

Globe lamps

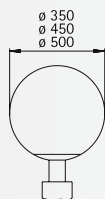

Globe lamps

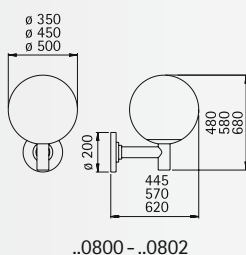

Wall lamps

Protection class IP 44
for incandescent lamps A 60
respectively A 65
cast aluminium
white plastic globe

Art.-no.	Lamp	Base	Globe	Colour	
660800	1 x A 60 100 W	E27	ø 350	black	
680800	1 x A 60 100 W	E27	ø 350	white	
660801	1 x A 65 150 W	E27	ø 450	black	
680801	1 x A 65 150 W	E27	ø 450	white	
660802	1 x A 65 150 W	E27	ø 500	black	
680802	1 x A 65 150 W	E27	ø 500	white	

Pole top lamps

Protection class IP 44
for poles ø = 110 mm
pole top ø = 60 mm
for incandescent lamps A 60
respectively A 65
cast aluminium
white plastic globe

- Globe lamps with a diameter ≥ 350 mm are available on request for following lamps:
TC-TEL 26 to 42 W
TC-D/TC-T 10 to 26 W
HME 50 to 125 W
HI and HS 70 W

- Available with clear plastic globe.

Art.-no.	Lamp	Base	Globe	Colour	
1-unit					
660850	1 x A 60 100 W	E27	ø 350	black	
680850	1 x A 60 100 W	E27	ø 350	white	
660854	1 x A 65 150 W	E27	ø 450	black	
680854	1 x A 65 150 W	E27	ø 450	white	
660858	1 x A 65 150 W	E27	ø 500	black	
680858	1 x A 65 150 W	E27	ø 500	white	
2-units					
660851	2 x A 60 100 W	E27	ø 350	black	
680851	2 x A 60 100 W	E27	ø 350	white	
660855	2 x A 65 150 W	E27	ø 450	black	
680855	2 x A 65 150 W	E27	ø 450	white	
660859	2 x A 65 150 W	E27	ø 500	black	
680859	2 x A 65 150 W	E27	ø 500	white	
3-units					
660852	3 x A 60 100 W	E27	ø 350	black	
680852	3 x A 60 100 W	E27	ø 350	white	
660856	3 x A 65 150 W	E27	ø 450	black	
680856	3 x A 65 150 W	E27	ø 450	white	
660860	3 x A 65 150 W	E27	ø 500	black	
680860	3 x A 65 150 W	E27	ø 500	white	
4-units					
660853	4 x A 60 100 W	E27	ø 350	black	
680853	4 x A 60 100 W	E27	ø 350	white	
660857	4 x A 65 150 W	E27	ø 450	black	
680857	4 x A 65 150 W	E27	ø 450	white	
660861	4 x A 65 150 W	E27	ø 500	black	
680861	4 x A 65 150 W	E27	ø 500	white	



Path and Pole lamps

Protection class IP 44
pole lamps with pole
for incandescent lamps A 60
cast aluminium
clear crystal glass

■ Available with opal coated glass.

For installation on a foundation or on the sunk pedestal 690010.

Art.-no.	Lamp	Base	Globe	Colour
Path lamps				
662053	1 x A 60 75 W	E27	ø 250	black
682053	1 x A 60 75 W	E27	ø 250	white
Pole lamps				
662054	1 x A 60 75 W	E27	ø 300	black
682054	1 x A 60 75 W	E27	ø 300	white

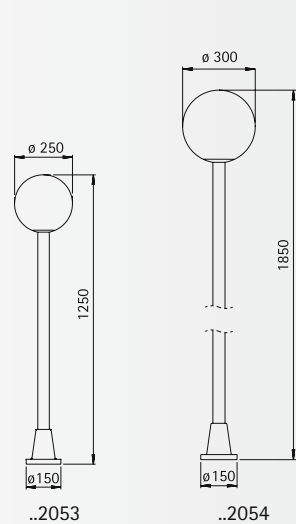

Poles made of aluminium for pole top lamps

Length 2000 – 3000 mm
pole top ø = 60 mm
For installation on a foundation or on the sunk pedestal 690011.
Sunk pedestal and junction box for all poles.

Art.-no.	H	D1	D2	Colour
690012	2000	60	110	black
690013	2500	60	110	black
690014	3000	60	110	black
Sunk pedestal		depth	drill holes	
690011		500	ø 136/140/170/175/190	
Junction box				
690036				

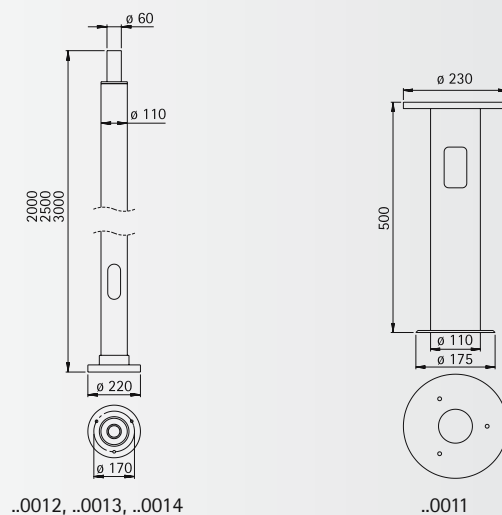

Globe lamps

Globe lamps

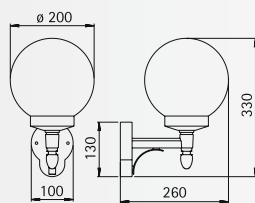

..0698

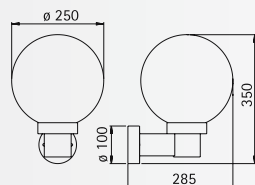

..0633

Wall lamps

Protection class IP 44
for incandescent lamps A 60
cast aluminium
with mounting plate
clear blown glass

- Available with opal coated glass.

Art.-no.	Lamp	Base	Globe	Colour	
660698	1 x A 60 75 W	E27	ø 200	black	
680698	1 x A 60 75 W	E27	ø 200	white	
660633	1 x A 60 75 W	E27	ø 250	black	
680633	1 x A 60 75 W	E27	ø 250	white	

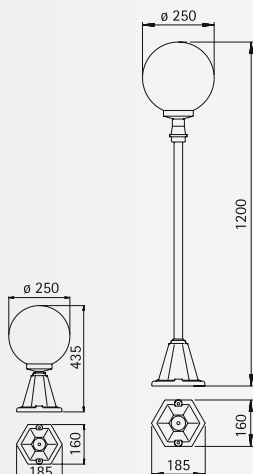

..0501

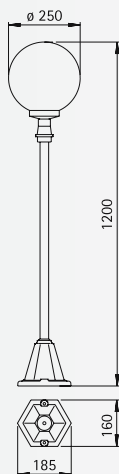

..2003

Pedestal and Path lamps

Protection class IP 44
for incandescent lamps A 60
cast aluminium
clear blown glass

For installation on a foundation or
on the sunk pedestal 690011.

- Available with opal coated glass.

Art.-no.	Lamp	Base	Globe	Colour	
Pedestal lamps					
660501	1 x A 60 75 W	E27	ø 250	black	
680501	1 x A 60 75 W	E27	ø 250	white	
Path lamps					
662003	1 x A 60 75 W	E27	ø 250	black	
682003	1 x A 60 75 W	E27	ø 250	white	

Pedestal and Bollard lamps

with/without integra-
ted movement detector

Protection class IP 44
for incandescent lamps A 60
cast aluminium, clear blown glass
For installation on a foundation or
on the sunk pedestal 690010.

- Available with opal coated glass.

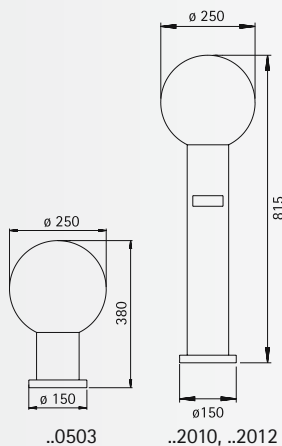

..0503



..2010, ..2012

Art.-no.	Lamp	Base	Globe	Colour	
Pedestal lamps					
660503	1 x A 60 75 W	E27	ø 250	black	
680503	1 x A 60 75 W	E27	ø 250	white	
Bollard lamps					
662012	1 x A 60 75 W	E27	ø 250	black	
682012	1 x A 60 75 W	E27	ø 250	white	
Bollard lamps with movement detector					
662010	1 x A 60 75 W	E27	ø 250	black	
682010	1 x A 60 75 W	E27	ø 250	white	



Globe lamps

Wall lamps

with/without integrated movement detector

Protection class IP 44
with mounting plate
cast aluminium
with mounting plate
clear crystal glass

- Available with opal coated glass.

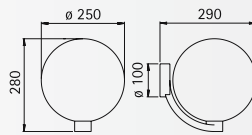

..0614

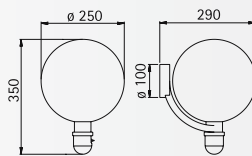

..0613



Art.-no.	Lamp	Base	Globe	Colour
Wall lamps				
660614	1 x A 60 75 W	E27	ø 250	black
680614	1 x A 60 75 W	E27	ø 250	white
Wall lamps with movement detector				
660613	1 x A 60 75 W	E27	ø 250	black
680613	1 x A 60 75 W	E27	ø 250	white

Wall and Pedestal lamps

Protection class IP 44
for incandescent lamps A 60
cast aluminium
with mounting plate
clear crystal glass

- Available with opal coated glass.

For installation on a wall, on a foundation or on the sunk pedestal 690010.

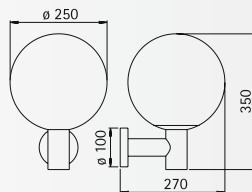

..0639

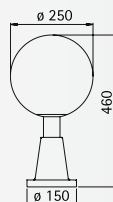

..0538



Art.-no.	Lamp	Base	Globe	Colour
Wall lamps				
660639	1 x A 60 75 W	E27	ø 250	black
680639	1 x A 60 75 W	E27	ø 250	white
Pedestal lamps				
660538	1 x A 60 75 W	E27	ø 250	black
680538	1 x A 60 75 W	E27	ø 250	white

Globe lamps

Globe lamps

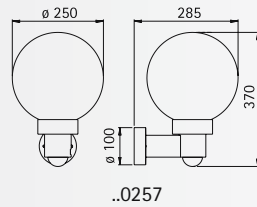

Wall lamps

with integrated movement detector

Protection class IP 44
for incandescent lamps A 60
cast aluminium
with mounting plate
white plastic globe

Art.-no.	Lamp	Base	Globe	Colour
660257	1 x A 60 75 W	E27	ø 250	black
680257	1 x A 60 75 W	E27	ø 250	white

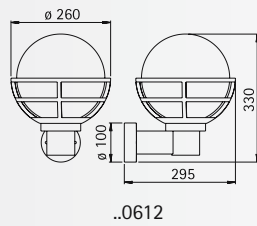

Wall lamps Pedestal lamps Bollard lamps

Protection class IP 44
for incandescent lamps A 60
cast aluminium
with mounting plate
opal coated glass

For installation on a wall,
on a foundation or
on the sunk pedestal 690010.

■ Available for further lamps.

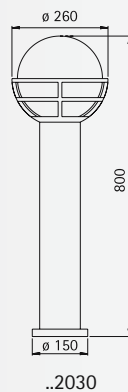
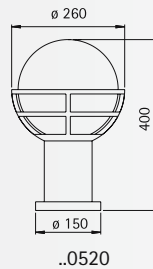

Art.-no.	Lamp	Base	Globe	Colour
Wall lamps				
660612	1 x A 60 75 W	E27	ø 230	black
680612	1 x A 60 75 W	E27	ø 230	white
Pedestal lamps				
660520	1 x A 60 75 W	E27	ø 230	black
680520	1 x A 60 75 W	E27	ø 230	white
Bollard lamps				
662030	1 x A 60 75 W	E27	ø 230	black
682030	1 x A 60 75 W	E27	ø 230	white

Wall lamps

Protection class IP 44
for incandescent lamps A 60
stainless steel
with mounting plate
opal coated glass respectively
clear blown glass

Art.-no.	Lamp	Base	Globe	Material
opal coated glass				
690227	1 x A 60 75 W	E27	ø 200	stainless steel
clear blown glass				
690226	1 x A 60 75 W	E27	ø 200	stainless steel

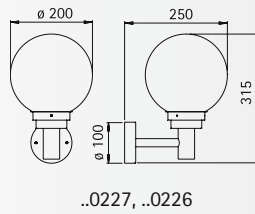

Globe lamps

Wall and Bollard lamp

Protection class IP 44
for incandescent lamps A 60
stainless steel
opal coated glass respectively
clear blown glass

with/without integra-
ted movement detector

For installation on a wall,
on a foundation or
on the sunk pedestal 690010.

Art.-no.	Lamp	Base	Globe	Material
Wall lamp with movement detector, opal coated glass				
690224	1 x A 60 75 W	E27	ø 200	stainless steel
Bollard lamp, clear blown glass				
692261	1 x A 60 75 W	E27	ø 200	stainless steel

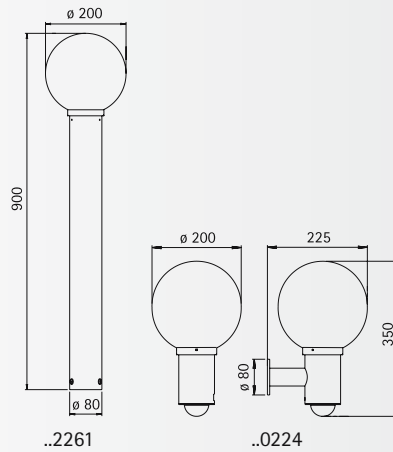

Globe lamps

Globe lamps



Wall lamps
Path lamps
Pole lamps

Protection class IP 44
pole lamps with pole
for incandescent lamps A 60
cast aluminium
with mounting plate
opal coated glass

For installation on a wall, on
a foundation or on the
sunk pedestal 690011 respectively
690010 (only ..2014).

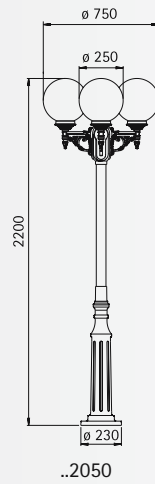

Art.-no.	Lamp	Base	Globe	Colour	
Wall lamps					
600609	1 x A 60 75 W	E27	ø 250	black-silver	→
670609	1 x A 60 75 W	E27	ø 250	white-gold	→
Path lamps					
602014	1 x A 60 75 W	E27	ø 250	black-silver	→
672014	1 x A 60 75 W	E27	ø 250	white-gold	→
Pole lamps 3-units					
602050	3 x A 60 75 W	E27	ø 250	black-silver	→
672050	3 x A 60 75 W	E27	ø 250	white-gold	→
Pole lamps 4-units					
602051	4 x A 60 75 W	E27	ø 250	black-silver	→
672051	4 x A 60 75 W	E27	ø 250	white-gold	→