

Stainless steel lamps

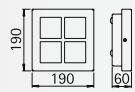

Stainless steel lamps

Stainless steel lamps



..6153

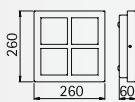

..6136

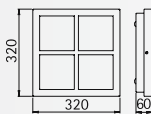

..6137

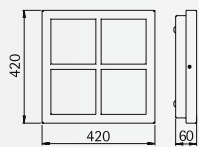

..6215



Wall and Ceiling lamps

Protection class IP 54
for fluorescent lamps TC-S/TC-L/TC-F
stainless steel
with mounting plate
opal coated plane glass

Art.-no.	Lamp	Base	Material
696153	1 x TC-F 18 W	2G10	stainless steel
696136	2 x TC-S 9 W	G23	stainless steel
696137	3 x TC-S 11 W	G23	stainless steel
696215	2 x TC-L 24 W	2G11	stainless steel

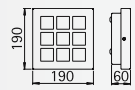

..6154

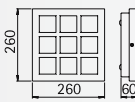

..6134

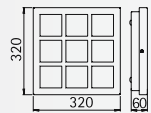

..6135

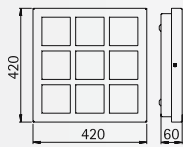

..6216



Wall and Ceiling lamps

Protection class IP 54
for fluorescent lamps TC-S/TC-L/TC-F
stainless steel
with mounting plate
opal coated plane glass

Art.-no.	Lamp	Base	Material
696154	1 x TC-F 18 W	2G10	stainless steel
696134	2 x TC-S 9 W	G23	stainless steel
696135	3 x TC-S 11 W	G23	stainless steel
696216	2 x TC-L 24 W	2G11	stainless steel

Wall and Ceiling lamps

Protection class IP 54
for fluorescent lamps TC-S/TC-L/TC-F
stainless steel
with mounting plate
opal coated plane glass

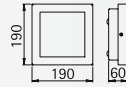

..6152

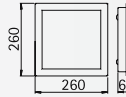

..6132

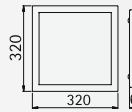

..6133

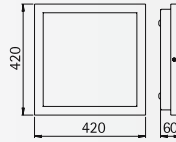

..6214



Art.-no.	Lamp	Base	Material
696152	1 x TC-F 18 W	2G10	stainless steel
696132	2 x TC-S 9 W	G23	stainless steel
696133	3 x TC-S 11 W	G23	stainless steel
696214	2 x TC-L 24 W	2G11	stainless steel

Stainless steel lamps

Wall and Ceiling lamps

Protection class IP 54
for fluorescent lamps TC-S
stainless steel
with mounting plate
opal coated plane glass

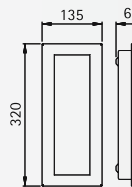

..6151

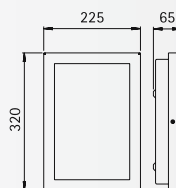

..6150



Art.-no.	Lamp	Base	Material
696151	1 x TC-S 11 W	G23	stainless steel
696150	2 x TC-S 11 W	G23	stainless steel

Stainless steel lamps

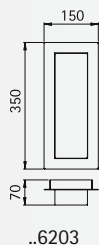

Wall and Ceiling lamp

Protection class IP 44
for fluorescent lamps TC-S
stainless steel
with mounting plate
opal coated glass

Art.-no.	Lamp	Base	Material
696203	1 x TC-S 11 W	G23	stainless steel

Stainless steel lamps

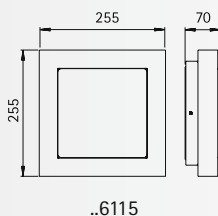

Wall and Ceiling lamp

Protection class IP 44
for tungsten halogen lamps QT-DE 12
stainless steel
with mounting plate made of
cast aluminium
opal coated glass

Art.-no.	Lamp	Base	Material
696115	1 x QT-DE 12 60 W	R7s	stainless steel

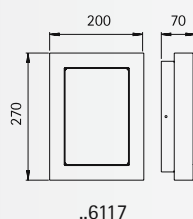

Wall and Ceiling lamp

Protection class IP 44
for tungsten halogen lamps QT-DE 12
stainless steel
with mounting plate made of
cast aluminium
opal coated glass

Art.-no.	Lamp	Base	Material
696117	1 x QT-DE 12 60 W	R7s	stainless steel



Special design with colour filter

Wall lamps

with double-sided
light output

Protection class IP 44
for tungsten halogen lamps QT 14
respectively fluorescent lamps TC-D
stainless steel
with mounting plate made of
cast aluminium
opal coated glass

- On request available with
one-sided light output

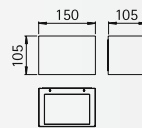

..6164



Stainless steel
lamps

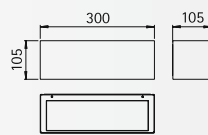

..6165

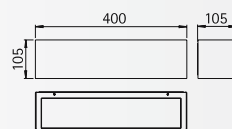

..6166



Art.-no.	Lamp	Base	Material
for tungsten halogen lamps			
696164	1 x QT 14 60 W	G9	stainless steel
for fluorescent lamps			
696165	1 x TC-D 26 W	G24d-3	stainless steel
696166	2 x TC-D 18 W	G24d-2	stainless steel



Stainless steel lamps

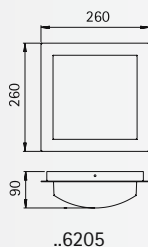

Wall and Ceiling lamp

Protection class IP 44
for incandescent lamps A 60
stainless steel
with mounting plate made of
cast aluminium
opal coated glass

Art.-no.	Lamp	Base	Material
696205	1 x A 60 75 W	E27	stainless steel

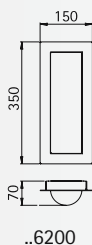

Wall and Ceiling lamp

Protection class IP 44
for fluorescent lamps TC-S
stainless steel
with mounting plate
opal coated glass

Art.-no.	Lamp	Base	Material
696200	1 x TC-S 11 W	G23	stainless steel

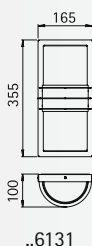

Wall and Ceiling lamp

Protection class IP 44
for incandescent lamps A 60
stainless steel
with mounting plate made of
cast aluminium
opal coated glass

Art.-no.	Lamp	Base	Material
696131	2 x A 60 75 W	E27	stainless steel



Wall lamp

with double-sided
light output

Protection class IP 44
for tungsten halogen lamps QT 14
stainless steel
with mounting plate made of
cast aluminium
opal coated plane glass

- On request available with
one-sided light output

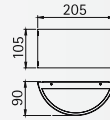

..6146

Art.-no.	Lamp	Base	Material
for tungsten halogen lamps			
696146	1 x QT 14 60 W	G9	stainless steel

Wall lamp

with double-sided
light output

Protection class IP 44
for tungsten halogen lamps QT-DE 12
stainless steel
with mounting plate made of
cast aluminium
opal coated plane glass

- On request available with
one-sided light output



Stainless steel
lamps

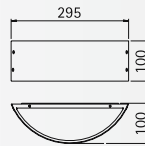

..6142

Art.-no.	Lamp	Base	Material
for tungsten halogen lamps			
696142	1 x QT-DE 12 60 W	R7s	stainless steel

Wall lamp

with double-sided
light output

Protection class IP 44
for fluorescent lamps TC-D
stainless steel
with mounting plate made of
cast aluminium
opal coated plane glass

- On request available with
one-sided light output

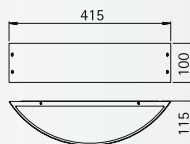

..6143

Art.-no.	Lamp	Base	Material
for fluorescent lamps			
696143	1 x TC-D 26 W	G24d-3	stainless steel

Stainless steel lamps

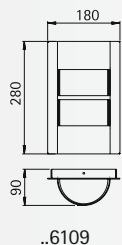

Wall lamp

Protection class IP 44
for incandescent lamps A 60
stainless steel
with mounting plate made of
cast aluminium
opal coated glass

Art.-no.	Lamp	Base	Material
Wall lamp			
696109	1 x A 60 75 W	E27	stainless steel



Stainless steel lamps

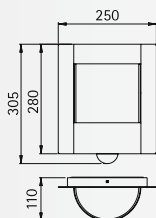

.6188

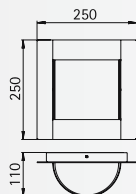

.6187

Wall lamps

with/without integrated movement detector

Protection class IP 44
for incandescent lamps A 60
stainless steel
with mounting plate made of
cast aluminium
opal coated glass

Art.-no.	Lamp	Base	Material
Wall lamp with movement detector			
696188	1 x A 60 75 W	E27	stainless steel

Art.-no.	Lamp	Base	Material
Wall lamp			
696187	1 x A 60 75 W	E27	stainless steel



Wall and Ceiling lamp

Protection class IP 44
for incandescent lamps A 60
stainless steel
with mounting plate made of
cast aluminium
opal coated glass

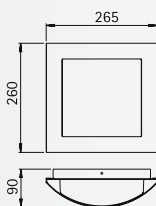

.6193

Art.-no.	Lamp	Base	Material
Wall and Ceiling lamp			
696193	1 x A 60 75 W	E27	stainless steel





Wall lamps

Protection class IP 44
for incandescent lamps A 60
stainless steel
with mounting plate made of
cast aluminium
opal coated glass

- These lamps are available on request with a movement detector.

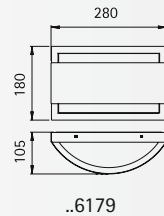

..6179

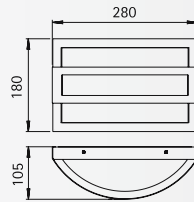

..6180



Stainless steel lamps

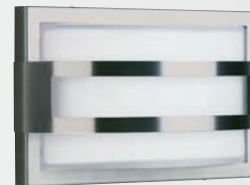

Art.-no.	Lamp	Base	Material
696179	1 x A 60 75 W	E27	stainless steel
696180	1 x A 60 75 W	E27	stainless steel



Wall and Ceiling lamp

Protection class IP 44
for incandescent lamps A 60
stainless steel
with mounting plate made of
cast aluminium
opal coated glass

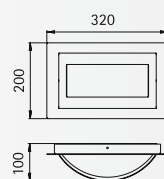

..6092



Art.-no.	Lamp	Base	Material
696092	1 x A 60 75 W	E27	stainless steel



Stainless steel lamps

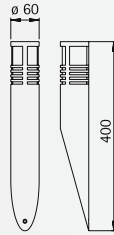

.0204

Wall lamps
Pedestal lamp
Bollard lamp

Protection class IP 44
for tungsten halogen lamps QT 14
stainless steel
with mounting plate made of
cast aluminium
borosilicate glass

For installation on a wall,
on a foundation or
on the sunk pedestal 690010.

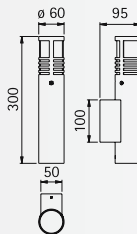

.0205

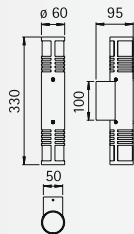

.0206

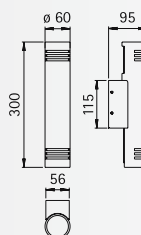

.0208



Foto: DPI Paneelen, Wesel

Stainless steel
lamps

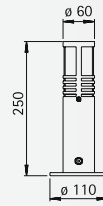

..0557



Stainless steel lamps

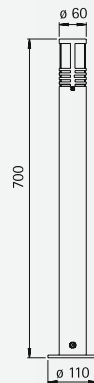

..2244



Art.-no.	Lamp	Base	Material
Wall lamps			
690204	1 x QT 14 40 W	G9	stainless steel
690205	1 x QT 14 40 W	G9	stainless steel
690206	2 x QT 14 40 W	G9	stainless steel
690208	2 x QT 14 40 W	G9	stainless steel
Pedestal lamp			
690557	1 x QT 14 40 W	G9	stainless steel
Bollard lamp			
692244	1 x QT 14 40 W	G9	stainless steel

Stainless steel lamps



Stainless steel lamps

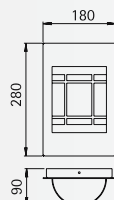

.6097

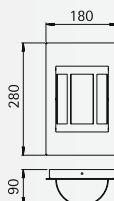

.6098

Wall lamps

Protection class IP 44
for incandescent lamps A 60
stainless steel
with mounting plate made of
cast aluminium
opal coated glass

Art.-no.	Lamp	Base	Material
696097	1 x A 60 75 W	E27	stainless steel
696098	1 x A 60 75 W	E27	stainless steel

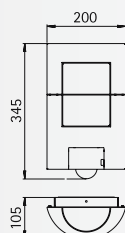

.6140

Wall lamp

with integrated move-
ment detector

Protection class IP 44
for incandescent lamps A 60
stainless steel
with mounting plate made of
cast aluminium
opal coated glass

Art.-no.	Lamp	Base	Material
696140	1 x A 60 75 W	E27	stainless steel

Wall lamps
Pedestal
Bollard lamp

Protection class IP 44
for energy saving lamps TC-DSE
stainless steel
with mounting plate made of
cast aluminium
opal coated glass

For installation on a wall,
on a foundation or
on the sunk pedestal 690010.

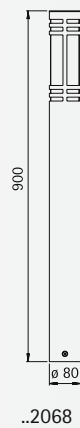
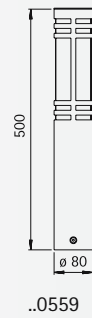
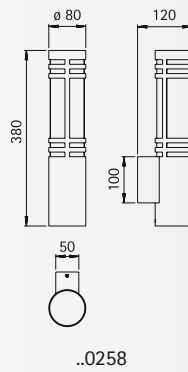
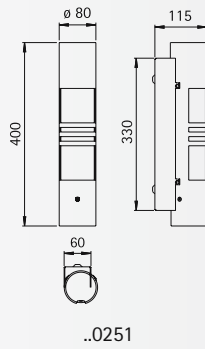

Stainless steel
lamps

Art.-no.	Lamp	Base	Material	
Wall lamps				
690251	1 x TC-DSE max. 20 W	E27	stainless steel	
690258	1 x TC-DSE max. 20 W	E27	stainless steel	
Pedestal lamp				
690559	1 x TC-DSE max. 20 W	E27	stainless steel	
Bollard lamp				
692068	1 x TC-DSE max. 20 W	E27	stainless steel	

Stainless steel lamps

Wall lamps

Protection class IP 44
 for fluorescent lamps TC-S resp.
 tungsten halogen lamps QT 14
 stainless steel
 with mounting plate made of
 cast aluminium
 690635 acrylic hollow glass
 690252 borosilicate glass

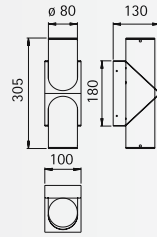

..0635

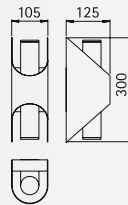

..0252

Art.-no.	Lamp	Base	Material
for fluorescent lamps			
690635	1 x TC-S 11 W	G23	stainless steel
for tungsten halogen lamps			
690252	2 x QT 14 40 W	G9	stainless steel



Stainless steel lamps





Wall lamp
Pedestal lamp
Bollard lamp

Protection class IP 44
for energy saving lamps TC-DSE
stainless steel
acrylic glass satiné

Art.-no.	Lamp	Base	Material	
Wall lamp				
690214	1 x TC-DSE max. 20 W	E27	stainless steel	
Pedestal lamp				
690506	1 x TC-DSE max. 20 W	E27	stainless steel	
Bollard lamp				
692044	1 x TC-DSE max. 20 W	E27	stainless steel	

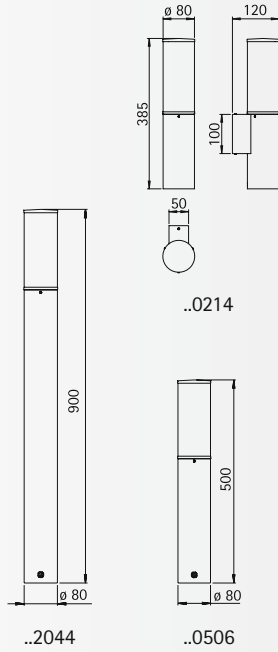



Stainless steel lamps

Wall and
Bollard lamp

Protection class IP 44
for energy saving lamps TC-DSE
stainless steel
with mounting plate
acrylic and opal coated glass

For installation on a wall,
on a foundation or
on the sunk pedestal 690010.



Art.-no.	Lamp	Base	Material	
Wall lamp				
690309	1 x TC-DSE max. 20 W	E27	stainless steel	
Bollard lamp				
692272	1 x TC-DSE max. 20 W	E27	stainless steel	

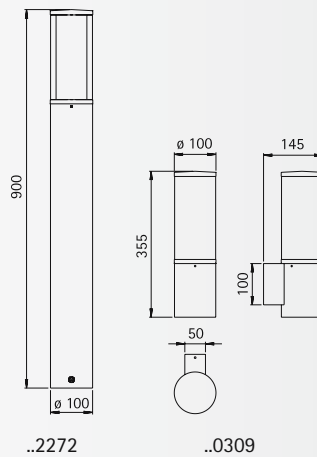

Stainless steel lamps

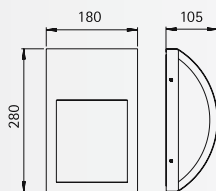

..6178

Wall lamp

Protection class IP 44
for incandescent lamps A 60
stainless steel
with mounting plate made of
cast aluminium
opal coated glass

Art.-no.	Lamp	Base	Material
696178	1 x A 60 75 W	E27	stainless steel

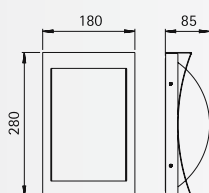

..6217

Wall lamp

Protection class IP 44
for incandescent lamps A 60
stainless steel
with mounting plate made of
cast aluminium
opal coated glass

Art.-no.	Lamp	Base	Material
696217	1 x A 60 75 W	E27	stainless steel





**Wall and
Bollard lamps**

Protection class IP 44
for incandescent lamps A 60
stainless steel
with mounting plate
opal coated glass

For installation on a wall,
on a foundation or
on the sunk pedestal 690010.

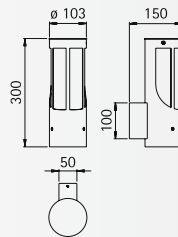



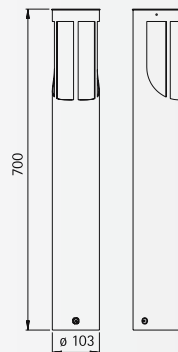

..0256



..2265



Stainless steel
lamps

Art.-no.	Lamp	Base	Material
Wall lamp			
690256	1 x A 60 75 W	E27	stainless steel  → 
Bollard lamp			
692265	1 x A 60 75 W	E27	stainless steel  → 

Bollard lamp



Protection class IP 44
for incandescent lamps A 60
stainless steel
with mounting plate
opal coated glass

For installation on a foundation or
on the sunk pedestal 690010.



..2264



Art.-no.	Lamp	Base	Material
Bollard lamp			
692264	1 x A 60 75 W	E27	stainless steel  → 

Stainless steel lamps

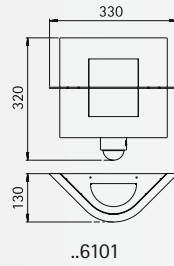

.6101

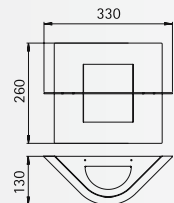

.6060

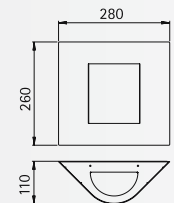

.6059

Stainless steel lamps

Wall lamps

Protection class IP 44
for incandescent lamps A 60
stainless steel
with mounting plate made of
cast aluminium
opal coated glass

with/without integra-
ted movement detector



Art.-no.	Lamp	Base	Material
Wall lamp with movement detector			
696101	1 x A 60 75 W	E27	stainless steel
Wall lamps			
696060	1 x A 60 75 W	E27	stainless steel
696059	1 x A 60 75 W	E27	stainless steel

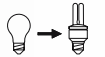

Wall and Bollard lamp

Protection class IP 44
for incandescent lamps A 60
stainless steel
with mounting plate
opal coated glass

For installation on a wall,
on a foundation or
on the sunk pedestal 690010.

Art.-no.	Lamp	Base	Material
Wall lamp			
690254	1 x A 60 75 W	E27	stainless steel
Bollard lamp			
692263	1 x A 60 75 W	E27	stainless steel

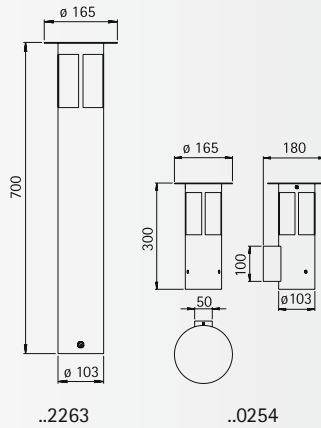

Wall and Bollard lamp

Protection class IP 44
for incandescent lamps A 60
stainless steel
with mounting plate
opal coated glass

For installation on a wall,
on a foundation or
on the sunk pedestal 690010.

Art.-no.	Lamp	Base	Material
Wall lamp			
690601	1 x A 60 75 W	E27	stainless steel
Bollard lamp			
692226	1 x A 60 75 W	E27	stainless steel

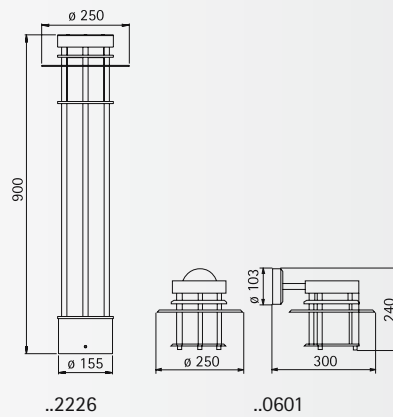

Stainless steel lamps

Wall and Bollard lamp

Protection class IP 44
for incandescent lamps A 60
stainless steel
opal coated glass

For installation on a wall,
on a foundation or
on the sunk pedestal 690010.

Art.-no.	Lamp	Base	Material
Wall lamp			
690658	1 x A 60 75 W	E27	stainless steel
Bollard lamp			
692036	1 x A 60 75 W	E27	stainless steel

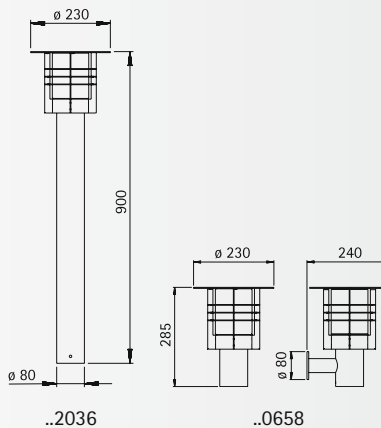

Stainless steel lamps

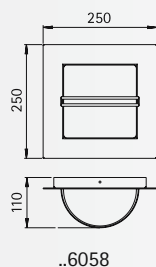

Wall lamp

Protection class IP 44
for incandescent lamps A 60
stainless steel
with mounting plate made of
cast aluminium
opal coated glass

Art.-no.	Lamp	Base	Material
696058	1 x A 60 75 W	E27	stainless steel



Stainless steel lamps

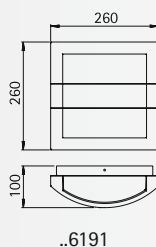

Wall and Ceiling lamp

Protection class IP 44
for incandescent lamps A 60
stainless steel
with mounting plate made of
cast aluminium
opal coated glass

Art.-no.	Lamp	Base	Material
696191	1 x A 60 75 W	E27	stainless steel

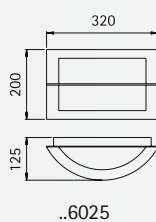

Wall and Ceiling lamp

Protection class IP 44
for incandescent lamps A 60
stainless steel
with mounting plate made of
cast aluminium
opal coated glass

Art.-no.	Lamp	Base	Material
696025	1 x A 60 75 W	E27	stainless steel



Wall lamp
Pedestal lamp
Bollard lamp

Protection class IP 44
for fluorescent lamps TC-D
stainless steel
with mounting plate (except ..0687)
acrylic hollow glass

For installation on a wall,
on a foundation or
on the sunk pedestal 690010.

Art.-no.	Lamp	Base	Material
Wall lamp			
690687	1 x TC-D 18 W	G24d-2	stainless steel
Pedestal lamp			
690551	1 x TC-D 18 W	G24d-2	stainless steel
Bollard lamp			
692219	1 x TC-D 18 W	G24d-2	stainless steel

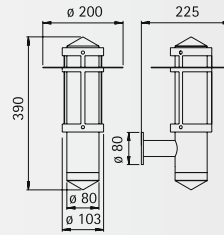

..0687

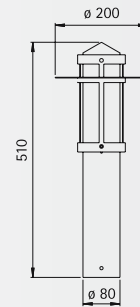

..0551



Stainless steel lamps

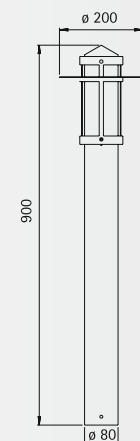

..2219



Foto: DPI Paneelen, Wesel

Stainless steel lamps

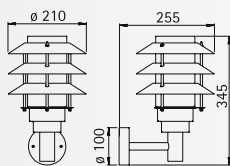

..0216

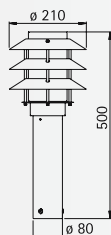

..0500

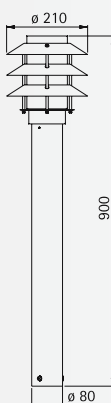







..2256

Wall lamp
Pedestal lamp
Bollard lamp

Protection class IP 44
for incandescent lamps A 60
stainless steel
with mounting plate
opal coated glass

For installation on a wall,
on a foundation or
on the sunk pedestal 690010.

Stainless steel
lamps

Art.-no.	Lamp	Base	Material	
Wall lamp				
690216	1 x A 60 75 W	E27	stainless steel	 → 
Pedestal lamp				
690500	1 x A 60 75 W	E27	stainless steel	 → 
Bollard lamp				
692256	1 x A 60 75 W	E27	stainless steel	 → 





Stainless steel lamps

Wall and Bollard lamp

Protection class IP 44
for incandescent lamps A 60
stainless steel
with mounting plate
opal coated glass

For installation on a wall,
on a foundation or
on the sunk pedestal 690010.

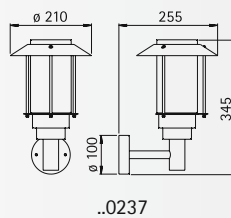

..0237

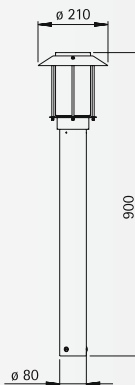

..2257

Art.-no.	Lamp	Base	Material
690237	1 x A 60 75 W	E27	stainless steel
692257	1 x A 60 75 W	E27	stainless steel

Stainless steel lamps

Wall lamps

Protection class IP 44
for incandescent lamps A 60
stainless steel
with mounting plate made of
cast aluminium
opal coated glass

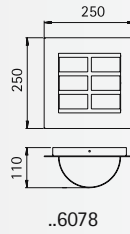
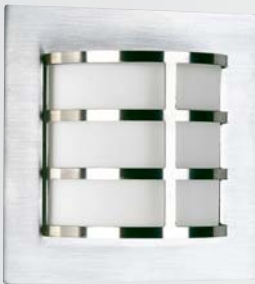
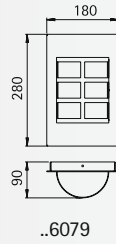

Art.-no.	Lamp	Base	Material
696079	1 x A 60 75 W	E27	stainless steel
696078	1 x A 60 75 W	E27	stainless steel



Stainless steel lamps



Wall lamps
Pedestal lamp
Bollard lamp

Protection class IP 44
for fluorescent lamps TC-D
respectively TC-S
stainless steel
with mounting plate (except ..0627)
acrylic hollow glass

For installation on a wall,
on a foundation or
on the sunk pedestal 690010.

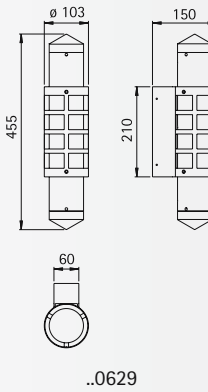
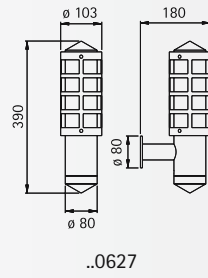

..0629

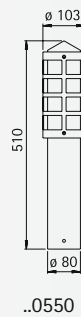

..0550

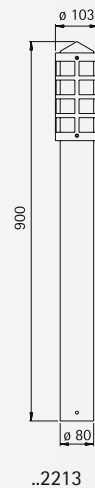

..2213



Stainless steel
lamps



Foto: DPI Paneelen, Wessel

Art.-no.	Lamp	Base	Material
Wall lamps			
690627	1 x TC-D 18 W	G24d-2	stainless steel
690629	2 x TC-S 9 W	G23	stainless steel
Pedestal lamp			
690550	1 x TC-D 18 W	G24d-2	stainless steel
Bollard lamp			
692213	1 x TC-D 18 W	G24d-2	stainless steel



Stainless steel lamps

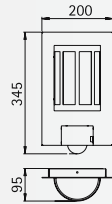

..6141

Wall lamp

with integrated movement detector

Protection class IP 44
for incandescent lamps A 60
stainless steel
with mounting plate made of cast aluminium
opal coated glass

Art.-no.	Lamp	Base	Material
Wall lamp with movement detector			
696141	1 x A 60 75 W	E27	stainless steel

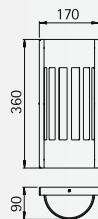

..6010

Wall lamp

Protection class IP 44
for incandescent lamps A 60
stainless steel
with mounting plate made of cast aluminium
opal coated glass

Art.-no.	Lamp	Base	Material
Wall lamp			
696010	1 x A 60 75 W	E27	stainless steel



Wall lamps
Pedestal lamp
Bollard lamps

with/without downlight
with/without integrated movement detector

Protection class IP 44
for incandescent lamps A 60
respectively for additional pressed
glass reflector lamp PAR 20
stainless steel
with mounting plate made of
cast aluminium (only ..6119)
opal coated glass

For installation on a wall,
on a foundation or
on the sunk pedestal 690010.

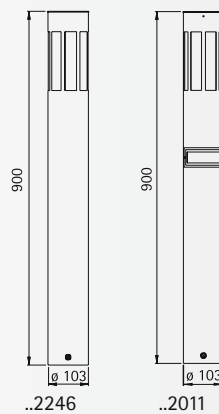
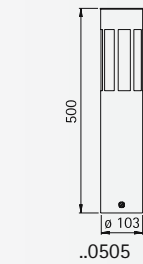
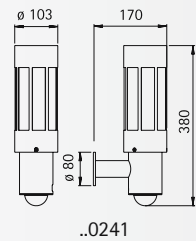
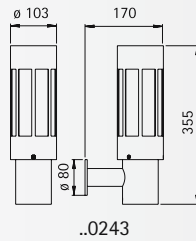
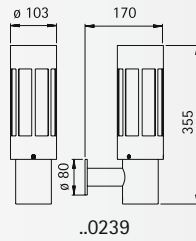
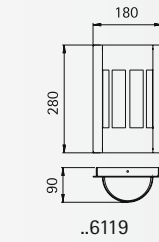

Stainless steel
lamps

Art.-no.	Lamp	Base	Material
Wall lamps			
696119	1 x A 60 75 W	E27	stainless steel
690239	1 x A 60 75 W	E27	stainless steel
Wall lamp with downlight PAR 20 50 W			
690243	1 x A 60 75 W	E27	stainless steel
Wall lamp with movement detector			
690241	1 x A 60 75 W	E27	stainless steel
Pedestal lamp			
690505	1 x A 60 75 W	E27	stainless steel
Bollard lamp (without picture)			
692246	1 x A 60 75 W	E27	stainless steel
Bollard lamp with movement detector			
692011	1 x A 60 75 W	E27	stainless steel

Stainless steel lamps

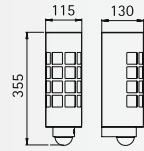

..0209

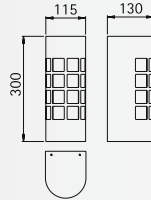

..0691

Wall lamps

with/without integrated movement detector

Protection class IP 44
for incandescent lamps A 60
stainless steel
with mounting plate made of
cast aluminium
opal coated glass

Art.-no.	Lamp	Base	Material
Wall lamp with movement detector			
690209	1 x A 60 75 W	E27	stainless steel
Wall lamp			
690691	1 x A 60 75 W	E27	stainless steel 

Stainless steel lamps

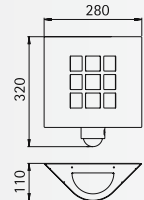

..6102

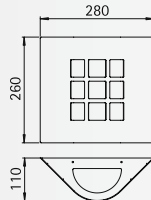

..6061

Wall lamps

with/without integrated movement detector

Protection class IP 44
for incandescent lamps A 60
stainless steel
with mounting plate made of
cast aluminium
opal coated glass

Art.-no.	Lamp	Base	Material
Wall lamp with movement detector			
696102	1 x A 60 75 W	E27	stainless steel
Wall lamp			
696061	1 x A 60 75 W	E27	stainless steel 



Foto: H. Klostermann, Coesfeld

Wall lamp

Protection class IP 44
for incandescent lamps A 60
stainless steel
with mounting plate made of
cast aluminium
opal coated glass

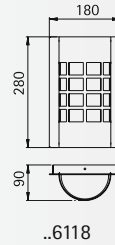

Art.-no.	Lamp	Base	Material
696118	1 x A 60 75 W	E27	stainless steel



Pedestal and Bollard lamp

Protection class IP 44
for incandescent lamps A 60
stainless steel
with mounting plate made of
cast aluminium
opal coated glass

For installation on a foundation or
on the sunk pedestal 690010.



Stainless steel
lamps

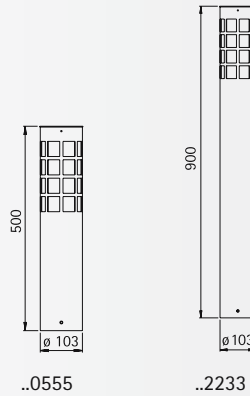

Art.-no.	Lamp	Base	Material
690555	1 x A 60 75 W	E27	stainless steel
692233	1 x A 60 75 W	E27	stainless steel



Pedestal and Bollard lamp

Protection class IP 44
for incandescent lamps A 60
stainless steel
with mounting plate made of
cast aluminium
opal coated glass

For installation on a foundation or
on the sunk pedestal 690010.

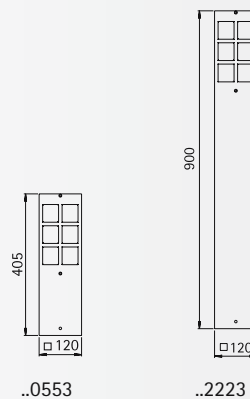

Art.-no.	Lamp	Base	Material
690553	1 x A 60 100 W	E27	stainless steel
692223	1 x A 60 100 W	E27	stainless steel



Stainless steel lamps

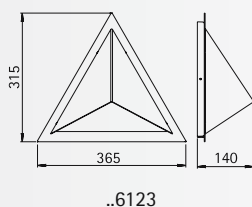

Wall lamp

Protection class IP 44
for incandescent lamps A 60
stainless steel
with mounting plate made of
cast aluminium
opal coated glass

Art.-no.	Lamp	Base	Material
696123	1 x A 60 75 W	E27	stainless steel

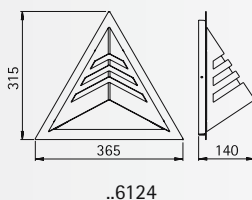

Wall lamp

Protection class IP 44
for incandescent lamps A 60
stainless steel
with mounting plate made of
cast aluminium
opal coated glass

Art.-no.	Lamp	Base	Material
696124	1 x A 60 75 W	E27	stainless steel

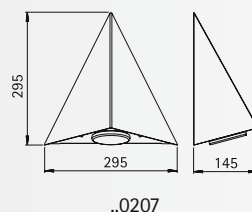

Wall lamp

Protection class IP 44
for pressed glass reflector lamps PAR 20
stainless steel
with mounting plate
blown glass clear

Art.-no.	Lamp	Base	Material
690207	1 x PAR 20 50 W	E27	stainless steel

Wall lamp

Protection class IP 44
for incandescent lamps A 60
stainless steel
with mounting plate made of
cast aluminium
opal coated glass

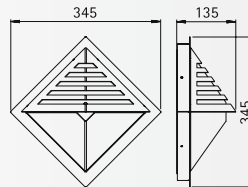

..0220

Art.-no.	Lamp	Base	Material
690220	1 x A 60 75 W	E27	stainless steel



Wall lamp

Protection class IP 44
for tungsten halogen lamps QT-DE 12
stainless steel
with mounting plate made of
cast aluminium
opal coated glass



Stainless steel
lamps

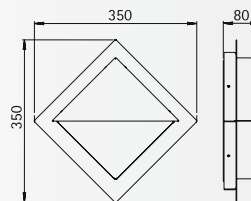

..6122

Art.-no.	Lamp	Base	Material
696122	1 x QT-DE 60 W	R7s	stainless steel

Wall and Bollard lamp

Protection class IP 44
for tungsten halogen lamps QT 14
stainless steel
with mounting plate made of
cast aluminium
opal coated plane glass

For installation on a wall or on a
foundation.

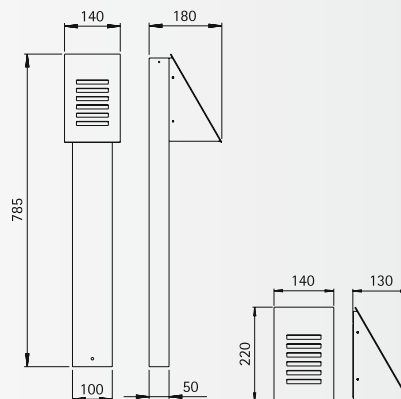

..2250

..0228



Art.-no.	Lamp	Base	Material
690228	1 x QT 14 75 W	G9	stainless steel
692250	1 x QT 14 75 W	G9	stainless steel

Stainless steel lamps

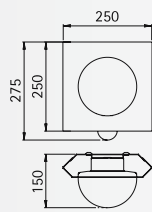

..6127

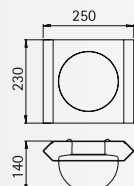

..6112

Wall lamps

with/without integrated movement detector

Protection class IP 44
for incandescent lamps A 60
stainless steel
opal coated glass

Art.-no.	Lamp	Base Material
Wall lamp with movement detector		
696127	1 x A 60 75 W	E27 stainless steel
Wall lamp		
696112	1 x A 60 75 W	E27 stainless steel 

Stainless steel lamps

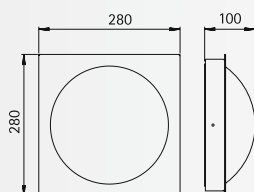

..6175

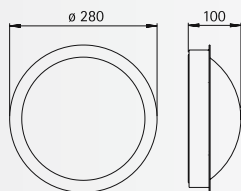

..6174

Wall and Ceiling lamps

Protection class IP 44
for incandescent lamps A 60
stainless steel
with mounting plate made of cast aluminium
opal coated glass

Art.-no.	Lamp	Base Material
696175	1 x A 60 75 W	E27 stainless steel
696174	1 x A 60 75 W	E27 stainless steel 

Wall and Ceiling lamp

Protection class IP 44
for tungsten halogen lamps QT-DE 12
stainless steel
with mounting plate made of cast aluminium
opal coated glass

■ With adhesive foil 660034 available.

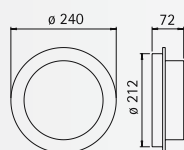

..6022

Art.-no.	Lamp	Base	Material
696022	1 x QT-DE 12 60 W	R7s	stainless steel

House number lamp

Protection class IP 44
for fluorescent lamps TC-S
stainless steel
custom-made house number
opal coated glass

- For the order please give us the house number.

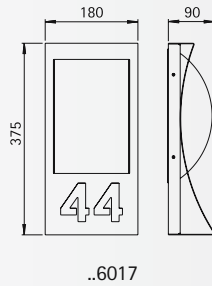

Art.-no.	Lamp	Base	Material
Wall lamp			
696017	1 x TC-S 5/7 W	G23	stainless steel

House number lamps

with/without integrated twilight switch

Protection class IP 44
for fluorescent lamps TC-S
stainless steel
custom-made house number
with mounting plate made of cast aluminium
opal coated glass

- For the order please give us the house number.

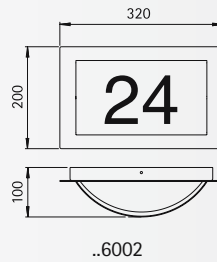

Stainless steel lamps

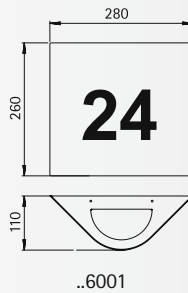

Art.-no.	Lamp	Base	Material
Wall lamps			
696002	1 x TC-S 5/7 W	G23	stainless steel
696001	1 x TC-S 5/7 W	G23	stainless steel
Wall lamp with twilight switch			
696003	1 x TC-S 5/7 W	G23	stainless steel

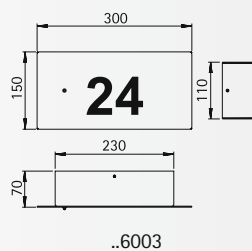

Stainless steel lamps

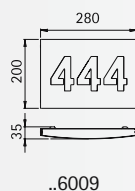
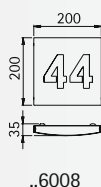
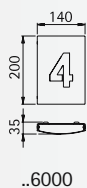

House number lamps

with LED

Protection class IP 44
with LED, lightcolour white
inclusive converter
connection directly 230 V, 50 Hz
stainless steel
custom-made house number
lettering height: 100 mm

- For the order please give us the house number.

Art.-no.	Lamp	Power	Material
696000	LED	1,0 W	stainless steel
696008	LED	1,2 W	stainless steel
696009	LED	1,5 W	stainless steel

LED

Stainless steel lamps

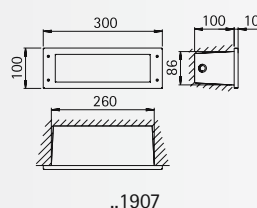
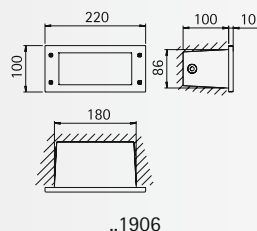

Wall recessed lamps

Protection class IP 54
for fluorescent lamps TC-D
cast aluminium and stainless steel
white macrolon
insert hole:
691906: 180 x 86 x 100 mm
691907: 260 x 86 x 100 mm

Art.-no.	Lamp	Base	Material
691906	1 x TC-D 10/13 W	G24d-1	stainless steel
691907	1 x TC-D 18 W	G24d-2	stainless steel

