

 **MODUL** 
ELECTRO
www.modulelectro.ru

Artemide[®]

MODULO
ELECTRO
www.modulelectro.ru

MODULO
ELECTRO
www.modulelectro.ru

Artemide[®]



MODUL
ELECTRO

www.modulelectro.ru

Sfogliare il catalogo Artemide è ripercorrere un sentiero importante nella storia del design contemporaneo. Grandi maestri, inimitabili intuizioni, paziente ricerca e tenace spirito innovativo, insigniti da innumerevoli premi e consacrati nei più prestigiosi Musei del mondo, fino alle più recenti creazioni, espressioni dello spirito del presente e proiettate nel futuro. In quasi cinquant'anni di esperienza aziendale ed imprenditoriale, si coglie una sorprendente continuità, tale da porre i prodotti Artemide al di fuori ed al di sopra dei filoni, delle tendenze, delle mode del momento. Il fil rouge che caratterizza l'esperienza Artemide è la volontà inesausta di trovare soluzioni alle esigenze di illuminazione dell'uomo, anche se non ancora espresse e consapevoli. La persona è costantemente posta al centro del progetto; le esigenze formali ed estetiche, le innovazioni tecnologiche, i talenti individuali e collettivi sono stati, sono e saranno sempre posti al servizio di un fine precipuo. The Human Light: in ogni luogo del mondo, la luce di Artemide per il benessere dell'uomo.

Leafing through the Artemide catalogue is like retracing an important pathway in the history of contemporary design. Great masters, unique intuitions, patient research and tenacious innovative spirit, rewarded by innumerable prizes and consecrated in the most prestigious Museums worldwide, up to and including the most recent creations, expressions of the spirit of today and projected into the future. In almost half a century of business and entrepreneurial experience, a surprising continuity can be felt, placing the Artemide products outside and above traditions, trends, and fashions of the moment. The fil rouge which characterises Artemide's experience is the unexhausted desire to find solutions to the human demand for lighting, even if still unexpressed and unconscious. The person is constantly placed at the centre of the project; formal and aesthetic needs, technological innovations, individual and collective talents have been, are, and always will be, at the service of a special purpose. The Human Light: everywhere in the world, the light of Artemide for the wellness of man.

Feuilleter le catalogue Artemide, revient à parcourir un chapitre essentiel de l'histoire du Design contemporain. La collaboration de créateurs exceptionnels aux inimitables intuitions, une recherche patiente et un esprit novateur tenace, participent aux créations d'Artemide. Ces dernières ont été couronnées par d'innombrables prix et consacrées par les Musées les plus prestigieux du monde entier. Quant aux créations les plus récentes elles expriment l'esprit d'aujourd'hui, projeté vers le futur. En près de cinquante ans d'expérience sur le marché du Design, on parvient à saisir un étonnant esprit de continuité, en mesure d'imposer les produits Artemide en-dehors et au-delà de tous les filons, de toutes les tendances, de toutes les modes du moment. Le fil rouge qui caractérise l'expérience d'Artemide est la volonté intarissable de trouver des solutions aux exigences d'éclairage de l'Homme, même lorsque ces dernières restent encore inexprimées et inconscientes. L'homme est constamment au centre des différents projets ; les besoins formels et esthétiques, les innovations technologiques, les talents individuels et collectifs ont été, sont et seront toujours mis au service d'un unique objectif primordial. The Human Light : partout à travers le monde, la lumière d'Artemide, pour le bien-être de l'Humanité.

Blättern in den Seiten des Artemide-Katalogs heißt, einen der wichtigen Unternehmensverläufe in der Geschichte des modernen Designs zurück zu verfolgen. Große Meister, außergewöhnliche Intuition, geduldige Entwicklungsarbeit und unermüdlicher Innovationsgeist, ausgezeichnet mit ungezählten Preisen und gefeiert in den wichtigsten Museen der Welt, bis hin zu den jüngsten Kreationen, die Ausdruck zeitgenössischen Geists und zugleich zukunftsweisend sind. Es ist die unerwartete Kontinuität, die nahezu fünfzig Jahre betrieblicher und unternehmerischer Erfahrung prägt, die macht, dass die Produkte von Artemide außerhalb und jenseits von Strömungen, Tendenzen, momentanen Modeerscheinungen stehen. Den roten Faden, der sich durch die Geschichte und die Tätigkeit Artemides zieht, bildet das unermüdliche Bestreben, möglichst schon in Vorwegnahme Lösungen für die Bedürfnisse der Menschen nach Licht zu entwickeln. Im Mittelpunkt des Projekts steht immer der Mensch; ein vorrangiges Ziel, dem die formalen und ästhetischen Anforderungen, die technologischen Innovationen, die Talente des Individuums und des Kollektivs gestern, heute und morgen immer nachgeordnet waren, sind und sein werden. The Human Light: an jedem Ort der Welt. Licht von Artemide, damit Menschen sich wohl fühlen.

Hoje el catálogo Artemide es recorrer un sendero importante en la historia del design contemporáneo. Grandes maestros, inimitables intuiciones, paciente búsqueda y tenaz espíritu innovador, condecorados con innumerables premios y consagrados en los más prestigiosos museos del mundo, hasta las más recientes creaciones, expresiones de espíritu del presente y proyectadas en el futuro. En casi cincuenta años de experiencia tanto como empresa como imprenta-editorial, se adivina una sorprendente continuidad, colocando los productos Artemide exteriormente y por encima de categorías standard, de las tendencias, de las modas del momento. El fil rouge que caracteriza la experiencia Artemide es la voluntad inexhausta de encontrar soluciones a las exigencias de iluminación del hombre, anticipando su expresión a los demás y a sí misma. La persona está constantemente como centro del proyecto; las exigencias formales y estéticas, las innovaciones tecnológicas, los talentos individuales y colectivos han sido, son y serán siempre puestos al servicio de un fin primario. The Human Light: en cualquier lugar del mundo, la luz de Artemide para el bienestar del hombre.

 **MODUL** 
ELECTRO

www.modulselectro.ru



Per Artemide l'obiettivo è ad un tempo semplice e straordinariamente complesso: rendere la luce un elemento capace di migliorare la qualità della vita. The Human Light, progetto promosso da Carlotta de Bevilacqua, significa concepire la luce per accompagnare l'uomo nella propria attività quotidiana, assecondandone gli stati d'animo e contribuendo al benessere individuale, con il massimo della precisione visiva ed il minimo consumo di risorse ambientali.

La vision The Human Light è stata declinata in alcuni importanti percorsi di ricerca: METAMORFOSI (progetto brevettato) è una tecnologia innovativa impegnata per creare sensazioni cromatiche che possono essere adattate ai diversi stati d'animo, alle caratteristiche dell'ambiente e alle atmosfere fisiche e mentali di ogni individuo. La luce è restituita del senso dei colori, con tutta la loro capacità simbolica e benefica.

A.L.S.O. è una collezione di oggetti multiperformativi che consentono la gestione integrata di parametri ambientali rilevanti, quali luce, suono e aria, mediante l'azione combinata di tecnologie per l'illuminazione, la diffusione sonora e la filtrazione elettrostatica.

L'ambiente intero è plasmabile in funzione delle esigenze personali.

Con MY WHITE LIGHT Artemide propone apparecchi in grado di generare sia luce bianca variabile dai toni caldi (2.500 K) ai toni molto freddi (20.000 K) e regolabile per intensità, come pure di generare luce colorata. Per la prima volta l'uomo può scegliere tra le infinite tonalità di luce bianca.

LUXERION è una nuova gamma di apparecchi multifunzionali che integrano luce e purificazione dell'aria. Sviluppata in collaborazione con Elica, leader nella produzione di cappe aspiranti, è una linea totalmente innovativa, che segna un livello di comfort senza precedenti negli ambienti residenziali e professionali.

Artemide's goal is simple and yet extraordinarily complex: to make light an element able to improve the quality of life. The Human Light, a project promoted by Carlotta de Bevilacqua, means conceiving light to accompany man in his daily activity, supporting moods and contributing to individual wellness, with maximum visual precision and minimum consumption of environmental resources.

The idea of The Human Light takes the form of a number of important research paths: METAMORFOSI (patented project) is an innovative technology involved in creating colour sensations which can be adapted to different moods, to the characteristics of the setting and to physical and mental moods of each individual. Light takes back its sense of colour, with all its symbolic and beneficial power.

A.L.S.O. is a collection of multi-performing objects for the integrated management of important environmental parameters, like light, sound and air, using the combined action of lighting technologies, sound diffusion and electrostatic filtration. The entire setting can be moulded to individual needs.

With MY WHITE LIGHT Artemide makes appliances available that can generate variable white light from warm tones (2.500 K) to very cold tones (20.000 K) and adjustable in intensity, as well as generating coloured light. For the first time man can choose between the infinite shades of white light.

LUXERION is a new range of multifunctional appliances which integrate light and air purification. Developed together with Elica, leader in the production of kitchen hoods, it is a totally innovative line, which marks a first-time level of comfort in residential and professional settings.

Pour Artemide, l'objectif poursuivi est à la fois simple et extraordinairement complexe : faire de la lumière un élément capable d'améliorer la qualité de la vie. The Human Light, projet promu par Carlotta de Bevilacqua, signifie concevoir la lumière de façon à accompagner l'Homme tout au long de ses activités de tous les jours, dans le respect de ses états d'âme et en contribuant à son bien-être individuel, le tout en offrant un maximum de précision visuelle et un minimum de consommation des ressources environnementales.

La vision de The Human Light a été déclinée sur différents parcours de recherche essentiels : METAMORFOSI (projet breveté) est une technologie innovatrice qui s'attache à créer des sensations chromatiques pouvant être adaptées aux états d'âme du moment, aux caractéristiques de l'environnement et aux nuances, tant physiques et mentales, qui caractérisent chaque individu. La lumière est restituée au sens des couleurs, avec toute leur capacité symbolique et bénéfique.

A.L.S.O. est une collection d'objets aux performances multiples qui consentent une gestion intégrée de paramètres environnementaux de tout premier plan, comme la lumière, le son et l'air, grâce à l'action combinée de technologies destinées à l'éclairage, la diffusion sonore et le filtrage électrostatique. L'environnement, dans sa totalité, est malléable en fonction des exigences personnelles.

Avec MY WHITE LIGHT, Artemide propose des appareils en mesure de générer tant de la lumière blanche, variable, des tons les plus chauds (2.500 K) aux tons les plus froids (20.000 K), et réglable en intensité, que de la lumière colorée. Pour la première fois, l'Homme peut choisir entre une infinité de tonalités de lumière blanche.

LUXERION est une nouvelle gamme d'appareils multifonctionnels qui intègrent lumière et purification de l'air. Développée en collaboration avec Elica, leader dans la production de hottes aspirantes, il s'agit d'une ligne totalement innovante, qui assure un niveau de confort sans précédent pour les environnements tant résidentiels que professionnels.

Artemide hat sich eine ebenso einfache wie komplexe Aufgabe gestellt: Licht zu einem Element zu machen, das zu mehr Lebensqualität beiträgt. The Human Light, ein Projekt von Carlotta de Bevilacqua, versteht Licht als einen Begleiter des Menschen im Alltag, als Förderung seiner Stimmung und Beitrag zu seinem persönlichen Wohlbefinden, mit der Prämisse bestmöglicher Beleuchtungsverhältnisse und geringstmöglichen Verbrauchs von Ressourcen.

Diese Vision von The Human Light kommt in mehreren bedeutenden Produktentwicklungen zum Ausdruck: METAMORFOSI (patentiertes Projekt) ist eine innovative Technologie mit der Absicht, Farbeffekte zu erzeugen, die sich an die verschiedenen Stimmungen des Menschen, die Art der Umgebung und das physische und geistige Befinden eines jeden einzelnen Menschen anpassen lassen. Licht bekommt hier wieder Farbe, die mit ihrem ganzen symbolischen Gehalt und all ihrer wohltuenden Wirkung wahrgenommen wird.

A.L.S.O. ist eine Kollektion von Multiperformance-Objekten für die integrierte Steuerung von so wichtigen Umgebungsfaktoren wie Licht, Klang und Luft mittels der Kombination von Technologien für Beleuchtung, Sound und elektrostatistische Luftfiltrierung. Das gesamte Umfeld lässt sich nach ganz persönlichen Vorstellungen gestalten.

Mit MY WHITE LIGHT bietet Artemide Beleuchtungskörper an, die weißes Licht in warmen (2.500 K) bis hin zu den sehr kalten Tönen (20.000 K) mit regulierbarer Intensität und ebenso auch farbiges Licht erzeugen können. Der Mensch hat erstmalig die Auswahl unter unendlichen Abstufungen weißen Lichts.

LUXERION ist eine neue Linie multifunktionaler Beleuchtungskörper, die gleichzeitig für Licht und saubere Luft sorgen. Die gemeinsame Entwicklung mit Elica, dem Leader in der Herstellung von Absaughauben, führt zu einer absolut innovativen Linie für ein bisher beispielloses Niveau an Komfort im Wohn- und Arbeitsbereich.

Para Artemide el objetivo es al mismo tiempo simple y extraordinariamente complejo: hacer de la luz un elemento capaz de mejorar la calidad de la vida. The Human Light, proyecto propuesto por Carlotta de Bevilacqua, significa concebir la luz para acompañar al hombre en la actividad cotidiana, adaptándose a los estados de ánimo y contribuyendo al bienestar individual, con la máxima precisión visual y el mínimo consumo de recursos ambientales.

La visión The Human Light ha sido desarrollada en diferentes categorías de investigación: METAMORFOSI (proyecto patentado) es una tecnología innovadora empeñada en crear sensaciones cromáticas que pueden ser adaptadas a los diferentes estados de ánimo, a las características del ambiente y a las atmósferas físicas y mentales de cada individuo. La luz es retoma el sentido de los colores, con toda su capacidad simbólica y de bienestar.

A.L.S.O. es una colección de objetos con múltiples funcionalidades que admiten la gestión integrada de parámetros ambientales relevantes, tales como la luz, sonido y aire, mediante la acción combinada de tecnologías para la iluminación, la difusión sonora y la filtración electrostática. El ambiente entero es plasmable en función de las exigencias personales.

Con MY WHITE LIGHT Artemide propone aparatos generando, sea luz blanca variable de tonos cálidos (2.500 K) o tonos muy fríos (20.000 K) y regulable en intensidad, como también generar luz de color. Por primera vez el hombre puede escoger entre las infinitas tonalidades de luz blanca.

LUXERION es una nueva gama de aparatos multifuncionales que integran luz y purificación del aire. Desarrollada en colaboración con Elica, líder en la producción de campanas extractoras, es una línea totalmente innovadora que señala un nivel de confort sin precedentes en los ambientes residenciales y profesionales.



MODUL
ELECTRO
www.modulselectro.ru

Artemide

Artemide

Artemide

Il Gruppo Artemide è uno dei leader mondiali nel settore dell'illuminazione residenziale e professionale di alta gamma. Con sede a Milano, opera attraverso un'ampia organizzazione commerciale che si declina in società controllate e distributori specializzati, e vanta una rete distributiva tra cui spiccano gli showroom monomarca nelle più importanti città del mondo e gli shop-in-shop nei migliori negozi di illuminazione e arredamento.

Con diversi stabilimenti, per garantire il più alto livello qualitativo tramite l'accurato e completo controllo del processo produttivo, il Gruppo Artemide è organizzato in due Divisioni di Business – Design e Architectural. In particolare, nel comparto professionale, grazie alla recentissima acquisizione di Nord Light, il Gruppo Artemide ha ulteriormente rafforzato la propria capacità di penetrazione del mercato, potendo contare su una gamma di apparecchi tecnici LED ai migliori livelli e su una struttura totalmente dedicata alla realizzazione di progetti di illuminazione tailor made.

Fondata da Ernesto Gismondi e Sergio Mazza nel 1960, grazie all'incessante sforzo di ricerca ed innovazione tecnologica, alla collaborazione con i migliori designers del mondo, alla continua attività di comunicazione e pubblicità, Artemide è uno dei brand di illuminazione più riconosciuti e prestigiosi nel mondo, sinonimo di Design, Luce e Made in Italy.

Artemide Group is a worldwide leader in high range residential and professional lighting. Located in Milan, the company operates through a large-scale commercial organisation which takes the form of subsidiary companies and specialised distributors, and boasts a distribution network which includes mono brand showrooms in the most important cities worldwide and shop in shop in the best lighting and furniture stores.

With numerous plants, to guarantee the highest level of quality through the accurate and complete control of the production process, Artemide is structured in two Business Divisions – Design and Architectural. The very recent acquisition of Nord Light has enabled Artemide to further strengthen its ability to penetrate the market, relying on a range of LED technical appliances of the highest standards and a structure fully dedicated to the design and production of tailor-made lighting projects.

Artemide was founded by Ernesto Gismondi and Sergio Mazza in 1960. The ongoing commitment to research and technological innovation, collaboration with the best designers around the world, and continuous communication and advertising have made Artemide one of the world's best-known and celebrated lighting brands, synonymous of Design, Light and Made in Italy.

Le Groupe Artemide est l'un des leaders mondiaux du secteur de l'éclairage résidentiel et professionnel haut de gamme. Depuis son siège de Milan, il opère au travers d'une vaste organisation commerciale, qui se décline en sociétés contrôlées et distributeurs spécialisés, et peut compter sur un réseau de distribution d'excellence, avec en particulier des showrooms monomarkes dans les villes les plus importantes du monde entier et des shops-in-shops situés dans les meilleurs magasins d'éclairage et d'ameublement.

Avec différents établissements de production, permettant de garantir un niveau qualitatif d'excellence grâce au contrôle extrêmement soigné et complet de tous les processus, le Groupe Artemide est organisé en deux Divisions Business – Design et Architectural. Pour ce qui concerne le secteur professionnel en particulier, avec l'acquisition toute récente de Nord Light, le Groupe Artemide a ultérieurement renforcé sa capacité de pénétration du marché, pouvant compter sur une gamme d'appareils techniques LED du plus haut niveau et sur une structure totalement dédiée à la réalisation de projets d'éclairage sur mesure.

Fondée par Ernesto Gismondi et Sergio Mazza en 1960, grâce aux efforts incessants de recherche et d'innovation technologique, à la collaboration avec les meilleurs Designers du monde entier, à ses activités de communication et de publicité continues, Artemide est l'une des marques du secteur de l'éclairage parmi les plus connues et les plus prestigieuses existant au niveau mondial, synonyme de Design, de Lumière et d'excellence Made in Italy.

Die Gruppe Artemide zählt zu den weltweit führenden Unternehmen im Bereich hochwertiger Wohn- und Arbeitsraumbeleuchtung. Ihr Geschäftssitz ist Mailand. Die umfassende Verkaufsorganisation besteht aus Filialen und Spezialgeschäften und einem Vertriebsnetz, in dem insbesondere die unternehmenseigenen Showrooms in den wichtigsten Städten der Welt und die Shop-in-Shops in den führenden Geschäften für Beleuchtung und Einrichtung beeindruckend sind.

Die Gruppe Artemide hat mehrere Werke und ist in zwei Geschäftsbereiche aufgeteilt - Design und Architectural - und kann so jederzeit höchste Qualität mittels sorgfältiger Überwachung der Produktionsprozesse garantieren. Dank der jüngsten Übernahme von Nord Light konnte die Gruppe Artemide ihre Marktdurchdringungsfähigkeit im Bereich der Arbeitsplatzbeleuchtung zusätzlich stärken: Mit einem Angebot an technischen LED-Beleuchtungskörpern höchsten Niveaus und einer Struktur, die sich vollständig auf individuell zugeschnittene Beleuchtungsprojekte spezialisiert hat.

Gegründet 1960 von Ernesto Gismondi und Sergio Mazza ist Artemide heute, dank unablässiger Entwicklungsarbeit und technologischer Innovation, dank der Zusammenarbeit mit den weltweit besten Designern, dank kontinuierlicher Kommunikation und Werbung eine der bekanntesten und berühmtesten Marken für Beleuchtung in der Welt - Synonym für Design, Licht und Made in Italy

El Grupo Artemide es uno de los líderes mundiales en el sector de la iluminación residencial y profesional de alta gama. Con sede en Milán, opera a través de una amplia organización comercial que se desarrolla en sociedades controladas y distribuidores especializados, más una red distributiva con los showroom monomarca en las más importantes ciudades del mundo y los shop-in-shop en los mejores negocios de iluminación y decoración.

Con distintos establecimientos, para garantizar el más alto nivel cualitativo gracias al preciso y completo control del proceso productivo, el Grupo Artemide está organizado en dos Divisiones de Business – Design y Architectural. En particular, en el sector técnico-comercial, gracias a la reciente adquisición de Nord Light, el Grupo Artemide ha ulteriormente reforzado su propia capacidad de penetración del mercado, pudiendo así contar con una gama de aparatos técnicos LED a los mejores niveles y en una estructura totalmente dedicada a la realización de proyectos de iluminación a su medida.

Fundada por Ernesto Gismondi y Sergio Mazza en el 1960, gracias al incesante esfuerzo de búsqueda e innovación tecnológica, a la colaboración con los mejores diseñadores del mundo, a la continua actividad de comunicación y publicidad, Artemide es uno de las marcas de iluminación más reconocidas y prestigiosas en el mundo, sinónimo de Design, Luz y Made in Italy.

Lampade da tavolo

Table lamps
Lampes de table
Tischleuchten
Lámparas de sobre-mesa



Lampade da terra

Floor lamps
Lampadaires
Stehleuchten
Lámparas de pie



Lampade da parete

Wall lamps
Appliques
Wandleuchten
Apliques



Lampade da soffitto

Ceiling lamps
Plafonniers
Deckenleuchten
Pláfonos



- 18 Egle
- 20 Veio
- 22 Itis
- 24 One line tavolo
One line tavolo Led
- 25 Talak tavolo
Talak tavolo Led
- 26 Cosmic Leaf tavolo
- 28 Tizio Led
- 30 Tizio
Tizio 35
Tizio plus
Tizio micro
Tizio X30
- 32 Tolomeo
Tolomeo mini
Tolomeo Led
Tolomeo mini Led
Tolomeo Led MWL
Tolomeo mini Led MWL
- 36 Tolomeo micro
- 38 Tolomeo basculante tavolo
- 39 Tolomeo Mega morsetto
- 40 Melampo tavolo
Melampo notte
- 42 Choose tavolo
- 43 Monroe
- 44 Nessino
- 45 Dalù
- 46 Yang, Yang touch
- 48 Aqua Cil tavolo
- 50 Nestore 90 tavolo
- 51 Shogun tavolo
- 52 Dioscuri tavolo 14, 25, 35, 42
- 54 Castore tavolo 14, 25, 35, 42
- 55 Castore calice tavolo
- 56 Soffione tavolo 36, 45
- 57 Soffione stelo tavolo 36, 45
- 58 Logico tavolo
Logico tavolo mini
Logico tavolo micro
- 60 Onfale tavolo grande
Onfale tavolo medio
Onfale tavolo piccolo
- 61 Miconos tavolo

- 64 Ipogeo
- 66 Doride
- 68 Cadmo
- 70 Aqua Cil terra
- 72 Cabildo terra
- 73 Echos
- 74 Megaron terra
- 75 Callimaco
- 76 Tizio supporto terra
- 77 Nestore terra
Nestore lettura
- 78 Tolomeo terra
Tolomeo lettura
Tolomeo micro terra
- 80 Tolomeo XXL
- 82 Tolomeo basculante terra
Tolomeo basculante lettura
- 84 Tolomeo Mega terra
- 86 Melampo terra
Melampo Mega terra
- 87 Choose terra
Choose Mega terra
- 88 Genesy
- 90 Cosmic Leaf terra
- 92 Pipe terra
- 94 Talak lettura
Talak lettura Led
- 95 Firefly lettura
- 96 Metacolor
- 97 Metacolor MWL
- 98 Rigel
- 100 Yin flu
- 102 Prometeo
- 103 Iride
- 104 Castore terra 35, 42
- 106 Soffione terra
- 107 Logico terra
- 108 Miconos terra
- 109 Acquarelli
- 110 Acheo terra
- 111 Tebe terra
- 112 Montjuic
- 113 Zen terra

- 121 Droplet mini parete/soffitto
- 128 Cosmic Angel parete
- 132 Space Oddity parete
- 135 Eurialo
- 136 Talo parete
- 138 Talo parete 90, 120, 150, 180, 240
- 139 Cabildo parete
- 140 Mesmeri
- 142 Tities 26, 40, 70
- 143 Astarte
- 148 Go to the mirror
- 150 Altrevo parete/soffitto
- 152 Rothko
- 156 My White Light kit
- 157 Metamorfoosi kit 3, kit 4
- 160 Tolomeo parete
Tolomeo mini parete
Tolomeo micro parete
Tolomeo braccio
- 162 Tolomeo faretto
Tolomeo micro faretto
- 163 Tolomeo pinza
Tolomeo micro pinza
- 164 Tolomeo parete diffusore 18, 24, 32
- 166 Tolomeo basculante parete
- 167 Tolomeo Mega parete
- 169 Melampo parete
- 170 Choose parete
Choose Led
Choose parete + Led
Choose incasso Led
- 172 Cadmo parete
- 174 Talak parete
Talak parete LED
- 175 Pipe parete/soffitto
- 176 Edge parete/soffitto 21, 30
- 177 Teti
- 179 Telefono 50, 70, 120, 170
Telefono 72 vetro Murano
- 180 Dioscuri parete/soffitto 14, 25, 35, 42
- 182 Soffione parete/soffitto 36, 45
- 188 Logico parete
Logico parete mini
Logico parete micro
- 190 Logico parete mini full
- 191 Miconos parete
- 192 Frost
- 193 Robbia 30, 60
- 194 Canne
- 195 Sagitta
- 196 Onfale parete 28, 36, 28 vetro chiuso
- 197 Tilos 150, 200
- 198 Kalias 110, 200
Deltakalias
Trikalias
Pentakalias
- 200 Utopia parete/soffitto 32, 42, 52
- 201 Zsu-zsu parete/soffitto 55, 65
- 202 Acheo parete
- 203 Icaro

- 116 Mercury soffitto
- 118 Mercury Cluster
- 120 Droplet soffitto
- 121 Droplet mini parete/soffitto
- 122 Skydro
- 124 Cosmic Leaf soffitto
Cosmic Leaf incasso
Cosmic Leaf mini incasso
- 126 Cosmic Ocean
- 130 Cosmic Angel soffitto
- 134 Aqua Cil soffitto
- 144 Nur soffitto
Nur mini soffitto
- 145 Nur Gloss soffitto
Nur mini Gloss soffitto
- 146 Float soffitto circolare
Float soffitto lineare
- 149 Lara
- 150 Altrevo parete/soffitto
- 154 Pozzo
- 156 My White Light kit
- 157 Metamorfoosi kit 3, kit 4
- 168 Alicud
- 175 Pipe parete/soffitto
- 176 Edge parete/soffitto 21, 30
- 177 Teti
- 178 Zeffiro 80, 140
- 180 Dioscuri parete/soffitto 14, 25, 35, 42
- 182 Soffione parete/soffitto 36, 45
- 184 Logico soffitto
Logico soffitto mini
Logico soffitto micro
Logico soffitto nano
- 191 Miconos soffitto
- 195 Sagitta
- 197 Tilos 150, 200
Tilos 150 incasso
- 198 Kalias 110, 200
Deltakalias
Trikalias
Pentakalias
- 200 Utopia parete/soffitto 32, 42, 52
- 201 Zsu-zsu parete/soffitto 55, 65
- 202 Acheo soffitto

MODULO
EL CENTRO
www.modulocentro.ru

Lampade a sospensione

Suspension lamps
Suspensions
Pendelleuchten
Suspensiones

Residential outdoor

Modern Classic

Collezioni





- 206 Mercury sospensione
- 208 Droplet sospensione
- 210 Cosmic Angel sospensione
- 212 Aqua Cil sospensione
- 214 Cabildo sospensione
- 216 Pirce
- 218 Space Oddity sospensione
- 220 Talo sospensione
- 222 Float sospensione circolare
Float sospensione lineare
- 226 Nur Metamorfozi
Nur 1618 Metamorfozi
Nur mini Metamorfozi
- 228 Nur
Nur 1618
Nur mini
- 230 Nur Gloss
Nur mini Gloss
- 232 Eutopia
- 234 Eutopia Pro
- 236 Altreve sospensione
- 240 Tian Xia Metamorfozi
- 242 Tian Xia 2
- 243 Tian Xia halo
- 244 Tian Xia 500 Led
- 245 Tian Xia 500 filuo
- 246 Trifluro
- 248 Sarissa
- 249 Attalo
- 250 Tolomeo sosp. due bracci alluminio
- 251 Tolomeo sosp. due bracci pergamena
- 252 Tolomeo sospensione decentrata
- 254 Tolomeo Mega sospensione 42, 52
- 256 Choose sospensione
Choose Mega sospensione
- 258 Pipe sospensione
- 260 Mouette simmetrica
Mouette asimmetrica
- 262 Fractals
- 264 Aggregato sospensione
Aggregato sospensione saliscendi
Aggregato sospensione decentrato
- 265 Talak sospensione
- 266 Edge sospensione 30
- 267 Castore calice sospensione 18, 42
- 268 Castore sospensione 18, 25, 35, 42
- 270 Soffione sospensione 36, 45
- 272 Noto
- 274 Logico sospensione, mini, micro, nano
- 278 Miconos sospensione
- 279 Zsu-Zsu sospensione 55, 65

- 286 Tolomeo XXL
- 288 Ciclope incasso
Ciclope parete
Ciclope terra 50, 90
- 290 Chilone parete
Chilone terra 45, 90, 250
Chilone up
- 292 Gilippo
- 294 Pantarei
- 296 Niki
- 297 Dioscuri parete/soffitto 14, 25, 35, 42
- 298 Giasole t.s. parete/soffitto
Giasole t.s. terra
- 300 Illo
- 300 Catilina
- 300 Aglala
- 301 Alcesti parete
Alcesti terra
- 302 Teseo parete
Teseo terra
- 304 Mitasi 36 t.s.
- 305 Onlylight
Onlyled
- 306 Metamorfozi kit outdoor
- 306 Metaponto
- 308 Felsina parete
Felsina palo
- 310 Timpone





























- 314 Alfa
- 315 Eclipse
- 316 Lesbo
- 317 Nesso
- 318 Patroclo
- 319 Boalum
- 320 Chimera
Mezzachimera
- 321 Fato

- 324 Leda sospensione 6
Leda sospensione 8
Leda sospensione 12
Leda sospensione 12+6
Leda parete 2
- 326 Pantalica sospensione
Pantalica parete 2
Pantalica parete 3
- 328 Melissa
- 329 Fenice 8
Fenice 15
Fenice 20
- 330 Giocasta parete 1
Giocasta parete 2
Giocasta soffitto 3
Giocasta sospensione

 **MODUL** 
ELECTRO
www.modulelectro.ru

LUXERION

- 281 Azio
- 282 Farsalo
- 283 Filippi

		 Table	 Floor
Acheo	110 202 202		
Altrove	150 232		
Aqua Cil	40 70 134 212		
Cabildo	72 239 214		
Cadmo	68 172		
Castore	54 104 268	   	 
Castore calice	55 267		
Choose	42 87 170 256		 
Cosmic Angel	128 130 210		
Cosmic Leaf	26 90 124		
Dioscuri	52 180 297	   	
Droplet	109 212 212		
Edge	176 266		
Float	146 222		
Logico	58 107 184 188 190 274	  	
Logico in linea	184 188 274		
Logico 3x120°	184 274		
Logico 4x90°	184 274		

www.modulelectro.ru

	Wall	Ceiling	Suspension
--	------	---------	------------

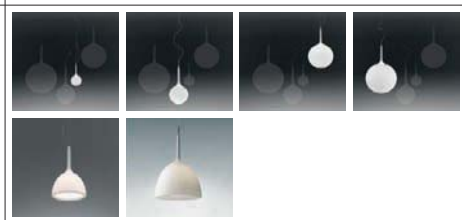
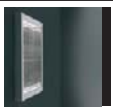

MODULO
ELECTRO
www.modulelectro.ru

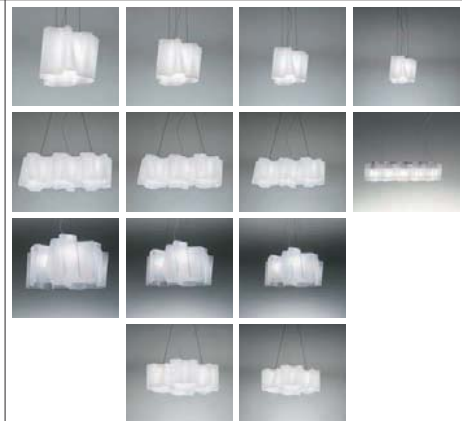
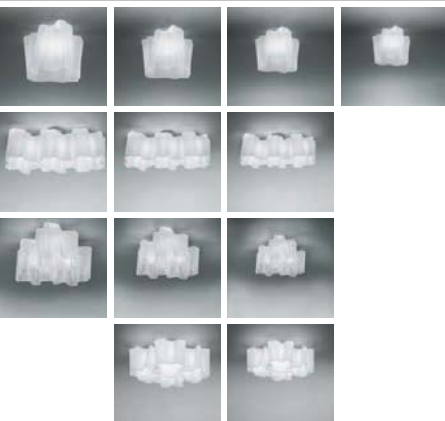
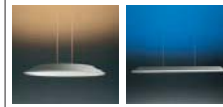

Table

Floor

Melampo	40 86 169
Mercury	116 118 206
Miconos	61 191 278
Nestore	50 77
Nur	144 145 226 228 230
Onfale	60 196
Pipe	92 175 258
Soffione	56 57 106 182 270
Space Oddity	132 218
Talak	25 94 174 265
Talo	136 138 220
Tizio	28 30 76
Tolomeo	32 36 78 160 162 163 164 250 252 286
Tolomeo basculante	38 82 166 251 252
Tolomeo Mega	39 84 167 254
Zsu-zsu	201 279

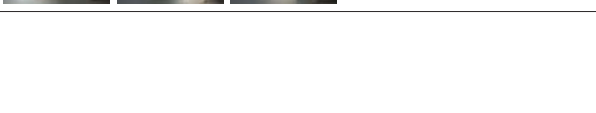
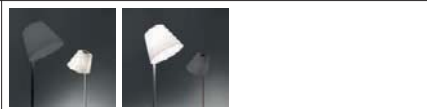

MODUL
ELECTRO

www.modulelectro.ru

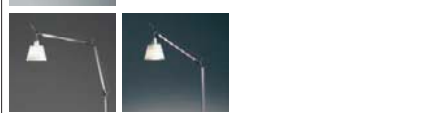
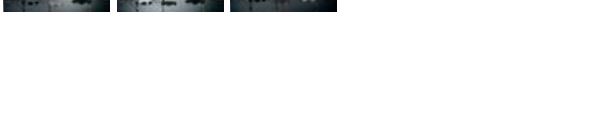

Wall	Ceiling	Suspension
------	---------	------------

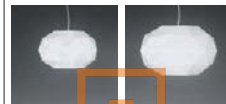
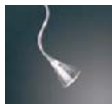

MODUL
ELECTRO

www.modulelectro.ru

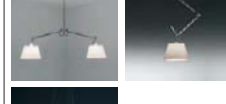



Indice alfabetico

Alphabetical index

Index par order alphabétique

Alphabetisches Inhaltsverzeichnis

Índice alfabético

202	Acheo parete	234	Eutopia Pro	272	Noto	166	Tolomeo basculante parete
202	Acheo soffitto			228	Nur, 1618, Mini	251	Tolomeo basculante sospensione due bracci pergamena
110	Acheo terra	282	Farsalo	230	Nur Gloss, mini	38	Tolomeo basculante tavolo
109	Acquarelli	321	Fato	145	Nur Gloss soffitto, mini	82	Tolomeo basculante terra
264	Aggregato sospensione, decentrato, saliscendi	308	Felsina palo	226	Nur Metamorfosi, 1618, mini	160	Tolomeo braccio
300	Aglaia	308	Felsina parete	144	Nur soffitto, mini	162	Tolomeo faretto
301	Alcesti parete	329	Fenice 8, 15, 20			32	Tolomeo Led
301	Alcesti terra	283	Filippi	24	One line tavolo Led	32	Tolomeo Led MWL
314	Alfa	95	Firefly lettura	24	One line tavolo	78	Tolomeo lettura
168	Alicudi	146	Float soffitto circolare	196	Onfale parete 28, 36, 28 vetro chiuso	39	Tolomeo Mega morsetto
150	Altrove parete/soffitto	146	Float soffitto lineare	60	Onfale tavolo grande	167	Tolomeo Mega parete
236	Altrove sospensione	222	Float sospensione circolare, lineare	60	Onfale tavolo medio	254	Tolomeo Mega sospensione 42,52
134	Aqua Cil soffitto	262	Fractals	60	Onfale tavolo piccolo	84	Tolomeo Mega terra
212	Aqua Cil sospensione	192	Frost	305	Onlyled	36	Tolomeo micro
48	Aqua Cil tavolo			305	Onlylight	162	Tolomeo micro faretto
70	Aqua Cil terra	88	Genesy			160	Tolomeo micro parete
143	Astarte	298	Giasole t.s. parete/soffitto	326	Pantalica parete 2, 3	163	Tolomeo micro pinza
249	Attalo	298	Giasole t.s. terra	326	Pantalica sospensione	78	Tolomeo micro terra
281	Azio	292	Gillippo	294	Pantarei 180, 300, 390	32	Tolomeo mini
		330	Giocasta parete 1, 2	318	Patroclo	32	Tolomeo mini Led
319	Boalum	330	Giocasta soffitto 3	198	Pentakalias	32	Tolomeo mini Led MWL
		330	Giocasta sospensione	92	Pipe terra	160	Tolomeo mini parete
139	Cabildo parete	148	Go to the mirror	175	Pipe parete/soffitto	160	Tolomeo parete
214	Cabildo sospensione			258	Pipe sospensione	164	Tolomeo parete diffusore 18, 24, 32
72	Cabildo terra	203	Icaro	216	Pirce	163	Tolomeo pinza
68	Cadmo	300	Illo	154	Pozzo	252	Tolomeo sospensione decentrata
172	Cadmo parete	64	Ipogeo	102	Prometeo	250	Tolomeo sosp. due bracci alluminio
75	Callimaco	103	Iride			78	Tolomeo terra
194	Canne	22	Itis	98	Rigel	286, 80	Tolomeo XXL
267	Castore calice sospensione 18, 42	198	Kalias 110, 200	193	Robbia 30, 60	246	Trifluo
55	Castore calice tavolo			152	Rothko	198	Trikalias
268	Castore sospensione 18, 25, 35, 42	149	Lara	195	Sagitta		
54	Castore tavolo 14, 25, 35, 42	324	Leda parete 2	248	Sarissa	200	Utopia parete/soffitto 32, 42, 52
104	Castore terra 35, 42	324	Leda sospensione 6, 8, 12, 12+6	51	Shogun tavolo	20	Veio
300	Catilina	316	Lesbo	122	Skydro		
290	Chilone parete	188	Logico parete, mini, micro	182	Soffione parete/soffitto 36, 45	46	Yang
290	Chilone terra 40, 100, 250, up	190	Logico parete mini full	270	Soffione sospensione 36, 45	46	Yang touch
320	Chimera	184	Logico soffitto, mini, micro, nano	57	Soffione stelo tavolo 36, 45	100	Yin flu
170	Choose incasso Led	274	Logico sospensione, mini, micro, nano	56	Soffione tavolo 36, 45		
170	Choose Led	58	Logico tavolo, mini, micro	106	Soffione terra	178	Zeffiro 80, 140
256	Choose Mega sospensione	107	Logico terra	132	Space Oddity parete	113	Zen terra
87	Choose Mega terra			218	Space Oddity sospensione	201	Zsu-zsu parete/soffitto 55, 65
170	Choose parete	74	Megaron terra			279	Zsu-Zsu sospensione 55, 65
170	Choose parete + Led	86	Melampo Mega terra	94	Talak lettura		
256	Choose sospensione	40	Melampo notte	94	Talak lettura Led		
42	Choose tavolo	169	Melampo parete	174	Talak parete		
87	Choose terra	40	Melampo tavolo	174	Talak parete Led		
288	Ciclope incasso	86	Melampo terra	265	Talak sospensione		
288	Ciclope parete	328	Melissa	25	Talak tavolo Led		
288	Ciclope terra 50, 90	118	Mercury Cluster	25	Talak tavolo		
128	Cosmic Angel parete	116	Mercury soffitto	136	Talo parete		
130	Cosmic Angel soffitto	206	Mercury sospensione	138	Talo parete 90, 120, 150, 180, 240		
210	Cosmic Angel sospensione	140	Mesmeri	220	Talo sospensione		
124	Cosmic Leaf soffitto	96	Metacolor	111	Tebe terra		
124	Cosmic Leaf incasso	97	Metacolor MWL	179	Telefo 50, 70,120, 170		
124	Cosmic Leaf mini incasso	157	Metamorfosi kit 3, kit 4	179	Telefo 72 vetro Murano		
26	Cosmic Leaf tavolo	306	Metamorfosi kit outdoor	302	Teseo parete		
90	Cosmic Leaf terra	306	Metaponto	302	Teseo terra		
126	Cosmic Ocean	320	Mezzachimera	177	Teti		
		191	Miconos parete	242	Tian Xia 2		
45	Dalù	191	Miconos soffitto	245	Tian Xia 500 fluo		
198	Deltakalias	278	Miconos sospensione	244	Tian Xia 500 Led		
180, 297	Dioscuri parete/soffitto 14, 25, 35, 42	61	Miconos tavolo	243	Tian Xia halo		
52	Dioscuri tavolo 14, 25, 35, 42	108	Miconos terra	240	Tian Xia Metamorfosi		
66	Doride	304	Mitasi 36 t.s.	197	Tilos 150, 150 incasso, 200		
121	Droplet mini parete/soffitto	43	Monroe	310	Timpone		
120	Droplet soffitto	112	Montjuic	142	Tities 26, 40, 70		
208	Droplet sospensione	260	Mouette simmetrica, asimmetrica	30	Tizio		
		156	My White Light kit	30	Tizio 35		
73	Echos			28	Tizio Led		
315	Eclisse	44	Nessino	30	Tizio micro		
176	Edge parete/soffitto 21, 30	317	Nesso	30	Tizio plus		
266	Edge sospensione 30	50	Nestore 90 tavolo	76	Tizio supporto terra		
18	Egle	77	Nestore lettura	30	Tizio X30		
135	Eurialo	77	Nestore terra	32	Tolomeo		
232	Eutopia	296	Niki	82	Tolomeo basculante lettura		

Lampade da tavolo

Table lamps / Lampes de table / Tischleuchten / Lámparas de sobre-mesa



MODUL
ELECTRO
www.modulelectro.ru



18
Egale



20
Veio



22
Itis



24
One line tavolo,
tavolo Led



25
Talak tavolo,
tavolo Led



26
Cosmic Leaf tavolo



28
Tizio Led



30
Tizio, 35, plus,
micro, X30



32
Tolomeo, mini, Led,
mini Led, Led MWL,
mini Led MWL



36
Tolomeo micro



38
Tolomeo basculante
tavolo



39
Tolomeo Mega
morsetto



40
Melampo tavolo,
notte



42
Choose tavolo



43
Monroe



44
Nessino



45
Dalù



46
Yang, Yang touch



48
Aqua Cil tavolo



50
Nestore 90 tavolo



51
Shogun tavolo



52
Dioscuri tavolo 14,
25, 35, 42



54
Castore tavolo 14,
25, 35, 42



55
Castore calice tavolo



56
Soffione tavolo 36, 45



57
Soffione stelo tavolo
36, 45



58
Logico tavolo,
mini, micro



60
Onfaie tavolo
grande, medio,
piccolo



61
Miconos tavolo

MODULO
ELECTRO
www.modulelectro.ru



Materiali: base e diffusore in zama cromata o verniciata; stelo in acciaio.

Specificità: lo stelo è orientabile in tutte le direzioni tramite uno snodo sferico posto sulla base. Il diffusore, dotato di una lente concentrante, ruota di 360° sulla verticale. Quando il diffusore è orientato verticalmente verso il basso, la base funge da riflettore.

Light emission



Colours



Polished white



Polished black



Mirror

Materials

Chromed or painted zamak base and diffuser; stem in steel.

Specification

The stem is adjustable in all directions thanks to a spherical pivot positioned on the base. The diffuser, fitted with a concentrating lens, rotates 360° on the vertical axis. When the diffuser is directed downwards vertically, the base acts as a reflector.

Matériaux

Base et diffuseur en zamak chromé ou peint ; tige en acier.

Spécificité

La tige peut s'orienter dans tous les sens grâce à l'articulation à rotule située sur la base. Le diffuseur est muni d'une lentille concentrante qui tourne à 360° sur l'axe vertical. Quand le diffuseur est orienté verticalement vers le bas, la base sert de réflecteur.

Materialien

Sockel und Schirm aus lackiertem oder verchromtem Zamak; Stab aus Stahl.

Spezifikation

Ein auf dem Unterteil installiertes Kugelgelenk ermöglicht die individuelle Ausrichtung der Leuchte. Diffusor mit Linse zur Lichtbündelung um 360° auf der vertikalen Achse drehbar. Bei Positionierung des Leuchtenkopfes nach unten dient der Leuchtenfuß als Reflektor.

Materiales

Base y difusor de zamak pintado o cromado; vástago en acero.

Especificaciones

El vástago se puede orientar en todas las direcciones mediante una articulación esférica colocada en la base. El difusor, dotado de una lente concentrante, gira 360° en la vertical. Cuando el difusor está orientado verticalmente hacia abajo, la base funciona como reflector.

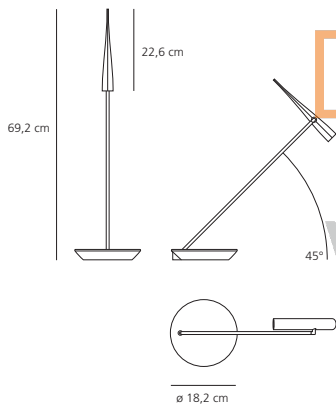

LED 3W, included
(illuminance: max 750 lux, cm 40h)

IP20 Touch Dimmer

MODUL
ELECTRO
www.modulelectro.ru





MODUL
ELECTRO

www.modulelectro.ru

Veio

design

Neil Poulton
2008

MY WHITE LIGHT®



Materiali: alluminio verniciato.

Specificità: grazie alla tecnologia My White Light è possibile generare tutte le sfumature di luce bianca, dalla più calda (2.500K) alla più fredda (20.000 K).

Light emission



Colours

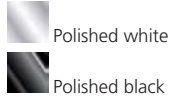

Materials

Painted aluminium.

Specification

Thanks to My White Light technology, it is possible to produce all the tones of white light, from the warmest (2.500 K) to the coldest (20.000 K).

Matériaux

Aluminium verni.

Spécificité

La technologie My White Light permet de générer toutes les nuances de lumière blanche, de la plus chaude (2.500 K) à la plus froide (20.000 K).

Materialien

Lackiertes Aluminium.

Spezifikation

Mit integrierter My White Light-Technologie lassen sich alle Weißlichtstufen von warm (2.500 K) bis kalt erzeugen. (20.000 K).

Materiales

Aluminio pintado.

Especificaciones

Gracias a la tecnología My White Light es posible generar todos los matices de luz blanca, de la más cálida (2.500 K) a la más fría (20.000 K).

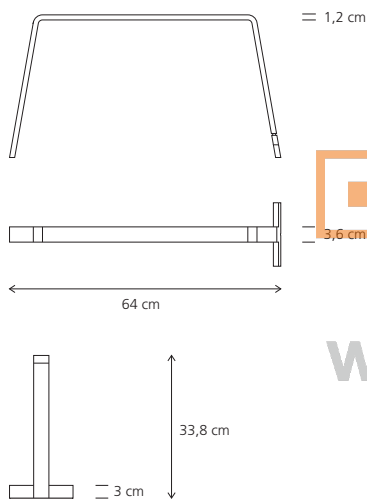

MODULO
ELECTRO
www.modulelectro.ru

LED 12,5W (amber, white, blue) included
(Illuminance: max 600 lux, cm 40h)

IP20 + - Touch Dimmer



 **MODUL** 
ELECTRO

www.modulelectro.ru



**Awards**

Reddot Design Award
"Best of the Best"
2007 – Essen (Deutschland)
Good Design Award
The Chicago Atheneum
2007 – Chicago (US)

Museum

Die Neue Sammlung
State Museum of Applied Arts
and Design in the Pinakothek der Moderne
München (Deutschland)

Materiali: base in zama verniciata; stelo in metallo verniciato; testa in metallo verniciato e policarbonato; diffusore in policarbonato trasparente satinato.

Specificità: due snodi collegano lo stelo rispettivamente alla base e alla testa consentendo l'inclinazione dello stelo da 0° a 90° e l'orientamento della testa di 180°.

Materials

Painted zamak base; painted metal stem; painted metal and polycarbonate head; satin transparent polycarbonate diffuser.

Matériaux

Base en zamac peint ; tige en métal peint ; tête en métal peint et polycarbonate ; diffuseur en polycarbonate transparent satiné.

Materialien

Sockel aus lackiertem Zamak; Stab aus lackiertem Metall; Leuchtenkopf aus lackiertem Metall und Polycarbonat; Schirm aus transparentem und satiniertem Polycarbonat.

Materiales

Base de zamak pintado; vástago, de metal pintado; cabeza de metal pintado y policarbonato; difusor de policarbonato transparente satinado.

Specification

Two articulations connect the stem to the base and the head which allow the stem to be tilted from 0° to 90° and the head to be rotated 180°.

Spécificité

Les deux articulations qui relient respectivement la tige à la base et à la tête permettent à la tige de s'incliner de 0° à 90° et à la tête de s'orienter de 180°.

Spezifikation

Die beiden Gelenke am Sockel und am Leuchtenkopf ermöglichen die Drehung des Schaftes von 0° bis 90° und die Ausrichtung des Leuchtenkopfes um 180°.

Especificaciones

Las dos articulaciones, que unen el vástago con el pie y con la cabeza respectivamente, permiten inclinar el vástago de 0° a 90° y orientar la cabeza a 180°.

Light emission**Colours**

White



Black

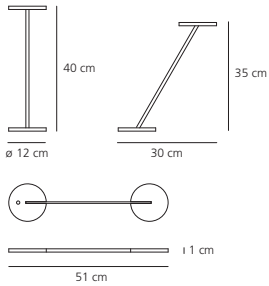

LED 5W, included
(illuminance: max 800 lux, h. 35 cm)

IP20 + Touch Dimmer





MODUL
ELECTRO

www.modulselectro.ru

One line tavolo
One line tavolo Led

design
Ora Ito
2005, 2007



Awards
Reddot Design Award
2005 – Essen (Deutschland)



Materiale: base in pressofusione di alluminio verniciato; corpo lampada in estruso di alluminio con anima d'acciaio. Nella versione fluorescente diffusore in policarbonato.

Specificità: rotazione del corpo lampada sul piano orizzontale.

Light emission



Colours

-  Body and base: silver grey
-  Screen (fluo only): transparent

Materials

Base in painted die-cast aluminium; body in extruded aluminium, steel internal structure. Polycarbonate diffuser by the fluorescent version.

Specification

The lamp unit rotates on the horizontal plane.

Matériaux

Base en aluminium moulé sous pression ; corps en aluminium extrudé ; structure interne en acier. Diffuseur en polycarbonate, dans la version fluorescente.

Spécificité

Rotation du corps de la lampe sur le plan horizontal.

Materialien

Sockel aus Aluminiumdruckguss, Körper aus fließgepresstem Aluminium, Struktur aus Stahl. Bei Bestückung mit Leuchtstofflampen Leuchtenkopf aus Polycarbonat.

Spezifikation

Ausrichtung des Leuchtenkopfes auf der horizontalen Ebene.

Materiales

Base en presofusión de aluminio; cuerpo lámpara en estruso de aluminio con "alma" de acero. Difusor en policarbonato, en la versión fluorescente.

Especificaciones

Rotación del cuerpo de la lámpara sobre el plano horizontal.



One line tavolo

MODUL
ELECTRO
www.modulelectro.ru

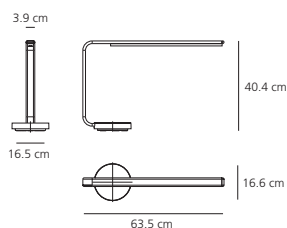

One line tavolo

FLUO 1x11W (W 4,3x8,5d) T2, included
Electronic ballast



One line tavolo Led

LED 80x0,1W included
(illuminance: max 710 lux, h. 40 cm)



One line tavolo Led

Talak tavolo Talak tavolo Led

design

Neil Poulton
2005, 2007



Awards

"Observateur du Design" 2005
Etoile 2005 A.P.C.I. – Paris (France)
Design Innovationen Design Zentrum
Nordrhein Westfalen
Reddot Design Award – Product Design
"Best of the Best 2006"
Essen (Deutschland)
Compasso D'oro / A.D.I.
Segnalazione
2008 – Milano (Italia)

Materiali: base in ferro verniciato; morsetto in alluminio brillantato; stelo in acciaio cromato lucido; corpo lampada in resina termoplastica verniciata.

Specificità: con base tavolo o morsetto. Il corpo lampada ruota di 360° sul piano orizzontale ed è regolabile in altezza.

Light emission



Colours



Base, diffuser:
white



Stem:
mirror

Materials

Base in painted iron; clamp in polished aluminium; stem in chromed polish steel; body lamp in painted thermoplastic resin.

Specification

With table base or clamp. The body lamp rotates 360° on the horizontal plane and it is adjustable in height.

Matériaux

Base en fer peint ; étai en aluminium poli ; tige en acier poli chromé ; corps en résine thermoplastique vernie.

Spécificité

avec base ronde ou étai. Le corps de la lampe s'oriente jusqu'à 360° sur le plan horizontal et se règle en hauteur.

Materialien

Sockel aus lackiertem Eisen; Klemme aus poliertem Aluminium; Stab aus Stahl, Chrom poliert; Leuchtenkörper aus lackiertem Kunstharz.

Spezifikation

Mit Fuß oder Klemmbefestigung. Der Leuchtenkörper kann horizontal um 360° gedreht werden und ist höhenverstellbar.

Materiales

Base en hierro pintado; mordaza en aluminio brillante; tija en acero cromado brillante; cuerpo de la lámpara en resina termoplástica pintada.

Especificaciones

Con base de sobremesa o mordaza. El cuerpo de la lámpara gira a 360° en sentido horizontal y es regulable en altura.



MODUL
ELECTRO
www.modulelectro.ru

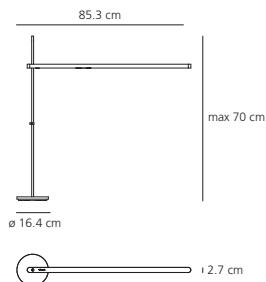

Talak tavolo

FLUO 1x13W (W 4,3x8,5d) – T2, included
Electronic ballast



Talak tavolo Led

LED 80 x 0,1W, included
(illuminance: max 710 lux, h. 40 cm)



Talak tavolo Led

Cosmic Leaf tavolo

design
Ross Lovegrove
2009



Materiali: corpo lampada-diffusore in metacrilato trasparente texturizzato; corpo illuminante in metallo spazzolato.

Light emission



Colours



Diffuser:
transparent



Lighting unit:
grey

Materials

Body lamp-diffuser in transparent methacrylate with texture; brushed metal lighting unit.

Matériaux

Corps diffuseur en méthacrylate transparent tissé ; corps lumineux en métal brossé.

Materialien

Leuchtenkörper aus transparentem, strukturiertem Metacrylat; Beleuchtungseinheit aus gebürstetem Metall.

Materiales

Cuerpo de la lámpara-difusor en metacrilato transparente texturizado, cuerpo luminoso en metal cepillado.

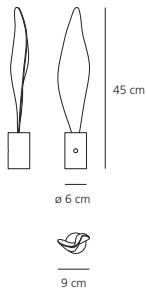

LED 3,5W, included





MODUL
ELECTRO
www.modulselectro.ru

Tizio Led

design
Richard Sapper
2008



Materiali: policarbonato verniciato.
Specificità: testa e bracci orientabili bilanciati da contrappesi.

Light emission



Colour



Black

Materials

Painted polycarbonate.

Specification

Adjustable counterbalanced arms and head.

Matériaux

Polycarbonate peint.

Spécificité

Bras articulés et tête orientable, l'ensemble est équilibré par contrepoids.

Materialien

Lackiertes Polycarbonat.

Spezifikation

Ausrichtbare Arme und Leuchtenkopf mit Gegengewichten.

Materiales

Policarbonato pintado.

Especificaciones

Brazos y cabezal orientables, compensados mediante contrapesos.

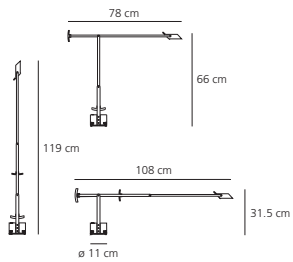

LED 8W, included
(illuminance: max 1250 lux, cm 40h)

IP20 + Dimmer

MODUL
ELECTRO
www.modulelectro.ru





MODUL
ELECTRO
www.modulelectro.ru

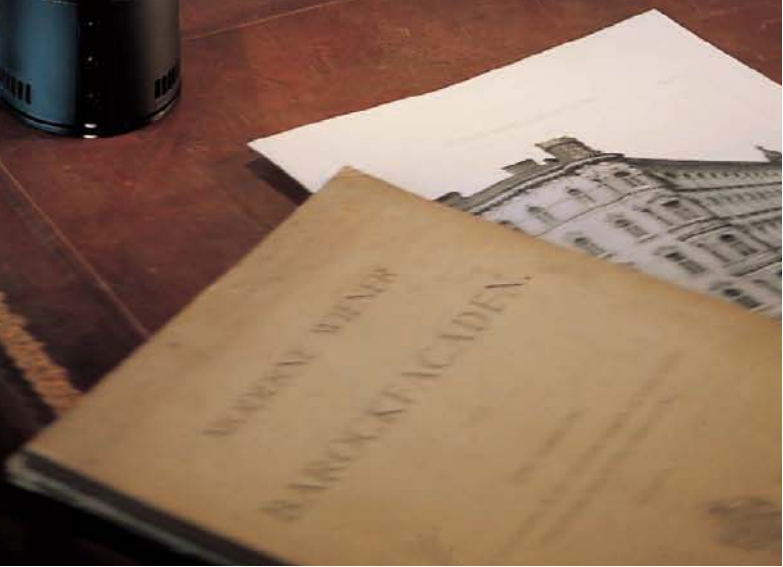

**Tizio, Tizio 35
Tizio plus
Tizio micro
Tizio X30**

design

Richard Sapper
1972, 1990, 1991
2002, 2008



Awards

- Tizio
- Compasso D'Oro / A.D.I. Segnalazione 1979 – Milano (Italia)
- Casamica – Per l'accessorio 1973 Milano (Italia)
- BIO 9 – Gold Medal 1981 – Ljubljana (Slovenia)
- Haus Industrieform Design Zentrum Nordrhein Westfalen 1980 – Essen (Deutschland)

Museum

- Tizio
- Twentieth Century Design Collection of the Metropolitan Museum of Art New York (USA)
- Design Collection of the Museum of Modern Art – New York (USA)
- Itinerario Storico Permanente Museo Nazionale della Scienza e della Tecnica Leonardo da Vinci Milano (Italia)
- Sezione Design Civica Galleria d'Arte Moderna Gallarate (Italia)
- Collection "Design since 1945" Philadelphia Museum of Art Philadelphia (USA)
- Museum Rufino Tamayo Mexico City (Mexico)
- Victoria and Albert Museum London (United Kingdom)
- The Denver Art Museum Denver Colorado (USA)
- The Israel Museum Jerusalem (Israel)
- Musée des Arts Décoratifs Montréal (Canada)
- Museo Permanente del Design Italiano 1945-1990 – Triennale di Milano Milano (Italia)
- Brooklyn Museum of Art New York (USA)

Materiali: policarbonato verniciato; versione Tizio bianca in metallo verniciato.
Specificità: testa e bracci orientabili bilanciati da contrappesi. Nella versione Plus la testa è orientabile anche in senso trasversale.

Tizio X30: in edizione limitata annuale e firmata da Richard Sapper, è prodotta in serie numerata, con base e testina in alluminio lucidato e astine in alluminio brillante anodizzato.

Materials

Painted polycarbonate; Tizio white in painted metal.

Matériaux

Polycarbonate peint ; Tizio blanc en métal verni.

Materialien

Lackiertes Polycarbonat; Tizio Weiß aus lackiertem Metall.

Materiales

Polycarbonato pintado; Tizio blanca de metal pintado.

Specification

Adjustable counterbalanced arms and head.
Plus version with tilting head.

Spécificité

Bras articulés et tête orientable, l'ensemble est équilibré par contrepoids. Dans la version Plus, la tête est orientable dans le sens transversal.

Spezifikation

Ausrichtbare Arme und Leuchtenkopf mit Gegengewichten. Ausführung Plus mit neigbarem Leuchtenkopf.

Especificaciones

Brazos y cabezal orientables, compensados mediante contrapesos. En el modelo Plus con cabezal, orientable incluso en sentido transversal.

Tizio X30: is produced in numbered edition, with base and head in polished aluminium and rods in shiny anodised aluminium.

La **Tizio X30** est produite en série numérotée, avec base et tête en aluminium poli et bras en aluminium anodisé brillant.

Tizio X30: In nummerierter Edition, mit Sockel aus druckgegossenem, hochglanzpoliertem Aluminium; Stangen aus eloxiertem Aluminium.

Tizio X30: en serie anual limitada y firmada por Richard Sapper, está producida en serie numerada, con pie y cabezal de aluminio presofuso brillante y varillas de aluminio brillante anodizado.

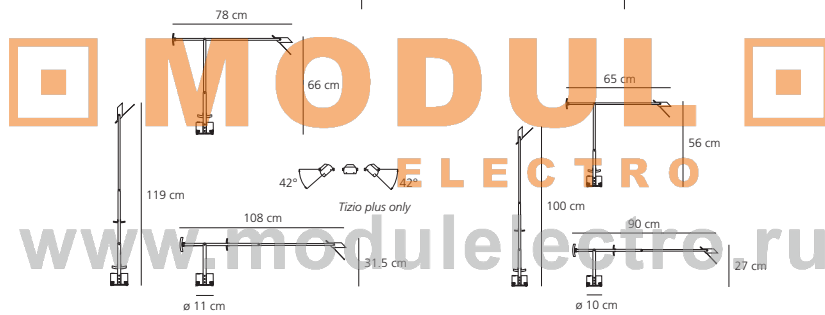

Tizio, Tizio X30

HALO max 1x50W/12V (GY 6,35) - QT 12, included. With two light levels.



Tizio 35

HALO max 1x35W/12V (GY 6,35) - QT 12, included. With two light levels.



Tizio micro

HALO max 1x20W/12V (G4) - QT 9, included



Tizio plus

HALO max 1x50W/12V (GY 6,35) - QT 12, included



Light emission



Colours

Tizio, Tizio 35

- Black
- Silver grey
- White

Tizio plus

- Black

Tizio X30

- Mirror

Tizio micro

- Black
- Silver grey
- White
- Mirror





MODUL
ELECTRO

www.modulelectro.ru

Tolomeo
Tolomeo mini
Tolomeo Led
Tolomeo mini Led
Tolomeo Led MWL
Tolomeo mini Led MWL

design

Michele De Lucchi
 Giancarlo Fassina
 1987, 1991, 2005, 2006

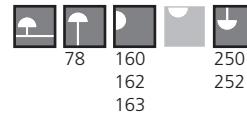

Awards

Tolomeo tavolo
 Compasso d'Oro / A.D.I.
 1989 – Milano (Italia)
 SNAI Oscar des Architectes d'Intérieur
 1987 – Paris (France)
 Haus Industrieform
 1987 – Deutschland
 Tolomeo fluo
 Designpreis
 2008 – Deutschland

Museum

Tolomeo tavolo
 Itinerario Storico Permanente
 Museo Nazionale della Scienza
 e della Tecnica Leonardo da Vinci
 Milano (Italia)
 Sezione Design
 Civica Galleria d'Arte Moderna
 Gallarate (Italia)
 The Israel Museum – Jerusalem (Israel)
 Musée des Arts Décoratifs de Montréal
 Montréal (Canada)
 Museo Permanente del Design Italiano
 1945/1990 – Triennale di Milano
 Milano (Italia)
 Galleria d'Arte Moderna – Roma (Italia)

Materiali: base e struttura a bracci mobili in alluminio lucidato; diffusore in alluminio anodizzato opaco o alluminio brillantato; snodi e supporti in alluminio brillantato.

Specificità: supporto intercambiabile: base, morsetto o perno fisso. Sistema di equilibratura a molle.

Materials

Base and cantilevered arms in polished aluminium; diffuser in matt anodised or polished aluminium; joints and supports in polished aluminium.

Matériaux

Base et structure à bras articulés en aluminium poli ; diffuseur en aluminium anodisé ou brillant, articulations et supports en aluminium brillant.

Materialien

Sockel und ausrichtbare Arme aus glänzendem Aluminium; Kopf aus matt-eloxiert- oder poliertem Aluminium; Gelenke und Halterungen aus poliertem Aluminium.

Materiales

Base y estructura con brazos móviles de aluminio pulido; difusor en aluminio anodizado opaco o brillante; articulaciones y soportes de aluminio brillante.

Specification

Interchangeable support: table base, clamp or desk fixed support. System of spring balancing.

Spécificité

Le corps de la lampe peut être associé à une base, à un étau ou à un pivot. Système d'équilibrage à ressorts.

Spezifikation

Auswechselbare Halterungen: Tischfuß, Klemme oder Schraubbefestigung. Mit Federausgleichsystem.

Especificaciones

Soporte intercambiable: base de sobremesa, mordaza o perno fijo para escritorio. Sistema de equilibrado a muelles y mando a distancia (toma accionada).

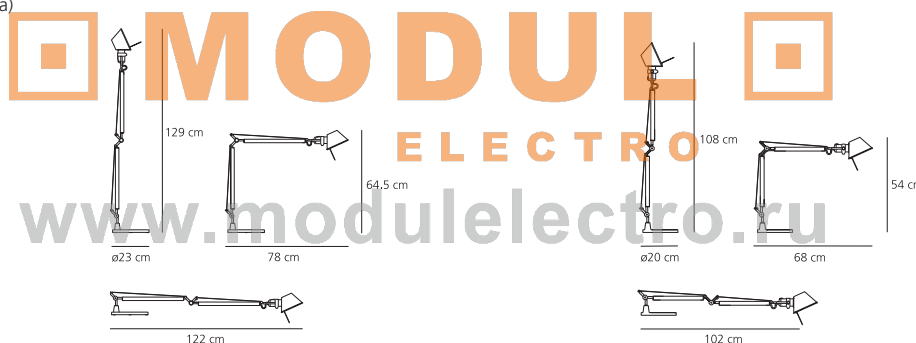

Light emission



Colours

Tolomeo

- Metal grey
- Black
- Mirror
- White (halo version only)

Tolomeo Mini

- Metal grey
- Black

Tolomeo Led

- Metal grey
- Black

Tolomeo mini Led

- Metal grey

Tolomeo Led MWL

- Metal grey

Tolomeo
Tolomeo Led
Tolomeo Led MWL

Tolomeo mini
Tolomeo mini Led



Mirror finishing



 **MODUL** 
ELECTRO

www.modulelectro.ru



HALOGEN

Tolomeo halo

HALO max 1x70W (E27) - ES, included



Tolomeo Mini halo

HALO max 1x70W (E27) - ES, included



Con l'utilizzo di questa sorgente, si ottiene un abbattimento del 30% del consumo energetico rispetto ad una sorgente tradizionale equivalente, con una conseguente sostanziale riduzione di emissione di CO₂.

By using this light source, we obtain a 30% reduction in energy consumption compared with an equivalent traditional light source, with a consequent substantial reduction of CO₂ emissions.

Grâce à l'emploi de cette source, on obtient une diminution de 30% de la consommation d'énergie par rapport à une source traditionnelle équivalente, avec, en conséquence, une réduction substantielle de l'émission de CO₂.

Durch den Einsatz dieser Lichtquelle kann der Energieverbrauch gegenüber konventionellen Leuchten um 30% gesenkt werden, wodurch eine deutliche Reduzierung des CO₂-Ausstoßes erzielt wird.

Utilizando esta fuente se obtiene una reducción del 30% del consumo energético respecto a una fuente tradicional equivalente, con la consiguiente e importante reducción de emisión de CO₂.

FLUORESCENT

Tolomeo fluo

FLUO 1x18W (G 24 q-2) - TC-DEL
Electronic ballast, darklight louvre included



Tolomeo Mini fluo

FLUO 1x18W (G 24 q-2) - TC-DEL
Electronic ballast, darklight louvre included



Con l'utilizzo di questa sorgente, si ottiene un abbattimento dell'80% del consumo energetico rispetto ad una sorgente tradizionale equivalente, con una durata fino a 15 volte superiore. L'efficienza luminosa passa da 12 lm/W di una lampadina incandescente da 100W a 67 lm/W con una fluorescente da 18W.

By using this light source, we obtain an 80% reduction in energy consumption compared with an equivalent traditional light source, with a duration up to 15 times longer. Light efficiency increases from 12 lm/W for a 100W incandescent light bulb to 67 lm/W with an 18W fluorescent.

Avec l'emploi de cette source, on obtient une diminution de 80% de la consommation d'énergie par rapport à une source traditionnelle équivalente, avec une durée pouvant être de 15 fois supérieure. L'efficacité lumineuse passe de 12 lm/W d'une ampoule à incandescence de 100W à 67 lm/W avec une fluorescente de 18W.

Durch die Bestückung mit einer Leuchtstofflampe wird der Energieverbrauch um 80% gegenüber dem Einsatz eines konventionellen Leuchtmittel bei gleicher Leistung reduziert; gleichzeitig erhöht sich die Lebensdauer der Leuchte um das 15-fache. Die Lichtausbeute dagegen kann von 12 lm/W einer 100W-Glühlampe bei Einsatz einer 18W-Leuchtstofflampe auf 67 lm/W erhöht werden.

Utilizando esta fuente se obtiene una reducción del 80% del consumo energético respecto a una fuente tradicional equivalente, con una duración de hasta 15 veces superior. La eficiencia luminosa pasa de 12 lm/W de una bombilla incandescente de 100W a 67 lm/W con una fluorescente de 18W.

LED

Tolomeo Led

LED 10W, included
(illuminance: max 1250 lux, cm 40h)



Tolomeo Mini Led

LED 10W, included
(illuminance: max 1250 lux, cm 40h)



Utilizzando la tecnologia Led l'attenzione va posta non solo al consumo di energia e all'efficienza luminosa, ma soprattutto alla qualità e quantità della distribuzione della luce. Infatti il vantaggio del Led è che emette il 100% di flusso luminoso nell'emisfero diretto, annullando dispersioni e sprechi in altre direzioni. Questo significa che per ottenere sul piano di lavoro un illuminamento di 1250lux, con una sorgente incandescente è necessaria una potenza di 100W, mentre con una sorgente Led sono sufficienti 10W, con un risparmio del 90% di energia elettrica.

Using Led technology, the attention must be focused not only on energy consumption and light efficiency, but above all on the quality and quantity of the distribution of the light. In fact the advantage of the Led is that it emits 100% light flow into the direct hemisphere, eliminating dispersion and waste in other directions. This means that in order to obtain illuminance of 1250 lux on the work surface, with an incandescent light source a power of 100W is necessary, while with a Led source 10W is sufficient, with a 90% energy saving.

En utilisant la technologie Led, on prête l'attention non seulement à la consommation d'énergie et à l'efficacité lumineuse, mais aussi et surtout à la qualité et la quantité de la distribution de la lumière. En effet, l'avantage de la Led est qu'elle émet 100% du flux lumineux d'hémisphère direct, en annulant ainsi les dispersions et les gâchis dans les autres directions. Cela signifie que, pour obtenir sur le plan de travail, un éclairage de 1250 lux, avec une source à incandescence, il est nécessaire d'avoir une puissance de 100W, tandis que 10W suffisent avec une source Led, soit 90% d'économie d'énergie électrique.

LED zeichnen sich durch einen stark reduzierten Energieverbrauch, eine lange Lebensdauer und eine optimale Lichtausbeute aus. Bei Led-Leuchten wird das Licht zu 100% direkt in die Umgebung abgegeben, so daß Energievergeudung und Lichtemission in andere Richtungen ausgeschlossen werden können. So ist beispielsweise zur Ausleuchtung einer Arbeitsfläche mit 1.250 Lux bei Einsatz einer Glühlampe eine Leistung von 100W erforderlich, wo hingegen eine LED-Leuchte lediglich 10W benötigt. Hierdurch wird eine Energieeinsparung von 90% erzielt.

Utilizando la tecnología Led la atención se centra no sólo en el consumo de energía y en la eficiencia luminosa, sino sobre todo en la calidad y cantidad de la distribución de la luz. En efecto la ventaja del Led es que emite el 100% de flujo luminoso en el hemisferio directo, anulando dispersiones y despilfarros en otras direcciones. Esto significa que para obtener en el plano de trabajo una iluminación de 1250lux, con una fuente incandescente se necesita una potencia de 100W, mientras con una fuente Led bastan 10W, con un ahorro del 90% de la energía eléctrica.

LED MWL

MY WHITE LIGHT

Tolomeo Led MWL

LED 15W, (4 amber + 4 white + 2 blue), included
(illuminance: max 1250 lux, cm 40h)



Tolomeo Mini Led MWL

LED 15W, (4 amber + 4 white + 2 blue), included
(illuminance: max 1250 lux, cm 40h)



Tolomeo My White Light coniuga i vantaggi della tecnologia Led e quelli della tecnologia My White Light, consentendo di ottenere numerose declinazioni della luce bianca, nelle sue diverse intensità e varietà di temperature di colore, con un'escursione da 3.200K (luce calda) a 10.000K (luce fredda).

Tolomeo My White Light combines the advantages of LED technology with those of My White Light technology, enabling numerous variations of white light to be obtained, with different intensities and varieties of colour temperature, with a range from 3,200K (warm light) to 10,000K (cold light).

Tolomeo My White Light allie les avantages de la technologie Led à ceux de la technologie My White Light, ce qui permet d'obtenir de nombreuses déclinaisons de lumière blanche, dans les différentes intensités et variétés de températures de couleur, avec une amplitude allant de 3.200K (lumière chaude) à 10.000K (lumière froide).

Tolomeo My White Light verbindet die Vorteile der LED-Technologie mit denen des "My White Light"-Systems, das eine ausgesprochen breite Palette der Abgabe von Weißlicht in verschiedenen Lichtstärken und Farbtemperaturen ermöglicht; die Farbtemperatur beträgt 3.200K bei Warmlicht bzw. 10.000K bei Kaltlicht.

Tolomeo My White Light coniuga las ventajas de la tecnología Led con las de la tecnología My White Light, y permite obtener numerosas gamas de luz blanca, en sus diversas intensidades y variedades de temperatura de color, con una variación de 3.200K (luz cálida) a 10.000K (luz fría).

Tolomeo Halo

Tolomeo Fluo

MODULO
ELECTRO

www.modulelectro.ru

Tolomeo LED MWL



Tolomeo micro

design

Michele De Lucchi
Giancarlo Fassina
1999



Awards

Observateur du design
Produit sélectionné – A.P.C.I.
2001 – Paris (France)

Light emission



Colours



Materiali: base e struttura a bracci mobili in alluminio lucidato; diffusore in alluminio anodizzato opaco o alluminio brillantato; snodi e supporti in alluminio brillantato.

Specificità: supporto intercambiabile: base, morsetto o perno fisso. Sistema di equilibratura a molle.

Materials

Base and cantilevered arms in polished aluminium; diffuser in matt anodised or polished aluminium; joints and supports in polished aluminium.

Specification

Interchangeable support: table base, clamp or desk fixed support. System of spring balancing.

Matériaux

Base et structure à bras articulés en aluminium poli ; diffuseur en aluminium anodisé ou brillant, articulations et supports en aluminium brillant.

Spécificité

Le corps de la lampe peut être associé à une base, à un étau ou à un pivot. Système d'équilibrage à ressorts.

Materialien

Sockel und ausrichtbare Arme aus glänzendem Aluminium; Kopf aus matt-eloxiert- oder poliertem Aluminium; Gelenke und Halterungen aus poliertem Aluminium.

Spezifikation

Auswechselbare Halterungen: Tischfuß, Klemme oder Schraubbefestigung. Mit Federausgleichsystem.

Materiales

Base y estructura con brazos móviles de aluminio pulido; difusor en aluminio anodizado opaco o brillante; articulaciones y soportes de aluminio brillante.

Especificaciones

Soporte intercambiable: base de sobremesa, mordaza o perno fijo para escritorio. Sistema de equilibrado a muelles y mando a distancia (toma accionada).

MODUL

ELECTRO

www.modulelectro.ru

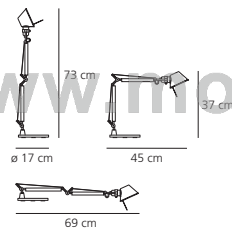

HALO max 1x60W (E 14) – QT-26



Table base



Clamp



Desk fixed support





MODUL
ELECTRO
www.modul-electro.ru

Tolomeo basculante tavolo

design

Michele De Lucchi
Giancarlo Fassina
2004

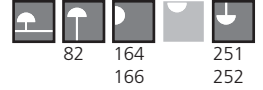

Materiali: base e struttura a bracci mobili in alluminio lucidato; diffusore in carta pergamena o in raso di seta supportato da materiale plastico; snodi in alluminio brillantato.

Specificità: supporto intercambiabile: base, morsetto o perno fisso. Il diffusore nel normale utilizzo, si dispone verticalmente, indipendentemente dall'angolazione del braccio. Sistema di equilibratura a molle.

Light emission



Colours



Base and arms:
mirror



Diffuser:
natural



Diffuser:
grey

Materials

Base and cantilevered arms in polished aluminium; diffuser in parchment paper or in silk satin fabric on a plastic frame; joints in polished aluminium.

Matériaux

Base et structure à bras articulés en aluminium poli; diffuseur en papier parchemin ou en polycarbonate recouvert de satin de soie; articulations en aluminium brillant.

Materialien

Sockel und ausrichtbare Arme aus glänzendem Aluminium; Schirm aus mit Kunststoff stabilisiertem Pergamentpapier oder Seidensatin; Gelenke aus poliertem Aluminium.

Materiales

Base y estructura con brazos móviles de aluminio pulido; difusor en pergamino o en raso seda reforzado con plástico; articulaciones de aluminio pulido.

Specification

Interchangeable support: table base, clamp or desk fixed support. The diffuser normally used, remains vertical regardless of the angle of the arm. System of spring balancing.

Spécificité

Le corps de la lampe peut être associé à une base, à un étau ou à un pivot. Le diffuseur dans le cadre d'une utilisation normale, se place verticalement, indépendamment de la position du bras. Système d'équilibrage à ressorts.

Spezifikation

Auswechselbare Halterungen: Tischfuß, Klemme oder Schraubbefestigung. Der Schirm steht bei normalem Gebrauch vertikal, unabhängig von der Ausrichtung des Armes. Federausgleichsystem.

Especificaciones

Soporte intercambiable: base de sobremesa, mordaza o perno fijo para escritorio. En su uso normal, el difusor se dispone verticalmente, independientemente de la inclinación del brazo. Sistema de equilibrado a muelles.

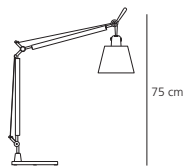
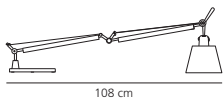
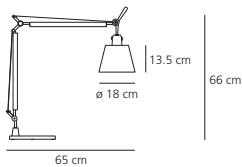

HALO max 1x70W (E 27) - ES



MODUL
ELECTRO
www.modulelectro.ru



Table base



Clamp



Desk fixed support



Tolomeo Mega morsetto

design

Michele De Lucchi
Giancarlo Fassina
2004



Materiali: struttura a bracci mobili in alluminio lucidato; diffusore in carta pergamena o in raso di seta supportato da materiale plastico; snodi e morsetto in alluminio brillantato.

Funzionalità: diffusore disponibile in tre dimensioni, orientabile in tutte le direzioni. Sistema di equilibratura a molle.

Light emission



Colours

-  Clamp and arms: mirror
-  Diffuser: natural
-  Diffuser: grey

Materials

Cantilevered arms in polished aluminium; diffuser in parchment paper or in silk satin fabric on a plastic frame; joints and clamp in polished aluminium.

Specification

Diffuser, available in three sizes, adjustable in all directions. System of spring balancing.

Matériaux

Structure à bras articulés en aluminium poli ; diffuseur en papier parchemin ou en polycarbonate recouvert de satin de soie ; articulations et étai en aluminium brillant.

Spécificité

Diffuseur disponible en trois tailles, orientable dans toutes les directions. Système d'équilibrage à ressorts.

Materialien

Ausrichtbare Arme aus glänzendem Aluminium; Schirm aus mit Kunststoff stabilisiertem Pergamentpapier oder Seidensatin; Gelenke und Klemme aus poliertem Aluminium.

Spezifikation

Der Leuchtenkopf, in drei Größen erhältlich, ist in alle Richtungen verstellbar. Federausgleichsystem.

Materiales

Estructura con brazos móviles de aluminio pulido; difusor en pergamino o en raso seda reforzado con plástico; articulaciones y mordaza de aluminio pulido.

Especificaciones

Difusor disponible en tres tamaños, orientable en todas direcciones. Sistema de equilibrio a muelles.

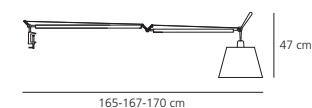
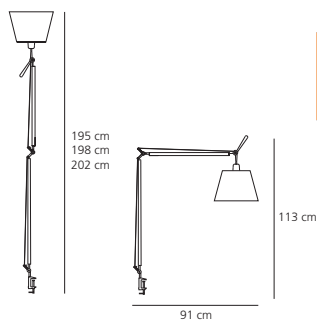
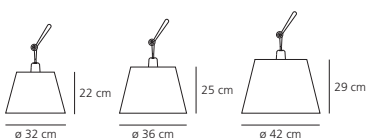

HALO max 1x150W (E 27) - ECO



MODUL
ELECTRO
www.modulelectro.ru

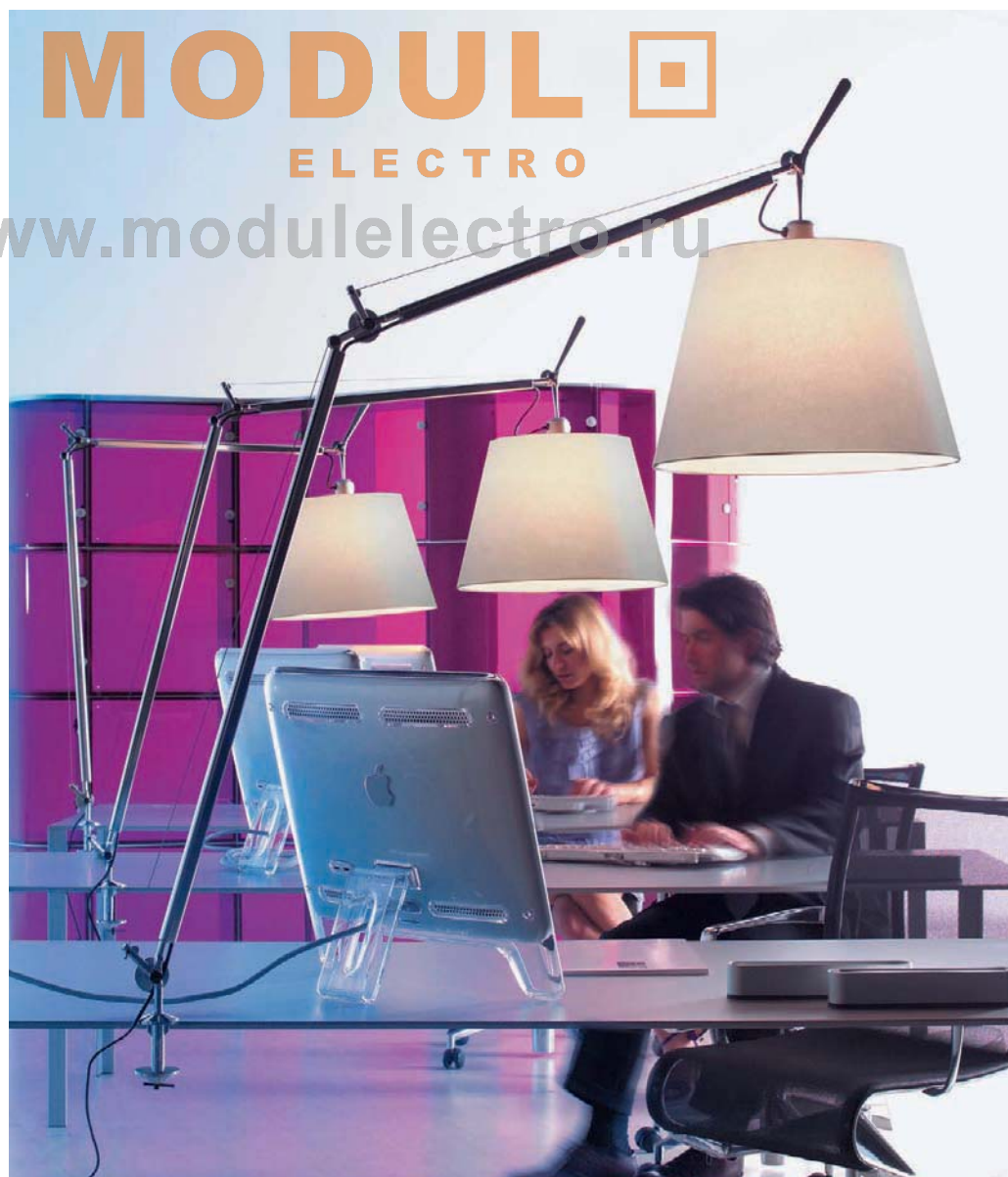

Clamp

Melampo tavolo Melampo notte

design

Adrien Gardère
2000, 2002



Awards

"Observateur du Design" Etoile 2001
A.P.C.I. – 2001 – Paris (France)
Reddot Design Award
2001 – Essen (Deutschland)

Materiali: base in zama verniciata; stelo in alluminio verniciato; diffusore in raso di seta, supportato da materiale plastico.

Specificità: diffusore orientabile in tre diverse posizioni nella versione tavolo e in due diverse posizioni nella versione notte.

Light emission



Colours

-  Base and stem: silver grey
-  Diffuser: grey
-  Base + stem: bronze
-  Diffuser: natural

Materials

Base in painted zamak; painted aluminium stem; diffuser in silk satin fabric on a plastic frame,

Specification

Adjustable diffuser into three different positions by the table version and into two positions by the night-table version.

Matériaux

Base en zamak peint ; tige en aluminium peint ; diffuseur en polycarbonate recouvert de satin de soie.

Spécificité

Diffuseur orientable dans trois positions différentes pour la version de table et dans deux positions différentes pour la version de chevet.

Materialien Sockel aus lackiertem Zamak; Stab aus lackiertem Aluminium; Schirm aus Seidensatin (stabilisiert mit Kunststoff).

Spezifikation

Schirm verstellbar in drei unterschiedliche Positionen bei der Tischleuchte und in zwei Positionen bei der Nachttischversion.

Materiales

Pie de zamak pintado; tija de aluminio pintado; difusor en raso seda reforzado con plástico.

Especificaciones

Difusor orientable en tres posiciones diferentes en la versión de sobremesa y en dos posiciones en el modelo noche.



MODUL
ELECTRO
www.modulelectro.ru

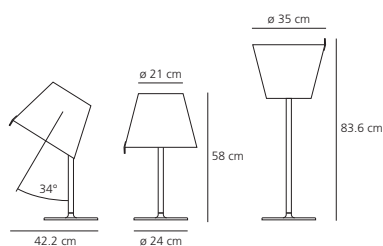

Melampo tavolo

HALO max 2x52W (E 27) – ES

IP20      

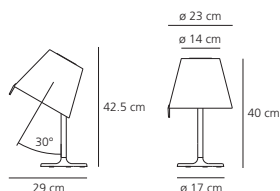

Melampo notte

INC max 1x60W (E 14) – D 45

IP20      



Melampo tavolo

Melampo notte



MODUL
ELECTRO

www.modulelectro.ru

Choose tavolo

design

Matteo Thun
2006



Materiale: base in zama; struttura in metallo verniciato grigio; diffusore orientabile in policarbonato accoppiato a un foglio di polipropilene serigrafato rosso o da carta pergamena.

Specificità: il diffusore si inclina di 30° e ruota di sul proprio asse di 350°.

Light emission



Colours

-  Base and stem: dark grey
-  Diffuser: transparent+red
-  Diffuser: transparent+natural

Materials

Base in zamak, grey painted metal structure, adjustable diffuser in transparent polycarbonate, joined with red silkscreened polypropylene sheet or with parchment paper.

Specification

The diffuser tilts 30° and rotates 350° on its axis.

Matériaux

Base en zamak ; structure en métal verni gris ; diffuseur orientable en polycarbonate couplé à une feuille de polypropylène sérigraphié rouge ou papier parchemin.

Spécificité

Le diffuseur s'incline de 30° et peut pivoter sur son axe à 350°.

Materialien

Leuchtenfuß aus Zamak; Struktur aus grau-lackiertem Metall; verstellbarer Schirm aus Polycarbonat mit rot bedrucktem Polypropylen oder Pergamentpapier zusammengestellt.

Spezifikation

Schirm: schwenkbar um 30°, drehbar um 355°.

Materiales

Pie de zamak; estructura de metal pintado gris; difusor orientable de policarbonato junto con tejido al polipropileno rojo serigrafado o con tela de pergamena.

Especificaciones

El difusor se inclina a 30° y gira sobre si mismo hasta 350°.



MODUL
ELECTRO
www.modulelectro.ru

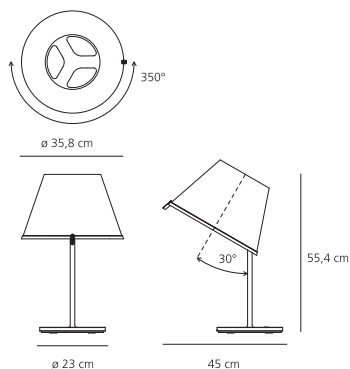

HALO max 1x52W (E 27) – ES

IP20 

FLUO 1x13W (G24 q-1) – TC-DEL
Electronic ballast

IP20 

Monroe

design

Ora Ito
2007



Materiali: base e struttura in acciaio verniciato; diffusore termoplastico accoppiato a un foglio texturizzato.

Specificità: grazie a due perni posti sulla base e in corrispondenza del diffusore, può ruotare di 360°, permettendo un ampio raggio di orientamento della luce sul piano di lavoro.

Light emission



Colours



Base and stem:
polished white



Diffuser:
white

Materials

Painted steel base and structure;
thermoplastic diffuser joined
with a textured sheet.

Specification

Due to two clips positioned
on the base near the diffuser,
this lamp can rotate 360°,
allowing a wide range of
orientation of light on the
work surface.

Matériaux

Base et structure en acier peint ;
diffuseur en thermoplastique
couplé à une feuille avec
texture.

Spécificité

Grâce aux deux pivots situés
sur la base et au niveau du
diffuseur, cette lampe peut
s'orienter à 360° et garantir
ainsi un ample rayon d'orien-
tation de la lumière sur le plan
de travail.

Materialien

Sockel und Rahmen aus
lackiertem Stahl; Schirm aus
Thermoplast mit Siebdruck-
blatt zusammengestellt.

Spezifikation

Tischleuchte mit zwei Achsen
am Sockel und in Höhe
des Lichtverteilers, die eine
Rotation um 360° und somit
eine gezielte Ausrichtung des
Lichtkegels auf die Tischplatte
bzw.
Arbeitsfläche ermöglichen.

Materiales

Pie y estructura, de acero
pintado, difusor de termo-
plástico junto con una ola
texturizada.

Especificaciones

Merced a dos pernos, ubica-
dos en el pie de la lámpara, a
la altura del difusor, la misma
puede girar a 360°. Ello
permite obtener un extenso
radio de acción, para orientar
el haz de luz contra la superficie
de trabajo.



MODUL
ELECTRO
www.modulelectro.ru

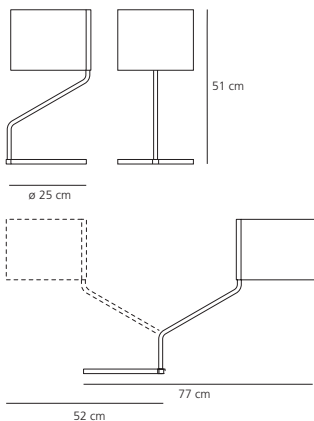

HALO max 1x150W (E 27) – ECO

IP20

FLUO 1x18W (GX 24 q-2) – TC-TEL
Electronic ballast

IP20



Nessino

design

Giancarlo Mattioli,
Gruppo Architetti Urbanisti Città
Nuova
re-edition 2003



Materiali: corpo e diffusore in policarbonato.

Light emission



Colours



Transparent red



Trasparent orange



Polished white

Materials

Body and diffuser in polycarbonate.

Matériaux

Corps et diffuseur en polycarbonate.

Materialien

Körper und Schirm aus Polycarbonat.

Materiales

Cuerpo y difusor de policarbonato.

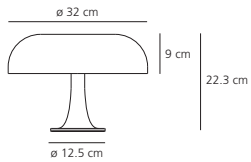

INC max 4x25W (E 14) – D 45



MODULO
ELECTRO



www.modulelectro.ru

Dalù

design

Vico Magistretti
re-edition 2005



Materiali: materiale termoplastico stampato.

Light emission



Colours



Trasparent red



Trasparent orange



Polished black



Polished white

Materials

Moulded thermoplastic material.

Matériaux

Matériau thermoplastique moulé.

Materialien

Leuchtenkörper aus thermoplastischem Material.

Materiales

Material termoplástico estampado.

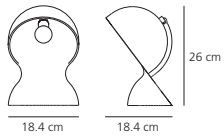

INC max 1x25W (E 14) – D 45 (for transparent finishing)
INC max 1x40W (E 14) – D 45 (for polished finishing)



MODULO 
ELECTRO



www.modulelectro.ru



Yang Yang touch

design
Carlotta de Bevilacqua
2000, 2003



Awards
Signed Design 5° Edizione
2000 – Milano (Italia)

Materiali: struttura in metacrilato e policarbonato trasparente, maniglia in alluminio (solo Yang touch).

Specificità: sei piedini permettono di regolare il posizionamento con diverse inclinazioni. Tre proiettori con i filtri dicroici rosso, verde e blu consentono di ottenere infinite atmosfere di luce colorata.

Yang: attraverso un telecomando è possibile gestire 10 atmosfere standard, crearne e memorizzarne ulteriori 10 e agire sull'intensità luminosa. Un display nella lampada visualizza l'atmosfera selezionata.

Yang touch: la regolazione delle atmosfere colorate e dell'intensità luminosa avviene singolarmente per ogni sorgente tramite tre tasti sul corpo della lampada. Una maniglia ne facilita lo spostamento.

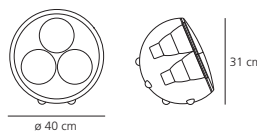
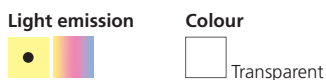

Yang
FLUO 3x42W (GX 24 q-4) – TC-TEL, included
Electronic ballast



Infrared remote control (included)

GOOD MORNING	RELAX	ENERGY
R 99% + G 99% = B 99% +	R 20% + G 50% = B 80% +	R 99% + G 40% = B 00% +
WORKING	IDEA	BALANCE
R 60% + G 50% = B 50% +	R 40% + G 60% = B 00% +	R 40% + G 60% = B 99% +
RELATION	PLAY	LOVE
R 40% + G 99% = B 50% +	R 99% + G 00% = B 99% +	R 99% + G 00% = B 00% +
DREAM		
R 00% + G 00% = B 99% +		



Materials
Methacrylate structure and transparent polycarbonate case; aluminium handle (Yang touch only).

Specification
Six small feet allow the lamp to be placed at different inclinations. Three projectors with dichroic filters red, green and blue allow to create a wide range of light coloured atmospheres.

Yang: it is possible, using a remote control, to manage 10 standard atmospheres, to create and memorise, other 10 and to adjust the light intensity. A display on the lamp shows the selected atmosphere.

Yang touch: the sources are individually switched to allow selection of colours and light intensity. An handle makes the lamp easy to move and therefore to use in various environments.

Matériaux
Structure en méthacrylate et polycarbonate transparent; poignée en aluminium (seulement Yang touch).

Spécificité
Six pieds permettent de placer la lampe dans différentes positions. Trois projecteurs avec filtres dichroïques rouge, vert et bleu permettent d'obtenir nombreuses atmosphères de lumière colorées.

Yang: à l'aide de la télécommande, il est possible de gérer 10 atmosphères standard, d'en créer et d'en mémoriser 10 autres et d'agir sur l'intensité lumineuse.

Yang touch: trois touches, situées sur le corps du luminaire, assurent les fonctions d'interrupteur et de gradateurs pour chacune des trois sources. Une poignée permet de déplacer facilement la lampe et de pouvoir l'utiliser dans diverses ambiances.

Materialien
Struktur aus Metakrylat und durchsichtigem Polycarbonat; Griff aus Aluminium (nur Yang touch).

Spezifikation
Die sechs Füße ermöglichen eine unterschiedliche Positionierung der Leuchte. Drei Strahler mit dichroitischen Filter, in den Grundfarben Rot, Blau und Grün erzeugen unzählige farbige Lichtstimmungen.

Yang: über eine Fernbedienung lassen sich 10 Standard-Lichtstimmungen abrufen sowie weitere 10 zur Einstellung der Lichtintensität. Ein Display visualisiert die ausgewählte Lichtstimmung.

Yang touch: Das Ein- und Ausschalten der Leuchte sowie die Steuerung der Lichtintensität erfolgt für jede Lichtquelle einzeln mittels dreier Tasten, die auf dem Leuchtenkörper angebracht sind. Ein Spezialgriff ermöglicht den einfachen Transport.

Materiales
Estructura en metacrilato y policarbonato transparente, manilla en aluminio (solo Yang touch).

Especificaciones
Seis piecitos permiten regular la posición con distintas inclinaciones. Tres proyectores con los filtros dicroicos rojo, verde y azul permiten obtener infinitas atmósferas de luz colorada.

Yang: mediante un mando a distancia es posible gestionar 10 atmósferas standard, crear y memorizar 10 más y gestionar la intensidad luminosa. Un display en la lámpara visualiza la atmósfera seleccionada.

Yang touch: la regulación de las atmósferas coloradas y de la intensidad luminosa se obtiene de forma singular para cada bombilla gracias a los tres botones situados en el cuerpo de la lámpara. Una manilla facilita el traslado.

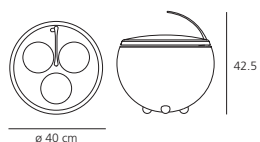
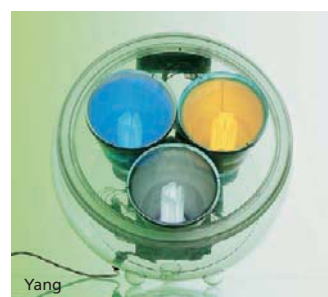

Yang touch
HALO max 3x100W (B 15d) – ECO, included
IP20 ENEC CE Dimmer



MODULO
ELECTRO
www.modulelectro.ru

Aqua Cil tavolo

design

Ross Lovegrove
2007



Materiali: base e struttura in alluminio pressofuso; stelo in acciaio; diffusore in alluminio stampato e trattato a specchio.

Light emission



Colours

- Base and stem: metal grey
- Diffuser: mirror
- Diffuser: metal orange
- Diffuser: metal blue

Materials

Die-cast aluminium base and structure; steel stem; moulded and mirror-treated aluminium diffuser.

Matériaux

Base et structure en aluminium moulé sous pression ; tige en acier ; diffuseur en aluminium moulé et traité façon miroir.

Materialien

Sockel und Struktur aus druckgegossenem Aluminium; Stab aus Stahl, Schirm aus Spritzguss und hochglanzpoliertem Aluminium.

Materiales

Pie y estructura en aluminio fundido a presión; tija en acero; difusor en aluminio moldeado por inyección con acabado pulido espejo.

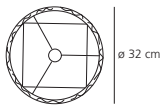
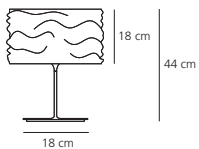

HALO max 1x150W (E27) - ECO

IP20 + Touch Dimmer

MODUL
ELECTRO
www.modulelectro.ru





MODUL
ELECTRO
www.modulelectro.ru

Nestore 90 tavolo

design

Carlo Forcolini
1989



77

Awards

Compasso d'Oro / A.D.I.
Segnalazione
1991 – Milano (Italia)

Materiali: base in lega di zinco e resina termoplastica; struttura in acciaio verniciato o nichelato opaco; testa in resina termoplastica.

Specificità: braccio bilanciato, regolabile sul piano verticale ed orizzontale, mediante contrappeso sferico.

Light emission



Colours



Black



Metal grey

Materials

Base in die-cast zinc alloy and thermoplastic resin; painted or matt nickel steel structure; thermoplastic resin head.

Matériaux

Base en alliage de zinc et résine thermoplastique ; structure en acier verni ou nickel mat ; tête en résine thermoplastique.

Materialien

Tischfuß aus Zinklegierung und thermoplastischem Kunstharz.; Gestell aus lackiertem oder mattvernickeltem Stahl; Leuchtenkopf aus Kunstharz.

Materiales

Pie de aleación de zinc y resina termoplástica; estructura de acero pintado o niquelado mate, cabezal de resina termoplástica.

Specification

Counter-balanced arm adjustable on both vertical and horizontal planes, by means of a spherical counterweight.

Spécificité

Bras équilibré réglable sur l'axe horizontal et vertical au moyen d'un contrepoids sphérique.

Spezifikation

Verstellbarer Arm, der auf der horizontalen und vertikalen Ebene durch ein kugelförmiges Gegengewicht regulierbar ist.

Especificaciones

Brazo compensado que se regula en sentido horizontal y vertical, por medio de un contrapeso esférico.

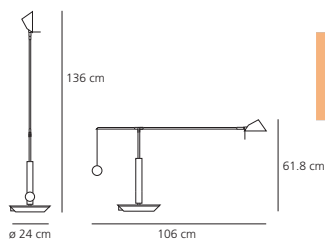

HALO max 1x50W/12V (GY 6,35) – QT 12, included with two light levels

IP20

MODUL
ELECTRO
www.modulelectro.ru



Shogun tavolo

design

Mario Botta
1986



Awards

Twentieth Century Design Collection
of the Metropolitan Museum of Art
New York (USA)

Materiali: stelo in metallo verniciato; diffusori orientabili in lamiera d'acciaio forata verniciata.

Light emission



Colours



Black/white

Materials

Painted metal stem; white
adjustable diffusers in painted
perforated plate steel.

Matériaux

Structure en métal verni ;
diffuseurs orientables en tôle
d'acier perforé verni.

Materialien

Säule aus lackiertem Metall,
verstellbare Schirme aus
gelochtem Stahlblech.

Materiales

Vástago de metal pintado;
difusores pintados orientables,
de chapa de acero perforada.

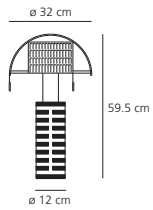

HALO max 1x150W (E 27) - ECO

IP20



Dioscuri tavolo 14
Dioscuri tavolo 25
Dioscuri tavolo 35
Dioscuri tavolo 42

design
 Michele De Lucchi
 2000, 2003



Materiali: base in resina termoplastica; diffusore in vetro soffiato acidato.

Light emission



Colour



White

Materials

Base in thermoplastic resin,
 acid-etched blown glass
 diffuser.

Matériaux

Base en résine thermoplasti-
 que, diffuseur en verre soufflé
 traité à l'acide.

Materialien

Sockel aus thermoplastischem
 Harz, Kugel aus mundgebla-
 senem geätztem Glas.

Materiales

Base de resina termoplástica,
 difusor de vidrio soplado
 al ácido.



Dioscuri tavolo 14
 HALO max 1x60W (G 9) – ES, included

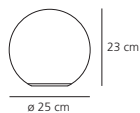

Dioscuri tavolo 25
 HALO max 1x150W (E 27) – ECO

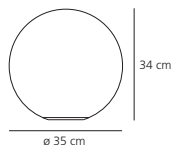

Dioscuri tavolo 35
 HALO max 1x150W (E 27) – ECO

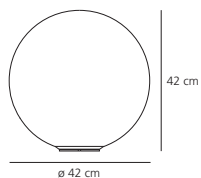

Dioscuri tavolo 42
 HALO max 1x205W (E 27) – ECO

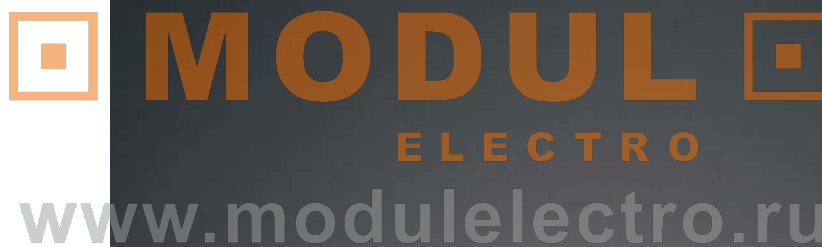

Dioscuri tavolo 25

Dioscuri tavolo 42

Dioscuri tavolo 14

Dioscuri tavolo 35

MODUL
ELECTRO
www.modulelectro.ru



Castore tavolo 14
Castore tavolo 25
Castore tavolo 35
Castore tavolo 42

design
 Michele De Lucchi
 Huub Ubbens
 2003



Awards

Design Plus, light + building
 2004 – Frankfurt am Main (Deutschland)
 Reddot Design Award
 2004 – Essen (Deutschland)
 Compasso d'oro / A.D.I. – Segnalazione
 2004 – Milano (Italia)

Light emission



Colour



White

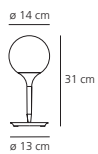

Castore tavolo 14

HALO max 1x60W (G 9) – ES, included

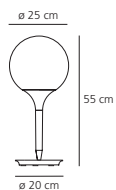

Castore tavolo 25

HALO max 1x100W (E 27) – ECO

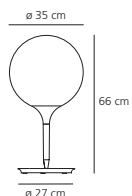

Castore tavolo 35

HALO max 1x150W (E 27) – ECO

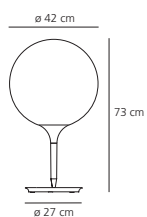

Castore tavolo 42

HALO max 1x205W (E 27) – ECO



Touch dimmer
 for Castore tavolo 25,
 Castore tavolo 35,
 Castore tavolo 42

Functions:
 1) memo
 2) reset

Materiali: base in zama; stelo in resina termoplastica; diffusore in vetro soffiato.
Specificità: un tasto d'accensione touch, presente sulla base di Castore 25, 35 e 42, permette la regolazione dell'intensità luminosa, la memorizzazione dell'ultimo livello di luce impostato e la possibilità di scegliere tra comando locale e comando remoto (presa comandata).

Materials

Base in zamac, stem in thermoplastic resin, blown glass diffuser.

Specification

Castore 25, 35 and 42 have a touch dimmer button on the lamp base for the storage of the last light intensity set-up or the use of a local or remote control (controlled socket).

Matériaux

Base en zamac, tige en résine thermoplastique, diffuseur en verre soufflé.

Spécificité

Castore 25, 35 et 42 sont dotées d'un variateur sensitif situé sur la base, pour la mémorisation du dernier niveau d'intensité lumineuse établi et la possibilité de choisir entre la commande déportée (interrupteur) ou directement sur le luminaire.

Materialien

Fuß aus Zamak, Stab aus thermoplastischem Harz, Schirm aus mundgeblasenem Glas.

Spezifikation

Ein Touch-Dimmer am Fuß der Tischleuchte Castore 25, 35 und 42 ermöglicht die Regelung und die Speicherung der Lichtintensität und bietet außerdem die Möglichkeit, zwischen Hand- und Fernbedienung zu wählen (Steckdosenschalter).

Materiales

Base en zamac, tija en resina termoplástica, difusor en cristal soplado.

Especificaciones

Una tecla que enciende por contacto y que se encuentra en la base de Castore 25, 35 y 42, permite la regulación de la intensidad luminosa y la memorización del último nivel de intensidad configurado y la posibilidad de elegir entre mando exclusivamente local y mando a distancia (toma accionada).

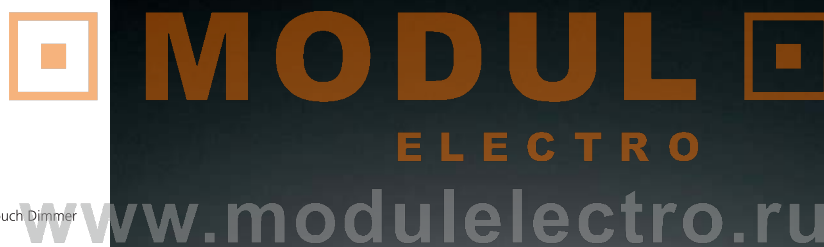

Castore tavolo 42

Castore tavolo 25

Castore tavolo 14

Castore tavolo 35

Castore calice tavolo

design

Michele De Lucchi
Huub Ubbens
2004



267

Materiali: base in zama; stelo in resina termoplastica; diffusore in vetro soffiato.

Light emission



Colour



White

Materials

Base in zamac, stem in thermoplastic resin, blown glass diffuser.

Matériaux

Base en zamac, tige en résine thermoplastique, diffuseur en verre soufflé.

Materialien

Fuß aus Zamak, Stab aus thermoplastischem Harz, Schirm aus mundgeblasenem Glas.

Materiales

Base en zamac, tija en resina termoplástica, difusor en cristal soplado.

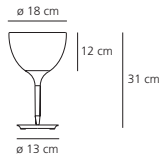

HALO max 1x60W (G 9) – ES, included



MODUL
ELECTRO
www.modulelectro.ru



Soffione tavolo 36
Soffione tavolo 45

design
Michele De Lucchi
Alberto Nason
2008



Materiali: base in resina termoplastica, diffusore in vetro soffiato opalino.

Light emission



Colour



White

Materials

Base in thermoplastic resin,
opaline blown glass diffuser.

Matériaux

Base en résine thermo-
plastique, diffuseur en verre
soufflé opalin.

Materialien

Sockel aus thermoplastischem
Harz, Schirm aus geblasenem
Opalglas.

Materiales

Base de resina termoplástica,
difusor de cristal soplado
opalino.

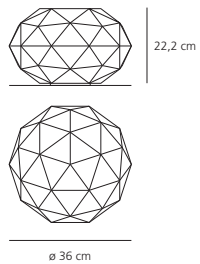

Soffione tavolo 36

HALO max 1x150W (E 27) - ECO

IP20 □ F + - Dimmer

FLUO 1x26/32W (GX 24 q-3) - TC-DEL

Electronic ballast

IP20 □ F

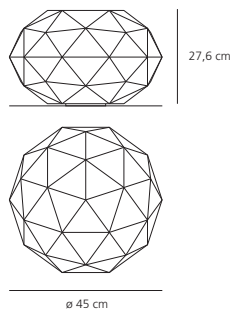

Soffione tavolo 45

HALO max 1x205W (E 27) - ECO

IP20 □ F + - Dimmer

FLUO 1x42W (GX 24 q-4) - TC-DEL

Electronic ballast

IP20 □ F

MODUL
ELECTRO
www.modulelectro.ru



Soffione tavolo 36

Soffione tavolo 45

Soffione stelo tavolo 36
Soffione stelo tavolo 45

design
 Michele De Lucchi
 Alberto Nason
 2008





Materiali: base in alluminio pressofuso, stelo in acciaio, diffusore in vetro soffiato opalino.

Light emission



Colours

-  Base and stem: polished black
-  Base and stem: mirror
-  Diffuser: white

Materials

Base in die-cast aluminium, steel stem, opaline blown glass diffuser.

Matériaux

Base en aluminium moulé sous pression, tige en acier, diffuseur en verre soufflé opalin.

Materialien

Sockel aus Aluminiumdruckguss; Stab aus Stahl; Schirm aus geblasenem Opalglas.

Materiales

Pie en aluminio fundido a presión; tija en acero, difusor de cristal soplado opalino.

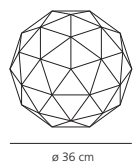
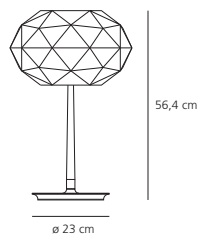

Soffione stelo tavolo 36:

HALO max 1x150W (E 27) - ECO

IP20     +  Touch Dimmer

FLUO 1x26/32W (GX 24 q-3) - TC-DEL

Electronic ballast

IP20    

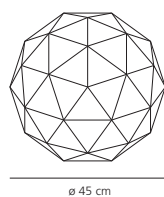
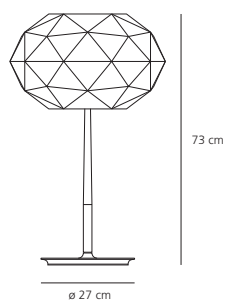

Soffione stelo tavolo 45:

HALO max 1x205W (E 27) - ECO

IP20     +  Touch Dimmer

FLUO 1x42W (GX 24 q-4) - TC-DEL

Electronic ballast

IP20    

MODUL
ELECTRO
www.modulelectro.ru



Soffione stelo tavolo 36

Soffione stelo tavolo 45

Logico tavolo
Logico tavolo mini
Logico tavolo micro

design
 Michele De Lucchi
 Gerhard Reichert
 2001, 2002, 2003

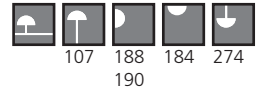

Awards

Logico tavolo
 Design Innovationen Design Zentrum
 Nordrhein Westfalen
 Reddot Design Award
 2004 – Essen (Deutschland)

Materiali: struttura in metallo verniciato; diffusore in vetro soffiato con finitura seta lucida.

Specificità: un tasto d'accensione touch, presente su Logico tavolo e Logico tavolo mini, permette la regolazione dell'intensità luminosa.

Light emission



Colours

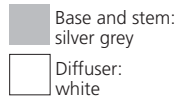

Materials

Painted metal structure, blown glass diffuser with polished-silk finish.

Specification

Logico tavolo and Logico tavolo mini have a touch dimmer to adjust the light intensity.

Matériaux

Structure en métal verni ; diffuseur en verre soufflé, finition soie brillante.

Spécificité

Logico tavolo et Logico tavolo mini sont dotées d'un variateur sensible, pour agir sur l'intensité lumineuse

Materialien

Rahmen aus lackiertem Metall; Schirm aus geblasenem Glas in seidig glänzendem Finish.

Spezifikation

Die Versionen Logico tavolo und Logico tavolo mini sind mit einem Touch-Dimmer ausgestattet.

Materiales

Estructura de metal pintado; difusor de cristal soplado con acabado de seda brillante.

Especificaciones

Una tecla que enciende por contacto y que se encuentra en Logico tavolo y Logico tavolo mini permite la regulación de la intensidad luminosa

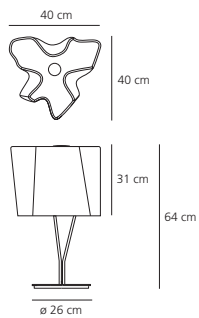

Logico tavolo

INC max 3x60W (E 27) – A 60

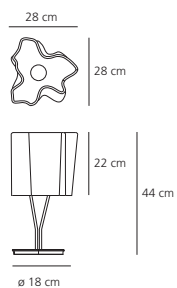

Logico tavolo mini

INC max 3x40W (E 14) – D 45

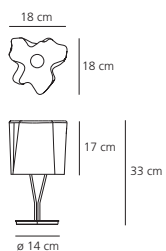

Logico tavolo micro

INC max 1x60W (E 14) – D 45



Touch dimmer



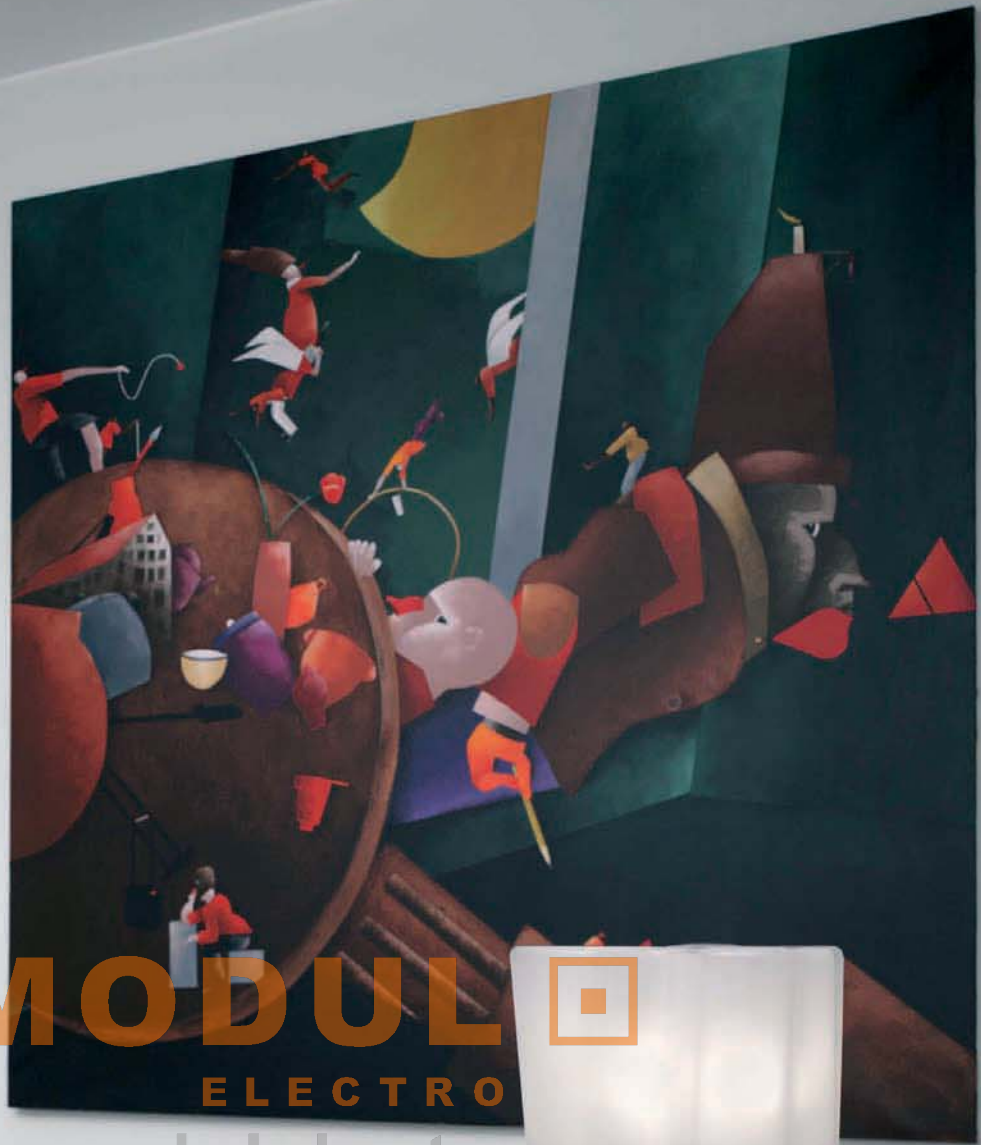

 **MODUL** 
ELECTRO

www.modulelectro.ru



Onfale tavolo grande
Onfale tavolo medio
Onfale tavolo piccolo

design
 Luciano Vistosi
 1978



Materiali: corpo e diffusore in vetro soffiato opalino; bordo del diffusore in cristallo trasparente riportato a caldo.

Light emission



Colour



White

Materials

Body and diffuser in opaline blown glass. Transparent crystal edge added.

Matériaux

Corps et diffuseur en verre soufflé opalin ; bord du diffuseur en cristal transparent appliqué à chaud.

Materialien

Leuchtenkörper aus mundgeblasenem Opalglas; Rand aus transparentem Kristallglas.

Materiales

Cuerpo y difusor, de cristal soplado opalino; borde del difusor de cristal transparente, aplicado en caliente.

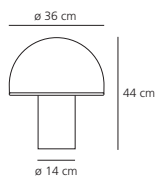

Onfale tavolo grande
 HALO max 1x70W (E 27) – ES
 INC max 1x40W (E 14) – D 45

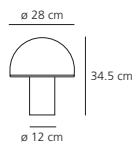

Onfale tavolo medio
 INC max 1x60W (E 14) – D 45
 INC max 1x25W (E 14) – D 45

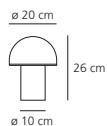

Onfale tavolo piccolo
 INC max 1x60W (E 14) – D 45



MODUL
ELECTRO
www.modulelectro.ru



Miconos tavolo

design

Ernesto Gismondi
1998



Awards

BIO 16 – Selection
1998 – Ljubljana (Slovenia)

Materiali: base e stelo in metallo cromato lucido; diffusore in vetro soffiato trasparente.

Light emission



Colours



Base and stem:
mirror



Diffuser:
trasparent

Materials

Base and stem in polished
chromed metal, diffuser in
transparent blown glass.

Matériaux

Base et tige en métal chromé
brillant, diffuseur en verre
soufflé transparent.

Materialien

Sockel und Stab aus polier-
tem und verchromtem Metall,
Schirm aus klarem, munde-
blasenem Glas.

Materiales

Base y vástago, de metal
cromado brillante; difusor en
cristal soplado transparente.

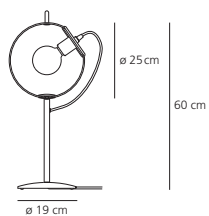

FLUO 1x20W (E 27) – globe ø 9cm





MODUL
ELECTRO
www.modulselectro.ru

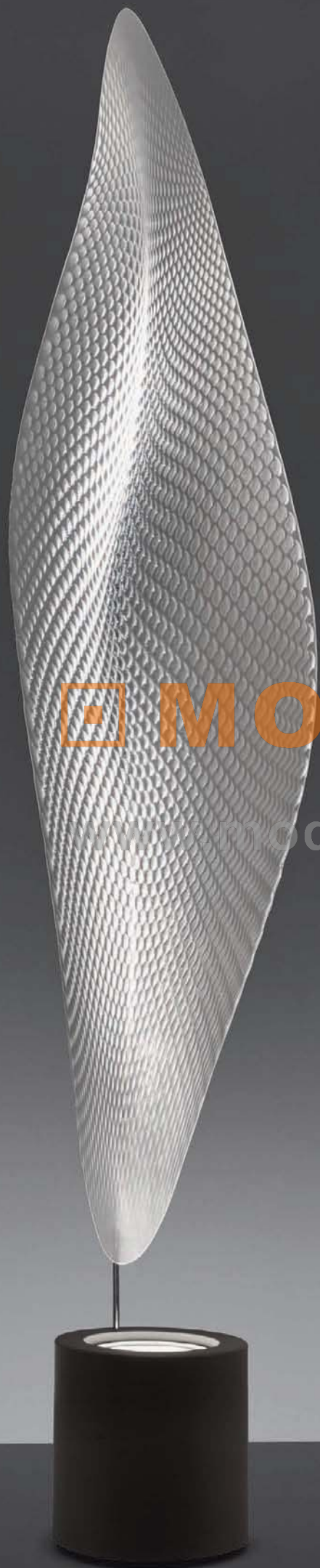

Lampade da terra

Floor lamps / Lampadaires / Stehleuchten / Lámparas de pie



 **MODUL** 
ELECTRO
www.modulelectro.ru



64
Ipogeo



66
Doride



68
Cadmo



70
Aqua Cil terra



72
Cabildo terra



73
Echos



74
Megaron terra



75
Callimaco



76
Tizio supporto terra



77
Nestore terra, lettura



78
Tolomeo terra, lettura, micro terra



80
Tolomeo XXL



82
Tolomeo basculante terra, lettura



84
Tolomeo Mega terra



86
Melampo terra, Mega terra



87
Choose terra, Mega terra



88
Genesy



90
Cosmic Leaf terra



92
Pipe terra



94
Talak lettura, lettura Led



95
Firefly lettura



96
Metacolor



97
Metacolor MWL



98
Rigel



100
Yin flu



102
Prometeo



103
Iride

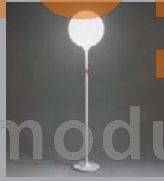

104
Castore terra 35, 42



106
Soffione terra



107
Logico terra



108
Miconos terra



109
Acquarelli



110
Acheo terra



111
Tebe terra



112
Montjuic



Zen terra

MODULO
ELECTRO
www.modulelectro.ru

Ipogeo

design

Joe Wentworth
2008



Awards

Reddot Design Award – Honorable Mention
2009 – Essen (Deutschland)

Materiali: base in ferro e alluminio; bracci orientabili in estruso di alluminio verniciato; snodi in alluminio pressofuso; contrappesi in ferro verniciato.
Specificità: lampada da terra totalmente orientabile nello spazio.

Light emission



Colours



Base and structure:
polished black



Counterweights:
polished red

Materials

Iron and aluminium base;
painted extruded aluminium
adjustable arms; die-cast
aluminium joints; painted iron
counterweights.

Matériaux

Base en fer et aluminium ;
bras orientables en aluminium
extrudé verni ; articulations en
aluminium moulé sous pression ;
contrepoids en fer verni.

Materialien

Sockel aus Eisen und Aluminium;
verstellbare Arme aus fließgepres-
stem und lackiertem Aluminium;
Gelenke aus Aluminiumdruck-
guss; Gegengewichte aus
lackiertem Eisen.

Materiales

Pie de hierro y aluminio;
brazos orientables de aluminio
extruido pintado; articulaciones
de aluminio fundido a
presión; contrapesos de hierro
pintado.

Specification

Floor lamp totally adjustable.

Spécificité

Lampadaire totalement orien-
table dans l'espace.

Spezifikation

Individuell verstellbare Steh-
leuchte.

Especificaciones

Lámpara de pie totalmente
orientable en el espacio.

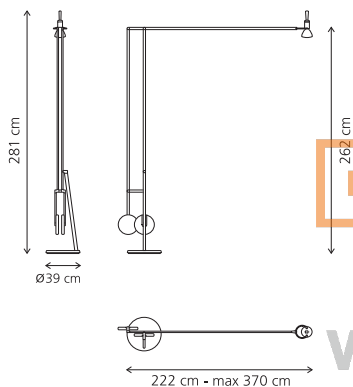

MODULO
ELECTRO
www.modulelectro.ru

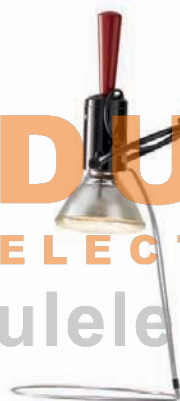

HALO max 1x150W (E 27) - PAR 38, included



IP20 □ F + Dimmer

FLUO 1x23W (E 27) - PAR 38, included

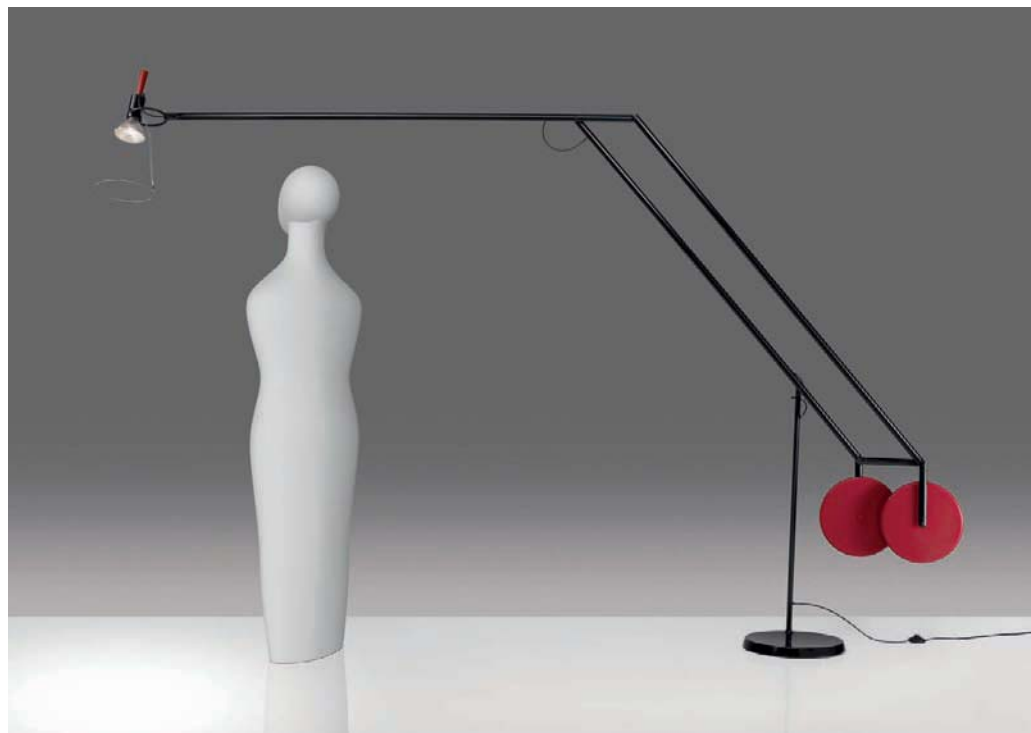
IP20 □ F





 **MODUL** 
ELECTRO
www.modulelectro.ru

Doride

design

Karim Rashid
2009



Awards

Good Design Award
The Chicago Athenaeum
2009 – Chicago (US)

Materiali: base in acciaio; struttura in metallo idroformato; griglia frangiluce antiabbagliamento in materiale termoplastico.

Specificità: lungo lo sviluppo verticale della lampada è presente uno snodo che permette una rotazione sul proprio asse fino a 350°, regolando così l'emissione della luce. Touch dimmer posto lungo l'asta.

Light emission



Colour



Polished black

Materials

Steel base; structure in hydro-formed metal; anti-dazzle louvre in thermoplastic material.

Matériaux

Base en acier ; structure en métal hydro-formé ; grille anti-éblouissement en matériau thermoplastique.

Materialien

Sockel aus lackiertem Stahl; Struktur aus hydrogeformten Metall; Blendschutz Gitter aus thermoplastischem Material.

Materiales

Base metálica; estructura en metal hidroformado; parrilla antideslumbramiento en material termoplástico.

Specification

A joint along the vertical lamp development allows a rotation until 350°, adjusting the light emission and assuming different shapes in the space. Touch dimmer placed on the stem.

Spécificité

Le lampadaire se développe verticalement avec une rotation jusqu'à 350° permettant ainsi l'orientation de la lumière et revêtant différentes formes dans l'espace. Variateur sensible placé sur la tige.

Spezifikation

Ein Gelenk an der vertikalen Achse erlaubt eine Drehung des Leuchtenkopfes um 350°, um den Lichtaustritt durch unterschiedliche Positionen zu verändern.

Especificaciones

Un largo cuerpo vertical al final del cual encontramos un nudo que permite la rotación sobre el propio eje hasta 350°, regulando así la emisión de la luz y asumiendo diferentes formas y curvas en el espacio. Encendido mediante la modalidad touch para la regulación de la intensidad luminosa colocado a lo largo del asta.

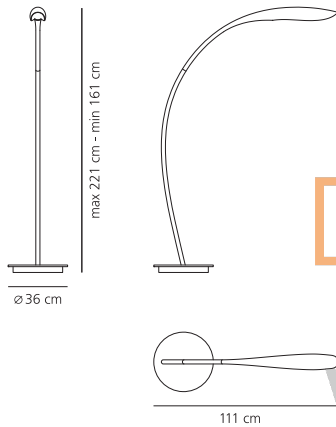

MODUL
ELECTRO

www.modulelectro.ru

FLUO 1x57W (GX 24 q-5) - TC-TEL
Electronic ballast

IP20 Touch Dimmer





 **MODUL** 
ELECTRO

www.modulelectro.ru

Cadmo

design

Karim Rashid
2006



Awards

iF Produkt Design Award
2010 – Hannover (Deutschland)
Good Design Award
The Chicago Athenaeum
Chicago (US)

Light emission



Colours

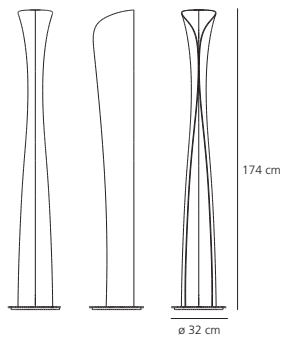
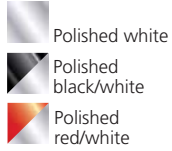

Indirect emission:
HALO max 1x230W (R7s) – ES, included + Dimmer
Diffused emission:
INC max 1x60W (E 27) – R 63, included



Indirect emission:
METAL HALIDE 1x70W (E 27) – HIE, included
Diffused emission:
INC max 1x60W (E 27) – R 63, included



Indirect emission:
METAL HALIDE 1x150W (E 27) – HIE, included
Diffused emission:
INC max 1x60W (E 27) – R 63, included



Materiali: corpo lampada in acciaio verniciato, base in acciaio con copribase verniciato.

Materials

Painted steel body lamp; inox-steel base with painted cover.

Matériaux

Corps en acier verni; base en acier inox avec couverture vernie.

Materialien

Leuchtenkörper aus lackiertem Stahl; Sockel aus Inox-Stahl mit lackiertem Schutz.

Materiales

Cuerpo de la lámpara de acero; base de acero inox con cubierta pintada.

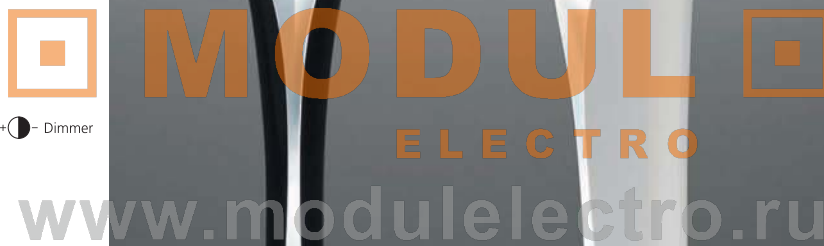



MODUL
ELECTRO
www.modul-electro.ru

Aqua Cil terra

design

Ross Lovegrove
2007



Materiali: base e struttura in alluminio pressofuso; stelo in acciaio; diffusore in alluminio stampato e trattato a specchio.

Light emission



Colours

- Base and stem: metal grey
- Diffuser: mirror
- Diffuser: metal orange
- Diffuser: metal blue

Materials

Die-cast aluminium base and structure; steel stem; moulded and mirror-treated aluminium diffuser.

Matériaux

Base et structure en aluminium moulé sous pression; tige en acier; diffuseur en aluminium moulé et traité façon miroir.

Materialien

Sockel und Struktur aus druckgegossenem Aluminium; Stab aus Stahl, Lichtverteiler aus Spritzguss und hochglanzpoliertem Aluminium.

Materiales

Pie y estructura en aluminio fundido a presión; tija en acero; difusor en aluminio moldeado por inyección con acabado pulido espejo.

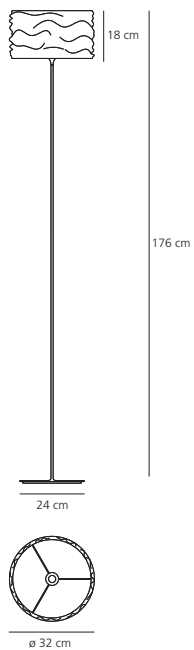

HALO max 1x205W (E 27) – ECO

IP20 + Touch Dimmer





MODUL
ELECTRO

www.modulelectro.ru

Cabildo terra

design

Eric Solé
2007



Awards

Good Design Award
The Chicago Atheneum
2008 – Chicago (US)

Materiali: base e stelo in acciaio; corpo lampada in alluminio pressofuso verniciato.

Light emission



Colour



White

Materials

Steel base and stem; body
lamp in painted die-cast
aluminium.

Matériaux

Base et tige en acier ; corps
de lampe en aluminium
moulé sous pression peint.

Materialien

Sockel und Stab aus Stahl;
Leuchtenkörper aus
druckgegossenem, lackiertem
Aluminium.

Materiales

Pie y tija en acero; cuerpo
de lámpara en aluminio
fundido a presión y pintado.

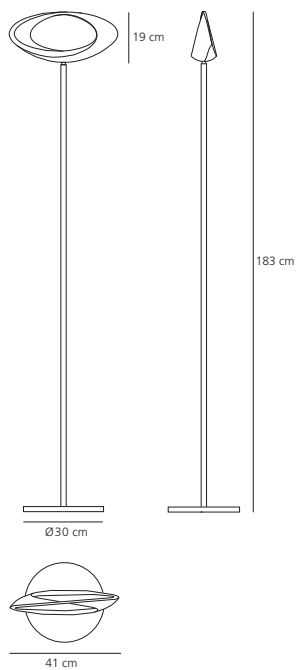

HALO max 1x230W (R7s) – ES, included

IP20      +  Dimmer

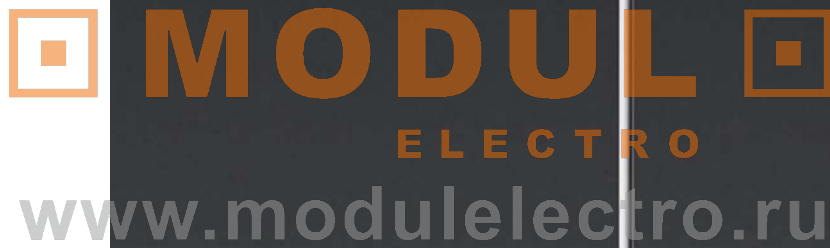
www.modulelectro.ru



Echos

design
Jan Van Lierde
1998



Awards

Design Innovationen Design Zentrum
Nordrhein Westfalen
Reddot Design Award
1999 – Essen (Deutschland)

Materiali: base in acciaio verniciato; corpo in alluminio verniciato.

Light emission



Colours

Base:
dark grey
Body:
metal grey

Materials

Base in painted steel;
body in painted aluminium.

Matériaux

Base en acier verni ;
corps en aluminium peint.

Materialien

Sockel aus lackiertem Stahl;
Gehäuse aus eloxiertem
Aluminium.

Materiales

Pie de acero pintado;
cuerpo de aluminio pintado.

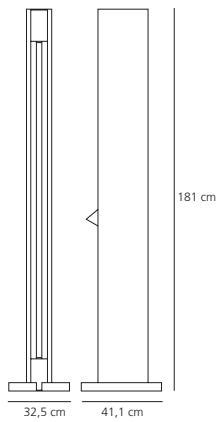

Indirect emission:
HALO max 1x400W (R7s) - ES, included + Dimmer
Diffused emission:
FLUO 1x58W (G 13) - T 26, included
Spot emission:
HALO max 1x35W/12V (GU 4) -
QR CBC 35, included + Dimmer



MODULO
ELECTRO

www.modulelectro.ru



Diffused back light

Megaron terra

design

Gianfranco Frattini
1979



Awards

Compasso d'Oro / A.D.I.
Segnalazione
1981 – Milano (Italia)
BIO 9 – Honourable mention
1981 – Ljubljana (Slovenia)
Sixth Arango International
Design Exhibition
1987 – Miami (US)

Light emission



Colours



Base:
polished black



Body:
polished black



Body:
mirror

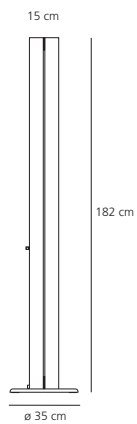

max 1x400W (R7s) – ES, included

IP20 + – Dimmer

Materiali: base in acciaio rivestita con resina termoplastica; corpo in alluminio verniciato o anodizzato lucido.

Materials

Steel base coated with thermoplastic resin; body in painted or polished anodized aluminium.

Matériaux

Base en acier recouvert de résine thermoplastique ; corps en aluminium verni ou anodisé poli.

Materialien

Standfuß aus Stahl mit thermoplastischem Kunstharz überzogen; Gehäuse aus lackiertem oder glänzend eloxiertem Aluminium.

Materiales

Pie de acero, revestido con resina termoplástica; cuerpo de aluminio pintado, o anodizado pulido.

 **MODUL** 
ELECTRO
www.modulelectro.ru



Callimaco

design

Ettore Sottsass
1982



Awards

Twentieth Century Design Collection
of the Metropolitan Museum of Art
New York (US)
The Israel Museum
Jerusalem (Israel)

Materiali: base e diffusore in acciaio verniciato; stelo in alluminio verniciato;
maniglia in metallo cromato lucido.

Light emission



Colours

- Base: polished grey
- Stem: polished yellow
- Diffuser: polished red

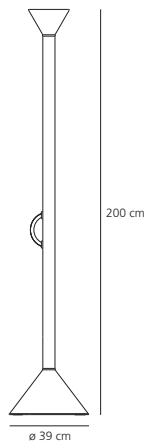

HALO max 1x230W (R7s) – ES, included

IP20 Dimmer

Materials
Base and diffuser in painted steel; stem in painted aluminium; handle in polished chrome metal plate.

Matériaux
Base et diffuseur en acier verni ; tige en aluminium verni ; poignée en métal chromé.

Materialien
Sockel und Schirm aus lackiertem Stahl; Säule aus lackiertem Aluminium; Griff aus poliertem, verchromtem Metall.

Materiales
Materiales: pie y difusor de acero pintado; vástago de aluminio pintado y empuñadura, de metal cromado lúcido.

 **MODULO** 
ELECTRO

www.modulelectro.ru



Tizio supporto terra

(for Tizio, Tizio Led, Tizio 35, Tizio plus)

design

Richard Sapper
1980



Materiali: alluminio verniciato.

Specificità: supporti terra per il sostegno delle lampade Tizio, Tizio Led, Tizio 35 e Tizio Plus.

Colours

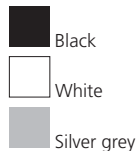

Materials

Painted aluminium.

Specification

Floor supports for Tizio, Tizio Led, Tizio 35, Tizio Plus fittings.

Matériaux

Aluminium verni.

Spécificité

Support pour Tizio, Tizio Led, Tizio 35, Tizio Plus.

Materialien

Lackiertes Aluminium.

Spezifikation

Säule für die Leuchten Tizio, Tizio Led, Tizio 35, Tizio Plus.

Materiales

Aluminio pintado.

Especificaciones

Soportes de pie para la sujeción de las lámparas Tizio, Tizio Led, Tizio 35 y Tizio plus.

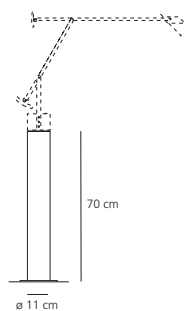

Supporto terra Tizio, Tizio Led, Tizio plus

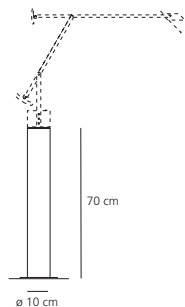

Supporto terra Tizio 35

MODULO
ELECTRO
www.modulelectro.ru



Nestore terra
Nestore lettura

design
Carlo Forcolini
1989,1991



Awards
Nestore terra
Compasso d'Oro / A.D.I. – Segnalazione
1991 – Milano (Italia)

Materiale: struttura in metallo verniciato o nichelato opaco; testa in resina termoplastica.
Specificità: braccio bilanciato, regolabile sul piano verticale ed orizzontale.

Light emission



Colours

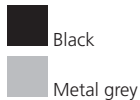

Materials

Painted or matt nickel metal structure; thermoplastic resin head.

Matériaux

Structure en métal verni ou nickel mat ; tête en résine thermoplastique.

Materialien

Gestell aus lackiertem oder matt-vernicheltem Metall; Leuchtenkopf aus Kunstharz.

Materiales

Estructura de metal pintado o niquelado mate, cabezal de resina termoplástica.

Specification

Counter-balanced arm adjustable on both vertical and horizontal planes.

Spécificité

Bras équilibré réglable sur l'axe horizontal et vertical.

Spezifikation

Verstellbarer Arm, vertikal und horizontal regulierbar.

Especificaciones

Brazo compensado que se regula en sentido horizontal y vertical.

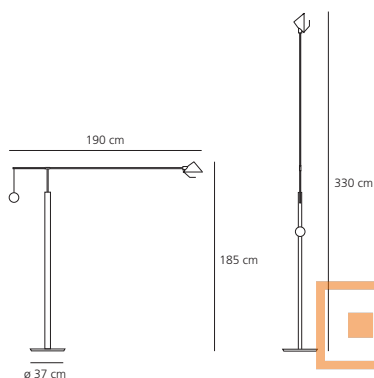

Nestore terra
HALO max 1x205W (B 15d) – ECO, included
IP20 □ ▽ PG © + ◐ – Touch Dimmer

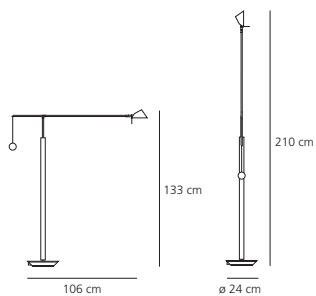

Nestore lettura
HALO max 1x50W/12V (GY 6,35) – QT 12, included
IP20 □ ▽ © PG © + ◐ – Dimmer



Tolomeo terra
Tolomeo lettura
Tolomeo micro terra

design
 Michele De Lucchi
 Giancarlo Fassina
 1987, 1990, 2001

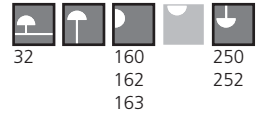

Awards
 Tolomeo terra
 Compasso d'Oro / A.D.I.
 1989 – Milano (Italia)

Materiali: base e struttura a bracci mobili in alluminio lucidato; diffusore orientabile in tutte le direzioni in alluminio anodizzato opaco; snodi in alluminio brillantato.

Specificità: disponibile con due snodi in due dimensioni (terra e micro terra) e con uno snodo (lettura). Sistema di equilibratura a molle.

Light emission



Colours

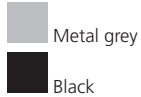

Materials

Base and cantilevered arms in polished aluminium; diffuser in opaque anodized aluminium adjustable in all directions; joints in polished aluminium.

Specification

Available with two joints and in two sizes (floor and micro floor versions) and with only one joint (reading-floor version). System of spring balancing.

Matériaux

Base et structure à bras articulés en aluminium poli; diffuseur, orientable dans toutes les directions, en aluminium anodisé opaque; articulations en aluminium brillant.

Spécificité

Disponible avec deux articulations en deux tailles (lampadaire et lampadaire micro) et avec une articulation (lampadaire de lecture). Système d'équilibrage à ressorts.

Materialien

Sockel und ausrichtbare Arme aus glänzendem Aluminium; in alle Richtungen verstellbarer Leuchtenkopf aus matt eloxiertem Aluminium; Gelenke aus poliertem Aluminium.

Spezifikation

Erhältlich mit zwei Gelenken und in zwei Größen (Stehleuchte und Micro-Stehleuchte) und mit nur einem Gelenk (Lese-Version). Federausgleichsystem.

Materiales

Pie y estructura con brazos móviles de aluminio pulido; difusor orientable en todas direcciones en aluminio anodizado opaco; articulaciones de aluminio pulido.

Especificaciones

Está disponible con dos articulaciones y en dos tamaños (terra y micro terra) y con sólo una articulación (lectura). Sistema de equilibrado a muelles.

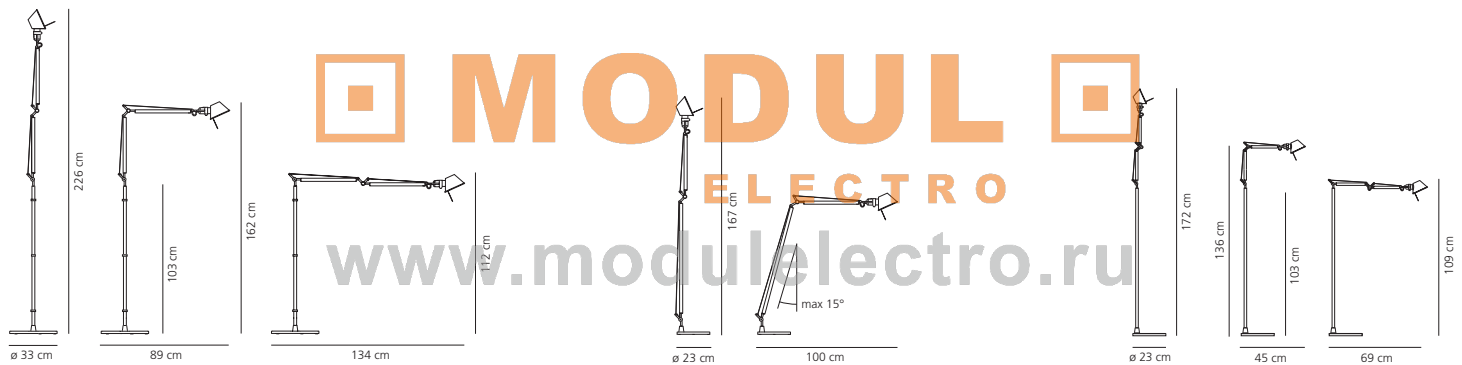

Tolomeo terra
 HALO max 1x70W (E 27) – ES, included



FLUO 1x18W (G 24 q-2) – TC-DEL, included
 Electronic ballast, darklight louvre included



Tolomeo lettura
 HALO max 1x70W (E 27) – ES



Tolomeo micro terra
 HALO max 1x60W (E 14) – QT 26





MODUL
ELECTRO
www.modul-electro.ru

Tolomeo XXL

design

Michele De Lucchi,
Giancarlo Piretti
2009



Materiali: base in cemento; struttura a bracci mobili in alluminio lucidato; testa in alluminio verniciato; diffusore in materiale termoplastico opalino satinato; snodi in alluminio brillantato.

Specificità: in scala 4:1 rispetto al modello da tavolo, è disponibile in versione da interno e in versione outdoor. Sistema di equilibratura a molle.

Light emission



Colours

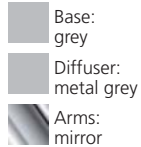

Materials

Base in concrete; cantilevered arms in polished aluminium; head in painted aluminium; diffuser in opal thermoplastic material; joints in polished aluminium.

Matériaux

Base en béton; structure à bras articulés en aluminium poli; tête en aluminium peint; diffuseur en matériau thermoplastique opalin; articulations en aluminium brillant.

Materialien

Sockel aus Beton; ausrichtbare Arme aus glänzendem Aluminium; Leuchtenkopf aus lackiertem Aluminium; Schirm aus thermoplastischem Material; Gelenke aus poliertem Aluminium.

Materiales

Base en cemento; estructura y brazos móviles en aluminio brillo; cabezal en aluminio pintado; difusor en material termoplástico opal satinado; nudos en aluminio brillo.

Specification

In scale 4:1 relative to the table model, it's available both in indoor and outdoor versions. System of spring balancing.

Spécificité

A l'échelle 4:1 par rapport au modèle à poser, elle est disponible aussi bien pour l'intérieur que pour l'extérieur. Système d'équilibrage à ressorts.

Spezifikation

Im Maßstab 4:1 im Vergleich zu der Tischleuchte ist diese XXL-Version für den Innen- und Außenbereich erhältlich. Federausgleichsystem.

Especificaciones

En escala 4:1 respecto al modelo de sobremesa, está disponible en versiones de interior o exterior. Sistema de equilibrio por muelles.

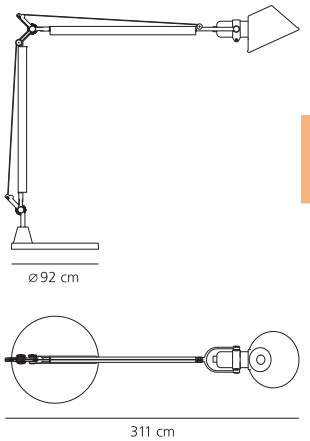

MODULO
ELECTRO

www.modulelectro.ru

Tolomeo XXL

FLUO 1x120W (2G 8) - TC-TELI
Electronic ballast



Tolomeo XXL outdoor

FLUO 1x120W (2G 8) - TC-TELI
Electronic ballast





MODUL
ELECTRO

www.modulelectro.ru

Tolomeo basculante terra
Tolomeo basculante lettura

design
Michele De Lucchi
Giancarlo Fassina
2006



Materiali: struttura a bracci mobili in alluminio lucidato; snodi in alluminio brillantato, diffusore in carta pergamena o in raso di seta supportato da materiale plastico.

Specificità: disponibile nella versione da terra (con due snodi) o da lettura (con uno snodo). Sistema di equilibratura a molle. Il diffusore, nel normale utilizzo, si dispone verticalmente, indipendentemente dall'angolazione del braccio.

Light emission



Colours

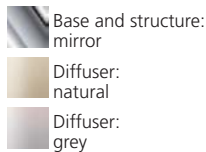

Materials

Cantilevered arms in polished aluminium; joints in polished aluminium; diffuser in parchment paper or in silk satin fabric on a plastic frame.

Specification

Available in floor (with two joints) or in reading-floor version (with only one joint). System of spring balancing. The diffuser normally used, remains vertical regardless of the angle of the arm.

Matériaux

Structure à bras articulés en aluminium poli ; articulations en aluminium brillant ; diffuseur en papier parchemin ou en polycarbonate recouvert de satin de soie.

Spécificité

Disponible dans les versions lampadaire (avec deux articulations) et lampadaire de lecture (avec une articulation). Système d'équilibrage à ressorts. Le diffuseur dans le cadre d'une utilisation normale, se place verticalement, indépendamment de la position du bras.

Materialien

Ausrichtbare Arme aus glänzendem Aluminium; Gelenke aus poliertem Aluminium; Schirm aus mit Kunststoff stabilisiertem Pergamentpapier oder Seidensatin.

Spezifikation

Erhältlich als Stehleuchte (mit zwei Gelenken) und als Leselampe (mit nur einem Gelenk). Federausgleichsystem. Der Schirm steht bei normalem Gebrauch vertikal, unabhängig von der Ausrichtung des Armes.

Materiales

Estructura con brazos móviles de aluminio pulido; articulaciones de aluminio pulido; difusor en pergamino o en raso seda reforzado con plástico.

Especificaciones

Está disponible en versión de pie (con dos articulaciones) y de lectura (con sólo una articulación). Sistema de equilibrado a muelles. En su uso normal, el difusor se dispone verticalmente, independientemente del ángulo del brazo.

MODULO
ELECTRO
www.modulelectro.ru

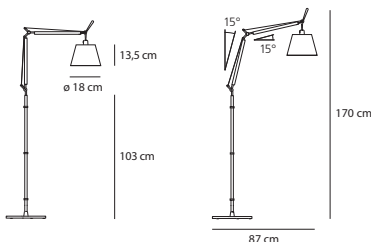

Tolomeo basculante terra

HALO max 1x70W (E 27) – ES

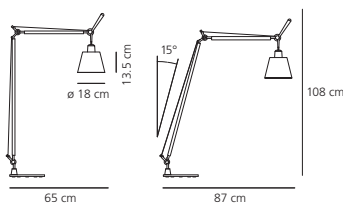

Tolomeo basculante lettura

HALO max 1x70W (E 27) – ES



Tolomeo basculante terra



Tolomeo basculante lettura



MODUL
ELECTRO

www.modulelectro.ru

Tolomeo Mega terra

design

Michele De Lucchi
Giancarlo Fassina
2002



Awards

Reddot Design Award
2003 – Essen (Deutschland)

Materiali: base in alluminio lucidato; struttura a bracci mobili in alluminio lucidato; diffusore in carta pergamena o in raso di seta supportato da materiale plastico; snodi in alluminio brillantato.

Specificità: diffusore disponibile in tre dimensioni, orientabile in tutte le direzioni. Sistema di equilibratura a molle.

Light emission



Colours



Base and structure:
mirror



Diffuser
natural



Diffuser
grey.

Materials

Polished aluminium base and cantilevered arms; diffuser in parchment paper or in silk satin fabric on a plastic frame; joints in polished aluminium.

Specification

Diffuser, available in three sizes, adjustable in all directions. System of spring balancing.

Matériaux

Base et structure à bras articulés en aluminium poli ; diffuseur en papier parchemin ou en polycarbonate recouvert de satin de soie ; articulations en aluminium brillant.

Spécificité

Diffuseur disponible en trois tailles, orientable dans toutes les directions. Système d'équilibrage à ressorts.

Materialien

Sockel und ausrichtbare Arme aus glänzendem Aluminium; Schirm aus mit Kunststoff stabilisiertem Pergamentpapier oder Seidensatin; Gelenke aus poliertem Aluminium.

Spezifikation

Der Leuchtenkopf, welcher in drei Größen erhältlich ist, lässt sich in alle Richtungen verstellen. Federausgleichsystem.

Materialien

Pie y estructura con brazos móviles de aluminio pulido; difusor en pergamino o en raso seda reforzado con plástico; articulaciones de aluminio pulido.

Especificaciones

Difusor disponible en tres tamaños, orientable en todas direcciones. Sistema de equilibrado a muelles.

MODULO
ELECTRO
www.modulelectro.ru

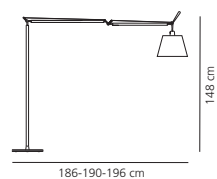
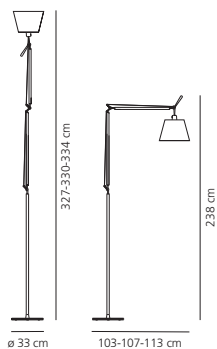
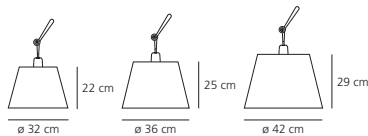

HALO max 1x150W (E 27) – ECO

IP20 + Dimmer





 **MODUL** 
ELECTRO

www.modulelectro.ru

Melampo terra Melampo Mega terra

design
Adrien Gardère
2000, 2005



Awards

Design Innovationen Design Zentrum
Nordrhein Westfalen
Reddot Design Award
1999 – Essen (Deutschland)

Materiali: base in zama verniciata; stelo in alluminio verniciato; diffusore in raso di seta, supportato da materiale plastico.

Specificità: diffusore orientabile in tre diverse posizioni.

Light emission



Colours

-  Base and stem: grey
-  Diffuser: grey
-  Base and stem: bronze
-  Diffuser: natural

Materials

Base in painted zamac; painted aluminium stem; diffuser in silk satin fabric on a plastic frame.

Matériaux

Base en zamac peint ; tige en aluminium peint ; diffuseur en polycarbonate recouvert de satin de soie.

Materialien

Sockel aus lackiertem Zamak; Stab aus lackiertem Aluminium; Schirm aus Seidensatin (stabilisiert mit Kunststoff).

Materiales

Pie de zamak pintado; tija de aluminio pintado; difusor en raso seda reforzado con plástico.

Specification

Adjustable diffuser into three different positions.

Spécificité

Diffuseur orientable dans trois positions différentes.

Spezifikation

Schirm in drei unterschiedliche Positionen verstellbar.

Especificaciones

Difusor orientable en tres posiciones diferentes.

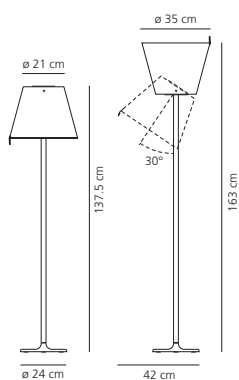

Melampo terra

HALO max 2x52W (E 27) – ES

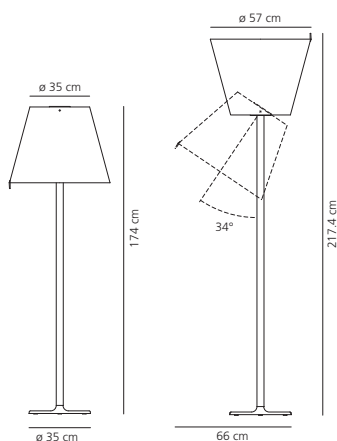

Melampo Mega terra

HALO max 2x150W (E 27) – ECO



MODULO
ELECTRO

www.modulelectro.ru



Melampo Mega terra

Melampo terra



Choose terra
Choose Mega terra

design
Matteo Thun
2006, 2007



Materiali: base in zama; struttura in metallo verniciato; diffusore orientabile in materiale termoformato accoppiato a un foglio di polipropilene serigrafato rosso o da carta pergamena.

Light emission



Colours

-  Base and stem: dark grey
-  Diffuser: transparent + red
-  Diffuser: transparent + natural

Materials

Base in zamak, painted metal structure, adjustable diffuser in thermoformed material joined with red silkscreened polypropylene sheet or with parchment paper.

Matériaux

Base en zamak ; structure en métal verni ; diffuseur orientable en matériau thermoformé couplé à une feuille de polypropylène sérigraphié rouge ou papier parchemin.

Materialien

Leuchtenfuß aus Zamak; Struktur aus lackiertem Metall; verstellbarer Schirm aus thermogeformtem Polypropylen entweder rot bedruckt oder mit Pergamentpapier zusammengesetzt.

Materiales

Pie de zamak; estructura de metal pintado; difusor orientable de material termoconformado junto con tejido al polipropileno rojo serigrafado o con tela de pergamena.

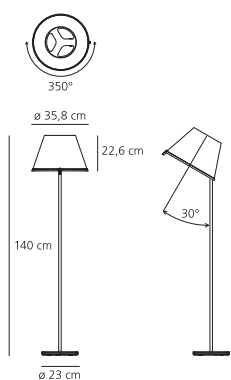

Choose terra

HALO max 2x52W (E 27) – ES



FLUO 2x13W (GX 24 q-1) – TC-DEL

Electronic ballast

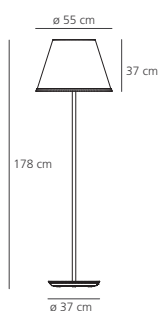

Choose Mega terra

Direct emission:

HALO max 3x70W (E 27) – ES +  Dimmer

Indirect emission:

INC max 1x100W (E 27) – R 80 reflector



Direct emission:

FLUO 3x18W (GX 24 q-2) – TC-DEL, Electronic ballast

Indirect emission:

INC max 1x100W (E 27) – R 80 reflector

or

FLUO 1x23W (E 27) – SPOT



Genesy

design

Zaha Hadid
2009



Materiali: corpo lampada monomaterico in poliuterano espanso stampato a iniezione.

Specificità: la luce diretta Led e l'indiretta (alogeno o fluorescente) sono gestibili separatamente da due pulsanti touch posti sul corpo lampada.

Light emission



Colours



Polished black



Polished white

Materials

Injection-moulded foam polyurethane.

Specification

Direct Led light and indirect light (halogen or fluorescent) are manageable separately by two touch dimmers placed on the body lamp.

Matériaux

Mousse de polyuréthane moulée par injection.

Spécificité

La lumière directe à Led et indirecte (halogène ou fluorescente) sont gérables séparément grâce à deux variateurs sensitifs placés sur le corps de l'appareil.

Materialien

Poliertes Polyurethan.

Spezifikation

Regelung der Beleuchtung (direkt Led, indirekt Halogen- und Leuchtstofflampen) durch zwei getrennte Touch-Dimmer am Leuchtenkörper.

Materiales

Cuerpo mono material en poliuretano espanso estampado a inyección.

Especificaciones

La luz directa Led y la indirecta (halógena o fluorescente) se gestionan separadamente desde dos pulsantes touch localizados en el cuerpo de la lámpara.



Touch dimmer



Led

MODUL
ELECTRO
www.modulelectro.ru

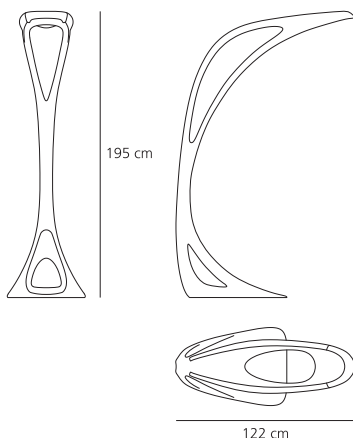

Indirect emission:
HALO max 1x230W (R7s) - ES, included
Direct emission:
LED 7,5W, included



IP20 +

Indirect emission:
FLUO 2x42W (GX 24 q-4)- TC-TEL, included
Direct emission:
LED 7,5W, included

IP20 +





 **MODUL** 
ELECTRO
www.modulelectro.ru

Cosmic Leaf terra

design
Ross Lovegrove
2009

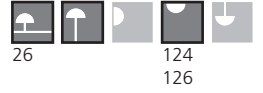

Materiali: struttura in acciaio cromato; corpo lampada-diffusore in metacrilato trasparente texturizzato; corpo illuminante in metallo verniciato.

Light emission



Colours



Diffuser:
trasparent



Lighting unit:
grey

Materials

Chromed steel structure;
body lamp-diffuser in
transparent methacrylate
with texture; painted metal
lighting unit.

Matériaux

Structure en acier chromé ;
corps diffuseur en méthacry-
late transparent tissé ; corps
lumineux en métal peint.

Materialien

Gestell aus verchromten
Stahl, Leuchtenkörper aus
transparentem, strukturiertem
Metacrylat; Beleuchtungsein-
heit aus lackiertem Metall.

Materiales

Estructura en metal cromado;
cuerpo de lámpara-difusor
en metacrilato transparente
texturizado, cuerpo luminoso
en metal pintado.

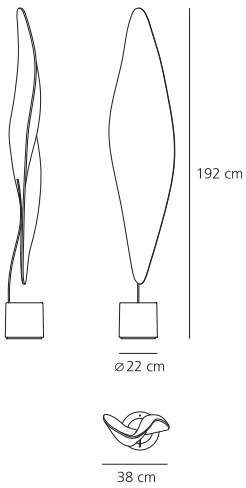

HALO 1x100W (G 53) - QR-LP 111,
included



METAL HALIDE 1x70W (GX 8,5) - HIR-CE 111,
included

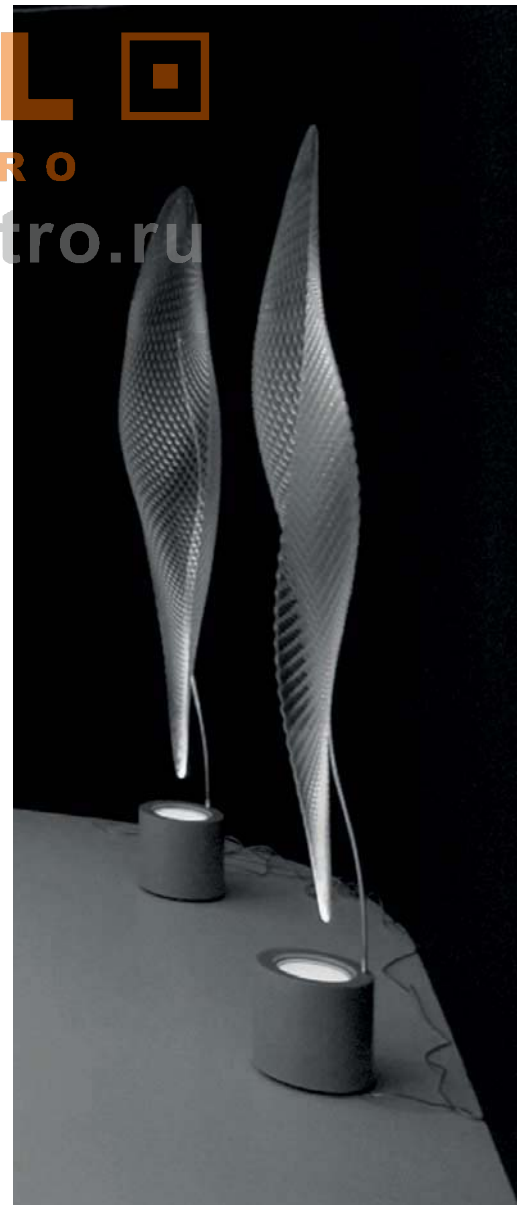

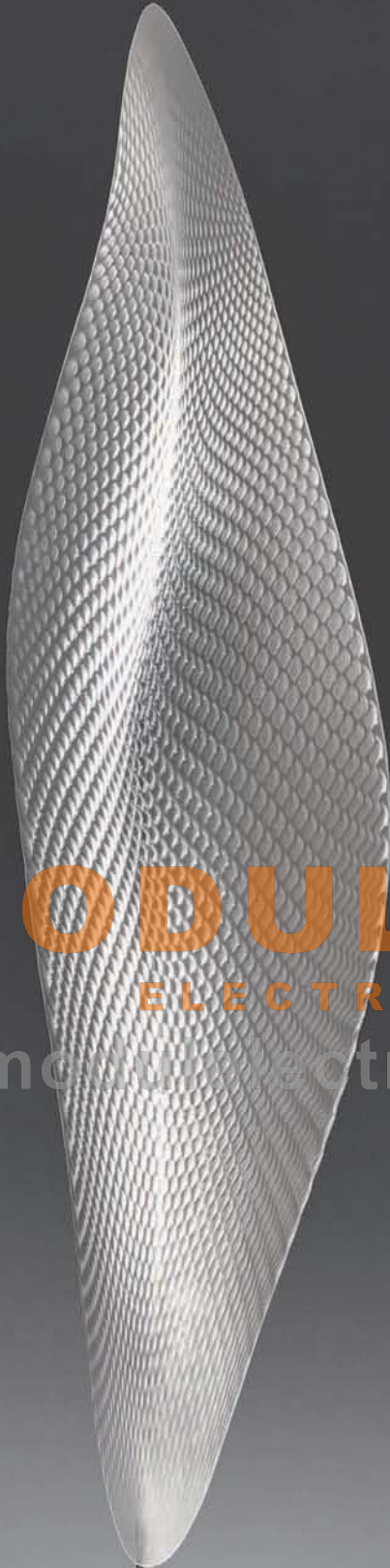

 **MODUL** 
ELECTRO

www.modulselectro.ru



Pipe terra

design
Herzog & de Meuron
2005



Awards

Reddot Award Product Design
"Best of the best"
2006 – Essen (Deutschland)
Designpreis der Bundesrepublik Deutschland
2008 – Frankfurt (Deutschland)

Materiali: base in acciaio verniciato effetto "soft touch"; stelo rivestito da una guaina di silicone platinico naturale (anti ingiallimento); diffusore in policarbonato trasparente verniciato effetto gomma; lente trasparente; riflettore interno in alluminio speculare con microforature irregolari.

Specificità: costituita da un unico tubo d'acciaio, formato da una parte rigida inferiore e da una flessibile superiore. Touch dimmer posto lungo lo stelo.

Light emission



Colours

Body:
transparent satin
Base:
black

Materials

Steel base "soft touch" effect painted; stem covered by a natural platinum silicone sheath (antiyellowing); diffuser in transparent polycarbonate with rubber-effect coat; transparent lens; internal reflector made of specular aluminium with random perforations.

Matériaux

Base en acier verni peint effet "soft touch"; tige revêtue d'une gaine en silicone naturelle transparente (anti jaunissement) ; diffuseur en polycarbonate verni transparent ; réflecteur interne en aluminium spéculaire comprenant de petites perforations.

Materialien

Sockel aus lackiertem Stahl mit Soft Touch-Effekt; Stab mit transparentem, platinier-tem und gegen Vergilben geschütztem Silikon überzogen; Leuchtenkopf aus gummiartig anmutendem, transparentem Polycarbonat; transparente Linse; Innenreflektor aus verspiegeltem Aluminium.

Materiales

Base en acero pintado efecto "soft touch"; tija revestida por una funda de silicona platinica natural (antioxidante); difusor en policarbonato transparente pintado efecto goma; lente transparente; reflector interno en aluminio "Speculare" con micro agujeros irregulares.

Specification

The body lamp is a single tubular steel structure, composed of a rigid lower part and an adjustable higher part. Touch dimmer placed on the steel.

Spécificité

Constitué d'un tube en acier rigide dans sa partie inférieure et flexible dans sa partie supérieure. Variateur sensible placé sur la tige.

Spezifikation

Der röhrenförmige Leuchtenkörper besitzt eine Struktur aus Stahl, deren unterer Teil unbeweglich während der obere flexibel und ausrichtbar ist. Lichtaustritt durch unterschiedliche Positionen zu verändern.

Especificaciones

Está constituida por un único tubo de acero, formado por una pared rígida inferior y de una flexible superior. Encendido mediante la modalidad touch para la regulación de la intensidad luminosa colocado a lo largo del asta.

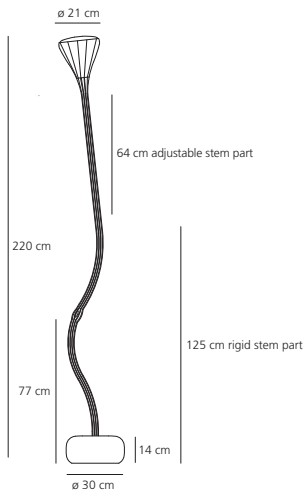

MODULO ELECTRO
www.modulelectro.ru



Touch dimmer



FLUO 1x42W (GX 24 q-4) – TC-TEL, included
Electronic ballast

IP20 + Touch Dimmer



MODUL
ELECTRO
www.modulelectro.ru

Talak lettura
Talak lettura Led

design
Neil Poulton
2007



Materiali: base in ferro verniciato; stelo in acciaio cromato lucido; corpo lampada in resina termoplastica verniciata.

Specificità: il corpo lampada ruota di 360° sul piano orizzontale ed è regolabile in altezza.

Light emission



Colours

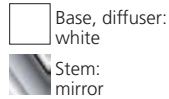

Materials

Base in painted iron; polished chromed steel stem; body lamp in painted thermoplastic resin.

Specification

The body lamp rotates 360° on the horizontal plane and is adjustable in height.

Matériaux

Base en fer peint; tige en acier poli chromé, corps en résine thermoplastique vernie.

Spécificité

Le corps de la lampe s'oriente jusqu'à 360° sur le plan horizontal et se règle en hauteur.

Materialien

Sockel aus lackiertem Eisen; Stab aus Stahl, Chrom poliert; Leuchtenkörper aus lackiertem Kunstharz.

Spezifikation

Der Leuchtenkörper kann horizontal um 360° gedreht werden und ist höhenverstellbar.

Materiales

Base en hierro pintado; tija en acero cromado brillante; cuerpo de la lámpara en resina termoplástica pintada.

Especificaciones

El cuerpo de la lámpara gira a 360° en sentido horizontal y es regulable en altura.

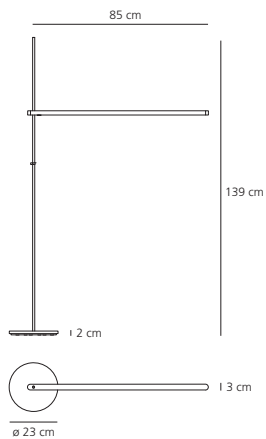

Talak lettura

FLUO 1x13W (W 4,3x8,5d) – T2, included
Electronic ballast



Talak lettura Led

LED 80 x 0,1W, included



Firefly lettura

design

Emanuele Ricci
1993



Materiali: stelo in acciaio verniciato, base e diffusore in resina termoplastica.
Specificità: stelo e diffusore orientabili in tutte le direzioni.

Light emission



Colour



Black

Materials

Stem in painted steel; base and diffuser in thermoplastic resin.

Specification

Stem and diffuser adjustable in all directions.

Matériaux

Tige en acier verni, base et diffuseur en résine thermoplastique.

Spécificité

Tige et tête orientables dans toutes les directions.

Materialien

Stab aus lackiertem Stahl, Sockel und Schirm aus Kunstharz.

Spezifikation

Leuchtenarm und-kopf in alle Richtungen verstellbar.

Materiales

Vástago de acero pintado. Pie y difusor, de resina termoplástica.

Especificaciones

Vástago y difusor, orientables en todas las direcciones.

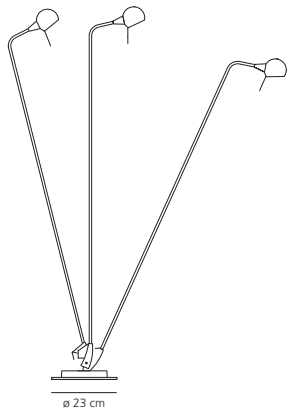

max 121 cm

www.modulelectro.ru

HALO max 20W/12V (G 4) - QT 9, included



Materiali: acrilico opalino.

Specificità: utilizza sorgenti RGB che consentono di ottenere infinite atmosfere di luce colorata. Attraverso un telecomando è possibile gestire 10 atmosfere standard, crearne e memorizzarne ulteriori 10 e agire sull'intensità luminosa. Un display posto sulla base visualizza l'atmosfera selezionata. In prossimità della base è posta una luce blu di presenza.

Light emission



Colours

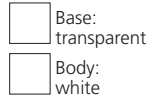

Materials

Opal acrylic.

Specification

It uses RGB sources which allow to create a wide range of light coloured atmospheres. It is possible, using a remote control, to manage 10 standard atmospheres, to create and memorise other 10 and to adjust the light intensity. A display situated on the lamp base shows the selected atmosphere. A blue light near the base marks the presence of the lamp.

Matériaux

Acrylique opalin.

Spécificité

Il utilise des sources RGB, qui permettent d'obtenir de nombreuses atmosphères colorées. A l'aide de la télécommande, il est possible de gérer 10 atmosphères standard, d'en créer et d'en mémoriser 10 autres et d'agir sur l'intensité lumineuse. Un écran sur la base, visualise l'atmosphère sélectionnée. Une lumière bleue près de la base signale la présence de la lampe.

Materialien

Opales Acryl.

Spezifikation

Durch den Einsatz von RGB-Lampen lassen sich verschiedenste farbige Lichtstimmung kreieren, die über eine Fernbedienung abrufbar sind (10 Standard-Lichtstimmungen, 10 individuell einstellbare Lichtstimmungen und sowie Wahl der Lichtintensität). Ein Display am Sockel visualisiert die ausgewählte Lichtstimmung. Die im unteren Bereich installierte blaue Leuchte signalisiert die Präsenz.

Materiales

Metacrilato opalino.

Especificaciones

Incorpora fuentes de luz RGB, que permiten obtener infinitas atmósferas de luz coloradas. Mediante un mando a distancia es posible manejar 10 atmósferas standard, crear y memorizar otras 10 y actuar en la intensidad luminosa. Un display contenido en el pie de la lámpara expone la atmósfera seleccionada. Una luz azul marino cerca del pie indica la presencia de la bombilla alojada.

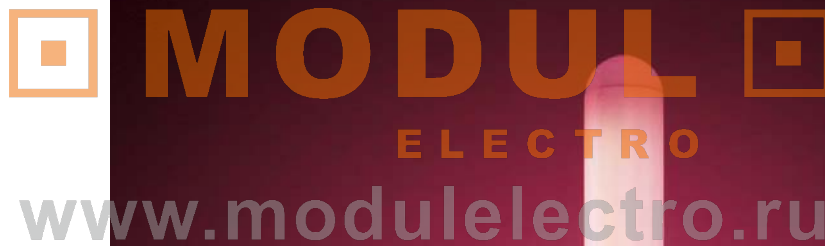
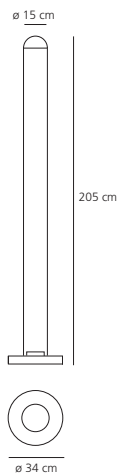

Diffused emission:
FLUO 3 RGBx58W (G 13) – T 26, included. Electronic ballast + Dimmer
Presence light:
FLUO 3x9W (G 23) blue – TC-5, included



Infrared remote control (included)

GOOD MORNING	RELAX	ENERGY
R 99% + G 99%	R 20% + G 50%	R 99% + G 40%
B 99% +	B 80% +	B 00% +
WORKING	IDEA	BALANCE
R 60% + G 50%	R 40% + G 60%	R 40% + G 60%
B 50% +	B 00% +	B 99% +
RELATION	PLAY	LOVE
R 40% + G 99%	R 99% + G 00%	R 99% + G 00%
B 50% +	B 99% +	B 00% +
DREAM		
R 00% + G 00%		
B 99% +		



Materiali: acrilico opalino.

Specificità: utilizza sorgenti RGB che consentono di ottenere infinite declinazioni della luce bianca, nelle diverse intensità e varietà delle temperature di colore, dalla più calda (2.500 K) alla più fredda (20.000 K). La regolazione delle funzioni avviene attraverso un telecomando a infrarossi. In prossimità della base è posta una luce blu di presenza.

Light emission



Colours

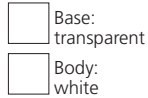

Materials

Opal acrylic.

Specification

It uses RGB light sources, which enable a limitless variation of white light with different intensities and a variety of colour temperatures, from the hottest (2.500 K) to the colder (20.000 K). The colour selection functions are set by an infrared remote control. A blue light near the base marks the presence of the lamp.

Matériaux

Acrylique opalin.

Spécificité

Il utilise des sources RGB qui permettent d'obtenir d'innombrables déclinaisons de la lumière blanche dans les différentes intensités et les variétés de températures de couleur, de la plus chaude (2.500 K) à la plus froide (20.000 K). Le réglage des fonctions se fait avec une télécommande à infra rouges. Une lumière bleue près de la base signale la présence de la lampe.

Materialien

Opales Acryl.

Spezifikation

Durch den Einsatz von RGB-Lampen lassen sich in Bezug auf die Farbtemperatur und Farbintensität verschiedenste Abstufungen des Weißlichts kreieren, von den wärmsten (2.500 K) zu den kältesten (20.000 K). Regelung der verschiedenen Funktionen über eine Infrarot-Fernbedienung. Die im unteren Bereich installierte blaue Leuchte signalisiert die Präsenz.

Materiales

Metacrilato opalino.

Especificaciones

Incorpora fuentes de luz RGB de color rojo, verde y azul, a efectos de obtener una gradación infinita de la luz blanca, con toda su variedad de intensidades y un amplio abanico de temperaturas-color, de muy fría (2.500 K) a muy cálida (20.000 K). Las funciones se regulan mediante mando a distancia de infrarrojos. Una fuente de luz azul, muy cerca de la base, subraya la presencia de la lámpara.

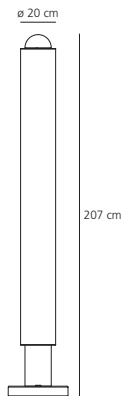

Diffused emission:

FLUO 2x3 RGB groups (tot. 6) x58W (G 13) – T 26, included. Electronic ballast



Presence light:

FLUO 3x9W (G 23) blue – TC-S, included



Infrared remote control (included)

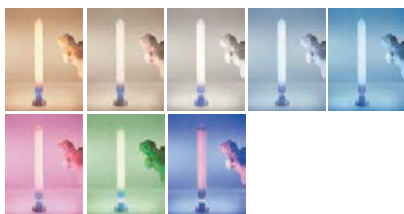

MODULO
ELECTRO
www.modulelectro.ru



Materiali: struttura in metallo; base in acciaio; diffusore in vetro serigrafato a specchio.
Specificità: disponibile nelle versioni Rigel Luce (standard), Rigel Luce Aria e Rigel Luce Suono (a richiesta su progetto). Il corpo lampada è uno specchio quando la luce è spenta, e si colora di luce cromatica quando la luce è accesa, grazie alle sorgenti fluorescenti RGB. Una sorgente alogena posta alla sommità dell'apparecchio produce luce bianca indiretta. La regolazione delle funzioni avviene sia attraverso una tastiera touch capacitiva, sia attraverso un telecomando. La lampada è dotata di rilevatore di presenza.

Light emission



Colour



Materials

Metal structure; steel base plate; glass moulded with filigree diffuser, mirror finish.

Matériaux

Structure en métal ; base en acier ; diffuseur en feuille de verre sérigraphié, finition chromée.

Materialien

Gestell aus verchromtem Metall; Fußplatte aus Stahl; Opal-Schirm mit Siebdruck und Verspiegelung.

Materiales

Estructura en metal; base en acero; difusor en vidrio serigrafiado a espejo, con acabado cromo.

Specification

Available in the following versions: Rigel Light (standard), Rigel Light Air and Rigel Light Sound (on project request). The lamp unit is a mirror when off, when it is turned on, it allows the coloured light of the RGB sources to pass through. An halogen source at the top produces indirect white light. Regulation of functions: through touch capacitive keyboard or remote control. The luminaire is equipped with a presence detector.

Spécificité

Disponible dans les versions : Rigel lumière (standard), Rigel lumière air et Rigel lumière son (sur demande). Lorsque la lampe est éteinte, son corps est un miroir tandis qu'il laisse passer la lumière colorée des sources (Rouge Vert Bleu) lorsqu'elle est allumée. Une source halogène sur le sommet produit une lumière blanche indirecte. Réglage des fonctions: aussi bien à l'aide d'un clavier à effleurement qu'avec la télécommande. Le luminaire est équipé d'un détecteur de présence.

Spezifikation

Erhältlich in den folgenden Ausführungen: Rigel Licht (Standard), Rigel Licht-Luft und Rigel Licht-Klang (auf Anfrage). Ausgeschaltet dient die Leuchte als Spiegel; in eingeschaltetem Zustand wird farbiges Licht abgestrahlt, das von RGB-Lichtquellen erzeugt wird. Eine Halogenlampe an der Spitze der Leuchte erzeugt indirektes Weißlicht. Funktionsregelungen: über eine Touch-Tastatur oder über eine Fernbedienung. Die Leuchte ist mit einem Anwesenheitssensor ausgestattet.

Especificaciones

Disponible en versiones Rigel luce (standard), Rigel luce aria y Rigel luce suono (sobre proyecto). El cuerpo de la lámpara apagado es un espejo, encendido trapasa la luz de color de las fuentes RGB. El extremo presenta una fuente de luz halógena produce una luz indirecta blanca. Regulacion de las funciones: mediante un botón touch o un mando a distancia. Está equipada de un detector de presencia.

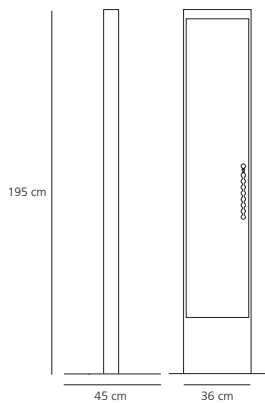

www.modulelectro.ru

Diffused emission:

FLUO 2x3 RGB groups (tot. 6) x58W (G 13) - T 26, included. Electronic ballast









Indirect emission:

HALO max 1x230W (R7s) - ES, included +  Dimmer



Infrared remote control (included)



-  indirect light
-  red
-  green
-  blue
-  rolling
-  white
-  presence sensor
-  on - off

Touch capacitive keyboard



Rigel Luce Aria



MODUL
ELECTRO
www.modulelectro.ru

Yin flu

design
 Carlotta de Bevilacqua
 2001



Materiali: struttura in metacrilato trasparente; diffusore in poliestere con finitura satinata a sfumare.

Specificità: tre proiettori fluorescenti con i filtri dicroici rosso, verde e blu consentono di ottenere infinite atmosfere di luce colorata. Attraverso un telecomando è possibile gestire 10 atmosfere standard, crearne e memorizzarne ulteriori 10 e agire sull'intensità luminosa. Un display posto sulla base visualizza l'atmosfera selezionata. Dotata di ruote per facilitarne lo spostamento.

Light emission



Colour



Materials

Transparent methacrylate structure; diffuser in polyester with satinated graduated finish.

Matériaux

Structure en méthacrylate transparent et diffuseur en polyester avec finition satinée nuancée.

Materialien

Struktur aus transparentem Metakrylat; Schirm aus satiniertem Polyester.

Materiales

Estructura de metacrilato transparente y difusor de poliéster con acabado satinado que degrada.

Specification

Three fluorescent projectors with dichroic filters red, green and blue, allow to create a wide range of light coloured atmospheres. It is possible, using a remote control, to manage 10 standard atmospheres, to create and memorise, other 10 and to adjust the light intensity. A display on the base shows the selected atmosphere. Four plastic transparent wheels give easy mobility to the lamp.

Spécificité

Trois projecteurs fluorescents avec filtres dichroïques rouge, vert et bleu permettent d'obtenir de nombreuses atmosphères colorées. A l'aide de la télécommande, il est possible de gérer 10 atmosphères standard, d'en créer et d'en mémoriser 10 autres et d'agir sur l'intensité lumineuse. Un écran sur la base, visualise l'atmosphère sélectionnée. Des roulettes permettent de déplacer la lampe facilement.

Spezifikation

Drei Strahler mit Lampen mit dichroitischem Filter in den Grundfarben Rot, Blau und Grün erschaffen unzählige farbige Lichtstimmungen, die über eine Fernbedienung abrufbar sind (10 Standardlichtstimmungen, 10 weitere Einstellungen der Lichtintensität). Ein Display visualisiert die ausgewählte Lichtstimmung. Vier Räder machen die Leuchte mobil.

Especificaciones

Tres proyectores fluorescentes con filtros dicroicos, rojo, verde y azul permiten obtener infinitas atmósferas de luz coloradas. Mediante un mando a distancia es posible manejar 10 atmósferas standard, crear y memorizar otras 10 y actuar en la intensidad luminosa. Un display contenido en la lámpara expone la atmósfera seleccionada. Cuatro ruedas de plástico transparente permiten mover con facilidad la lámpara.



ELECTRO

www.modulelectro.ru



FLUO 3x42W (GX 24 q-4) - TC-TEL, included
 Electronic ballast



Infrared remote control (included)

GOOD MORNING	RELAX	ENERGY
99% + 99%	20% + 50%	99% + 40%
99% +	80% +	00% +
WORKING	IDEA	BALANCE
60% + 50%	40% + 60% =	40% + 60%
50% +	00% +	99% +
RELATION	PLAY	LOVE
40% + 99%	99% + 00% =	99% + 00%
50% +	99% +	00% +
DREAM		
00% + 00%		
99% +		



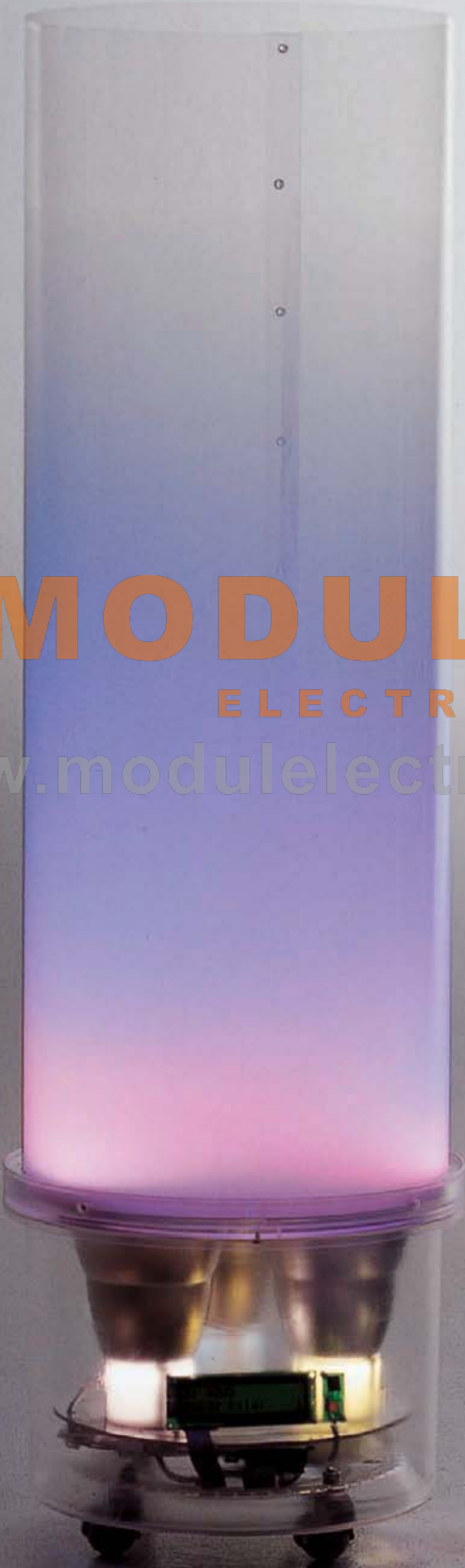

MODUL
ELECTRO
www.modulelectro.ru

Prometeo

design

Aldo Rossi
1996



Materiali: acciaio verniciato; schermi diffusori in metacrilato opalino.

Specificità: tre proiettori con i filtri dicroici rosso, verde e blu consentono di ottenere infinite atmosfere di luce colorata e un quarto proiettore produce luce bianca. Attraverso un telecomando è possibile selezionare 12 atmosfere standard, crearne e memorizzarne ulteriori 86 e agire sull'intensità luminosa.

Light emission



Colour



Materials

Matt laquered steel; diffuser screens in opaline methacrylate.

Specification

Three projectors with dichroic filters red, green and blue, allow to create a wide range of light coloured atmospheres and a fourth projector produces white light. It is possible, using a remote control, to select 12 standard atmospheres, to create and memorise other 86 and to adjust the light intensity.

Matériaux

Acier verni mat ; écrans diffuseurs en métacrylate opalin.

Spécificité

Trois projecteurs avec filtres dichroïques rouge, vert et bleu permettent d'obtenir de nombreuses atmosphères colorées ; un quatrième projecteur produit la lumière blanche. A l'aide de la télécommande, il est possible de sélectionner 12 atmosphères standard, d'en créer et d'en mémoriser 86 autres et d'agir sur l'intensité lumineuse.

Materialien

Mattlackierter Stahl; Lichtfenster aus opalem Metakrylat.

Spezifikation

Drei Strahler mit dichroitischem Filter in den Grundfarben Rot, Blau und Grün, erschaffen unzählige farbige Lichtstimmungen, Über ein viertes Element wird Weißlicht erzeugt. Diese Lichtstimmungen sind über eine Fernbedienung abrufbar (12 Standardlichtstimmungen, 86 Einstellungen bzgl. der Lichtintensität).

Materiales

Acero pintado opaco; pantallas difusores de metacrilato opalino.

Especificaciones

Tres proyectores con filtros dicroicos, rojo, verde y azul permiten obtener infinitas atmósferas de luz coloradas y el cuarto proyector produce luz blanca. Mediante un mando a distancia es posible manejar 12 atmósferas standard, crear y memorizar otras 86 y actuar en la intensidad luminosa.

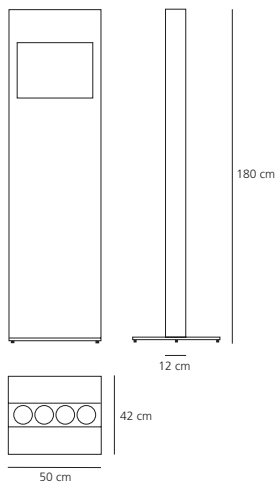

Indirect emission:
HALO max 4x100W (B 15d) – ECO, +  Dimmer included

Diffused emission:
FLUO 1x36W (2 G 11) – TC-L, included

IP20   



Infrared remote control (included)



Iride

design
Pierluigi Nicolin
1996



Materiali: diffusori in metacrilato trasparente; basi in acciaio con contrappesi in ferro.
Specificità: tre proiettori con i filtri dicroici rosso, verde e blu consentono di ottenere infinite atmosfere di luce colorata e un quarto proiettore produce luce bianca. Attraverso un telecomando è possibile selezionare 12 atmosfere standard, crearne e memorizzarne ulteriori 86 e agire sull'intensità luminosa.

Light emission



Colours

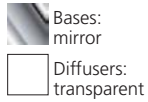

Materials

Diffusers in transparent methacrylate; steel bases with iron counterweights.

Specification

Three projectors with dichroic filters red, green and blue, allow to create a wide range of light coloured atmospheres and a fourth projector produces white light. It is possible, using a remote control, to select 12 standard atmospheres, to create and memorise other 86 and to adjust the light intensity.

Matériaux

Diffuseurs en méthacrylate transparent, bases en acier avec contrepoids en fer.

Spécificité

Trois projecteurs avec filtres dichroïques rouge, vert et bleu permettent d'obtenir de nombreuses atmosphères colorées ; un quatrième projecteur produit la lumière blanche. A l'aide de la télécommande, il est possible de sélectionner 12 atmosphères standard, d'en créer et d'en mémoriser 86 autres et d'agir sur l'intensité lumineuse.

Materialien

Schirme aus transparentem Metakrylat, Sockel aus Stahl mit Gegengewicht.

Spezifikation

Drei Strahler mit dichroitischem Filter in den Grundfarben Rot, Blau und Grün, erschaffen unzählige farbige Lichtstimmungen, Über ein viertes Element wird Weißlicht erzeugt. Diese Lichtstimmungen sind über eine Fernbedienung abrufbar (12 Standardlichtstimmungen, 86 Einstellungen bzgl. der Lichtintensität).

Materiales

Difusores de metacrilato transparente; bases de acero con contrapesos de hierro.

Especificaciones

Tres proyectores con filtros dicroicos, rojo, verde y azul permiten obtener infinitas atmósferas de luz coloradas y el cuarto proyector produce luz blanca. Mediante un mando a distancia es posible manejar 12 atmósferas standard, crear y memorizar otras 86 y actuar en la intensidad luminosa.

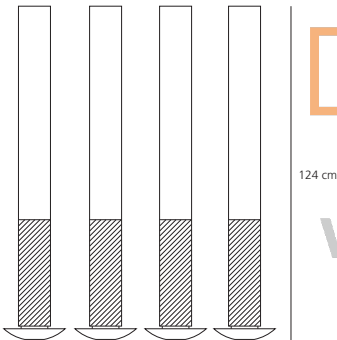

ø 13 cm



ø 23 cm

HALO max 4x100W (B 15d) – ECO, included

IP20 + Dimmer



Infrared remote control (included)

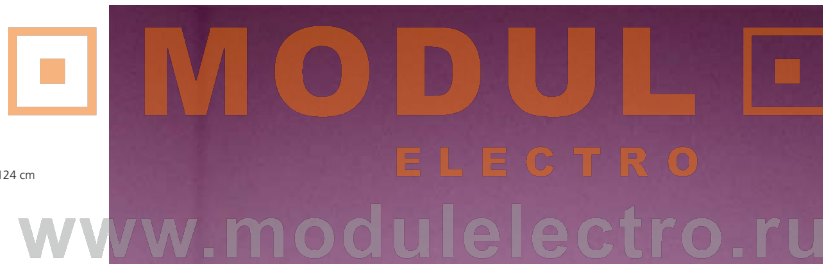

Castore terra 35
Castore terra 42

design
Michele De Lucchi
Huub Ubbens
2003



Awards

Design Plus, light + building
2004 – Frankfurt am Main (Deutschland)
Reddot Design Award
2004 – Essen (Deutschland)
Compasso d'Oro / A.D.I. – Segnalazione
2004 – Milano (Italia)

Light emission



Colour



White

Materiali: base in zama; stelo in resina termoplastica; diffusore in vetro soffiato.
Specificità: un tasto d'accensione touch, presente sullo stelo, permette la regolazione dell'intensità luminosa, la memorizzazione dell'ultimo livello di luce impostato e la possibilità di scegliere tra comando locale e comando remoto (presa comandata).

Materials

Base in zamac, stem in thermoplastic resin, blown glass diffuser.

Specification

A touch dimmer button on the stem for the storage of the last set light intensity set-up or the use of a local or remote control.

Matériaux

Base en zamac, tige en résine thermoplastique, diffuseur en verre soufflé.

Spécificité

Castore 35 et 42 sont dotés d'un variateur sensible, situé sur la tige pour la mémorisation du dernier niveau d'intensité lumineuse établi et la possibilité de choisir entre la commande déportée (interrupteur) ou directement sur le luminaire.

Materialien

Fuß aus Zamak, Stab aus thermoplastischem Harz, Schirm aus mundgeblasenem Glas.

Spezifikation

Ein Touch Dimmer am Stab der Leuchte ermöglicht die Regelung und die Speicherung der Lichtintensität und bietet außerdem die Möglichkeit, zwischen Hand- und Fernbedienung zu wählen (Steckdosenschalter).

Materiales

Base en zamac, tija en resina termoplástica, difusor en cristal soplado.

Especificaciones

Una tecla que enciende por contacto y que se encuentra en el cuerpo, permite la regulación de la intensidad luminosa y la memorización del último nivel de intensidad configurado y la posibilidad de elegir entre mando exclusivamente local y mando a distancia (toma accionada).

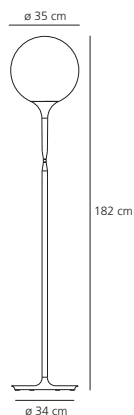

Castore terra 35

HALO max 1x150W (E 27) – ECO

IP20 + Touch Dimmer

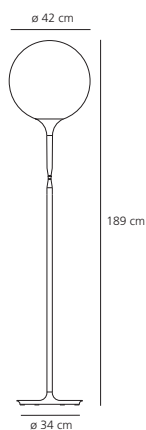

Castore terra 42

HALO max 1x205W (E 27) – ECO

IP20 + Touch Dimmer



Touch dimmer

Functions:
1. Memo
2. Reset





MODUL
ELECTRO
www.modul-electro.ru

Soffione terra

design

Michele De Lucchi
Alberto Nason
2008



Materiali: base in alluminio pressofuso, stelo in acciaio, diffusore in vetro soffiato opalino.

Light emission



Colours

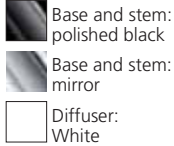

Materials

Base in die-cast aluminium, steel stem, opaline blown glass diffuser.

Matériaux

Base en aluminium moulé sous pression, tige en acier, diffuseur en verre soufflé opalin.

Materialien

Sockel aus Aluminiumdruckguss; Stab aus Stahl; Schirm aus geblasenem Opalglas.

Materiales

Pie en aluminio fundido a presión; tija en acero, difusor de cristal soplado opalino.

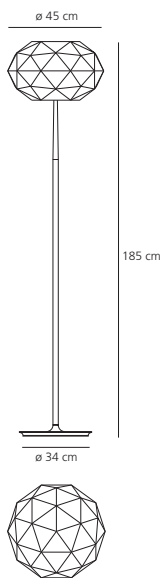

HALO max 1x205W (E 27) - ES

IP20 + Touch Dimmer

FLUO 1x42W (GX 24 q-4) - TC-DEL

IP20



Soffione terra polished black finishing

Soffione terra mirror finishing

Logico terra

design

Michele De Lucchi
Gerhard Reichert
2001



Awards

Design Innovationen Design Zentrum
Nordrhein Westfalen
Reddot Design Award
2002 – Essen (Deutschland)

Materiali: struttura in metallo verniciato; diffusore in vetro soffiato con finitura seta lucida.

Specificità: un tasto d'accensione touch permette la regolazione dell'intensità luminosa

Light emission



Colours

Base and stem:
silver grey
Diffuser:
white

Materials

Painted metal structure,
blown glass diffuser with
polished-silk finish.

Specification

Logico terra has a touch
dimmer to adjust the light
intensity.

Matériaux

Structure en métal verni ;
diffuseur en verre soufflé,
finition soie brillante.

Spécificité

Logico terra est doté d'un
variateur sensible, pour agir
sur l'intensité lumineuse.

Materialien

Rahmen aus lackiertem Metall;
Schirm aus geblasenem Glas in
seidig glänzendem Finish.

Spezifikation

Ein Touch Dimmer ermöglicht
die Einstellung verschieden-
ster Lichtintensitäten.

Materiales

Estructura de metal pintado;
difusor de cristal soplado con
acabado de seda brillante.

Especificaciones

Una tecla que enciende por
contacto permite la regulación
de la intensidad luminosa.

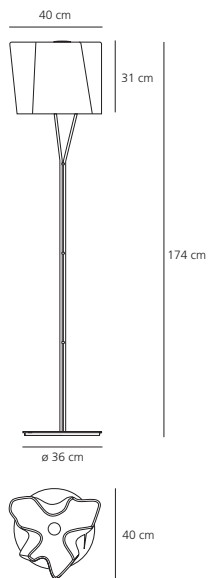

MODUL
ELECTRO
www.modulelectro.ru

HALO max 3x70W (E 27) – ES

IP20 + Touch Dimmer



Light off



Light on



Miconos terra

design

Ernesto Gismondi
1999



Materiali: base e stelo in metallo cromato lucido; diffusore in vetro soffiato trasparente.

Light emission



Colours



Base and stem:
mirror



Diffuser:
trasparent

Materials

Base and stem in polished
chromed metal, diffuser in
transparent blown glass.

Matériaux

Base et tige en métal chromé
brillant, diffuseur en verre
soufflé transparent.

Materialien

Sockel und Stab aus polier-
tem und verchromtem Metall,
Schirm aus klarem, munde-
blasenem Glas.

Materiales

Base y vástago, de metal
cromado brillante; difusor en
cristal soplado transparente.

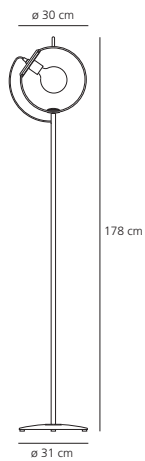

FLUO 1x23W (E 27) – globe ø 12 cm



MODUL
ELECTRO
www.modulelectro.ru



Acquarelli

design

Studio Original Design
1983



Materiali: base e stelo in metallo nichelato opaco; diffusore in vetro soffiato opalino.

Light emission



Colours

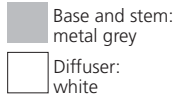

Materials

Base and stem in metal with nickel matt finish; diffuser in opal blown glass.

Matériaux

Base et tige en métal finition nickel mat ; diffuseur en verre soufflé opalin.

Materialien

Sockel und Stab aus matt-vernickeltem Metall; Schirm aus mundgeblasenem Opalglas.

Materiales

Base y tija en metal niquelado opaco, difusor en cristal soplado opalino.

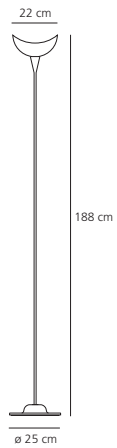

HALO max 1x205W (B 15d) – ECO, included

IP20     +  Dimmer

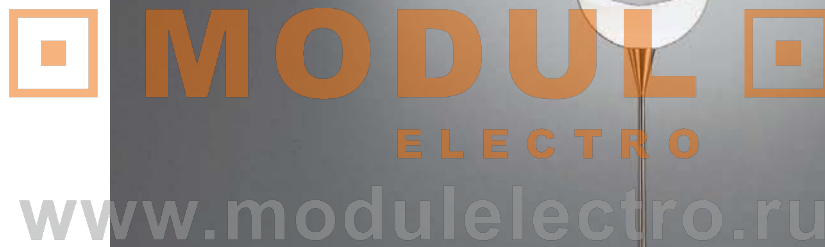
www.modulelectro.ru



Acheo terra

design

Gianfranco Frattini
1989



202 202

Awards

Compasso d'Oro / A.D.I. – Segnalazione
1991 – Milano (Italia)

Materiali: base e stelo in acciaio verniciato; diffusore in vetro borosilicato con supporto in alluminio cromato. Stabilità dello stelo garantita da tre cavi tenditori in acciaio fissati alla base con terminali estensibili.

Light emission



Colours



Base and stem:
dark grey



Diffuser:
trasparent

Materials

Base and stem in painted steel; diffuser in borosilicate glass with chromed aluminium support. Three steel tension cables fixed to the base with adjustable clamps guarantee the stem's stability.

Matériaux

Base et tige en acier verni ; diffuseur en verre borosilicate avec support en aluminium chromé. La stabilité de la tige est assurée par trois câbles en acier fixés à la base.

Materialien

Sockel und Stab aus lackiertem Stahl; Schirm aus Borosilikatglas mit Halterung aus verchromtem Aluminium. Die Stabilität des Leuchtenstabes wird durch drei Stahlzüge erzeugt, die über verstellbare Endstücke am Fußteil der Leuchte befestigt sind.

Materiales

Pie y vástago de acero pintado; difusor de vidrio borosilicado, con soporte de aluminio cromado. La estabilidad del vástago se obtiene merced a tres cables tensores de acero, que están sujetos al pie mediante terminales extensibles.

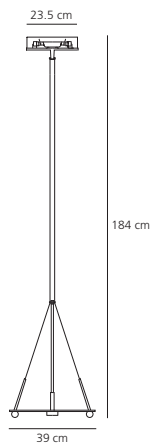

HALO max 1x230W (R7s) – ES, included

IP20      +  Dimmer

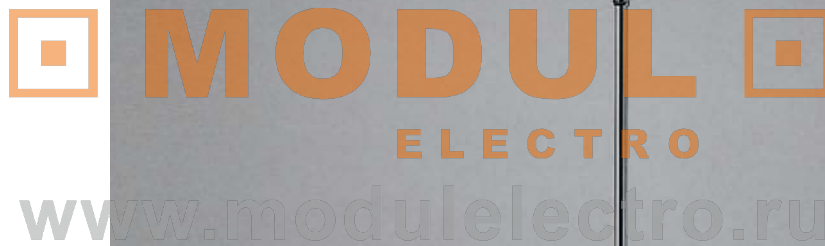
www.modulelectro.ru

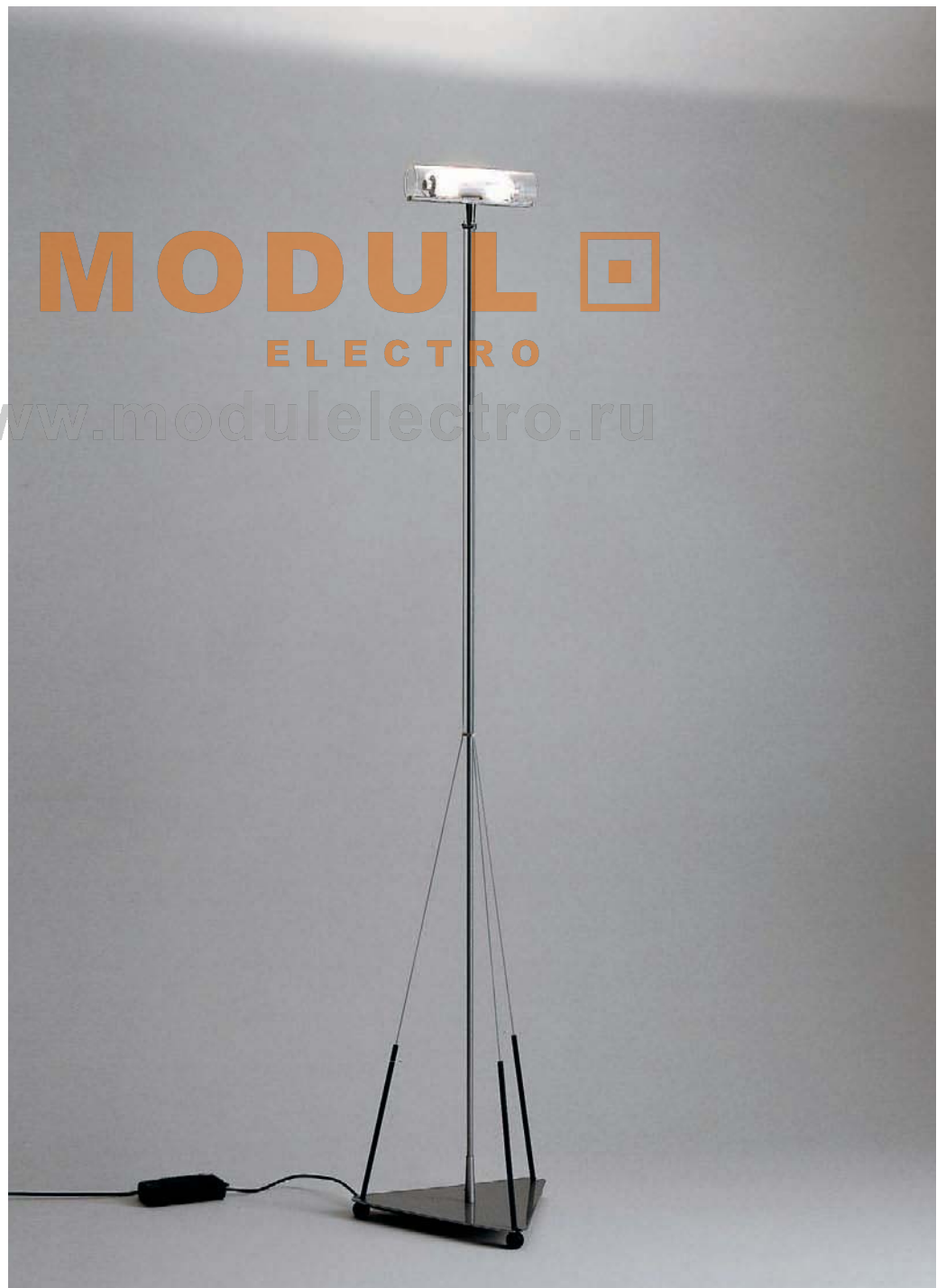

Tebe terra

design

Ernesto Gismondi
1989



Awards

Design Auswahl '90
1990 – Stuttgart (Deutschland)

Materiali: base e stelo in alluminio verniciato o in metallo nichelato opaco; diffusore in vetro sabbato.

Light emission



Colours

■ Base and stem:
grey

■ Base and stem:
metal grey

□ Diffuser:
white

Materials

Base and stem in painted
aluminium or in nickel matt
metal; sanded glass diffuser.

Matériaux

Base et tige en aluminium
verni ou en métal nickel mat ;
diffuseur en verre sablé.

Materialien

Sockel und Stab aus
lackiertem Aluminium oder
in matt-vernicheltem Metall;
Schirm aus sandgestrahltem
Glas.

Materiales

Pie y vástago de aluminio
pintado o de metal nique-
lado mate; difusor en cristal
arenado.

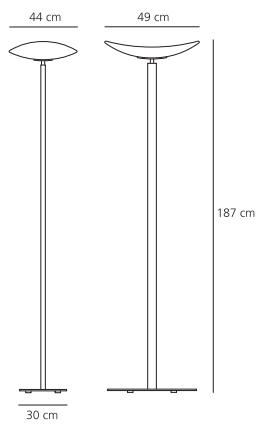

HALO max 1x230W (R7s) – ES, included

IP20 □ F + Dimmer

MODULO **ELECTRO**

www.modulelectro.ru



Montjuic

design
Santiago Calatrava
1990



Materiali: struttura in resina poliuretana espansa verniciata; diffusore in metacrilato opalino bianco.

Light emission



Colours

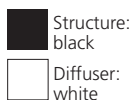

Structure:
black

Diffuser:
white

Materials

Structure in painted foamed polyurethane; white opaline methacrylate diffuser.

Matériaux

Structure en résine polyuréthane expansé vernie ; diffuseur en méthacrylate opalin blanc.

Materialien

Struktur aus lackiertem Polyurethanharz; Schirm aus opalweißem Metakrylat.

Materiales

Estructura de resina de poliuretano rígido; difusor en metacrilato opalino blanco.

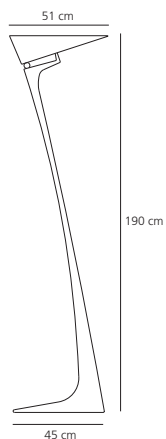

HALO max 1x400W (R7s) –ES, included

IP20 + Dimmer

MODULO
ELECTRO
www.modulelectro.ru



Zen terra

design

Ernesto Gismondi
1988



Awards

Design Innovationen
Design Zentrum Nordrhein Westfalen
1989 – Essen (Deutschland)

Materiali: base in metallo verniciato; stelo in alluminio verniciato; diffusori in alluminio anodizzato.

Specificità: due diffusori: uno superiore, orientabile sull'asse orizzontale, per un'illuminazione generale, e uno inferiore per un'illuminazione più circoscritta.

Light emission



Colours

Base and stem:
black
Diffusers:
metal grey

Materials

Painted metal base, stem in painted aluminium, diffusers in anodised aluminium.

Specification

Lamp with two diffusers: the upper one is adjustable on horizontal axis for ambient lighting, the lower one gives more directional light.

Matériaux

Base en métal verni ; tige en aluminium verni ; diffuseurs en aluminium anodisé.

Spécificité

Lampadaire avec deux diffuseurs: l'un vers le haut, orientable sur l'axe horizontal, pour un éclairage général, l'autre vers le bas pour un éclairage ponctuel.

Materialien

Sockel aus lackiertem Metall; Stab aus lackiertem Aluminium; Reflektorschale aus eloxiertem Aluminium.

Spezifikation

Stehleuchte mit zwei Lichtquellen: die obere horizontal verstellbar für die Grundbeleuchtung, die untere für eine Akzentbeleuchtung.

Materiales

Base en metal pintado; tija en aluminio pintado y difusores de aluminio anodizado.

Especificaciones

Lámpara de pie con dos difusores: con el superior se obtiene una iluminación general; con el inferior, una iluminación más circunscrita.

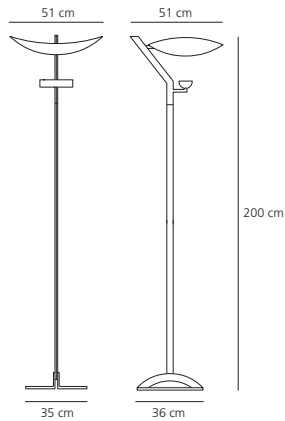

HALO max 1x400W (R7s) – ES, included +  Dimmer
HALO max 1x160W (R7s) – ES, included

IP20    

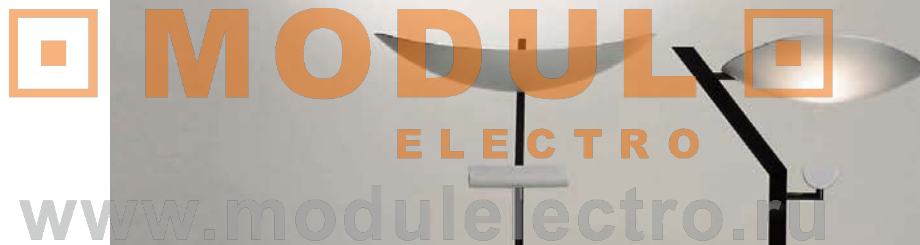
www.modulelectro.ru



Lampade da parete

Wall lamps / Appliques / Wandleuchten / Appliques



121
Droplet mini
parete/soffitto



128
Cosmic Angel parete



132
Space Oddity



135
Eurialo



136
Talo parete



138
Talo parete 90
120, 150, 180, 240



139
Cabildo parete



140
Mesmeri



142
Titius 26, 40, 70



143
Astarte



148
Go to the mirror



150
Altrove parete/
soffitto



152
Rothko



156
my White Light kit



157
Metamorfosi kit 3,
kit 4



160
Tolomeo parete
mini, micro



160
Tolomeo braccio



162
Tolomeo faretto,
micro



163
Tolomeo pinza,
micro



164
Tolomeo parete
diffusore 18, 24, 32



166
Tolomeo basculante
parete



167
Tolomeo Mega
parete



169
Melampo parete



170
Choose parete



170
Choose Led
parete + Led
incasso Led



172
Cadmo parete



174
Talak parete,
Led



175
Pipe parete/soffitto



176
Edge
parete/soffitto 21, 30



177
Teti



179
Telefo 50, 70, 120,
170, 72 vetro Murano



180
Dioscuri
parete/soffitto
14, 25, 35, 42



182
Soffione
parete/soffitto 36, 45



188
Logico parete,
mini, micro



188
Logico parete in
linea, mini, micro



190
Logico parete
mini full



191
Miconos parete



192
Frost



193
Robbia 30, 60



194
Canne



195
Sagitta



196
Onfale parete 28, 36,
28 vetro chiuso



197
Tilos 150, 200



198
Kalias 110, 200



198
Deltakalias



198
Trikalias



198
Pentakalias



200
Utopia parete/soffitto
32, 42, 52



201
Zsu-zsu parete/soffitto
55, 65



202
Acheo parete



203
Icaro

MODULO
ELECTRO
www.modulelectro.ru

Lampade da soffitto

Ceiling lamps / Plafonniers / Deckenleuchten / Pláfonos

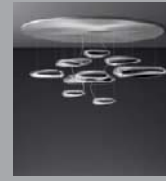

116
Mercury soffitto



118
Mercury Cluster



120
Droplet soffitto



121
Droplet mini parete/soffitto



122
Skydro



124
Cosmic Leaf soffitto



124
Cosmic Leaf incasso, mini incasso



126
Cosmic Ocean



130
Cosmic Angel soffitto



134
Aqua Cil soffitto



144
Nur soffitto, mini



145
Nur Gloss soffitto, mini Gloss



146
Float soffitto circolare



146
Float soffitto lineare



149
Lara



150
Altrove parete/soffitto



154
Pozzo

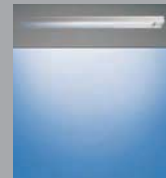

156
My White Light kit



157
Metamorfosi kit 3, kit 4



168
Alicudi



175
Pipe parete/soffitto



176
Edge parete/soffitto 21, 30



177
Teti



178
Zeffiro 140, 80



180
Dioscuri parete/soffitto 14, 25, 35, 42



182
Soffione parete/soffitto 36, 45



184
Logico soffitto mini, micro, nano



184
Logico soffitto in linea mini, micro



184
Logico soffitto 3X120°, mini, micro



184
Logico soffitto 4X90°, mini, micro



191
Miconos soffitto



197
Tilos 150, 200



197
Tilos 150 incasso



198
Kalias 110, 200



198
Deltakalias



198
Trikalias



198
Pentakalias



200
Utopia parete/soffitto 32, 42, 52



201
Zsu-zsu parete/soffitto 55, 65

MODULO ELECTRO
www.modulelectro.ru

Mercury soffitto

design

Ross Lovegrove
2007



Awards

Good Design Award
The Chicago Athenaeum
2008 – Chicago (US)

Materiale: corpi luminosi in alluminio pressofuso; corpi riflettenti in materiale termoplastico stampato ad iniezione con finitura metallizzata; riflettore in alluminio stampato.

Light emission



Colours



Reflector:
metal grey

Units:
mirror

Materials

Die-cast aluminium lighting units; reflective units made of injection-moulded thermo-plastic material with metallic finish; die-cast aluminium reflector.

Matériaux

Corps en aluminium moulé sous pression; galets réfléchissants en matière thermo-plastique finition métallisée; réflecteur en aluminium moulé.

Materialien

Leuchtenkörper aus druckgegossenem Aluminium; reflektierende Körper aus Spritzguss-Thermoplast mit Metallic-Oberfläche, Reflektor aus formgestanztem Aluminium.

Materiales

Cuerpos luminosos en aluminio fundido a presión; cuerpos reflectantes en material termoplástico moldeado por inyección, con acabado metalizado; reflector en aluminio moldeado.

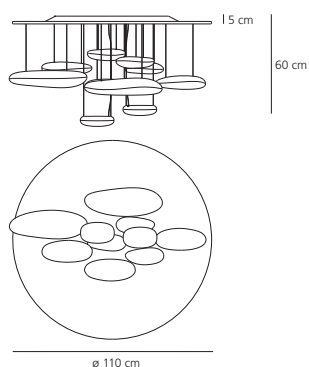

HALO max 2x160W (R7s) – ES, included



MODULO
ELECTRO
www.modul-electro.ru

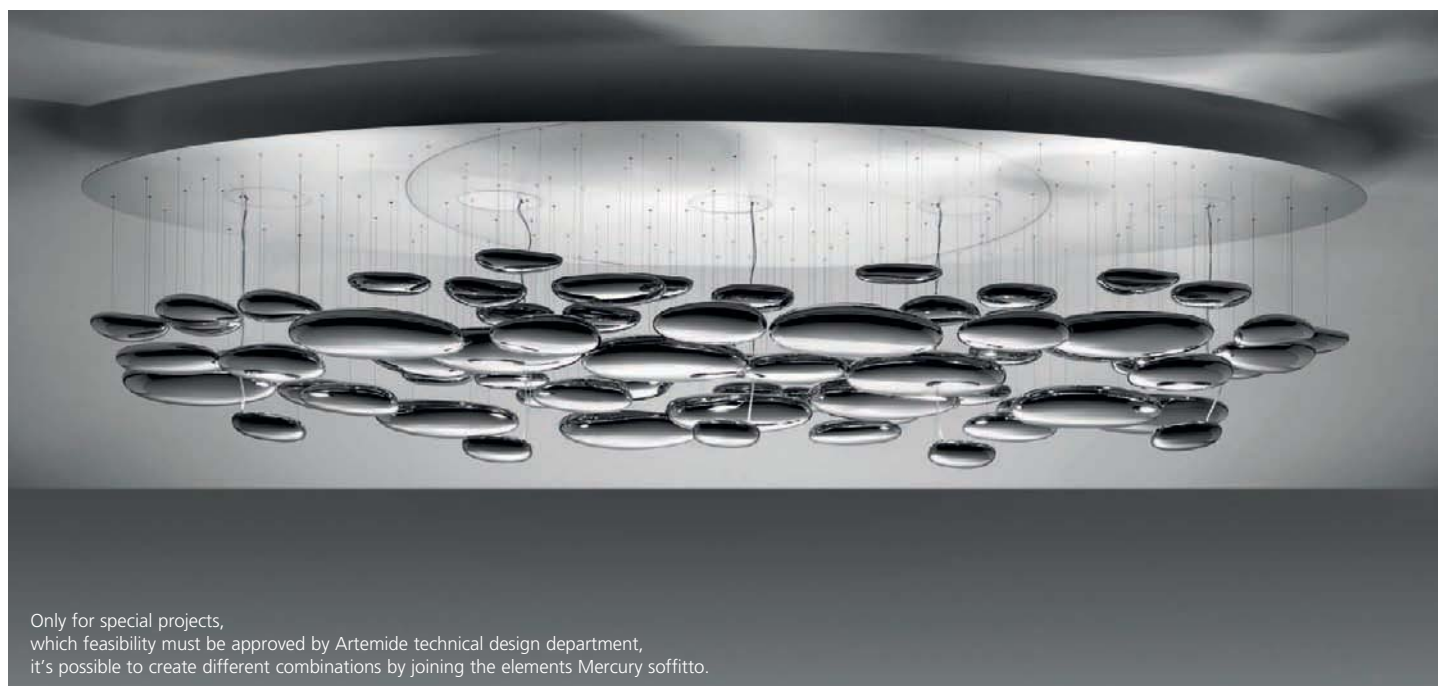

Only for special projects, which feasibility must be approved by Artemide technical design department, it's possible to create different combinations by joining the elements Mercury soffitto.



 **MODUL** 

ELECTRO

www.modulelectro.ru

Materiali: corpi luminosi in alluminio pressofuso; corpi riflettenti in materiale termoplastico stampato ad iniezione con finitura metallizzata; riflettore in alluminio stampato.

Specificità: Mercury Cluster è un sistema componibile a luce indiretta che permette numerose aggregazioni. Fornito come progetto speciale, è disponibile con sorgenti alogene o a ioduri metallici. È inoltre possibile realizzare configurazioni in cui la luce indiretta proviene da uno o più proiettori a parete esterni.

Light emission



Colours

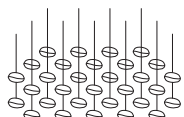
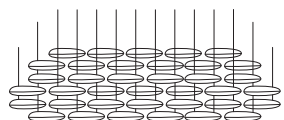
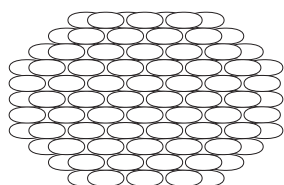

Materials

Die-cast aluminium lighting units; reflective units made of injection-moulded thermoplastic material with metallic finish; die-cast aluminium reflector.

Specification

Mercury Cluster is an indirect light modulary system, with which it's possible to obtain numerous range of configurations. It's supplied as special project, and it's available both with halogen and metal halide sources. It's possible to realize configurations in which the indirect light comes from one or more wall projectors that are separated from the lamp.

Matériaux

Corps en aluminium moulé sous pression. Corps réfléchissants en matière thermoplastique finition métallisée. Réflecteur en aluminium moulé.

Spécificité

Mercury Cluster est un système modulaire d'éclairage indirect permettant d'obtenir de nombreuses configurations. Produit spécial à définir pour tout projet et disponible avec sources halogènes ou iodures métalliques. Il est possible de réaliser des compositions dans lesquelles la lumière indirecte provient de un ou plusieurs projecteurs muraux (vendu séparément).

Materialien

Gehäuse aus Aluminium-druckguss; reflektierende Körper aus Spritzguss-Thermoplast mit Metallic-Oberfläche; Reflektor aus formgestanztem Aluminium.

Spezifikation

Mercury Cluster ist ein modulares System, das eine Vielzahl von Lichtkonfigurationen mit indirekter Beleuchtung ermöglicht. Erhältlich als Sonderleuchte mit Halogen- oder Metaldampf Lampe. Die indirekte Beleuchtung kann auch durch den Einsatz eines externen Strahlers erzeugt werden.

Materiales

Cuerpo luminoso en aluminio fundido a presión; cuerpos reflectantes en material termoplástico moldeado por inyección, con acabado metalizado; reflector en aluminio moldeado.

Especificaciones

Mercury Cluster es un sistema componible de luz indirecta que permite obtener numerosos tipos de configuración. Suministrado como proyecto especial, está disponible con bombillas halógenas o de yoduros metálicos. Así mismo es posibles realizar configuraciones en las que la luz indirecta proviene de uno o más proyectores separados de la lámpara.



www.modulelectro.ru

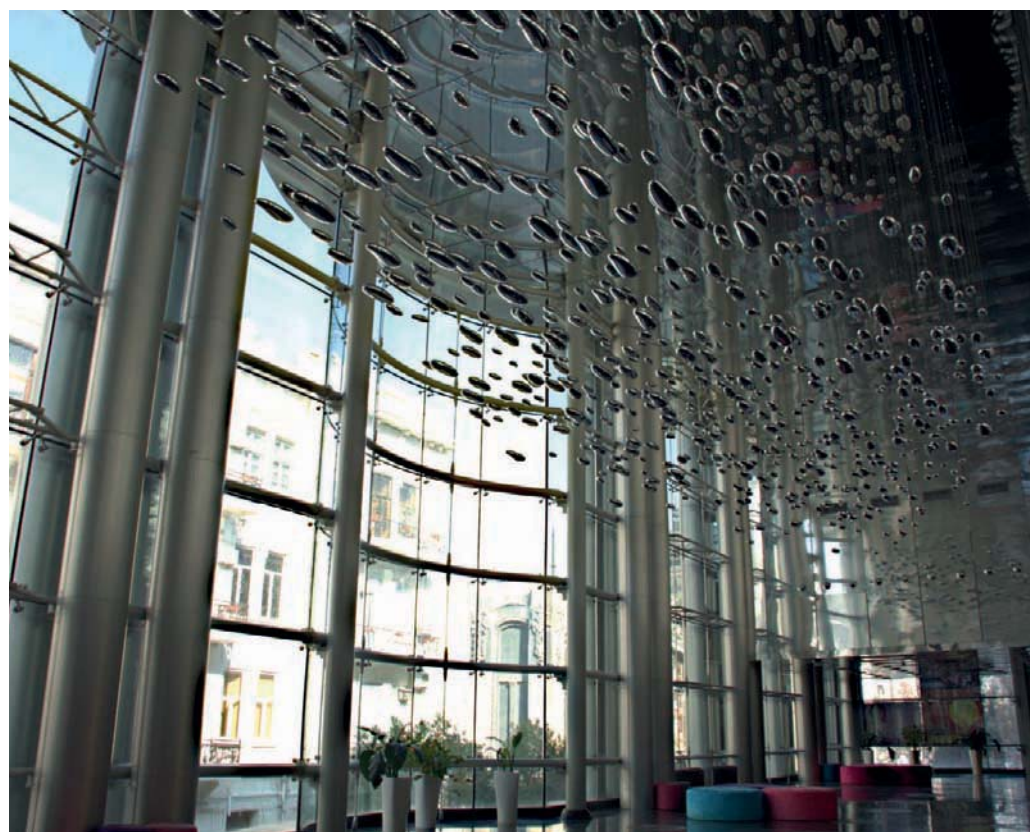

Only for special projects which feasibility must be approved by Artemide technical design department it's possible to create different combinations by joining the elements Mercury Cluster.



MODULO
ELECTRO

www.modulelectro.ru

Droplet soffitto

design

Ross Lovegrove
2007



121 208

Materiali: corpi luminosi in alluminio pressofuso; riflettore in alluminio stampato e verniciato.

Light emission



Colours

Reflector:
aluminium grey

Units:
mirror

Materials

Die-cast aluminium lighting
units; painted die-cast alu-
minium reflector.

Matériaux

Corps lumineux en aluminium
moulé sous pression.
Réflecteur en aluminium moulé
et verni.

Materialien

Leuchtenkörper aus druck-
gegossenem Aluminium;
Reflektor aus formgestanztem
Aluminium.

Materiales

Cuerpos luminosos en aluminio
fundido a presión; reflector
en aluminio moldeado y
pintado.

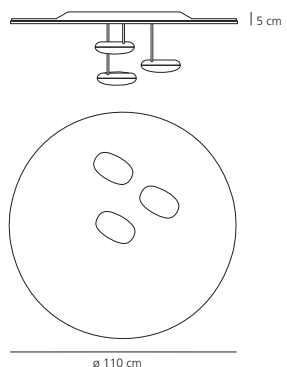

HALO max 3x160W (R7s) – ES, included

IP20 



MODUL



ELECTRO

www.modulelectro.ru



Droplet mini parete/soffitto

design

Ross Lovegrove
2009



Materiali: corpo luminoso in alluminio pressofuso; riflettore in alluminio stampato e verniciato.

Light emission



Colours

Reflector:
aluminium grey

Units:
mirror

Materials

Die-cast aluminium lighting unit; painted die-cast aluminium reflector.

Matériaux

Corps lumineux en aluminium moulé sous pression.
Réflecteur en aluminium moulé et verni.

Materialien

Leuchtenkörper aus druckgegossenem Aluminium;
Reflektor aus formgestanztem Aluminium.

Materiales

Cuerpos luminosos en aluminio fundido a presión; reflector en aluminio moldeado y pintado.

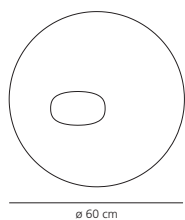
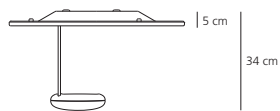

HALO max 1x160W (R7s) - ES, included



METAL HALIDE 1x70W (G 8,5) - HIT
Electronic ballast



MODUL
ELECTRO
www.modulelectro.ru

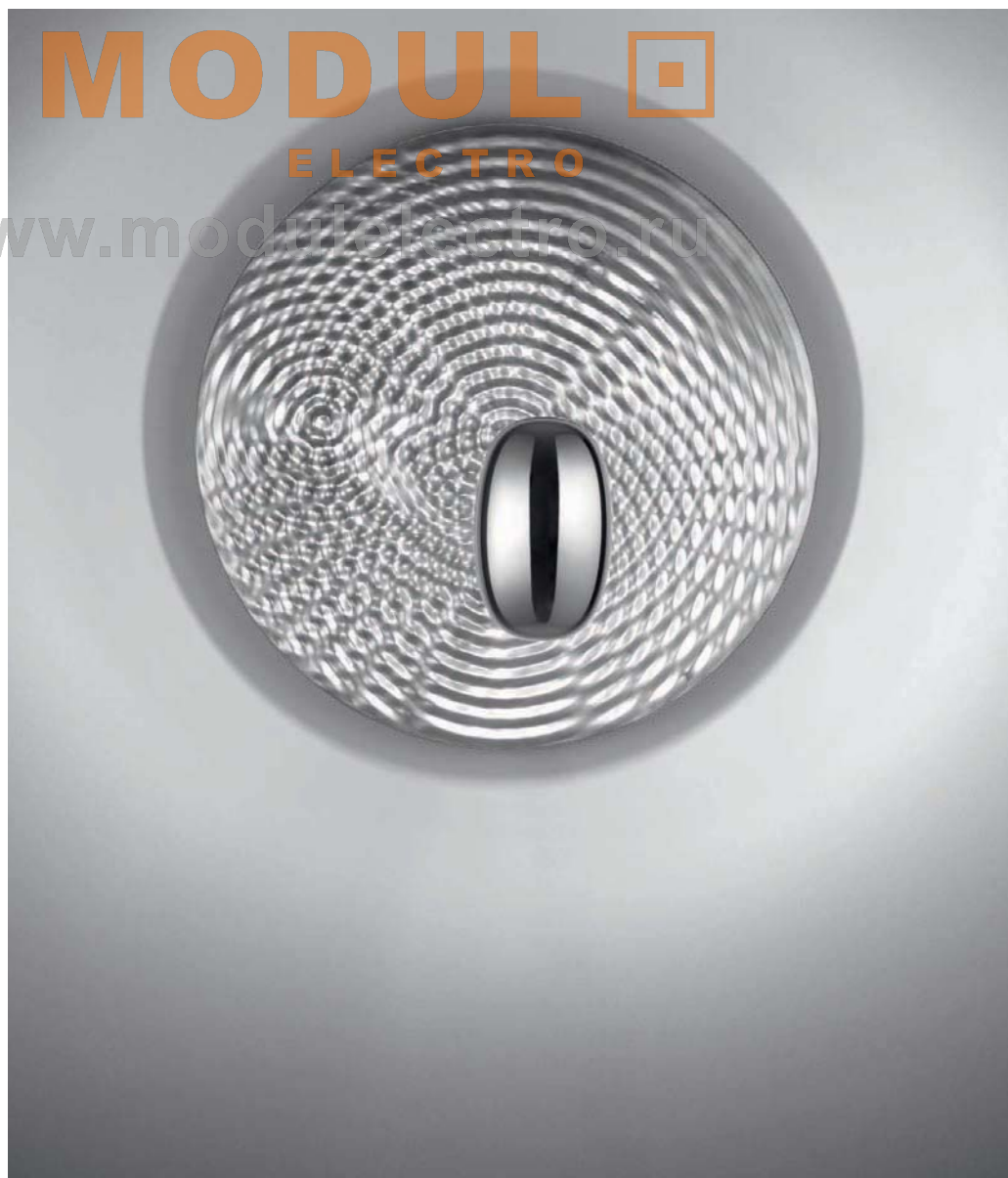

Skydro

design
Ross Lovegrove
2007



Light emission



Colour



Mirror

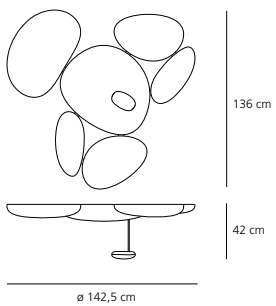
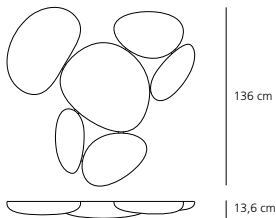

Materials

Abs injection-moulded reflective units; lighting unit in die cast aluminium; painted steel bearing structure.

Specification

Skydro is available with or without the integrated lighting unit; available in halogen source or metal halide versions. Thanks to the modularity of the system, it is possible to obtain a numerous range of configurations, simply adding extra units. To assemble the multiple units it needs - in addition to the basic units (with or without light source) - an assembly kit (template) and cable kits for the electrical connection.

Matériaux

Unités réfléchissantes en Abs moulé, unité d'éclairage en fonte d'aluminium, structure porteuse en acier peint.

Spécificité

Skydro est disponible avec ou sans source lumineuse, en version halogènes ou iodures métalliques. Compte tenu de la modularité du système, il est possible d'obtenir de nombreuses configurations, en ajoutant simplement des éléments. Pour l'installation d'unités multiples, un kit d'assemblage est nécessaire (gabarit), des kits de câblage pour la connexion électrique, ainsi que des unités de base (avec ou sans source lumineuse).

Materialien

Reflektierende Körper aus Spritzgussthermoplast; Reflektor aus formgestanztem Aluminium; Struktur aus lackiertem Stahl.

Spezifikation

Skydro ist mit integriertem Leuchtmittel oder externem Strahler erhältlich. Wahlweise mit Halogen- oder Metaldampfampe. Die modulare Struktur ermöglicht die Kombination mehrerer Skydro-Elemente. Hierdurch entstehen beliebig große Konfigurationen. Zur Verkabelung mehrerer Einheiten ist ein elektronischer Verbinder sowie ein Montage-Kit erforderlich.

Materiales

Cuerpo reflexivo en ABS estampado a inyección, cuerpo iluminante en presofusión de aluminio, estructura portante en acero pintado.

Especificaciones

Skydro está disponible en dos versiones: con o sin cuerpo luminoso integrado. Gracias a la composición del sistema, agregando los módulos se pueden obtener numerosas configuraciones. Para el montaje de configuraciones múltiples son necesarios- más allá de los módulos base (con o sin fuente de luz) - un kit de montaje - dima - y un kit de cables para la conexión eléctrica.

HALO max 1x160W (R7s) - ES, included

IP20

METAL HALIDE 1x70W (G 8,5) - HIT

IP20

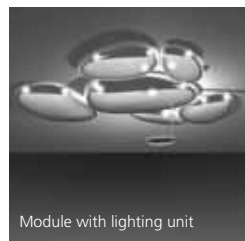

Module with lighting unit

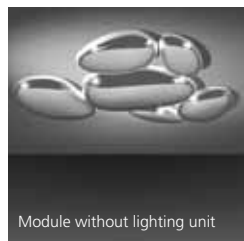

Module without lighting unit

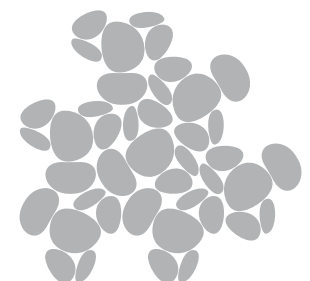
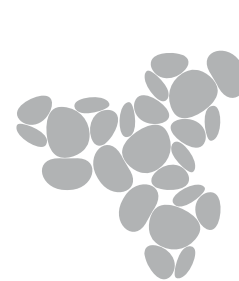
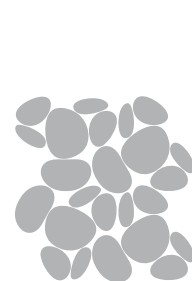
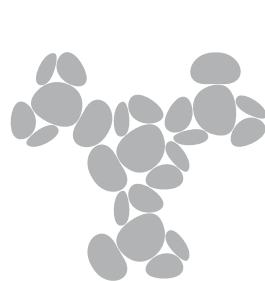
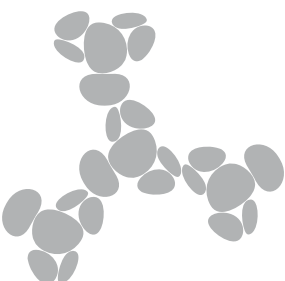
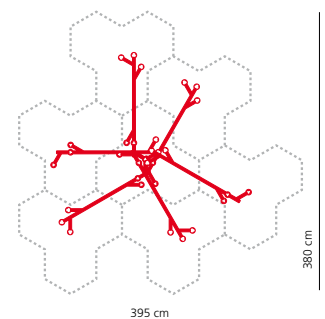
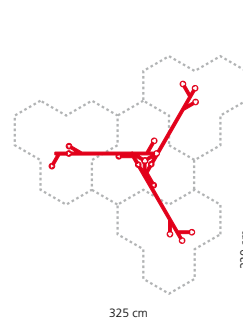
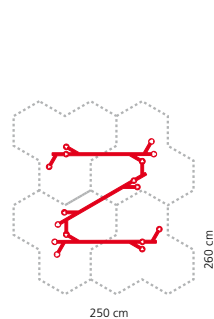
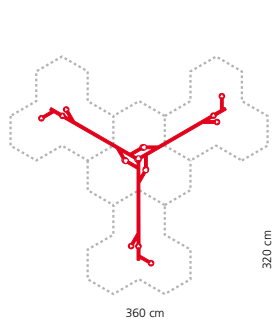
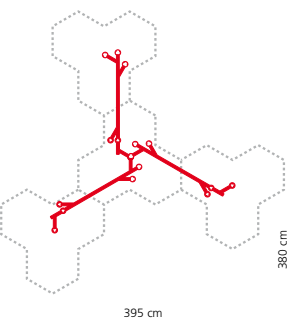
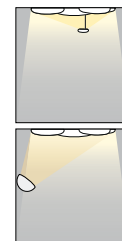



MODUL

ELECTRO

www.modulelectro.ru

Cosmic Leaf soffitto
Cosmic Leaf incasso
Cosmic Leaf mini incasso

design
 Ross Lovegrove
 2009



Materiali: struttura in acciaio cromato; corpo lampada-diffusore in metacrilato trasparente texturizzato; corpo illuminante in metallo verniciato.

Light emission



Colours

Diffuser:
 transparent
 Lighting unit:
 grey

Materials

Chromed steel structure;
 body lamp-diffuser in
 transparent methacrylate
 with texture; painted metal
 lighting unit.

Matériaux

Structure en acier chromé ;
 corps diffuseur en méthacry-
 late transparent tissé ; corps
 lumineux en métal peint.

Materialien

Gestell aus verchromten
 Stahl, Leuchtenkörper aus
 transparentem, strukturiertem
 Metacrylat; Beleuchtungsein-
 heit aus lackiertem Metall.

Materiales

Estructura en metal cromado;
 cuerpo de la lámpara-difusor
 en metacrilato transparente
 texturizado, cuerpo luminoso
 en metal pintado.

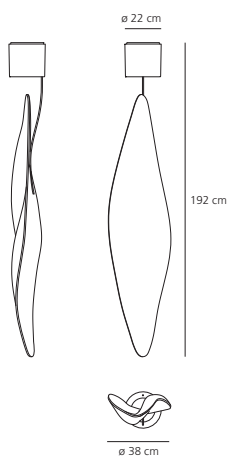

Cosmic Leaf soffitto
 HALO 1x100W (G 53) - QR-LP 111
 included

IP20

METAL HALIDE 1x70W (GX 8,5) - HIR-CE 111
 Electronic ballast

IP20

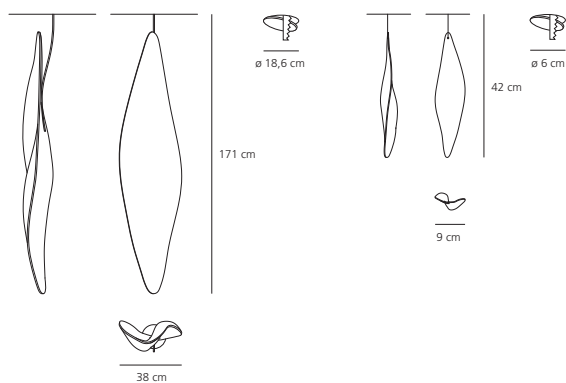

Cosmic Leaf incasso
 HALO 1x100W/12V (G 53) - QR-LP 111
 included

IP20

METAL HALIDE 1x70W (GX 8,5) - HIR-CE 111
 Electronic ballast

IP20



Cosmic Leaf Mini incasso
 LED 1x7W, included

IP20

MODULO
ELECTRO
www.modulelectro.ru

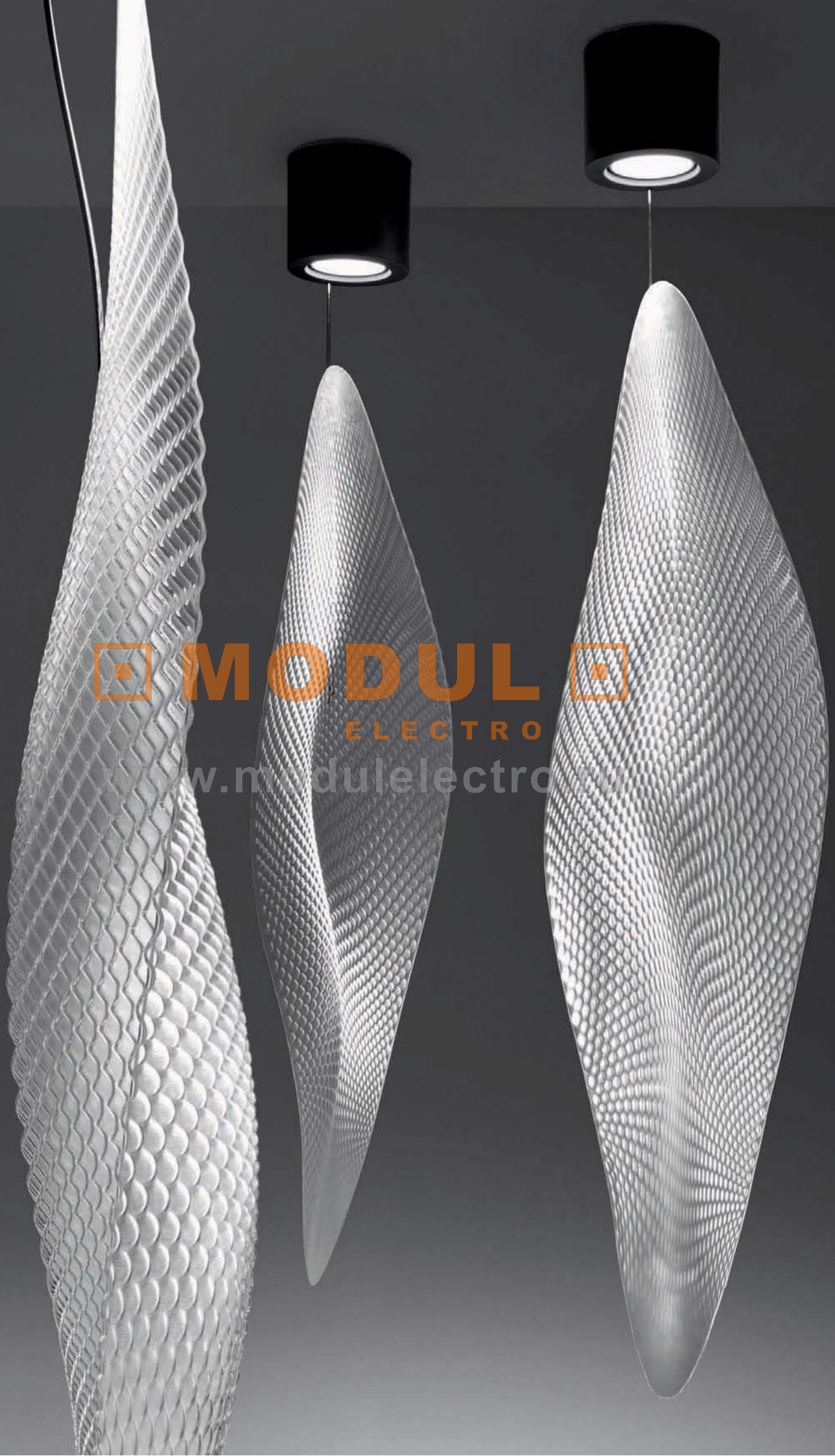



 **MODUL** 
ELECTRO
www.modulelectro.it

Cosmic Ocean

design
Ross Lovegrove
2009



Materiali: cielino in alluminio a specchio; diffusori in metacrilato trasparente texturizzato.

Specificità: modulo componibile che permette numerose aggregazioni, costituito da un cielino a cui sono sospesi gli elementi diffusori. Disponibile in versione con Led integrati nel cielino e in versione in cui la luce proviene da un proiettore esterno. Fornito come progetto speciale.

Light emission



Colours



Materials

Plate in aluminium mirror finish; body lamp-diffuser in transparent methacrylate with texture.

Matériaux

Coupe en aluminium finition miroir, corps diffuseur en méthacrylate transparent tissé.

Materialien

Platte aus Aluminium mit spiegelartiger Oberfläche. Korpus und Lichtverteiler aus transparentem Metacrylat mit Gewebestruktur.

Materiales

Plafón en aluminio espejado; difusores en metacrilato transparente texturizado.

Specification

It's a sectional unit that enables elements to be added. It's provided by a plate from which the diffuser elements hang. Available in version with Led integrated in the ceiling and in version in which the light comes from a wall projector that is separate from the lamp. Supplied as special project.

Spécificité

Module unitaire permettant de nombreuses compositions. Elle prend la forme d'un plateau dans lequel les éléments diffuseurs s'accrochent. Disponible avec Led intégré au plafond ou en version dans laquelle la lumière vient d'un projecteur déporté du luminaire (vendu séparément). Produit spécial à définir pour tout projet.

Spezifikation

Bestehend aus verschiedenen Einheiten, die zusammengefügt werden können. Diese Einheiten sind auf einer Platte verankert, an der die Lichtverteiler befestigt sind. Als in die Decke eingebaute Led-Version oder als Version mit externem Strahler verfügbar. Erhältlich als Sonderleuchte.

Especificaciones

Módulos componibles que permiten numerosas composiciones, formado por un plafón del cual están suspendidos los elementos difusores. Disponibles en la versión Led integrados en el plafón y en la versión en que la luz proviene de un proyector externo. Suministro como proyecto especial.

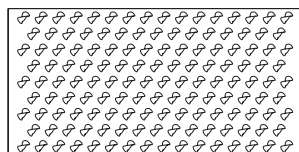

100 cm

92 cm

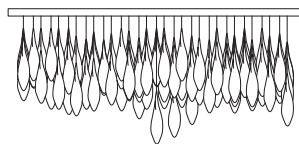

200 cm

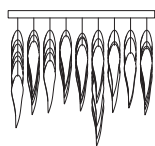

100 cm

LED 3,5W, included



MODULO ELECTRO
www.moduloelectro.com

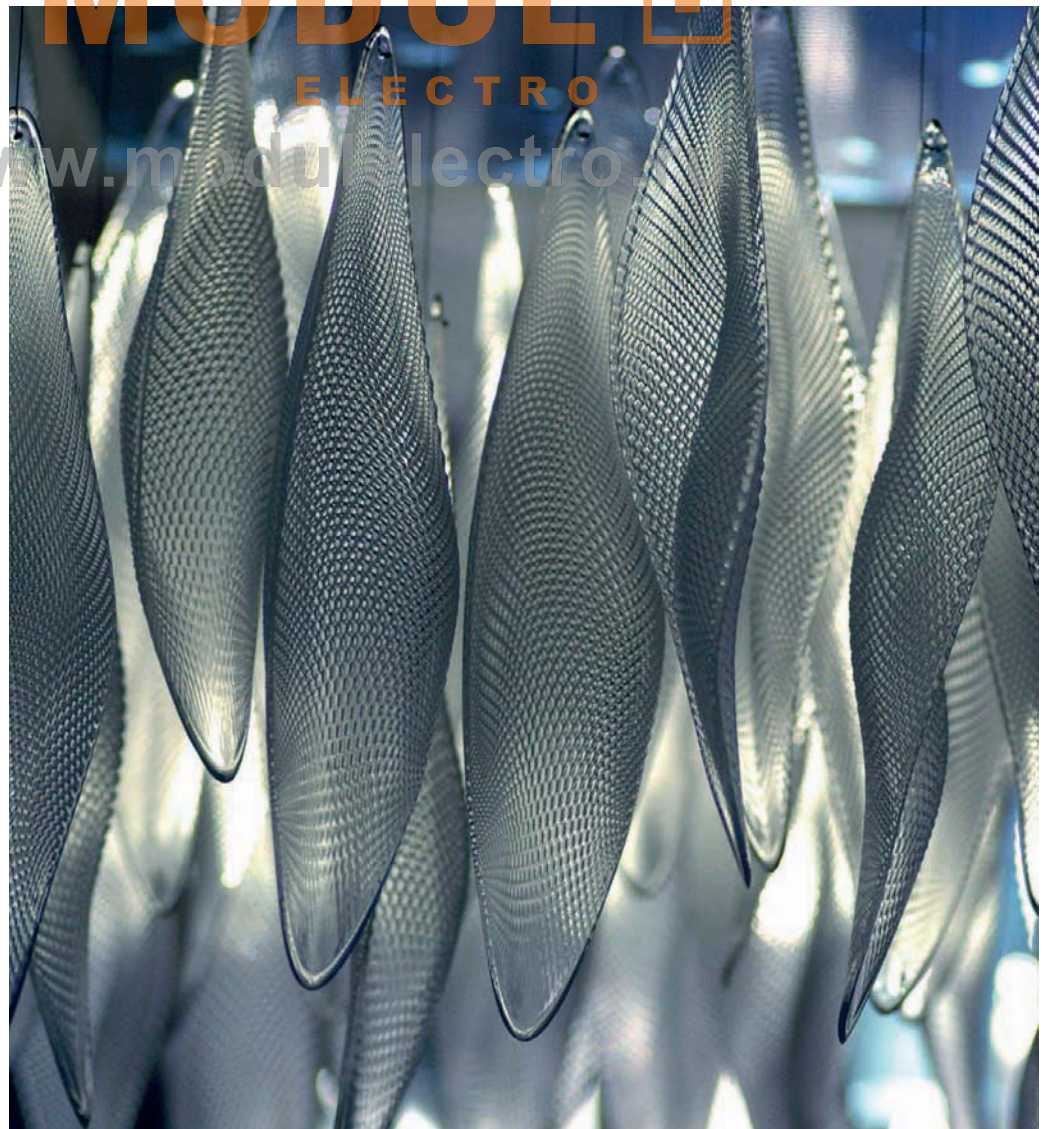

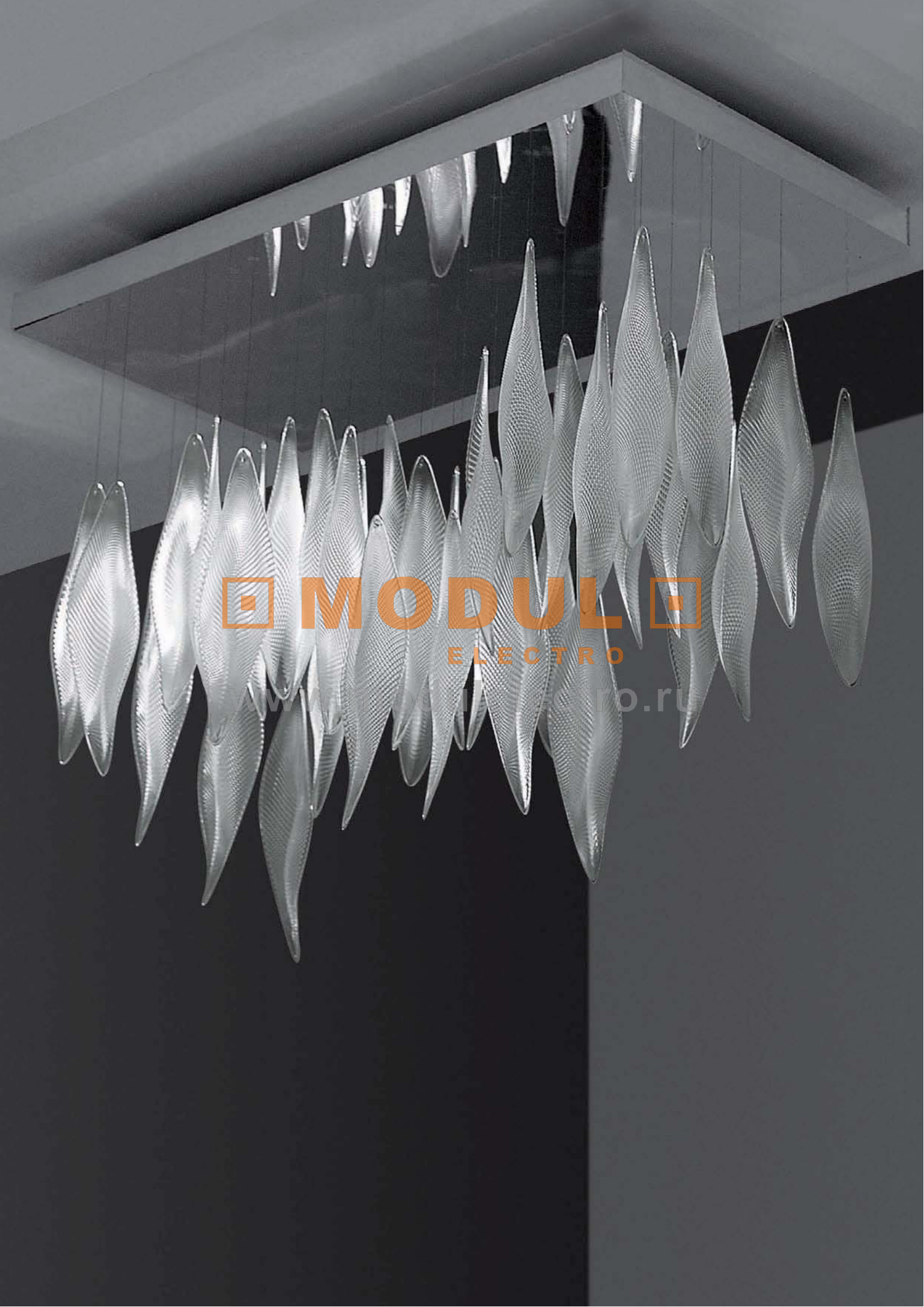

 **MODUL** 
ELECTRO

www.modul-electro.ru

Cosmic Angel parete

design

Ross Lovegrove
2009



Materiali: corpo lampada-riflettore in materiale termoplastico; diffusore posteriore in metrilato opalino.

Specificità: 45 Led RGB producono sul corpo lampada luce decorativa colorata, gestibile attraverso un telecomando.

Light emission



Colour



Mirror

Materials

Body lamp-reflector made of thermoplastic material; back diffuser in opal methacrylate.

Specification

45 RGB leds generate decorative coloured light on body lamp, manageable using a remote control.

Matériaux

Corps réflecteur en matériau thermoplastique ; diffuseur arrière en méthacrylate opalin.

Spécificité

45 Leds RGB produisent une lumière colorée sur le corps du luminaire, gérés à l'aide d'une télécommande.

Materialien

Leuchtenkopf aus thermoplastischem Material; hinterer Schirm aus Opal-Metacrylat.

Spezifikation

45 Led-RGB setzen auf dem Leuchtenkörper Farbakzente, die über eine Fernbedienung steuerbar sind.

Materiales

Cuerpo lámpara-reflector en material termoplástico. Difusor posterior en metacrilato opal.

Especificaciones

45 led RGB producen sobre le cuerpo lámpara luz decorativa colorada, gestionada gracias a un mando a distancia.

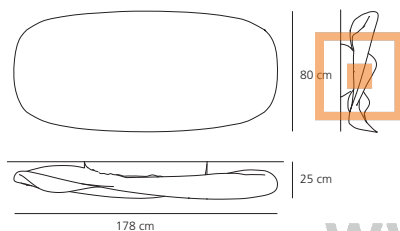

Indirect emission:

FLUO 2x80W (2G 11) - TC-L, included

Electronic ballast

Decorative light:

LED max 17W (45 LED RGB), included

IP20 Dimmer



Infrared remote control
(included)

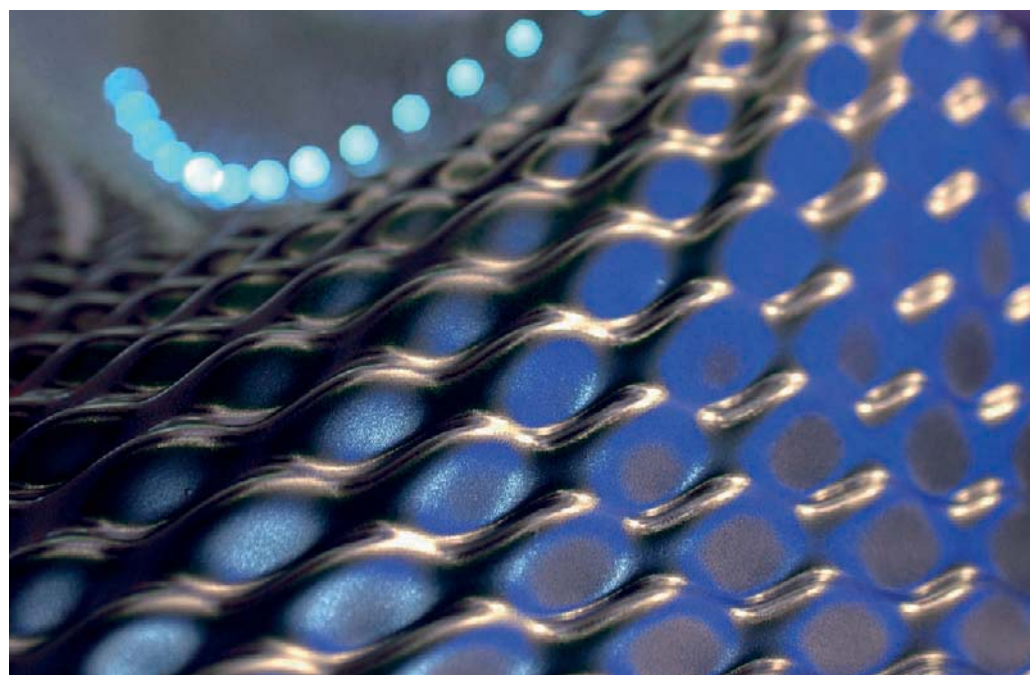
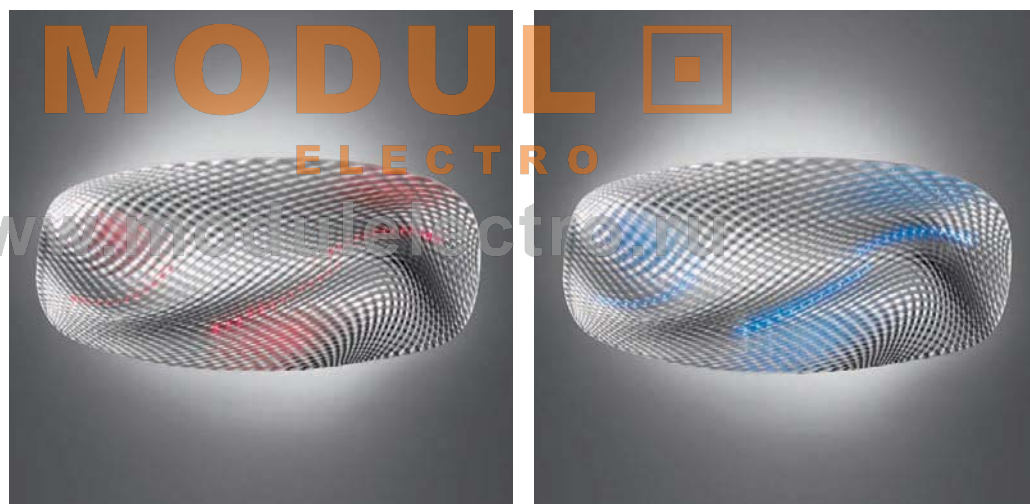

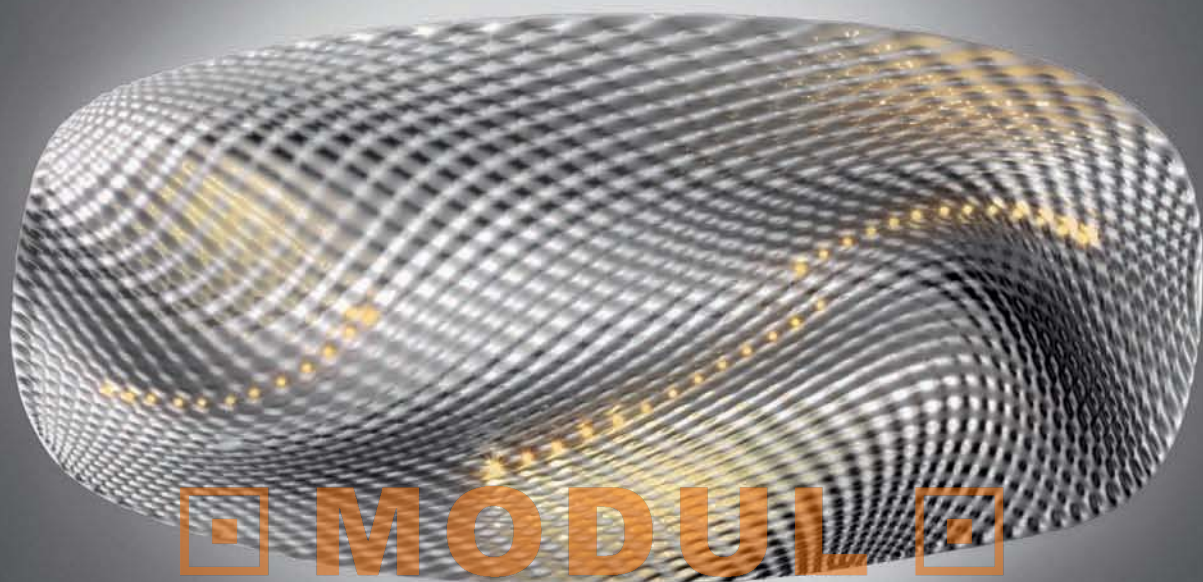

MODUL

ELECTRO

www.modulelectro.ru

Cosmic Angel soffitto

design
Ross Lovegrove
2009



Materiali: corpo lampada-riflettore in materiale termoplastico. Corpi illuminanti in alluminio pressofuso; diffusore superiore in metacrilato opalino.

Light emission



Colours



Mirror

Materials

Body lamp- reflector made of thermoplastic material; die-cast aluminium lighting units; upper diffuser in opal methacrylate.

Matériaux

Corps réflecteur en matériau thermoplastique ; corps lumineux en aluminium moulé sous pression ; diffuseur supérieur en méthacrylate opalin.

Materialien

Leuchtenkopf aus thermoplastischem Material; Leuchtenkörper aus druckgepressem Aluminium, oberer Schirm aus Opal-Metacrylat.

Materiales

Cuerpo lámpara-reflector en material termoplástico. Cuerpos luminosos en aluminio fundido; difusor superior en metacrilato opal.

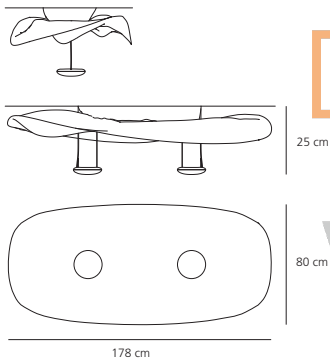

HALO max 2x400W (R7s) - ECO, included
FLUO 2x80W (2G 11) - TC-L, included
Electronic ballast

IP20 + Dimmer

METAL HALIDE 2x70W (G 8,5) - HIT
Electronic ballast
FLUO 2x80W (2G 11) - TC-L
Electronic ballast

IP20 + Dimmer

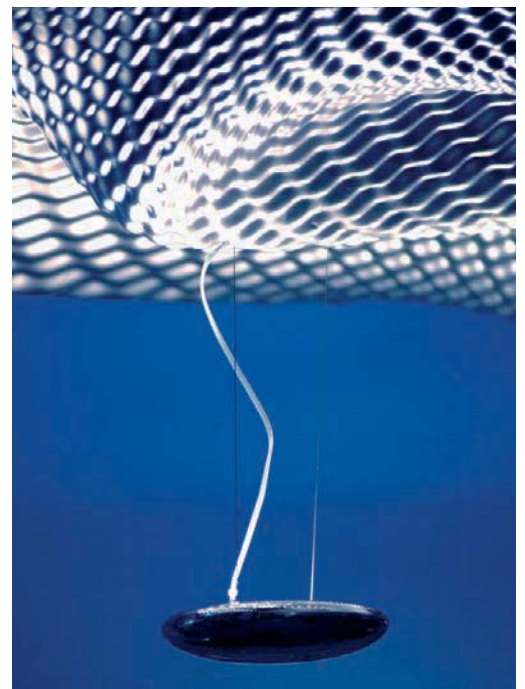
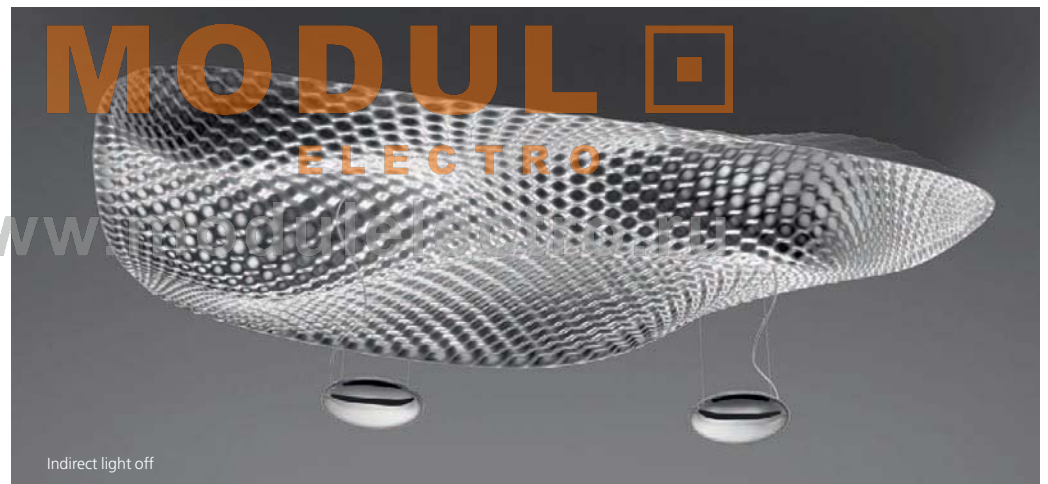



MODUL

ELECTRO

www.modulelectro.ru



Materiali: struttura in lamiera metallica piegata e forata. Dietro la lamiera vi è un foglio opalino che diffonde il flusso luminoso. La parte superiore dell'apparecchio è in materiale plastico trasparente che tende ad ottimizzare la performance di luce indiretta e protegge, inoltre, le sorgenti e l'elettronica interna dagli agenti esterni.

Specificità: l'accostamento di vari moduli può dare forma ad infinite superfici di luce componibili secondo esigenze funzionali e spaziali. Moduli di 1x1m possono costituire un wall, una quinta luminosa che scompone la luce volumetrica e la emette nello spazio, nella dinamicità delle varianti cromatiche che può assumere.

Light emission



Colour



mirror

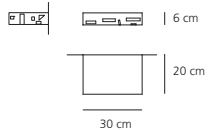

Space Oddity parete 30x20
FLUO 1x36W (2G 10) - TC-F
Electronic ballast

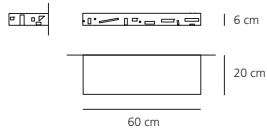

Space Oddity parete 60x20
FLUO 2x55W (2G 11) - TC-L
Electronic ballast



Materials

Folded and perforated plate frame. An opalescent sheet over the plate helps diffuse the luminous flow. The rear of the appliance is made of transparent plastics, which tends to optimize the indirect lighting performance and also protects the light sources and the electronic parts within from outer agents.

Matériaux

Structure en tôle pliée et perforée. Derrière la tôle se trouve une feuille opaline qui aide la diffusion du flux lumineux. La partie postérieure est en matière plastique transparente qui vise à optimiser la performance de la lumière indirecte et protège, en outre, les sources et l'électronique internes contre les agents externes.

Materialien

Struktur aus gebogenem und gestanztem Metallblech. Hinter dem Blech ist eine opalisierende Folie befestigt, die als Reflektor dient. Die hintere Seite der Leuchte besteht aus transparentem Kunststoff, der die indirekte Lichtwirkung optimiert und als Schutz der im Innern befindlichen Elektronik dient.

Materiales

Estructura de chapa metálica plegada y perforada. Detrás de la chapa hay una hoja opalina que ayuda a difundir el flujo luminoso. La parte trasera del aparato es de material plástico transparente que tiende a optimizar el resultado de luz indirecta y protege, además, las fuentes y la electrónica interna de los agentes externos.

Specification

The combination of multiple modules can give life to countless light surfaces to be organized according to functional and space requirements. Modules sized 1x1m can make up a wall, a luminous scene that breaks down and emits volumetric light into space, with a range of dynamic colour variations.

Spécificité

L'assemblage de différents modules peut former des surfaces de lumière infinies composables selon les exigences fonctionnelles et spatiales. Des modules de 1x1m peuvent constituer un mur, une coulisse lumineuse, qui décompose la lumière volumétrique et l'émet dans l'espace, dans une dynamique de variantes chromatiques.

Spezifikation

Nur der Raum setzt der Kombination der verschiedenen Wandmodule Grenzen. Module können z.B. eine Wand bilden und damit Lichtszenarien, die das erzeugte Licht in den Raum abgeben und eine Vielzahl dynamischer Farbvarianten erzeugen.

Especificaciones

La combinación de diferentes módulos puede dar forma a infinitas superficies de luz componibles según exigencias funcionales y espaciales. Módulos de 1x1m pueden constituir un wall, un bastidor luminoso que descompone la luz volumétrica y la emite en el espacio, en la dinamicidad de las variantes cromáticas que puede asumir.



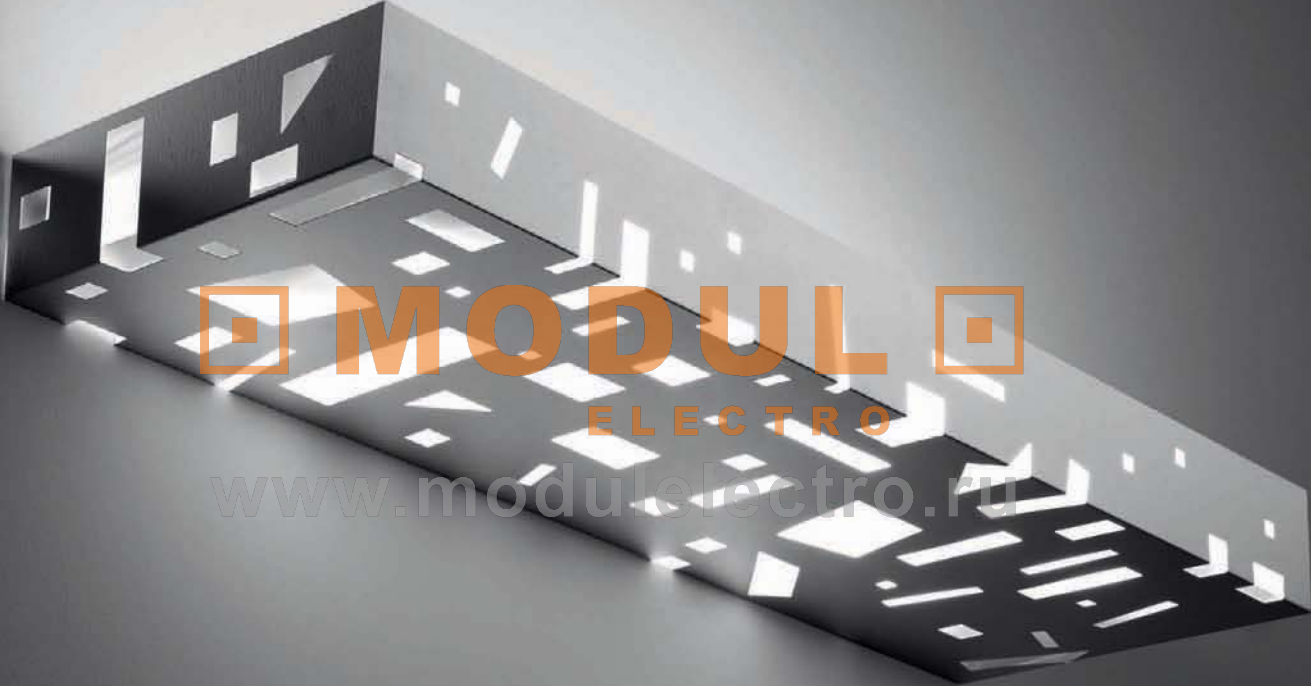

MODUL
ELECTRO

www.modulelectro.ru

Aqua Cil soffitto

design
Ross Lovegrove
2008



Materiali: supporto soffitto in alluminio pressofuso, corpo in alluminio stampato e trattato a specchio, diffusore in materiale termoplastico stampato ad iniezione.

Light emission



Colours



Mirror



Metal orange



Metal blue

Materials

Die-cast aluminium ceiling support, body in moulded and mirror-treated aluminium, injection-moulded thermo-plastic material diffuser.

Matériaux

Support plafonnier et corps en aluminium moulé sous pression ; diffuseur en matériau thermoplastique traité façon miroir

Materialien

Sockel der Deckenleuchte aus Aluminiumdruckguss, Körper aus Aluminium-Spritzguss und hochglanzpoliertem Aluminium, Schirm aus thermoplastischem Material, in Spritzgusstechnik hergestellt.

Materiales

Soporte de plafón en aluminio fundido a presión, cuerpo de aluminio moldeado por inyección y con acabado pulido espejo; difusor de material termoplástico estampado a inyección.

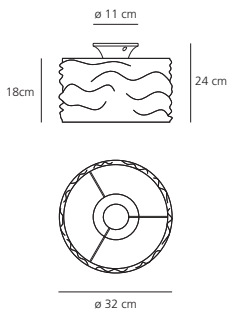

HALO max 1x150W (E 27) - ECO



MODUL
ELECTRO
www.modulelectro.ru

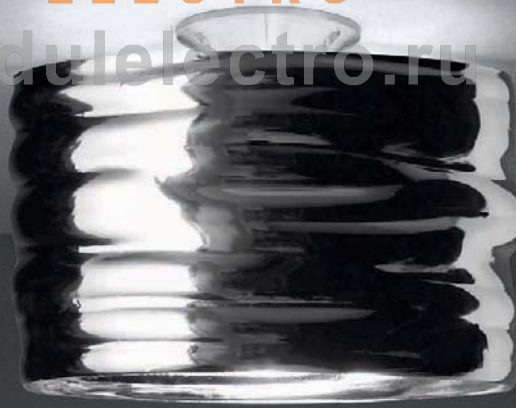

Eurialo

design
Pio & Tito Toso
2008





Materiali: lamiera di alluminio stampato, verniciato o spazzolato.

Light emission



Colours

-  Metal grey
-  Polished white
-  Polished black/white

Materials

Moulded aluminium plate,
painted or brushed.

Matériaux

Tôle en aluminium moulé, peint
ou brossé.

Materialien

Gegossenes Aluminiumblech,
lackiert oder gebürstet.

Materiales

Chapa de aluminio prensado,
pintado o cepellado.

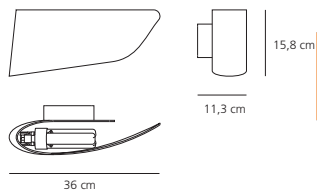
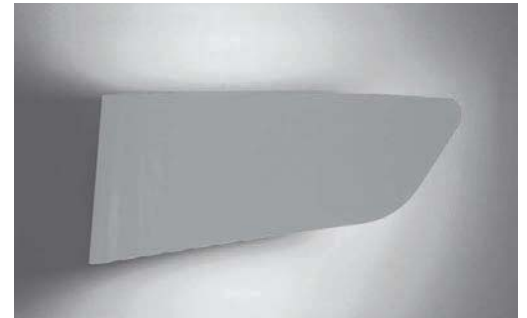

MODULO

ELECTRO

www.modulelectro.ru

HALO max 1x160W (R7s) - ES, included

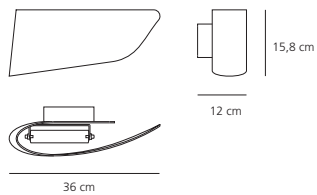

FLUO 1x32/42W (GX 24 q-3) - TC-TEL
Electronic ballast



METAL HALIDE 1x70W (E 27) - HIE
Electronic ballast

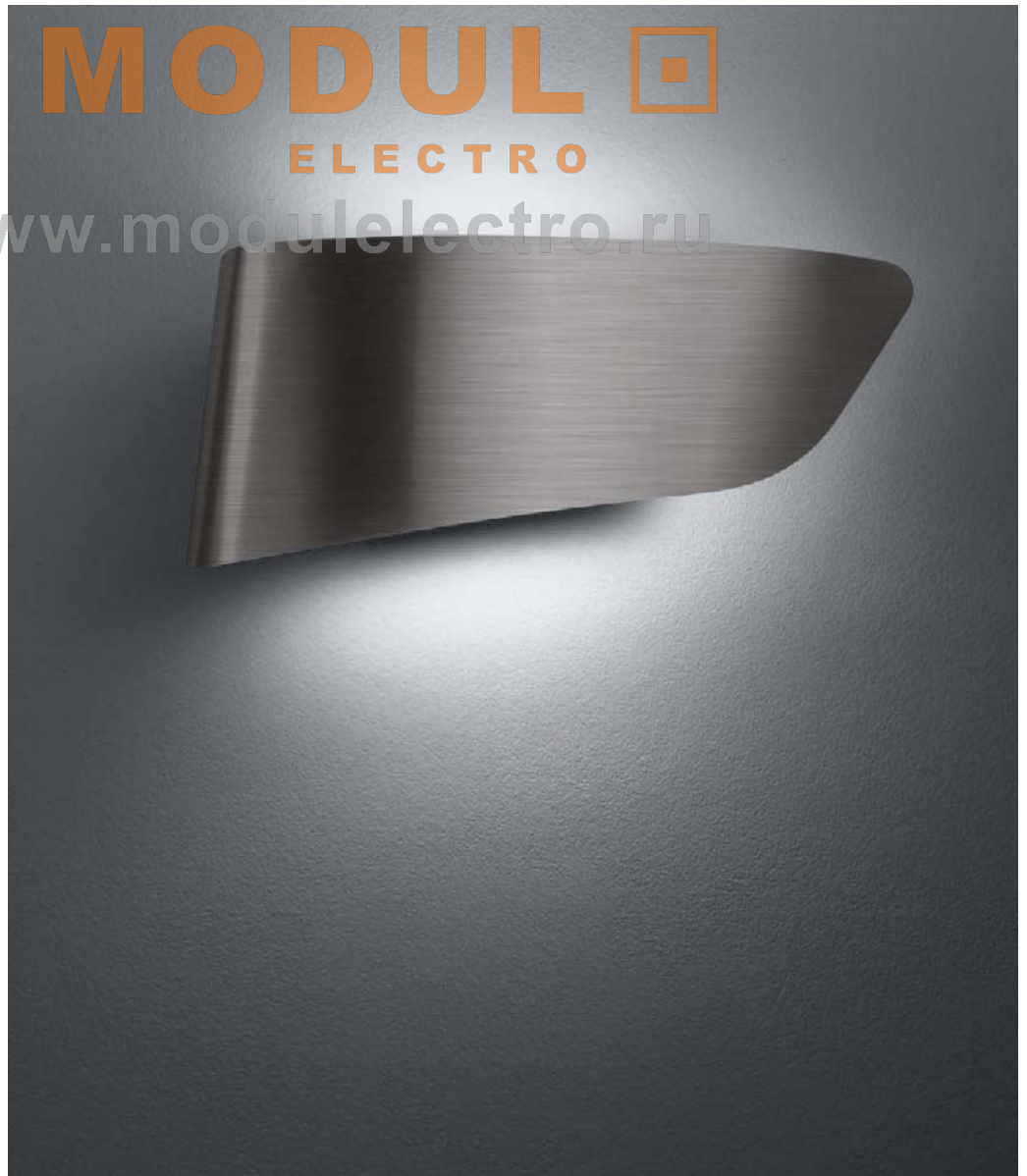

Talo parete

design

Neil Poulton
2002



Awards

Prix "L'Observateur du Design 2002"
"Etoile 2002" – Paris (France)

Reddot Design Award
2002 – Essen (Deutschland)

iF Product Design Award
2002 – Hannover (Deutschland)

Compasso d'Oro / ADI – Selezione
2002 Milano (Italia)

Materiali: alluminio pressofuso verniciato o cromato.

Light emission



Colours

White
(only halo version)

Silver grey

Mirror

Metal grey

Materials

Die-cast aluminium painted or
chromed.

Matériaux

Aluminium galvanisé verni ou
chromé.

Materialien

Lackierter oder verchromter
Aluminiumdruckguss.

Materiales

Aluminio comprimido pintado
o cromado.

3.4 cm

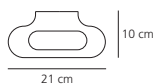

HALO max 1x120W (R7s) – ES, included



4.3 cm

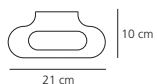

FLUO 1x18W (G 24 q-2) – TC-DEL. Electronic ballast



MODUL
ELECTRO
www.modulelectro.ru





MODUL
ELECTRO
www.modulelectro.ru

Talo parete 90
Talo parete 120
Talo parete 150
Talo parete 180
Talo parete 240

design
 Neil Poulton
 2001, 2002



Awards
 Prix "L'Observateur du Design 2002"
 "Etoile 2002" – Paris (France)
 Reddot Design Award
 2002 – Essen (Deutschland)
 iF Product Design Award
 2002 – Hannover (Deutschland)
 Compasso d'Oro / ADI – Selezione
 2002 – Milano (Italia)

Materiali: corpo in alluminio verniciato; testate di chiusura in alluminio pressofuso.
Specificità: : disponibile in tre lunghezze a seconda della potenza della sorgente luminosa: 90,5 cm (39W), 120,5 cm (54W), 150,5 cm (80W). Talo parete da 39W e 54W è disponibile in versione bilampada in due lunghezze: 179,5 cm e 239,5 cm.

Light emission



Colours



Materials

body in painted aluminium;
 die-cast aluminium endpieces.

Matériaux

Corps en aluminium verni;
 embouts de finition en aluminium galvanisé.

Materialien

Körper aus lackiertem Aluminium;
 Verschlussvorrichtungen aus Aluminiumdruckguss.

Materiales

cuerpo de aluminio pintado;
 cabezales de cierre de aluminio comprimido.

Specification

Dimensions: available in three lengths according to the power of the light source: 90,5 cm (39W), 120,5 cm (54W), 150,5 cm (80W). 39W and 54W versions are available also with double light source in two lengths: 179,5 cm, 239,5 cm.

Spécificité

Disponible en trois longueurs selon la puissance de la source lumineuse: 90,5 cm (39W); 120,5 cm (54W); 150,5 cm (80W). Talo parete 39W et 54W sont disponibles en version bitube en deux longueurs : 179,5 cm, 239,5 cm.

Spezifikation

Erhältlich in drei Größen mit unterschiedlicher Bestückung: 90,5cm (39W), 120,5cm (54W), 150,5cm (80W). Die 39W und 54W Versionen sind auch in 2-lampiger Ausführung und in zwei Längen: 179,5 cm; 239,5 cm erhältlich.

Especificaciones

Disponible en tres longitudes, según la potencia de la fuente luminosa: 90,5cm (39W), 120,5cm (54W), 150,5cm (80W). Talo parete 39W y 54W disponible en versión bitubo en dos longitudes: 179,5cm, 239,5cm.

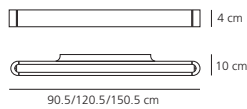

Talo parete 90, 120, 150
 FLUO 1x39W/54W/80W (G 5) – T 16, included
 Electronic ballast

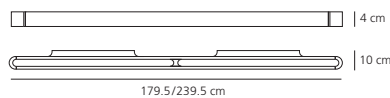

Talo parete 180, 240
 FLUO 2x39W/54W/80W (G 5) – T 16, included
 Electronic ballast

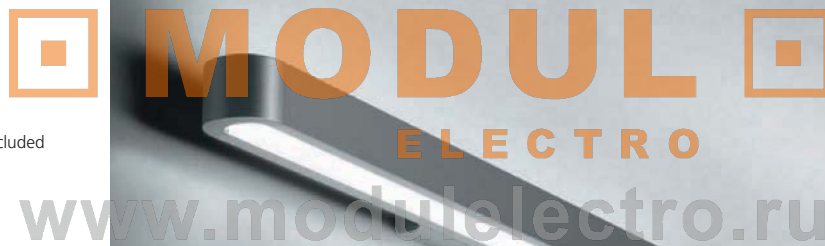

Talo parete 180



Cabildo parete

design
Eric Solé
2007



Materiali: attacco parete e corpo lampada in alluminio pressofuso verniciato.

Light emission



Colour



White

Materials

Wall support and body lamp in painted die-cast aluminium.

Matériaux

Support applique et corps de lampe en aluminium moulé sous pression peint.

Materialien

Wandhalterung und Leuchtenkörper aus druckgegossenem, lackiertem Aluminium.

Materiales

Soporte a pared y cuerpo de la lámpara en aluminio fundido a presión y pintado.

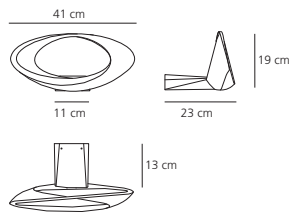

MODULO
ELECTRO



www.modulelectro.ru

HALO max 1x230W (R7s) – ES, included



METAL HALIDE 1x70W (G 8,5) – HIT
Electronic ballast

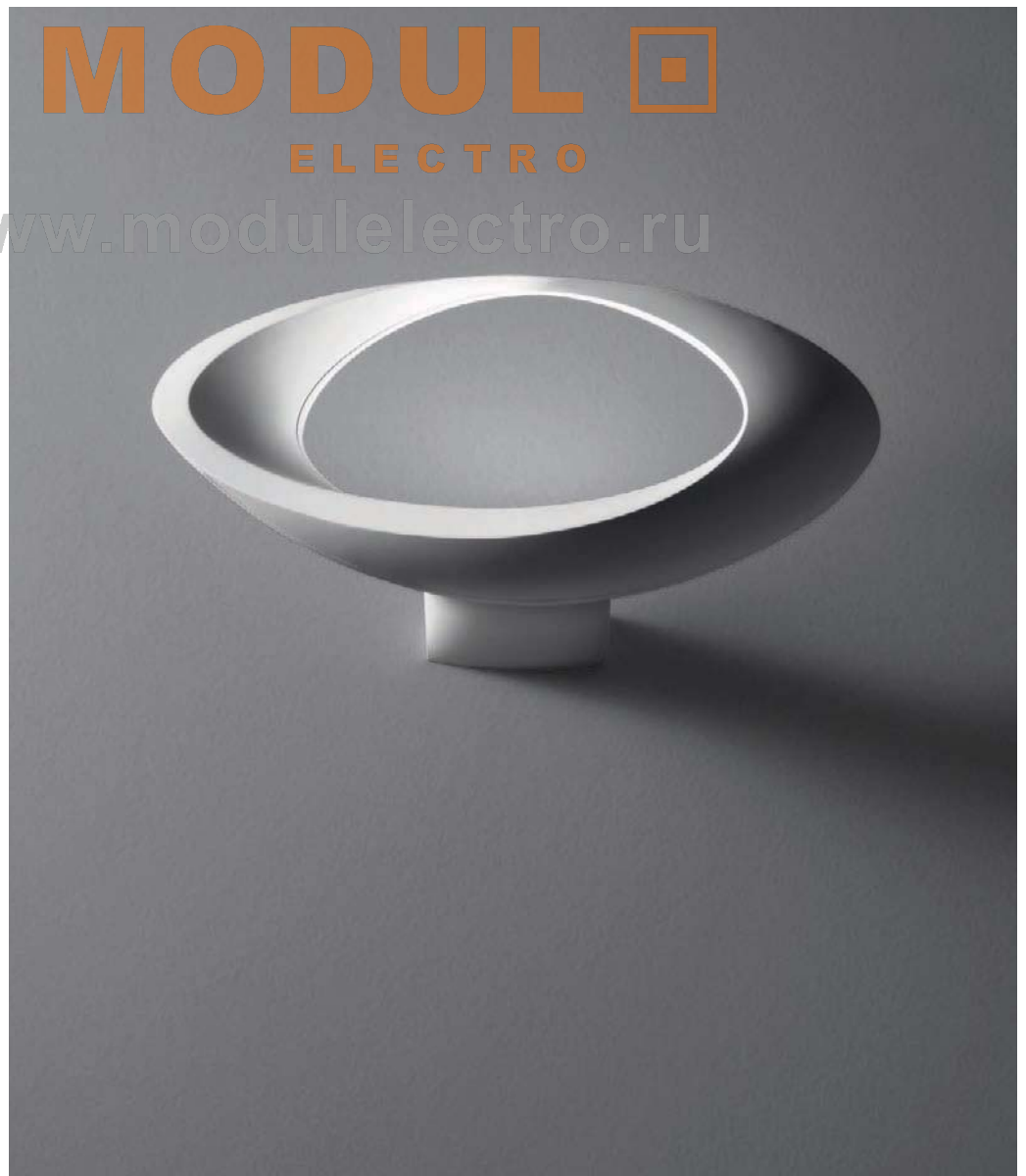



Awards

iF Produkt Design Award
2006 – Hannover (Deutschland)
Reddot Design Award – Product Design
2006 – Essen (Deutschland)
Good Design Award
The Chicago Atheneum
2007 – Chicago (US)

Materiali: alluminio pressofuso verniciato o cromato.

Light emission



Colours

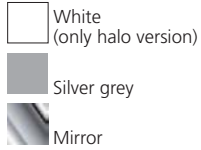

Materials

Painted or chromed die-cast aluminium.

Matériaux

Aluminium moulé verni ou chromé.

Materialien

Leuchtenkörper aus lackiertem Aluminiumdruckguss oder aus mattem oder glänzendem Chrom.

Materiales

Aluminio presofuso pintado o cromado.

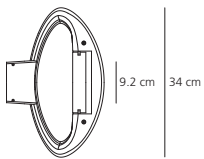
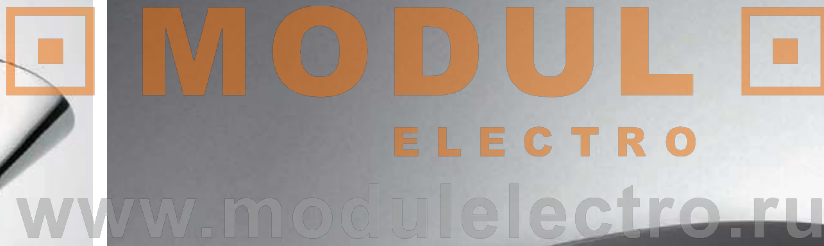

HALO max 1x230W (R7s) - ES, included

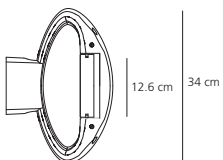

METAL HALIDE 1x35W (G 8,5) HIT
Electronic ballast





MODUL
ELECTRO
www.modulelectro.ru

Tities 26
Tities 40
Tities 70

design
 Zebulon
 1998, 2001



Awards

Intel Design 2003
 Selezione categoria design
 "Augusto Morello" IIIa edizione
 2003 – Milano (Italia)

Materiali: struttura e diffusore in metallo verniciato o microforato.

Light emission



Colours



White



Metal grey

Materials

Structure and diffuser in painted or microperforated metal.

Matériaux

Structure et diffuseur en métal verni ou microperforé.

Materialien

Leuchtgehäuse aus lackiertem oder mikroperforiertem Metall.

Materiales

Estructura y difusor, de metal pintado o microperforado.

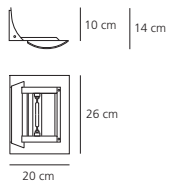

Tities 26
 HALO max 1x230W (R7s) – ES, included

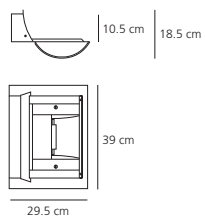

Tities 40
 METAL HALIDE 1x250W (Fc 2) – HIT-DE

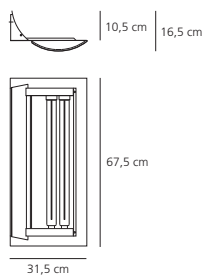

Tities 70
 FLUO 2x55W (2G 11) – TC-L
 Electronic ballast



Tities 40



Tities 70

Astarte

design

Richard Sapper
1990



Awards

The Israel Museum
Jerusalem (Israel)

Materiali: materiali: supporto parete in acciaio verniciato; stelo, prolungabile a richiesta, in fibra di carbonio; riflettore in alluminio anodizzato.

Specificità: il riflettore orientabile sull'asse orizzontale e scorrevole lungo lo stelo consente di portare la sorgente luminosa verso il centro di spazi anche di grande dimensione, senza ingombri a terra.

Light emission



Colour

Structure:
Black

Materials

Wall support in painted steel;
carbon fibre stem extension
available on request; reflector in
anodised aluminium.

Specification

Reflector is adjustable on the
horizontal axis and by sliding
along the stem, allowing
the light source to reach the
centre of big spaces, without
encumbering the space on
the floor.

Matériaux

Support applique en acier
verni ; tige, prolongée sur
demande, en fibre de carbone ;
réflecteur en aluminium
anodisé.

Spécificité

Le réflecteur, orientable sur
l'axe horizontal et coulissant
le long de la tige, permet de
diriger la source lumineuse
vers le centre de la pièce, sans
encombrement au sol.

Materialien

Sockel der Wandleuchte aus
lackiertem Stahl; Teleskopstab
aus Kohlenfaser; Reflektor
aus eloxiertem Aluminium.

Spezifikation

Der horizontal verstellbare
Reflektor aus eloxiertem
Aluminium ist über ein
Gegengewicht justierbar.

Materiales

Soporte de aplique, de acero
pintado; vástago (extensible
bajo pedido), de fibra de car-
bono; reflector, de aluminio
anodizado.

Especificaciones

El reflector, orientable en sen-
tido horizontal, se desliza a lo
largo del vástago, merced a lo
cual la fuente luminosa puede
ubicarse en el centro del
recinto, aunque el mismo sea
de grandes dimensiones, sin
ocupar espacio en el suelo.

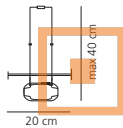

HALO max 1x230W (R7s) - ES

IP20 + Dimmer

MODUL

ELECTRO

www.modulelectro.ru



Nur soffitto
Nur mini soffitto

design
Ernesto Gismondi
2007



228

Materiali: corpo lampada in alluminio; diffusore in policarbonato.
Specificità: all'emissione diretta si aggiunge un'emissione indiretta che produce un alone di luce decorativo sul soffitto.

Light emission



Colours

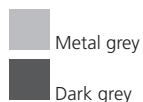

Materials

Aluminium body lamp; polycarbonate diffuser.

Specification

Added to the direct emission is an indirect emission that produces a halo of decorative light on the ceiling.

Matériaux

Corps en aluminium ; diffuseur en polycarbonate.

Spécificité

L'émission directe s'enrichit d'une émission indirecte qui produit un halo lumineux décoratif au plafond.

Materialien

Leuchtenkörper aus Aluminium; Schirm aus Polycarbonat.

Spezifikation

Der direkte Lichtaustritt wird durch indirektes Licht ergänzt, das an der Zimmerdecke einen dekorativen Lichtkranz entstehen läßt.

Materiales

Cuerpo de la lámpara en aluminio; difusor en policarbonato.

Especificaciones

A la emisión de luz directa se suma la indirecta, para dar vida a un halo de luz decorativo sobre el techo.

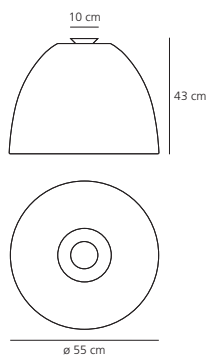

Nur soffitto

HALO max 1x205W (E 27) – ECO



FLUO 1x70W (GX 24q-6) – TC-TEL, included
Electronic ballast



METAL HALIDE 1x100W (E 27) – HIE
Electronic ballast

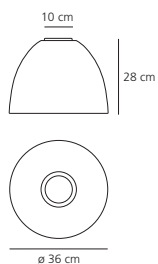

Nur mini soffitto

HALO max 1x150W (E 27) – ECO



FLUO 1x42W (GX 24q-4) – TC-TEL, included
Electronic ballast



METAL HALIDE 1x35W (E 27) – HIE
Electronic ballast

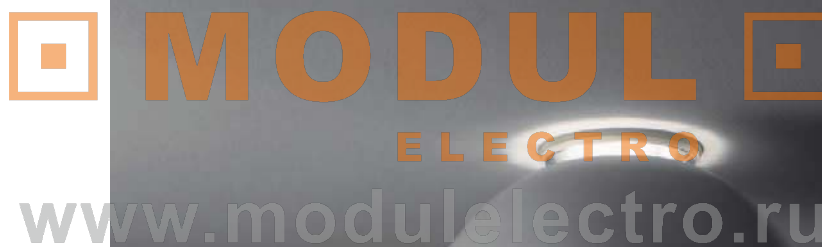

Nur Gloss soffitto
Nur mini Gloss soffitto

design
Ernesto Gismondi
2009



Materiali: corpo lampada in alluminio verniciato; diffusore in policarbonato.
Specificità: una finitura perfettamente liscia e lucida conferisce eleganza al classico modello Nur. All'emissione diretta si aggiunge un'emissione indiretta che produce un alone di luce decorativo sul soffitto.

Light emission



Colours



Polished black



Polished white

Materials

Painted aluminium body lamp;
polycarbonate diffuser.

Matériaux

Corps en aluminium verni;
diffuseur en polycarbonate.

Materialien

Körper aus lackiertem
Aluminium; Schirm aus
Polycarbonat.

Materiales

Cuerpo de aluminio pintado;
difusor en policarbonato.

Specification

A perfectly smooth and polished finish gives elegance to the classic Nur model. Added to the direct emission is an indirect emission that produces a halo of decorative light on the ceiling.

Spécificité

Une finition parfaitement lisse et brillante donne plus d'élégance au modèle Nur classique. L'émission directe s'enrichit d'une émission indirecte qui produit un halo lumineux décoratif au plafond.

Spezifikation

Die Hochglanzpolitur verleiht dem Klassiker Nur eine besondere Eleganz. Der direkte Lichtaustritt wird durch indirektes Licht ergänzt, das an der Zimmerdecke einen dekorativen Lichtkranz entstehen läßt.

Especificaciones

Un acabado perfectamente liso y brillante confiere elegancia al clásico modelo Nur. A la emisión de luz directa se suma la indirecta, para dar vida a un halo de luz decorativo sobre el techo.

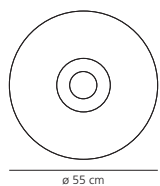
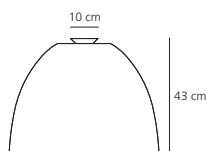

Nur Gloss soffitto

HALO max 1x205W (E 27) – ECO

IP20

FLUO 1x70W (GX 24q-6) – TC-TEL, included
Electronic ballast

IP20

METAL HALIDE 1x100W (E 27) – HIE
Electronic ballast

IP20

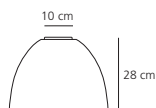

Nur mini Gloss soffitto

HALO max 1x150W (E 27) – ECO

IP20

FLUO 1x42W (GX 24q-4) – TC-TEL, included
Electronic ballast

IP20

METAL HALIDE 1x35W (E 27) – HIE
Electronic ballast

IP20

MODUL
ELECTRO
www.modulelectro.ru



Float soffitto circolare
Float soffitto lineare

design
James Irvine
2000



222

Materiali: struttura in alluminio verniciato; diffusore inferiore in metacrilato opalino; diffusore superiore in policarbonato trasparente.

Specificità: disponibile nelle versioni circolare o lineare. È possibile applicare un filtro blu o topazio all'emissione indiretta (solo nelle versioni circolare e lineare monotubo).

Light emission



Colour



White

Materials

Structure in painted aluminium, lower diffuser in opaline methacrylate, upper diffuser in transparent polycarbonate.

Matériaux

Structure en aluminium verni ; diffuseur inférieur en méthacrylate opalin ; diffuseur supérieur en polycarbonate transparent.

Materialien

Struktur aus lackiertem Aluminium; unterer Schirm aus opalem Metakrylat; oberer Schirm aus transparentem Polycarbonat.

Materiales

Estructura de aluminio pintado. Difusor inferior de metacrilato opalino, difusor superior en policarbonato transparente.

Specification

Available in circular or linear versions. Application of a coloured filter, blue or topaz, to the indirect light emission (Float circolare and Float lineare monotubo only).

Spécificité

Disponible en version circulaire ou linéaire. Un filtre coloré (bleu ou topaze) peut être ajouté, à l'émission indirecte (seulement pour Float circolare et Float lineare monotubo).

Spezifikation

Erhältlich als Kreis- oder Linearausführung. Für die Versionen Float circolare und Float lineare monotube ist der Einsatz eines blauen oder goldgelben Farbfilters möglich.

Especificaciones

Disponible en dos versiones: lineal o circular. Es posible aplicar un filtro azul o topacio para la emisión de luz indirecta (sólo en las versiones circular y lineal monotubo).

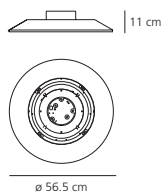

Float soffitto circolare

FLUO 1x55W (2GX 13) – T 16-R, included Electronic ballast

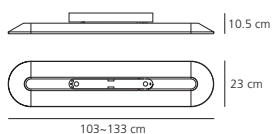
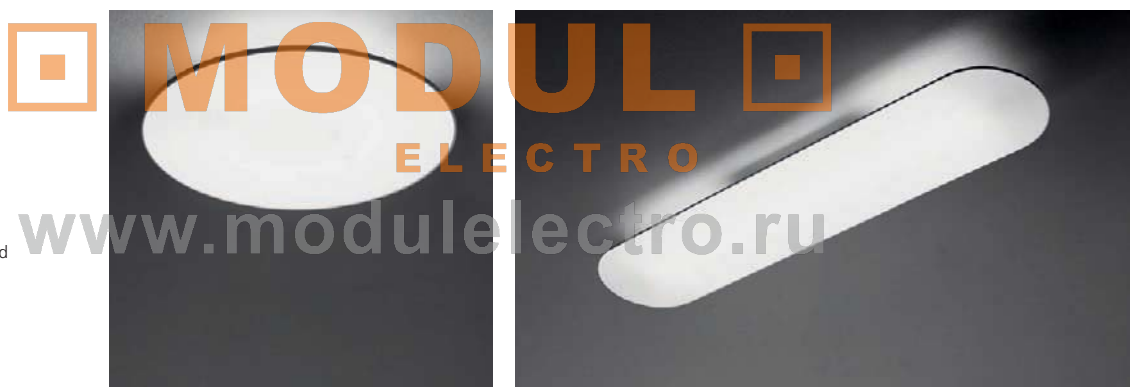

Float soffitto lineare monotubo

FLUO 1x39W (G 5) – T 16, included Electronic ballast



Float soffitto lineare bitubo

FLUO 2x39W (G 5) – T 16, included Dimmable or non dimmable, Electronic ballast



FLUO 2x54W (G 5) – T 16, included Dimmable or non dimmable, Electronic ballast





MODUL
ELECTRO
www.modulelectro.ru

Go to the mirror

design

Carlotta de Bevilacqua
2003



Materiali: struttura in alluminio ed acciaio; diffusore a specchio.

Specificità: uno specchio che si trasforma in diffusore luminoso una volta acceso. È composto da 3 settori verticali ognuno con una propria sorgente luminosa, riflettore autonomo e comando on-off. Si possono ottenere 7 diverse configurazioni a seconda delle sorgenti accese.

Light emission



Colour



Mirror

Materials

Structure in aluminium and steel; mirror diffuser.

Specification

A mirror that transforms into a light diffuser once it is turned on. The mirror is composed of 3 vertical sectors, each with its own light source and autonomous reflector and on-off control. 7 differing configurations, depending on which light sources are turned on, can be obtained.

Matériaux

Structure en aluminium et acier ; diffuseur miroir.

Spécificité

Un miroir qui se transforme en diffuseur lumineux dès qu'il est sous tension. Le miroir se compose de 3 zones verticales, chacune accueillant sa propre source lumineuse, un réflecteur et une commande on/off autonome. Go to the mirror présente 7 configurations différentes en fonction des sources éclairées.

Materialien

Struktur aus Aluminium und Stahl; Spiegel-Schirm.

Spezifikation

Ein Spiegel, der durch eine Spezialbehandlung der Platte zu einer attraktiven Leuchte wird. Je nach Zuschaltung der Lichtquellen können sieben verschiedene Farbkonstellationen gebildet werden. Der Spiegel ist in drei gleichgroße vertikale Abschnitte unterteilt, von denen jeder mit einer Lichtquelle, einem unabhängigen Reflektor und Ein/Aus-Schalter ausgestattet ist.

Materiales

Estructura en aluminio y acero, difusor acabo espejo.

Especificaciones

Un espejo que se transforma en difusor luminoso una vez encendido. El espejo está compuesto por tres sectores verticales, cada uno con una fuente luminosa propia un reflector y mando on-off autónomo. Se pueden obtener hasta 7 configuraciones diferentes según las fuentes luminosas encendidas.

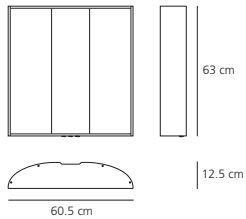

FLUO 6x18W (G 13) - T 26



MODULO ELECTRO
www.modulelectro.ru



Light off



1-2 light on



2 light on



1-2-3 light on



1-3 light on

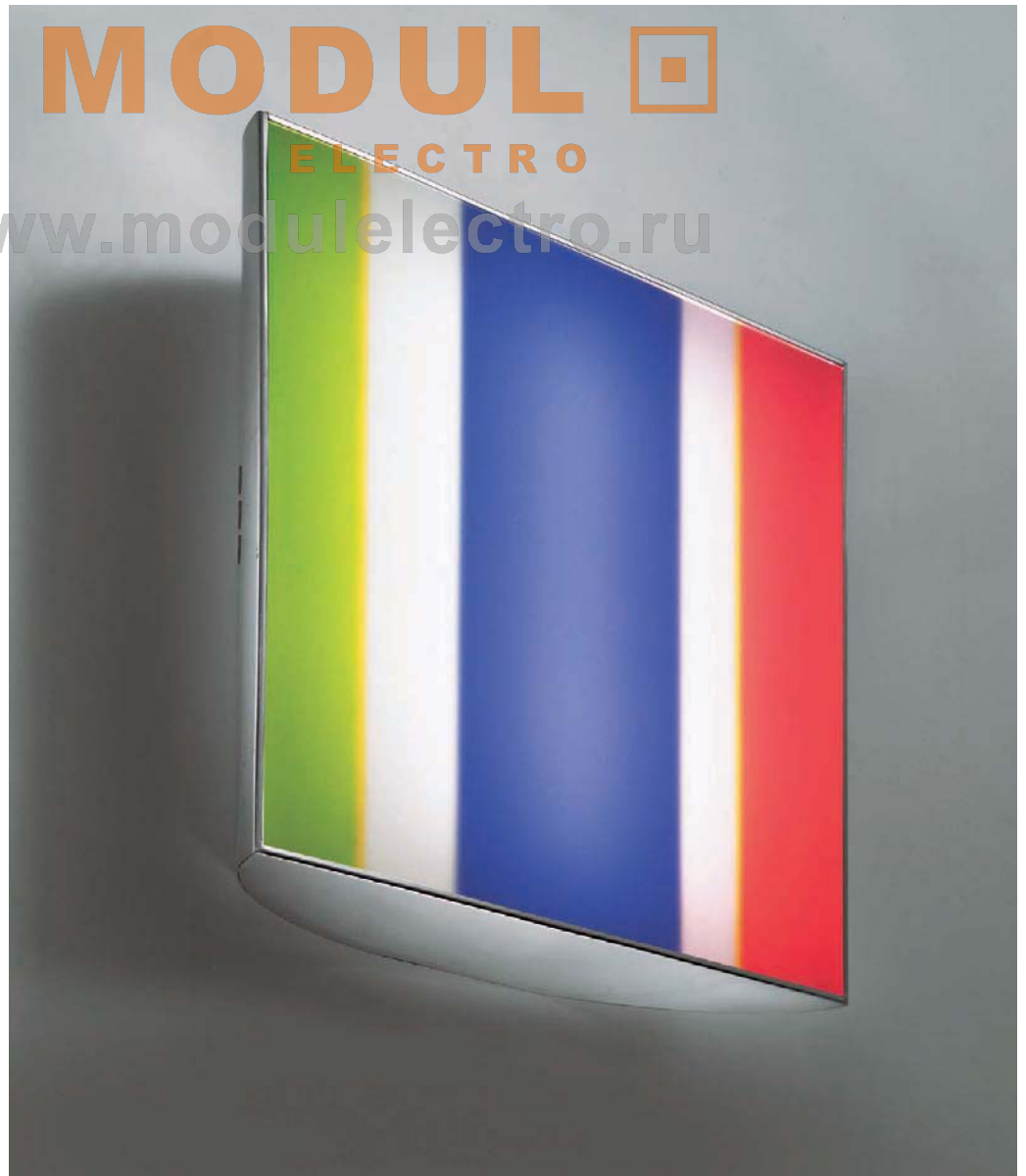

Materiali: struttura in acciaio verniciato, diffusore in metacrilato opalino.
Specificità: utilizza sorgenti RGB che consentono di ottenere infinite declinazioni della luce bianca, nelle diverse intensità e varietà delle temperature di colore, dalla più calda (2.500 K) alla più fredda (20.000 K). La regolazione delle funzioni avviene attraverso un telecomando a radiofrequenza.

Light emission



Colour



Materials

Painted steel structure; opal methacrylate diffuser.

Matériaux

Structure en acier peint ; diffuseur en méthacrylate opalin.

Materialien

Rahmen aus lackiertem Stahl, Schirm aus Opalin-Metakrylat.

Materiales

Estructura de acero pintado; difusor, de metacrilato opalino blanco.

Specification

It uses RGB light sources, which enable a limitless variation of white light with different intensities and a variety of colour temperatures, from the hottest (2.500 K) to the colder (20.000 K). The colour selection functions are set by a radiofrequency remote control.

Spécificité

Il utilise des sources RGB qui permettent d'obtenir d'innombrables déclinaisons de la lumière blanche dans les différentes intensités et les variétés de températures de couleur, de la plus chaude (2.500 K) à la plus froide (20.000 K). Le réglage des fonctions se fait avec une télécommande à radiofréquence.

Spezifikation

Durch den Einsatz von RGB-Lampen lassen sich in Bezug auf die Farbtemperatur und Farbintensität verschiedenste Abstufungen des Weißlichts kreieren, von den wärmsten (2.500 K) zu den kältesten (20.000 K). Die Regelung der verschiedenen Funktionen erfolgt über eine Radiofrequenz-Fernbedienung.

Especificaciones

Incorpora fuentes de luz RGB de color rojo, verde y azul, a efectos de obtener una gradación infinita de la luz blanca, con toda su variedad de intensidades y un amplio abanico de temperaturas-color, de muy fría (2.500 K) a muy cálida (20.000 K). Las funciones se regulan mediante mando a distancia de radio frecuencia.

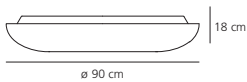
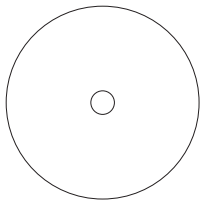

FLUO 3x3 RGB groups (tot. 9) x14W (G 5) - T16, included. Electronic ballast

IP20     - Dimmer



Radiofrequency remote control (included)



Wall mounted control panel (to order separately)



MODULO
ELECTRO
www.modulelectro.ru

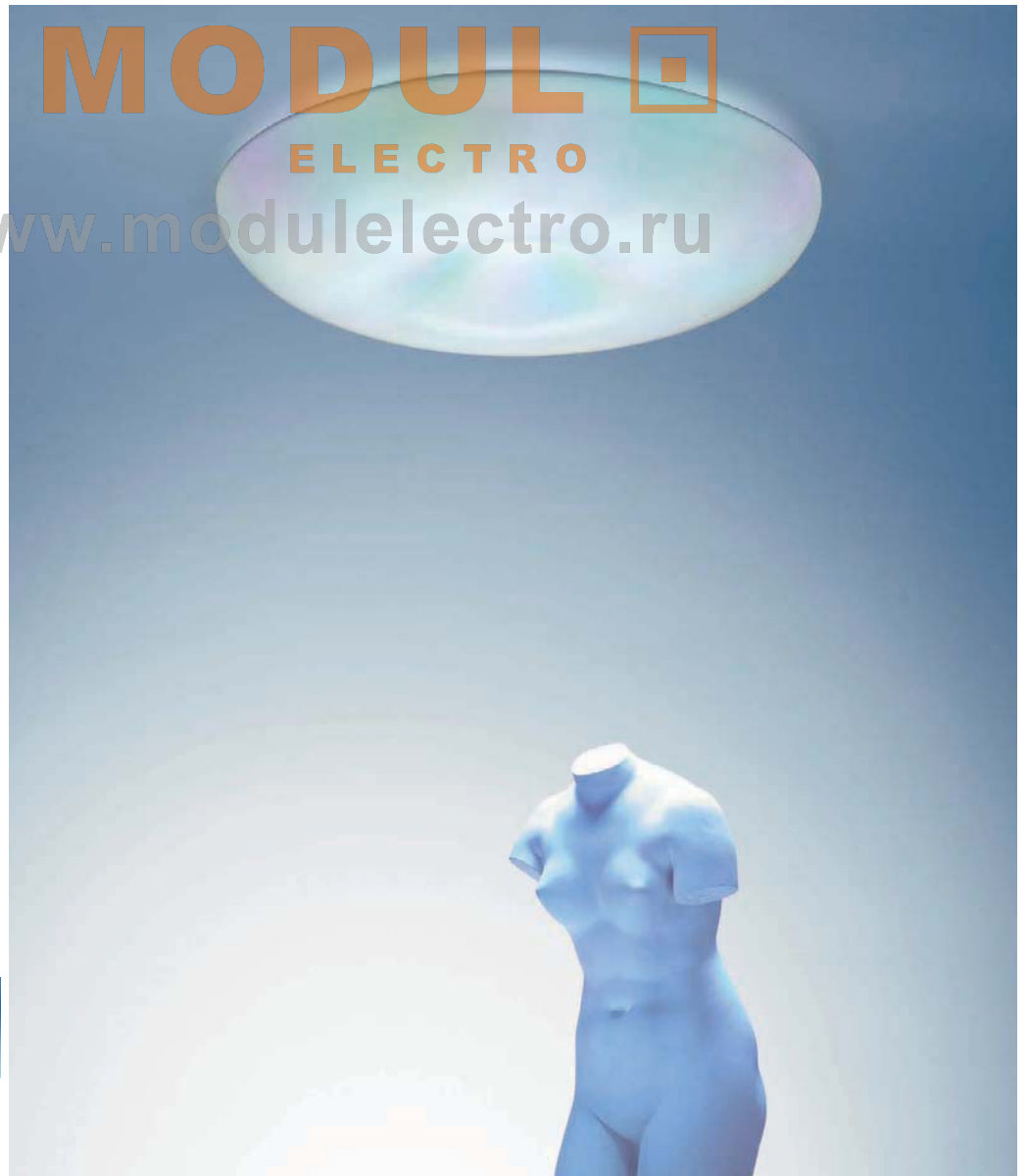



”Un m² di superficie dove la luce scorre fluida su fili trasparenti che attraverso un riflettore a specchio materializza un effetto luminoso volumetrico e controllato. È un m³ di luce nel quale ci si riflette all’infinito modulando liberamente più di un milione di effetti cromatici. Lo spazio non è più uno, ma diventa molti o semplicemente altro, percezione illusoria della realtà che porta verso un nuovo luogo, altrove.”

Materiale: struttura perimetrale in alluminio a specchio; diffusori laterali in Prismoptic satinato; diffusore frontale in metacrilato trasparente inciso.

Specificità: sono disponibili due versioni che emettono luci differenti a seconda del riflettore.

Luce fluida: con riflettore in alluminio lucido a specchio.

Luce volumetrica alluminio lucido a specchio a segmenti ottici.

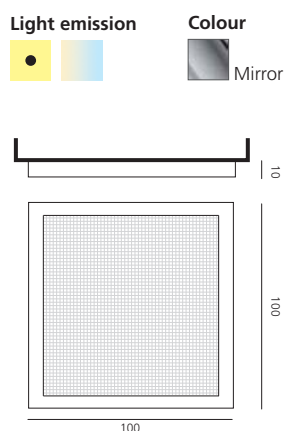

In a m² of surface where the light flows in a fluid way on transparent wires and, through a mirrored reflector, materializes a lighting and volumetric effect which is controlled. It is a cubic metre of light where everything is endlessly reflected, freely modulating more than a million of chromatic effects. The space is no more just one, but several, or simply “else”, illusory perception of reality, which drivesto a new place, elsewhere.

Un m² de surface où la lumière entre avec fluidité sur des fils transparents et au travers d’un réflecteur miroir. Altrove matérialise un éclairage à effet volumétrique commandé. C’est un mètre cube de lumière où celle-ci se réfléchit sans fin et qui module librement plus d’un million d’effets chromatiques. L’espace n’en est plus un mais plusieurs ou simplement autre chose, perception illusoire de la réalité, qui mène à un nouvel endroit, ailleurs.

Auf einer Fläche von einem Quadratmeter auf der das Licht in fließender Bewegung über transparente Nylonkabel geleitet und durch eine Spiegelfläche reflektiert wird, wird Licht materialisiert und erzeugt einen einzigartigen strukturierten Volumeneffekt. In einem Quadrat aus Licht das sich ins Endlose reflektiert, werden Millionen von farbigen Effekten erzeugt. Die Fläche hat damit nicht mehr nur eine, sondern viele oder einfach “weitere” scheinbare Wahrnehmungen der Realität, die zu einer neuen Dimension führen.

Para materializar un efecto luminoso volumétrico y controlado, se ha creado un metro cuadrado de superficie donde la luz discurre con fluidez sobre hilos transparentes que cruzan un reflector en forma de espejo. Se trata de un metro cúbico de luz en el cual refleja hacia el infinito modulando libremente más de un millón de efectos cromáticos. El espacio ya no es único, sino que se convierte en una multitud de espacios o simplemente en uno distinto, en una percepción ilusoria de la realidad que nos conduce a un nuevo lugar, más allá.

FLUO 2x3 RGB groups (tot. 6) x 39W (G 5) – T 16,
(234W total power)

Electronic ballasts



Radiofrequency remote control (included)



Wall mounted control panel (to order separately)

Materials

Perimeter structure made of mirror aluminium; side diffusers made of opaline Prismoptic; front diffuser in transparent engraved methacrylate.

Specification

Two versions are available, with two kind of reflector.

Fluid light: with mirror aluminium reflector

Volumetric light: with segment reflector in mirror aluminium.

Matériaux

Périmètre de la structure en aluminium ; diffuseurs latéraux en Prismoptic opalin ; diffuseur frontal en méthacrylate transparent strié.

Spécificité

Deux versions sont disponibles avec deux types de réflecteur:

Lumière fluide : avec réflecteur miroir.

Lumière volumétrique : avec lames de réflecteur miroir.

Materialien

Rahmen aus verspiegeltem Aluminium; seitliche Reflektoren mit opaliner Prismoptic; Frontscheibe aus transparentem, graviertem Metacrylat.

Spezifikation

Erhältlich in zwei Versionen:

Fließendes Licht: Reflektor aus verspiegeltem Aluminium

Volumen erzeugendes Licht: Lamellenreflektor aus verspiegeltem Aluminium.

Materiales

Estructura perimetral de aluminio, difusores laterales de Prismoptic opalino, difusor frontal de metacrilato transparente.

Especificaciones

Están disponibles dos versiones que se caracterizan por dos tipos de reflector.

Luz fluida: con reflector en acabado espejo.

Luz volumétrica: con reflector de segmentos ópticos.

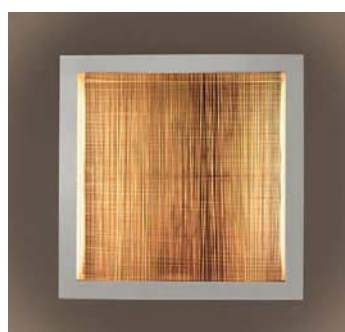



MODUL

ELECTRO

www.modulelectro.ru



”Un modulo di un m² può diventare porzione di una tela su cui l’uomo può esprimere i suoi ritmi, nel rapporto con il luogo e con gli altri. Il principio della sintesi additiva è alla base di questo progetto, che offre una infinita dinamicità cromatica, e diventa un vero e proprio mezzo di espressione emozionale e percettiva.

Materiali: pannello in barrisol retroilluminato con strip Led RGB. Struttura in alluminio. Pareti laterali e posteriore rivestite in materiale specchiante.

Specificità: la possibilità di rotazione meccanica del modulo fa diventare questo elemento versatile nel posizionamento. Fornito come progetto speciale.

Light emission



Colour



“A one sq. m. module can become a section of a canvas on which man can express the pace of his relation with the place and with others. The additive synthesis principle is at the basis of this project, which offers unending colour dynamism and becomes a true vehicle for emotional and perceptive expression.”

Materials

Barrisol panel backlit with RGB Led strips. Aluminium frame. Sides and rear coated with a reflecting material.

Specification

The mechanical rotation of the module ensure a versatile positioning of this element. Supplied as special project.

“Un module d’un m² peut devenir une portion de toile sur laquelle l’homme peut exprimer ses rythmes, dans la relation avec le lieu et avec les autres. Le principe de la synthèse additive est à la base de ce projet qui offre un dynamisme chromatique infini, et devient un véritable moyen d’expression émotionnelle et perceptive.”

Matériaux

Panneau en barrisol rétro-éclairé avec strip Led RGB. Structure en aluminium. Parois latérales et postérieure revêtues de matière réfléchissante.

Spécificité

L’éventuelle rotation mécanique du module transforme cet élément réversible en positionnement. Produit spécial à définir pour tout projet.

“Ein Modul kann Teil einer Wand werden, auf der der Mensch seine Rythmen im Verhältnis zum Ort und zu anderen Orten ausdrückt. Das Prinzip der Addition liegt diesem Projekt zugrunde, welches eine unendliche chromatische Dynamik bietet und ein regelrechtes Ausdrucksmittel von Gefühlen und Wahrnehmungen darstellt.”

Materialien

Hinterleuchtetes Barrisol-Paneel mit RGB-Led-Streifen. Struktur aus Aluminium. Seitliche und hintere Wände mit spiegelndem Material verkleidet.

Spezifikation

Durch mechanisches Drehen lässt sich das Modul auf unterschiedlichste Positionen platzieren. Erhältlich als Sonderleuchte.

“Un módulo de un m² puede volverse porción de una tela en la que el hombre puede expresar sus ritmos, en la relación con el lugar y con los demás. El principio de la síntesis adicional es la base de este proyecto, que ofrece una infinita dinamicidad cromática, y se vuelve un verdadero medio de expresión emocional y perceptivo.”

Materiales

Panel de barrisol iluminado por detrás con strip Led RGB. Estructura de madera. Paredes laterales y traseras revestidas en material tipo espejo.

Especificaciones

La posibilidad de rotación mecánica del módulo hace que este elemento sea versátil en su posicionamiento. Suministrado como proyecto especial.

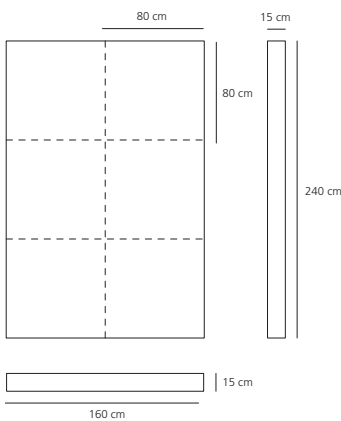

LED RGB max 55W/m²
Electronic ballasts

IP20 Dimmer





Radiofrequency remote control (included)



Wall mounted control panel (to order separately)





 **MODUL** 
ELECTRO
www.modulelectro.ru



”I limiti architettonici chiudono allo sguardo qualsiasi punto di fuga. Sottrarre materia solida e liberare la luce nella sua fluidità e dinamicità è un gesto di superamento di tali barriere percettive. Un pozzo di luce, a soffitto, come se fosse un’apertura verso la luce naturale, nella sua consistenza volumetrica, crea isole luminose. Esse diventano luoghi di passaggio, focus e punti nodali dell’esperienza legata al luogo.

Materiali: pannello in barrisol retroilluminato con gruppi di lampade fluorescenti RGB.

Specificità: fornito come progetto speciale.

Light emission



Colour



“The architectural limits ban all escape points from sight. Subtracting solid matter and releasing fluid and dynamic light means overcoming such perceptive barriers. A ceiling-mounted light pit, like an opening towards natural light, in its volumetric substance, creates luminous isles, which become transit places, focuses, and nodes of the location-based experience.”

“Les limites architecturales empêchent le regard de se poser sur n’importe quel point de fuite. Soustraire la matière solide et libérer la lumière dans sa fluidité et son dynamisme est un geste qui permet de dépasser ces barrières perceptives. Un puits de lumière, au plafond, comme s’il s’agissait d’une ouverture vers la lumière naturelle, dans sa consistance volumétrique, crée des îles lumineuses. Elles deviennent des lieux de passage, des foyers et des points nodaux de l’expérience liée au lieu.”

“Die architektonischen Grenzen entschwinden ins Nichts. Solide Materien zu entziehen und das Licht in seiner Flüchtigkeit und Dynamik zu befreien ist eine Art Überschreitung jener Wahrnehmungsgrenzen. Ein Lichtbrunnen, eine Deckenleuchte, die als Lichtinsel eine Öffnung zum natürlichen Licht in seiner volumetrischen Konsistenz schafft. Diese werden zu Übergangsorten, Fokus und Knotenpunkten - zum Erlebnis verbunden mit dem Ort.”

“Los límites arquitectónicos impiden la visión de cualquier punto de fuga. Sustraer materia sólida y liberar la luz en su fluidez y dinamicidad es un gesto de superación de dichas barreras perceptivas. Un pozo de luz, de techo, como si de una abertura hacia la luz natural se tratara, en su consistencia volumétrica, crea islas luminosas. Estas se vuelven lugares de paso, focus y puntos cruciales de la experiencia conectada al lugar.”



Materials

Barrisol panel backlit with groups of RGB fluorescent lamps.

Specification

Supplied as special project.

Matériaux

Panneau en barrisol rétro-éclairé avec des groupes de lampes fluorescentes RGB.

Spécificité

Produit spécial à définir pour tout projet.

Materialien

Hinterleuchtetes Barrisol-Panell mit RGB-Leuchtstoffröhren.

Spezifikation

Erhältlich als Sonderleuchte.

Materiales

Panel de barrisol iluminado por detrás con grupos de lámparas fluorescentes RGB.

Especificaciones

Suministrado como proyecto especial

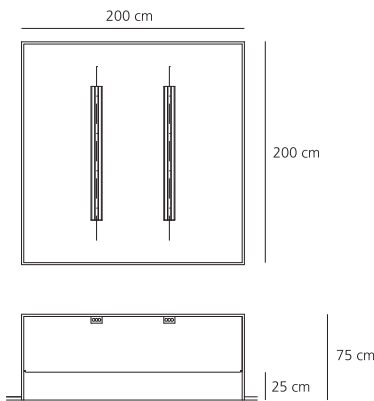

Kit: FLUO 3x54W RGB (G 5) – T 16, included
Electronic ballast
Max power for square meter: 140W/m2

IP20 Dimmer



Infrared remote control (included)



Wall mounted control panel (to order separately)

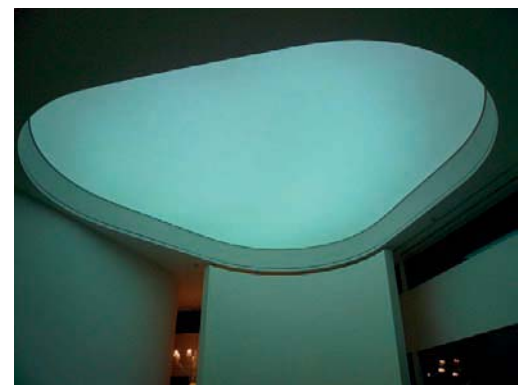
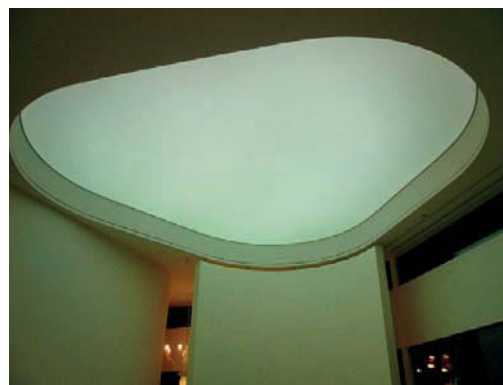

 **MODUL** 
ELECTRO

www.modulelectro.ru



Materiali: corpo in estruso di alluminio; copertura in vetro.

Specificità: apparecchio concepito per essere integrato in contesti architettonici che ne celano il corpo, lasciando trasparire solo l'effetto luce. Utilizza sorgenti fluorescenti RGB che consentono di ottenere infinite declinazioni della luce bianca, nelle sue diverse intensità e varietà delle temperature di colore, dalla più calda (2.500 K) alla più fredda (20.000 K). Le performance di luce sono gestite da una centralina elettronica e da un telecomando a radiofrequenza. Il kit è disponibile nelle versioni stand alone o sincronizzato, in cui al corpo lampada base si possono aggiungere fino a 9 apparecchi supplementari, comandabili dalla stessa centralina. Per un numero maggiore di apparecchi supplementari è necessario utilizzare un amplificatore di segnale.

Light emission



Colour

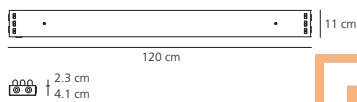

FLUO 3x54W RGB (G 5) – T 16, included
Electronic ballast

IP20 ⚡ ⚠ PG + Dimmer



Radiofrequency remote control (included)



Wall mounted control panel (to order separately)



Materials

Extruded aluminium body; glass cover.

Specification

Luminaire conceived to be introduced into architectural contexts that conceal the unit itself, only allowing the light effect to shine through. It uses fluorescent RGB light sources, which enable a limitless variation of white light with different intensities and a variety of colour temperatures, from the hottest (2.500 K) to the colder (20.000 K). The light performance is controlled by an electronic board and an infrared ray remote control. The kit is available in the stand alone or synchronised versions, in which up to 9 supplementary items, controllable from the same board, can be added to the basic lamp unit. For more supplementary items the use of a signal amplifier is required.

Matériaux

Corps en aluminium extrudé; couverture en verre.

Spécificité

Appareil conçu pour être intégré dans l'architecture afin de ne percevoir que l'effet lumineux. Il utilise des sources fluorescentes RGB qui permettent d'obtenir d'innombrables déclinaisons de la lumière blanche dans les différentes intensités et les variétés de températures de couleur, de la plus chaude (2.500 K) à la plus froide (20.000 K). Les performances lumineuses sont gérées par une centrale électronique et par une télécommande infrarouge. Il est possible d'ajouter au module de base jusqu'à neuf appareils supplémentaires commandés par la même centrale. Au-delà, un amplificateur de signal est nécessaire.

Materialien

Körper aus fließepresstem Aluminium; Abdeckung aus Glas.

Spezifikation

Das System wurde entwickelt, um eine "unsichtbare" Integration in architektonische Umgebungen zu ermöglichen. Hierbei wird die optische Wirkung allein durch das Licht erzielt; der Leuchtenkörper ist nicht sichtbar. Durch den Einsatz von RGB-Leuchtstofflampen lassen sich in Bezug auf die Farbtemperatur und Farbintensität verschiedene Abstufungen des Weißlichts kreieren – von den wärmsten (2.500 K) bis zu den kältesten (25.000 K). Die Regelung der verschiedenen Funktionen erfolgt über eine Steuerungseinheit und eine Infrarot-Fernbedienung. Das System ist in den Versionen "Stand alone" oder "Synchro" erhältlich. Bei der Synchro-Ausführung können an die Basisleuchte bis zu 9 Zusatzleuchten angeschlossen werden. Diese werden ebenfalls über die Steuerungseinheit geschaltet. Zur Steuerung weiterer Zusatzleuchten ist die Verwendung eines Signal-Verstärkers notwendig.

Materiales

Cuerpo en aluminio extruido; cubierta en cristal.

Especificaciones

Aparato concebido para iluminar contextos arquitectónicos, que ocultan el cuerpo de la lámpara, a fin de enseñar exclusivamente el efecto que genera la luz. Incorpora fuentes de luz fluorescentes RGB de color rojo, verde y azul, a efectos de obtener una gradación infinita de la luz blanca, con toda su variedad de intensidades y un amplio abanico de temperaturas-color, de muy fría (2.500 K) a muy cálida (20.000 K). Las características de la luz se gobiernan por medio de una central electrónica y de un mando a distancia de rayos infrarrojos. El kit está disponible en las versiones Stand Alone o Sincronizado. En esta última, al cuerpo de la lámpara, que hace de base, se le pueden añadir hasta 9 aparatos suplementarios, que se gobiernan mediante la misma central. Para un mayor número de aparatos suplementarios es necesario utilizar un amplificador de señal.



Materiali: acciaio.

Specificità: apparecchi concepiti per essere integrati in contesti architettonici che ne celano il corpo, lasciando trasparire solo l'effetto luce. I kit sono costituiti da 3 o 4 proiettori alogeni con i filtri dicroici rosso, verde e blu, che consentono di ottenere infinite atmosfere di luce colorata. Sono disponibili nelle versioni stand alone o sincronizzati, in cui al corpo lampada base si possono aggiungere fino a 120 apparecchi supplementari comandabili dalla stessa centralina (30 per ogni canale d'uscita).

Metamorfosi kit 4: costituito da quattro proiettori. Attraverso un telecomando è possibile selezionare 12 atmosfere standard, crearne e memorizzarne ulteriori 86, e agire sull'intensità luminosa.

Metamorfosi kit 3: costituito da tre proiettori. Attraverso un telecomando è possibile gestire 10 atmosfere standard, crearne e memorizzarne ulteriori 10 e agire sull'intensità luminosa.

Light emission



Colour

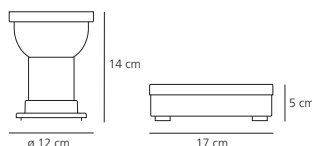

Metamorfosi Kit 3

HALO max 3x150W (B 15d) – ECO, included

IP20 + Dimmer



Infrared remote control (included)



Wall mounted control panel (to order separately)

Metamorfosi Kit 4

HALO max 4x150W (B 15d) – ECO, included

IP20 + Dimmer



Infrared remote control (included)



Wall mounted control panel (to order separately)

Materials

Steel.

Specification

Luminaires conceived to be introduced into architectural contexts that conceal the unit itself, only allowing the light effect to shine through. The kits are composed by 3 or 4 halogen projectors with dichroic filters, red, green and blue, which allow to create a wide range of light coloured atmospheres. They are available in stand alone or in synchronised versions, to which basic lamp unit can be added up to 120 supplementary items, controllable from the same board (30 for each output).

Metamorfosi kit 4

Composed by 4 projectors. It is possible, using a remote control, to select 12 standard atmospheres, to create and memorise other 86 and to adjust the light intensity.

Metamorfosi kit 3

Composed by 3 projectors. It is possible, using a remote control, to select 10 standard atmospheres, to create and memorise other 10 and to adjust the light intensity.

Matériaux

Acier.

Spécificité

Appareil conçu pour être inséré dans l'architecture afin de ne percevoir que l'effet lumineux. Les kits sont composés de 3 ou 4 projecteurs avec filtres dichroïques rouge, vert et bleu, permettant d'obtenir de nombreuses atmosphères de lumière colorée. Ils sont disponibles en version stand alone ou synchronisée et il est possible d'ajouter au module de base jusqu'à 120 appareils supplémentaires, commandés par la même centrale. (30 pour chaque conduit de sortie).

Metamorfosi kit 4

Composé de 4 projecteurs. A l'aide de la télécommande, il est possible de sélectionner 12 atmosphères standard, d'en créer et d'en mémoriser 86 autres et d'agir sur l'intensité lumineuse.

Metamorfosi kit 3

Composé de 3 projecteurs. A l'aide de la télécommande, il est possible de sélectionner 10 atmosphères standard, d'en créer et d'en mémoriser 10 autres et d'agir sur l'intensité lumineuse.

Materialien

Stahl.

Spezifikation

Das System wurde entwickelt, um eine "unsichtbare" Integration in architektonische Umgebungen zu ermöglichen.

Hierbei wird die optische Wirkung allein durch das Licht erzielt; der Leuchtenkörper ist nicht sichtbar. Die

Metamorfosi-Kits bestehen aus 3 oder 4 Strahlern mit dichroischen Filtern in den Grundfarben Rot, Grün und Blau. Mit Hilfe der Filter lassen sich vielfältige farbige Lichtstimmungen kreieren. Erhältlich als Stand Alone oder Synchro-Ausführung. Bei der Synchro-Ausführung können an die Basisleuchte bis zu 120 Zusatzleuchten angeschlossen werden, die über eine Steuerungseinheit geschaltet werden (30 Leuchten für jeden Ausgangskanal).

Metamorfosi kit 4

Bestehend aus 4 Strahlern. Die Lichtstimmungen sind über eine Fernbedienung regelbar (12 Standardlichtstimmungen 86 Einstellungen, der Lichtstärke).

Metamorfosi kit 3

Bestehend aus 3 Strahlern. Die Lichtstimmungen sind über eine Fernbedienung regelbar (10 Standardlichtstimmungen 10 Einstellungen, der Lichtstärke).

Materiales

Acero.

Especificaciones

Aparatos para iluminar contextos arquitectónicos, que ocultan el cuerpo de la lámpara, a fin de enseñar exclusivamente el efecto que genera la luz.

Los kits de Metamorfosi están constituidos por 3 o 4 proyectores halógenos con filtros dicroicos, rojo, verde y azul, que permiten obtener infinitas atmósferas de luz coloradas.

Se presentan en versiones stand alone o sincronizados y a las cuales el cuerpo de la lámpara, que hace de base, se le pueden añadir hasta 9 aparatos suplementarios, que se gobiernan mediante la misma central (30 para cada canal de salida).

Metamorfosi kit 4

Constituido por 4 proyectores. Mediante un mando a distancia es posible manejar 12 atmósferas standard, crear y memorizar otras 86 y actuar en la intensidad luminosa.

Metamorfosi kit 3

Constituido por 3 proyectores. Mediante un mando a distancia es posible manejar 10 atmósferas standard, crear y memorizar otras 10 y actuar en la intensidad luminosa.



Kit 3



Kit 4



MODUL
ELECTRO
www.modulelectro.ru



MODUL
ELECTRO
www.modulelectro.ru

Tolomeo parete
Tolomeo mini parete
Tolomeo micro parete
Tolomeo braccio

design
 Michele De Lucchi
 Giancarlo Fassina
 1987, 1991, 1996, 2000, 2006

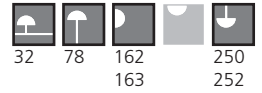

Awards
 Tolomeo parete
 Compasso d'Oro / ADI
 1989 – Milano (Italia)

Materiali: struttura a bracci mobili in alluminio lucidato; diffusore in alluminio anodizzato opaco o alluminio brillantato; snodi e supporto parete in alluminio brillantato.

Specificità: sistema di equilibratura a molle.

Light emission



Materials
 Cantilevered arms in polished aluminium; diffuser in matt anodised or polished aluminium; joints and wall support in polished aluminium.

Matériaux
 Structure à bras articulés en aluminium poli; diffuseur en aluminium anodisé opaque ou aluminium brillant; rotules et support applique en aluminium brillant.

Materialien
 Verstellbare Leuchtenarme aus glänzendem Aluminium; Leuchtenkopf aus matteneloxiertem oder poliertem Aluminium; Gelenke und Sockel der Wandleuchte aus poliertem Aluminium.

Materiales
 Estructura de brazos móviles, de aluminio pulido; difusor de aluminio anodizado mate o brillante; articulaciones y soporte de pared, de aluminio brillante.

Specification
 System of spring balancing.

Spécificité
 Système d'équilibrage à ressorts.

Spezifikation
 Mit Federausgleichsystem.

Especificaciones
 Sistema de compensación dinámica de resortes.

Colours

Tolomeo parete

- Metal grey (all versions)
- Black (halo and fluo version only)
- Mirror (halo version only)
- White (halo version only)

Tolomeo Mini parete

- Metal grey (all versions)
- Black (halo and fluo version only)

Tolomeo Micro parete

- Metal grey
- Black
- Metal dark grey
- Metal Red
- Metal Yellow
- Bronze
- Metal Orange
- Metal Green
- Metal Turquoise
- Metal Blue
- Mirror

Tolomeo Braccio

- Metal grey

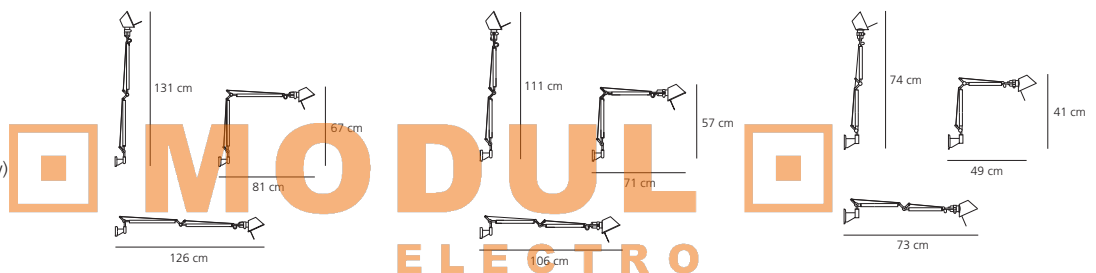

Tolomeo parete HALO max 1x70W (E27) - ES, included
Tolomeo mini parete HALO max 1x70W (E27) - ES, included
Tolomeo micro parete HALO max 1x60W (E 14) - QT 26

IP20

FLUO 1x18W (G 24 q-2) - TC-DEL
 Electronic ballast, darklight louvre included
IP20

LED 10W, included
 (illuminance: max 1250 lux, cm 40h)
IP20 + - Dimmer

MY WHITE LIGHT®
 LED 15W, (4 amber + 4 white + 2 blue), included
 (illuminance: max 1250 lux, cm 40h)
IP20 + - Dimmer

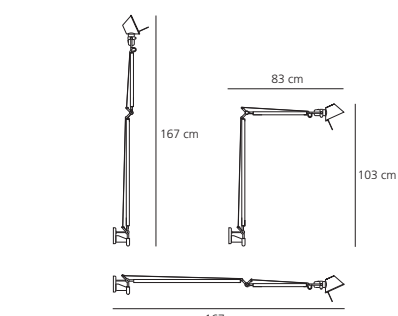

Tolomeo braccio
 HALO max 1x70W (E27) - ES
IP20



Tolomeo Braccio

MODUL
ELECTRO

www.modulelectro.ru



Tolomeo parete
Tolomeo mini parete

Tolomeo faretto
Tolomeo micro faretto

design
Michele De Lucchi
Giancarlo Fassina
1995, 2000



Materiali: supporto parete in alluminio lucidato; diffusore in alluminio anodizzato opaco.

Specificità: la versione micro è disponibile con o senza interruttore.

Light emission



Colour

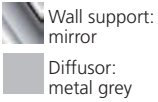

Materials

Wall support in polished aluminium; diffuser in matt anodised aluminium.

Specification

The Micro version is available with or without switch.

Matériaux

Support applique en aluminium poli ; diffuseur en aluminium anodisé opaque.

Spécificité

La version Micro est disponible avec ou sans interrupteur.

Materialien

Sockel der Wandleuchte aus glänzendem Aluminium; Kopf aus matt-eloxiertem Aluminium.

Spezifikation

Die Tolomeo micro faretto ist wahlweise mit oder ohne Schalter erhältlich.

Materiales

Soporte de aplique, de aluminio pulido; difusor de aluminio o anodizado mate.

Especificaciones

La versión micro está disponible con interruptor o sin interruptor.

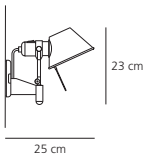

Tolomeo faretto

HALO max 1x70W (E27) - ES,

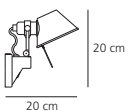

Tolomeo micro faretto

HALO max 1x60W (E 14) – QT 26



Tolomeo faretto

Tolomeo micro faretto

Tolomeo pinza
Tolomeo micro pinza

design
Michele De Lucchi
Giancarlo Fassina
1995, 2000

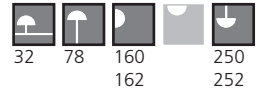

Awards

iF Product Design Award
1996 – Hannover (Deutschland)
"D'Excellence Marie-Claire Maison"
1996 – Paris (France)

Materiali: supporto in alluminio lucidato; diffusore in alluminio anodizzato opaco; pinza in acciaio.

Light emission



Materials

Support in polished aluminium,
diffuser in matt anodised aluminium;
steel pincer grip.

Matériaux

Support en aluminium poli ;
diffuseur en aluminium anodisé
mat, pince en acier.

Materialien

Halterung aus poliertem
Aluminium; Kopf aus
matt-eloxiertem Aluminium;
Klemme aus Stahl.

Materiales

Soporte de aluminio pulido;
difusor de aluminio anodizado
mate; pinza de acero.

Colours

Tolomeo pinza



Tolomeo micro pinza

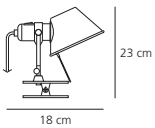
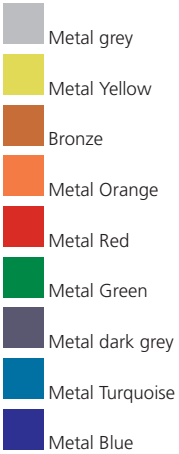

Tolomeo pinza

HALO max 1x70W (E27) - ES,

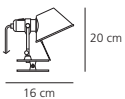

Tolomeo micro pinza

HALO max 1x60W (E 14) – QT 26



Tolomeo pinza

Tolomeo micro pinza

Tolomeo parete diffusore 18
Tolomeo parete diffusore 24
Tolomeo parete diffusore 32

design
 Michele De Lucchi
 Giancarlo Fassina
 2006



Materiali: braccio in alluminio lucidato; supporto parete in alluminio brillantato; diffusore in carta pergamena o in raso di seta supportato da materiale plastico.

Specificità: il braccio presenta uno snodo che permette al diffusore di ruotare di circa 30° perpendicolarmente alla parete.

Light emission



Colours



Materials

Arm and wall support in polished aluminium; diffuser in parchment paper or in silk satin fabric on a plastic frame.

Matériaux

Bras en aluminium poli; support applique en aluminium brillant; diffuseur en papier parchemin ou en polycarbonate recouvert de satin de soie.

Materialien

Leuchtenarm aus hochglanzpoliertem Aluminium; Wandhalterung aus glänzendem Aluminium; Schirm aus mit Kunststoff stabilisiertem Pergamentpapier oder Seidensatin.

Materiales

Brazo de aluminio pulido; soporte de pared de aluminio brillante; difusor en pergamino o en raso seda reforzado con plástico.

Specification

The arm presents an articulation that enables the diffuser to rotate around 30° perpendicular to the wall.

Spécificité

Le bras est doté d'une articulation permettant au diffuseur de tourner d'environ 30° perpendiculairement au mur.

Spezifikation

Der Leuchtenarm ist mit einem Gelenk ausgestattet, das eine Drehung des Schirms um ca. 30° ermöglicht.

Especificaciones

El brazo posee una articulación, merced a la cual el difusor logra girar a unos 30°, perpendicularmente a la pared.

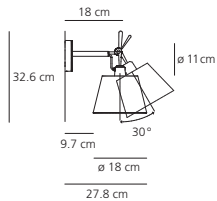

Tolomeo parete diffusore 18
 HALO max 1x42W (E 27) – ES
 (for parchment paper diffuser only)
 or
 HALO max 1x70W (E 27) – ES
 IP20 ⚡ ⚠ ⚙ Ⓜ Ⓢ

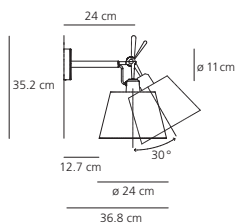

Tolomeo parete diffusore 24
 HALO max 1x70W (E 27) – ES
 IP20 ⚡ ⚠ ⚙ Ⓜ Ⓢ

FLUO 1x18W (GX 24 q-2) – TC-TEL
 Electronic ballast integrated in the lampholder
 IP20 ⚡ ⚠ ⚙ Ⓜ Ⓢ

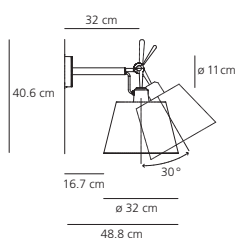

Tolomeo parete diffusore 32
 HALO max 1x150W (E 27) – ECO
 IP20 ⚡ ⚠ ⚙ Ⓜ Ⓢ



Tolomeo parete diffusore 32

Tolomeo parete diffusore 24

Tolomeo parete diffusore 18



MODUL
ELECTRO

www.modulelectro.ru

Tolomeo basculante parete

design

Michele De Lucchi
Giancarlo Fassina
2004



Materiali: struttura a bracci mobili in alluminio lucidato; diffusore in carta pergamena o in raso di seta supportato da materiale plastico; supporto parete in alluminio brillantato.

Specificità: il diffusore, nel normale utilizzo, si dispone verticalmente, indipendentemente dall'angolazione del braccio. Sistema di equilibratura a molle.

Light emission



Colours



Wall support and arms:
mirror



Diffuser:
natural



Diffuser:
grey

Materials

Cantilevered arms in polished aluminium; diffuser in parchment paper or in silk satin fabric on a plastic frame; wall support in polished aluminium.

Matériaux

Structure à bras articulés en aluminium poli; diffuseur en papier parchemin ou en polycarbonate recouvert de satin de soie; support applique en aluminium brillant.

Materialien

Ausrichtbare Arme aus glänzendem Aluminium; Schirm aus mit Kunststoff stabilisiertem Pergamentpapier oder Seidensatin; Wandhalterung aus poliertem Aluminium. Federausgleichsystem.

Materiales

Base y estructura con brazos móviles de aluminio pulido; difusor en pergamino o en raso seda reforzado con plástico; articulaciones de aluminio pulido. Soporte aplique de aluminio pulido.

Specification

The diffuser normally used, remains vertical regardless of the angle of the arm. System of spring balancing.

Spécificité

Le diffuseur dans le cadre d'une utilisation normale, se place verticalement, indépendamment de la position du bras. Système d'équilibrage à ressorts.

Spezifikation

Der Schirm steht bei normalem Gebrauch in vertikaler Position, unabhängig von der Ausrichtung des Armes. Federausgleichsystem.

Especificaciones

En su uso normal, el difusor se dispone verticalmente, independientemente de la angulación del brazo. Sistema de equilibrado a muelles.

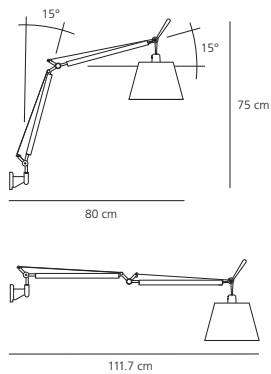

HALO max 1x70W (E 27) – ES

IP20    

MODULO
ELECTRO
www.modulelectro.ru



Tolomeo Mega parete

design

Michele De Lucchi
Giancarlo Fassina
2003



Materiali: struttura a bracci mobili in alluminio lucidato; diffusore in carta pergamena o in raso di seta supportato da materiale plastico; supporto parete in alluminio brillantato.

Specificità: diffusore disponibile in tre dimensioni, orientabile in tutte le direzioni. Sistema di equilibratura a molle.

Light emission



Colours



Wall support and arms:
mirror



Diffuser:
natural



Diffuser:
grey

Materials

Cantilevered arms in polished aluminium; diffuser in parchment paper or in silk satin fabric on a plastic frame; wall support in polished aluminium.

Matériaux

Structure à bras articulés en aluminium poli; diffuseur en papier parchemin ou en poly-carbonate recouvert de satin de soie ; support applique en aluminium brillant.

Materialien

Ausrichtbare Arme aus glänzendem Aluminium; Schirm aus mit Kunststoff stabilisiertem Pergamentpapier oder Seidensatin; Wandhalterung aus poliertem Aluminium. Federausgleichsystem.

Materiales

Base y estructura con brazos móviles de aluminio pulido; difusor en pergamino o en raso seda reforzado con plástico; articulaciones de aluminio pulido. Soporte aplique de aluminio pulido.

Specification

Diffuser, available in three sizes, adjustable in all directions. System of spring balancing.

Spécificité

Diffuseur disponible en trois tailles, orientable dans toutes les directions. Système d'équilibrage à ressorts.

Spezifikation

Der Leuchtenkopf, erhältlich in drei Größen, lässt sich in alle Richtungen verstellen. Federausgleichsystem.

Especificaciones

Difusor disponible en tres tamaños, orientable en todas direcciones. Sistema de equilibrado a muelles.

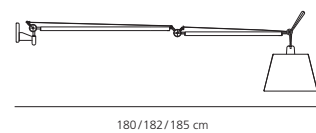
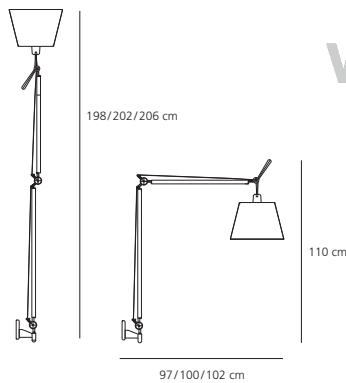
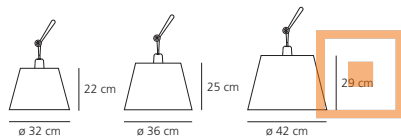

HALO max 1x150W (E 27) – ECO



Alicudi

design

Ora Ito
2007



Materiali: struttura in acciaio verniciato; diffusore in metacrilato opalino; rivestimento in tessuto bianco bielastico con texture sublimata.

Light emission



Colour



White

Materials

Painted steel structure; opal methacrylate diffuser; white doublestretch fabric cover with texture.

Matériaux

Structure en acier peint. Diffuseur en méthacrylate opalin. Revêtement en tissu blanc bi-élastique avec texture.

Materialien

Rahmen aus lackiertem Stahl; Schirm aus Opal-Metakrylat; Bezugsstoff aus weißem Stretchgewebe.

Materiales

Estructura en acero pintado; Difusor en metacrilato opalino; revestimiento en tejido blanco bielastizado con textura.

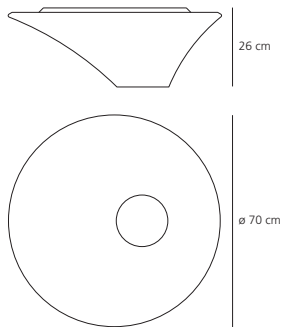

FLUO 2x42W (GX 24q-4) – TC-TEL
Electronic ballast



MODUL
ELECTRO
www.modulelectro.ru

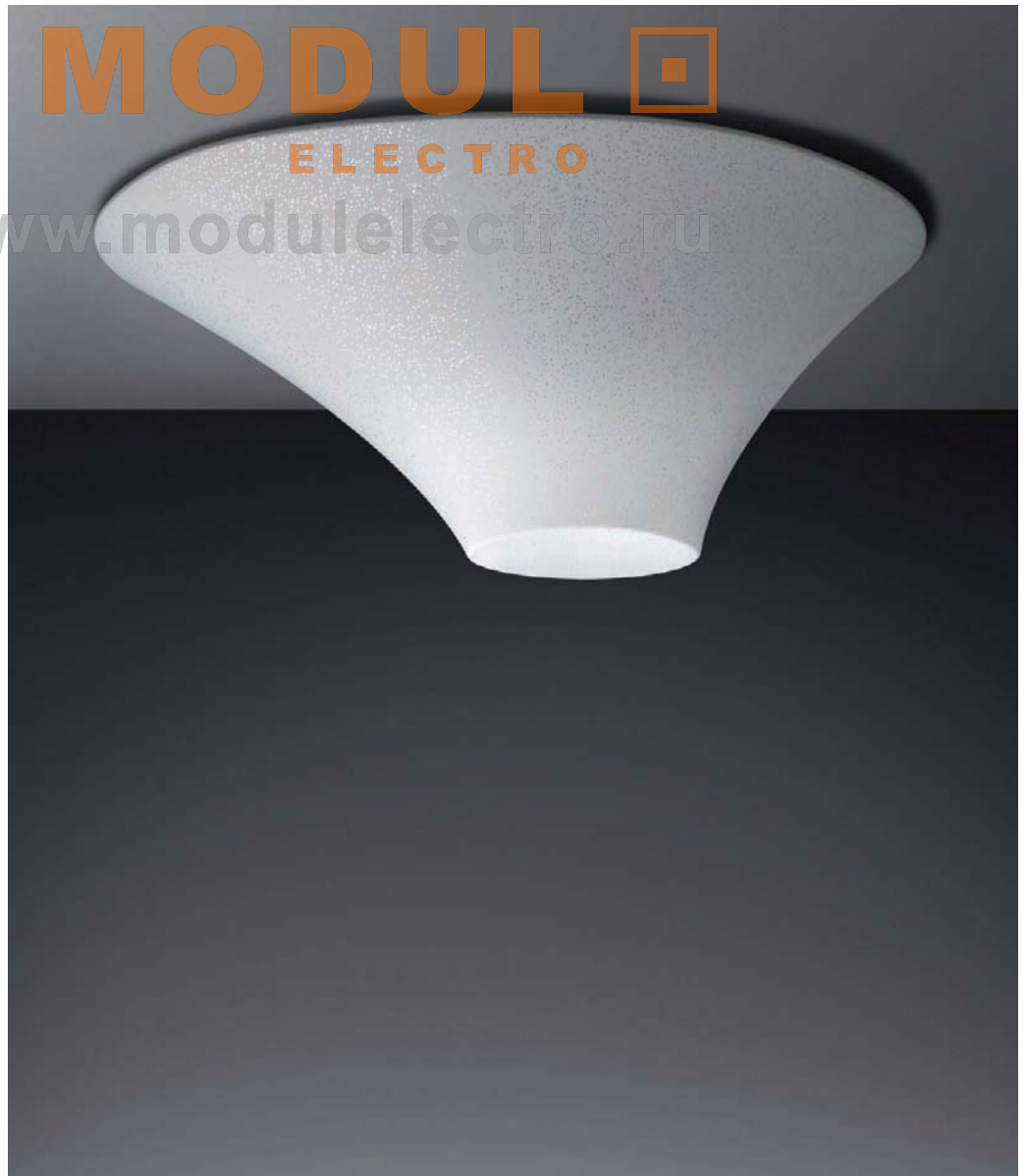

Melampo parete

design

Adrien Gardère
2003



Materiali: attacco parete in alluminio verniciato; diffusore in raso di seta, supportato da materiale plastico.

Specificità: diffusore orientabile in due diverse posizioni.

Light emission



Colours

- Wall support: grey
- Diffuser: grey
- Wall support: bronze
- Diffuser: natural

Materials

Wall support in painted aluminium; diffuser in silk satin fabric on a plastic frame,

Specification

Adjustable diffuser into two different positions.

Matériaux

Support applique en aluminium peint ; diffuseur en polycarbonate recouvert de satin de soie.

Spécificité

Diffuseur orientable dans deux positions

Materialien

Sockel der Wandleuchte aus lackiertem Aluminium; Schirm aus Seidensatin (stabilisiert mit Kunststoff).

Spezifikation

Der Schirm ist in zwei unterschiedliche Positionen verstellbar.

Materiales

Soporte de aplique de aluminio pintado; difusor en raso seda reforzado con plástico.

Especificaciones

Difusor orientable en dos posiciones diferentes.

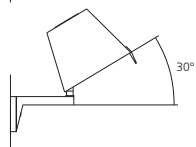
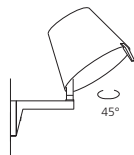
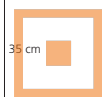
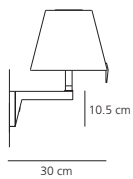

INC max 1x60W (E 14) – D 45
with or without on/off switch on body lamp



Choose parete
 Choose Led
 Choose parete + Led
 Choose incasso Led

design
 Matteo Thun
 2006, 2008



Materiali: struttura in metallo verniciato; diffusore in policarbonato trasparente, accoppiato a un foglio di polipropilene serigrafato rosso o da carta pergamenata. Guscio in policarbonato (Choose Led, Choose incasso Led).

Specificità: particolarmente indicate per le camere da letto, abbinano a una luce diffusa un fascio concentrante orientabile Led.

Light emission



Colours

Choose parete

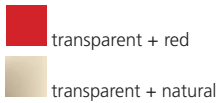

Choose parete + Led

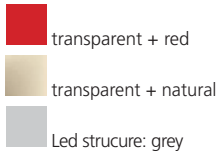

Choose Led, Choose incasso Led

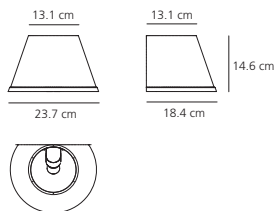
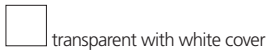

Choose parete

INC max 1x60W (E 14) – D 45
 On/off switch on body lamp



Choose parete IP23

INC max 1x60W (E 14) – D 45

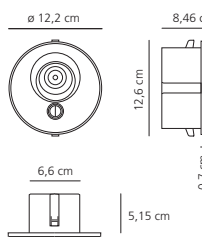

Choose incasso Led

LED 1W white (2.700 K)
 With or without on/off switch on body lamp



Materials

Painted metal structure; diffuser in transparent polycarbonate, joined with red silkscreened polypropylene sheet or with parchment paper. Polycarbonate shell (Choose Led, Choose incasso Led).

Specification

Particularly suitable for bedrooms, they link together a diffused light with a Led concentrated and adjustable flow.

Matériaux

Structure en métal verni, diffuseur en polycarbonate couplé avec une feuille de polypropylène sérigraphié rouge ou de papier parchemin. Coque en polycarbonate (Choose Led, Choose incasso Led).

Spécificité

Particulièrement destinée à la chambre à coucher, elle procure une lumière diffuse avec un flux concentré et orientable grâce au Led.

Materialien

Lackierte Metallstruktur; Leuchtschirm aus Polycarbonat, mit rot bedrucktem Polypropylen oder Pergamentpapier zusammengestellt. Gehäuse aus Polycarbonat (Choose Led, Choose incasso Led).

Spezifikation

Speziell beim Einsatz in Schlafzimmern schafft das diffuse Licht in Verbindung mit der konzentrierten LED-Beleuchtung ein hervorragendes Leselicht.

Materiales

Estructura metálica pintada; difusor de policarbonato, junto con una lámina de polipropileno con serigrafía roja o con papel pergamino. Choose Led y Choose incasso Led: carcasa de policarbonato.

Especificaciones

Especialmente indicadas para dormitorios, junto a una luz difusa otorgan una luz concentrada y orientable Led.

MODULO ELECTRO

www.modulelectro.ru

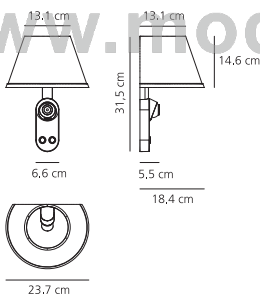

Choose parete + Led

INC max 1x60W (E 14) – D 45
 LED 1W white (2.700 K)
 On/off switch on body lamp

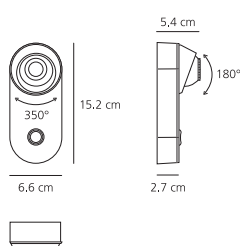

Choose Led

LED 1W white (2.700 K)
 On/off switch on body lamp



Choose parete + Led



MODUL
ELECTRO

www.modulelectro.ru



Choose incasso Led



Choose Led



Cadmo parete

design

Karim Rashid
2009



68

Materiali: corpo lampada in materiale termoplastico stampato a iniezione; riflettore in alluminio ottico.

Light emission



Colours



Polished white



Polished black/white



Polished red/white

Materials

Body lamp in injection-moulded thermoplastic material; reflector in optic aluminium.

Matériaux

Corps en matériau thermoplastique moulé par injection ; réflecteur en aluminium à haut rendement.

Materialien

Reflektierender Leuchtenkörper aus Spritzguss-Thermoplast; Reflektor in Aluminium-Optik.

Materiales

Cuerpo de la lámpara en material termoplástico estampado a inyección; reflector en aluminio óptico.



MODUL
ELECTRO
www.modulelectro.ru

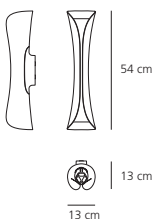

FLUO 2x26/32W (GX 24 q-3) – TC-TEL
Electronic ballast





MODUL
ELECTRO

www.modulelectro.ru

Talak parete Talak parete Led

design

Neil Poulton
2005, 2007



Awards

"Observateur du Design" 2005
Etoile 2005 A.P.C.I. – Paris (France)
Design Innovationen Design Zentrum
Nordrhein Westfalen
Reddot Design Award – Product Design
"Best of the Best 2006"
Essen (Deutschland)
Compasso D'oro / A.D.I.
Segnalazione
2008 – Milano (Italia)

Materiali: supporto parete in alluminio pressofuso; stelo in acciaio cromato lucido; corpo lampada in resina termoplastica verniciata.

Specificità: il corpo lampada ruota sul piano orizzontale ed è regolabile in altezza.

Light emission



Colours



Diffuser:
white



Stem:
mirror

Materials

Wall support in diecast aluminium; polished chromed steel stem; body lamp in painted thermoplastic resin.

Matériaux

Support applique en aluminium moulé ; tige en acier poli chromé, corps en résine thermoplastique vernie.

Materialien

Wandbefestigung aus Aluminium; Stab aus Stahl, Chrom poliert; Leuchtenkörper aus lackiertem Kunstharz.

Materiales

Soporte pared en aluminio presofuso; tija en acero cromado brillante; cuerpo de la lámpara en resina termoplástica pintada.

Specification

The body lamp rotates on the horizontal plane and is adjustable in height.

Spécificité

Le corps de la lampe s'oriente sur le plan horizontal et se règle en hauteur.

Spezifikation

Der Leuchtenkörper kann horizontal gedreht werden und ist höhenverstellbar.

Especificaciones

El cuerpo de la lámpara gira en sentido horizontal y es regulable en altura.

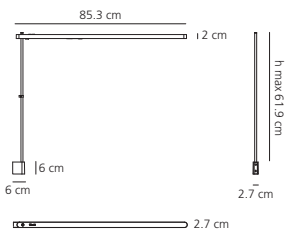

Talak parete

FLUO 1x13W (W 4,3x8,5d) – T2, included
Electronic ballast



Talak tavolo Led

LED 80x0,1W, included
(illuminance: max 710 lux, h. 40 cm)



MODUL
ELECTRO
www.modulelectro.ru



Pipe parete/soffitto

design

Herzog & de Meuron
2007



Materiali: struttura in acciaio flessibile verniciato, rivestita da una guaina in silicone platinico naturale (anti ingiallimento); attacco parete e diffusore in policarbonato trasparente verniciato effetto gomma; riflettore in alluminio speculare con microforature irregolari; fondello in acciaio verniciato.

Specificità: flessibile ed orientabile.

Light emission



Colour



Transparent satin

Materials

Flexible painted steel structure, covered with a natural anti-yellowing silicone case; wall attachment and diffuser in transparent rubber-effect painted polycarbonate; mirror aluminium reflector with random perforations; painted steel bottom plate.

Matériaux

Structure en acier flexible peint, revêtue d'une gaine en silicone naturelle (anti-jaunissement). Support applique et diffuseur en polycarbonate transparent peint effet caoutchouc. Réflecteur en aluminium spéculaire microperforé. Fond en acier peint.

Materialien

Rahmen aus lackiertem Stahl mit transparentem Silikonüberzug (gegen Vergilbung); Anschlussstück zur Wandmontage und Lichtverteiler aus transparentem Polycarbonat mit Soft-Touch-Lackierung; Reflektor aus hochglanzlackiertem Aluminium mit unregelmäßig angeordneten Mikrobohrungen.

Materiales

Estructura en acero flexible y pintado, revestida con una camisa de silicona platinica natural (antioxidante); soporte y difusor en policarbonato transparente pintado, efecto caucho. Reflector en aluminio espejular, con microorificios irregulares. Fondo en acero pintado.

Specification

Flexible and adjustable.

Spécificité

Flexible et orientable.

Spezifikation

Vielseitige, beliebig verstellbare Leuchte.

Especificaciones

Pipe es flexible y orientable.

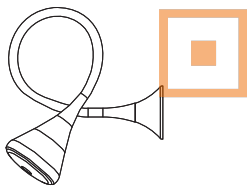
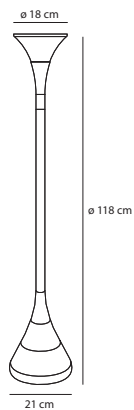

FLUO 1x32W (GX 24 q-3) – TC-TEL, included
Electronic ballast



MODUL
ELECTRO
www.modulelectro.ru

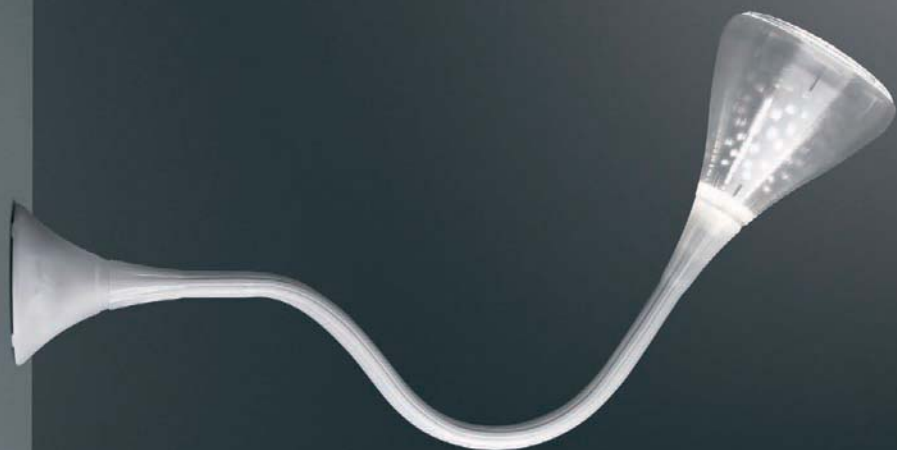

Edge parete/soffitto 21
Edge parete/soffitto 30

design
 Alessandro Mendini
 2004



266



Materiali: supporto parete in resina termoplastica; diffusore in materiale termoplastico.

Specificità: il grado di protezione IP65 la rende idonea all'utilizzo anche in esterno.

Light emission



Colour



White

Materials

Wall support in thermoplastic resin; diffuser in thermoplastic material.

Specification

The IP 65 degree of protection makes it also suitable for outdoor application.

Matériaux

Support applique en résine thermoplastique; diffuseur en matériau thermoplastique.

Spécificité

L'indice de protection IP 65 permet l'installation de l'appareil en extérieur.

Materialien

Wandhalterung aus Kunstharz; Schirm aus thermoplastischem Material.

Spezifikation

Durch Schutzart IP 65 auch im Außenbereich einsetzbar.

Materiales

Soporte aplique de resina termoplástica; difusor en material termoplástico.

Especificaciones

El grado de protección IP 65 la hace idónea para exteriores.

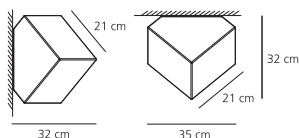

Edge parete/soffitto 21
 FLUO 1x20W (E 27) – TC-TSE

IP65 □ F PG

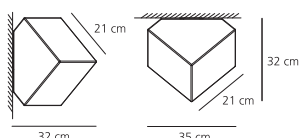

Edge parete/soffitto 30
 FLUO 1x23W (E 27) – TC-TSE

IP65 □ F PG

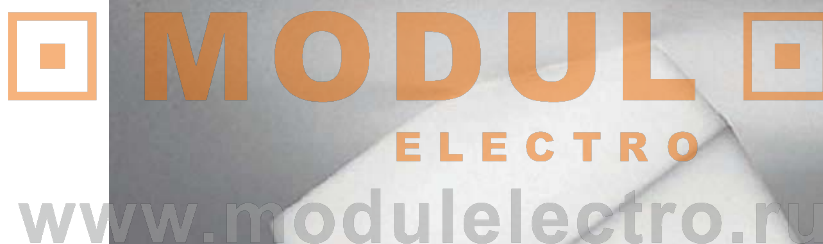

Teti

design

Vico Magistretti
1970



Materiali: policarbonato traslucido (versioni colorate) o in resina termoplastica (versione bianca).

Specificità: possibilità di comporre configurazioni multiple.

Light emission



Colours



Polished white



Trasparent



Trasparent dark grey



Trasparent orange

Materials

Translucent polycarbonate (coloured version); thermoplastic resin (white version).

Specification

It is possible to create multiple configurations.

Matériaux

Polycarbonate translucide (version colorée) ou en résine thermoplastique (version blanche).

Spécificité

Permettant de créer de multiples applications.

Materialien

Farbige Ausführungen aus transluzentem Polycarbonat, weiße Ausführung aus Kunstharz.

Spezifikation

Die Vielzahl an Kombinationsmöglichkeiten gestattet die Anwendung individueller Konfigurationen.

Materiales

Policarbonato traslúcido (versiones color) o de resina termoplástica (versión blanca).

Especificaciones

Posibilidad de componer configuraciones múltiple.

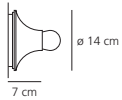

INC max 1x40W (E 14) – D 45

IP20

MODUL
ELECTRO

www.modulelectro.ru

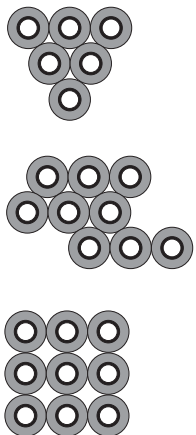

Configuration examples

Zeffiro 80
Zeffiro 140

design
Pio & Tito Toso
2007, 2008



Materiali: struttura in acciaio verniciato; diffusori in metacrilato opalino.

Light emission



Colour



White

Materials

Painted steel structure; opal methacrylate diffusers.

Matériaux

Structure en acier peint; diffuseurs en méthacrylate opalin.

Materialien

Struktur aus lackiertem Stahl; Schirme aus opalem Metakryl.

Materiales

Estructura en acero pintado; difusores en metacrilato opalino.

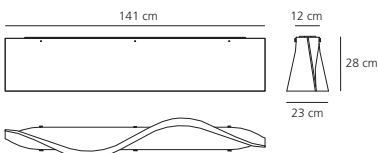

Zeffiro 140

FLUO 2x54W (G 5) – T 16, included
Electronic ballast

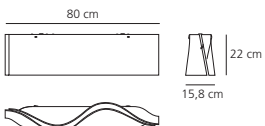

Zeffiro 80

FLUO 1x80W (2G 11) – T16, included
Electronic ballast



Telefo 50
Telefo 70
Telefo 120
Telefo 170
Telefo 72 vetro Murano

design
 Örne Hallween
 1994, 2003



Materiali:

Telefo 50, 70, 120, 170: supporto parete in alluminio; diffusore in metacrilato opalino; testate di chiusura in metallo cromato lucido.

Telefo 72 vetro Murano: supporto parete in resina termoplastica; diffusore in vetro soffiato; testate di chiusura in alluminio cromato lucido.

Light emission



Colour

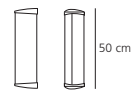

Telefo 50
 FLUO 2x11W (G 23) – TC-S

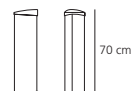

Telefo 70
 FLUO 1x18W (G 13) – T 26

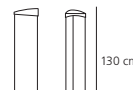

Telefo 120
 FLUO 1x36W (G 13) – T 26

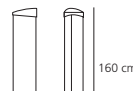

Telefo 170
 FLUO 1x58W (G 13) – T 26 Electronic ballast



Telefo 72 vetro Murano
 FLUO 2x24W (2G 11) – TC-L Electronic ballast



Materials

Telefo 50, 70, 120, 170: wall support in aluminium; diffuser in opaline methacrylate; end plates in polished chromed metal.

Telefo 72 Murano glass: wall support in thermoplastic resin; diffuser in blown glass; end plates in polished chromed metal.

Matériaux

Telefo 50, 70, 120, 170: support applique en aluminium, diffuseur en méthacrylate opalin, extrémités de fermeture en métal chromé brillant.

Telefo 72 verre de Murano: support applique en résine thermoplastique ; diffuseur en verre soufflé ; extrémités de fermeture en aluminium chromé brillant.

Materialien

Telefo 50,70,120,170: Profil aus Aluminium; Schirm aus opalem Metakrylat; Verschlussklemmen aus matt-vernickeltem Metall.

Telefo 72: Profil aus Kunstharz; Schirm aus mundgeblasenem Glas; Endkappen aus matt-vernickeltem Aluminium.

Materiales

Telefo 50,70,120,170: soporte aplique en aluminio; difusor en metacrilato opalino; cabezas de cierre en metal cromado brillante.

Telefo 72 cristal Murano: soporte aplique, de resina termoplástica; difusor de cristal soplado; cabezas de cierre, de aluminio cromado brillante.



Dioscuri parete/soffitto 14
Dioscuri parete/soffitto 25
Dioscuri parete/soffitto 35
Dioscuri parete/soffitto 42

design
 Michele De Lucchi
 1999, 2003, 2005



52



Awards

Design Innovationen
 Design Zentrum Nordrhein Westfalen
 Reddot Design Award
 2000 – Essen (Deutschland)
 Design Plus Light + Building
 2000 – Frankfurt am Main (Deutschland)

Light emission



Colour



White

Materiali: base in resina termoplastica; diffusore in vetro soffiato acidato.

Specificità: il grado di protezione IP65 le rende idonee all'utilizzo anche in esterno.

Materials

Base in thermoplastic resin,
 acid-etched blown glass
 diffuser.

Specification

The IP 65 degree of protec-
 tion makes it also suitable for
 outdoor application.

Matériaux

Base en résine thermoplasti-
 que, diffuseur en verre soufflé
 traité à l'acide.

Spécificité

L'indice de protection IP 65
 permet l'installation de
 l'appareil en extérieur.

Materialien

Sockel aus thermoplastischem
 Harz, Kugel aus mundgebla-
 senem, geätzttem Glas.

Spezifikation

Auch in Außenbereichen
 einsetzbar (Schutzart IP 65).

Materiales

Pie de resina termoplástica,
 difusor de cristal soplado al
 ácido.

Especificaciones

El grado de protección
 IP 65 la hace idónea para
 exteriores.

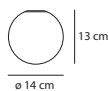

Dioscuri parete/soffitto 14
 HALO max 1x48W (G 9) – ES, included

IP65

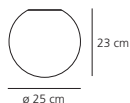

Dioscuri parete/soffitto 25
 HALO max 1x70W (E 27) – ES

or
 FLUO 1x20W (E 27) – TC-TSE

IP65

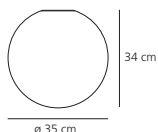

Dioscuri parete/soffitto 35
 HALO max 1x105W (E 27) – ES

or
 FLUO 1x23W (E 27) – TC-TSE

IP65

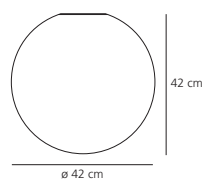

Dioscuri parete/soffitto 42
 HALO max 1x105W (E 27) – ECO

or
 FLUO 1x23W (E 27) – TC-TSE

IP65

MODUL
ELECTRO
www.modulelectro.ru





MODUL
ELECTRO

www.modulelectro.ru

Soffione parete/soffitto 36, 45

design

Michele De Lucchi
Alberto Nason
2008



Materiali: supporto parete/soffitto in resina termoplastica, diffusore in vetro soffiato opalino.

Light emission



Colour



White

Materials

Wall/ceiling support in thermoplastic resin, opaline blown glass diffuser.

Matériaux

Support applique/plafonnier en résine thermoplastique, diffuseur en verre soufflé opalin.

Materialien

Wand- und Deckenbefestigung aus thermoplastischem Harz, Kugel aus geblasenem Opalglas.

Materiales

Soporte aplique y plafón de resina termoplástica, difusor de cristal soplado opalino.

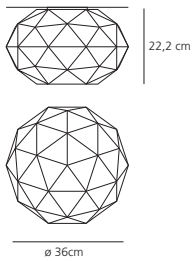

Soffione parete/soffitto 36

HALO max 1x150W (E 27) - ECO
or
FLUO 1x15W (E 27) - TC-TSE

IP20

FLUO 1x26/32W (GX 24 q-3) - TC-DEL
Electronic ballast

IP20

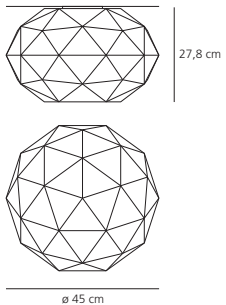

Soffione parete/soffitto 45

HALO max 1x205W (E 27) - ECO
or
FLUO 1x23W (E 27) - TC-TSE

IP20

FLUO 1x42W (GX 24 q-3) - TC-DEL
Electronic ballast

IP20

MODUL
ELECTRO
www.modulelectro.ru





 **MODUL** 
ELECTRO

www.modulelectro.ru



Logico soffitto
Logico soffitto mini
Logico soffitto micro
Logico soffitto nano

design
 Michele De Lucchi
 Gerhard Reichert
 2001, 2002, 2003, 2006



Awards
 Design Innovationen
 Design Zentrum Nordrhein Westfalen
 Reddot Design Award
 2002 – Essen (Deutschland)

Materiali: struttura in metallo verniciato; diffusore in vetro soffiato con finitura seta lucida.
Specificità: la forma modulare si presta alla componibilità e alla realizzazione di combinazioni personalizzate, fornite come progetto speciale.

Light emission



Colours

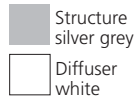

Materials
 Painted metal structure, blown glass diffuser with polished-silk finish.

Specification
 Its modular shape lends itself to the creation and realisation of customized compositions, supplied as special project.

Matériaux
 Structure en métal verni ; diffuseur en verre soufflé, finition soie brillante.

Spécificité
 Sa forme modulaire permet de personnaliser les compositions, comme produit spécial à définir pour tout projet.

Materialien
 Rahmen aus lackiertem Metall; Schirm aus geblasenem Glas in seidig glänzendem Finish.

Spezifikation
 Die Leuchtenmodule erlauben eine individuell gestaltete Anordnungen, die als Sonderleuchten erhältlich sind.

Materiales
 estructura de metal pintado; difusor de cristal soplado con acabado de seda brillante.

Especificaciones
 Su forma modular, se presta para realizar combinaciones personalizadas, suministrado como proyecto especial.





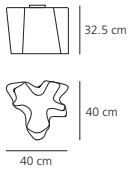

Logico soffitto

HALO max 1x105W (E 27) – ES
or
FLUO 1x23W (E 27) – TC-TSE

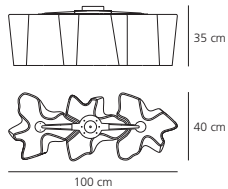

Logico soffitto 3 in linea

HALO max 3x105W (E 27) – ES
or
FLUO 3x23W (E 27) – TC-TSE

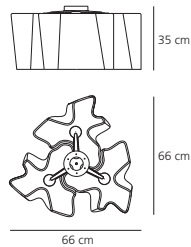

Logico soffitto 3x120°

HALO max 3x105W (E 27) – ES
or
FLUO 3x23W (E 27) – TC-TSE

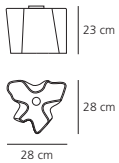

Logico soffitto mini

HALO max 1x70W (E 27) – ES

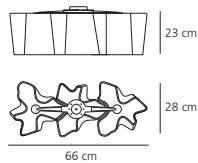

Logico soffitto mini 3 in linea

HALO max 3x70W (E 27) – ES

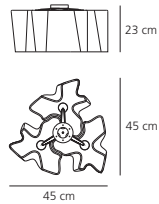

Logico soffitto mini 3x120°

HALO max 3x70W (E 27) – ES

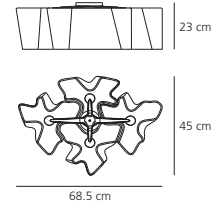

Logico soffitto mini 4x90°

HALO max 4x70W (E 27) – ES

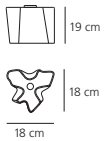

Logico soffitto micro

INC max 1x60W (E 14) – D 45

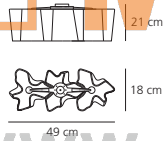

Logico soffitto micro 3 in linea

INC max 3x60W (E 14) – D 45

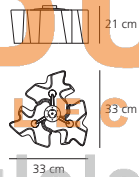

Logico soffitto micro 3x120°

INC max 3x60W (E 14) – D 45

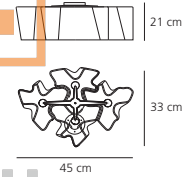

Logico soffitto micro 4x90°

INC max 4x60W (E 14) – D 45



Logico soffitto nano

INC max 1x60W (E 14) – D 45

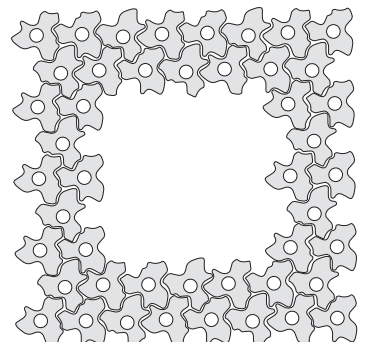
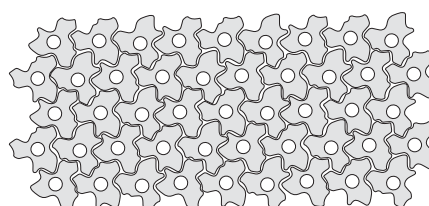
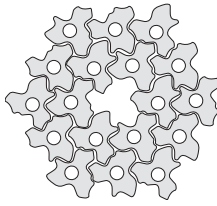
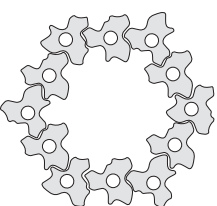

Only for special projects – which feasibility must be approved by Artemide technical design department – it's possible to create different combinations by joining the elements Logico soffitto.



 **MODUL** 
ELECTRO

www.modulelectro.ru

Logico parete
Logico parete mini
Logico parete micro

design
 Michele De Lucchi
 Gerhard Reichert
 2001, 2002



Awards

Design Innovationen
 Design Zentrum Nordrhein Westfalen
 Reddot Design Award
 2002 – Essen (Deutschland)

Materiali: struttura in metallo verniciato; diffusore in vetro soffiato con finitura seta lucida.

Light emission



Colours

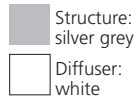

Materials

Painted metal structure,
 blown glass diffuser with
 polished-silk finish.

Matériaux

Structure en métal verni ;
 diffuseur en verre soufflé,
 finition soie brillante.

Materialien

Rahmen aus lackiertem Metall;
 Schirm aus geblasenem Glas
 in seidig glänzendem Finish.

Materiales

Estructura de metal pintado;
 difusor de cristal soplado con
 acabado de seda brillante.

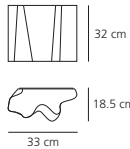

Logico parete

HALO max 2x52W (E 27) – ES



FLUO 1x36W (2 G 10) – TC-F
 Electronic ballast



Logico parete mini

HALO max 1x52W (E 27) – ES



FLUO 1x18/24W (2 G 10) – TC-F
 Electronic ballast



Logico parete micro

INC max 1x60W (E 14) – D 45



FLUO 1x18W (GX 24 q-2) – TC-TEL
 Electronic ballast



Logico parete

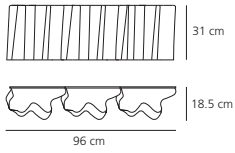

Logico parete 3 in linea
HALO max 6x52W (E 27) – ES



3x36W (2 G 10) – TC-F
Electronic ballast

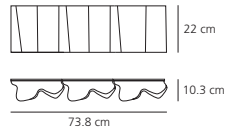

Logico parete mini 3 in linea
HALO max 3x52W (E 27) – ES



3x18/24W (2 G 10) – TC-F
Electronic ballast

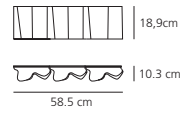

Logico parete micro 3 in linea
INC max 3x60W (E 14) – D 45



3x18W (GX 24 q-2) – TC-TEL
Electronic ballast



MODUL
ELECTRO

www.modulelectro.ru



Logico parete 3 in linea

Logico parete mini full

design

Michele De Lucchi
Gerhard Reichert
2004



Materiali: struttura in metallo verniciato; diffusore in vetro soffiato con finitura seta lucida.

Light emission



Colours

Structure:
silver grey

Diffuser:
white

Materials

Painted metal structure,
blown glass diffuser with
polished-silk finish.

Matériaux

Structure en métal verni ;
diffuseur en verre soufflé,
finition soie brillante.

Materialien

Rahmen aus lackiertem Metall;
Schirm aus geblasenem Glas
in seidig glänzendem Finish.

Materiales

Estructura de metal pintado;
difusor de cristal soplado con
acabado de seda brillante.

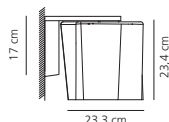
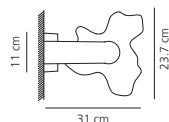

HALO max 1x70W (E 27) – ES



FLUO 1x18W (G 24 q-2) – TC-DEL
Electronic ballast



MODULO
ELECTRO
www.modulelectro.ru



Miconos parete
Miconos soffitto

design
Ernesto Gismondi
1999, 2000



Materiali: struttura in metallo cromato lucido; diffusore in vetro soffiato trasparente.

Light emission



Colour



Structure:
mirror



Diffuser:
transparent

Materials

Structure in polished chromed metal, diffuser in transparent blown glass.

Matériaux

Structure en métal chromé brillant, diffuseur en verre soufflé transparent.

Materialien

Struktur aus poliertem und verchromtem Metall, Schirm aus klarem, mundgeblasenem Glas.

Materiales

Estructura, de metal cromado brillante; difusor en cristal soplado transparente.

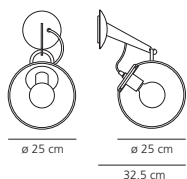

Miconos parete

FLUO 1x20W (E 27) - globe ø 9cm

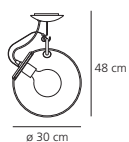

Miconos soffitto

FLUO 1x20W (E 27) - globe ø 9cm



MODUL
ELECTRO
www.modulelectro.ru



Miconos soffitto

Miconos parete

Frost

design
Paolo De Lucchi
2004



Materiali: supporto parete in acciaio cromato; diffusore in vetro stampato trasparente.

Light emission



Colour



Transparent

Materials

Wall support in polished chrome steel, moulded transparent glass diffuser.

Matériaux

Support en acier chromé poli ; diffuseur en verre moulé transparent.

Materialien

Wandbefestigung aus poliertem Stahl, Leuchtenkörper aus gegossenem transparentem Glas.

Materiales

Soporte pared en acero cromado, difusor en cristal estampado transparente.

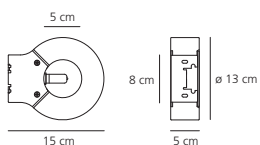

HALO 1x60W (G 9) – ES, included



MODUL
ELECTRO

www.modulelectro.ru



Robbia 30
Robbia 60

design
Ennio Pasini
1996



Materiali: struttura in metallo verniciato; diffusore in vetro soffiato opalino.

Light emission



Colour



White

Materials

structure in painted metal; opal blown glass diffuser. Colour: white.

Matériaux

Structure en métal verni ; diffuseur en verre soufflé opalin.

Materialien

Struktur aus lackiertem Metall; Schirm aus mundgeblasenem Opalglas.

Materiales

Estructura de metal pintado y difusor en cristal soplado opalino.

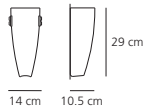

Robbia 30

HALO max 1x70W (E 27) – ES



FLUO 1x9W (G 23) – TC-S

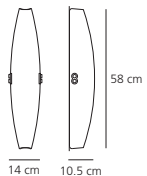

Robbia 60

HALO max 2x70W (E 27) – ES



FLUO 2x9W (G 23) – TC-S



MODUL
ELECTRO
www.modulelectro.ru



Canne

design
Rodolfo Dordoni
1998



Materiali: struttura in metallo verniciato; diffusore in vetro sabbiato.

Light emission



Colours



White

Materials

Structure in painted metal;
sanded glass diffuser.

Matériaux

Structure en métal verni,
diffuseur en verre sablé.

Materialien

Struktur aus lackiertem Metall;
sandgestrahlter Schirm.

Materiales

Estructura, de metal pintado;
difusor, de cristal arenado.



HALO max 1x70W (E 27) – ES



MODUL
ELECTRO
www.modulelectro.ru



Sagitta

design
Thomas Sandell
2003



Materiali: supporto parete in metallo verniciato; diffusore in vetro soffiato opalino.

Light emission



Colour



White

Materials

Materials: painted metal wall support; opal blown glass diffuser.

Matériaux

Support applique en métal verni ; diffuseur en verre soufflé opalin.

Materialien

Sockel der Wandleuchte aus lackiertem Metall; Schirm aus mundgeblasenem Opalglas.

Materiales

Soporte de aplique de metal pintado; difusor de cristal soplado opalino.



MODUL

ELECTRO

www.modulelectro.ru

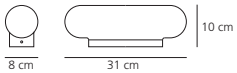

INC max 2x40W (E 14) – D 45



FLUO 1x18W (G24 q-2) – TC-DE
Electronic ballast



Onfale parete 28
Onfale parete 36
Onfale parete 28 vetro chiuso

design
 Luciano Vistosi
 1991, 1994



Materiali: attacco parete in metallo cromato; diffusore in vetro soffiato con bordo in cristallo riportato a caldo.

Light emission



Colours

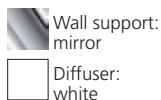

Materials

Wall support in chromed metal. Diffuser in blown glass with transparent crystal edge.

Matériaux

Support applique en métal chromé ; diffuseur en verre soufflé avec rebord en cristal transparent.

Materialien

Sockel der Wandleuchte aus verchromtem Metall; Schirm aus mundgeblasenem Opalglas mit Rand aus klarem Kristallglas.

Materiales

Soporte de aplique, de metal cromado; difusor de cristal soplado con borde de cristal transparente, aplicado en caliente.

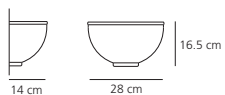

Onfale parete 28
 HALO max 2x70W (E 27) – ES
 IP20 ⚡ F PG

Onfale parete 28 vetro chiuso
 FLUO 2x13W (G 24 d-1) – TC-D
 IP40 ⚡ F PG



Onfale parete 36
 HALO max 2x105W (E 27) – ES
 IP20 ⚡ F PG



Onfale parete 36

Onfale parete 28

Tilos 150
Tilos 150 incasso
Tilos 200

design
 Ernesto Gismondi
 1993



Materiali: struttura in metallo verniciato; diffusori in vetro sabbiato colorato.

Light emission



Colours

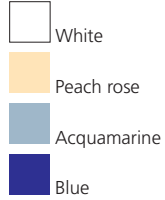

Materials

structure in painted metal;
 diffusers in coloured sanded
 glass.

Matériaux

Structure en métal verni ; diffu-
 seur en verre sablé coloré.

Materialien

Sockel aus lackiertem Metall;
 Schirm aus farbigem sandge-
 strahltem Glas.

Materiales

Estructura, de metal pintado;
 difusor, de vidrio arenado y
 colorado.

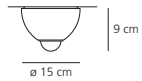

Tilos 150
 INC max 1x60W (E 14) – D 45
 IP20

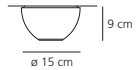

Tilos 150 dicroica
 HALO max 1x50W/12V (GU 5,3) – QR-CBC 51
 IP20

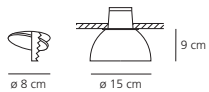

Tilos 150 incasso dicroica
 HALO max 1x50W/12V (GU 5,3) – QR-CBC 51
 IP20

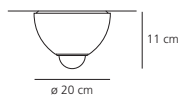

Tilos 200
 HALO max 1x70W (E 27) – ES
 IP20



Kalias 110
Kalias 200
Deltakalias
Trikalias
Pentakalias

design
 Ernesto Gismondi
 1993



Materiali: struttura in metallo verniciato; diffusori in vetro sabbato colorato.
Specificità: serie di lampade da parete/soffitto particolarmente indicate per le specchiere da bagno.

Light emission



Colours

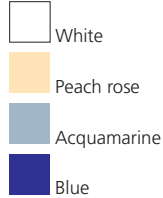

Materials

Structure in painted metal;
 coloured sanded glass dif-
 fusers.

Specification

Range of wall/ceiling lamps,
 particularly suitable for
 bathroom mirror frames.

Matériaux

Structure en métal chromé;
 diffuseur en verre sablé
 coloré.

Spécificité

Série d'appliques/plafonniers,
 particulièrement adaptée
 pour la salle de bains.

Materialien

Sockel aus lackiertem Metall;
 Schirm aus farbigem sandge-
 strahltem Glas.

Spezifikation

Wand- Deckenleuchte,
 besonders für die Beleuchtung
 von Badspiegeln geeignet.

Materiales

Estructura, de metal pintado;
 difusores, de cristal arenado y
 colorado.

Especificaciones

Serie de apliques/plafones,
 particularmente idónea para
 los espejos de baño.

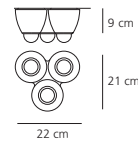
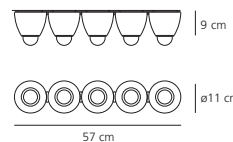
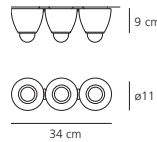

Trikalias

INC max 3x40W (E 14) – D 45



Pentakalias

INC max 5x40W (E 14) – D 45



Deltakalias

INC max 3x40W (E 14) – D 45



Kalias 110

INC max 1x40W (E 14) – D 45



Kalias 110 IP23 (wall mounting only)

HALO max 1x28W (E 14) – ES

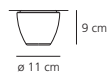

Kalias 110 dicroica

HALO max 1x35W/12V (GU 5,3) – QR-CBC 51

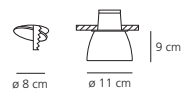

Kalias 110 incasso dicroica

HALO max 1x50W/12V (GU 5,3) – QR-CBC 51

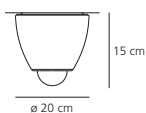

Kalias 200

HALO max 1x70W (E 27) – ES

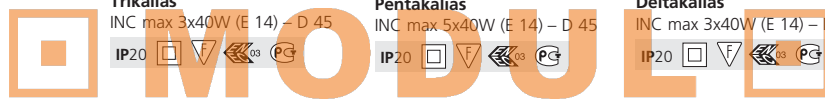

www.modulelectro.ru





 **MODUL** 
ELECTRO

www.modulelectro.ru

Utopia parete/soffitto 32
Utopia parete/soffitto 42
Utopia parete/soffitto 52

design
 Ernesto Gismondi
 1990



Materiali: struttura in metallo verniciato; diffusore in vetro sabbiato serigrafato.

Light emission



Colours



Materials

Structure in painted metal;
 diffuser in white silkscreened
 sanded glass.

Matériaux

Structure en métal verni ;
 diffuseur en verre sablé séri-
 graphié.

Materialien

Struktur aus lackiertem
 Metall; Schirm aus Sandglas
 mit Siebdruck.

Materiales

Estructura de metal pintado;
 difusor de vidrio arenado
 serigrafado.

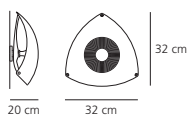

Utopia parete/soffitto 32
 HALO max 1x70W (E 27) – ES
 IP20 ⚡ F ⚡ ⚡ ⚡

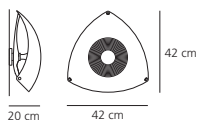

Utopia parete/soffitto 42
 HALO max 1x205W (E 27) – ECO
 or
 FLUO 1x28W (E 27) – TC-SER
 IP20 ⚡ F ⚡ ⚡ ⚡

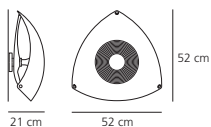

Utopia parete/soffitto 52
 HALO max 1x205W (E 27) – ECO
 or
 FLUO 1x28W (E 27) – TC-SER
 IP20 ⚡ F ⚡ ⚡ ⚡

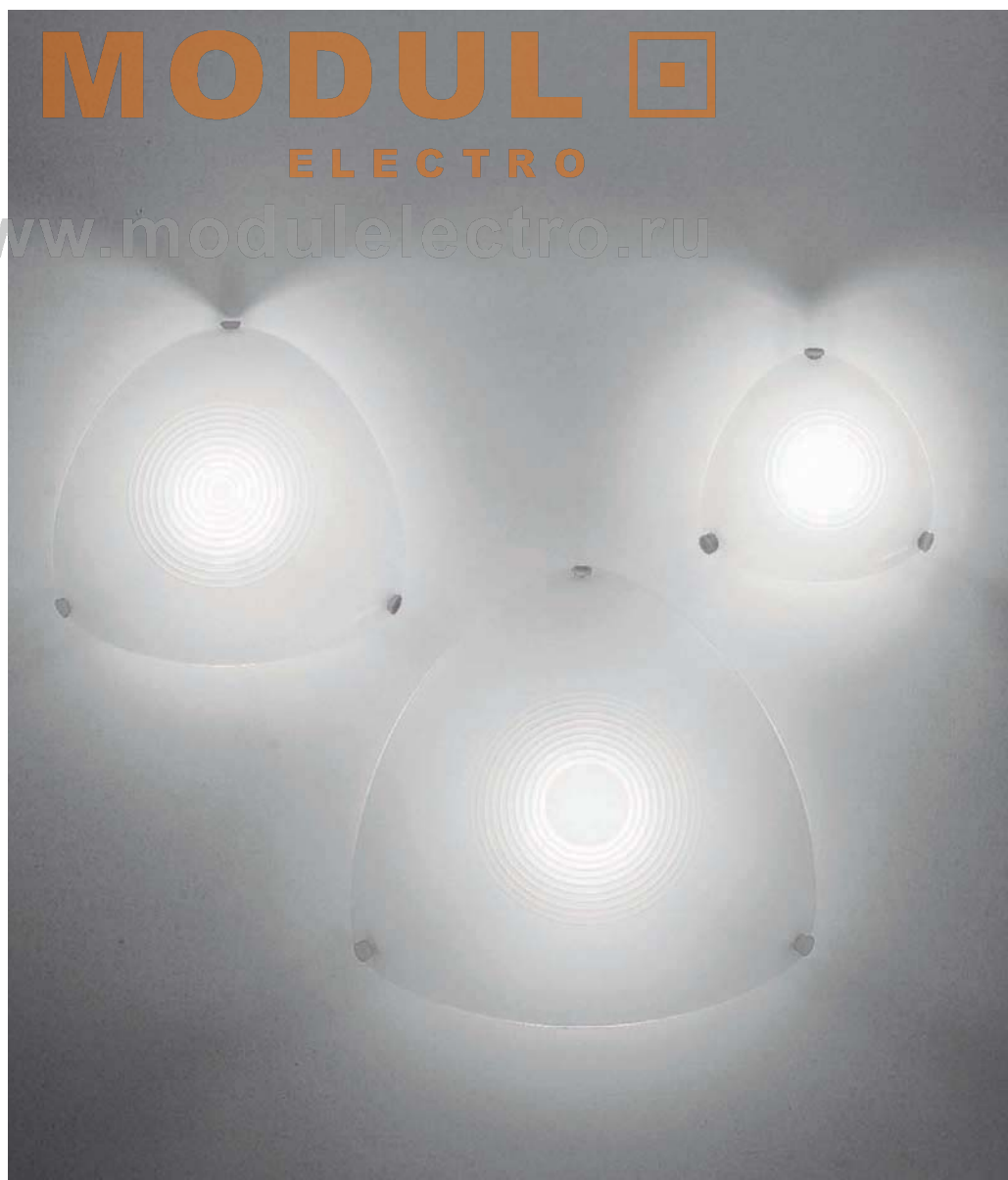
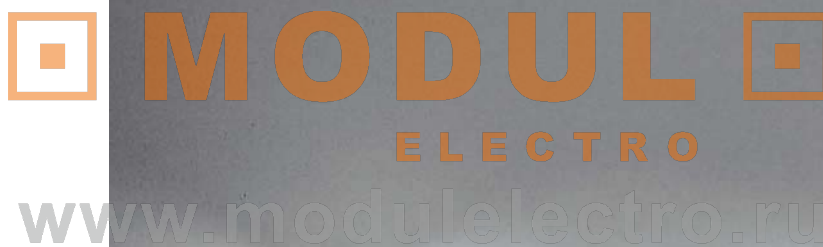

Zsu-zsu parete/soffitto 55
Zsu-zsu parete/soffitto 65

design
Örni Halloween
1994



279

Materiali: struttura in metallo verniciato e resina termoplastica; diffusore in lastra di vetro serigrafato.

Light emission



Colours



Structure:
grey



Diffuser:
white

Materials

Structure in painted metal and thermoplastic resin; glass moulded with filgree diffuser.

Matériaux

Structure en métal verni et résine thermoplastique ; feuille de verre sérigraphié.

Materialien

Baldachin und Abhängung aus lackiertem Metall und thermoplastischem Kunstharz; Schirm aus Glas mit Siebdruck.

Materiales

estructura, de metal pintado y resina termoplástica; difusor, de placa de vidrio serigrafiado.

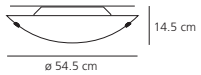

Zsu-zsu 55 parete/soffitto
INC max 3x60W (E 27) – A 60

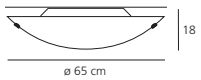

Zsu-zsu 65 parete/soffitto
HALO max 3x70W (E 27) – ES



MODUL
ELECTRO

www.modulelectro.ru



Acheo parete
Acheo soffitto

design
Gianfranco Frattini
1989, 1991





Materiali: supporto parete in metallo cromato; fondello per la versione soffitto in metallo verniciato; diffusore in vetro borosilicato.

Light emission



Colours

-  Wall support: mirror
-  Ceiling support: metal grey
-  Diffuser: transparent

Materials

Wall support in chromed metal; ceiling support in painted metal; diffuser in borosilicate glass.

Matériaux

Support applique en métal chromé ; support plafonnier en métal verni ; diffuseur en verre borosilicate.

Materialien

Sockel für die Wandleuchte aus verchromtem Metall; Sockel für die Deckenausführung aus lackiertem Metall; Schirm aus Borosilikatglas.

Materiales

Materiales: soporte de aplique de metal cromado; soporte de plafón de metal pintado; difusor de vidrio borosilicado.

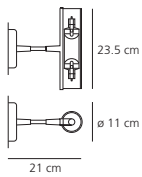

Acheo parete

HALO max 1x230W (R7s) – ES, included

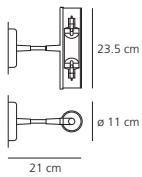

Acheo soffitto

HALO max 1x230W (R7s) – ES, included



Acheo soffitto

MODUL
ELECTRO

www.modulelectro.ru



Acheo parete

Icaro

design

Carlo Forcolini
1985



Awards

Swislyo '96 IV Miedzynarodowe
Targi Wyznienie
1996 – Warsaw (Poland)

Materiali: corpo in metallo verniciato, schermo in acciaio forato cromato lucido;
diffusore in cristallo trasparente.

Light emission



Colours



Steel screen:
mirror



Diffuser:
trasparent

Materials

Body in painted metal; perfo-
rated polished chromed steel
screen; diffuser in clear crystal.

Matériaux

Corps en métal verni ; écran
en acier perforé chromé poli ;
diffuseur en verre transparent.

Materialien

Gehäuse aus lackiertem
Metall; Schirm aus Kristallglas
mit poliertem, verchromtem
Stahl.

Materiales

cuerpo en metal pintado;
pantalla, de acero cromado
brillante, perforada; difusor
de cristal transparente.

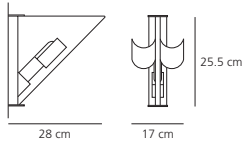

MODUL
ELECTRO

HALO max 1x100W (B 15d) – ECO, included





www.modulelectro.ru



Lampade a sospensione

Suspension lamps / Suspensions / Pendelleuchten / Suspensiónes

 **MODUL** 
ELECTRO

www.modulelectro.ru



206
Mercury sospensione



208
Droplet sospensione



210
Cosmic Angel
sospensione



212
Aqua Cil sospensione



214
Cabildo sospensione



216
Pirce



218
Space Oddity
sospensione



220
Talo sospensione



222
Float sospensione
circolare, lineare



226
Nur Metamorfosi,
1618, mini



228
Nur, 1618, mini



230
Nur Gloss, mini



232
Eutopia



234
Eutopia Pro



236
Altrove sospensione

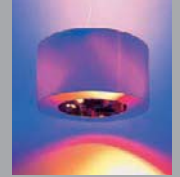

240
Tian Xia
Metamorfosi



242
Tian Xia 2



243
Tian Xia halo



244
Tian Xia 500 Led



245
Tian Xia 500 fluo



246
Trifluo



248
Sarissa



249
Attalo



250
Tolomeo sospensione
due bracci alluminio



251
Tolomeo sospensione
due bracci pergamena

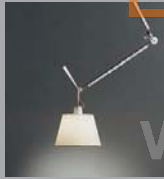

252
Tolomeo sospensione
decentrata



254
Tolomeo Mega
sospensione 42, 52



256
Choose sospensione,
Mega



258
Pipe sospensione



260
Mouette simmetrica,
asimmetrica



262
Fractals



264
Aggregato sospensione
salliscendi, decentrato



265
Talak sospensione



266
Edge sospensione 30



267
Castore calice
sospensione 18, 42



268
Castore sospensione
18, 25, 35, 42



270
Soffione sospensione
36, 45



272
Noto



274
Logico sospensione,
mini, micro, nano



278
Miconos sospensione



279
Zsu-Zsu sospensione
55, 65



281
Azio



282
Farsalo



283
Filippi

MODULO
ELECTRO
www.modulelectro.ru

Mercury suspensione

design

Ross Lovegrove
2007



116
118

Awards

Reddot Design Award
"Best of the Best"
2008 – Essen (Deutschland)
Good Design Award
The Chicago Athenaeum
2008 – Chicago (US)

Light emission



Colour



Reflector:
metal grey



Units:
mirror

Materiali: corpi luminosi in alluminio pressofuso; corpi riflettenti in materiale termoplastico stampato ad iniezione con finitura metallizzata; riflettore in alluminio stampato.

Specificità: la forma modulare si presta alla componibilità e alla realizzazione di combinazioni personalizzate, fornite come progetto speciale.

Materials

Die-cast aluminium lighting units; reflective units made of injection-moulded thermo-plastic material with metallic finish; die-cast aluminium reflector.

Matériaux

Corps lumineux en aluminium moulé sous pression. Galets réfléchissants en matière thermoplastique finition métallisée. Réflecteur en aluminium moulé.

Materialien

Leuchtenkörper aus druckgegossenem Aluminium; reflektierende Körper aus Spritzguss-Thermoplast mit Metall-Oberfläche; Reflektor aus formgestanztem Aluminium.

Materiales

Cuerpos luminosos en aluminio fundido a presión; cuerpos reflectantes en material termoplástico moldeado por inyección, con acabado metalizado; reflector en aluminio moldeado.

Specification

Its modular shape lends itself to the creation and realisation of customized compositions, supplied as special project.

Spécificité

Sa forme modulaire, permet de nombreuses combinaisons capables de produire autant de compositions personnalisées, produit spécial à définir pour tout projet.

Spezifikation

Die Leuchtenmodule erlauben eine individuell gestaltete Anordnungen, die als Sonderleuchten erhältlich sind.

Especificaciones

Su forma modular, se presta para realizar combinaciones personalizadas, entrega como proyecto especial.

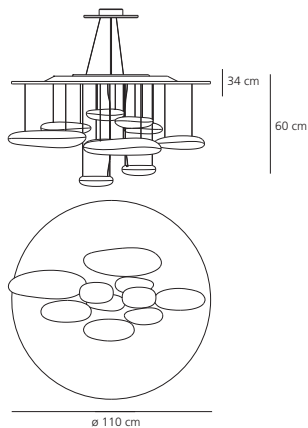

HALO max 2x160W (R7s) – ES, included



MODUL
ELECTRO
www.modulelectro.ru





 **MODUL** 

ELECTRO

www.modulelectro.ru

Droplet sospensione

design

Ross Lovegrove
2007



Materiali: corpi luminosi in alluminio pressofuso; riflettore in alluminio stampato e verniciato.

Light emission



Colours



Materials

Die-cast aluminium lighting units; painted die-cast aluminium reflector.

Matériaux

Corps lumineux en aluminium moulé sous pression.
Réflecteur en aluminium moulé et verni.

Materialien

Leuchtenkörper aus druckgegossenem Aluminium;
Reflektor aus formgestanztem Aluminium.

Materiales

Cuerpos luminosos en aluminio fundido a presión; reflector en aluminio moldeado y pintado.

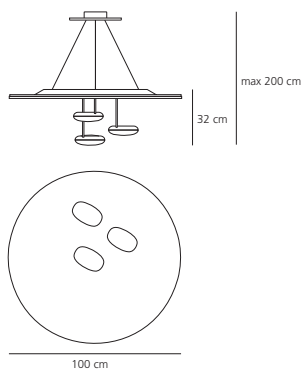

HALO max 3x160W (R7s) – ES, included



MODUL
ELECTRO
www.modulelectro.ru





MODUL
ELECTRO

www.modulelectro.ru

Cosmic Angel sospensione

design

Ross Lovegrove
2009



Materiali: corpo lampada-riflettore in materiale termoplastico. Corpi illuminanti in alluminio pressofuso.

Light emission



Colours



Mirror

Materials

Body lamp-reflector made of thermoplastic material; die-cast aluminium lighting units.

Matériaux

Corps-réfecteur en matériau thermoplastique ; corps lumineux en aluminium moulé sous pression.

Materialien

Leuchtenkopf aus thermoplastischem Material; Leuchtenkörper aus druckgegossem Aluminium.

Materiales

Cuerpo de la lámpara-reflector en material termoplástico. Cuerpo luminoso en aluminio fundido.

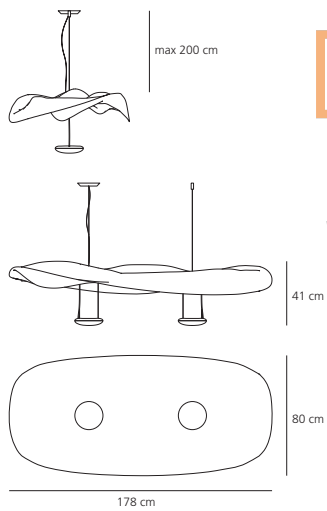

HALO max 2x400W (R7s) - ES, included



METAL HALIDE 2x70W (G 8,5) - HIT
Electronic ballast

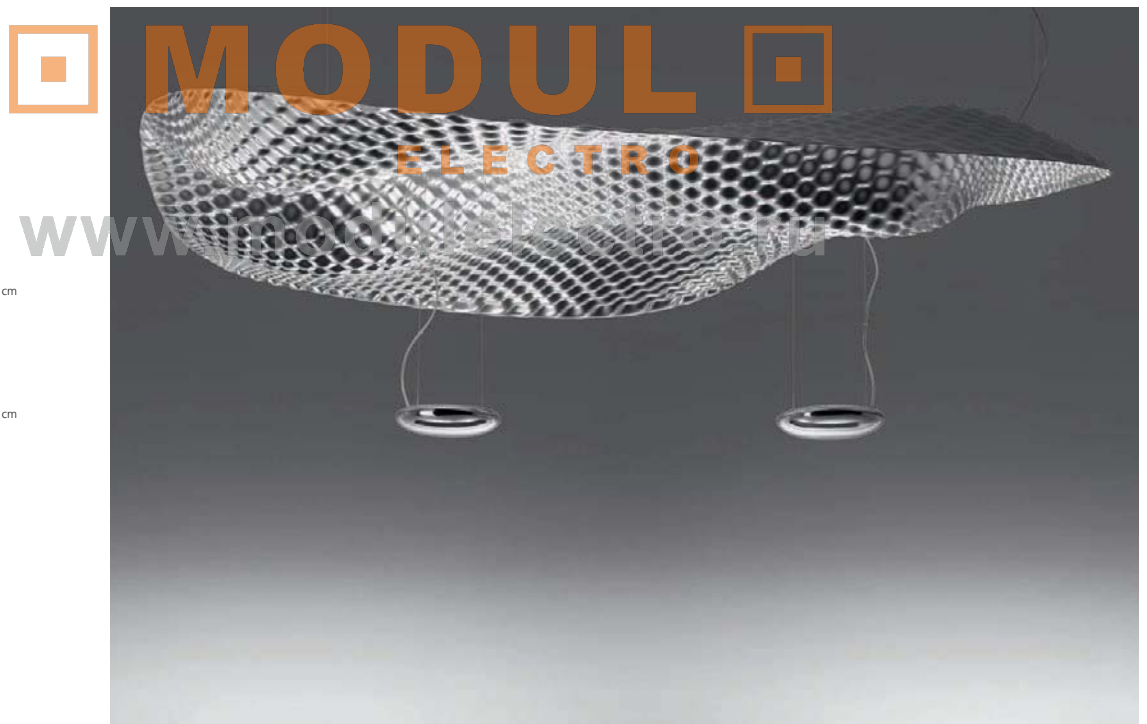



MODUL
ELECTRO

www.modulelectro.ru

Aqua Cil sospensione

design

Ross Lovegrove
2007



Materiali: struttura in alluminio pressofuso; diffusore in alluminio stampato e trattato a specchio.

Light emission



Colours

- Structure: metal grey
- Diffuser: mirror
- Diffuser: metal orange
- Diffuser: metal blue

Materials

Die-cast aluminium structure; moulded and mirror-treated aluminium diffuser.

Matériaux

Structure en aluminium moulé sous pression ; diffuseur en aluminium moulé et traité façon miroir.

Materialien

Struktur aus druckgegossenem Aluminium; Lichtverteiler aus Spritzguss und hochglanzpoliertem Aluminium.

Materiales

Estructura en aluminio fundido a presión; difusor en aluminio moldeado por inyección con acabado pulido espejo.



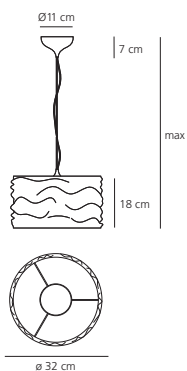

MODUL
ELECTRO
www.modulelectro.ru



HALO max 1x150W (E 27) – ECO





 **MODUL** 
ELECTRO
www.modulelectro.ru

Cabildo sospensione

design
Eric Solé
2007



Materiali: corpo lampada in alluminio pressofuso verniciato.
Specificità: i cavetti di sospensione fungono anche da alimentazione.

Light emission



Colour



White

Materials

Body lamp in painted die-cast aluminium.

Specification

The suspension cables are also feed cables.

Matériaux

Corps en aluminium moulé sous pression peint.

Spécificité

Les câbles de suspension servent également de câbles d'alimentation.

Materialien

Leuchtenkörper aus druckgegossenem, lackiertem Aluminium.

Spezifikation

Die Aufhängung der Leuchte dient gleichzeitig als Netzkabel zur Stromversorgung.

Materiales

Cuerpo de la lámpara en aluminio fundido a presión y pintado.

Especificaciones

Los cables de suspensión funcionan también de alimentación.

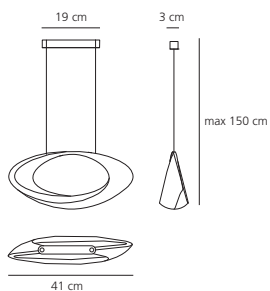

HALO max 1x230W (R7s) – ES, included





MODUL
ELECTRO

www.modulelectro.ru

Pirce

design

Giuseppe Maurizio Scutellà
2008



Awards

iF Produkt Design Award
2010 – Hannover (Deutschland)
Good Design Award
The Chicago Athenaeum
2008 – Chicago (US)

Light emission



Colour



White

Materiali: alluminio verniciato.

Specificità: da un disco sottile si aprono volute fluttuanti, che ricadono morbida-
mente verso il basso, creando magici effetti di forma e luce.

Materials

Painted aluminium.

Specification

Opening out of a slim disk are
fluttering spirals, which fall
gently downwards, creating
magical effects of form and
light.

Matériaux

Aluminium verni.

Spécificité

Un disque mince donne
naissance à des volutes
flottantes qui retombent
doucement vers le bas en
créant des effets magiques de
forme et de lumière.

Materialien

Lackiertem Aluminium

Spezifikation

Eine feine Scheibe geht in
sanft geschwungene Schnör-
kel über, die sich spiralförmig
nach unten neigen und magi-
sche Lichteffekte erzeugen.

Materiales

Aluminio pintado.

Especificaciones

De un disco fino parten
volvas fluctuantes que caen
suavemente hacia abajo,
creando mágicos efectos de
forma y luz.

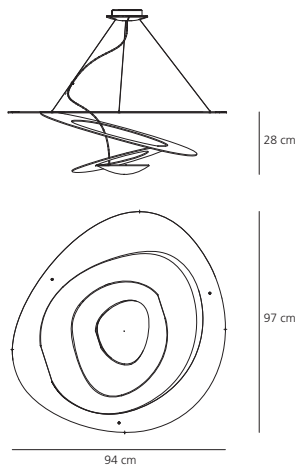

HALO max 1x400W (R7s) - ES, included



METAL HALIDE 1x70W (G 8,5) - HIT





MODUL
ELECTRO

www.modulelectro.ru

Space Oddity sospensione

design

Carlotta de Bevilacqua
2009



132

Materiali: struttura in lamiera metallica piegata e forata. Dietro la lamiera vi è un foglio opalino che aiuta a diffondere il flusso luminoso. La parte superiore dell'apparecchio è in materiale plastico trasparente che tende ad ottimizzare la performance di luce indiretta e protegge, inoltre, le sorgenti e l'elettronica interna dagli agenti esterni.

Light emission



Colour



Mirror

Materials

Folded and perforated plate frame. An opalescent sheet behind the plate helps diffuse the luminous flow. The rear of the appliance is made of transparent plastics, which tends to optimize the indirect lighting performance and also protects the light sources and the electronic parts within from outer agents.

Matériaux

Structure en tôle métallique pliée et perforée. Derrière la tôle se trouve une feuille opaline qui aide à diffuser le flux lumineux. La partie supérieure est en matière plastique transparente qui vise à optimiser la performance de la lumière indirecte et protège, en outre, les sources et l'électronique internes contre les agents externes.

Materialien

Struktur in gebogenem und gelochtem Metallblech. Hinter dem Blech ist eine helle Folie, die das Verteilen des Lichtstrahls unterstützt. Obere Seite des Leuchtenkörpers aus transparentem Kunststoff. Dieser verbessert die Qualität des indirekten Lichts und schützt das Leuchtmittel sowie die Elektronik vor äußeren Einflüssen.

Materiales

Estructura de chapa metálica plegada y perforada. Detrás de la chapa hay una hoja opalina que ayuda a difundir el flujo luminoso. La parte trasera del aparato es de material plástico transparente que tiende a optimizar el resultado de luz indirecta y protege, además, las fuentes y la electrónica interna de los agentes externos.

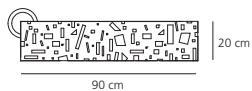
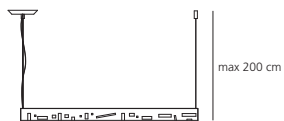
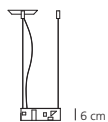

FLUO 2x39W (G 5) - T 16, included
Electronic ballast



MODUL
ELECTRO
www.modulelectro.ru

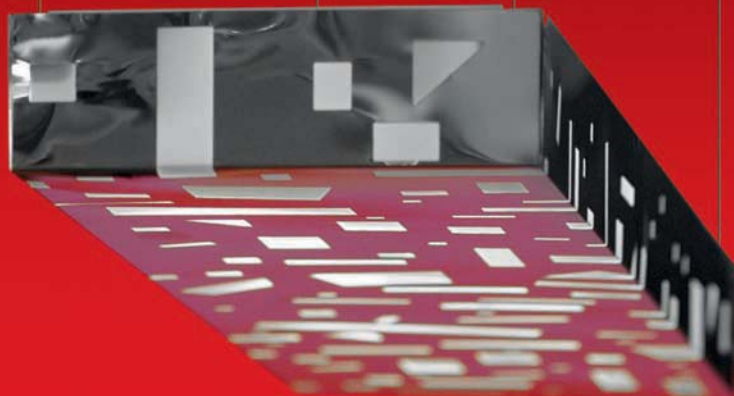

■ MODUL ■

ELECTRO

www.modulelectro.ru

Talo sospensione

design

Neil Poulton
2001



136
138

Awards

Prix "L'Observateur du Design 2002"
"Etoile 2002" – Paris (France)

Design Innovationen – Design
Zentrum Nordrhein Westfalen
Reddot Design Award
2002 – Essen (Deutschland)

iF Product Design Award
2002 – Hannover (Deutschland)

Compasso d'Oro / A.D.I. – Selezione
2002 – Milano (Italia)

Intel Design 2003
Categoria design "Augusto Morello"
III edizione – Milano (Italia)

Light emission



Colours



White



Silver grey

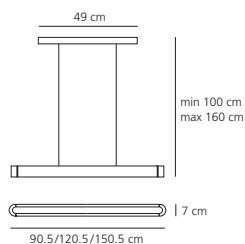

Talo sospensione 90, 120, 150

FLUO 1x39W/54W/80W (G 5) – T16, included,
dimmable or non dimmable
Electronic ballast

IP20 + Dimmer

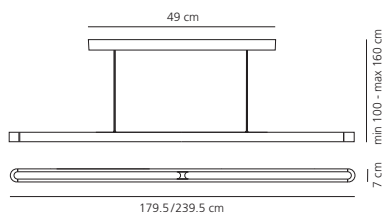

Talo sospensione 180, 240

FLUO 2x39W/2x54W/80W (G 5) – T16, included,
dimmable or non dimmable
Electronic ballast

IP20 + Dimmer

Materiali: rosone in resina termoplastica; corpo in alluminio verniciato; diffusore inferiore in policarbonato opalino.

Specificità: disponibile monotubo o bitubo in linea in diverse lunghezze a seconda della sorgente impiegata. I cavetti di sospensione svolgono anche funzione di alimentazione.

Materials

Thermoplastic resin ceiling
rose; painted aluminium
body; opal polycarbonate
lower diffuser.

Matériaux

Rosace en résine thermoplas-
tique ; corps en aluminium
verni ; diffuseur inférieur en
polycarbonate opalin.

Materialien

Rosette aus Kunststoff; Körper
aus lackiertem Aluminium;
unterer Schirm aus opalem
Polycarbonat.

Materiales

Rosetón en resina termo-
plástica; cuerpo en aluminio
pintado; difusor inferior en
policarbonato opalino.

Specification

Available mono or double
tube (on the same line), in
different lengths according to
the power of the light source.
The suspension cables are
also feed cables.

Spécificité

Disponible en version mono
ou bitube (en ligne) en
différentes longueurs selon
la puissance de la source
lumineuse. Les 4 câbles
servent également de câbles
d'alimentation.

Spezifikation

In 1- oder 2-lampiger
Ausführung (Bandmontage
Anordnung) und verschiede-
nen Größen (in Abhängigkeit
des eingesetzten Leuchtmittels)
erhältlich. Die Seilzüge
dienen als Aufhängung und
Stromversorgung.

Especificaciones

Disponible en versión mono
o doble tubo (en línea), en
longitudes diferentes según
la potencia de la fuente
luminosa. Los cables desar-
rollan también la función de
alimentación.

MODUL
ELECTRO
www.modulelectro.ru





MODUL
ELECTRO
www.modulelectro.ru

Float sospensione circolare Float sospensione lineare

design

James Irvine
2000



146

Awards

Float circolare
Compasso d'Oro / A.D.I. – Segnalazione
2001 – Milano (Italia)

Light emission



Colour



White

Materiali: struttura in alluminio verniciato; diffusore inferiore in metacrilato opalino; diffusore superiore in policarbonato trasparente.

Specificità: disponibile nelle versioni circolare o lineare. È possibile applicare un filtro blu o topazio all'emissione indiretta (solo nelle versioni circolare e lineare monotubo).

Materials

Structure in painted aluminium, lower diffuser in opaline methacrylate, upper diffuser in transparent polycarbonate.

Specification

Available in circular or linear versions. Application of a coloured filter, blue or topaz, to the indirect light emission (Float circolare and Float lineare monotubo only).

Matériaux

Structure en aluminium verni, diffuseur inférieur en méthacrylate opalin, diffuseur supérieur en polycarbonate transparent.

Spécificité

Disponible en version circulaire ou linéaire. Un filtre coloré (bleu ou topaze) peut être ajouté, à l'émission indirecte (seulement pour Float circolare et Float lineare monotubo).

Materialien

Struktur aus lackiertem Aluminium; unterer Schirm aus opalem Metakrylat; oberer Schirm aus durchsichtigem Polycarbonat.

Spezifikation

Erhältlich als Kreis- oder Linearausführung. Für die Versionen Float circolare und Float lineare monotube ist der Einsatz eines blauen oder goldgelben Farbfilters möglich.

Materiales

Estructura de aluminio pintado; difusor inferior de metacrilato opalino, difusor superior en metacrilato transparente.

Especificaciones

Disponible en dos versiones: lineal o circular. Es posible aplicar un filtro azul o topacio para la emisión de luz indirecta (sólo en las versiones circular y lineal monotubo).

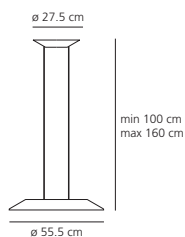
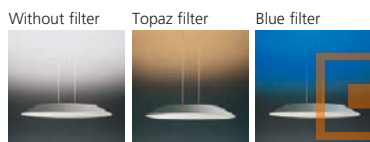

Float sospensione circolare

FLUO 1x55W (2GX 13) – T 16-R, included
Electronic ballast

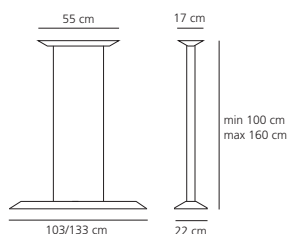

Float sospensione lineare monotubo

FLUO 1x39W (G 5) – T 16, included
Electronic ballast



Float sospensione lineare bitubo

FLUO 2x39W (G 5) – T 16, included
dimnable or non dimmable.

Electronic ballast



2x54W (G 5) – T 16, included
dimnable or non dimmable.

Electronic ballast



MODUL
ELECTRO
www.modulelectro.ru



Float sospensione circolare – Topaz filter



MODUL
ELECTRO
www.modulelectro.ru

Nur family

design
Ernesto Gismondi

Serie di lampade a sospensione disponibili in diverse versioni.

3 dimensioni: Nur (ø diffusore 55 cm), Nur 1618 (ø diffusore 90 cm) e Nur Mini (ø diffusore 36 cm)

4 sorgenti luminose: alogena Metamorfofi, alogena, fluorescente e a ioduri metallici)

5 finiture: alluminio, antracite, ruggine, gloss bianco e gloss nero.

Range of suspension lamps available in many versions.

3 sizes

Nur (diffuser ø 55 cm), Nur 1618 (diffuser ø 90 cm), and Nur Mini (diffuser ø 36 cm).

4 lighting sources

Metamorfofi halogen, halogen, fluorescent and metal halide.

5 finishing

Aluminium, anthracite, rust, white gloss and black gloss.

Série de suspensions disponibles dans de nombreuses versions.

3 tailles

Nur (diffuseur ø 55 cm), Nur 1618 (diffuseur ø 90 cm), et Nur Mini (diffuseur ø 36 cm).

4 sources lumineuses

Metamorfofi halogène, halogène, fluorescent et iodures métalliques.

5 finitions

Aluminium, anthracite, rouille, blanc ou noir brillant.

Vielfältige Familie von Pendelleuchten.

3 Größen:

Nur (Schirm Ø55 cm), Nur 1618 (Schirm Ø90 cm) und Nur mini (Schirm Ø36 cm).

4 Bestückungsvarianten:

Metamorfofi Halogen, Halogen-, Leuchtstoff- oder Metaldampf lampen.

5 Farben/Oberflächen:

Aluminium, Anthrazit, Rost, Weiß glänzend und Schwarz glänzend.

Serie de lámparas de suspensión disponibles en distintas versiones.

3 dimensiones:

Nur (ø difusor 55 cm), Nur 1618 (ø difusor 90 cm) y Nur Mini (ø difusor 36 cm)

4 fuentes de luz:

halógena Metamorfofi, halógena, fluorescente y de yoduros metálicos.

5 acabados:

aluminio, antracita, corten, gloss blanca y gloss negra.

	METAMORFOSI	HALOGEN	FLUORESCENT	METAL HALIDE
NUR 1618				
NUR				
NUR MINI				



A modern dining room with a glass table, wire chairs, and a mezzanine level. The room features a large window, a balcony with a railing, and a kitchen area in the background. The floor is made of dark wood, and the walls are white. The lighting is warm, with two large pendant lamps hanging over the table. The overall atmosphere is clean and contemporary.

MODUL

ELECTRO

www.modulelectro.ru

Nur Metamorfosi
Nur 1618 Metamorfosi
Nur Mini Metamorfosi

design
 Ernesto Gismondi
 2003, 2005, 2006



Awards
 Design Innovationen – Design Zentrum Nordrhein Westfalen
 Reddot Design Award
 2003, 2005, 2006 – Essen (Deutschland)

Materiali: corpo lampada in alluminio, calotta superiore in vetro borosilicato trasparente.

Specificità: gruppi di sorgenti alogene con filtri dicroici rosso, verde e blu consentono di ottenere infinite atmosfere di luce colorata. Un'ulteriore sorgente alogena produce un'emissione indiretta bianca. Attraverso un telecomando è possibile gestire le atmosfere standard, memorizzarne altre a scelta e agire sull'intensità luminosa.

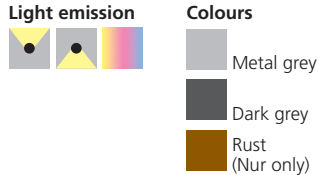

Materials
 Aluminium body lamp, upper cap in borosilicate transparent glass.

Specification
 Groups of halogen sources with dichroic filters red, green and blue allow to create a wide range of light coloured atmospheres. A further halogen source produces a white indirect emission. It is possible, using a remote control, to manage standard atmospheres, to create and memorise others and to adjust the light intensity.

Matériaux
 Corps en aluminium, calotte supérieure en verre borosilicate transparent.

Spécificité
 Des sources halogènes avec filtres dichroïques rouge, vert et bleu, permettent d'obtenir de nombreuses atmosphères de lumière colorée. Une autre source halogène produit une émission lumineuse indirecte blanche. A l'aide de la télécommande, il est possible de gérer les atmosphères standard, d'en créer d'en mémoriser et d'agir sur l'intensité lumineuse.

Materialien
 Leuchtenkörper aus Aluminium; obere Kappe aus transparentem Borosilikatglas.

Spezifikation
 Die Ausführungen für Halogenlampen sind mit dichroitischen Filtern in den Grundfarben Rot, Blau und Grün ausgestattet und schaffen unzählige farbige Lichtstimmungen. Eine weitere Halogenlampe erzeugt weißes, indirektes Licht. Die Lichtstimmungen sind über eine Fernbedienung abrufbar (verschiedene Standardlichtstimmungen und Lichtintensitäten).

Materiales
 Cuerpo lámpara en aluminio; campana superior en cristal borosilicado transparente.

Especificaciones
 Grupos de fuentes de luz halógenas con filtros dicroicos, rojo, verde y azul permiten obtener infinitas atmósferas de luz coloradas. Otras fuentes de luz halógenas producen una emisión de luz indirecta blanca. Mediante un mando a distancia es posible manejar las atmósferas standard, crear y memorizar otras y actuar en la intensidad luminosa.



Nur 1618 Metamorfosi



Metal grey (Aluminium)



Dark grey (anthracite)



Rust

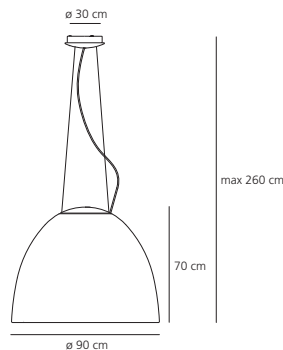

Nur 1618 Metamorfosi*
 Indirect emission:
 HALO max 1x230W (R7s) – ES, included
 Direct emission:
 HALO max 9x150W (B 15d) – ECO, included
 IP20 ⚡ ⚡ ⚡ + Dimmer

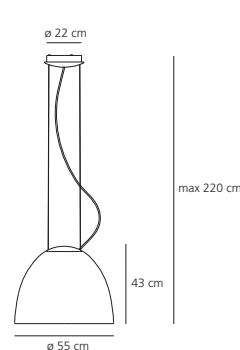

Nur Metamorfosi
 Indirect emission:
 HALO max 1x230W (R7s) – ES, included
 Direct emission:
 HALO max 3x150W (B 15d) – ECO, included
 IP20 ⚡ ⚡ ⚡ + Dimmer

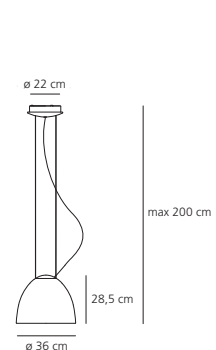

Nur Mini Metamorfosi
 Indirect emission:
 HALO max 1x80W (R7s) – ES, included
 Direct emission:
 HALO max 3x80W (R7s) – ES, included
 IP20 ⚡ ⚡ ⚡ + Dimmer



Wall mounted control panel (to order separately)



Radiofrequency remote control (included)



Infrared remote control (included)



Infrared remote control (included)

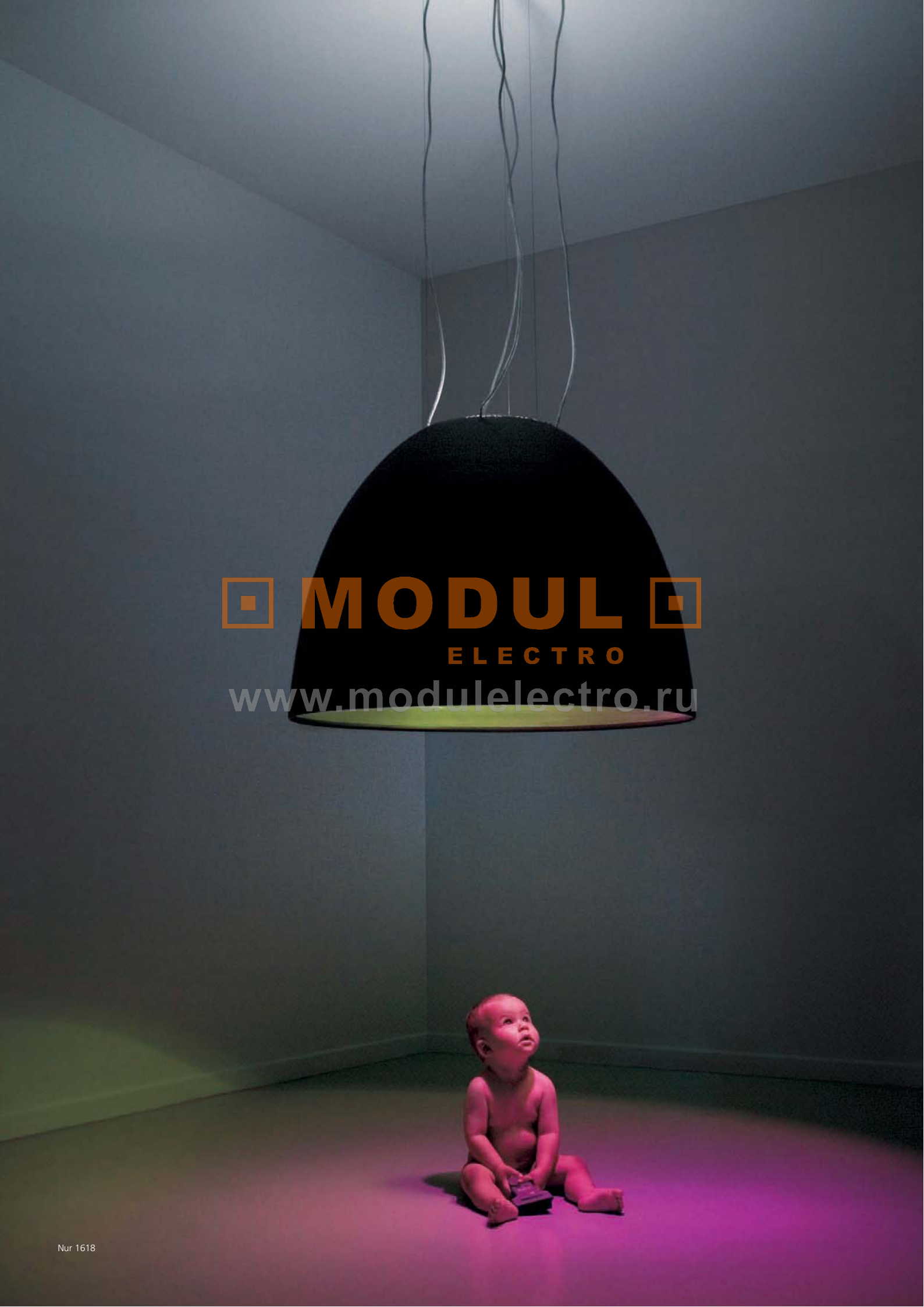

MODUL
ELECTRO
www.modulelectro.ru

Nur
Nur 1618
Nur mini

design
Ernesto Gismondi
2003, 2005, 2006



Awards

Design Innovationen – Design Zentrum Nordrhein Westfalen
Reddot Design Award
2004 – Essen (Deutschland)

Materiali: corpo lampada in alluminio, calotta superiore in vetro borosilicato sabbiato.

Specificità: disponibile come accessorio una cupola antiabbagliamento, e per le versioni alogena e fluoescente anche un filtro colorato.

Light emission



Colours

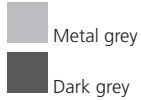

Materials

Aluminium body lamp; upper cap in borosilicate sanded glass.

Specification

As accessory, is available an antidazzle cap and a coloured filter for halogen and fluorescent versions.

Matériaux

Corps en aluminium; calotte supérieure en verre borosilicate sablé.

Spécificité

Un écran anti-éblouissant est disponible en option et, pour les versions halo et fluo un filtre coloré est également disponible.

Materialien

Leuchtenkörper aus Aluminium; obere Kappe aus Sand-Borosilikatglas.

Spezifikation

Entblendungsschirm sowie Farbfilter für Nur Halo und Nur Fluo als Zubehör erhältlich.

Materiales

Cuerpo de la lámpara en aluminio; campana superior en cristal borosilicado arenado.

Especificaciones

La cúpula antideslumbramiento es opcional y para las versiones halógena y fluorescente un filtro de color.

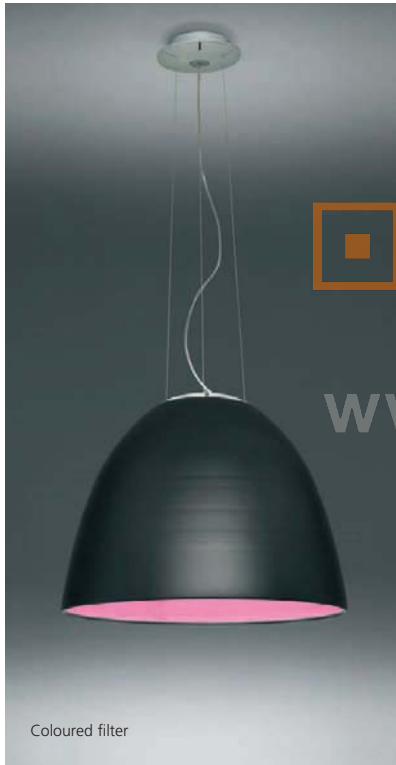

MODULO
ELECTRO
www.modulelectro.ru

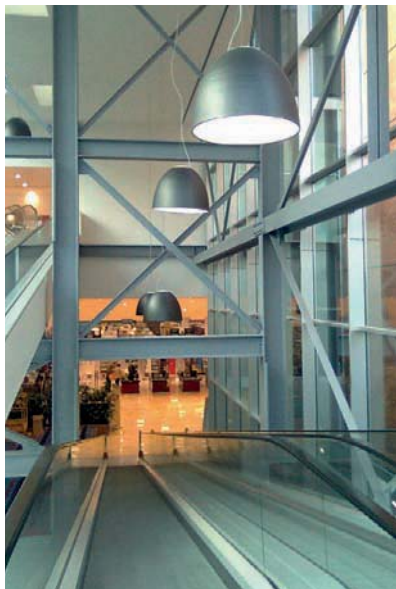
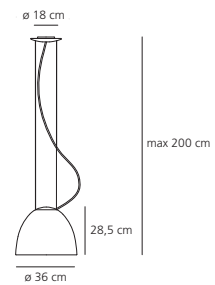
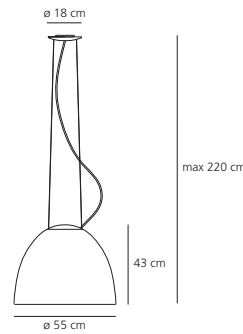
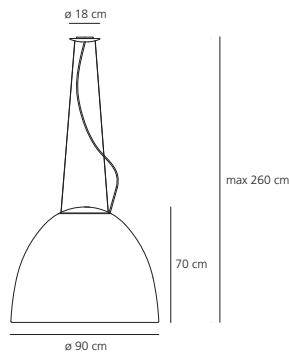

Nur 1618

HALO max 2x400W (R7s) –ES, included



FLUO 1x120W (2G 8) – TC-TELI, included
Electronic ballast



FLUO 4x57W (GX 24 q-5) – TC-TEL, included
Electronic ballast



METAL HALIDE 1x250W (E 40) – HIE
Ferromagnetic ballast



METAL HALIDE 1x400W (E 40) – HIE
Ferromagnetic ballast



Nur

HALO max 1x205W (E 27) – ECO



FLUO 1x120W (2G 8)– TC-TEL, included
Electronic ballast



FLUO 1x70W (GX 24 q-6) – TC-TEL, included
Electronic ballast



METAL HALIDE 1x150W (E 27) – HIE
Ferromagnetic or electronic ballast



METAL HALIDE 1x250W (E 40) – HIE
Ferromagnetic ballast



Nur Mini

HALO max 1x160W (R7s) – ES





MODULO
ELECTRO
www.modulelectro.ru

Nur Gloss Nur mini Gloss

design

Ernesto Gismondi
2008, 2009



145

Materiali: corpo lampada in alluminio verniciato; diffusore in materiale termoplastico; calotta superiore in vetro borosilicato sabbato.

Specificità: una finitura perfettamente liscia e lucida conferisce eleganza al classico modello Nur. Tutte le versioni sono chiuse da un diffusore nella parte inferiore.

Light emission



Colours



Polished black



Polished white

Materials

Painted aluminium body lamp; diffuser in thermoplastic material; upper cap in borosilicate sanded glass.

Matériaux

Corps en aluminium verni; diffuseur en matériau thermoplastique; calotte supérieure en verre borosilicate sablé.

Materialien

Körper aus lackiertem Aluminium; Schirm aus thermoplastischem Material; obere Abdeckung aus Sand-Borosilikatglas.

Materiales

Cuerpo de aluminio pintado, difusor de material termoplástico, campana superior en cristal borosilicado arenado.

Specification

A new perfectly smooth and polished finish gives elegance to the classic Nur model. All the versions are encased in a diffuser at the bottom.

Spécificité

Une nouvelle finition parfaitement lisse et brillante donne plus d'élégance au modèle Nur classique. Toutes les versions sont fermées par un diffuseur dans la partie inférieure.

Spezifikation

Die neue Hochglanzpolitur verleiht dem Klassiker Nur eine besondere Eleganz. Alle Ausführungen sind mit einem an der Unterseite des Schirms angebrachten Diffusor versehen.

Especificaciones

Un nuevo acabado perfectamente liso y brillante confiere elegancia al clásico modelo Nur. Todas las versiones están cerradas por un difusor en la parte inferior.

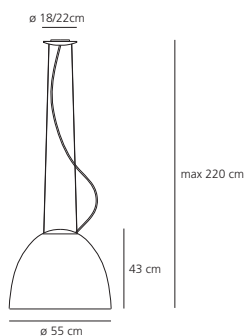

Nur Gloss

HALO max 1x205W (E 27) – ECO

IP20 IP40

FLUO 1x70W (GX 24 q-6) – TC-TEL, included
Electronic ballast

IP20 IP40

METAL HALIDE 1x100W (E 27) – HIE
Electronic ballast

IP20 IP40

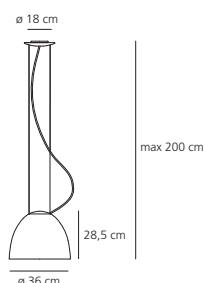

Nur Mini Gloss

HALO max 1x150W (E 27) – ECO

IP20 IP40

FLUO 1x24W (GX 24 q-6) – TC-TEL, included
Electronic ballast

IP20 IP40

METAL HALIDE 1x100W (E 27) – HIE
Electronic ballast

IP20 IP40



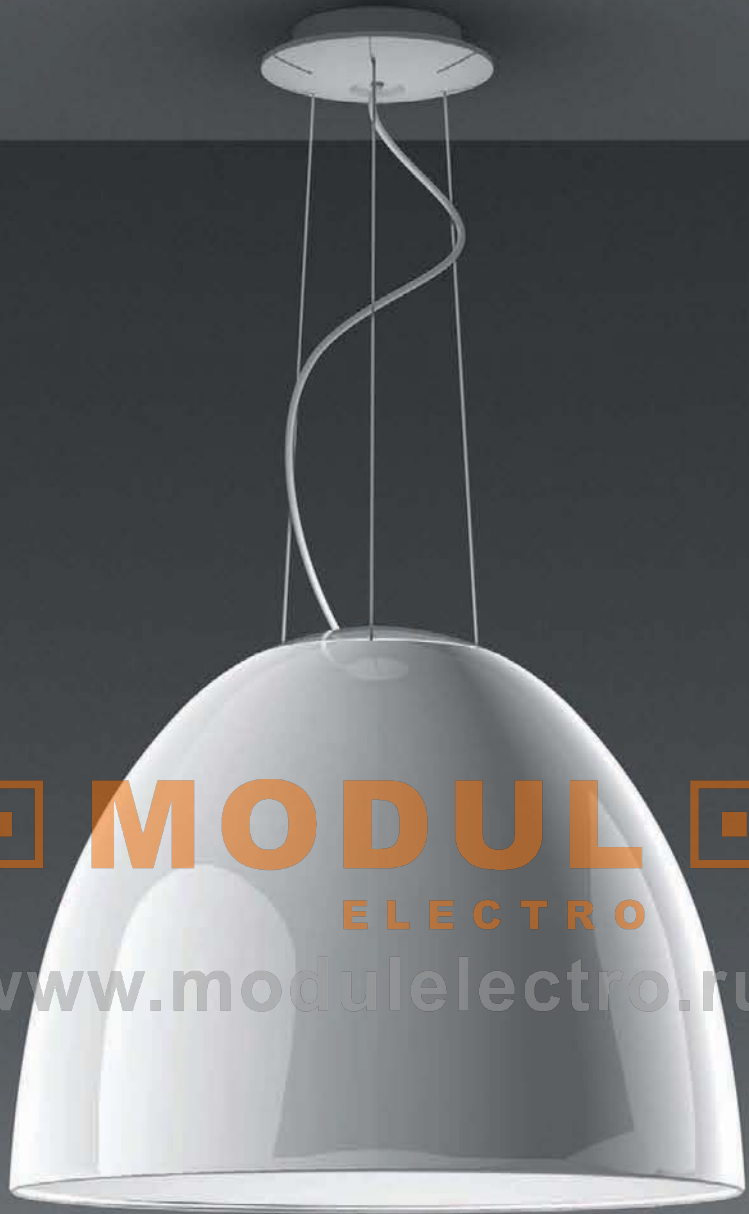

MODUL
ELECTRO
www.modulelectro.ru

“La luce del nero. L’occhio scopre lo spazio a partire dall’ombra. Meno luce, ritorno all’ombra senza sprechi. Superfici riflettenti e quattro linee luminose di LED generano tagli cromatici e figurativi per esplorare l’ambiente. La luce, ridotta alla sua essenza, disegna lo spazio. Lo specchio, macchina ottica, a seconda dell’angolazione crea una nuova visione. 24 sorgenti LED dirette, con luce bianca dalla temperatura di colore modulabile, definiscono una territorialità, altrettante e identiche sorgenti indirette trasformano la penombra in una camera chiara. La luce diventa sottrazione, è il buon luogo, nel quale la luce mi segue, diventa liquida e si fonde nello spazio”.

Materiali: alluminio specchiato.

Light emission



Colours

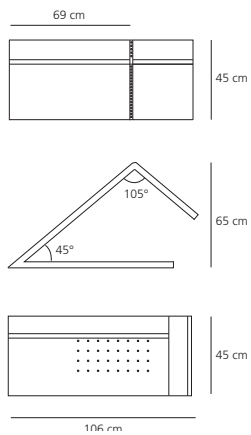
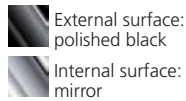

Direct emission:

12 LED Warm White

12 LED Cold White

Indirect emission:

12 LED Warm White

12 LED Cold White

LED line:

4 LED RGB lines (max 35W)

IP20 Dimmer

“The light of black. The eye discovers space starting from shade. Less light, a wasteless return to shade. Reflecting surfaces and four luminous Led lines generate colours and images to explore the environment. Light, reduced to its essence, designs space. The mirror, an optical machine, creates new visions according to its angle. 24 direct Led sources, with a white light with adjustable colour temperature, define the space limits, as many identical indirect sources turn half-light into a clear chamber. Light becomes subtraction, it is the good place where light follows me, becomes fluid, and melts into space”.

Materials

Reflecting aluminium.

“La lumière du noir. L’œil découvre l’espace à partir de l’ombre. Moins de lumière, permet un retour à l’ombre sans gaspillage. Des surfaces réfléchissantes et quatre lignes lumineuses de Leds engendrent des coupes chromatiques et figuratives pour explorer l’environnement. La lumière, réduite à son essence, dessine l’espace. Selon l’angle, le miroir, machine optique, crée une nouvelle vision de la lumière. 24 sources de Leds directes, avec une lumière blanche à température de couleur modulable, définissent une territorialité; autant de sources indirectes identiques transforment la pénombre en un espace clair. La lumière devient une soustraction, c’est le lieu juste où la lumière me suit, devient liquide et se fond avec l’espace”.

Matériaux

Aluminium réfléchissant.

“Licht aus der Dunkelheit. Ausgehend von Schatten ergründet das Auge den Raum. Wenig Licht bedeutet Reduktion auf leichte Schatten. Eine reflektierende Oberfläche mit vier LED Lichtlinien erzeugt eine farbige Segmentierung des Raums und gibt eine Raumgeometrie frei. Das Licht, reduziert auf das Wesentliche, erzeugt die Raumtiefe. Ein Spiegel, als optisches Werkzeug, erzeugt je nach Blickwinkel unterschiedliche Raumdimensionen. 24 gerichtete LED in zwei unterschiedlichen Farbtönen schaffen ein Raumzentrum, das die indirekten Lichtquellen in der Erzeugung eines Raumes ergänzen. Das Licht erhebt sich im Zentrum, bietet Halt und verbindet sich gleichzeitig mit dem Raum.

Materialien

Reflektierendes Aluminium.

“La luz del negro. El ojo descubre el espacio a partir de la sombra. Menos luz, retorno a la sombra sin derroches. Superficies reflectantes y cuatro líneas luminosas de Led generan cortes cromáticos y figurativos para explorar el ambiente. La luz, reducida a su esencia, diseña el espacio. El espejo, máquina óptica, dependiendo del ángulo crea una nueva visión. 24 fuentes Led directas, con luz blanca con temperatura de color modulable, definen una territorialidad, otras tantas e idénticas fuentes indirectas transforman la penumbra en una cámara clara. La luz se vuelve sustracción, es el buen lugar, en el que la luz me sigue, se vuelve líquida y se funde en el espacio”.

Materiales

Aluminio acabado espejo.



 **MODUL** 
ELECTRO

www.modulelectro.ru

Eutopia Pro

design

Carlotta de Bevilacqua
2009



“Lo specchio capovolge le prospettive attraverso interferenze visive, ed interagisce con lo spazio: ha la capacità di catturare le dinamiche che avvengono in un luogo; moltiplica i punti di vista, diventando un filtro nel rapporto interno-esterno. Una presenza solitaria nello spazio o un continuum di luce dinamica senza interruzioni o linee d’ombra.”

Materiali: struttura in alluminio specchiato; superficie inferiore in vetro a specchio; ottica in alluminio lucido; diffusore in PMMA con prismatura esagonale.

Specificità: disponibile in versione base fluorescente in cui la striscia di colore è data da un filtro, e in versione fluo con linea Led RGB. Un sistema a cerniera consente la connessione dei vari moduli, permettendo varie configurazioni del prodotto: una trave dritta o dinamica, a sospensione o a parete.

Light emission



Colour



Mirror

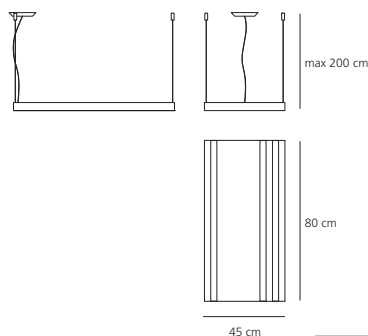

“The mirror reverses perspectives through visual interferences, and interacts with space: it has the ability to capture the dynamics of a place; it multiplies points of view, and becomes a filter in the indoor-outdoor relation. A lonely entity in space or a continuum of dynamic light without breaks or shadows”.

“Le miroir renverse les perspectives à travers des interférences visuelles, et interagit avec l’espace: il possède la capacité de capturer les dynamiques qui ont lieu dans un endroit; il multiplie les points de vue, en devenant un filtre dans le rapport interne-externe. Une présence solitaire dans l’espace ou un continuum de lumière dynamique sans interruptions ou lignes d’ombre”.

“Ein Spiegel erzeugt Perspektiven, die sich optisch überlagern und mit dem Raum in Wechselwirkung treten. Der Spiegel besitzt die Fähigkeit die Dynamik des Raumes einzufangen. Daraus entstehen unendlich viele Blickwinkel, die mit anderen Spiegelementen interagieren. Das Licht kann als Einzelement oder als dynamische Folge von Elementen ohne Schattenphasen konfiguriert werden.”

“El espejo invierte las perspectivas a través de interferencias visuales, e interactúa con el espacio: tiene la capacidad de capturar las dinámicas que ocurren en un lugar; multiplica los puntos de vista, volviéndose un filtro en la relación interior-exterior. Una presencia solitaria en el espacio o un continuum de luz dinámica sin interrupciones o líneas de sombra”.

Eutopia Pro fluo

FLUO 2x39W (G5) - T 16
Electronic ballast

IP20 Dimmer

Eutopia Pro fluo + Led

FLUO 2x39W (G5) - T 16
Electronic ballast

LED line:
900mm: LED RGB max 11W

IP20 Dimmer

Materials

Structure in reflecting aluminium; bottom surface in mirror glass, polished aluminium lenses; PMMA diffuser with hexagonal prisms.

Matériaux

Structure en aluminium réfléchissant ; surface arrière en verre finition miroir ; optique en aluminium brillant ; diffuseur en PMMA avec prisme hexagonal.

Materialien

Struktur aus reflektierendem Aluminium. Oberfläche im unteren Bereich aus Spiegelglas. Blenden aus glänzendem Aluminium. Lichtverteiler aus PMMA mit 6eckigen Prismen.

Materiales

Estructura de aluminio acabado espejo; superficie inferior en cristal espejado; óptica de aluminio brillante; difusor de PMMA con prismado hexagonal.

Specification

Available in two versions: fluo with coloured strip filter and fluo plus Led RGB line. A hinge system allows to connect the modules together, thus creating a variety of product configurations: a straight or dynamic, suspended or wall-mounted beam.

Spécificité

Disponible en deux versions : fluorescente avec un filtre linéaire coloré et fluorescente avec une ligne Led RGB. Un système à charnière permet la connexion des différents modules, et consent diverses configurations du produit : une poutre droite ou dynamique, à suspension ou murale.

Spezifikation

Erhältlich in den Versionen Fluo mit farbigem Filterband und Fluo Plus mit Led-LED Linie. Ein Scharniersystem ermöglicht die Verbindung mehrerer Module und schafft so verschiedene Möglichkeiten der Raumgestaltung. Ein fester oder dynamischer Befestigungsträger ermöglicht die Wand- und Deckenmontage.

Especificaciones

Disponible en versión base fluorescente en la cual la tira de color se da gracias a un filtro, está en versión fluo con línea Led RGB. Un sistema de bisagras consente la conexión de los diferentes módulos, permitiendo diferentes configuraciones de producto: un larguero recto o dinámico, suspendido o de pared.





 **MODUL** 
ELECTRO

www.modulelectro.ru

Altrove sospensione

design

Carlotta de Bevilacqua
2008



“Un m² di superficie dove la luce scorre fluida su fili trasparenti che attraverso un riflettore a specchio materializza un effetto luminoso volumetrico e controllato. È un m³ di luce nel quale ci si riflette all’infinito modulando liberamente più di un milione di effetti cromatici. Lo spazio non è più uno, ma diventa molti o semplicemente altro, percezione illusoria della realtà che porta verso un nuovo luogo, altrove. “

Materiali: struttura perimetrale in alluminio a specchio; diffusori laterali in Prismoptic satinato; diffusore frontale in metacrilato trasparente inciso; diffusore superiore in PETG trasparente.

Specificità: sono disponibili due versioni che emettono luci differenti a seconda del riflettore.

Luce fluida: con riflettore in alluminio lucido a specchio.

Luce volumetrica alluminio lucido a specchio a segmenti ottici.

Light emission



Colour



Mirror

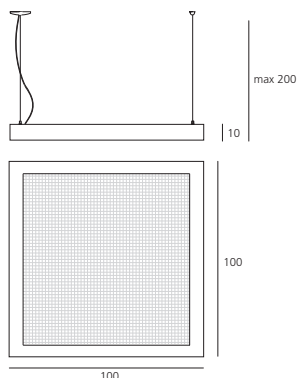

FLUO 2x3 RGB groups (tot. 6) x 39W (G 5) – T 16, (234W total power), included Electronic ballasts

IP20 Dimmer



Infrared remote control (included)



Wall mounted control panel (to order separately)

“In a m² of surface where the light flows in a fluid way on transparent wires and, through a mirrored reflector, materializes a lighting and volumetric effect wich is controlled. It is a cubic metre of light where everything is endlessly reflected, freely modulating more than a million of chromatic effects. The space is no more just one, but several, or simply “else”, illusory perception of reality, which drivesto a new place, elsewhere”.

Materials

Perimeter structure made of mirror aluminium; side diffusers made of opaline Prismoptic; front diffuser in transparent engraved methacrylate; upper diffuser in transparent PETG.

Specification

Two versions are available, with two kind of reflector.
Fluid light: with mirror aluminium reflector.
Volumetric light: with segment reflector in mirror aluminium.

Un m² de surface où la lumière entre avec fluidité sur des fils transparents et au travers d’un réflecteur miroir. Altrove matérialise un éclairage à effet volumétrique commandé. C’est un mètre cube de lumière où celle-ci se réfléchit sans fin et qui module librement plus d’un million d’effets chromatiques. L’espace n’en est plus un mais plusieurs ou simplement autre chose, perception illusoire de la réalité, qui mène à un nouvel endroit, ailleurs.

Matériaux

Périmètre de la structure en aluminium ; diffuseurs latéraux en Prismoptic opalin ; diffuseur frontal en méthacrylate transparent strié ; diffuseur supérieur en PETG transparent.

Spécificité

Deux versions sont disponibles avec deux types de réflecteur.
Lumière fluide : avec réflecteur miroir.
Lumière volumétrique : avec lames de réflecteur miroir.

“Auf einer Fläche von einem Quadratmeter auf der das Licht in fließender Bewegung über transparente Nylonkabel geleitet und durch eine Spiegelfläche reflektiert wird, materialisiert sich das Licht und erzeugt einen einzigartigen, strukturierten Volumeneffekt. In einem Quadrat aus Licht das sich ins Endlose reflektiert, werden Millionen von farbigen Effekten erzeugt. Die Fläche hat damit nicht mehr nur eine, sondern viele oder einfach “weitere” scheinbare Realitäten, die zu einer neuen Dimension führen”.

Materialien

Rahmen aus verspiegeltem Aluminium; seitliche Reflektoren mit opaliner Prismoptic; Frontscheibe aus transparentem, graviertem Metacrylat; oberer Diffusor aus transparentem PETG.

Spezifikation

Erhältlich in zwei Versionen:
Fließendes Licht: Reflektor aus verspiegeltem Aluminium.
Volumen erzeugendes Licht: Lamellenreflektor aus verspiegeltem Aluminium.

Para materializar un efecto luminoso volumétrico y controlado, se ha creado un metro cuadrado de superficie donde la luz discurre con fluidez sobre hilos transparentes que cruzan un reflector en forma de espejo. Se trata de un metro cúbico de luz en el cual reflejarse hacia el infinito modulando libremente más de un millón de efectos cromáticos. El espacio ya no es único, sino que se convierte en una multitud de espacios o simplemente en uno distinto, en una percepción ilusoria de la realidad que nos conduce a un nuevo lugar, más allá.

Materiales

Estructura perimetral de aluminio, difusores laterales de Prismoptic opalino, difusor frontal de metacrilato transparente; difusor superior en PETG transparente.

Características técnicas

Están disponibles dos versiones que se caracterizan por dos tipos de reflector.
Luz fluida: con reflector en acabado espejo.
Luz volumétrica: con reflector de segmentos ópticos.

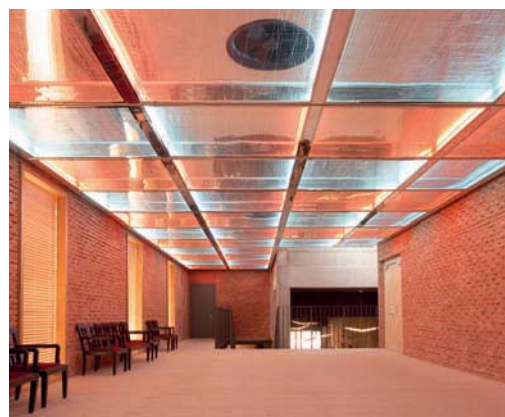



MODUL
ELECTRO
www.modulelectro.ru

Tian Xia family

design
Carlotta de Bevilacqua



Serie di lampade a sospensione disponibili in diverse versioni.

2 dimensioni: Tian Xia (ø diffusore 80 cm) e Tian Xia 500 (ø diffusore 50 cm).

Soluzioni luminose: sono disponibili diverse combinazioni delle missioni diretta, indiretta e diffusa, da Metamorfofi alla versione Led, a seconda del modello.

Range of suspension lamps available in many versions.

2 sizes

Tian Xia (diffuser ø 80 cm) and Tian Xia 500 (diffuser ø cm 50).

Lighting solutions

Many combinations of direct, indirect and diffused emission are available, from Metamorfofi to Led version, according with the model.

Série de suspensions disponibles dans différentes versions.

2 tailles

Tian Xia (diffuseur ø 80 cm) et Tian Xia 500 (diffuseur ø cm 50).

Solutions d'éclairage

Nombreuses combinaisons d'émission directe, indirecte et diffuse, de a version Metamorfofi à la version Led en fonction du modèle.

Familie von Pendelleuchten.

2 Größen

Tian Xia (Schirm Ø80 cm) und Tian Xia 500 (Schirm Ø50 cm).

Lichtlösungen

Umfangreiche Kombinationen direkter, indirekter und gestreuter Lichtverteilung möglich, von der Metamorfofi-Technologie bis hin zu Led (siehe Grafik).

Serie de lámparas de suspensión disponibles en distintas versiones.

2 dimensiones

Tian Xia (ø difusor 80 cm) y Tian Xia 500 (ø difusor 50 cm).

Soluciones luminosas

Están disponibles diversas combinaciones de las emisiones directa, indirecta y difusa, desde Metamorfofi a la versión Led, según el modelo.

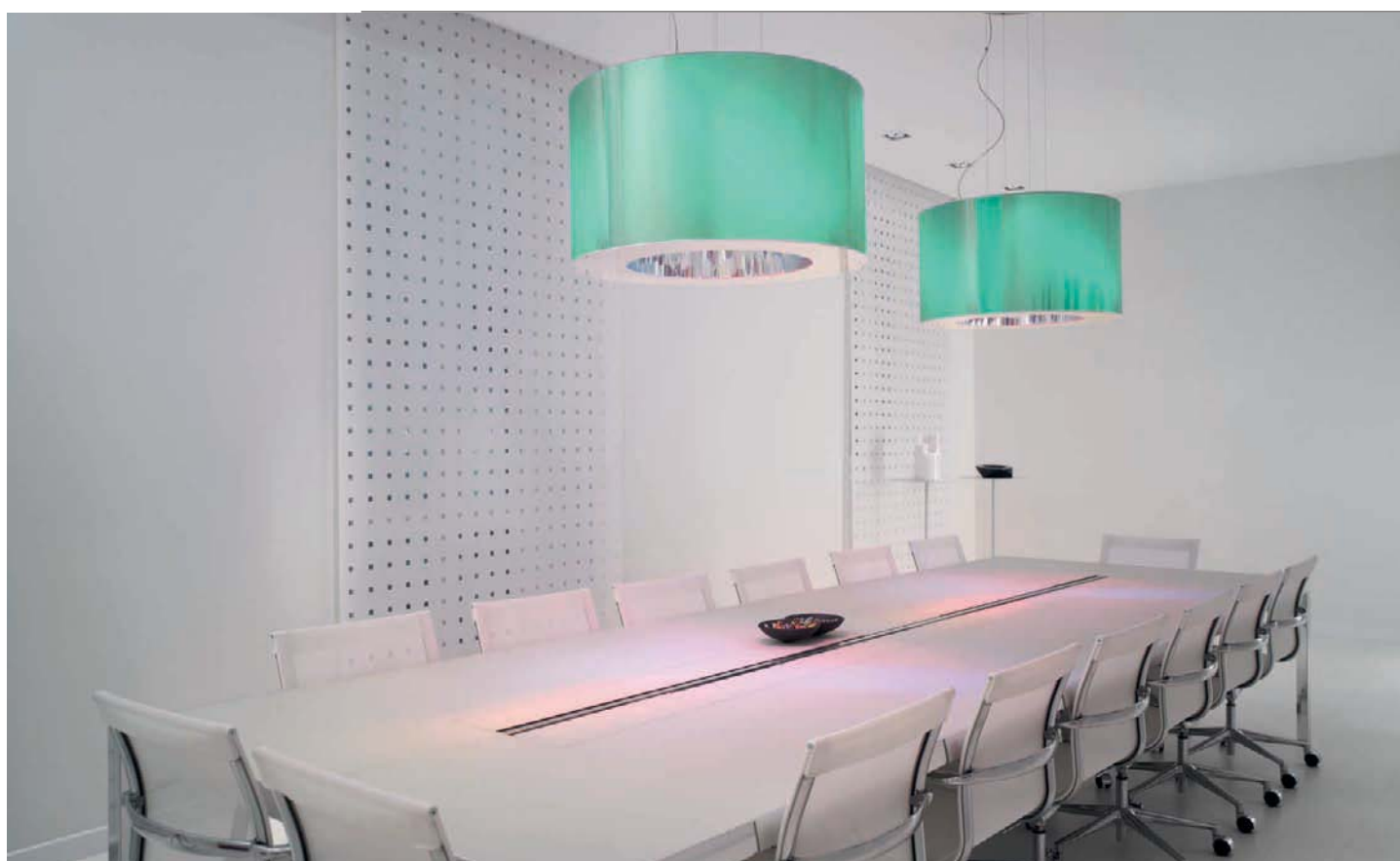
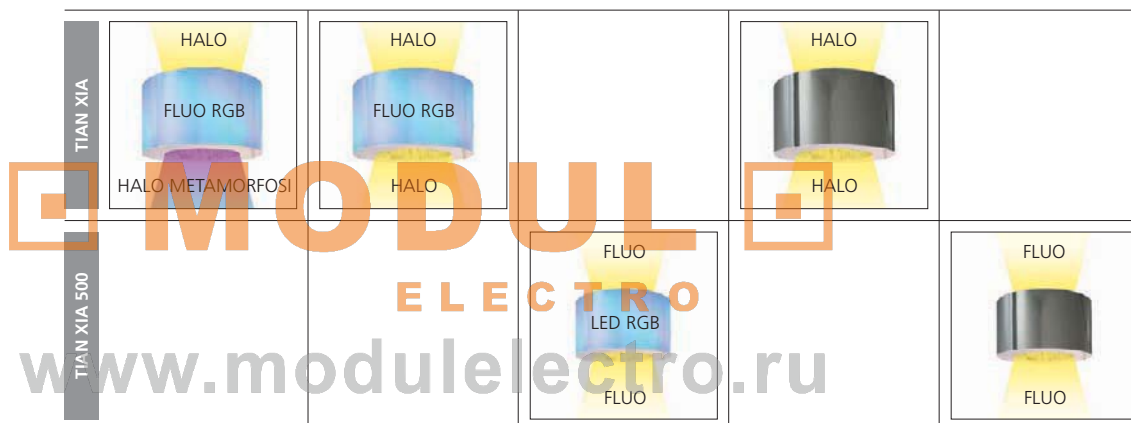



MODUL
ELECTRO

www.modulelectro.ru

Awards

Design Innovationen – Design Zentrum Nordrhein Westfalen
Reddot Design Award
2004 – Essen (Deutschland)

Materiali: struttura in alluminio lucido con finitura a specchio; diffusore in resina termoplastica, con film traslucido finitura specchio.

Specificità: TianXia utilizza tre sistemi luminosi per luce diretta, indiretta e diffusa. Luce diretta: sistema Metamorfosi, costituito da sorgenti alogene con i filtri dicroici rosso, verde e blu che consentono di ottenere infinite atmosfere di luce colorata. Luce diffusa: sistema RGB che produce 6 varianti di luce colorata e una di luce bianca, costituito da sorgenti fluorescenti lineari posizionate nella intercapedine del cilindro diffusore. Luce indiretta: sorgente alogena. Attraverso un telecomando è possibile gestire separatamente i tre sistemi luminosi, richiamare 10 atmosfere standard, crearne e memorizzarne ulteriori 10 e agire sull'intensità luminosa.

Light emission



Colour

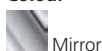

Mirror

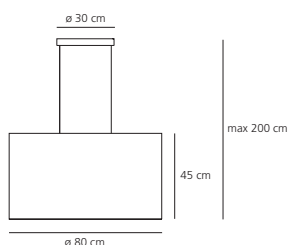

Indirect emission:

HALO max 400W (R7s) – ES, included

Diffused emission:

FLUO 4x3 RGB groups (tot. 12) x 14W (G 5) – T 16, included. Electronic ballast

Direct emission:

HALO max 3x150W (B 15d) – ECO, included



Infrared remote control (included)



Wall mounted control panel (to order separately)

Materials

Mirror-treated finish polished aluminium structure; thermoplastic resin diffuser with translucent film mirror-finish.

Specification

Tian Xia uses three systems for direct, indirect and diffused light. Direct light: Metamorfosi system, consisting of halogen sources with dichroic filters red, green and blue, which allow to create a wide range of light coloured atmospheres. Diffused light: RGB system producing 6 coloured light range and a white light, consisting of linear fluorescent sources positioned in the cavity of the diffuser cylinder. Indirect light: halogen source. It is possible, using a remote control, to manage 10 standard atmospheres, to create and memorise other 10 and to adjust the light intensity.

Matériaux

structure en aluminium brillant avec finition miroir ; diffuseur en résine thermoplastique, avec film translucide finition miroir.

Spécificité

Tian Xia utilise trois systèmes lumineux : lumière directe, indirecte et diffuse. Lumière directe : Metamorfosi système, constitué de sources halogènes avec filtres dichroïques rouge, vert et bleu, permettant d'obtenir de nombreuses atmosphères de lumière colorée. Lumière diffuse : RGB système produisant 6 ambiances colorées et une de lumière blanche, constitué de sources fluorescentes linéaires positionnées à l'intérieur du diffuseur. Lumière indirecte : source halogène. A l'aide de la télécommande, il est possible de gérer 10 atmosphères standard, d'en créer et d'en mémoriser 10 autres et d'agir sur l'intensité lumineuse.

Materialien

Rahmen aus hochglanzpoliertem Aluminium; Lichtverteiler aus Kunstharz mit transluzenter Folie, Oberfläche hochglanzpoliert.

Spezifikation

Drei Arten der Lichtverteilung: direkt, indirekt und gestreut. Direkte Lichtverteilung: die Metamorfosi-Technologie, bestehend aus Halogenlampen mit dichroitischen Filtern in den Grundfarben Rot, Blau und Grün, schafft unzählige farbige Lichtstimmungen. Gestreute Lichtverteilung: ein RGB System aus Leuchtstoffröhren, die im zylindrischen Leuchtenkörper angeordnet sind, schafft 6 farbige Lichtstimmung sowie Weißlicht. Indirekte Lichtverteilung: durch Einsatz von Halogenlampen. Die Lichtstimmungen sind über eine Fernbedienung abrufbar (10 Standardlichtstimmungen, 10 Einstellungen bzgl. der Lichtintensität).

Materiales



Estructura en aluminio brillante con acabado espejo; difusor en resina termoplástica, con film traslúcido acabado espejo.

Especificaciones

Tian Xia incorpora tres sistemas luminosos para luz directa, indirecta y difusa. Luz directa: sistema Metamorfosi, consta de fuentes luminosas halógenas con filtros dicroicos, rojo, verde y azul, que permiten obtener infinitas atmósferas de luz coloradas. Luz difusa: sistema RGB, que produce 6 variantes de luz de color y una luz blanca, consta de fuentes luminosas fluorescentes lineales, que están ubicadas en el interior del cilindro difusor. Luz indirecta: fuente de luz halógena. Mediante un mando a distancia es posible manejar 10 atmósferas standard, crear y memorizar otras 10 y actuar en la intensidad luminosa.





 **MODUL** 
ELECTRO
www.modulelectro.ru





Materiali: struttura in alluminio lucido con finitura a specchio; diffusore in resina termoplastica, con film traslucido finitura specchio.

Specificità: utilizza tre sistemi luminosi per luce diretta, indiretta e diffusa. Luce diffusa: sistema RGB che produce 6 varianti di luce colorata e una di luce bianca, costituito da sorgenti fluorescenti lineari posizionate nella intercapedine del cilindro diffusore. Luce indiretta e luce diretta: sorgenti alogene. È disponibile un filtro colorato come accessorio. Attraverso un telecomando è possibile gestire separatamente i tre sistemi luminosi e agire sull'intensità luminosa.

Light emission



Colour

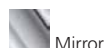

Materials

Mirror-treated finish polished aluminium structure; thermoplastic resin diffuser with translucent film mirror-finish.

Specification

Tian Xia 2 uses three systems for direct, indirect and diffused light. Diffused light: RGB system producing 6 coloured light range and a white light, consisting of linear fluorescent sources positioned in the cavity of the diffuser cylinder. Indirect and direct light: halogen sources. A coloured filter is provided as an accessory. By a remote control it is possible to manage separately the three light systems and to adjust the light intensity.

Matériaux

Structure en aluminium brillant avec finition miroir ; diffuseur en résine thermoplastique, avec film translucide finition miroir.

Spécificité

Tian Xia 2 utilise trois systèmes lumineux : lumière directe, indirecte et diffuse. Lumière diffuse : RGB système, produisant 6 ambiances colorées et une de lumière blanche, constitué de sources fluorescentes linéaires positionnées à l'intérieur du diffuseur. Lumière indirecte et directe : sources halogènes. Un filtre coloré est fourni en tant qu'accessoire. A l'aide de la télécommande il est possible de gérer séparément les trois systèmes lumineux et d'agir sur l'intensité lumineuse.

Materialien

Rahmen aus hochglanzpoliertem Aluminium; Lichtverteiler aus Kunstharz mit durchscheinender Folie, Oberfläche hochglanzpoliert.

Spezifikation

Lichtverteilung: direkt, indirekt und gestreut. Die gestreute Lichtverteilung wird durch ein RGB-System erzeugt, das 6 farbige Lichtstimmungen sowie Weißlicht kreiert. Farbfilter für die Halogenvariante im Lieferumfang enthalten. Die Lichttechnik ist durch eine Fernbedienung individuell steuerbar.

Materiales

Estructura en aluminio brillante con acabado espejo; difusor en resina termoplástica, con film traslúcido acabado espejo.

Especificaciones

Tian Xia 2 incorpora tres sistemas luminosos para luz directa, indirecta y difusa. Luz difusa: sistema RGB que produce 6 variantes de luz de color y una luz blanca, consta de fuentes luminosas fluorescentes lineales, que están ubicadas en el interior del cilindro difusor. Luz indirecta y luz directa: lámparas halógenas. Se suministra un filtro de color como accesorio de serie. Mediante un mando a distancia es posible gobernar por separado los tres sistemas luminosos y actuar en la intensidad luminosa.

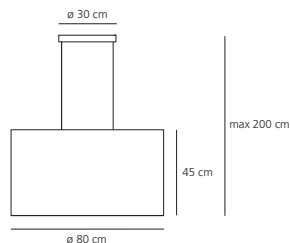

Indirect emission:
HALO max 1x400W (R7s) – ES, included
Diffused emission:
FLUO 4x3 RGB groups (tot. 12) x 14W (G 5) – T 16, included. Electronic ballast
Direct emission:
HALO max 1x230W (R7s) – ES, included

IP20 ⚡ ⚠ Ⓢ Ⓜ + Dimmer



Infrared remote control (included)



Wall mounted control panel (to order separately)



Coloured filter

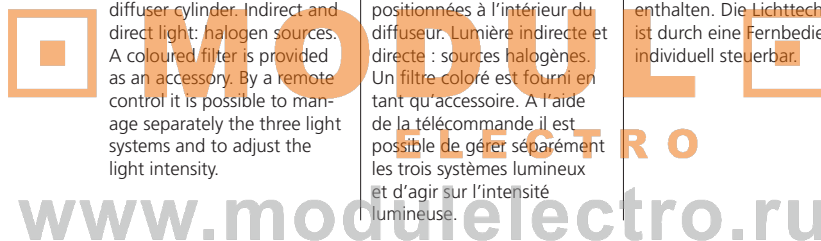

Tian Xia halo

design

Carlotta de Bevilacqua
2003



Awards

Design Innovationen – Design
Zentrum Nordrhein Westfalen
Reddot Design Award
2004 – Essen (Deutschland)

Materiali: struttura in alluminio lucido con finitura a specchio; corpo in resina termoplastica, con film traslucido finitura specchio.

Specificità: Tian Xia halo è la versione a solo luce bianca della serie Tian Xia.

Light emission



Colour



Mirror

Materials

Mirror-treated finish polished aluminium structure; thermoplastic resin diffuser with translucent film mirror-finish.

Specification

Tian Xia halo is the only white light version of the Tian Xia range.

Matériaux

Structure en aluminium brillant avec finition miroir ; diffuseur en résine thermoplastique, avec film translucide finition miroir.

Spécificité

Tian Xia halo est la seule version à lumière blanche de la série Tian Xia.

Materialien

Rahmen aus hochglanzpoliertem Aluminium; Leuchtenkörper aus Kunstharz mit transluzenter Folie, Oberfläche hochglanzpoliert.

Spezifikation

Tian Xia halo erzeugt allein Weißlicht.

Materiales

Estructura en aluminio brillante con acabado espejo; difusor en resina termoplástica, con film traslúcido acabado espejo.

Especificaciones

Tian Xia halo es la versión con solo luz blanca de la serie Tian Xia.

MODULO

ELECTRO

www.modulelectro.ru

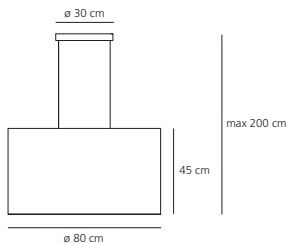

Indirect emission:

HALO max 1x400W (R7s) – ES, included

Direct emission:

HALO max 1x230W (R7s) – ES, included



Tian Xia 500 Led

design

Carlotta de Bevilacqua
2008



Materiali: struttura in alluminio lucido con finitura a specchio; diffusore in resina termoplastica, con film traslucido finitura specchio.

Specificità: riduce dell'80% i consumi mantenendo le prestazioni, nel segno della sostenibilità e in seguito agli sviluppi della tecnologia delle sorgenti. Utilizza tre sistemi luminosi per luce diretta, indiretta e diffusa, gestibili separatamente. In emissioni diretta e indiretta sono utilizzate sorgenti fluorescenti compatte, mentre per quella diffusa sono utilizzate strisce Led RGB, che producono 6 varianti di luce colorata e una di luce bianca.

Light emission

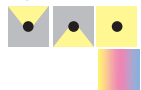

Colour



Mirror

Materials

Mirror-treated finish polished aluminium structure; thermoplastic resin diffuser with translucent film mirror-finish.

Specification

Tian Xia 500 Led reduces of 80% the consumption, maintaining the performances, in the sign of sustainability and as consequence to the source technology developments. Uses three systems for direct, indirect and diffused light, managed separately. By direct and indirect emissions compact fluorescent light sources are employed, while for the diffused one strips Led RGB are used, that produce 6 coloured light range and a white light.

Matériaux

Structure en aluminium brillant avec finition miroir ; diffuseur en résine thermoplastique, avec film translucide finition miroir.

Spécificité

Tian Xia 500 Led réduit la consommation énergétique de 80% tout en maintenant les performances, et ceci dans une démarche de développement durable suite à l'évolution technologique des sources. Elle utilise trois systèmes lumineux : lumière directe, indirecte et diffuse, pilotés séparément. Pour l'émission de lumière directe et indirecte, des sources fluorescentes compactes sont utilisées et, pour obtenir une lumière diffuse on emploie des Led RGB, permettant d'obtenir 6 ambiances colorées et une de lumière blanche.

Materialien

Rahmen aus hochglanzpoliertem Aluminium; Lichtverteiler aus Kunstharz mit durchscheinender Folie, Oberfläche hochglanzpoliert.

Spezifikation

Als Ergebnis der stetigen Forschung im Bereich der LED-Technologie und als Zeichen der Nachhaltigkeit reduziert die Tian Xia 500 Led den Energieverbrauch bei gleich bleibender Lichtleistung um 80%. In drei Ausführungen für direkte, indirekte und gestreute Lichtverteilung erhältlich. Direkte und indirekte Lichtverteilung bei Ausführung für Kompaktleuchtstofflampen; gestreute Lichtverteilung bei Ausführung für LED RGB (6 farbige Lichtstimmungen sowie Weißlicht).

Materiales

Estructura en aluminio brillante con acabado espejo; difusor en resina termoplástica, con film traslúcido acabado espejo.

Especificaciones

Tian Xia 500 Led reduce un 80% los consumos, manteniendo al mismo tiempo, las prestaciones, en un signo de la sostenibilidad y la raíz de los acontecimientos en la tecnología de fuentes de luz. Incorpora tres sistemas luminosos para luz directa, indirecta y difusa, gestionados separadamente. Para la emisión directa e indirecta se utilizan fuentes de luz fluorescentes compactas, mientras para la emisión difusa se utilizan fuentes de luz Led RGB, que permiten obtener 6 variantes de luz de color y una luz blanca.

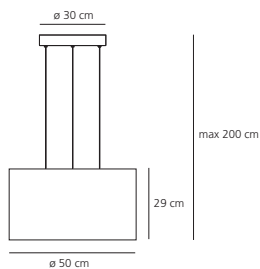

Indirect emission:
FLUO 1x42W (GX 24q-4) – TC-TEL, included
Electronic ballast
Diffused emission:
12 LED strips, (30W total power), included
Direct emission:
FLUO 1x42W (GX 24q-4) – TC-TEL, included
Electronic ballast

IP20 Dimmer



Infrared remote control (included)



Wall mounted control panel (to order separately)



Tian Xia 500 fluo

design

Carlotta de Bevilacqua
2003



Materiali: struttura in alluminio lucido con finitura a specchio; corpo in resina termoplastica, con film traslucido finitura specchio.

Light emission



Colour



Mirror

Materials

Mirror-treated finish polished aluminium structure; thermoplastic resin diffuser with translucent film mirror-finish.

Matériaux

Structure en aluminium brillant avec finition miroir ; diffuseur en résine thermoplastique, avec film translucide finition miroir.

Materialien

Rahmen aus hochglanzpoliertem Aluminium; Leuchtenkörper aus Kunstharz mit transluzenter Folie, Oberfläche hochglanzpoliert.

Materiales

Estructura en aluminio brillante con acabado espejo; difusor en resina termoplástica, con film traslúcido acabado espejo.

MODULO

ELECTRO

www.modulelectro.ru

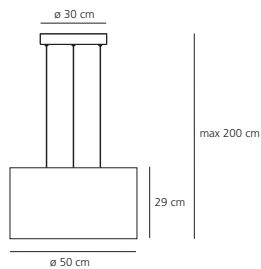

Indirect emission:
FLUO 2x42W (GX 24q-4) – TC-TEL, included
Electronic ballast
Direct emission:
FLUO 1x42W (GX 24q-4) – TC-TEL, included
Electronic ballast

IP20 Dimmer



Awards

Compasso d'Oro / A.D.I. – Segnalazione 2008 – Milano (Italia)

Design Award of the Federal Republic of Germany 2009 – Nomination Frankfurt (Deutschland)

Light emission



Colour



White

Materiali: struttura in alluminio; diffusore inferiore in metacrilato prismatico; diffusore superiore in metacrilato trasparente.

Specificità: utilizza sorgenti RGB che consentono di ottenere infinite declinazioni della luce bianca, nelle sue diverse intensità e varietà delle temperature di colore, dalla più calda (2.500 K) alla più fredda (20.000 K). La regolazione delle funzioni avviene attraverso un telecomando a infrarossi.

Materials

Aluminium structure; lower prismatic diffuser in methacrylate; upper diffuser in transparent methacrylate.

Specification

It uses RGB light sources, which enable a limitless variation of white light with different intensities and a variety of colour temperatures, from the warmest (2.500 K) to the coolest (20.000 K). The colour selection functions are set by an infrared remote control.

Matériaux

Structure en aluminium ; diffuseur inférieur en méthacrylate à prisme; diffuseur supérieur en méthacrylate transparent.

Spécificité

Elle utilise des sources RGB qui permettent d'obtenir d'innombrables déclinaisons de la lumière blanche dans les différentes intensités et les variétés de températures de couleur, de la plus chaude (2.500 K) à la plus froide (20.000 K). Le réglage des fonctions se fait avec une télécommande infrarouge.

Materialien

Rahmen aus Aluminium, unterer Schirm aus Metakryl in Prismaschliff, oberer Schirm aus transparentem Polycarbonat.

Spezifikation

Durch den Einsatz von RGB-Lampen lassen sich in Bezug auf die Farbtemperatur und Farbintensität verschiedenste Abstufungen des Weißlichts kreieren - von den wärmsten (2.500 K) zu den kältesten (20.000 K). Regelung der verschiedenen Funktionen über eine Infrarot-Fernbedienung.

Materiales

Estructura de aluminio; difusor inferior de metacrilato con acabado prismático; difusor superior, de policarbonato transparente.

Especificaciones

Incorpora fuentes de luz RGB de color rojo, verde y azul, a efectos de obtener una gradación infinita de la luz blanca, con toda su variedad de intensidades y un amplio abanico de temperaturas-color, desde la más cálida (2.500 K) hasta la más fría (20.000 K). Las funciones se regulan mediante mando a distancia del tipo de rayos infrarrojos.

MODULO

ELECTRO

www.modulelectro.ru

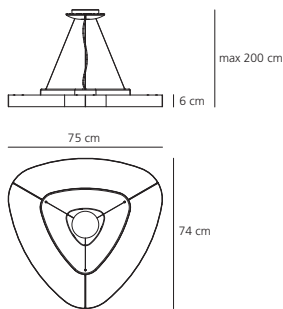

FLUO 3x3 RGB groups (tot. 9) x14W (G 5) – T 16, included. Electronic ballast

IP20     Dimmer



Infrared remote control (included)



Wall mounted control panel (to order separately)

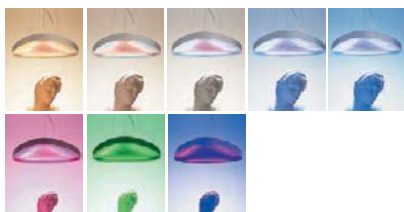



MODUL
ELECTRO

www.modulelectro.ru

Materiali: struttura in metacrilato trasparente; diffusore inferiore in metacrilato prismato; diffusore superiore in policarbonato.

Specificità: utilizza sorgenti RGB che consentono di ottenere infinite declinazioni della luce bianca, nelle sue diverse intensità e varietà delle temperature di colore, dalla più calda (2.500 K) alla più fredda (20.000 K). La regolazione delle funzioni avviene attraverso un telecomando a radiofrequenza. La struttura della lampada funge anche da superficie diffondente.

Light emission



Colour



Materials

Transparent methacrylate structure; lower prismatic methacrylate diffuser; upper diffuser in polycarbonate.

Matériaux

Structure en méthacrylate transparent ; diffuseur inférieur en méthacrylate avec finition prismatique ; diffuseur supérieur en polycarbonate transparent.

Materialien

Rahmen aus transparentem Metakrylat; unterer Schirm aus Metakryl in Prismaschliff; obere Schale aus transparentem Polycarbonat.

Materiales

Estructura de metacrilato transparente; difusor inferior de metacrilato con acabado prismático; difusor superior, de policarbonato transparente.

Specification

It uses RGB light sources, which enable a limitless variation of white light with different intensities and a variety of colour temperatures, from the warmest (2.500 K) to the coolest (20.000 K). The colour selection functions are set by a radiofrequency remote control.

Spécificité

Elle utilise des sources RGB qui permettent d'obtenir d'innombrables déclinaisons de la lumière blanche dans les différentes intensités et les variétés de températures de couleur, de la plus chaude (2.500 K) à la plus froide (20.000 K). Le réglage des fonctions se fait avec une télécommande à radiofréquence.

Spezifikation

Durch den Einsatz von RGB-Lampen lassen sich in Bezug auf die Farbtemperatur und Farbintensität verschiedenste Abstufungen des Weißlichts kreieren - von den wärmsten (2.500 K) zu den kältesten (20.000 K). Regelung der verschiedenen Funktionen über eine Radiofrequenz-Fernbedienung.

Especificaciones

Incorpora fuentes de luz RGB de color rojo, verde y azul, a efectos de obtener una gradación infinita de la luz blanca, con toda su variedad de intensidades y un amplio abanico de temperaturas-color, desde la más cálida (2.500 K) hasta la más fría (20.000 K). Las funciones se regulan mediante mando a distancia de radio frecuencia.

MODULO
ELECTRO
www.modulelectro.ru

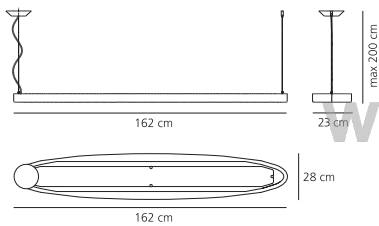

FLUO 3x80 RGB (G 5) - T 16, included. Electronic ballast

IP20     +  Dimmer



Radiofrequency remote control (included)



Wall mounted control panel (to order separately)

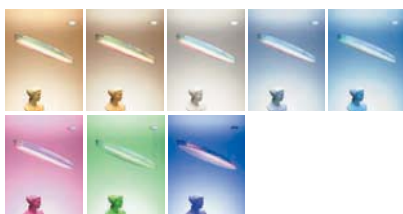

Materiali: struttura in alluminio; diffusore inferiore in metacrilato prismatico; diffusore superiore in policarbonato.

Specificità: utilizza sorgenti RGB che consentono di ottenere infinite declinazioni della luce bianca, nelle sue diverse intensità e varietà delle temperature di colore, dalla più calda (2.500 K) alla più fredda (20.000 K). La regolazione delle funzioni avviene attraverso un telecomando a radiofrequenza.

Light emission



Colour



Materials

Aluminium structure; lower prismatic methacrylate diffuser; upper diffuser in transparent polycarbonate.

Specification

It uses RGB light sources, which enable a limitless variation of white light with different intensities and a variety of colour temperatures, from the warmest (2.500 K) to the coolest (20.000 K). The colour selection functions are set by a radiofrequency remote control.

Matériaux

Structure en aluminium ; diffuseur inférieur en méthacrylate avec finition prismatique ; diffuseur supérieur en polycarbonate transparent.

Spécificité

Elle utilise des sources RGB qui permettent d'obtenir d'innombrables déclinaisons de la lumière blanche dans les différentes intensités et les variétés de températures de couleur, de la plus chaude (2.500 K) à la plus froide (20.000 K). Le réglage des fonctions se fait avec une télécommande à radiofréquence.

Materialien

Rahmen aus Aluminium, unterer Schirm aus Metakryl in Prismaschliff, obere Schale aus transparentem Polycarbonat.

Spezifikation

Durch den Einsatz von RGB-Lampen lassen sich in Bezug auf die Farbtemperatur und Farbintensität verschiedenste Abstufungen des Weißlichts kreieren - von den wärmsten (2.500 K) zu den kältesten (20.000 K). Regelung der verschiedenen Funktionen über eine Radiofrequenz-Fernbedienung.

Materiales

Estructura de aluminio; difusor, inferior de metacrilato con acabado prismático, difusor superior, de policarbonato transparente

Especificaciones

Incorpora fuentes de luz RGB de color rojo, verde y azul, a efectos de obtener una gradación infinita de la luz blanca, con toda su variedad de intensidades y un amplio abanico de temperaturas-color, desde la más cálida (2.500 K) hasta la más fría (20.000 K). Las funciones se regulan mediante mando a distancia de radio frecuencia.

MODULO

ELECTRO

www.modulelectro.ru

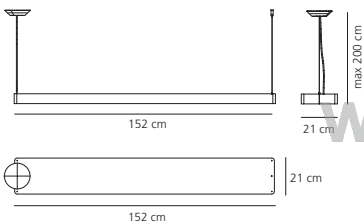

FLUO 3x80 RGB (G 5) - T 16, included. Electronic ballast

IP20 + - Dimmer



Radiofrequency remote control (included)



Wall mounted control panel (to order separately)

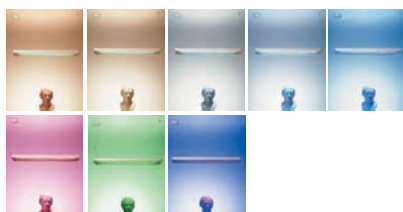

Tolomeo sospensione due bracci alluminio

design

Michele De Lucchi
Giancarlo Fassina
1996

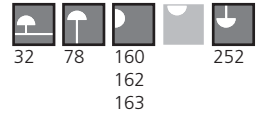

Materiali: struttura a bracci mobili in alluminio lucidato; diffusore in alluminio anodizzato opaco; snodi in alluminio brillantato.

Specificità: tige rigida adattabile in funzione dell'altezza del soffitto. Sistema di equilibratura a molle.

Light emission



Colours



Rod and diffusers:
metal grey



Arms:
mirror

Materials

Cantilevered arms in polished aluminium; diffuser in matt anodised aluminium; joints in polished aluminium.

Matériaux

Structure à bras articulés en aluminium poli ; diffuseur en aluminium anodisé opaque, rotules en aluminium brillant.

Materialien

Ausrichtbare Arme aus glänzendem Aluminium; Kopf aus matt-eloxiertem Aluminium; Gelenke aus poliertem Aluminium.

Materiales

Estructura con brazos móviles de aluminio pulido; difusor en aluminio anodizado opaco; articulaciones de aluminio pulido.

Specification

Rigid rod adjustable for different ceiling heights. System of spring balancing.

Spécificité

Tige rigide, adaptable aux différentes hauteurs de plafond. Système d'équilibrage à ressorts.

Spezifikation

Höhenverstellbarer Stab. Mit Federausgleichsystem.

Especificaciones

La varilla rígida se regula con arreglo a la altura del techo. Sistema de equilibrado a muelles.

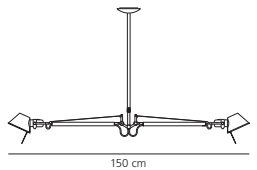

HALO max 2x70W (E27) - ES

IP20

MODUL
ELECTRO
www.modulelectro.ru



Tolomeo sospensione due bracci pergamena

design

Michele De Lucchi
Giancarlo Fassina
2005



Materiali: struttura a bracci mobili in alluminio lucidato; diffusori in carta pergamena o in raso di seta supportato da materiale plastico; snodi in alluminio brillantato.

Specificità: i diffusori nel normale utilizzo si dispongono verticalmente, indipendentemente dall'angolazione del braccio. Tige rigida adattabile in funzione dell'altezza del soffitto. Sistema di equilibratura a molle.

Light emission



Colours



Materials

Cantilevered arms in polished aluminium; diffuser in parchment paper or in silk satin fabric on a plastic frame, joints in polished aluminium.

Specification

The diffusers, available in four sizes, normally used, remains vertical regardless of the angle of the arm. Rigid rod adjustable for different ceiling heights. System of spring balancing.

Matériaux

Structure à bras articulés en aluminium poli ; diffuseur en papier parchemin ou en polycarbonate recouvert de satin de soie; articulations en aluminium brillant.

Spécificité

Les diffuseurs, disponibles en quatre tailles, dans le cadre d'une utilisation normale, se placent verticalement, indépendamment de la position du bras. Tige rigide, adaptable aux différentes hauteurs de plafond. Système d'équilibrage à ressorts.

Materialien

Ausrichtbare Arme aus glänzendem Aluminium; Schirm aus mit Kunststoff stabilisiertem Pergamentpapier oder Seidensatin; Gelenke aus poliertem Aluminium.

Spezifikation

Bei normaler Anwendung befinden sich die Schirme (erhältlich in vier Größen) in einer vertikalen Position, unabhängig von der Ausrichtung des Armes. Höhenverstellbarer Stab. Federausgleichssystem.

Materiales

Estructura con brazos móviles de aluminio pulido; difusor en pergamino o en raso seda reforzado con plástico; articulaciones de aluminio pulido.

Especificaciones

Los difusores, disponibles en cuatro tamaños, en su uso normal, se disponen verticalmente, independientemente de la angulación del brazo. La varilla rígida se regula con arreglo a la altura del techo. Sistema de equilibrado a muelles.

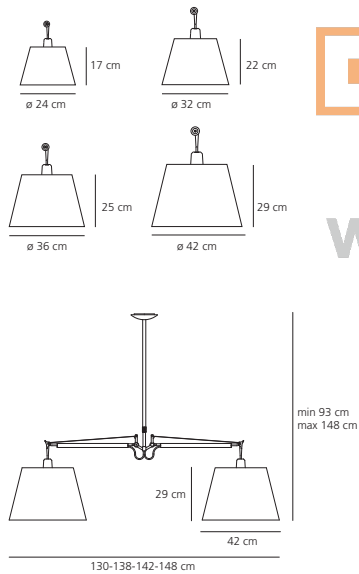

HALO max 2x150W (E 27) - ECO



Tolomeo sospensione decentrata

design
Michele De Lucchi
Giancarlo Fassina
1996

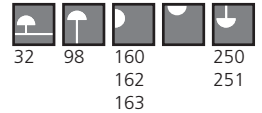

Awards

iF Product Design Award
2001 – Hannover (Deutschland)
Focus Mobilität Internationaler Designpreis –
Baden Württemberg
2001 – Stuttgart (Deutschland)

Light emission



Colours



Materiali: struttura a bracci mobili in alluminio lucidato; snodi in alluminio brillantato; diffusori in alluminio opaco o carta pergamena o seta di raso o anello in acciaio inox.

Specificità: disponibile con diffusori di diverse forme, dimensioni e materiali. Sistema di equilibratura a molle.

Materials

Cantilevered arms in polished aluminium; joints in polished aluminium; diffuser in matt aluminium or in parchment paper or silk satin fabric or stainless steel ring.

Specification

Available with different shapes, sizes and materials diffusers. System of spring balancing.

Matériaux

Structure à bras articulés en aluminium poli ; articulations en aluminium brillant ; diffuseur en aluminium opaque en papier parchemin, ou en satin de soie ou avec anneau en acier inoxydable.

Spécificité

Disponible avec diffuseurs de formes, de tailles et de matériaux différents. Système d'équilibrage à ressorts.

Materialien

Ausrichtbare Arme aus glänzendem Aluminium; Gelenke aus poliertem Aluminium; Schirm aus mattem Aluminium, oder aus Pergamentpapier, Seidensatin oder Ring aus Innoxstahl.

Spezifikation

Erhältlich mit verschiedenen Schirmen in unterschiedlichen Größen und aus verschiedenen Materialien.

Materiales

Estructura con brazos móviles de aluminio pulido; articulaciones de aluminio pulido; difusores de aluminio opaco, en pergamino o en raso seda o bien, anillo de acero inoxidable.

Especificaciones

Está disponible con difusores de formas, tamaños y materiales diferentes. Sistema de equilibrado a muelles.

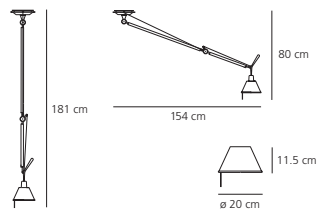
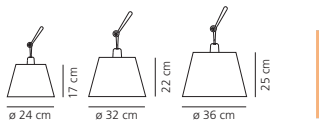

Aluminium diffuser

HALO max 1x70W (E27) – ES

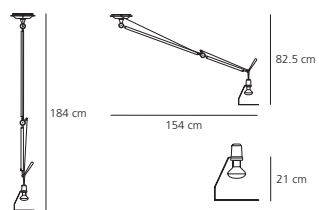

Ring diffuser

INC max 1x100W (E27) – R 80 reflector

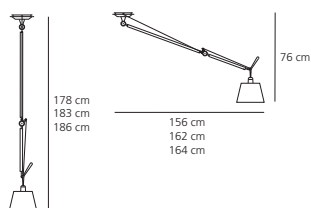

Parchment paper/silk satin fabric diffuser

Diffuser ø 24 cm
HALO max 1x70W (E 27) – ES
Diffuser ø 32, 36
HALO max 1x150W (E 27) – ECO





MODUL
ELECTRO
www.modulelectro.ru

Tolomeo Mega sospensione 42
Tolomeo Mega sospensione 52

design
 Michele De Lucchi
 Giancarlo Fassina
 2007



Materiali: struttura in alluminio e metacrilato trasparente stampato ad iniezione; diffusore in carta pergamena o in raso di seta supportato da materiale plastico.

Light emission



Colours

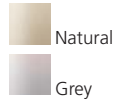

Materials

Aluminium and transparent injection-moulded methacrylate structure; diffuser in parchment paper or in silk satin fabric on a plastic frame.

Matériaux

Structure en aluminium et en méthacrylate transparent ; diffuseur en papier parchemin ou en polycarbonate recouvert de satin de soie.

Materialien

Struktur aus Aluminium und transparentem Metakryl-Spritzguss; Schirm aus mit Kunststoff stabilisiertem Pergamentpapier oder Seidensatin.

Materiales

Estructura en aluminio y metacrilato transparente moldeado por inyección; difusor en pergamino o en raso seda reforzado con plástico.

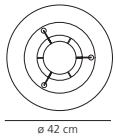
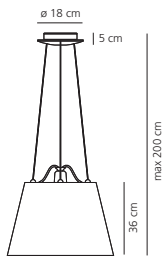

Tolomeo Mega sospensione 42
 HALO max 1x105W (E 27) – ES

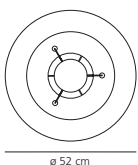
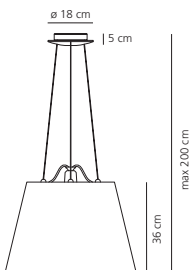

Tolomeo Mega sospensione 52
 HALO max 1x105W (E 27) – ES

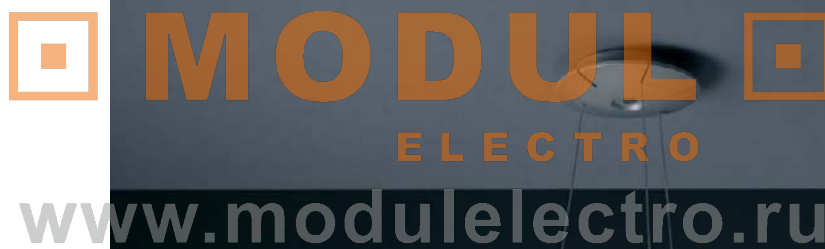



MODUL

ELECTRO

www.modulelectro.ru

Choose sospensione
Choose Mega sospensione

design
Matteo Thun
2008



Materiali: diffusore in materiale termoformato accoppiato a un foglio di polipropilene serigrafato rosso o da carta pergamena.

Light emission



Colours



Transparent+red



Transparent+natural

Materials

Diffuser in thermoformed material joined with red silk-screened polypropylene sheet or parchment paper.

Matériaux

Diffuseur en matériau thermoformé couplé à une feuille de polypropylène sérigraphié rouge ou avec papier parchemin.

Materialien

Verstellbarer Schirm aus thermogeformtem Polypropylen entweder rot oder mit Pergamentpapier zusammengestellt.

Materiales

Difusor orientable de material termoconformado junto con tejido de polipropileno rojo serigrafado o con tela de pergamino.

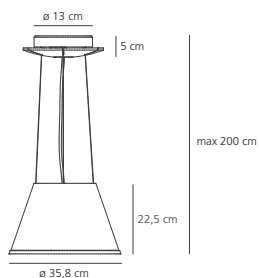

Choose sospensione

HALO max 1x70W (E 27) – ES

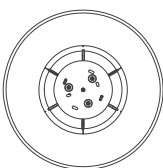
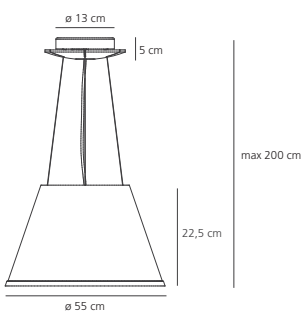

Choose Mega sospensione

HALO max 3x70W (E 27) – ES



FLUO 3x18W (GX 24 q-2) – TC-TEL, included
Electronic ballast



MODUL
ELECTRO
www.modulelectro.ru



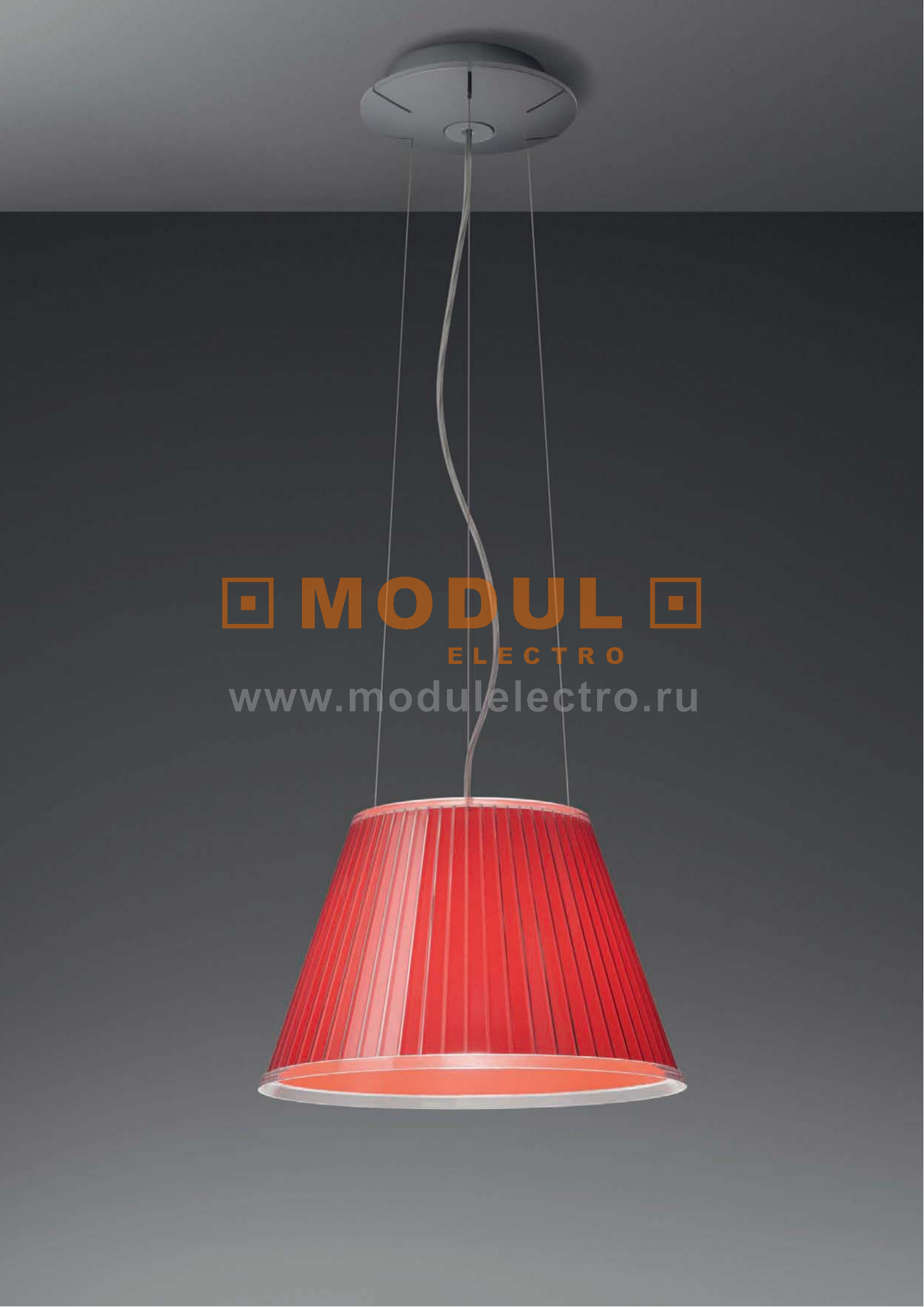

MODUL
ELECTRO
www.modulelectro.ru

Pipe sospensione

design

Herzog & de Meuron
2002



Awards

Compasso d'Oro / A.D.I.
2004 – Milano (Italia)
Intel Design 2003
Categoria Design "Augusto Morello"
Selezione alla III edizione 2003 – Milano (Italia)
Design Plus, light + building
2004 – Frankfurt am Main (Deutschland)

Museums

Design Collection of the Museum
of Modern Art – New York (USA)

Materiali: struttura in acciaio flessibile verniciato rivestita da una guaina in silicone platinico naturale (anti ingiallimento); rosone e diffusore in policarbonato trasparente verniciato effetto gomma; riflettore in alluminio speculare con microforature irregolari; fondello in acciaio verniciato.

Specificità: flessibile ed orientabile, Pipe monta un riflettore con microforature a diverse distanze dal diffusore che, oltre a migliorare la qualità dell'illuminazione dell'ambiente, arricchisce il design dell'oggetto che appare costellato di punti di luce di dimensioni variabili.

Light emission



Colour



Transparent satin

Materials

Flexible painted steel structure, covered with a natural anti-yellowing silicone case; ceiling rose and diffuser in transparent rubber-effect painted polycarbonate; mirror aluminium reflector with random perforations; painted steel bottom plate.

Matériaux

Structure en acier flexible peint, revêtu d'une gaine en silicone naturelle (anti-jaunissement). Rosace et diffuseur en polycarbonate transparent peint effet caoutchouc. Réflecteur en aluminium spéculaire microperforé. Fond en acier peint.

Materialien

Rahmen aus lackiertem Stahl mit transparentem Silikonüberzug (gegen Vergilbung); Rosette und Lichtverteiler aus transparentem Polycarbonat mit Soft-Touch-Lackierung; Reflektor aus hochglanzlackiertem Aluminium mit unregelmäßig angeordneten Mikrobohrungen.

Materiales

Estructura en acero flexible pintado, revestida con una camisa de silicona platinica natural (antioxidante); rosetón y difusor en policarbonato transparente pintado, efecto caucho. Reflector en aluminio especular, con microorificios irregulares. Fondo en acero pintado.

Specification

Flexible and adjustable, Pipe has a micro-perforated reflector that improves the quality of the lighting in the environment, as well as it enriches the design of the luminaire, which looks like it is studded with points of light of varied dimensions.

Spécificité

Flexible et orientable, Pipe est équipée d'un réflecteur microperforé qui, non content d'améliorer la qualité d'éclairage de l'espace, enrichit également le design de l'objet qui apparaît ainsi constellé de points de lumière aux dimensions variables.

Spezifikation

Eine vielseitige, beliebig verstellbare Leuchte. Der Reflektor sowie zusätzliche feine Bohrungen, die in unterschiedlichen Abständen zum Lichtverteiler angebracht sind, gewähren eine optimale Raumausleuchtung und schaffen durch den entstehenden Lichthof mit Lichtpunkten ein attraktives Bild.

Especificaciones

Pipe es flexible y orientable e incorpora un reflector con micro-orificios, que están ubicados a una distancia variable del difusor. Este detalle mejora la calidad de la iluminación en el espacio y realza la belleza del diseño del objeto, dando lugar a una constelación de puntos luminosos, de distintos tamaños.

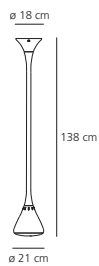

FLUO 1x32W (GX 24 q-3) – TC-TEL, included
Electronic ballast





MODUL
ELECTRO

www.modulelectro.ru

Mouette simmetrica Mouette asimmetrica

design

Wilmotte & Associés
2004



Awards

Design Innovationen – Design Zentrum Nordrhein Westfalen
Reddot Design Award 2005
"Reddot: best of the best"
Essen (Deutschland)

Materiali: struttura in estruso di alluminio verniciato, diffusore in polipropilene stampato in tecnica rotazionale, cavetti in acciaio.

Specificità: disponibile nelle versioni dimmerabile e non dimmerabile.

Light emission



Colour



white

Materials

Extruded aluminium structure; rotational moulded polypropylene diffuser; steel suspension wires.

Matériaux

Structure en aluminium extrudé ; diffuseur en polypropylène moulé ; câbles de suspension en acier.

Materialien

Montageprofil aus fließgepresstem Aluminium; Schirm aus Polypropylen im Rotationsstritzguss-Verfahren hergestellt; Stahlseile

Materiales

Estructura en estruso de aluminio; difusor en polipropileno estampado con técnica rotacional; cables de suspensión en acero.

Specification

Available in the versions dimmable and non dimmable.

Spécificité

Disponible en version dimmable ou non dimmable.

Spezifikation

Wahlweise mit nicht dimmbarem EVG oder dimmbarem DSI EVG.

Especificaciones

Está disponible en dos versiones dimerable y no dimerable.

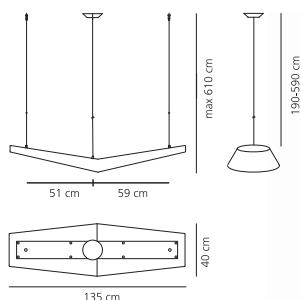

Mouette simmetrica

FLUO 4x24W (G 5) – T 16, included
Electronic ballast

IP20 IP40

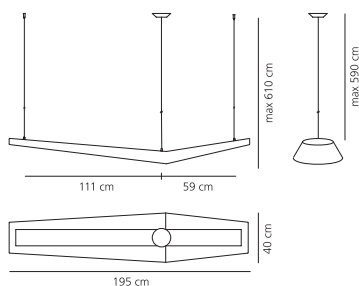
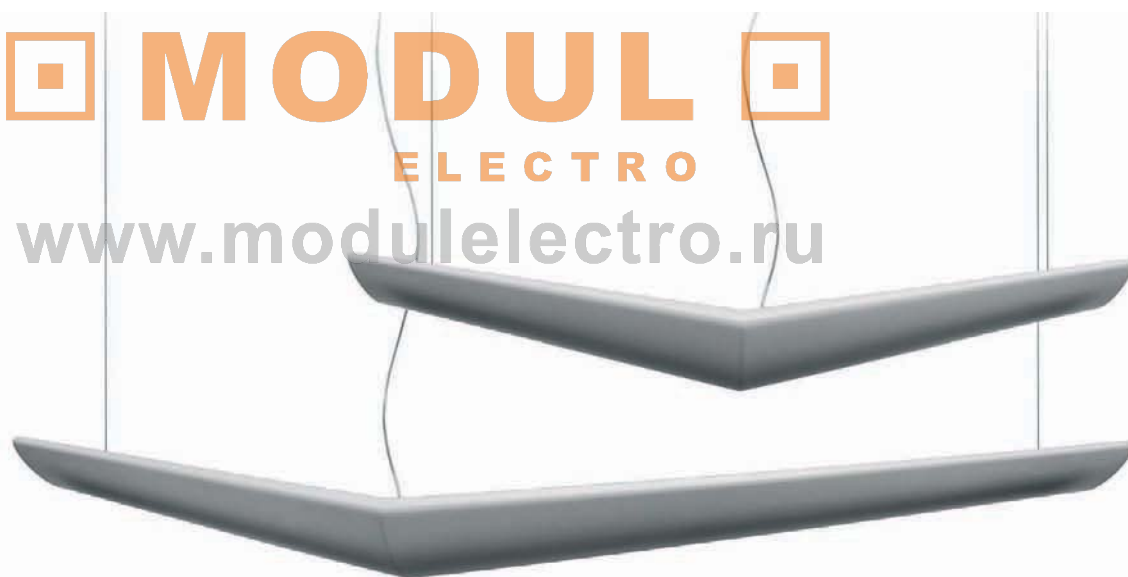

Mouette asimmetrica

FLUO 2x24W (G 5) – T 16
FLUO 2x54W (G 5) – T 16, included
Electronic ballast

IP20 IP40





MODULE
ELECTRO
www.modulelectro.ru







Materiali: lastre di PMMA trasparente sovrapposte forate con pattern "frattale".
Specificità: la lastra inferiore è la superficie di supporto dei Led, montati su un meccanismo sferico, che permette all'utente di utilizzare la stessa sorgente in maniera diretta o indiretta, semplicemente ruotandola. La lastra superiore, disponibile incolore, verde o fumé, viene intercettata dal flusso dei Led che emettono luce indiretta e proiettano il frattale sul soffitto. I Led sono orientabili e dotati di ottiche che permettono un controllo mirato del flusso.

Light emission



Colours

-  Lower sheet: transparent
-  Upper sheet: transparent
-  Upper sheet: transparent green
-  Upper sheet: transparent fumé

Materials

Transparent, overlapped PMMA sheets, perforated according to a "fractal" pattern.

Specification

The lower sheet is the surface supporting the Leds, mounted on a spherical mechanism, which allows the user to use the same source in a direct or indirect manner, by simply rotating it. The upper sheet, available uncoloured, green or fumé, is struck by the Led flow, emitting indirect light and projecting the fractal on the ceiling. The Leds are adjustable and fitted with lenses that allow focused light flow control.

Matériaux

Plaques de PMMA transparent superposées et trouées d'une forme "fractale".

Spécificité

La plaque inférieure est la surface de support des Leds, montées sur un mécanisme à rotule, qui permet à l'utilisateur d'employer la même source de façon directe ou indirecte simplement en la tournant. La plaque supérieure, disponible incolore, verte ou fumé, accroche par le flux des Leds qui émettent une lumière indirecte et projettent le fractale vers le plafond. Les Leds sont orientables et dotés d'optiques qui permettent un contrôle maîtrisé du flux. "Ground control" tactile disponible comme accessoire.

Materialien

Leuchtenkörper aus zwei übereinander liegenden, transparenten PMMA-Platten in gelochtem "Fractal"-Muster.

Spezifikation

Die untere Platte ist Trägerfläche der Leds, die in einem Kugel-Mechanismus aufmontiert sind, das dem Benutzer erlaubt, durch einfaches Drehen, die selbe Lichtquelle auf direkte oder indirekte Art zu benutzen. Die obere Platte, die farblos, grün oder fumé erhältlich ist, wird durch den Strahl der Led abgefangen, die indirektes Licht ausstoßen und wirft das Fractal an die Decke. Die Leds sind ausrichtbar und mit einer Optik ausgestattet.

Materiales

Láminas de PMMA transparente superpuestas perforadas con pattern "fractal".

Especificaciones

La lámina inferior es la superficie de soporte de los Leds, montados en un mecanismo esférico, que permite al usuario el empleo de la misma fuente de modo directo o indirecto, simplemente girándola. La lámina superior, disponible en colores, con matiz verde o fumé, es interceptada por el flujo luminoso de los Leds de luz indirecta, proyectando el fractal en el techo. Los Leds son orientables y están dotados de ópticas que permiten un control dirigido del flujo.

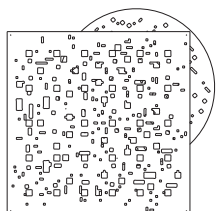
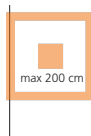
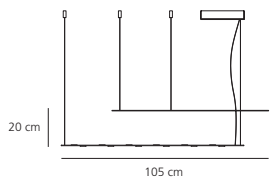

30 LED max 60W, included



Only for special projects – which feasibility must be approved by Artemide technical design department – it's possible to create different shapes and dimensions of Fractals sheets.

www.modulelectro.ru



Transparent green sheet



Transparent sheet



MODUL
ELECTRO

www.modulelectro.ru

Aggregato sospensione
Aggregato sosp. saliscendi
Aggregato sosp. decentrato

design
 Enzo Mari
 Giancarlo Fassina
 1976, 1995



Awards
 BIO 7 – Honourable Mention
 1977 – Ljubljana (Slovenia)

Museums
 Museo Permanente del Design Italiano
 1945/1990 – Triennale di Milano
 Milano (Italia)

Materiali: rosone in resina termoplastica e metallo verniciati; contrappeso in resina termoplastica trasparente; diffusori conici in metacrilato o metallo; diffusori sferici in metacrilato.

Specificità: lampada con diffusori intercambiabili. Disponibile con cavo fisso o saliscendi con contrappeso.

Light emission



cone

Colours



Polished white



Dark metal grey
 (cone only)

Materials

Ceiling rose in thermoplastic resin and metal, painted; counterweight in thermoplastic transparent resin; cone-shaped diffuser in methacrylate or in metal; sphere-shaped diffuser in methacrylate.

Specification

Lamp with interchangeable diffusers. Available with fixed cable or rise and fall counterweight.

Matériaux

Rosace en résine thermoplastique et métal verni ; contrepoids en résine thermoplastique transparente; diffuseurs coniques en méthacrylate ou en métal ; diffuseurs sphériques en méthacrylate.

Spécificité

Suspension avec diffuseurs interchangeables. Disponible avec câble fixe ou avec monte et baisse avec contrepoids.

Materialien

Baldachin aus Kunstharz und Metall, lackiert; Gegengewicht aus transparentem Kunstharz; kegelförmiger Schirm aus Metakrylat oder aus Metall; kugelförmiger Schirm aus Metakrylat.

Spezifikation

Die Schirme der Pendelleuchte sind austauschbar. Auf Wunsch mit höhenverstellbarem Kabel erhältlich.

Materiales

Rosetón, de resina termoplástica y metal pintados; contrapeso de resina termoplástica transparente; difusores cónicos de metacrilato o metal; difusores esféricos de metacrilato.

Especificaciones

Lámpara con difusores intercambiables. Está disponible con cable fijo o de sube y baja, con contrapeso.

MODULO

ELECTRO

www.modulelectro.ru

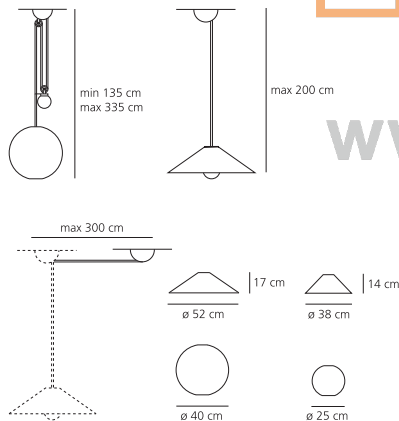

HALO max 1x70W (E 27) – ES



Aggregato sospensione only



Aggregato sospensione decentrato



Aggregato sospensione

Aggregato sospensione saliscendi

Talak sospensione

design

Neil Poulton
2005



Awards

Prix "Observateur du Design" 2005
Etoile 2005 – A.P.C.I. – Paris (France)

Design Innovationen – Design
Zentrum Nordrhein Westfalen
Reddot Design Award – Best of the best 2006 –
Essen (Deutschland)

Materiale: rosone in materiale termoplastico; corpo lampada in resina termoplastica verniciata.

Specificità: l'alimentatore della sorgente fluorescente miniaturizzata è alloggiato nel corpo lampada. I cavetti di sospensione svolgono anche funzione di alimentazione.

Light emission



Colour



White

Materials

Ceiling rose in thermoplastic material; body lamp in painted thermoplastic resin.

Specification

The body lamp houses the miniaturised fluorescent light source and electronic ballast. The suspension cables are also feed cables.

Matériaux

Rosace en matériau thermoplastique ; corps en résine thermoplastique vernie.

Spécificité

Le corps de la lampe contient le ballast électronique pour la source fluorescente miniaturisée. Les câbles de suspension servent également de câbles d'alimentation.

Materialien

Leuchtenkörper und Rosette aus thermoplastischem Kunstharz.

Spezifikation

Das Vorschaltgerät für die miniaturisierte Leuchtstofflampe befindet sich im Leuchtenkörper. Die Kabel dienen gleichzeitig der Aufhängung und Stromversorgung.

Materiales

Rosetón en material termoplástico; cuerpo lámpara, en resina termoplástica pintada.

Especificaciones

El cuerpo lámpara, aloja el alimentador electrónico para la bombilla fluorescente miniaturizada. Los cables desarrollan también la función de alimentación.

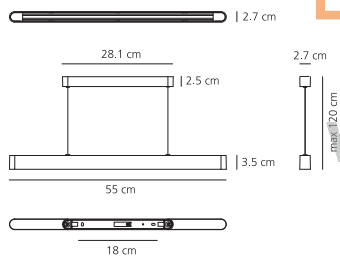

FLUO 1x13W (W 4,3x8,5d) – T2, included
Electronic ballast



MODULO
ELECTRO
www.modulelectro.ru



Edge suspension 30

design

Alessandro Mendini
2004



Materiali: rosone in resina termoplastica; diffusore in materiale termoplastico.

Light emission



Colour



White

Materials

Ceiling rose in thermoplastic resin; diffuser in thermoplastic material.

Matériaux

Rosace en résine thermoplastique ; diffuseur en matériau thermoplastique.

Materialien

Rosette aus Kunstharz; Schirm aus thermoplastischem Material.

Materiales

Rosetón, de resina termoplástica; difusor en material termoplástico.

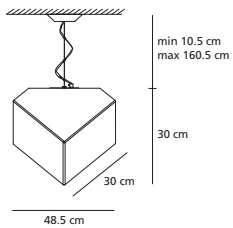

FLUO 1x23W (E 27) – TC-TSE

IP20   

 **MODULO** 
ELECTRO

www.modulelectro.ru



Castore calice sospensione 18
Castore calice sospensione 42

design
Michele De Lucchi
Huub Ubbens
2004



55

Materiali: rosone e stelo in resina termoplastica; diffusore in vetro soffiato.
Specificità: il diffusore della versione 42 è chiuso inferiormente.

Light emission



Colour



White

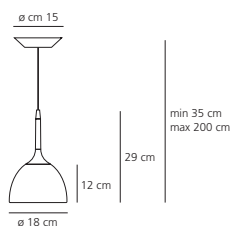

Castore calice sospensione 18
HALO max 1x48W (G 9) – ES, included

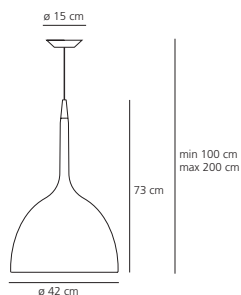

Castore calice sospensione 42
HALO max 1x205W (E 27) – ECO
or
FLUO 1x23W (E 27) – TC-TSE



Materials

Ceiling rose and stem in thermoplastic resin; blown glass diffuser.

Specification

The diffuser of Castore Calice 42 is closed in the lower part.

Matériaux

Base en zamac, tige en résine thermoplastique ; diffuseur en verre soufflé.

Spécificité

Le diffuseur de la version 42 est fermé dans la partie inférieure.

Materialien

Deckenrosette und Stab aus thermoplastischem Harz; Schirm aus mundgeblasenem Glas.

Spezifikation

Der Schirm der Ausführung Castore Calice 42 ist unten geschlossen.

Materiales

Florón y varilla en resina termoplástica, difusor en cristal soplado.

Especificaciones

El difusor de la versión 42 viene con la parte inferior cerrada.

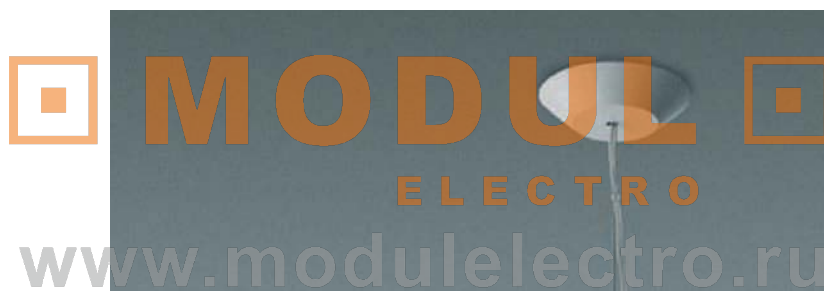

Castore calice sospensione 18



Castore calice sospensione 42

Castore sospensione 14
Castore sospensione 25
Castore sospensione 35
Castore sospensione 42

design
 Michele De Lucchi
 Huub Ubbens
 2003



Awards

Design Plus, light + building
 2004 – Frankfurt am Main (Deutschland)
 Design Innovationen – Design
 Zentrum Nordrhein Westfalen
 Reddot Design Award
 2004 – Essen (Deutschland)
 Compasso d'Oro / A.D.I. – Segnalazione
 2004 – Milano (Italia)

Materiali: rosone e stelo in resina termoplastica; diffusore in vetro soffiato.

Light emission



Colour



White

Materials

Ceiling rose and stem
 in thermoplastic resin; blown
 glass diffuser.

Matériaux

Tige et rosace en résine
 thermoplastique ; diffuseur
 en verre soufflé.

Materialien

Deckenrosette und Stab aus
 thermoplastischem Harz;
 Schirm aus mundgeblasenem
 Glas.

Materiales

Florón y cuerpo en resina
 termoplástica; difusor en
 cristal soplado.

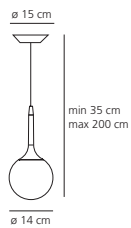

Castore sospensione 14

HALO max 1x48W (G 9) – ES, included

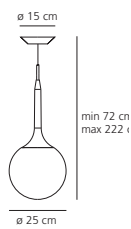

Castore sospensione 25

HALO max 1x100W (E 27) – ECO

or
 FLUO 1x15W (E 27) – TC-TSE

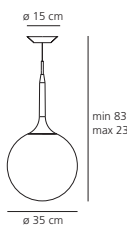

Castore sospensione 35

HALO max 1x150W (E 27) – ECO

or
 FLUO 1x23W (E 27) – TC-TSE

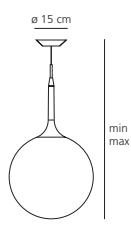

Castore sospensione 42

HALO max 1x150W (E 27) – ECO

or
 FLUO 1x23W (E 27) – TC-TSE



Castore sosp. 42

Castore sosp. 25

Castore sosp. 14

Castore sosp. 35



MODUL

ELECTRO

www.modulelectro.ru



Soffione sospensione 36
Soffione sospensione 45

design
 Michele De Lucchi
 Alberto Nason
 2008



Materiali: rosone in resina termoplastica, diffusore in vetro soffiato opalino.

Light emission



Colour



White

Materials

Ceiling rose in thermoplastic resin, opaline blown glass diffuser.

Matériaux

Rosace en résine thermoplastique, diffuseur en verre soufflé opalin.

Materialien

Rosette aus thermoplastischem Harz; Schirm aus geblasenem Opalglas.

Materiales

Florón en resina termoplástica, difusor de cristal soplado opalino.

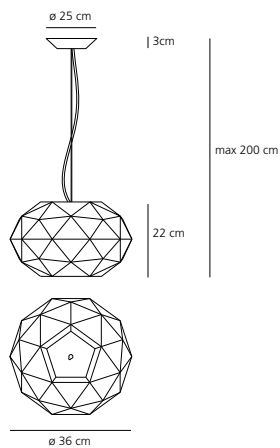

Soffione sospensione 36

HALO max 1x150W (E 27) - ECO
 or
 FLUO max 1x15W (E 27) - TC-DEL



FLUO 1x26/32W (GX 24 q-3) - TC-DEL
 Electronic ballast

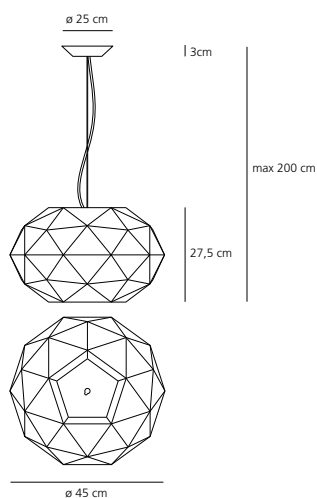

Soffione sospensione 45

HALO max 1x205W (E 27) - ECO
 or
 FLUO max 1x23W (E 27) - TC-DEL



FLUO 1x42W (GX 24 q-3) - TC-DEL
 Electronic ballast



MODUL
ELECTRO
www.modulelectro.ru





 **MODUL** 
ELECTRO

www.modulelectro.ru

Noto

design
Michele De Lucchi
2008



Materiali: struttura in acciaio; diffusore in vetro soffiato opalino.
Specificità: è possibile applicare un filtro rosso all'elemento più piccolo del diffusore.

Light emission



Colour



White

Materials

Steel structure; opal blown glass diffuser.

Matériaux

Structure en acier; diffuseur en verre soufflé opalin.

Materialien

Struktur aus Stahl, Lichtverteiler aus mundeblasenem Opalglas.

Materiales

Estructura en acero; difusor en cristal soplado opalino.

Specification

Possibility to apply a red filter to the smallest diffuser element.

Spécificité

Possibilité d'appliquer un filtre rouge sur le plus petit diffuseur.

Spezifikation

Wahlweise Anbringung eines roten Filters am kleinsten Schirmelement möglich.

Características técnicas

Posibilidad de aplicar un filtro rojo al elemento más pequeño del difusor.

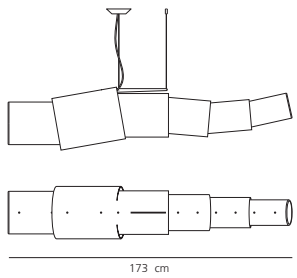

FLUO 2x80W (G 5) - T 16, included
Electronic ballast

IP20 Dimmer





 **MODUL** 
ELECTRO

www.modulelectro.ru

Logico sospensione
Logico sospensione mini
Logico sospensione micro
Logico sospensione nano

design

Michele De Lucchi
Gerhard Reichert
2001, 2002, 2003, 2006

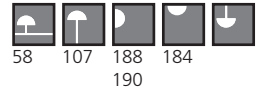

Awards

Logico sospensione
Design Innovationen – Design
Zentrum Nordrhein Westfalen
Reddot Design Award
2002 – Essen (Deutschland)
Logico sospensione micro
Design Plus, light + building
2004 – Frankfurt am Main (Deutschland)

Light emission



Colour



White

Materiali: struttura in metallo verniciato; diffusore in vetro soffiato con finitura seta lucida.

Specificità: disponibile in quattro dimensioni e in quattro configurazioni: singola, in linea, 3x120° e 4x90°. La forma modulare si presta alla componibilità e alla realizzazione di combinazioni personalizzate, fornite come progetto speciale. Logico nano track è disponibile con adattatore a binario.

Materials

Painted metal structure,
blown glass diffuser with
polished-silk finish.

Specification

Available in four sizes and in four configurations: single, on line, 3x120° and 4x90°. Its modular shape lends itself to the creation and realisation of customized compositions, supplied as special project. Logico nano track is available with track adapter.

Matériaux

Structure en métal verni ;
diffuseur en verre soufflé,
finition soie brillante.

Spécificité

Disponible en quatre tailles et en quatre configurations : simple, en ligne, 3x120° et 4x90°. Sa forme modulaire, permet de nombreuses combinaisons capables de produire autant de compositions personnalisées, produit spécial à définir pour tout projet. Logico nano track est disponible avec adaptateur pour rail.

Materialien

Rahmen aus lackiertem Metall;
Schirm aus geblasenem Glas
in seidig glänzendem Finish.

Spezifikation



Erhältlich in vier Größen und in vier Ausführungen: Einzel, in Linie, 3x120° und 4x90°. Eine individuelle Anordnung der Leuchtenmodule ist auf Wunsch als Sonderleuchte möglich. Die Ausführung Logico nano track ist mit einem Adapter für 3-Phasen-Stromschienen erhältlich.

Materiales

Estructura de metal pintado;
difusor de cristal soplado con
acabado de seda brillante.

Características técnicas

Disponible, en cuatro tamaños y en cuatro configuraciones: individual, en línea, 3x120° y 4x90°. Su forma modular, se presta para realizar combinaciones personalizadas, entrega como proyecto especial. Logico nano track está disponible con adaptador para carril eléctrico.

 **MODULO** 
ELECTRO
www.modulelectro.ru



Logico sospensione



Logico sospensione mini



Logico sospensione micro



Logico sospensione nano



MODUL
ELECTRO

www.modulelectro.ru

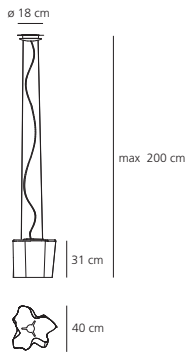

Logico sospensione

HALO max 1x150W (E 27) – ECO
or
FLUO 1x20W (E 27) – TC-TSE

IP20

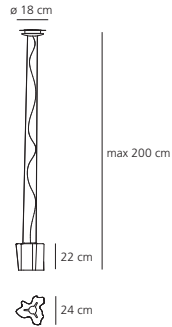

Logico sospensione mini

HALO max 1x70W (E 27) – ES

IP20

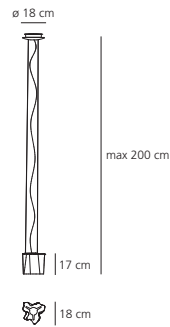

Logico sospensione micro

INC max 1x60W (E 14) – D 45

IP20

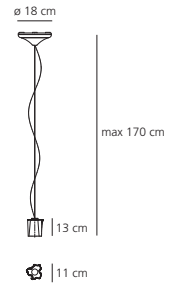

Logico sospensione nano

INC max 1x60W (E 14) – D 45

IP20

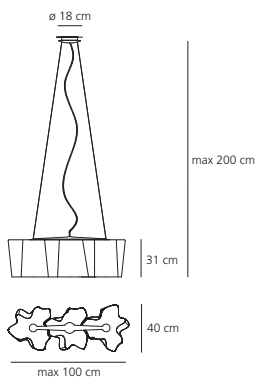

Logico sospensione 3 in linea

HALO max 3x150W (E 27) – ECO
or
FLUO 3x23W (E 27) – TC-TSE

IP20

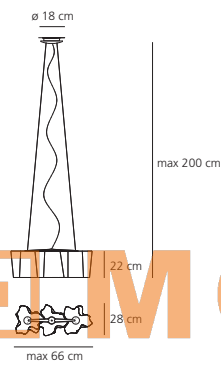

Logico sospensione mini 3 in linea

HALO max 3x70W (E 27) – ES

IP20

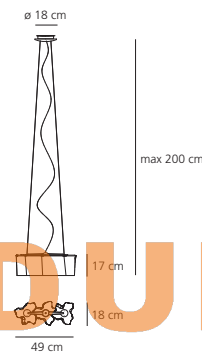

Logico sospensione micro 3 in linea

INC max 3x60W (E 14) – D 45

IP20

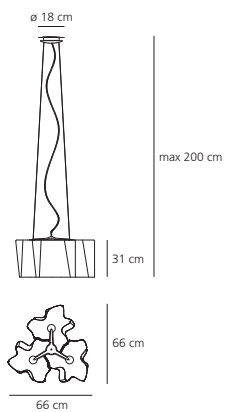

Logico sospensione 3x120°

HALO max 3x150W (E 27) – ECO
or
FLUO 3x23W (E 27) – TC-TSE

IP20

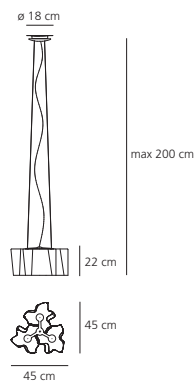

Logico sospensione mini 3x120°

HALO max 3x70W (E 27) – ES

IP20

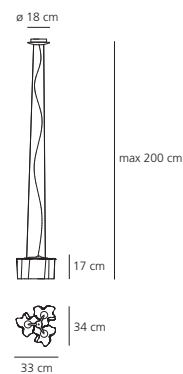

Logico sospensione micro 3x120°

INC max 3x60W (E 14) – D 45

IP20



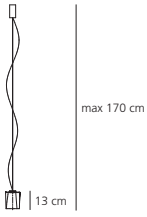

11 cm

Logico sospensione nano track
INC max 1x60W (E 14) – D 45



Track

Only for special projects – which feasibility must be approved by Artemide technical design department – it's possible to create different combinations by joining the elements Logico sospensione.

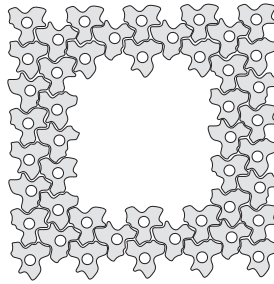

Logico sospensione nano track

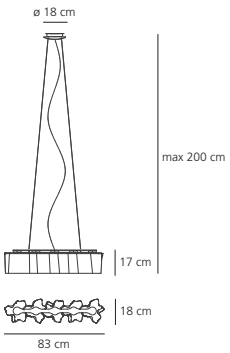

Logico sospensione micro 5 in linea
INC max 5x60W (E 14) – D 45

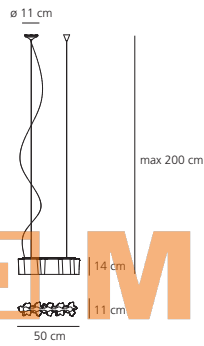

Logico sospensione nano 5 in linea
INC max 5x60W (E 14) – D 45



MODUL
ELECTRO
www.modulselectro.ru



Logico sospensione nano 5 in linea

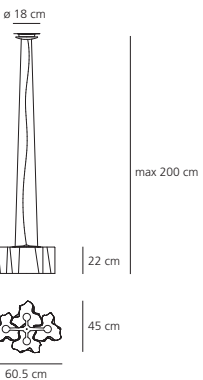

Logico sospensione mini 4x90°
HALO max 4x70W (E 27) – ES

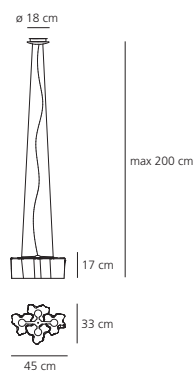

Logico sospensione micro 4x90°
INC max 4x60W (E 14) – D 45

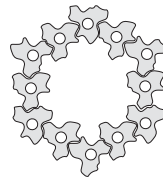

Logico sospensione 3x120°



Logico sospensione mini 4x90°

Miconos sospensione

design

Ernesto Gismondi
1998



Awards

BIO 16 – Selection
1998 – Ljubljana (Slovenia)

Materiali: tige in metallo cromato lucido; diffusore in vetro soffiato trasparente.
Specificità: tige adattabile alle diverse altezze dei soffitti.

Light emission



Colours



Rod:
mirror



Diffuser:
transparent

Materials

Metal rode, diffuser in transparent blown glass.

Matériaux

Tige en métal chromé brillant ; diffuseur en verre soufflé transparent.

Materialien

Gestell aus verchromtem und poliertem Metall, Schirm aus klarem, mundgeblasenem Glas.

Materiales

Varilla, de metal cromado brillante; difusor en cristal soplado transparente.

Specification

Adjustable rod for different ceiling heights;

Spécificité

Tige adaptable aux différentes hauteurs de plafond.

Spezifikation

Das Kabel ist für unterschiedliche Deckenhöhen justierbar.

Especificaciones

Varilla se regula con arreglo a la altura del techo.

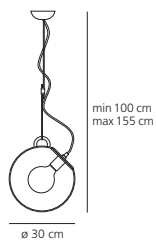

FLUO max 1x23W (E 27) – globe ø cm 12

IP20

MODULO
ELECTRO
www.modulelectro.ru



Zsu-Zsu sospensione 55
Zsu-Zsu sospensione 65

design
 Örne Halloween
 1994



Materiali: struttura in metallo verniciato e resina termoplastica; diffusore in lastra di vetro serigrafato.

Light emission



Colours

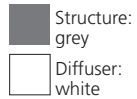

Materials

Structure in painted metal and thermoplastic resin; glass moulded with filigree diffuser.

Matériaux

Structure en métal verni et résine thermoplastique ; diffuseur en feuille de verre sérigraphié.

Materialien

Baldachin und Abhängung aus lackiertem Metall und thermoplastischem Kunstharz; Schirm aus Glas mit Siebdruck.

Materiales

Estructura, de metal pintado y resina termoplástica; difusor de placa de vidrio serigrafado.

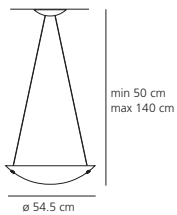

Zsu-Zsu sospensione 55
 HALO max 1x230W (R7s) – ES, included

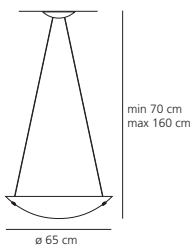

Zsu-Zsu sospensione 65
 HALO max 1x230W (R7s) – ES, included



LUXERION™

La collezione

La collezione Luxerion 2009, comprende tre apparecchi disegnati da Michele De Lucchi, Rota & Pedretti e Karim Rashid. Si tratta di apparecchi che combinano design, comfort visivo dell'illuminazione e purificazione dell'aria con elevate prestazioni, migliorando in modo sostanziale il benessere dell'utente. All'interno dei diffusori è integrato il sistema di filtraggio dell'aria prodotto da Elica.

Modalità di funzionamento

Il funzionamento del modulo di purificazione si basa su un motore interno che aspira l'aria dell'ambiente, depurandola dalle macro impurità grazie a un pre-filtro; successivamente l'aria attraversa un filtro a carboni attivi che ne elimina i cattivi odori, per venire poi purificata da un filtro HEPA (High Efficiency Particulate Air) che trattiene tutte le impurità di dimensione superiore a 0,1 micron, siano esse polveri, pollini, batteri, ecc. L'aria in uscita è completamente depurata e rimessa nell'ambiente. Nel purificatore è integrata una sorgente luminosa a tensione di rete che fornisce una emissione diretta, in aggiunta alle sorgenti per emissione diretta o indiretta presenti negli apparecchi.

Modalità di comando

Gli apparecchi sono comandabili attraverso uno stelo di controllo (touch sensor posizionato sul prodotto o attraverso un comodo telecomando che consente di dimmerare la luce e di regolare la velocità di funzionamento del purificatore. Il purificatore dell'aria è infatti dotato di quattro differenti velocità di aspirazione.

Manutenzione

La manutenzione dell'apparecchio di purificazione dell'aria è un elemento importante per garantire il corretto funzionamento dello stesso. Il filtro HEPA in esso contenuto deve essere sostituito con periodicità che dipende dalle condizioni ambientali in cui l'apparecchio si trova ad operare. In condizioni di impiego normali in ambiente domestico, il filtro deve essere sostituito ogni 8-10 mesi. Un uso molto frequente ed ambienti umidi e molto polverosi riducono il periodo di durata del filtro.

The collection

The Luxerion collection 2008 includes three items, designed by Michele De Lucchi, Rota & Pedretti and Karim Rashid. These are products that combine design, visual comfort of lighting and air purification with high performance characteristics, substantially improving users' well-being. The collection is composed of three suspension lamps with blown glass diffusers, integrated into which is the air filtration system produced by Elica.

How it works

Operation of the purification unit is based on an internal motor that draws the air from the environment, purifying it of its macro-impurities thanks to a pre-filter, subsequently the air passes through an activated carbon filter that eliminates bad odours, to then be purified by an HEPA (High Efficiency Particulate Air) filter that traps all impurities with dimensions of more than 0.1 microns, such as dust, pollen, bacteria, etc. The outgoing air is completely purified and returned into the environment. Integrated into the purifier is a light source at mains voltage that provides direct light emission, in addition to the light sources for direct or indirect emission present in the equipment.

How control it

The equipment can be controlled via a touch sensor positioned on the product or through a convenient remote control that allows to control both the lighting and the speed of operation of the purifier. The air purifier in fact has four different suction speeds.

Maintenance

Maintenance of the air purification equipment is an important element to guarantee its correct operation. The HEPA filter contained in it must be replaced periodically, depending on the conditions of the environment where the equipment operates. Under normal conditions of use in a domestic environment, the filter must be replaced every 8-10 months. Very frequent use and damp and very dusty environments reduce the duration of the filter.

La collection

La collection Luxerion 2008 comprend trois appareils dessinés par Michele De Lucchi, Rota & Pedretti et Karim Rashid. Ce sont des appareils qui associent le design, le confort visuel de l'éclairage et la purification de l'air. Dotés d'excellentes performances ils améliorent substantiellement le bien-être de l'utilisateur. La collection se compose de trois lampes à suspension, comprenant des diffuseurs en verre soufflé, à l'intérieur desquels se trouvent le système de filtrage de l'air réalisé par Elica.

Modalités de fonctionnement

Le fonctionnement du module de purification se base sur un moteur interne qui aspire l'air de la pièce en l'épurant des macro-impuretés, grâce à un filtre préliminaire. Ensuite, l'air traverse un filtre à charbons actifs qui élimine les mauvaises odeurs, puis il est purifié par un filtre HEPA (High Efficiency Particulate Air) qui retient toutes les impuretés mesurant plus de 0,1 micron, qu'il s'agisse de poussière, de pollen, de bactéries, etc. A la sortie, l'air est parfaitement pur et il est réintroduit dans la pièce. Dans le purificateur, une source fournit une émission lumineuse directe, en plus des sources d'émission directe ou indirecte présentes dans les appareils.

Modalités de commande

Les appareils peuvent être commandés à travers une touche de contrôle sensitif (touch sensor) placée sur le produit ou au moyen d'une télécommande qui permet de piloter aussi bien l'éclairage que la vitesse de fonctionnement du purificateur. En effet, le purificateur d'air possède quatre vitesses différentes d'aspiration.

Entretien

L'entretien est un élément important pour garantir le bon fonctionnement de l'appareil de purification de l'air. Le filtre HEPA qu'il contient doit être remplacé avec une fréquence qui dépend des conditions ambiantes avec laquelle l'appareil est appelé à fonctionner. Dans des conditions d'utilisation normales dans un espace domestique, le filtre doit être remplacé tous les huit ou dix mois. L'utilisation fréquente dans des milieux humides et très poussiéreux réduit la période de durée du filtre.

Die Kollektion

Die Kollektion Luxerion 2008 besteht aus drei Leuchten der Designer Michele De Lucchi, Rota & Pedretti sowie Karim Rashid. Die Leuchten zeichnen sich durch eine Kombination von Design, Lichtkomfort und Luftreinigung aus und verbessern spürbar das Wohlbefinden und die Lebensqualität. Die Kollektion umfasst drei Pendelleuchten mit Diffusoren aus geblasenem Glas, in denen ein von der Firma Elica produziertes Modul zur Luftreinigung integriert ist.

Funktionsprinzip

Das Modul zur Luftreinigung besteht aus einem Motor und einem Sauggebläse mit einem Vorfilter, der die größeren in der Umluft befindlichen Fremdstoffe und Unreinheiten auffängt. Ein Aktivkohlefilter gegen unangenehmen Geruch, gefolgt von einem sog. HEPA (High Efficiency Particulate Air)-Filter, der Fremdkörper mit Größe über 0,1 Mikron wie Staub, Pollen, Bakterien usw. filtert folgt darauf. Die nach der Reinigung austretende Luft ist somit von allen Fremd- und Schadstoffen gereinigt. Im Luftreinigungsmodul befindet sich ein über Netzspannung versorgtes Leuchtmittel für direkten Lichtaustritt. Direktes und indirektes Licht wird zusätzlich über in der Leuchte befindliche Lichtquellen erzeugt.

Steuerung

Die Steuerung des Licht- und Filtersystems erfolgt wahlweise über Steuertasten (Touch Sensors) oder über eine Fernbedienung. Der Luftreiniger ist mit vier Stufen zur Luftansaugung ausgestattet.

Wartung

Um eine optimale Funktion zu gewährleisten, ist die Wartung des Luftreinigers von grundlegender Bedeutung. Der HEPA-Filter des Luftreinigers muß regelmäßig ausgetauscht werden; der Zeitraum des Austauschs ist von den jeweiligen Umgebungsbedingungen abhängig. Bei normalen, in einer Wohnung üblicherweise gegebenen Bedingungen sollte der Filter alle 8-10 Monate, bei häufigerer Nutzung und in besonders staubigen Räumlichkeiten entsprechend öfter ausgetauscht werden.

La colección

La colección Luxerion 2008 comprende cuatro aparatos diseñados por Michele De Lucchi, Rota & Pedretti, Karim Rashid y Carlotta de Bevilacqua. Se trata de aparatos que combinan diseño, confort visual de la iluminación y purificación del aire con elevadas prestaciones que mejoran de modo sustancial el bienestar del usuario. La colección se compone de tres elementos suspendidos, con difusores de cristal soplado, en cuyo interior está integrado el sistema de filtración del aire producido por Elica.

Modalidad de funcionamiento

El funcionamiento del módulo de purificación se basa en un motor interno que aspira el aire del ambiente y lo depura de las macro impurezas gracias a un pre-filtro; seguidamente el aire pasa a través de un filtro de carbones activos que elimina los malos olores, para ser luego purificado por un filtro HEPA (High Efficiency Particulate Air) que retiene todas las impurezas de dimensión superior a 0,1 micron, sea polvo como polen, bacterias, etc. El aire que sale está completamente depurado y se incorpora al ambiente. El purificador lleva integrada una fuente con tensión de red que suministra una emisión luminosa directa, añadida a las fuentes por emisión directa o indirecta presentes en los aparatos.

Modalidades de mando

Los aparatos se pueden controlar a través de un vástago de control (touch sensor) colocado en el producto o través de un cómodo mando a distancia que permite pilotar tanto la iluminación como la velocidad de funcionamiento del purificador. En efecto el purificador del aire está dotado de cuatro velocidades de aspiración distintas.

Mantenimiento

El mantenimiento del aparato de purificación del aire es un elemento importante para garantizar el correcto funcionamiento del mismo. El filtro HEPA que lleva se debe sustituir con una periodicidad que depende de las condiciones medioambientales en las que trabaja el aparato. En condiciones de empleo normales en ambiente doméstico, el filtro se debe sustituir cada 8-10 meses. Un uso muy frecuente y ambientes húmedos y llenos de polvo reducen el período de duración del filtro.

Materiali: corpo lampada in vetro soffiato, purificatore in acciaio inox.

Specificità: all'interno del corpo lampada è integrato un filtro di purificazione dell'aria ad elevate prestazioni. Illuminazione e sistema di filtraggio dell'aria gestibili separatamente. Accensione indipendente per l'emissione indiretta dimmerabile e per l'emissione diretta on/off.

Light emission**Colour**

Polished black

Materials

Blown glass lamp unit, stainless steel purifier.

Matériaux

Corps en verre soufflé, système de purification en acier inoxydable.

Materialien

Körper aus geblasenem Glas, Luftreinigungsmodul aus Edelstahl.

Materiales

cuerpo lámpara de vidrio soplado, purificador de acero inox.

Specification

Multi-functional suspension unit. Integrated into the lamp unit is a high-performance filter for air purification. Lighting and air filtration system are manageable separately. Independent switches for dimmable indirect emission and for direct on/off emission.

Spécificité

Suspension multifonction. Le corps de la lampe contient un filtre hautement performant pour la purification de l'air. L'éclairage et le système de filtrage de l'air sont gérables séparément. Allumage indépendant pour l'émission diffuse à gradation et pour l'émission directe on/off.

Spezifikation

Pendelleuchte mit Mehrfachfunktion. Im Leuchtenkörper ist ein Hochleistungsfilter zur Luftreinigung integriert. Licht- und Filtersystem sind separat regelbar. Gestreuter (dimmbarer) sowie direkter Lichtaustritt sind getrennt schaltbar (On/ Off).

Especificaciones

Aparato de suspensión multifunción. En el interior del cuerpo de la lámpara está integrado un filtro de purificación del aire de elevadas prestaciones. Iluminación y sistema de filtración del aire se manejan separadamente. Encendido independiente para la emisión indirecta con dimmer y para la emisión directa on/off.

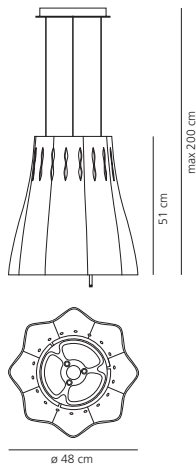
**Indirect emission:**

HALO max 1x230W (R7s) – ES, included

IP20      +  – Dimmer

Direct emission:

HALO max 1x40W (GU 10) – Q PAR 16, included

IP20     

With touch sensor.

Remote control on request.



MODUL
ELECTRO
www.modulelectro.ru



Materiali: diffusore in vetro soffiato, purificatore in acciaio inox.
Specificità: all'interno di un diffusore luminoso è integrato un filtro di purificazione dell'aria ad elevate prestazioni. Illuminazione e sistema di filtraggio dell'aria gestibili separatamente. Accensione indipendente per l'emissione diffusa dimmerabile e per l'emissione diretta on/off.

Light emission



Colour



Materials

Blown glass diffuser, stainless steel purifier.

Matériaux

Diffuseur en verre soufflé, système de purification en acier inoxydable.

Materialien

Diffusor aus geblasenem Glas, Luftreinigungsmodul aus Edelstahl.

Materiales

Difusor de cristal soplado, purificador de acero inox.

Specification

Integrated into a light diffuser is a high-performance filter for air purification. Lighting and air filtration system are manageable separately. Independent switches for dimmable indirect emission and for direct on/off emission.

Spécificité

Le diffuseur lumineux contient un filtre hautement performant pour la purification de l'air. L'éclairage et le système de filtrage de l'air sont gérables séparément. Allumage indépendant pour l'émission diffuse à gradation et pour l'émission directe on/off.

Spezifikation

Im Reflektor ist ein Hochleistungsfilter zur Luftreinigung integriert. Licht- und Filtersystem sind separat regelbar. Gestreuter (dimmbarer) sowie direkter Lichtaustritt sind getrennt schaltbar (On/ Off).

Especificaciones

En el interior de un difusor luminoso está integrado un filtro de purificación del aire con elevadas prestaciones. Iluminación y sistema de filtración del aire se pueden manejar por separado. Encendido independiente para la emisión difusa con dimmer y para la emisión directa on/off.

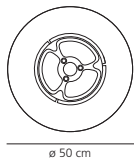
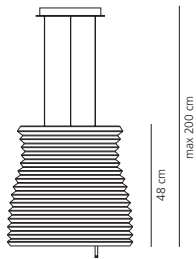

Diffused emission:
max 3x60W (G 9) – ES, included



IP20      +  Dimmer

Direct emission:
HALO max 1x40W (GU 10) – Q PAR 16, included

IP20    

With touch sensor.
Remote control on request.



 **MODUL** 
ELECTRO
www.modulelectro.ru



Materiali: corpo lampada in vetro soffiato, purificatore in acciaio inox.

Specificità: All'interno del corpo lampada è integrato un filtro di purificazione dell'aria ad elevate prestazioni. Illuminazione e sistema di filtraggio dell'aria gestibili separatamente. Accensione indipendente per l'emissione indiretta dimmerabile e per l'emissione diretta on/off.

Light emission



Colour



Materials

Blown glass lamp unit, stainless steel purifier.

Specification

Multi-functional suspension unit. Integrated into the lamp unit is a high-performance filter for air purification. Lighting and air filtration system are manageable separately. Independent switches for dimmable indirect emission and for direct on/off emission.

Matériaux

Corps en verre soufflé, système de purification en acier inoxydable.

Spécificité

Suspension multifonction. Le corps de la lampe contient un filtre hautement performant pour la purification de l'air. L'éclairage et le système de filtrage de l'air sont gérables séparément. Allumage indépendant pour l'émission diffuse à gradation et pour l'émission directe on/off.

Materialien

Körper aus geblasenem Glas, Luftreinigungsmodul aus Edelstahl.

Spezifikation

Pendelleuchte mit Mehrfachfunktion. Im Leuchtenkörper ist ein Hochleistungsfilter zur Luftreinigung integriert. Licht- und Filtersystem sind separat regelbar. Gestreuter (dimmbarer) sowie direkter Lichtaustritt sind getrennt schaltbar (On/ Off).

Materiales

cuerpo lámpara de vidrio soplado, purificador de acero inox.

Especificaciones

Aparato de suspensión multifunción. En el interior del cuerpo de la lámpara está integrado un filtro de purificación del aire de elevadas prestaciones. Iluminación y sistema de filtración del aire se manejan separadamente. Encendido independiente para la emisión indirecta con dimmer y para la emisión directa on/off.

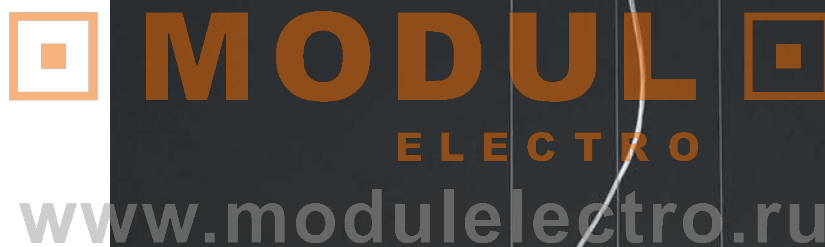
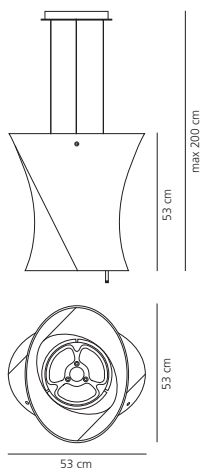

Indirect emission:

HALO max 1x230W (R7s) – ES, included



Direct emission:

HALO max 1x40W (GU 10) – Q PAR 16, included



With touch sensor.

Remote control on request.



Residential outdoor

 **MODUL** 
ELECTRO

www.modulelectro.ru





286
Tolomeo XXL



288
Ciclope incasso



288
Ciclope parete



288
Ciclope terra 50, 90



290
Chilone parete



290
Chilone terra 45,
90, 250, Up



292
Gilippo



294
Pantarei



296
Niki



297
Dioscuri
parete/soffitto 14,
25, 35, 42



298
Giasole t.s.
parete/soffitto



298
Giasole t.s. terra



300
Illo



300
Catilina



300
Aglaia



301
Alcesti parete



301
Alcesti terra



302
Teseo parete



302
Teseo terra



304
Mitasi 36 t.s.



305
Onlylight



305
Onlyled



306
Metamorfoosi kit
outdoor



306
Metaponto



308
Felsina parete



308
Felsina palo



310
Timpone

MODULO
ELECTRO
www.modulelectro.ru

Tolomeo XXL

design

Michele De Lucchi,
Giancarlo Fassina
2009



Materiali: base in cemento; struttura a bracci mobili in alluminio lucidato; testa in alluminio verniciato; diffusore in materiale termoplastico opalino satinato; snodi in alluminio brillantato.

Specificità: in scala 4:1 rispetto al modello da tavolo, è disponibile in versione da interno e in versione outdoor. Sistema di equilibratura a molle.

Light emission



Colours

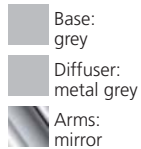

Materials

Base in concrete; cantilevered arms in polished aluminium; head in painted aluminium; diffuser in opal thermoplastic material; joints in polished aluminium.

Matériaux

Base en béton; structure à bras articulés en aluminium poli; tête en aluminium peint; diffuseur en matériau thermoplastique opalin; articulations en aluminium brillant.

Materialien

Sockel aus Beton; ausrichtbare Arme aus glänzendem Aluminium; Leuchtenkopf aus lackiertem Aluminium; Schirm aus thermoplastischem Material; Gelenke aus poliertem Aluminium.

Materiales

Base en cemento; estructura y brazos móviles en aluminio brillo; cabezal en aluminio pintado; difusor en material termoplástico opal satinado; nudos en aluminio brillo.

Specification

In scale 4:1 relative to the table model, it's available both in indoor and outdoor versions. System of spring balancing.

Spécificité

A l'échelle 4:1 par rapport au modèle à poser, elle est disponible aussi bien pour l'intérieur que pour l'extérieur. Système d'équilibrage à ressorts.

Spezifikation

Im Maßstab 4:1 im Vergleich zu der Tischleuchte ist diese XXL-Version für den Innen- und Außenbereich erhältlich. Federausgleichsystem.

Especificaciones

En escala 4:1 respecto al modelo de sobremesa, está disponible en versiones de interior o exterior. Sistema de equilibrio por muelles.

MODULO
ELECTRO
www.modulelectro.ru

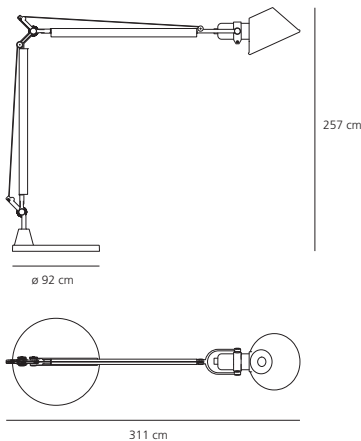

Tolomeo XXL

FLUO 1x120W (2G 8) - TC-TELI
Electronic ballast



Tolomeo XXL outdoor

FLUO 1x120W (2G 8) - TC-TELI
Electronic ballast





MODUL

ELECTRO

www.modulelectro.ru

Ciclope incasso
Ciclope parete
Ciclope terra 50
Ciclope terra 90

design
 Alessandro Pedretti
 Studio Rota & Partner



Materiali: corpo lampada in alluminio pressofuso; stelo in estruso di alluminio.
Specificità: fissaggio a terra con flangia.

Light emission



Colour



Materials

Body lamp in die-cast aluminium; extruded aluminium stem.

Specificity

Floor fixing with ground mounting plate.

Matériaux

Corps lumineux en aluminium galvanisé ; tige en aluminium extrudé.

Spécificité

Fixation au sol avec brides.

Materialien

Leuchtenkörper aus Aluminiumdruckguss, Stab aus stranggepresstem Aluminium.

Spezifikation

Die Verankerung im Boden erfolgt durch eine Montageplatte.

Materiales

Cuerpo de la lámpara en fusión de aluminio, asta en extrusión de aluminio.

Especificaciones

Fijación a tierra con base.

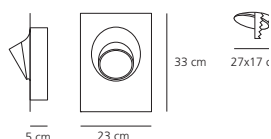

Ciclope incasso
 LED 10W, included

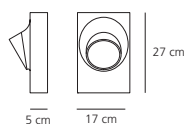

Ciclope parete
 LED 10W, included

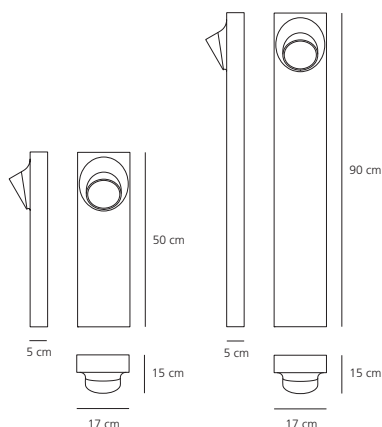

Ciclope terra 50/90
 LED 10W LED, included



MODULO
ELECTRO
www.modulelectro.ru



Ciclope parete



Ciclope incasso



MODUL
ELECTRO
www.modulelectro.ru

Ciclope terra 50

Ciclope terra 90

Chilone parete
Chilone terra 45
Chilone terra 90
Chilone terra 250
Chilone Up

design
 Ernesto Gismondi
 2009



Awards
 Wallpaper Design Award 2010
 "Best Domestic Design"

Materiali: corpo in alluminio verniciato; schermo in materiale termoplastico.
Specificità: fissaggio a terra con flangia.

Light emission



Colour



Metal grey

Materials

Painted aluminium body;
 screen in thermoplastic
 material.

Specificity

Floor fixing with ground
 mounting plate.

Matériaux

Corps en aluminium verni ;
 écran en matériau thermo-
 plastique.

Spécificité

Fixation au sol avec brides.

Materialien

Korpus aus lackiertem Alumi-
 nium, Schirm aus thermo-
 plastischem Material.

Spezifikation

Die Verankerung im Boden
 erfolgt durch eine Montage-
 platte.

Materiales

Cuerpo en aluminio pintado,
 difusor en material termo-
 plástico.

Especificaciones

Fijación a suelo con base.

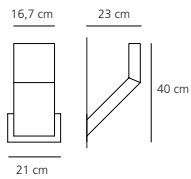

Chilone parete
 LED 12W, included

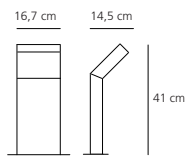

Chilone Up
 LED 12W, included

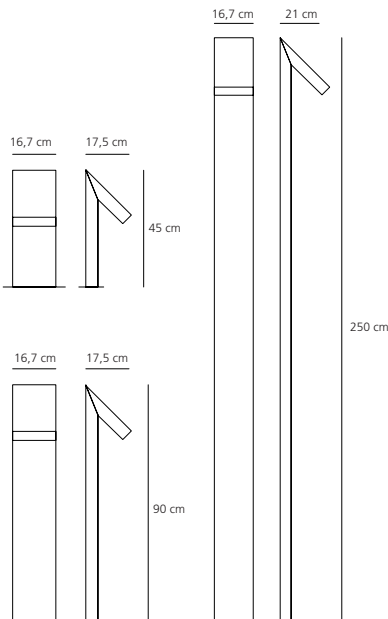

Chilone terra 45/90
 LED 6W, included



Chilone terra 250
 LED 12W, included



MODULO
ELECTRO
www.modulelectro.ru

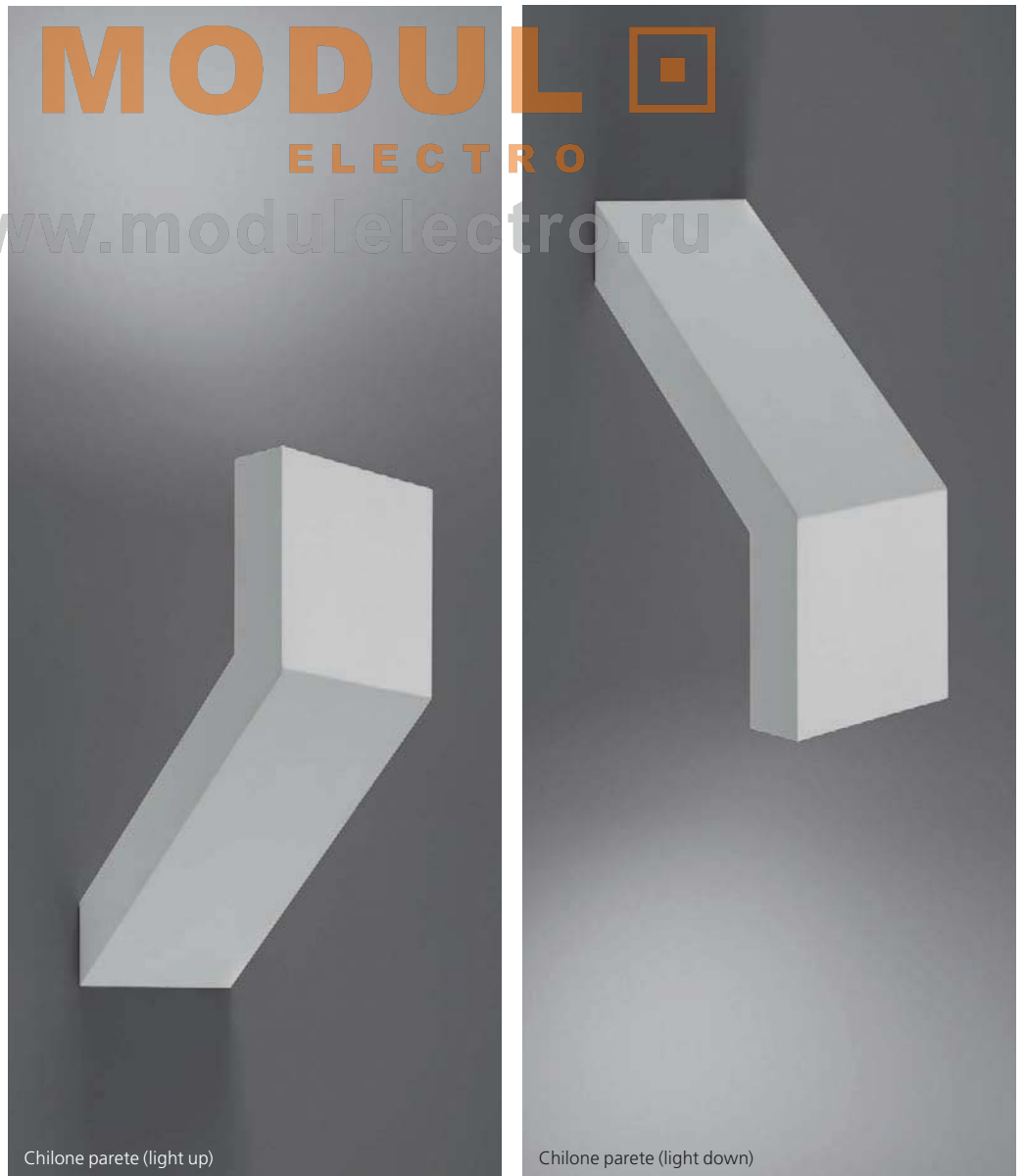

Chilone parete (light up)

Chilone parete (light down)



MODUL
ELECTRO
www.modulelectro.ru

Chilone terra 90

Chilone Up

Chilone terra 250

Chilone terra 45

Gilippo

design
Michele De Lucchi
2009



Materiale: corpi lampade, diffusori e scatole di connessione in materiale termoplastico stampato a iniezione.

Specificità: 6 elementi Led per creare percorsi o zone luminose tra l'erba del giardino.

Light emission



Colour



Green

Materials

Body lamps, diffusers and connection boxes in injection moulded thermoplastic material.

Specificity

6 Led elements create paths or luminous zones in the garden grass.

Matériaux

Base en zamac, tige en résine thermoplastique, diffuseur en verre soufflé.

Spécificité

Six éléments Led pour créer des chemins ou des zones lumineuses dans l'herbe des jardins.

Materialien

Leuchtenkörper, Lichtverteiler und Anschlussgehäuse aus thermoplastischem Kunststoff.

Spezifikation

6 LED-Elemente zur Wegebeleuchtung oder zur Kreation beleuchteter Zonen im Garten.

Materiales

Cuerpo de la lámpara, difusor y caja de conexiones en material termoplástico estampado a inyección.

Especificaciones

6 elementos Led para crear caminos o zonas iluminadas entre el césped y el jardín.

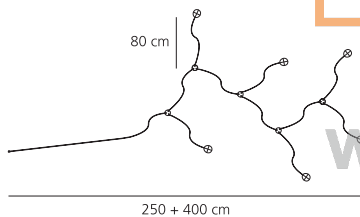
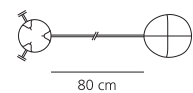
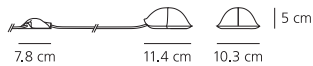

MODUL

ELECTRO

www.modulelectro.ru

LED 6x1W, included

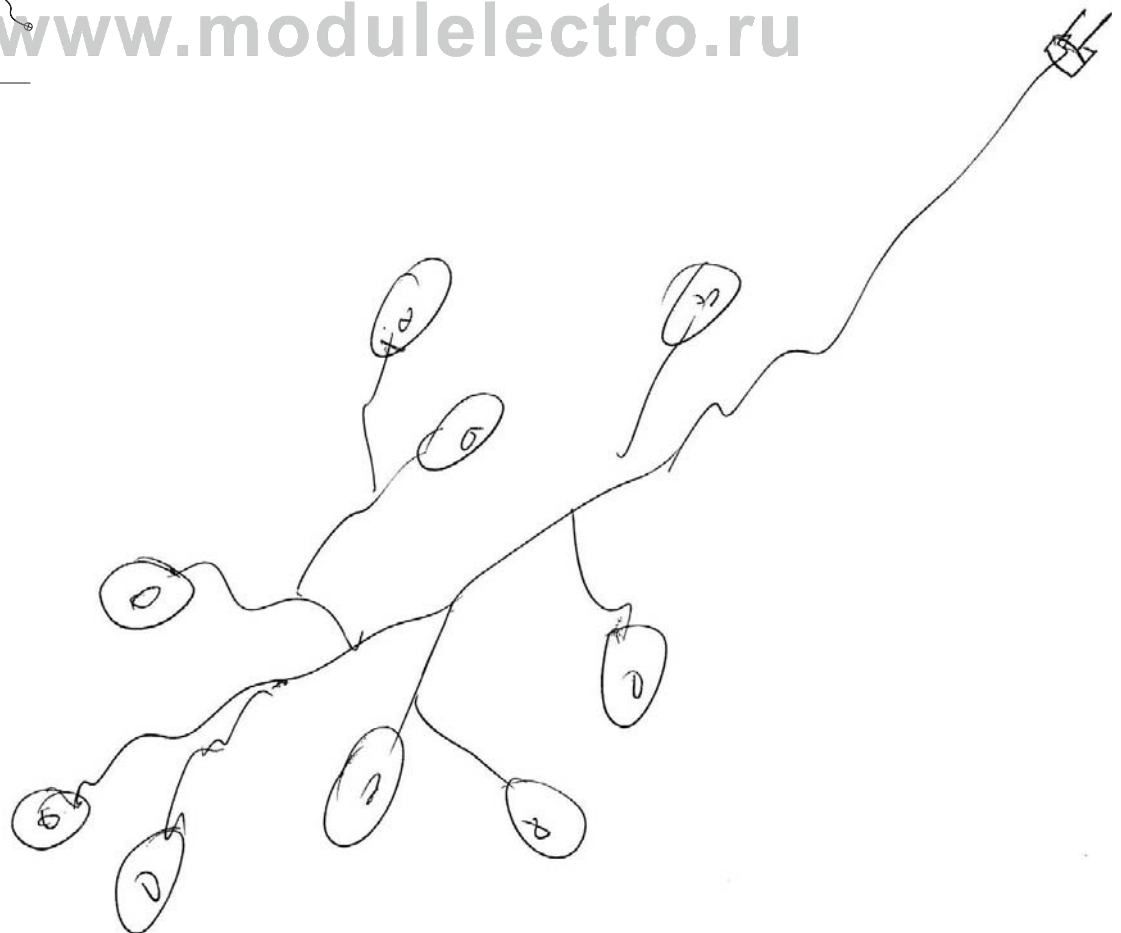



MODUL
ELECTRO
www.modulelectro.ru

Pantarei 180
Pantarei 300
Pantarei 390

design
Ernesto Gismondi
1993



Awards

Design Innovationen Design
Zentrum Nordrhein Westfalen
"Design Innovationen"
1995 – Essen (Deutschland)
"iF – Die Gute Form"
1996 – Hannover (Deutschland)

Museums

Museo Nazionale della Scienza
e della Tecnica – Milano (Italia)

Materiali: struttura in fusione di alluminio preventivamente fosfocromato e verniciato al poliester per la massima resistenza all'ossidazione; viterie in acciaio inox e guarnizioni in gomma siliconica per una perfetta tenuta stagna. Diffusore in vetro stapatato sabbiato o in policarbonato opalino resistente agli urti.
Specificità: Pantarei 190 può essere accessoriata con schermo mezzaluce. Versione emergenza installabile solo a parete.

Light emission



Colours



Structure:
black



Structure:
silver grey



Diffuser:
white

Materials

phospho-cromated die-cast aluminium structure, painted with polyester for maximum resistance to oxidation; inox-steel screws and bolts in silicone rubber. Diffuser in sanded-blasted glass or shock resistant opal polycarbonate.

Matériaux

Structure en fonte d'aluminium avec traitement de phospho-chromatation et peinture polyester pour une résistance maximale à l'oxydation; visserie en acier inoxydable et joints d'étanchéité en silicone.

Materialien

Körper aus Aluminiumguß, der nach einer Phosphorverchromung mit Polyester-Lack zum Schutz gegen Oxydation lackiert wird; Schrauben aus Edelstahl und Dichtungen aus Silikon-Gummi, die optimale Dichtung garantieren. Schirm aus sandgestrahltem Preßglas oder Polycarbonat opal schlagfest.

Materiales

Estructura de fusión de aluminio preventivamente fosfocromado y barnizado de poliester para la máxima resistencia a la oxidación; tornillería en acero inoxidable y guarnición en goma de silicona para una perfecta estanqueidad. Difusor de cristal estampado arenado o en policarbonato opalino resistente a los robos.

Specificity

Pantarei 190 can be equipped with half-light screen. Emergency version only for wall mounting.

Spécificité

Pantarei 190 est disponible avec écran demi-lumière. Version sécurité seulement pour la version applique.

Spezifikation

Pantarei 190 ist auch als Ausführung mit Halbschirm erhältlich. Mit Notlicht nur als Wandleuchte einsetzbar.

Especificaciones

Pantarei 190 ésta disponible con difusor media luz. La versión con emergencia sólo en pared.

MODULO

ELECTRO

www.modulelectro.ru



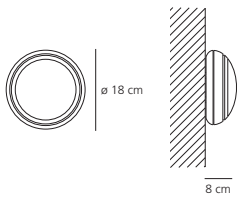

Pantarei 190

(diffuser in sanded glass)

HALO max 1x40W (E 14) – ES

IP65

FLUO 1x10W (G24 d-1) – TC-D

IP65

(diffuser in opal polycarbonate)

FLUO 1x10W (G24 d-1) – TC-D

IP65

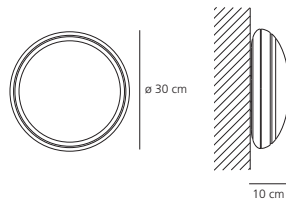

Pantarei 300

(diffuser in sanded glass)

HALO max 1x70W (E 27) – ES

IP65

FLUO 1x23W (E 27) – TC-TSE

IP65

FLUO 1x26W (G24 d-3) – TC-D

IP65

FLUO 2x18W (G24 d-2) – TC-D

IP65

FLUO 1x26W (G24 q-3) – TC-DEL

Electronic ballast

IP65

FLUO 2x18W (G24 q-2) – TC-DEL

Electronic ballast

IP65

FLUO 1x24W (2G 10) – TC-F

With emergency only for wall mounting

IP65

(diffuser in opal polycarbonate)

FLUO 1x26W (G24 d-3) – TC-D

IP65

FLUO 2x18W (G24 d-2) – TC-D

IP65

FLUO 1x26W (G24 q-3) – TC-DEL

Electronic ballast

IP65

FLUO 2x18W (G24 q-2) – TC-DEL

Electronic ballast

IP65

FLUO 1x24W (2G 10) – TC-F

With emergency only for wall mounting

IP65

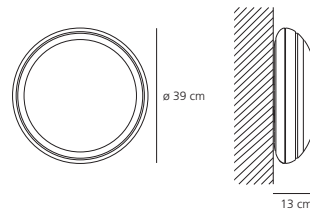

Pantarei 390

(diffuser in sanded glass)

HALO 2x60W (E 27) – QT 32

IP65

FLUO 2x26W (G24 d-3) – TC-D

IP65

FLUO 1x36W (2G 10) – TC-F

with emergency only for wall mounting

IP65

FLUO 1x24W (2G 10) – TC-F

IP65

(diffuser in opal polycarbonate)

FLUO 2x26W (G24 d-3) – TC-D

IP65

FLUO 1x36W (2G 10) – TC-F

With emergency only for wall mounting

IP65

FLUO 1x24W (2G 10) – TC-F

IP65



Pantarei 190



Pantarei 190
half-light screen



Pantarei 300



Pantarei 390

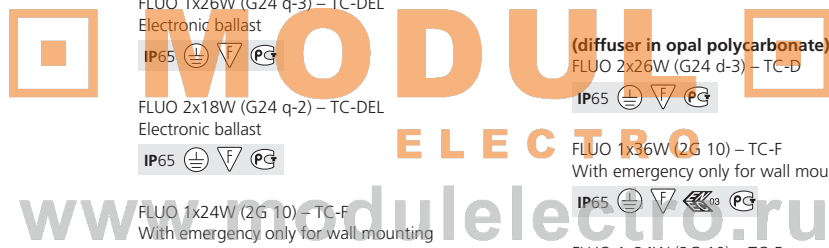

Niki

design

Ernesto Gismondi
1999



Materiali: corpo in acciaio inox, diffusore in vetro stampato prismato e satinato o in policarbonato opalino resistente agli urti.

Specificità: predisposizione per il collegamento in cascata degli apparecchi. Versione emergenza installabile solo a parete.

Light emission



Colours

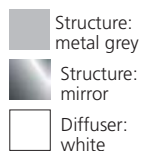

Materials

Body in stainless steel; diffuser in prismatic and satinized moulded glass or impact resistant polycarbonate.

Specificity

Suitability of the equipment for "cascade". Emergency version only for wall mounting.

Matériaux

Corps en acier inox ; diffuseur en verre moulé à prisme et sablé ou en polycarbonate antichoc.

Spécificité

Prédisposition pour le raccordement en cascade des appareils. Version sécurité seulement pour la version applique.

Materialien

Körper aus Edelstahl; Schirm aus satiniertem und prismatisiertem Preßglas oder aus stoßfestem Polycarbonat.

Spezifikation

Der elektrische Anschluß ermöglicht eine Installation in Reihe. Mit Notlicht nur als Wandleuchte einsetzbar.

Materiales

Cuerpo de acero inoxidable; difusor de cristal estampado prismático y satinado o en policarbonato opalino resistente a los golpes.

Especificaciones

Predisposición para la conexión en cascada de los aparatos. La versión con emergencia sólo en pared.

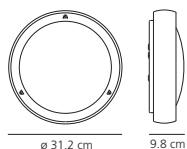

HALO max 1x52W (E 27) – ES



FLUO 2x18W (G24 d-2) – TC-D



FLUO 2x18W (G24 q-2) – TC-DEL
Electronic ballast
with emergency only for wall mounting



FLUO 1x18W (G24 q-2) – TC-DEL
Electronic ballast



Dioscuri parete/soffitto 14
Dioscuri parete/soffitto 25
Dioscuri parete/soffitto 35
Dioscuri parete/soffitto 42

design
 Michele De Lucchi
 1999, 2003, 2005



123



Awards

Design Innovationen
 Design Zentrum Nordrhein Westfalen
 Reddot Design Award
 2000 – Essen (Deutschland)
 Design Plus Light + Building
 2000 – Frankfurt am Main (Deutschland)

Light emission



Colour



White

Materiali: base in resina termoplastica; diffusore in vetro soffiato acidato.

Materials

Base in thermoplastic resin,
 acid-etched blown glass
 diffuser.

Matériaux

Base en résine thermoplastique,
 diffuseur en verre soufflé
 traité à l'acide.

Materialien

Sockel aus thermoplastischem
 Harz, Kugel aus mundgeblasenem,
 geätztem Glas.

Materiales

Pie de resina termoplástica,
 difusor de cristal soplado al
 ácido.

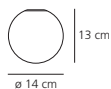

Dioscuri parete/soffitto 14
 HALO max 1x48W (G 9) – ES, included
 IP65 □ F

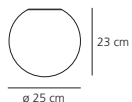

Dioscuri parete/soffitto 25
 HALO max 1x70W (E 27) – ES
 or
 FLUO 1x20W (E 27) – TC-TSE
 IP65 □ F

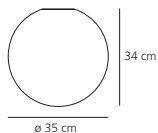

Dioscuri parete/soffitto 35
 HALO max 1x105W (E 27) – ES
 or
 FLUO 1x23W (E 27) – TC-TSE
 IP65 □ F

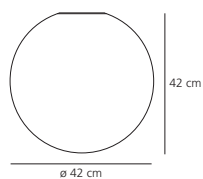

Dioscuri parete/soffitto 42
 HALO max 1x105W (E 27) – ES
 or
 FLUO 1x23W (E 27) – TC-TSE
 IP65 □ F

MODUL
ELECTRO
www.modulelectro.ru



Giasole t.s. parete/soffitto
Giasole t.s. terra

design
Ernesto Gismondi
1978







Materiali: diffusore in vetro sabbiato; guarnizioni in silicone espanso; viterie in acciaio inox; fondello in alluminio verniciato; palo in estruso di alluminio.

Specificità: versione terra disponibile ad una o due teste. Fissaggio palo: con flangia o con palo interrato.

Light emission



Colours

-  Structure: white
-  Structure: black
-  Structure: silver grey
-  Diffuser: white

Materials

Sanded glass diffuser; sealant in silicone rubber; metal components in stainless steel; support in painted aluminium; pole in extruded aluminium.

Specificity

Floor version is available with one or two heads.
Fixing: underground pole or pole with ground mounting plate.

Matériaux

Diffuseur en verre sablé ; joints d'étanchéité en silicone ; visserie en acier inoxydable ; base en aluminium verni ; mât en aluminium extrudé.

Spécificité

Giasole terra est disponible avec une ou deux têtes.
Fixation : mât à enterrer ou mât avec semelle de fixation.

Materialien

Schirm aus Sandglas; Dichtung aus geschäumtem Silikon; Schrauben aus Edelstahl; Sockel aus lackiertem Aluminium; Standrohr aus Aluminium.

Spezifikation

Pollerleuchte wahlweise ein- oder zweiflammig erhältlich.
Befestigung: mit durchgehendem Erdstück oder mit Halterung für Erdungsleiter.

Materiales

Difusor en cristal arenado; guarnición en silicona dilatada; tornillería en acero inoxidable; base de aluminio pintado; palo en aluminio extruido.

Especificaciones

Versión de pie, con una o dos cabezas. Fijación: palo empotrado con plancha de fijación al suelo.

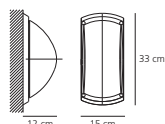

Giasole t.s. parete/soffitto
HALO max 1x70W (E 27) – ES

IP54    

FLUO 1x18W (G24 q-2) – TC-D
Electronic ballast

IP54    

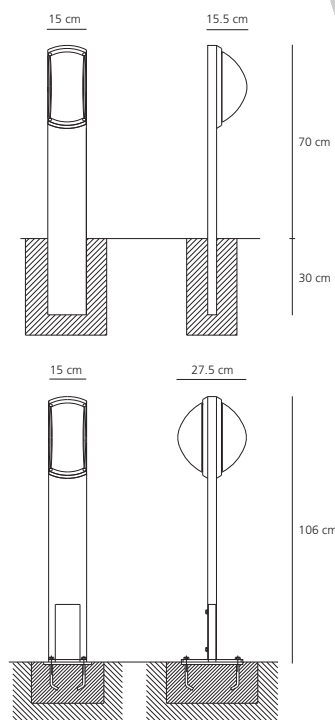

Giasole t.s. terra 1 head / 2 heads

HALO max 1x70W (E 27) – ES
HALO max 2x70W (E 27) – ES

IP54    

FLUO 1x18W (G24 q-2) – TC-D
FLUO 2x18W (G24 q-2) – TC-D
Electronic ballast

IP54    

MODULO
ELECTRO
www.modulelectro.ru





MODUL
ELECTRO
www.modulelectro.ru

Illo
Catilina
Aglaia

design
Sergio Mazza





Materiali: corpo in fusione di alluminio preventivamente fosfocromato e verniciato al poliестere per la massima resistenza all'ossidazione; viterie in acciaio inox; diffusore in vetro soffiato opalino; guarnizione in silicone espanso; palo in alluminio.

Specificità: Illo è installabile solo a soffitto, Catilina sia a parete che a terra. Fissaggio palo: con flangia o con palo interrato.

Light emission



Colours

-  Structure: grey
-  Structure: silver grey
-  Diffuser: white

Materials

Body in phospho-chromated diecast aluminium painted with polyester for maximum resistance to oxidation; internal metal components in stainless steel; diffuser in opal blown glass; sealant in silicone rubber; aluminium pole.

Matériaux

Corps en fonte d'aluminium avec traitement de phospho-chromatation et revêtement avec une peinture polyester pour une résistance maximale à l'oxydation ; visserie en acier inoxydable ; diffuseur en verre soufflé opalin ; joints d'étanchéité en silicone ; mât en aluminium.

Materialien

Leuchtenkörper aus Aluminiumguß, der nach einer Phosphor-Verchromung mit Polyester-Lack zum Schutz gegen Oxydation lackiert wird; Schrauben aus Edelstahl; Schirm aus geblasenem Opalglas; Dichtung aus geschäumtem Silikon; Standrohr aus Aluminium.

Materiales

Fusión de aluminio, preventivamente fosfocromado y barnizado con poliester para la máxima resistencia a la oxidación; tornillería en acero inoxidable; difusor de cristal soplado opalino; guarnición en silicona dilatada; palo en aluminio.

Specificity

Illo ceiling mounting only, Catilina both wall and floor mounting. Fixing: underground pole or with ground mounting plate.

Spécificité

Illo s'installe uniquement au plafond, Catilina aussi bien en applique qu'en lampadaire. Fixation : mât à enterrer ou mât avec semelle de fixation.

Spezifikation

Illo nur als Deckenleuchte, Catilina als Pollerleuchte und Wandleuchte erhältlich. Befestigung: mit durchgehendem Erdstück oder mit separater Bodenplatte.

Especificaciones

Illo sólo en plafón, Catilina aplique y de pie. Fijación: palo enterrado o con plancha de fijación al suelo pedir aparte.

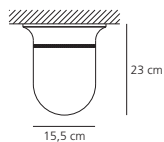

Illo
HALO max 1x70W (E 27) – ES

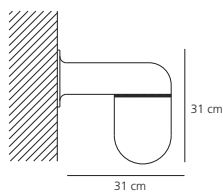
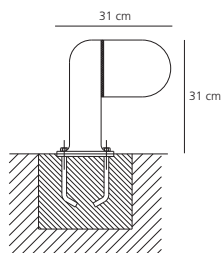

Catilina
HALO max 1x70W (E 27) – ES
or
FLUO 1x20W (E 27) – TC-TSE

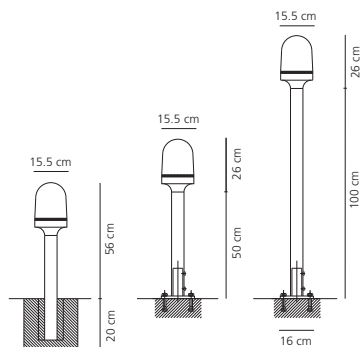

Aglaia
HALO max 1x70W (E 27) – ES
or
FLUO 1x20W (E 27) – TC-TSE



MODULO
ELECTRO

www.modulelectro.ru



Alcesti parete Alcesti terra

design
Ernesto Gismondi
1992





Materiali: fusione di alluminio preventivamente fosfocromato e verniciato al poliester per la massima resistenza all'ossidazione; viterie in acciaio inox; diffusore in vetro stampato sabbiato con profilo trasparente, guarnizione in silicone espanso; palo in acciaio verniciato.

Specificità: accessori parete: schermo direzionale. Fissaggio palo: con flangia o con palo interrato.

Light emission



Colours

-  Structure: black
-  Structure: silver grey
-  Diffuser: white

Materials

Body is phospho-chromated diecast aluminium painted with polyester for maximum resistance to oxidation; internal metal components in stainless steel; diffuser in sanded glass with transparent profile; sealant in silicone rubber; pole in painted steel.

Matériaux

Corps en fonte d'aluminium avec traitement de phosphochromatation et revêtement avec une peinture polyester pour une résistance maximale à l'oxydation; visserie en acier inoxydable; diffuseur en verre moulé sablé avec profilé transparent; mât en acier verni.

Materialien

Leuchtenkörper aus Aluminiumguß, der nach einer Phosphor-Verchromung mit Polyester-Lack zum Schutz gegen Oxydation lackiert wird; Schrauben aus Edelstahl; Schirm aus sandgestrahltem Preßglas mit transparentem Profil; Dichtung aus geschäumtem Silikon; Mast aus lackiertem Stahl. Zubehör (Alcesti parete): Reflektorschirm aus eloxiertem Aluminium.

Materiales

fusión de aluminio, anteriormente fosfocromado y barnizado con poliester para la resistencia máxima a la oxidación; tornillería en acero inox; difusor en cristal estampado arenado con perfil transparente; guarnición en silicona dilatada.

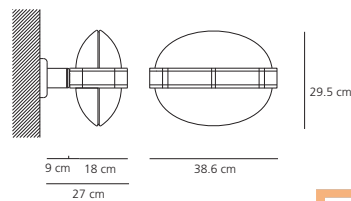

Alcesti parete
FLUO 2x26W (G24 d-3) – TC-D



Specificity

Accessories (Alcesti parete): directional screen. Fixing: underground pole or with flange.

Spécificité

Accessoires (Alcesti parete): écran pour lumière directionnelle en aluminium anodisé. Fixation: avec brides ou mât à enterrer.

Spezifikation

Befestigung: mit Flanschplatte oder Mast mit durchgehendem Erdstück. Farben: Schwarz oder Silver. Lichtverteilung: gestreut.

Especificaciones

Accesorios (Alcesti parete): pantalla direccional. Fijación: con brida o con palo empotrado.

MODULO
ELECTRO

www.modulelectro.ru

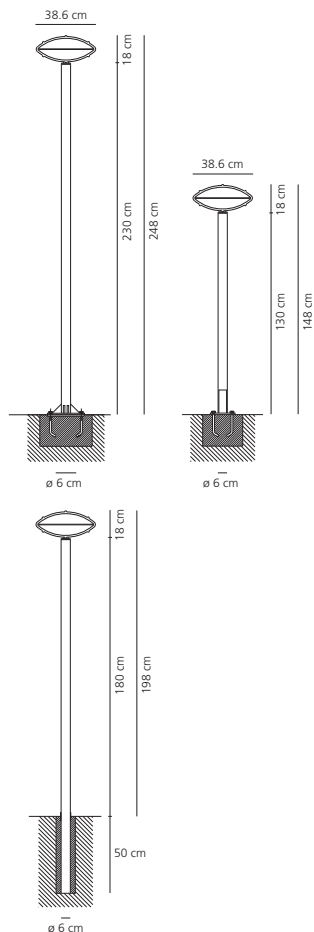

Alcesti terra
FLUO 2x26W (G24 d-3) – TC-D



Teseo parete
Teseo terra

design
Ernesto Gismondi
1984



Materiali: corpo in ABS; viterie in acciaio inox, diffusore in policarbonato opalino; guarnizioni in etilene propilene.

Specificità: fissaggio Teseo terra con flangia o con palo interrato.

Light emission



Colour

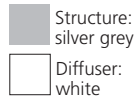

Materials

ABS body lamp; screws in stainless steel; diffuser in opal polycarbonate; sealant in propylene ethylene.

Specificity

Fixing Acesti terra: underground pole or pole with ground mounting plate.

Matériaux

Corps en ABS ; visserie en acier inoxydable; diffuseur en polycarbonate opalin ; joints d'étanchéité en éthylène propylène.

Spécificité

Fixation Teseo terra: mât à enterrer ou avec semelle de fixation.

Materialien

Leuchtenkörper aus ABS; Schrauben aus Edelstahl; Schirm aus opalem Polycarbonat; Dichtungen aus Propylen-Äthylen.

Spezifikation

Befestigung Teseo terra: mit durchgehendem Erdstück oder mit separater Bodenplatte.

Materiales

Cuerpo en ABS; tornillería en acero inoxidable; difusor en policarbonato opalino; guarniciones en etileno propileno.

Especificaciones

Fijación alcesti terra: palo empotrado con plancha de fijación en el suelo; pedir aparte.

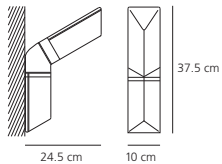

Teseo parete
FLUO 1x11W (G 23) – TC-S

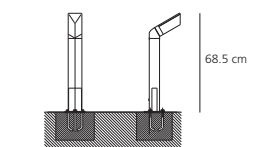
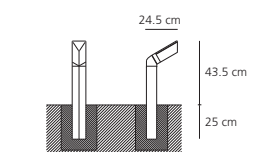
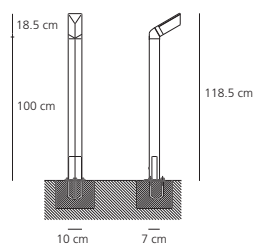
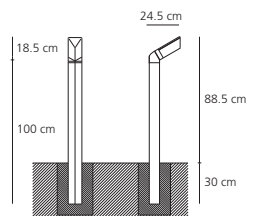

Teseo terra
FLUO 1x11W (G 23) – TC-S

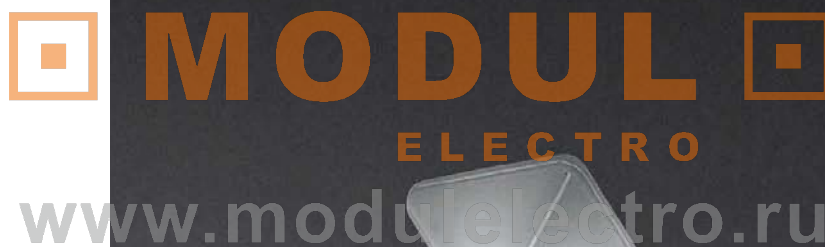



MODUL
ELECTRO
www.modulelectro.ru

Mitasi 36 t.s.

design

Ernesto Gismondi
1991



Materiali: supporto parete-soffitto in metallo verniciato; diffusore in vetro sabbato bianco.

Specificità: schermo direzionale fornito come accessorio.

Light emission



Colours

Structure:
black

Structure:
silver grey

Diffuser:
white

Materials

wall-ceiling support in
painted metal; white sanded
glass diffuser.

Specificity

Directional screen supplied as
accessory.

Matériaux

Support applique/plafonnier
en métal verni ; diffuseur en
verre sablé blanc.

Spécificité

Écran pour lumière direc-
tionnelle à commander en tant
qu'accessoire.

Materialien

Sockel der Wand- und
Deckenleuchte aus lackiertem
Metall; Schirm aus weißem
Sandglas.

Spezifikation

Reflektorschirm als Zubehör
erhältlich.

Materiales

Soporte de aplique o plafón
de metal pintado; difusor en
cristal estampado arenado
blanco.

Especificaciones

Accesorios: pantalla direc-
cional suministrado como
accessorio.

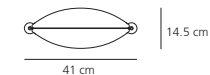
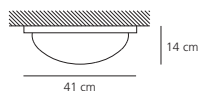

INC max 2x40W (E 14) -D 45

IP55     

FLUO 1x26W (G24 d-3) - TC-D

IP55     

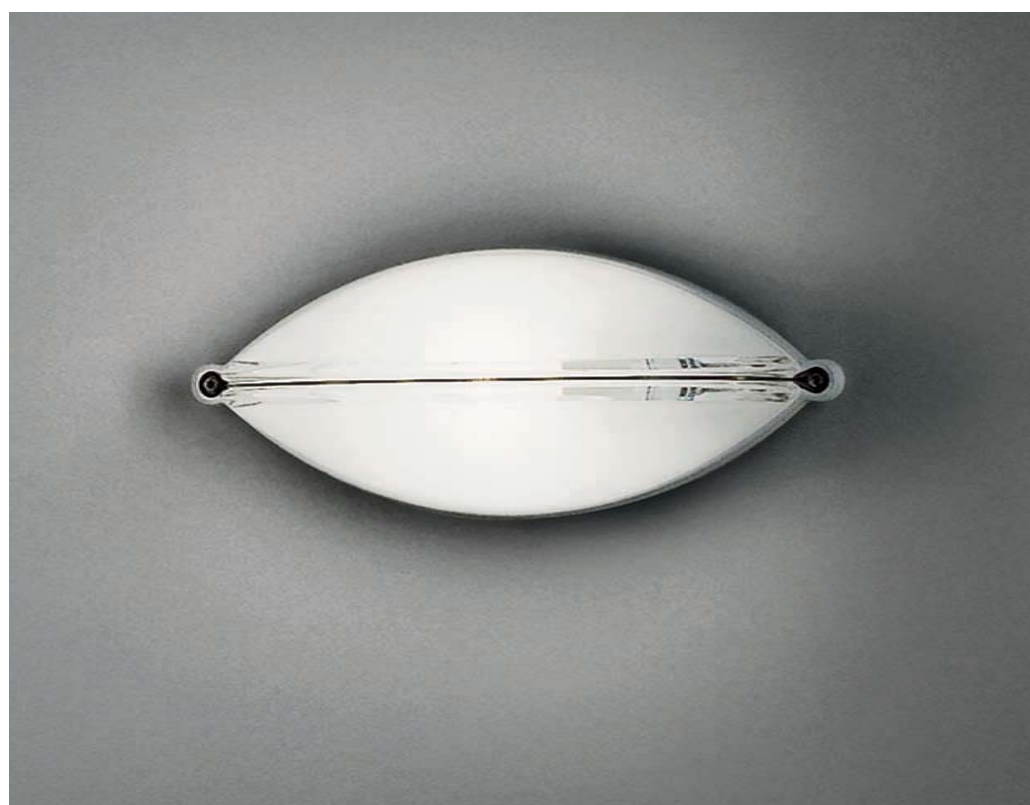
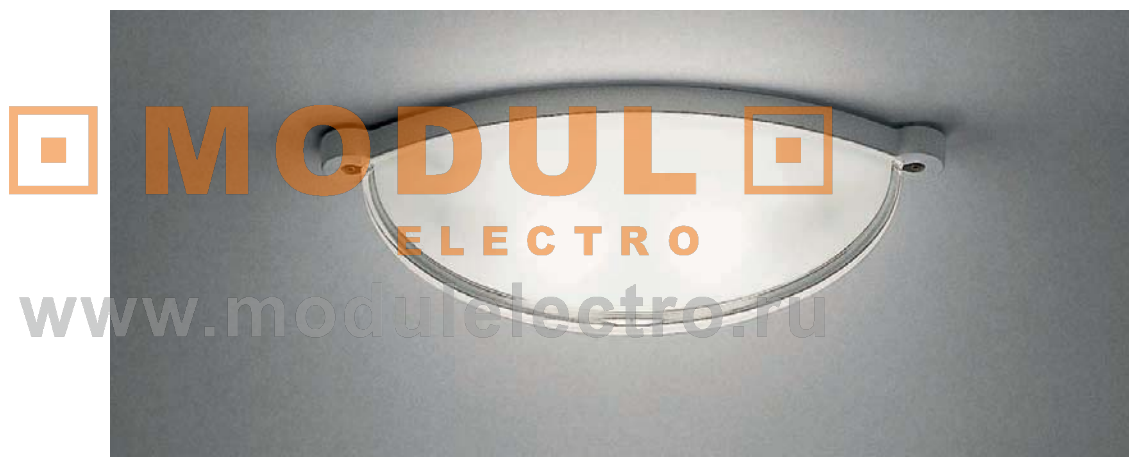



Materiali: struttura in acciaio inox (Onlyled) o alluminio (Onlylight); diffusore in vetro temperato acidato o trasparente; anello frontale in acciaio inox.

Specificità: serie di faretti calpestabili ad incasso. È disponibile una scatola di armatura in polipropilene per la posa nel calcestruzzo.

Light emission



Colour



Metal grey

Materials

Materials: stainless steel structure (Onlyled) or aluminium (Onlylight); acid-etched tempered or transparent glass diffuser; stainless steel front bezel.

Matériaux

Structure en acier inox (Onlyled) ou aluminium (Onlylight); diffuseur en verre trempé traité à l'acide ou transparent; colle-rette frontale en acier inox.

Materialien

Struktur aus Edelstahl (Onlyled) oder Aluminium (Onlylight); Schirm aus gehärtet- geätztem Glas; Abschlussring aus Edelstahl.

Materiales

Estructura en acero inox (Onlyled) o aluminio (Onlylight); difusor en cristal templado al ácido; anillo frontal en acero inox.

Specificity

Range of ground-recessed luminaires. A polypropylene recessed mounting box for installation into concrete is available.

Spécificité

Série d'encastres piétonniers. Un boîtier d'armature en polypropylène pour la mise en œuvre est disponible. Emission lumineuse : diffuse.

Spezifikation

Für die Installation in Beton ist ein Einbauehäuse aus Polypropylen erhältlich. Lichtverteilung: gestreut.

Especificaciones

Serie de focos pisables. Disponible una caja empotrable en polipropileno. Emisión de luz: difusa.

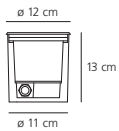

Onlylight 120

FLUO 1x6W (GX 53) - T2, spread angle 95°

IP67 Resistance 12j, max load 1000 kg

HALO 1x35W/12V (GU 5,3) - CBC 51 Spread angle 38°

IP67 Resistance 12j, max load 1000 kg

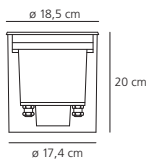

Onlylight 185

HALO 1x75W (E 27) - PAR30, spread angle 30°/50°

IP67 Resistance 12j, max load 1000 kg

FLUO 1x18W (GX 24d-2) - TC-T, spread angle 70°

IP67 Resistance 12j, max load 1000 kg

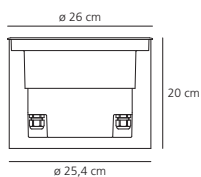

Onlylight 260

FLUO 1x26W (GX 24d-3) - TC-T, spread angle 95°

IP67 Resistance 12j, max load 1000 kg

METAL HALIDE 1x35W (G 12) HIT, spread angle 42°

IP67 Resistance 12j, max load 1000 kg

METAL HALIDE 1x70W (G 12) HIT, spread angle 42°

IP67 Resistance 12j, max load 1000 kg



spotlight

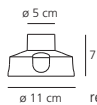

recessing box

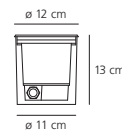

Onlyled 120

Onlyled 50

LED 5x0,2W white, included, spread angle 72°
or
LED 5x0,2W blue, included, spread angle 72°

IP67 Max load 2000 kg

Onlyled 120

LED 3x1W white, included, spread angle 6°
or
LED 3x1W blue, included, spread angle 6°

IP67 Max load 2000 kg

Metamorfosi kit outdoor Metaponto

2000

Artemide
METAMORFOSI



Light emission



Colour



Green

Materiali: corpo in estruso di alluminio e vetro stampato trasparente temperato.
Specificità: il kit è costituito da 3 cilindri contenenti 3 proiettori alogeni con filtri dicroici rosso, verde e blu che consentono di ottenere infinite atmosfere di luce colorata. Un quarto cilindro contiene centralina e ricevitore. Sono disponibili nelle versioni stand alone o sincronizzati, in cui al corpo lampada base si possono aggiungere fino a 120 apparecchi supplementari comandabili dalla stessa centralina (30 per ogni canale d'uscita). Attraverso un telecomando è possibile gestire le atmosfere standard e agire sull'intensità luminosa. Una staffa di sostegno consente il fissaggio a terra o a parete e permette l'orientabilità.

Metaponto: è il kit Metamorfosi outdoor in configurazione proiettore orientabile.

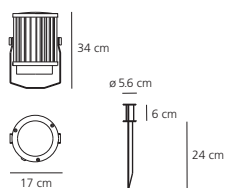

Metamorfosi kit outdoor
HALO 3x150W (B 15d) – ES
with or without remote control

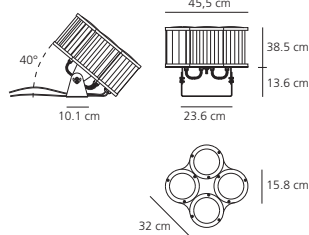

Metaponto
HALO 3x150W (B 15d) – ES



Infrared remote control
(included)

Materials

Body in extruded aluminium and transparent moulded tempered glass.

Specificity

The kit is composed by 3 cylinders containing 3 halogen projectors with dichroic filters red, green and blue, which allow to create a wide range of light coloured atmospheres. A fourth cylinder contains distribution board and receiver. They are available in stand alone or in synchronised versions, to which basic lamp unit can be added up to 120 supplementary items, controllable from the same board (30 for each output). It is possible, using a remote control, to select standard atmospheres and to adjust the light intensity. A support bracket allows floor or wall mounting and the adjustment.

Metaponto
It's the Metamorfosi Kit outdoor in adjustable spot configuration.

Matériaux

Corps en aluminium extrudé et verre transparent moulé trempé.

Spécificité

Le kit est composé de 3 cylindres contenant 3 projecteurs halogènes avec filtres dichroïques rouge, vert et bleu, permettant d'obtenir de nombreuses atmosphères de lumière colorée. Un quatrième cylindre contient la centrale de régulation et le récepteur. A l'aide de la télécommande, il est possible de sélectionner les atmosphères standard et d'agir sur l'intensité lumineuse. Ces kits sont disponibles en version stand alone ou synchronisée et il est possible d'ajouter au module de base jusqu'à 120 appareils supplémentaires, commandés par la même centrale. (30 pour chaque conduit de sortie). Une bride de support permet la fixation dans le sol ou au mur et l'orientation.

Metaponto
C'est le Kit Metamorfosi outdoor en configuration projecteur orientable.

Materialien

Körper aus Aluminium und gehärtetem Pressglas.

Spezifikation

Das Kit besteht aus 3 Zylindern mit jeweils einem Halogenstrahler. Die Halogenstrahler sind mit dichroitischen Filtern in den Grundfarben Rot, Grün und Blau ausgestattet. Mit Hilfe der Filter lassen sich vielfältige farbige Lichtstimmungen kreieren. In einem vierten Zylinder befinden sich die Steuereinheit und der Empfänger. Erhältlich als Stand Alone oder Synchron-Ausführung. Bei der Synchron-Ausführung können an die Basisleuchte bis zu 120 Zusatzleuchten angeschlossen werden, die über eine Steuerungseinheit geschaltet werden (30 Leuchten für jeden Ausgangskanal). Die Lichtstimmungen sind über eine Fernbedienung abrufbar (verschiedene Standardlichtstimmungen und Lichtintensitäten). Verstellbare Bügel ermöglichen die Montage der Leuchte an der Wand oder auf dem Boden.

Metaponto
Verstellbare Strahlerversion des Metamorfosi Kit Outdoor.

Materiales

Cuerpo en aluminio extruido y cristal impreso transparente templado.

Especificaciones

El kit está constituido por 3 cilindros que contienen 3 proyectores halógenos con filtros dicroicos, rojo, verde y azul, que permiten obtener infinitas atmósferas de luz coloradas. Un cuarto cuerpo cilíndrico contiene central y receptor. Se presentan en versiones stand alone o sincronizados y a las cuales el cuerpo de la lámpara, que hace de base, se le pueden añadir hasta 9 aparatos suplementarios, que se gobiernan mediante la misma central (30 para cada canal de salida). Mediante un mando a distancia es posible manejar 10 atmósferas standard y actuar en la intensidad luminosa.

Un soporte permite fijarlo en el suelo o en la pared y permite además su orientabilidad.

Metaponto
Esta el Kit Metamorfosi Outdoor en configuración proyector orientable.



Metamorfosi kit outdoor



Metaponto



MODUL
ELECTRO
www.modulelectro.ru

Felsina parete Felsina palo

design
Ernesto Gismondi
1994



Awards

Compasso D'oro/ADI
"Segnalazione d'Onore"
1998 – Milano (Italia)

Museums

Museo Nazionale della Scienza
e della tecnica – Milano (Italia)

Materiali: corpo lampada in fusione di alluminio preventivamente fosfocromato e verniciato al poliester per la massima resistenza all'ossidazione; riflettore in alluminio iperpuro; diffusore in vetro temprato; palo in acciaio verniciato.

Specificità: serie di proiettori installabili a parete o su palo. Disponibili ad emissione diretta o a doppia emissione, con sorgenti a ioduri metallici o vapori di sodio ad alta pressione. In versione su palo è disponibile singolo, a 2 o 3 teste con proiettori orientabili, e singolo con proiettore fisso. Disponibili pali da 3, 4 o 5 metri.

Light emission



Colours

Structure:
grey.
Diffuser:
transparent.

Felsina parete

(direct or direct-indirect emission)

Felsina palo, adjustable

(direct or direct-indirect emission)

Felsina palo, fix

(direct emission)

METAL HALIDE 1x70W (E 27) – HIE



METAL HALIDE 1x100W (E 27) – HIE



METAL HALIDE 1x150W (E 27) – HIE



SODIUM VAPOUR 1x100W (E 40) – HSE



SODIUM VAPOUR 1x150W (E 40) – HSE

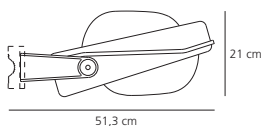

Felsina parete, - Felsina palo, adjustable

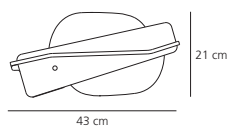

Felsina palo, fix

Materials

Body lamp in phospho-chromated die-cast aluminium painted with polyester for maximum resistance to oxidation; reflector of pure aluminium; diffuser in tempered glass pole. Colour: Antigua grey.

Specificity

Range of projectors for wall or pole installation. Available with direct or dual emission, with metal halide or high pressure sodium vapour sources. The pole luminaire is available with one, two or three heads with adjustable projectors and single with fixed projector. Poles: available in 3, 4 or 5 meters.

Matériaux

Corps en fonte d'aluminium avec traitement de phosphochromation et revêtement avec peinture polyester pour une résistance maximale à l'oxydation ; réflecteur en aluminium extra-pur ; diffuseur en verre trempé ; mât en acier verni.

Spécificité

Série de projecteurs en version applique ou sur mât. Disponibles avec émission directe ou double, avec sources à iodures métalliques ou vapeurs de sodium haute pression. En version sur mât 1, 2 ou 3 têtes avec projecteurs orientables sont disponibles et la version simple avec projecteur fixe. Mât disponibles de 3, 4 ou 5 mètres.

Materialien

Aluminiumguß, der nach einer Phosphorverchromung mit Polyester-Lack zum Schutz gegen Oxydation lackiert wird; Reflektor aus reinst-aluminium, Schirm aus Glas; Mast aus Stahl lackiert.

Spezifikation

Strahler für Wand- und Mastinstallation. Erhältlich mit direktem oder direkt/indirektem Lichtaustritt für Natriumhochdruck-, oder Quecksilberdampf lampen. Die Mastleuchte ist in 3 Versionen erhältlich: einflammig fest sowie zwei- oder dreiflammig verstellbar. Masthöhe wahlweise 3 m, 4 m oder 5 m.

Materiales

Fusión de aluminio preventivamente fosfocromado y barnizado de poliester para la máxima resistencia a la oxidación; reflector en aluminio hiperpuro; difusor de cristal templado; palo en acero barnizado.

Especificaciones

Aparato de pared o de palo. Disponibles con emisión directa o a doble emisión, con fuente de luz a yoduros metálicos o a vapores de sodio alta presión. En versión de palo está disponible de una, dos o tres cabezas con proyectores orientables y singular con proyector fijo. Palos disponibles de 3,8 o 5 metros.



Felsina parete, direct emission



Felsina parete, direct-indirect emission

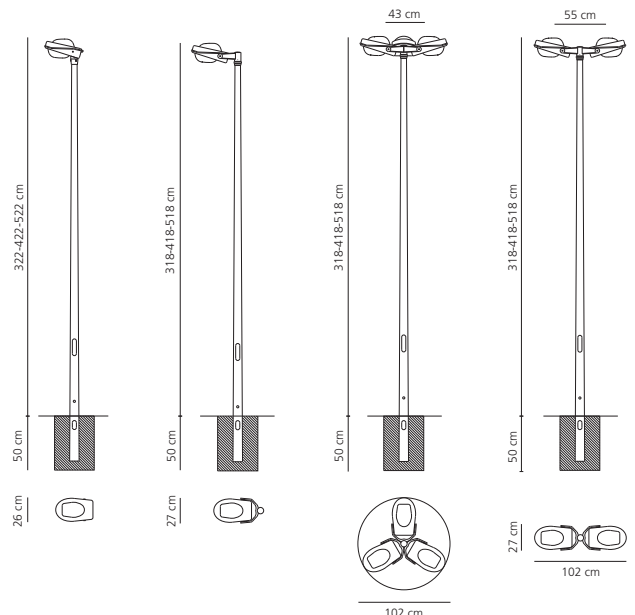



Felsina parete, adjustable



Felsina palo, fix



Felsina palo, adjustable



Felsina palo, 2 heads



Felsina palo, 3 heads

MODUL
ELECTRO
www.modulelectro.ru

Timpone

design

Umberto Riva
1995



Awards

Compasso D'oro/ADI
"Segnalazione d'Onore"
1998 – Milano (Italia)

Materiali: Corpo lampada in fusione di alluminio preventivamente fosfocromato e verniciato al poliestere per la massima resistenza all'ossidazione; diffusore in PMMA opalino; palo e bracci in acciaio verniciato.

Specificità: Apparecchio a palo. Disponibile con sorgenti a ioduri metallici o vapori di sodio ad alta pressione. Ampia possibilità di configurazioni dei bracci e dei diffusori. Pali da 3,8 o da 5 metri.

Light emission



Colours

Structure:
grey.
Diffuser:
transparent.

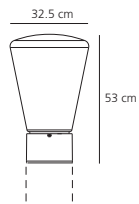

Timpone axial (for pole mounting)

METAL HALIDE 1x70W (E 27) – HIE



METAL HALIDE 1x100W (E 27) – HIE



SODIUM VAPOUR 1x100W (E 40) – HSE

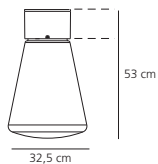

Timpone lateral (for arm mounting)

METAL HALIDE 1x70W (E 27) – HIE



METAL HALIDE 1x100W (E 27) – HIE



SODIUM VAPOUR 1x100W (E 40) – HSE



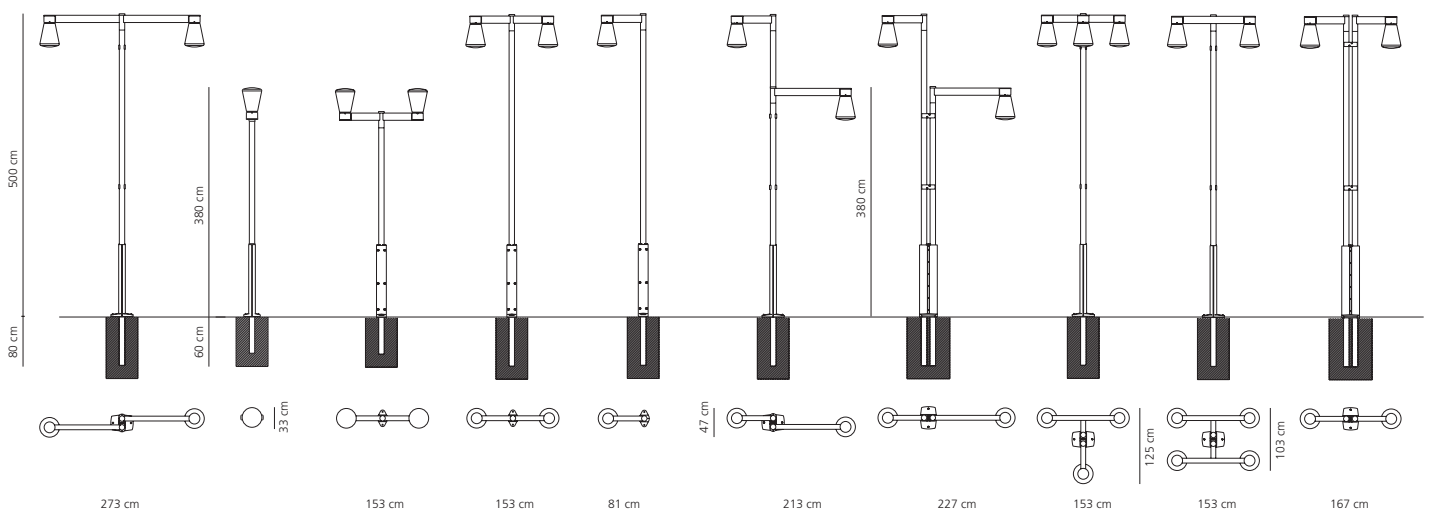

MODULO
ELECTRO
www.modulelectro.ru





MODUL
ELECTRO
www.modulelectro.ru

Modern classic

 **MODUL** 
ELECTRO
www.modulelectro.ru





314
Alfa



315
Eclisse



316
Lesbo



317
Nesso



318
Patroclo



319
Boalum





320
Chimera Mezzachimera



320



321
Fato

 **MODUL** 
ELECTRO
www.modulelectro.ru

Alfa

design

Sergio Mazza
1959



Materiali: struttura in metallo nichelato opaco; diffusore in cristallo; base in marmo. Parti metalliche tornite a mano.

Light emission



Colours

- Base: black
- Structure: mirror
- Diffuser: white

Materials

Metal structure in opaque nickel-plate; diffuser in crystal glass; base in marble. The metal parts are hand turned.

Matériaux

Structure en métal nickelé mat ; diffuseur en verre ; base en marbre. Les parties métalliques sont tournées à la main.

Materialien

Rahmen aus matt vernickeltem Metall; Leuchtschirm aus Kristall. Sockel aus Marmor. Die Metallteile sind handgedreht.

Materiales

Estructura de metal niquelado mate; difusor de cristal; base de mármol. Las piezas metálicas están torneadas a mano.

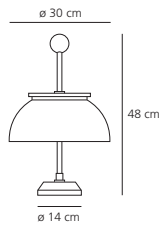

INC max 2x40W (E 14) – D 45

IP20 Dimmer

MODULO **ELECTRO**
www.modulelectro.ru



Eclisse

design

Vico Magistretti
1967



Materiali: metallo verniciato.
Specificità: installabile anche a parete.

Light emission



Colours



Polished white



Polished orange



Silver grey

Materials

Painted metal.

Specificity

Wall mounting possibility.

Matériaux

Métal verni.

Spécificité

Fixation possible en applique.

Materialien

Lackiertem Metall.

Spezifikation

Wandmontage möglich.

Materiales

Metal pintado.

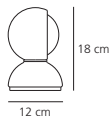

Especificaciones

Posibilidad de instalación a pared.



INC max 1x25W (E 14) – D 45

IP20

 **MODUL** 
ELECTRO
www.modulelectro.ru

Awards

Awards

Compasso d'Oro/ADI
XIV Triennale di Milano
1967 – Milano (Italia)

Museums

Twentieth Century Design Collection
of the Metropolitan Museum of Art
New York (US)

Design Collection of the Museum
of Modern Art – New York (US)

Itinerario Storico Permanente
Museo Nazionale della Scienza
e della Tecnica L. da Vinci
Milano (Italia)

Sezione Design
Civica Galleria d'Arte Moderna
Gallarate (Italia)

The Denver Art Museum
Denver (Colorado, US)

The Israel Museum – Jerusalem (Israel)

Musée des Arts Décoratifs
de Montréal – Montréal (Canada)

Museo Permanente del Design Italiano
1945/1990 – Triennale di Milano
Milano (Italia)

Galleria Nazionale d'Arte Moderna
Roma (Italia)



Lesbo

design

Angelo Mangiarotti
1967



Materiali: corpo e diffusore in vetro Murano soffiato-sfumato, base in metallo lucidato.

Light emission



Colour



White

Materials

Body and diffuser in blown smoked Murano glass; base in polished metal.

Matériaux

Corps et diffuseur en verre de Murano soufflé ; base en métal poli.

Materialien

Körper und Leuchtschirm aus opalweißem, mundeblasenem Muranoglas; Sockel aus poliertem Metall.

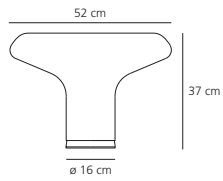

Materiales

Cuerpo y difusor de cristal de Murano ahumado-soplado, base de metal pulido.



HALO max 1x70W (E 27) – ES

IP20     Dimmer

 **MODUL** 
ELECTRO
www.modulelectro.ru



Nesso

design

Giancarlo Mattioli
Gruppo architetti urbanisti città nuova
1967



Materiali: base e diffusore in resina ABS stampata ad iniezione in stampi cromati.

Light emission



Colours



White



Orange

Materials

Base and diffuser in ABS resin, injection moulded in chromed moulds.

Matériaux

Base et diffuseur en résine ABS, injection dans des moules en chrome.

Materialien

Sockel und Leuchtschirm ABS-Kunstharz, das im Spritzgussverfahren in verchromten Gussformen hergestellt wird.

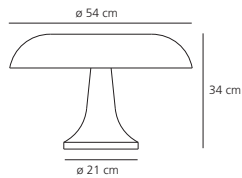

Materiales

Base y difusor de resina ABS, moldeados por inyección en moldes cromados.



INC max 4x25W (E 14) – D 45



 **MODUL** 
ELECTRO
www.modulelectro.ru

Awards

1° Premio Concorso
Studio Artemide/Domus
1965 – Milano (Italia)

Museums

Twentieth Century Design Collection
of the Metropolitan Museum of Art
New York (US)
Design Collection of the Museum
of Modern Art – New York (US)
The Denver Art Museum
Denver (Colorado, US)
The Israel Museum – Jerusalem (Israel)
Musée des Arts Décoratifs de Montréal
Montréal (Canada)
Museo Permanente del Design Italiano
1945-1990 – Triennale di Milano
Milano (Italia)



Patroclo

design

Gae Aulenti
1975



Museums

Twentieth Century Design Collection
of the Metropolitan Museum of Art
New York (US)
The Denver Art Museum
Denver (Colorado, US)

Light emission



Colour



Trasparent

Materiali: corpo in vetro soffiato trasparente con parte del diffusore rivestita da un'armatura metallica romboidale irregolare. L'armatura è ottenuta con la saldatura di fili d'acciaio resistenti al calore del vetro che viene soffiato a mano nella gabbia.

Specificità: il vetro così sfaccettato produce una texture luminosa sulle pareti.

Materials

Body in transparent blown glass with the diffuser partially covered by an irregular rhomboid metal frame. The frame is created by welding steel wire that is resistant to the heat of the glass which is blown within the cage.

Specificity

The glass is then faceted to light a space with mottled light.

Matériaux

Corps en verre soufflé transparent avec un diffuseur revêtu d'une armature métallique rhomboïdale irrégulière. L'armature est réalisée grâce au soudage de fils d'acier résistant à la chaleur du verre qui est soufflé dans la cage.

Spécificité

Ainsi taillé en facettes, le verre éclaire la pièce avec des effets tachetés.

Materialien

Gehäuse aus durchsichtigem, geblasenem Glas, das mit einem unregelmäßigen, rhomboiden Metallnetz verkleidet ist.

Spezifikation

Das Glas wird durch das Netz mundgeblasen und verschmilzt miteinander.

Materiales

Cuerpo de cristal soplado transparente con la parte de difusor forrada de un armazón metálico en forma de rombo irregular. El armazón se consigue soldando hilos de acero resistentes al calor del cristal, que se sopla en la caja.

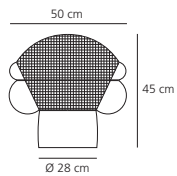

Especificaciones

El cristal tallado de esta manera ilumina la habitación con signos diferentes.



HALO max 1x70W (E 27) – ES

IP20    +  Dimmer

 **MODUL** 
ELECTRO
www.modulelectro.ru

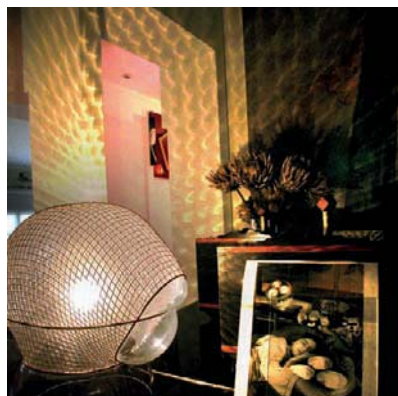

Boalum

design

Livio Castiglioni
Gianfranco Frattini
1970



Awards

BIO 5 – Honour Nomination
1975 – Ljubljana (Slovenia)

Museums

Musée des Arts Décoratifs de Montréal Montréal (Canada)

Museo Permanente del Design Italiano 1945-1990 – Triennale di Milano Milano (Italia)

Light emission



Colour



White

Materiali: struttura in plastica bianca flessibile rinforzata e terminali in resina.
Specificità: le piccole lampadine a siluro sono collegate in serie l'una all'altra e distanziate da una sfera isolante. I diversi elementi sono collegabili in serie fino ad un massimo di 4 pezzi per uno sviluppo di 8 metri circa e arrotolabili a piacere.

Materials

Structure in reinforced flexible white plastic with ends in resin.

Specificity

The small torpedo lamps are connected to each other in series and separated by an insulating sphere. Up to 4 individual sections may be connected to each other in series to make a length of 8 metres which may be wound into any shape.

Matériaux

Structure en plastique blanc flexible renforcée et extrémités en résine.

Spécificité

Les petites ampoules à siluro sont raccordées en série les unes aux autres et séparées par une boule isolante. Les différents éléments flexibles sur toute leur longueur peuvent se raccorder pour composer un ensemble de 4 pièces d'environ 8 mètres. Emission lumineuse diffuse.

Materialien

Rahmen aus weißem, flexiblem Kunststoff und Endstücke aus Kunstharz.

Spezifikation

Die hintereinander liegenden kleinen Torpedolampen sind miteinander verbunden, zwischen ihnen liegt je eine isolierende Kugel. Maximal 4 Leuchten mit einer Gesamtlänge von 8 m lassen sich zusammenstecken. Boalum kann beliebig zusammengerollt werden. Diffuse Lichtverteilung.

Materiales

Estructura de plástico blanco flexible reforzado y terminales de resina.

Especificaciones

Las pequeñas bombillas en forma de siluro están unidas en serie la una con la otra y distanciadas por una esfera aislante. Los elementos se pueden unir en serie hasta un máximo de 4 piezas, con un desarrollo de unos 8 metros, pudiéndolos enrollar a su gusto.

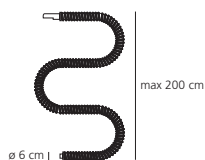

INC max 25x5W/12V, included

IP20    

MODUL
ELECTRO
www.modulelectro.ru



Chimera Mezzachimera

design

Vico Magistretti
1969, 1970



Materiali: base in metallo verniciato; struttura/diffusore in metacrilato opalino curvato a caldo.

Light emission



Colour



White

Materials

Base in painted metal; structure/diffuser in heat-curved opal methacrylate.

Matériaux

Base en métal verni ; structure/diffuseur en méthacrylate opalin courbés à chaud.

Materialien

Sockel aus lackiertem Metall; Rahmen/Leuchtschirm aus opalem Metacrylat, heiß gebogen.

Materiales

Base de metal pintado; estructura/difusor de metacrilato opalino curvado en caliente.

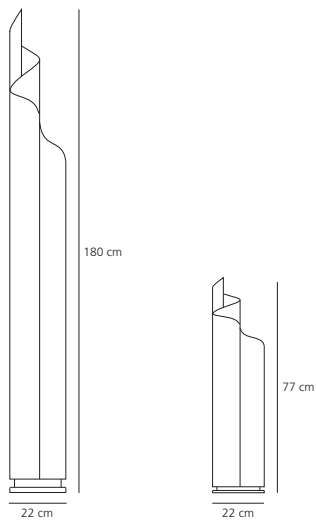

Chimera

FLUO 3 x 28W (G 5) - , included

IP20

Mezzachimera

HALO 3x60W (e 27) - QT 32

IP20





Materiali: struttura in lamiera piegata, saldata e smaltata bianca.

Specificità: questa lampada, con i suoi schermi metallici geometrici, le sue campiture di luce ed ombra, di vuoti e pieni, racchiusi in una cornice quadrata, si presenta come un oggetto luminoso dalla duplice funzione: lampada e insieme vetrina. Una scultura luminosa con una forte connotazione stilistica tipica degli anni 60.

Light emission



Colour



White

Materials

Structure in white enamelled, folded and welded plate. Indirect emission.

Specificity

A table or wall lamp, with geometrical metal screens creating light and dark, screened and clear, all enclosed in a square frame: it is both a light object and a lamp. A lighting sculpture with a strong styling connotation to the '60s.

Matériaux

Structure en tôle émaillée pliée et soudée blanche.

Spécificité

Avec ses écrans métalliques géométriques, ses peintures de fond de lumière et d'ombre, de pleins et de vides, renfermés dans un cadre carré, cette lampe de table ou applique se présente tel un objet lumineux multifonctions : lampe et vitrine évoquant une sculpture lumineuse dans les style typique des années 60.

Materialien

Rahmen aus weißem, gekrümmten, geschweißten und lackierten Metall.

Spezifikation

Die geometrischen Flächen in dem quadratischen Metallrahmen erzeugen ein attraktives Licht- und Schattenspiel. Fato ist Leuchte und Objekt zugleich. Ob Vitrine oder Tisch- oder Wandleuchte, Fato ist eine Lichtskulptur im typischen Stil der 60er Jahre. Eine Lichtskulptur mit einer starken stilistischen, Konnotation der 60er Jahre.

Materiales

Estructura de chapa esmaltada doblada y soldada blanca.

Especificaciones

Esta lámpara de sobremesa o de pared con sus pantallas metálicas geométricas, sus juegos de luz y sombras, vacío y llenos, encerrado en un marco cuadrado, se presenta como un objeto luminoso multiuso: lámpara y vitrina. Una escultura luminosa con una fuerte connotación estilística típica de los años 60.

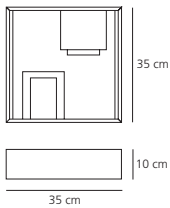

HALO max 2x18W (E 14) – ES



MODULO
ELECTRO
www.modulelectro.ru



Collezioni



MODUL
ELECTRO
www.modulselectro.ru



324
Leda sospensione 6



324
Leda sospensione 8



324
Leda sospensione 12



324
Leda sospensione 12+6



324
Leda parete 2



326
Pantalica
sospensione



326
Pantalica parete 2



326
Pantalica parete 3



328
Melissa



329
Fenice 8



329
Fenice 15



329
Fenice 20



330
Giocasta parete 1



330
Giocasta parete 2



330
Giocasta soffitto 3



330
Giocasta
sospensione

 **MODUL** 
ELECTRO

www.modulelectro.ru

Leda sospensione 6
Leda sospensione 8
Leda sospensione 12
Leda sospensione 12+6
Leda parete 2

design
 Örne Halloween
 1992, 1996



Materiali: bracci e coppette in vetro soffiato; tige in acciaio cromato lucido.
Specificità: nella versione sospensione, tige regolabile in altezza. Nella coppa inferiore è contenuta una lampadina.

Light emission



Colours



Rod:
mirror



Body and diffusers:
Milky white

Materials

Arms and bowls in blown glass; polished chrome-plated steel rod.

Specificity

Leda sospensione: rigid rod adjustable for different ceiling heights. The lower bowl is illuminated.

Matériaux

Bras et coupelles en verre soufflé ; tige en acier chromé.

Spécificité

Leda sospensione : tige rigide, adaptable aux différentes hauteurs de plafond. Dans la coupe inférieure est installée une source.

Materialien

Arme und Schalen aus transparentem mundgeblasenem Glas; Pendelstab aus poliertem Chromstahl.

Spezifikation

Leda sospensione: Höhenverstellbarer Stab. Das Leuchtmittel befindet sich in der unteren Glasschale.

Materiales

Metal y cristal soplado; brazos y copas de cristal soplado; tija de acero cromado.

Especificaciones

La versión de suspensión tiene una tija regulable en altura. La copa inferior contiene una bombilla.

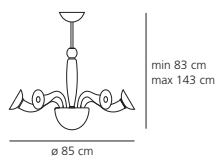

Leda sospensione 6

INC max 1x40W (E 14) – D 45
 INC max 6x60W (E 14) – D 45

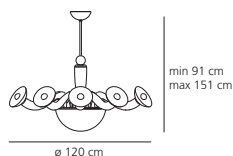

Leda sospensione 8

INC max 3x40W (E 14) – D 45
 INC max 8x60W (E 14) – D 45

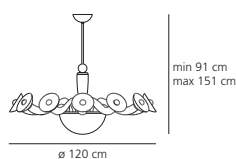

Leda sospensione 12

INC max 3x40W (E 14) – D 45
 INC max 12x60W (E 14) – D 45

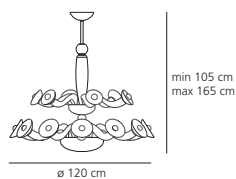

Leda sospensione 12+6

INC max 18x60W (E 14) – D 45



Leda parete 2

INC max 2x60W (E 14) – D 45

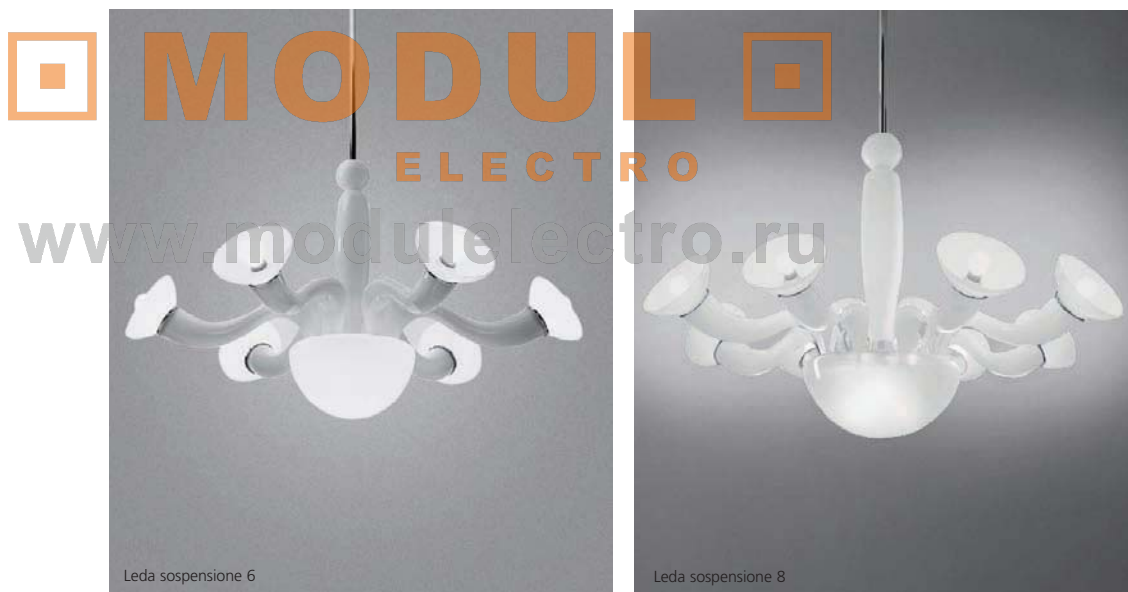

Leda sospensione 6

Leda sospensione 8



Leda sospensione 12



Leda parete 2



MODULO
ELECTRO

www.modulelectro.ru

Pantalica sospensione
Pantalica parete 2
Pantalica parete 3

design
 Örne Halloween
 1995, 1996



Materiali: bracci e coppette in vetro soffiato; tige in acciaio cromato lucido.
Specificità: nella versione sospensione, tige regolabile in altezza.

Light emission



Colours

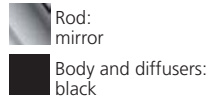

Materials

Arms and bowls in blown glass; polished chrome-plated steel rod.

Specificity

Pantalica sospensione: rigid rod adjustable for different ceiling heights.

Matériaux

Bras et coupelles en verre soufflé ; tige en acier chromé.

Spécificité

Pantalica sospensione : tige rigide, adaptable aux différentes hauteurs de plafond.

Materialien

Arme und Schalen aus transparentem mundgeblasenem Glas; Pendelstab aus poliertem Chromstahl.

Spezifikation

Pantalica sospensione: Höhenverstellbarer Stab.

Materiales

Metal y cristal soplado; brazos y copas de cristal soplado; tija de acero cromado.

Especificaciones

La versión de suspensión tiene una tija regulable en altura.

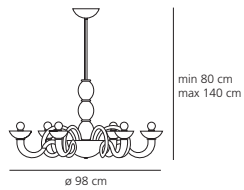

Pantalica sospensione
 INC max 6x60W (E 14) – D 45
 IP20 Ⓧ Ⓥ Ⓞ



Pantalica parete 2
 INC max 2x60W (E 14) – D 45
 IP20 Ⓧ Ⓥ Ⓞ



Pantalica parete 3
 INC max 3x60W (E 14) – D 45
 IP20 Ⓧ Ⓥ Ⓞ

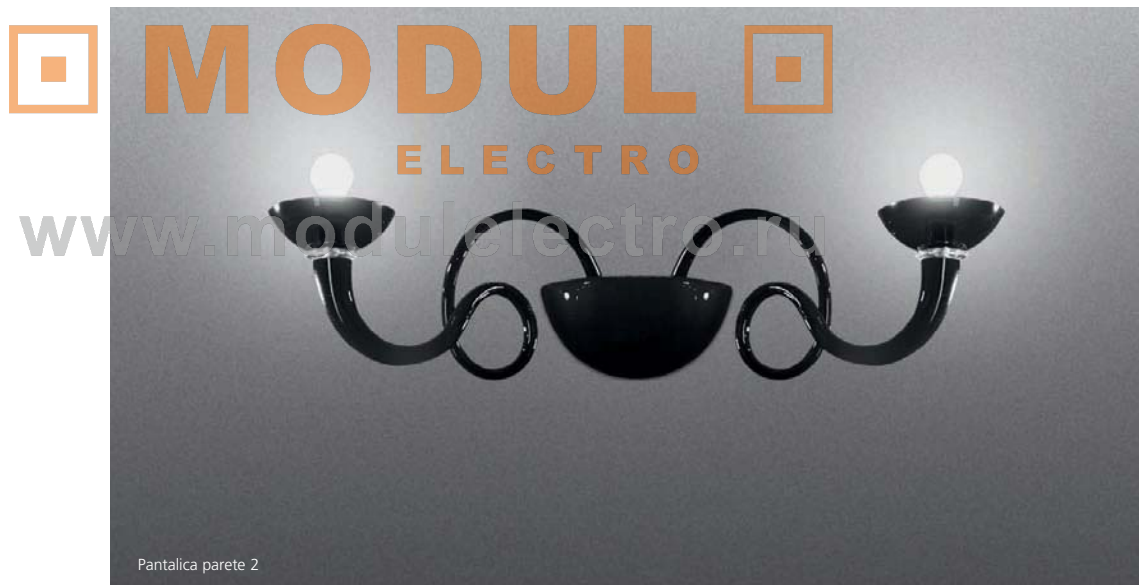

Pantalica parete 2



Pantalica parete 3



MODUL
ELECTRO
www.modulselectro.ru

Melissa

design
Toni Cordero
1991



Materiali: rosone, struttura a spirale e diffusore in acciaio cromato lucido. Sulla struttura sono disposti elementi in vetro cattedrale colorati e variamente tagliati in forme fra loro differenti.

Light emission



Colours



Structure:
mirror



Decorative glasses:
multicolor

Materials

Polished chrome-plated steel ceiling rose, structure and diffuser. Components in coloured cathedral glass cut in different shapes.

Matériaux

Rosace et structure spiralee en acier chromé. La structure est munie d'éléments teintés en verre de type vitrail de différentes formes.

Materialien

Rosette, Spiralelement und Schirm aus glanzpoliertem Chromstahl. An den Spiralen der Leuchte hängen mehrere Elemente aus buntem Glas in unterschiedlichen Formen.

Materiales

Difusor y estructura en espiral, de acero cromado lúcido. En la estructura destacan unos elementos de vidrio catedral, coloreados y cortados en formas diferentes.

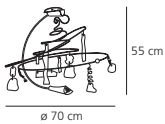

HALO max 1x205W (B 15d) – ECO



MODUL
ELECTRO
www.modulelectro.ru



Fenice 8
Fenice 15
Fenice 20

design
Renato Toso
Noti Massari & Associati
1996



Materiali: rosone in resina termoplastica verniciata metallizzata; diffusori, in vetro soffiato lavorato a lume.

Light emission



Colours

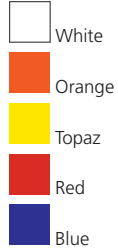

Materials

Ceiling rose in metal painted thermoplastic resin; diffusers in blown and handcraft glass.

Matériaux

Rosace en résine thermoplastique métallisée ; diffuseurs en verre soufflé travaillé à la main.

Materialien

Rosette aus metallic-lackiertem thermoplastischem Kunstharz. Kugel aus Kristallglas mit goldenen Partikeln und Schirme aus sandgestrahltem mundgeblasenem Glas.

Materiales

Rosetón de resina termoplástica pintada, con acabado metalizado; difusores de vidrio soplado recordando a los antiguos quinqués.

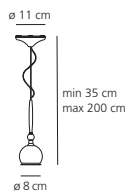

Fenice 8
HALO max 1x50W/12V (GY 6,35) - QT 12, included
IP20

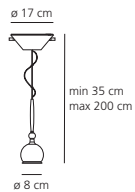

Fenice 8 with transformer
HALO max 1x50W/12V (GY 6,35) - QT 12, included
IP20

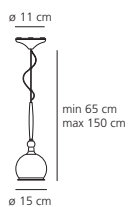

Fenice 15
HALO max 1x70W (B 15d) - ECO, included
IP20

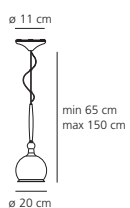

Fenice 20
HALO max 1x150W (B 15d) - ECO, included
IP20



Fenice 8

Fenice 20

Fenice 15

Giocasta parete 1
Giocasta parete 2
Giocasta soffitto 3
Giocasta sospensione

design
 Andrea Anastasio
 1992, 1995



Materiali: struttura in acciaio sabbiato e cromato; diffusori in vetro soffiato.

Light emission



Materials

Structure in sandblasted
 chrome-plated steel; diffusers
 in blown glass.

Matériaux

Structure en acier chromé poli ;
 diffuseurs en verre soufflé.

Materialien

Körper aus sandgestrahltem
 Chromstahl; Schalen aus
 mundgeblasenem Glas.

Materiales

Estructura de acero mate y
 cromado; copas de cristal
 soplado.

Giocasta parete 1



Milky white Yellow Green Blue

Giocasta parete 2

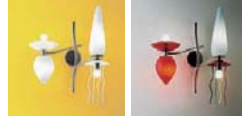

Milky white Multicolor

Giocasta soffitto 3



Milky white Multicolor

Giocasta sospensione



Milky white Multicolor

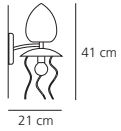

Giocasta parete 1

HALO max 1x28W (E 14) – ES
 HALO max 1x42W (E 14) – ES

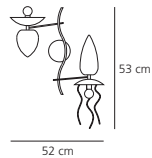

Giocasta parete 2

HALO max 2x28W (E 14) – ES
 HALO max 2x42W (E 14) – ES

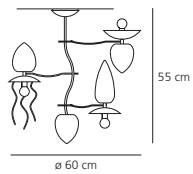

Giocasta soffitto 3

HALO max 4x28W (E 14) – ES
 HALO max 3x42W (E 14) – ES

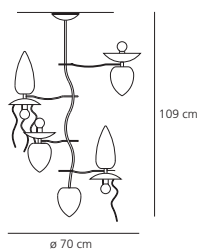

Giocasta sospensione

HALO max 5x28W (E 14) – ES
 HALO max 4x42W (E 14) – ES



Giocasta soffitto 3

Giocasta sospensione



Giocasta parete 1



Giocasta parete 2



MODUL
ELECTRO
www.modulelectro.ru

Itis

design
 Naoto Fukasawa
 2006



Premi / Musei
 Awards / Museums
 Prix / Musées
 Auszeichnungen / Museen
 Premios / Museos

Awards

Reddot Design Award
 "Best of the Best"
 2007 – Essen (Deutschland)
 Good Design Award
 The Chicago Athenaeum
 2007 – Chicago (US)

Museum

Die Neue Sammlung
 State Museum of Applied Arts
 and Design in the Pinakothek der Moderne
 München (Deutschland)

Materiale: base in zama verniciata; stelo in metallo verniciato; testa in metallo verniciato e policarbonato; diffusore in policarbonato trasparente satinato.
Specificità: due snodi collegano lo stelo rispettivamente alla base e alla testa consentendo l'inclinazione dello stelo da 0° a 90° e l'orientamento della testa di 180°.

Materials

Painted zamak base; painted metal stem; painted metal and polycarbonate head; satin transparent polycarbonate diffuser.

Matériaux

Base en zamac peint ; tige en métal peint ; tête en métal peint et polycarbonate ; diffuseur en polycarbonate transparent satiné.

Materialien

Sockel aus lackiertem Zamak; Stab aus lackiertem Metall; Leuchtenkopf aus lackiertem Metall und Polycarbonat; Schirm aus transparentem und satiniertem Polycarbonat.

Materiales

Base de zamak pintado; vástago de metal pintado y policarbonato; difusor de policarbonato transparente satinado.

Specification

Two articulations connect the stem to the base and the head which allow the stem to be tilted from 0° to 90° and the head to be rotated 180°.

Spécificité

Les deux articulations qui relient respectivement la tige à la base et à la tête permettent à la tige de s'incliner de 0° à 90° et à la tête de s'orienter de 180°.

Spezifikation

Die beiden Gelenke am Sockel und am Leuchtenkopf ermöglichen die Drehung des Schafies von 0° bis 90° und die Ausrichtung des Leuchtenkopfes um 180°.

Especificaciones

Las dos articulaciones, que unen el vástago con el pie y con la cabeza respectivamente, permiten inclinar el vástago de 0° a 90° y orientar la cabeza a 180°.

Emissione luminosa
 Light emission
 Emission lumineuse
 Lichtverteilung
 Emisión de luz

Light emission



Colours



Colori
 Colours
 Couleurs
 Farbe
 Colores

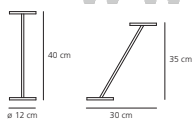

Dimensioni in cm
 Dimensions in cm
 Dimensions en cm
 Maße in cm
 Diseño acotado en cm

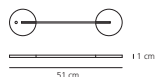

Sorgente luminosa
 Light source
 Source
 Leuchtmittel
 Lámpara

LED 5W, included
 (illuminance: max 800 lux, h. 35 cm)
 IP20 Touch Dimmer

Grado di protezione
 Protection degree
 Indice de protection
 Schutzart
 Grado de protección

Classe
 Class
 Classe
 Klasse
 Clase

Omologazioni
 Approvals
 Certifications
 Prüfzeichen
 Homologaciones



Reg. d'intensità luminosa
 Dimmer
 Var. d'intensité lumineuse
 Dimmer
 Dimmer



www.modulelectro.ru





Led	Protection degree	Class
<p>Tutti gli apparecchi Artemide con sorgenti Led sono stati testati secondo la norma IEC 62471:2006 sicurezza fotobiologica delle lampade.</p> <p>All Artemide fixtures mounting Led sources have been tested according to the standard IEC 62471:2006 photobiological safety of lamps.</p> <p>Tous les appareils Artemide utilisant des sources à Led ont été testés selon la norme IEC 62471:2006 sécurité photobiologique des lampes.</p> <p>Alle mit LED bestückten Artemide Leuchten wurden gemäß des IEC 62471:2006 (Standard für photobiologische Sicherheit von Lampen) getestet.</p> <p>Todos los aparatos Artemide con bombilla Led han sido testados según la norma IEC 62471:2006 seguridad fotobiológica de las lámparas.</p>	<p>IP...</p> <p>Gli apparecchi elettrici sono predisposti per impedire l'intrusione e il contatto di corpi solidi e liquidi con le parti in tensione. La resistenza alla penetrazione di solidi o liquidi è espressa dalla sigla IP, seguita da due numeri che esprimono il grado di protezione: la prima cifra è riferita ai corpi solidi, la seconda ai liquidi.</p> <p>Electric fittings are preset in order to prevent the intrusion and contact with solids and liquids with live parts. Resistance against the penetration of solids and liquids is expressed by the initials IP, followed by two digits that stand for the degree of protection: the first referring to solids, the second to liquids.</p> <p>Les appareils électriques sont conçus afin d'éviter toute intrusion ou contact de corps solides et liquides avec les parties sous tension. La résistance à la pénétration de solides ou liquides est exprimée par le sigle IP, suivi de deux chiffres qui expriment le degré de protection: le premier chiffre concerne les corps solides, le second les liquides.</p> <p>Die Leuchten sind ausgestattet, um das Eindringen und den Kontakt von Festkörpern und Flüssigkeiten zu verhindern. Hinter den Kennbuchstaben "IP" gibt die erste Kennziffer den Fremdkörperschutz an, die zweite Kennziffer den Schutz gegen Eindringen von Wasser.</p> <p>Los aparatos eléctricos están preparados para impedir la entrada y el contacto de cuerpos sólidos y de líquidos con las partes eléctricas. La resistencia a la penetración de sólidos y líquidos se expresa mediante las siglas IP seguidas de un número de dos dígitos que expresa el grado de protección: el primer dígito se refiere a los objetos sólidos, y el segundo, a los líquidos.</p>	<p></p> <p>Classe I - Class I - Classe I - Klasse I - Classe I</p> <p>Apparecchio nel quale la <i>sicurezza</i> elettrica è garantita da un conduttore supplementare di protezione (messa a terra) collegato alla struttura metallica della lampada.</p> <p>A light fitting whose safety is guaranteed by an additional protective conductor (earth) connected with the metal frame of the lamp.</p> <p>Appareil où la sécurité électrique est garantie par un conducteur supplémentaire de protection (mise à la terre) connecté à la structure métallique de la lampe.</p> <p>Beim Betrieb und bei der Wartung müssen alle berührbaren Metallteile der Leuchte, die im Fehlerfall Spannung annehmen können, leitend mit dem Schutzleiteranschluß verbunden sein.</p> <p>La seguridad eléctrica está garantizada por un cable protector adicional (toma de tierra) conectado a la estructura metálica del aparato.</p>

Light emission

	
Diretta Direct Directe Direkt Directa	Indiretta Indirect Indirecte Indirekt Indirecta





	
Diretta e indiretta Direct and indirect Directe et indirecte Direkt und indirekt Directa e indirecta	Diffondente Diffused Diffuse Gestreut Difusa









	
Oriutabile Adjustable Orientable Verstellbar Orientable	My White Light Metamorfosi

Approvals

	Certificazione di conformità europea Certification of European conformity Certificat de conformité à la norme Européenne Certificado de conformidad europeo
	Istituto Italiano del Marchio di Qualità Italian Institute of Quality Mark Institut Italien de la Marque de Qualité Italienisches Institut für Qualitätsmartsicherung Istituto Italiano de la Marca de Calidad
	Apparecchio idoneo al montaggio su superfici infiammabili Luminaire suitable for installation on inflammable surfaces Appareil utilisable sur les surfaces inflammables Gerät zum unmittelbaren Einbau in entflammbaren Flächen geeignet Aparato indicado para el montaje sobre superficies inflamables

Lamps typology

	
Lampade da tavolo Table lamps Lampes de table Tischleuchten Lámparas de sobre-mesa	Lampade da terra Floor lamps Lampadaires Stehleuchten Lámparas de pie
	
Lampade da parete Wall lamps Appliques Wandleuchten Appliques	Lampade da soffitto Ceiling lamps Plafonniers Deckenleuchten Pláfonos
	
Lampade a sospensione Suspension lamps Suspensions Pendelleuchte Lámparas de suspensión	

	Classe III - Class III - Classe III - Klasse III - Classe III
	Apparecchio in cui la protezione contro la scossa elettrica si basa sull'alimentazione a bassissima tensione di sicurezza e in cui non si producono tensioni superiori alla stessa. Nota: un apparecchio in classe III non deve essere provvisto di messa a terra di protezione.
	This light fixture is fitted with a protection device against electric shock that features a very low voltage power supply and prevents it from generating higher voltages. Note: a class III fixture does not have to be equipped with a protection grounding.
	Appareil dans lequel la protection contre les chocs électriques se base sur l'alimentation à très basse tension de sécurité et dans lequel ne se produisent pas de tensions supérieures à 50V. Note: un appareil classe III ne nécessite pas de mise à la terre.
	Diese Leuchte ist mit einer Schutzvorrichtung versehen, die einen Betrieb mit einer Schutzkleinspannung vorsieht und keine höheren Spannungen zuläßt. Bemerkung: eine Leuchte der Klasse III wird mit keiner Schutzerdung ausgestattet.
	Aparatos en los que la protección contra descargas eléctricas se basa en un sistema de alimentación de bajo voltaje que impide que se generen voltajes superiores. Nota: un aparato de clase III no debe equiparse con toma de tierra.
	GOST - Certificazione di conformità valida per la Federazione Russa GOST - Certification for Russian Federation GOST - Certificat de conformité pour la Fédération Russe GOST - Zertification nach der europäischen Norm für die russische Föderation GOST - Certificado de conformidad con validez para la Federación Rusa
	CCC - Certificazione di conformità valida per la Federazione Russa CCC - China Compulsory Certification CCC - Certificat de conformité pour la Chine CCC - Zertification nach der europäischen Norm für die China CCC - Certificado de conformidad con validez para la China

Арте

MODUL

ELECTRO

www.modulelectro.ru

midle®

MODUL

ELECTRO

www.modulelectro.ru

HEADQUARTERS

Artemide S.p.A.

Via Bergamo, 18
20010 Pregnana Milanese (MI), Italy
Tel. (+39) 02/93518.1 - 93526.1
Fax (+39) 02/93590254 - 93590496
Numero verde 800 834 093
info@artemide.com
www.artemide.com

ARCHITECTURAL DIVISION

Artemide Megalit SAS

Z.I. du Breuil
18400 Saint Florent sur Cher, France
Tél. (+33) 02/48 23 99 00
Fax (+33) 02/48 55 16 23
artemide.megalit@artemide.fr

ARGENTINA

Office and Showroom: Edimetra S.A.

Paraguay 792, 3rd floor
1057 Buenos Aires
Tel. (+54) 4312/4871
Fax (+54) 4312/4871
artemide@elsitio.net

AUSTRALIA

Artemide Australia

Australian Head Office & Showroom:

Artemide Adelaide
28 Fullarton Rd
Norwood SA 5067
Tel. (+61) 08 8362 3029
Fax (+61) 08 8362 2909
www.artemide.com.au
info@artemide.com.au

Sydney Office and Showroom: Artemide Sydney

504-508 Cleveland St,
Surry Hills NSW 2010
Tel. (+61) 02 9699 8472
Fax (+61) 02 9699 8492
www.artemide.com.au
sydney@artemide.com.au

Melbourne Office and Showroom: Artemide Melbourne

46-48 Rathdowne Street
Carlton VIC 3053
Tel. (+61) 03 9349 3310
Fax (+61) 03 9349 3320
www.artemide.com.au
melbourne@artemide.com.au

AUSTRIA

Office and Showroom:

Artemide Handelsgesellschaft mbH
Gonzagagasse 1 / Morzinplatz
1010 Wien
Tel. (+43) 01/803 21 82
Fax (+43) 01/803 21 82 20
info@artemide.at

BENELUX

(Belgium/Holland/Luxemburg)

Artemide Benelux

Beemdstraat 25
1601 Ruisbroek - Belgium
Tel. (+32) 02/334 84 50
Fax (+32) 02/378 12 17
artemide_benelux@artemide.com

Showroom and Lighting Consultancy Center:

Chaussée de Waterloo 410
1050 Brussels - Belgium
Tel. (+32) 02/534 03 67
Fax (+32) 02/534 32 01
artemide.brussels@skynet.be

CANADA

Head Office / Bureau Chef: Artemide Canada Ltée/Ltd.

11105 rue Renaude Lapointe
Montréal, Québec H1J 2T4
Tel. (+1) 514/323 6537
Fax (+1) 514/323 8864
Toll free (+1) 888 777 2783
info@artemide.ca

online store: www.artemide.ca

Showrooms:

440, rue Saint-Pierre
Montréal, Québec H2Y 2M5
Tel. (+1) 514/788 3788
Fax (+1) 514/788 4605
infoshowroommtl@artemide.ca

The Distillery Historic District

5 Mill Street, Building 37, Suite 101
Toronto, Ontario M5A 3R6
Tel. (+1) 416/628 6718
Fax (+1) 416/628 6827
infoshowroom@artemide.ca

CHINA

Office and Showroom:

Artemide Trading (Shanghai) Co., Ltd

Corporate Avenue Bldg, Tower 2,
Ground Floor/Shop 2
202 Hubin Road, Luwan District
200021 Shanghai
Tel. (+86) 21/6122 3408
Fax (+86) 21/6122 3410
info@artemide.cn

FRANCE

Head Office and Showroom: Artemide France Sarl

52, avenue Daumesnil
75012 Paris
Tél. (+33) 01/43 44 44 44
Fax (+33) 01/43 44 44 42
artemide@artemide.fr

GERMANY

Office and Showroom:

Artemide GmbH

Hans-Böckler-Straße 2
58730 Fröndenberg
Tel. (+49) 02373/975.0
Fax (+49) 02373/975.209
pr@artemide.de

Showroom:

Baseler Straße 10
60329 Frankfurt
Tel. (+49) 069/3399 5690
Fax (+49) 069/3399 56919

GREAT BRITAIN

Offices, Showroom and Lighting Consultancy Center: Artemide GB Ltd.

106 Great Russell Street
London WC1B 3NB
Tel. (+44) 020/7631 5200
Fax (+44) 020/7631 5222
info@artemide.co.uk

online store: www.artemidestore.co.uk

GREECE

Office and Showroom: Artemide Hellas S.A.

34, Solonos Str.
10 673 Athens
Tel. (+30) 210/364 6770.4.5
Fax (+30) 210/364 6823
info@artemide.gr

Showroom:

92, G. Papandreou Str.
54 665 Thessaloniki
Tel. (+30) 2310/403 934.5
Fax (+30) 2310/403 936

HONG KONG

Office and Showroom: Artemide Ltd.

Shop 111 Ruttonjee Centre
11 Duddell Street, Central
Hong Kong
Tel. (+852) 2523 0333 - 2882 6863
Fax (+852) 2845 0544 - 2882 6866
info@artemide.com.hk

ITALY

Artemide Italia S.r.l.

Via Bergamo 18
20010 Pregnana Milanese (MI)
Tel. (+39) 02/93518.1 - 93526.1
Fax (+39) 02/93590254 - 93590496
info@artemide.com

Showroom and Lighting Consultancy Center:

Via Manzoni 12
20121 Milano
Tel. (+39) 02/77871 2201 - 77871 2202
Fax (+39) 02/77871 2206
manzoni@artemide.com

Showrooms:

Corso Monforte 19
20122 Milano
Tel. (+39) 02/76006930 - 794039
Fax (+39) 02/794039
monforte@artemide.com

Via Margutta 107
00187 Roma
Tel. (+39) 06/36001802 - 36001808
Fax (+39) 06/36001810
margutta@artemide.com

Via Gaetano Filangieri 16/C
80121 Napoli
Tel. (+39) 081/4207283
Fax (+39) 081/4107563
filangieri@artemide.com

JAPAN

Artemide Japan K.K.

1104 Showamachi 2-1-16 Kita Ku
Tokyo 114-0011
Tel. (+81) 03/5492 4677
Fax (+81) 03/5692 4678
info@artemide.co.jp

RUSSIA

Artemide OOO

Bolshoj Zlatoustinskij Pereulok
Bldg 1, office 100
101000 Moscow
Tel. (+7) 495/984 2238
Fax (+7) 495/984 2239
info@artemide.ru

SCANDINAVIA

Artemide Scandinavia A/S

Strandvejen 66B
2900 Hellerup - Denmark
Tel. (+45) 7020 1700
Fax (+45) 7020 1701
info@artemide.dk

SOUTH KOREA

Office & Showroom: Artemide South Korea

Taeyang Bldg. 33-17, Nonhyun-dong,
Gangnam-gu Seoul Korea
Tel. (+82) 02 516 7083
Fax (+82) 02 516 7048
www.duomokorea.com
info@duomokorea.com

SPAIN

Artemide S.A.

C/Vico, 12-18
08021 Barcelona
Tel. (+34) 93/478 3911
Fax (+34) 93/370 7306
artemide@artemide.es

SWITZERLAND

Office and showroom: Artemide Illuminazione SA

Bären-gasse 16
8001 Zürich
Tel. (+41) 043/268 2727
Fax (+41) 043/268 2728
info@artemide.ch

UNITED ARAB EMIRATES

Representative Office: Artemide Middle East-Dubai Office

P.O. Box 18526 Dubai
LOB 16-204
Jebel Ali Free Zone
Tel. (+971) 4/887 2022
Fax (+971) 4/887 2023
artemide@eim.ae

U.S.A.

Headquarters, National Sales and Customer Service Center: Artemide Inc.

1980 New Highway
Farmingdale, NY 11735
Tel. (+1) 631/694 9292
Fax (+1) 631/694 9275
info@artemide.us

online store: www.artemidestore.com

Regional Showrooms & Customer Service Centers:

Atlanta, GA 30306
1011 Monroe Dr.
Atlanta, GA 30306
Tel. (+1) 404 881 6567
Fax (+1) 404 881 6805
atlanta@artemide.us

Boston, MA
343 Congress Street
Boston, MA 02210
Tel. (+1) 617 423 1450
Fax (+1) 617 423 1451
boston@artemide.us

Chicago, IL
223 West Erie Street
Chicago, IL 60654
Tel. (+1) 312 475 0100
Fax (+1) 312 475 0112
chicago@artemide.us
Dallas, TX
Dallas Design District
1621A Oak Lawn,
Dallas, TX 75207
Tel. (+1) 214 747 8344
Fax (+1) 214 747 1274
dallas@artemide.us

Denver, CO
(Area Sales office only)
7692 Bison Ct
Littleton, CO 80125
Tel. (+1) 303 683 0636
Fax (+1) 303 471 6536
denver@artemide.us

Honolulu, HI
Artemide @ HDC
1250 Kapiolani Blvd.
Honolulu, HI 96814
Tel. (+1) 808 956 1250
Fax (+1) 808 956 1255
info@honoluludesigncenter.com

Los Angeles, CA
9006 Beverly Blvd.,
West Hollywood, CA 90048
Tel. (+1) 310 888 4099
Fax (+1) 310 888 4098
losangeles@artemide.us

Miami, FL
277 Giralda Ave.
Coral Gables, FL 33134
Tel. (+1) 305 444 5800
Fax (+1) 305 444 5801
miami@artemide.us

New York, NY
46 Greene Street
New York, NY 10013
Tel. (+1) 212 925 1588
Fax (+1) 212 925 2429
newyork@artemide.us

Philadelphia, PA
232 North 2nd Street
Philadelphia, PA 19106
Tel. (+1) 215 733 9877
Fax (+1) 215 733 9878
philadelphia@artemide.us

San Diego, CA
301 4th Avenue
San Diego, CA 92101
Tel. (+1) 619 232 6072
Fax (+1) 619 232 6208
sandiego@artemide.us

San Francisco, CA
855 Montgomery Street
San Francisco, CA 94133
Tel. (+1) 415 393 9955
Fax (+1) 415 393 9959
sanfrancisco@artemide.us

Seattle, WA
310 Occidental Avenue S.
Seattle, WA 98104
Tel. (+1) 206 903 1511
Fax (+1) 206 903 1541
e-mail: seattle@artemide.us

St. Louis, MO
4727 McPherson Avenue
St. Louis, MO 63108
Tel. (+1) 314 361 0107
Fax (+1) 314 454 0112
stlouis@artemide.us

Washington D.C.
415 8th Street NW
Washington, D.C. 20004
Tel. (+1) 202 783 0133
Fax (+1) 202 783 9144
washingtondc@artemide.us

Per gli indirizzi dei distributori
Artemide nel mondo visitate il sito
www.artemide.com

For Artemide points of sale worldwide
visit our website www.artemide.com

Pour trouver les adresses des revendeurs
Artemide à travers le monde, visitez le site:
www.artemide.com

Die Adressen der Artemide Händler
weltweit finden Sie auf unserer Internetseite
www.artemide.com

Para las direcciones de los distribuidores
Artemide en el mundo visitad la página
www.artemide.com

Artemide Showrooms

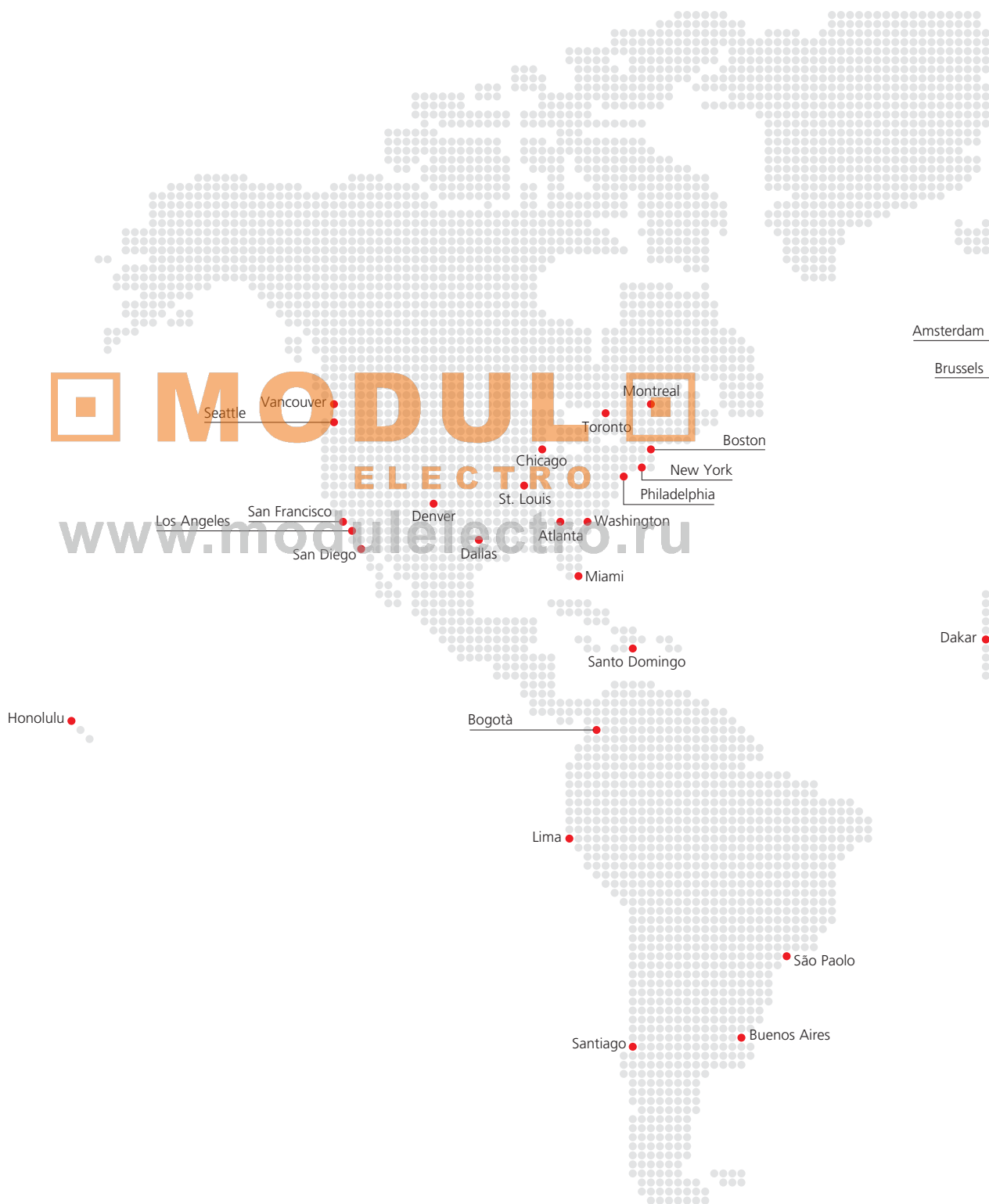

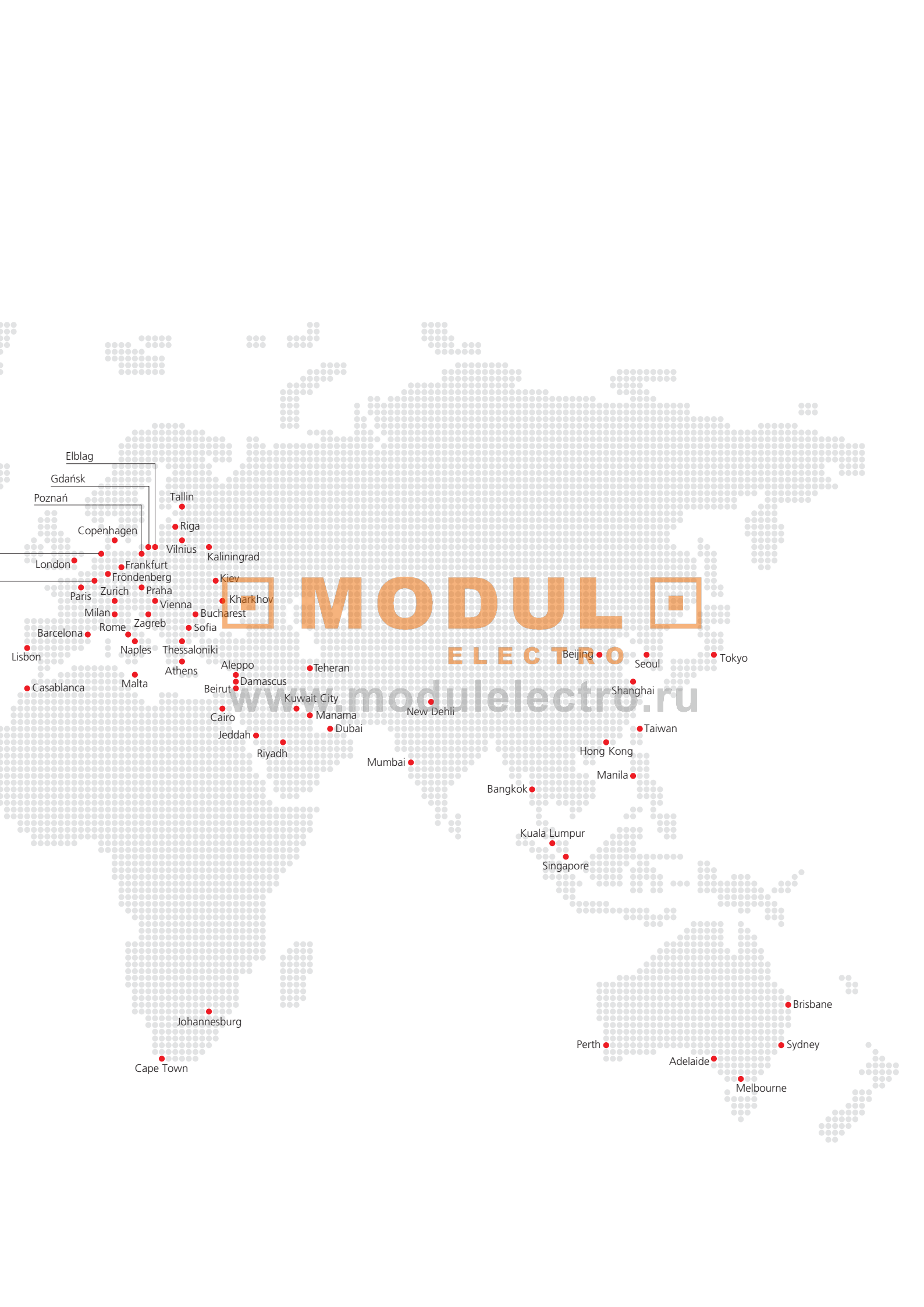

MODUL

ELECTRO

www.modulelectro.ru

Elblag
Gdańsk
Poznań
Copenhagen

Tallin
Riga
Vilnius
Kaliningrad

London
Frankfurt
Fröndenberg
Paris
Zurich
Prah
Milan
Rome
Zagreb
Barcelona
Naples
Thessaloniki
Athens
Aleppo
Beirut
Damascus
Cairo
Jeddah
Riyadh

Kiev
Kharkov
Bucharest
Sofia

Teheran
Kuwait City
Manama
Dubai
Mumbai

New Dehli

Beijing
Seoul
Tokyo

Shanghai
Taiwan
Hong Kong

Bangkok

Kuala Lumpur
Singapore

Johannesburg
Cape Town

Perth
Adelaide
Melbourne
Sydney
Brisbane

© Artemide S.p.A.

Photographers

Jean Pierre Maurer

Manuel Maurer

Miro Zagnoli

Ballo & Ballo

Amendolagine-Barracchia

Gio Pini

Oliviero Toscani

Marirosa Toscani Ballo

Page 36 Sala Consiliare Comune di Segrate - Italy - ph Beppe Raso
Page 36 National Theatre - Baku - Azerbaijan - Ph Khalid Ahmadov
Page 105 Watt Trdici Hotel - Milano - Italy - Ph Miro Zagnoli
Page 138 CB Richard Ellis - Frankfurt - Germany - Ph Fabian Aurel Hild
Page 146 Mediacal Praxis Dr Sabine Raulin - Karlsruhe - Germany - Ph Thomas A.Berger
Page 152 Spazio Teca - Milano - Italy - Ph Miro Zagnoli
Page 158 Sin - Aoyama - Japan - Ph Sergio Pirrone
Page 159 Kara Blanc - Tokyo - Japan - Ph Koji Horiuchi
Page 170 Steigenberger Hotel Therme, Meran - Italy
Page 178 Schelf Hotel - Büsum - Germany Ph Banck Studios
Page 184 Ristorante Il Corniolo - Cornaredo - Italy - Ph Miro Zagnoli
Page 187 Villa Borsig - Berlin - Germany - Ph Linus Lintner
Page 216 Hotel Ideal - Portugal
Page 220 CB Richard Ellis - Frankfurt - Germany - Ph Fabian Aurel Hild
Page 225 Wetzel House - Offenburg - Germany - Ph Linus Lintner
Page 228 Cantina Petra - Suvereto - Italy - Ph Miro Zagnoli
Page 230 Fraunhofer- Institut - Leipzig - Germany - Ph Günther Binsak
Page 237 Teatro Franco Parenti - Milano - Italy - Ph Miro Zagnoli
Page 258 Wetzel House - Offenburg - Germany - Ph Linus Lintner
Page 260 Eurizon - Milano - Italy - Ph Beppe Raso
Page 261 White Star Adventure - Milano - Italy - Ph Miro Zagnoli
Page 269 Watt Trdici Hotel - Milano - Italy - Ph Miro Zagnoli
Page 296 Indesit Company - Milano - Italy - Ph Miro Zagnoli
Page 311 Basisica di San Lorenzo - Milano - Italy - Ph Miro Zagnoli

Prepress

Actualtype s.r.l.

Print

Grafiche Moretti S.p.A.

March 2010

 **MODULO** 
ELECTRO

www.modulelectro.ru



Artemide S.p.A.
si riserva la facoltà di modificare, in qualunque momento e senza preavviso, le caratteristiche tecniche degli elementi illustrati nel presente catalogo.

Artemide S.p.A.
reserves the right to change, at any time and without prior warning, the technical specifications of any product illustrated in this catalogue.

Artemide S.p.A.
se réserve le droit de modifier, à n'importe quel moment et sans préavis, les caractéristiques techniques des éléments illustrés dans ce catalogue.

Artemide S.p.A.
behält sich das Recht vor jederzeit und ohne Ankündigung die technischen Daten der im Katalog abgebildeten Produkte zu ändern.

Artemide S.p.A.
se reserva la facultad de modificar, en cualquier momento y sin aviso previo, las características técnicas de los elementos ilustrados en el presente catálogo.



Winner European Design Prize '97



Compasso D'oro
1967-1989-1994-2004

MODULO
ELECTRO
www.modulelectro.ru

ELECTRO
www.modulelectro.ru