 **MODUL** 
ELECTRO
www.modulelectro.ru

AVMazzega *i* Moderni

AVMazzega *i* Moderni

MODUL

ELECTRO

www.modulelectro.ru

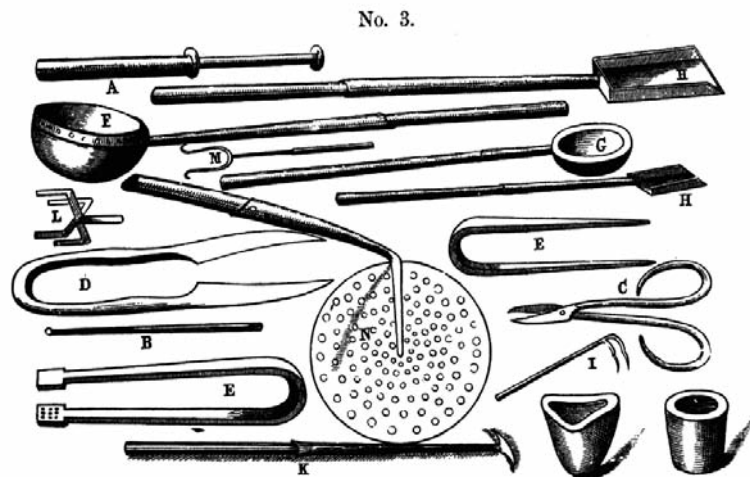

La perfetta imperfezione



Affondano nella nobile tradizione vetraria veneziana le radici di AVMazzega, fondata nel 1946 da Gianni Bruno Mazzega a Murano, terra di fornaci, di maestri, serventi e serventini che ancora oggi custodiscono secolari tecniche di lavorazione del vetro.

In oltre mezzo secolo AVMazzega, senza tradire le proprie origini, ha ravvivato e reinterpretato con passione e tenacia l'eredità muranese, invitando designers internazionali dagli eterogenei linguaggi espressivi a confrontarsi con le alchimie di sabbie, ossidi e polveri.

Il risultato è una sorprendente proposta di lampade in vetro che si confrontano con la contemporaneità in vibrante equilibrio tra arte ed industria, tradizione e modernità.

Perfect imperfect



The roots of AVMazzega lie in the noble Venetian glassworking tradition; the firm was founded in 1946 by Gianni Bruno Mazzega in Murano, a land of furnaces, masters and their assistants in the glassmaking process, known as “serventi” and “serventini”, who still today guard the age-old techniques for working the glass. In over half a century AVMazzega, without betraying its origins, has revived and reinterpreted the Murano heritage with passion and tenacity, inviting international designers with heterogeneous expressive languages to take on those alchemies of sands, oxides and powders.

The result is an amazing proposal of blown glass lamps that interact with contemporaneity, in vibrant equilibrium between art and industry, tradition and modernity.

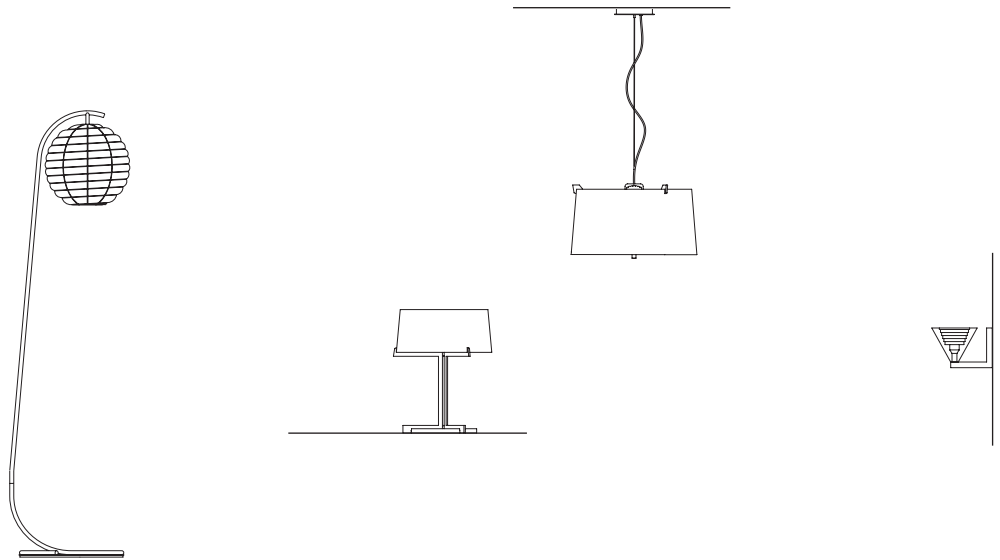

Designers

AVMazzega accompagna l'evolversi del gusto dell'abitare con una ragionata attenzione al mondo del design e della sperimentazione formale: numerosi designers collaborano con AVMazzega attivando competenze e relazioni che sono all'origine di oggetti entrati nella storia del vetro moderno; tra gli altri, Christophe Pillet, Michele DeLucchi, Jean Marie Massaud, Paolo Piva, Anki Gneib, Gordon Guillaumier e Nigel Coates.

www.modulelectro.ru



Designers

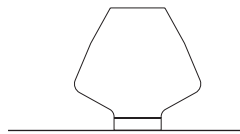

AVMazzega attentively follows changes in lifestyles and trends and is thus sensitive to design and formal experimentation: many designers have cooperated with AVMazzega, and this expertise and commitment have resulted in items that have become part of the history of modern glass. Among the others: Christophe Pillet, Michele DeLucchi, Jean Marie Massaud, Paolo Piva, Anki Gneib, Gordon Guillaumier and Nigel Coates.

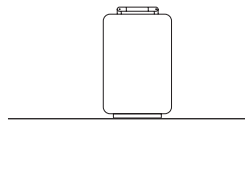



Per cielo, per terra, per mare

Grandi numeri, richieste speciali, ma anche realizzazioni ad hoc progettate dallo staff di Tecnici e progettisti di AVMazzega, in piena sintonia con l'immaginazione del committente.

Da semplici variazioni cromatiche, passando per lievi modifiche fino a vere e proprie soluzioni su misura, il grado di personalizzazione del servizio Contract è pensato per inseguire i sogni di progetti illuminotecnici che hanno intuito e sfruttano la duttilità e la magia del vetro.

Gli oggetti illuminanti AVMazzega viaggiano così per cielo per terra e per mare dialogando da protagonisti con spazi pubblici, alberghi, ristoranti, navi da crociera, aeroporti, musei, luoghi d'attesa.

By air, land and sea

Large numbers, special requests, but also ad hoc creations designed by the staff of technicians and designers at AVMazzega, fully in tune with customers' imaginations.

From simple chromatic variations, through slight modifications up to genuine made-to-measure solutions, the degree of personalization of the Contract supplies service is designed to pursue the dreams of lighting engineering projects that have the insight to exploit the ductility and magic of glass.

AVMazzega lighting objects therefore travel by air, land and sea, in a dialogue as protagonists with public spaces, hotels, restaurants, cruise ships, airports, museums and waiting areas.





MO
ELECTRO
www.mo

INDEX

Sospensioni Hanging lamps

- 064 **Mobile**
- 066 **Cocco**
- 068 **Frisbee**
- 070 **Forme**
- 072 **Hong Kong**
- 074 **Argo**
- 076 **Bios**
- 078 **Riflessi**
- 082 **Blow Up**
- 084 **Sixty**
- 090 **LS 150-153**
- 094 **White&Black**
- 096 **Point**
- 100 **Ola**
- 102 **Luna**
- 104 **Lilliput**

 **MODULO** 
ELECTRO
www.modulelectro.ru

Terra Floor lamps

- 036 **Mobile**
- 038 **Cocco**
- 040 **Frisbee**
- 042 **Argo**
- 044 **Hong Kong**
- 046 **Sezz Lamp**
- 048 **Riflessi**
- 050 **Sixty**
- 052 **Vaso XLS**
- 054 **Stand Up**
- 056 **White&Black**
- 058 **Sfinge**

Tavolo Table lamps

- 010 **Argo**
- 012 **Frisbee**
- 014 **Forme**
- 018 **Hong Kong**
- 020 **Air Can**
- 024 **Bios**
- 026 **Riflessi**
- 028 **Vaso S**
- 030 **Sixty**
- 032 **White&Black**

Soffitto Ceiling lamps

- 136 Cocco
- 138 White
- 140 Forme
- 142 Argo
- 144 Riflessi
- 146 Sixty
- 148 White&Black
- 150 Rio
- 152 Foglio
- 154 Trio
- 156 LP842/842T

Faretti Spot lamps

- 168 FR 6001
- FR 6002
- FR 6002/HA
- FR 6010
- FR 6011
- FR 6011/HA
- 169 LP 882
- LP 883
- LP 883/HA
- FR 6024
- FR 6024/HA
- 170 FR 6022
- FR 6022/HA
- FR 6013
- FR 6014
- FR 6014/HA
- 171 FR 6023
- FR 6023/HA
- FR 6016
- FR 6017
- FR 6017/HA

Parete Wall lamps

- 108 Cocco
- 110 Argo
- 112 White
- 114 Teia
- 116 Blow Up
- 118 Riflessi
- 120 Sixty
- 122 LP240-243
- 124 White&Black
- 126 Luna
- 128 Rio
- 130 Foglio
- 132 Lilliput

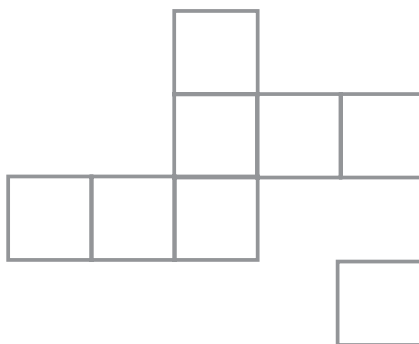

Modulari Modular lamps

- 160 LP 256-269
- 164 LP 276

MODUL
ELECTRO
www.modulelectro.ru

- 010 Argo
- 012 Frisbee
- 014 Forme
- 018 Hong Kong
- 020 Air Can
- 024 Bios
- 026 Riflessi
- 028 Vaso S
- 030 Sixty
- 032 White&Black





MODULO
ELECTRO
www.modulelectro.ru

Tavolo
Table lamps

Lampade da tavolo in vetro soffiato incamiciato con il lattimo.
 Struttura: metallo verniciato grigio grafite.
 Colore diffusore: bianco striato, rosso striato (solo TA 4073).

Colori / colours

-  bianco striato
striped white
-  rosso striato (solo TA 4073)
striped red (only TA 4073)

Blown glass table lamps in cased milk glass.
 Frame: graphite gray painted metal.
 Glass diffuser color: striped white, striped red (only TA 4073).

Argo

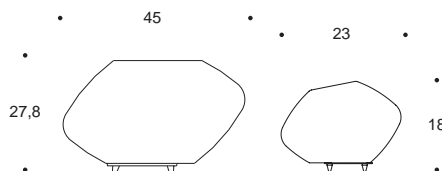

pag. 074 142

110



042

⁰¹⁰ design
 Claudio Marturano
 e Paolo Franzin



TA 4073 TA 4086
 ** *
 Kg 5,1 Kg 1,8

MODUL

ELECTRO

www.modulelectro.ru

Lampadine / Bulbs

- * E14
1X max 60W 230V
- 
- ** E27
1X max 150W 230V
- 

Classe II

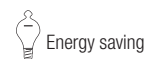

Argo

011



MODUL
ELECTRO
www.modulelectro.ru

Lampada da tavolo in vetro
soffiato incamiciato con il lattimo.
Struttura: metallo verniciato bianco.
Colore diffusore: bianco satinato.

Colori / colours

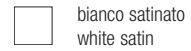

Blown glass lamp in cased milk glass.
Frame: white painted metal.
Glass diffuser color: white satin.

Frisbee

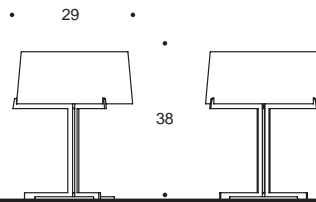

pag. 068

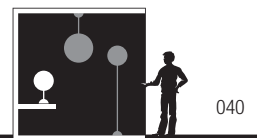

⁰¹² design
Christophe Pillet

TA 4087
*
Kg 2,5

MODULO
ELECTRO

www.modulelectro.ru

Lampadine / Bulbs

* E14
3X max 60W 230V



Classe II

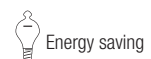



Energy saving



Frisbee

013

 **MODULO** 
ELECTRO
www.modulelectro.ru

 **MODULO** 
ELECTRO
www.moduloelectro.ru



Forme

015



 **MODULO** 
ELECTRO
www.modulelectro.ru



Lampada da tavolo
 in vetro soffiato, lavorato a mano.
 Struttura: metallo cromato.
 Colore diffusore: cristallo ballotton,
 bianco, bianco e filigrana nera.

Hand-crafted blown glass table lamp.
 Frame: polished chrome plated metal.
 Glass diffuser color: crystal "ballotton",
 white, white with internal black decorations.

Colori / colours

-  cristallo ballotton
crystal "ballotton"
-  bianco
white
-  bianco e filigrana nera
white with internal black decorations

Forme

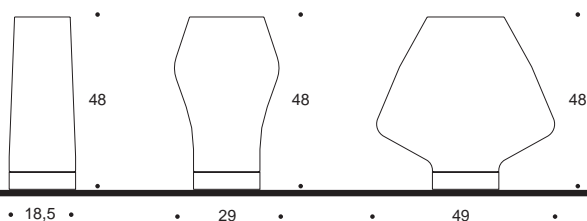

pag. 070 140



016 design
 Christophe Pillet

Forme A
 TA 4077
 Kg 3,3

Forme B
 TA 4079
 Kg 3,9

Forme C
 TA 4081
 Kg 4,9

MODUL
 ELECTRO

www.modulelectro.ru

Lampadine / Bulbs

* E27
 1X max 150W 230V



Classe II



 Energy saving

 **MODUL** 
ELECTRO
www.modulelectro.ru



Lampada da tavolo in vetro soffiato in gabbia.
Struttura: metallo cromato.
Colore diffusore: bianco.

Colori / colours



Hand-crafted in frame glass table lamp.
Frame: polished chrome plated metal.
Glass diffuser color: white.

TA 4085
*
Kg 3,8

pag. 072

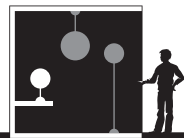



044

HongKong



018 design
Anki Gneib

• 33,2 •

 **MODULO** 
ELECTRO
www.modulelectro.ru

Lampadine / Bulbs

* E27
1X max 100W 230V



Classe II

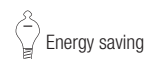

HongKong

019

 **MODUL** 
ELECTRO
www.modullectro.ru



020

 **MODUL**
ELECTRO
www.modulelectro.ru



Air can

021

MODUL
ELECTRO
www.modulelectro.ru



Lampada da tavolo in vetro soffiato
incamiciato con il lattimo.
Struttura: metallo nichelato e spazzolato.
Colore diffusore: bianco.

Colori / colours



Cased blown glass table
lamp in milk glass.
Frame: brushed nickel-plated metal.
Glass diffuser color: white.

TA 4027
*
Kg 2,7

TA 4028
**
Kg 4

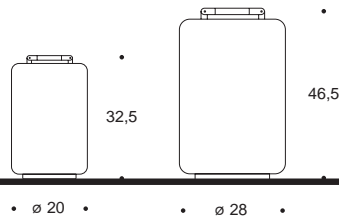

Air Can

022 design
Christophe Pillet

ELECTRO
www.modulelectro.ru

Lampadine / Bulbs

* E27
1X max 60W 230V



** E27
1X max 100W 230V



Classe II

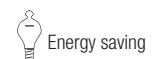



023

 **MODUL** 
ELECTRO
www.modulelectro.ru

Lampada da tavolo in vetro soffiato,
molato a mano.
Struttura: metallo cromato.
Colore vetri: cristallo.
N° vetri: 12

Colori / colours

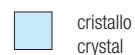

Hand-ground blown glass table lamp.
Frame: polished chrome plated metal.
Glass color: crystal.
Glass N°: 12

TA 4064

*

Kg 9,3

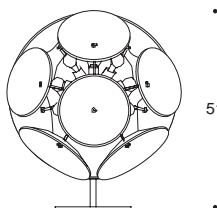

51

pag. 076



Bios

024 design
Oriano Favaretto

• ø 46 •

 **MODUL** 
ELECTRO

www.modulelectro.ru

Lampadine / Bulbs

* E14
6X max 40W 230V



Classe I

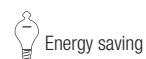



MODUL
ELECTRO
www.modul.electro.ru

Lampada da tavolo in vetro a piastra, lavorato a mano, satinato.

Struttura: metallo verniciato grigio.

Colore diffusore: cristallo satinato.

Colori fasce trasparenti: cristallo, ambra, rosso, argento.

Hand-crafted glass table lamp with satin finish.

Frame: grey painted metal.

Glass diffuser color: satin crystal.

Transparent bands colours: crystal, amber, red, silver.

Colori / colours

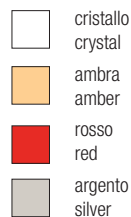

TA 4047

*

Kg 2,9

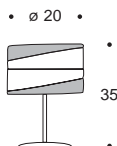

• ø 20 •

• ø 17 •

TA 4048

**

Kg 7,6

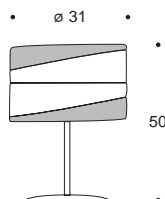

• ø 31 •

• ø 24 •

pag. 078 144

118



048

Riflessi

026 design
M & M

MODUL ELECTRO

www.modulelectro.ru



Lampadine / Bulbs

* E14

1X max 60W 230V



** E27

1X max 100W 230V



Classe II

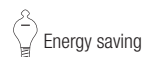

Riflessi

027

MODULO
ELECTRO
www.modulelectro.ru



Lampada da tavolo
in vetro soffiato incamiciato con il lattimo,
molato a mano.
Struttura: metallo inox satinato.
Colore diffusore: bianco.

Colori / colours



Hand-ground blown glass table lamp
in milk glass.
Frame: satin finish stainless steel.
Glass diffuser colour: white.

TA 4050
*
Kg 3,1

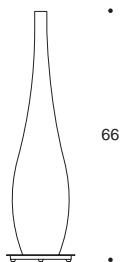

• ø 17 •

Vaso S



pag. 052

028 design
Christophe Pillet

www.modulelectro.ru

Lampadine / Bulbs

* E27
1X max 100W 230V

Classe I

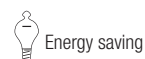

Vaso S

029

MODULO
ELECTRO
www.modulelectro.ru



Lampade da tavolo in vetro a piastra lavorato a mano.

Struttura: metallo cromato.

Colore diffusore: cristallo, rosso, nero.

N° vetri: 20 (TA 4067) 44 (TA 4068)

Hand-crafted glass table lamp.

Frame: polished chrome plated metal.

Glass color: crystal, red, black.

Glass N°: 20 (TA 4067) 44 (TA 4068)

Colori / colours

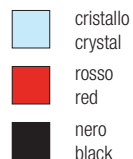

TA 4067

*

Kg 6

TA 4068

**

Kg 12

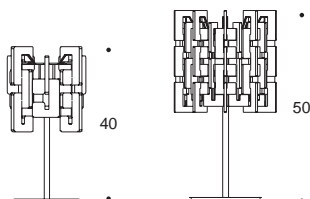

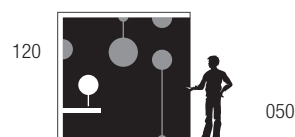

pag. 084 146



Sixty

030 design
Carlo Nason

• ø 20,5 • • ø 28 •

 **MODUL** 
ELECTRO
www.modulelectro.ru

Lampadine / Bulbs

* G9
1X max 60W 230V



** E27
1X max 100W 230V



Classe II





031

MODUL
ELECTRO
www.electro.ru

Lampada da tavolo in vetro soffiato incamiciato con il lattimo,
con striature lavorate a mano.

Struttura: metallo nichelato e satinato.

Colore diffusore: bianco e nero.

Colori / colours



Blown glass table lamp in milk glass, with handmade streaks.

Frame: brushed nickel plated metal.

Glassdiffuser colour: white and black.

TA 4037

*

Kg 1,9

• ø 21 •

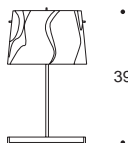

pag. 094 148

124



056

White&Black

• 15 •

032 design
M & M

 **MODUL** 
ELECTRO

www.modulelectro.ru

Lampadine / Bulbs

* E14
1X max 60W 230V



Classe II





033

MODULO
ELECTRO
www.modulelectro.ru

MODUL
ELECTRO
www.modulelectro.ru

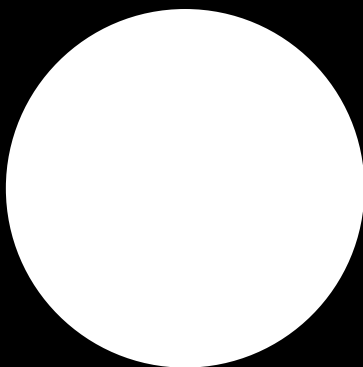

Terra
Floor lamps

MODULO

- 36 Mobile
- 38 Cocco
- 40 Frisbee
- 42 Argo
- 44 Hong Kong
- 46 Sezz Lamp
- 48 Riflessi
- 50 Sixty
- 52 Vaso XLS
- 54 Stand Up
- 56 White&Black
- 58 Sfinge

www.modulselectro.ru



Lampada da terra in vetro soffiato
lavorato a mano.
Struttura: metallo verniciato bianco.
Completa di variatore di luce.
Colore diffusore: bianco.

Hand-crafted blown glass lamp.
Frame: white painted metal.
Supplied with dimmer.
Glass diffuser color: white.

Colori / colours

 bianco
white

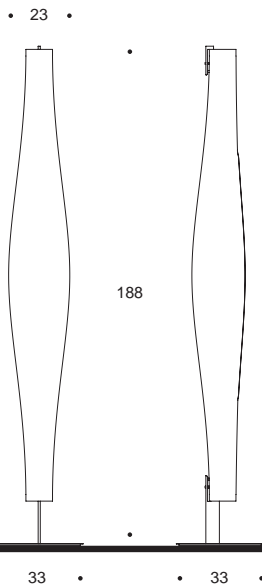

pag. 064



Mobile

⁰³⁶ design
Jean Marie Massaud

TE 5048
Kg 15



www.modulelectro.ru

Lampadine / Bulbs



* T5
2X max 80W 230V

Classe I





037

 **MODUL** 
ELECTRO
www.modulelectro.ru

Lampada da terra in vetro a
piastra lavorato a mano.
Struttura: metallo cromo.
Completa di variatore di luce.
Colore vetro: cristallo.
Colore paralume: bianco.

Colori vetro / glass colours

 cristallo
crystal

Hand-crafted glass floor lamp.
Frame: polished chrome.
Supplied with dimmer.
Glass color: crystal.
Lampshade color: white.



038

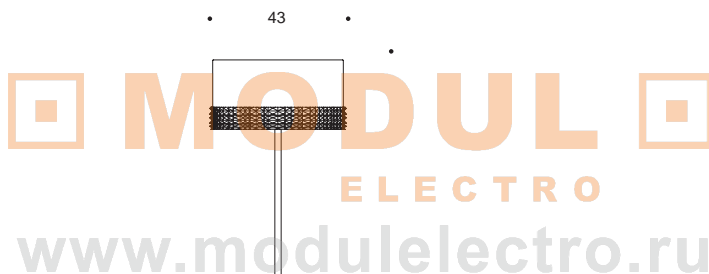

Cocco

design
M & M

TE 5050

*

Kg 16

pag. 066 136

108





Lampadine / Bulbs

* E27
3X max 75W 230V

Classe I

 Energy saving

 **MODUL** 
ELECTRO
www.modulelectro.ru



Lampada da terra in vetro soffiato
lavorato a mano.
Struttura: metallo verniciato bianco.
Completa di variatore di luce.
Colore vetro: bianco satinato.

Colori vetro / glass colours

 bianco satinato
white satin

Hand-crafted glass floor lamp.
Frame: white painted metal.
Supplied with dimmer.
Glass color: white satin.

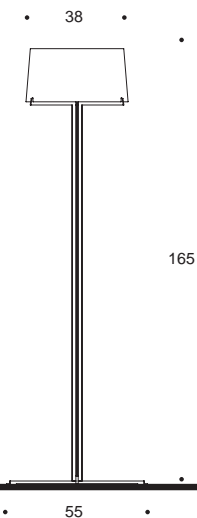

pag. 068



012

Frisbee

⁰⁴⁰ design
Christophe Pillet

TE 5049

 **MODULO** 
Kg 12
ELECTRO

www.modulelectro.ru

Lampadine / Bulbs

* E27
3X max 75W 230V

Classe I

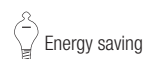



041

MODULO
ELECTRO
www.modulelectro.ru

Lampada da terra in vetro soffiato
incamiciato con il lattimo.
Struttura: metallo verniciato grigio grafite.
Completa di variatore di luce.
Colore diffusore: bianco striato, rosso striato.

Blown glass floor lamp in cased milk glass.
Frame: graphite gray painted metal.
Supplied with dimmer.
Glass diffuser color: striped white, striped red.

Colori / colours

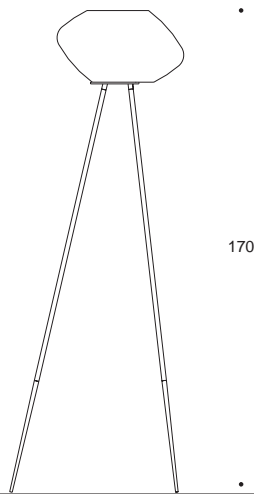

pag. 074 142



Argo

042 design
Claudio Marturano
e Paolo Franzin

66

TE 5046

*
Kg 12

MODUL
ELECTRO

www.modulelectro.ru



Lampadine / Bulbs

* E27
1X max 150W 230V

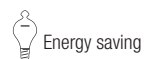

Classe II



 **MODUL** 
ELECTRO
www.modulelectro.ru



Lampada da terra in vetro soffiato in gabbia.
Struttura: metallo cromato.
Completa di variatore di luce.
Colore diffusore: bianco.

Colori / colours

 bianco
white

Hand-crafted blown in frame glass floor lamp.
Frame: polished chrome plated metal.
Supplied with dimmer.
Glass diffuser color: white.

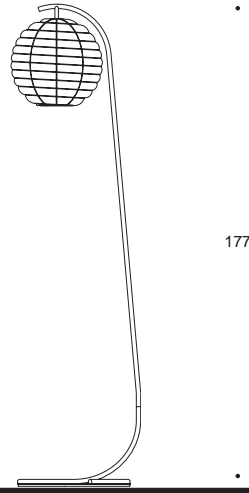

pag. 072

018

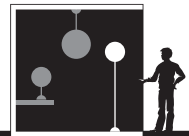

Hong Kong

⁰⁴⁴ design
Anki Gneib

41

TE 5047

*
Kg 13

 **MODUL** 
ELECTRO

www.modulelectro.ru

Lampadine / Bulbs

* E27
1X max 100W 230V



Classe II

 Energy saving



MODUL
ELECTRO
www.modul-electro.ru

Lampada da terra composta da due vetri soffiati.
Struttura: metallo inox satinato.
Completa di variatore di luce.
Colore diffusore: cristallo/bianco.

Colori / colours

 cristallo/bianco
crystal/white

Hand-ground blown glass floor lamp in milk glass,
two glasses.
Frame: satin finish stainless steel.
Supplied with dimmer.
Glass diffuser color: crystal/white.

046

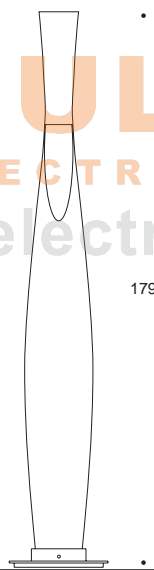
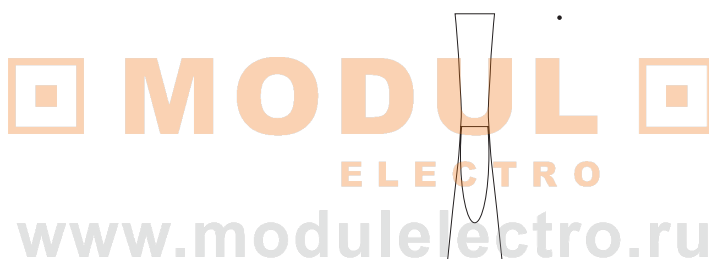

Sezz Lamp

design
Christophe Pillet

• 32 •

TE 5040

*

Kg 19,3



Lampadine / Bulbs

* E27 + E14
1X max 100W 230V + 3X max 40W 230V



Classe I

 Energy saving



047

MODUL
ELECTRO
www.modulelectro.ru

Lampada da terra in vetro a piastra lavorato a mano e satinato.
 Struttura: metallo verniciato grigio chiaro.
 Completa di variatore di luce.
 Colore diffusore: cristallo satinato.
 Colore fasce trasparenti: cristallo, ambra, rosso, argento.

Hand-crafted glass floor lamp with satin finish.
 Frame: grey painted metal.
 Supplied with dimmer.
 Glass diffuser color: satin crystal.
 Transparent bands colours: crystal, amber, red, silver.

Colori / colours

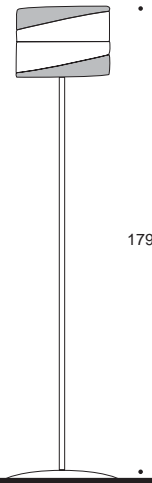
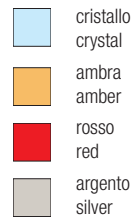

pag. 078 144

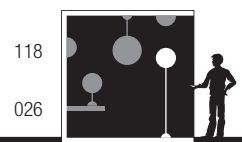

118
026

Riflessi

048 design
M & M

32

TE 5032

Kg 16,2

MODULO
ELECTRO

www.modulelectro.ru

Lampadine / Bulbs

* E27
1X max 150W 230V



Classe II

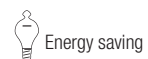



MODUL
ELECTRO
www.modulelectro.ru

Lampada da terra in vetro a piastra lavorato a mano.
Struttura: metallo cromato.
Completa di variatore di luce.
Colore vetri: cristallo, rosso, nero.
N° vetri: 90

Hand-crafted glass floor lamp.
Frame: polished chrome plated metal.
Supplied with dimmer.
Glass color: crystal, red, black.
Glass N°: 90

Colori / colours

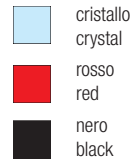

050

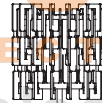
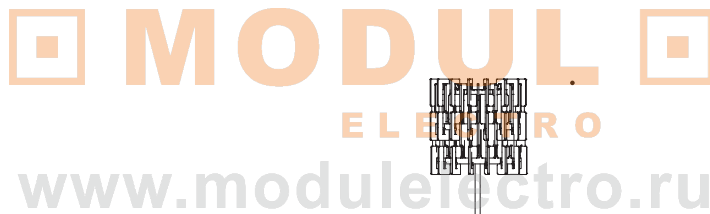

170

pag. 084 146

120

030



Sixty

design
Carlo Nason

• 35 •

TE 5044
*
Kg 20,2

Lampadine / Bulbs

* E27
1X max 150W 230V



Classe II

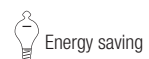



051

MODUL 
ELECTRO
www.modulelectro.ru

Lampada da terra in vetro soffiato incamiciato con il lattimo, molato a mano.

Struttura: metallo inox satinato.

Completa di variatore di luce.

Colore diffusore: bianco.

Colori / colours



Hand-ground blown glass floor lamp in milk glass.

Frame: satin finish stainless steel.

Supplied with dimmer.

Glass diffuser color: white.

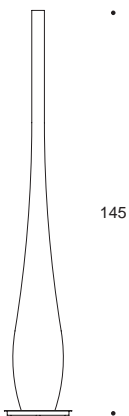

Vaso XLS

pag. 028



052 design
Christophe Pillet

• 24 •

TE 5036

*
Kg 8,2

 **MODULO** 
ELECTRO

www.modulelectro.ru

Lampadine / Bulbs

* E27
1X max 150W 230V



Classe I

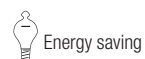

 **MODUL** 
ELECTRO
www.modulelectro.ru



Lampada da terra in vetro soffiato incamiciato con il lattimo, molato a mano.
Struttura: metallo nichelato e satinato.
Completa di variatore di luce.
Colore diffusore: bianco.

Colori / colours



Hand-ground blown glass floor lamp in milk glass.
Frame: satin finish nickel plated metal.
Supplied with dimmer.
Glass diffuser color: white.

054

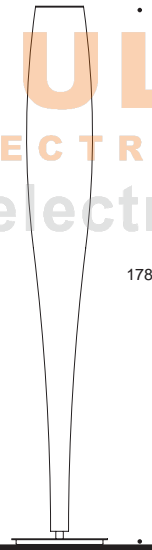
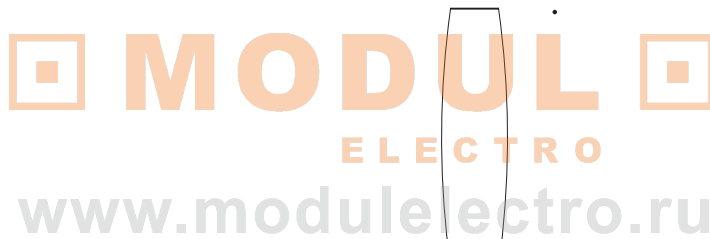

Lampadine / Bulbs

* E27
1X max 100W 230V



** E27
1X100W 230V



Classe I



Stand Up

design
Christophe Pillet

• 32 •

TE 5041

*

**

Kg 15,4

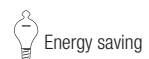

MODUL
ELECTRO
www.modulelectro.ru



Lampada da terra in vetro soffiato
 incamiciato con il lattimo con
 striature lavorate a mano.
 Struttura: metallo nichelato e spazzolato.
 Completa di variatore di luce.
 Colore diffusore: bianco e nero.

Blown glass floor lamp in milk glass
 with handmade streaks.
 Frame: brushed nickel plated metal.
 Supplied with dimmer.
 Glass diffuser color: white and black.

Colori / colours

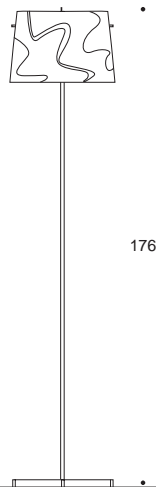

pag. 094 148



White&Black

056 design
 M & M

TE 5027

*
 Kg 8,1

MODUL
 ELECTRO

www.modulelectro.ru

Lampadine / Bulbs

* E27
 1X max 150W 230V



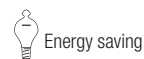

Classe II



MODUL
ELECTRO
www.modulelectro.ru



058



 **MODUL** 
ELECTRO
www.modulelectro.ru





Sfinge

059





 **MODUL** 
ELECTRO
www.modulelectro.ru



Lampada da terra in vetro soffiato
incamiciato con il lattimo.
Struttura: metallo verniciato grigio chiaro,
metallo cromato.
Completa di variatore di luce.
Colore diffusore: bianco, cristallo sfumato,
bianco e nero.

Cased blown glass floor lamp in milk glass.
Frame: grey painted metal, chrome plated metal.
Supplied with dimmer.
Glass diffuser color: white, crystal shading off into
white, white and black.

Colori / colours

-  bianco / struttura grigio chiaro
white / light grey frame
-  bianco / struttura cromo
white / chrome plated frame
-  cristallo sfumato / struttura cromo
crystal shading off into white / chrome
plated frame
-  bianco/nero / cromo
white/black / chrome plated frame

060

MODULO
ELECTRO
www.modulelectro.ru

Sfinge

design
M & M

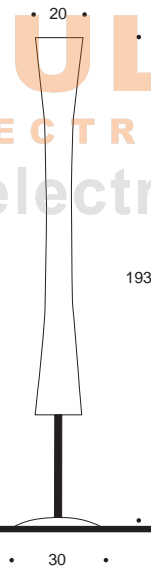

TE 5005
*
Kg 17,6



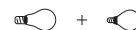

Lampadine / Bulbs

* E27 + E14
1X max 150W 230V + 3X max 40W 230V



Classe I



 **MODUL** 
ELECTRO
www.modulelectro.ru

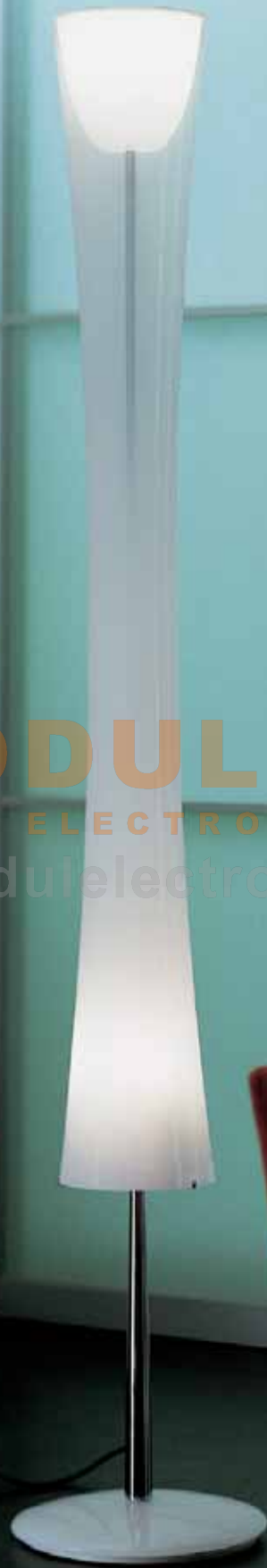

MODUL
ELECTRO
www.modulelectro.ru

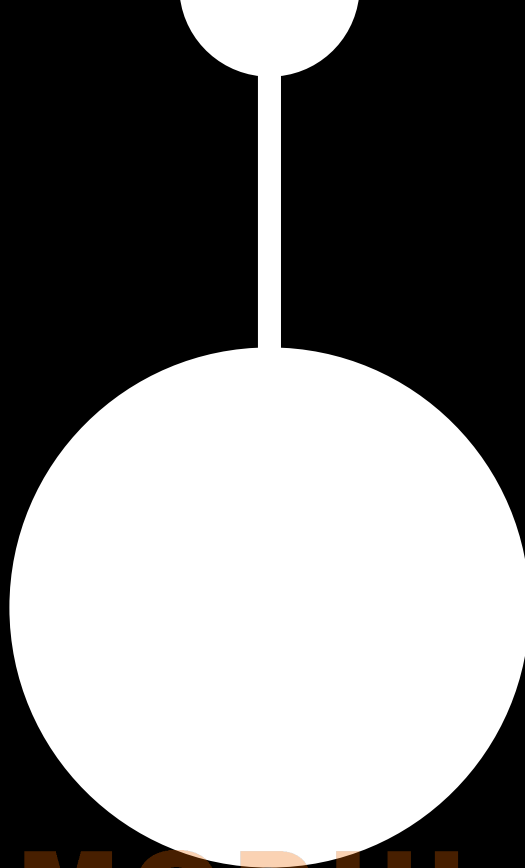

Sospensioni
Hanging lamps

MODUL
ELECTRO

www.modulelectro.ru

- 064 **Mobile**
- 066 **Cocco**
- 068 **Frisbee**
- 070 **Forme**
- 072 **HongKong**
- 074 **Argo**
- 076 **Bios**
- 078 **Riflessi**
- 082 **Blow up**
- 084 **Sixty**
- 090 **LS 150-153**
- 094 **White&Black**
- 096 **Point**
- 100 **Ola**
- 102 **Luna**
- 104 **Lilliput**

Sopensione in vetro soffiato
lavorato a mano.
Struttura: metallo verniciato bianco.
Fornita di ballast elettronico
dimmerabile.
Colore diffusore: bianco.

Colori / colours



Hand-crafted blown glass lamp.
Frame: white painted metal.
Supplied with dimmable
electronic ballast.
Glass diffuser color: white.

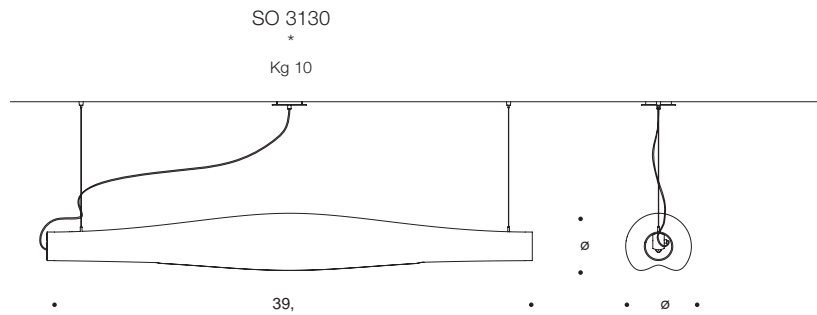

Mobile



pag. 036

⁰⁶⁴ design
Jean Marie Massaud

www.modulelectro.ru



Lampadine / Bulbs

* T5
2X max 80W 230V

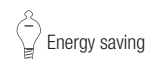
Classe I





 **MODUL** 
ELECTRO
www.modulelectro.ru

Sospensione in vetro a
piastra lavorato a mano.
Struttura: cromo.
Colore vetro: cristallo.
Colore paralume: bianco.

Colori / colours

 cristallo
crystal

Hand-crafted glass hanging lamp.
Frame: chrome.
Glass color: crystal.
Lampshade color: white.



SO 3129
*
Kg 5

SO 3133
*
Kg 6,5

pag. 066 136

108



038

Cocco

⁰⁶⁶ design
M & M

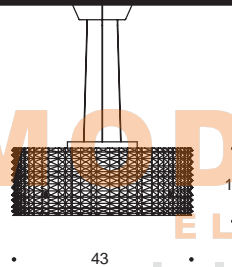
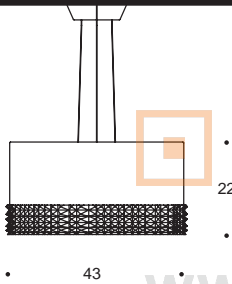

MODULO
ELECTRO

www.modulelectro.ru

Lampadine / Bulbs

* E27
3X max 75W 230V



Classe I



 Energy saving



MODUL
ELECTRO
www.modulselectro.ru

Sospensione in vetro soffiato
lavorato a mano.
Struttura: metallo verniciato bianco.
Colore vetro: bianco satinato.

Colori vetro / glass colours

 bianco satinato
white satin

Hand-crafted glass hanging lamp.
Frame: white painted metal.
Glass color: white satin.

SO 3132
*
Kg 4

pag. 068



012

040

Frisbee

⁰⁶⁸ design
Christophe Pillet

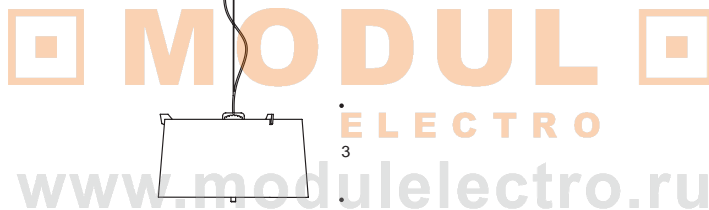

Lampadine / Bulbs

* E27
3X max 75W 230V

Classe I

• ø0 •

MODUL
ELECTRO

www.modul.electro.ru



Sospensione in vetro soffiato,
lavorato a mano.

Struttura: metallo cromato.

Colore diffusore: bianco,
bianco e filigrana nera.

Hand-crafted blown hanging glass lamp.

Frame: polished chrome plated metal.

Glass diffuser color: white,
white with internal black decorations.

Colori / colours



bianco
white



bianco e filigrana nera
white with internal black decorations

SO 3131

*

Kg 4

pag. 070 140



014

Forme

⁰⁷⁰ design
Christophe Pillet

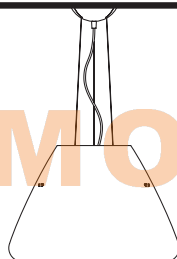

MODULO
ELECTRO

www.modulelectro.ru

Lampadine / Bulbs



* E27
1X max 100W 230V



Classe II



071

 **MODUL** 
ELECTRO
www.modulelectro.ru

Sospensione in vetro soffiato in gabbia.
Struttura: metallo cromato.
Colore diffusore: bianco.

Colori / colours



Hand blown in frame glass hanging lamp.
Frame: polished chrome plated metal.
Glass diffuser color: white.

SO 3123
*
Kg 3

SO 3124
*
Kg 5

pag. 072

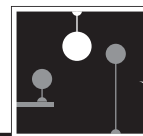

HongKong

072 design
Anki Gneib

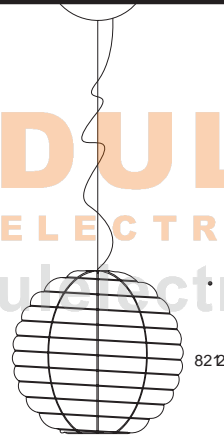
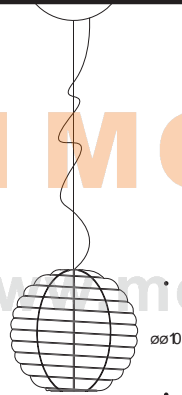
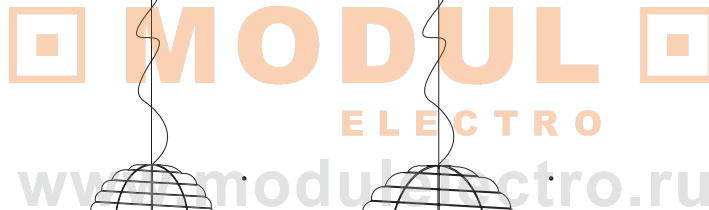

Lampadine / Bulbs

* E27
1X max 100W 230V



Classe II

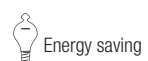

 **MODUL** 
ELECTRO

www.modul.electro.it



Sospensione in vetro soffiato
incamiciato con il lattimo.
Struttura: metallo verniciato grigio grafite.
Colore diffusore: bianco striato, rosso striato.

Blown glass hanging lamp in cased milk glass.
Frame: graphite gray painted metal.
Glass diffuser color: striped white, striped red.

Colori / colours

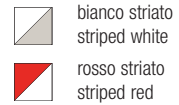

Argo

SO 3120
*
Kg 5,3

pag. 074 142

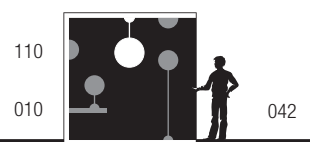

074 design
Claudio Marturano
e Paolo Franzin

MODULO
ELECTRO
www.modulelectro.ru



Lampadine / Bulbs

* E27
3X max 60W 230V

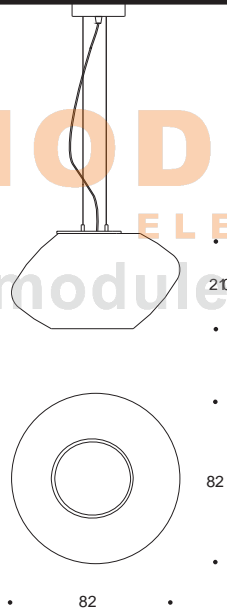

Classe I



 **MODUL** 
ELECTRO
www.modulelectro.ru



Sospensione in vetro soffiato, molato a mano.
Struttura: metallo cromato.
Colore vetri: cristallo.
N° vetri: 12 (SO 3102) 31(SO 3103)

Colori / colours

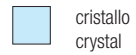

Hand-ground blown glass hanging lamp.
Frame: polished chrome plated metal.
Glass color: crystal.
Glass N°: 12 (SO 3102) 31(SO 3103)

Bios

SO 3102

*

Kg 8,6

• 548 •

SO 3103

**

Kg 22,7

• 548 •

pag. 036



076 design
Oriano Favaretto

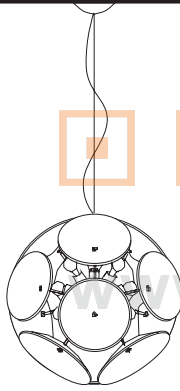

• 548 •

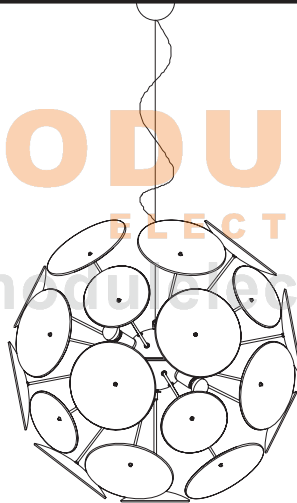

• 540 •

MODUL ELECTRO
www.modul-electro.ru

Lampadine / Bulbs

* E14
12X max 40W 230V



** E14
10X max 40W 230V



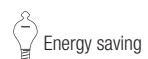

Classe I







MODUL
ELECTRO
www.modul.com

 **MODUL** 
ELECTRO
www.modul-electro.ru

Riflessi

079

 **MODULO** 
ELECTRO
www.modulelectro.ru

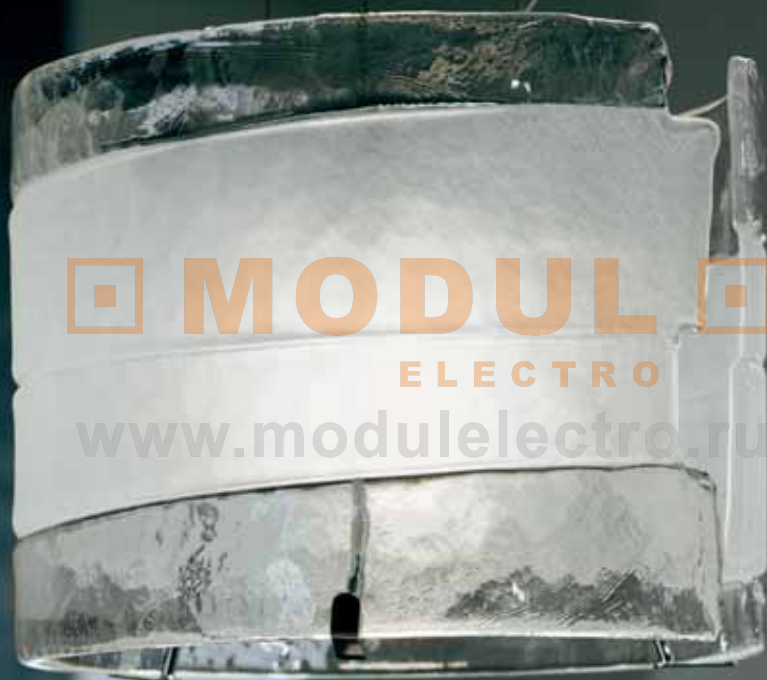

Sospensione in vetro a piastra, lavorato a mano, satinato.
 Struttura: metallo cromato.
 Colore diffusore: cristallo satinato.
 Colori fasce trasparenti: cristallo, ambra, rosso, argento.

Hand-crafted glass hanging lamp with satin finish.
 Frame: polished chrome plated metal.
 Glass diffuser color: satin crystal.
 Transparent bands colours: crystal, amber, red, silver.

Colori / colours

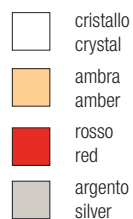

SO 3073 *	SO 3072 **	SO 3067 ***
Kg 3,2	Kg 5,9	Kg 7,2
•548•	•548•	•548•

pag. 080 144

118

026



048

Riflessi

080 design
M & M

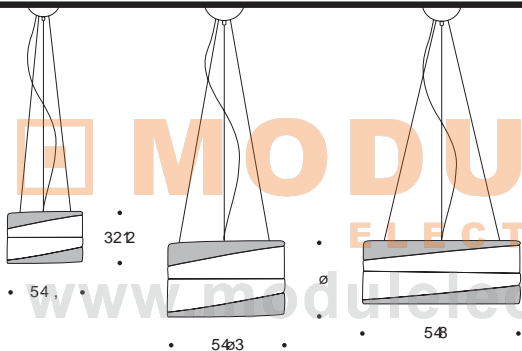

Lampadine / Bulbs

- * E27
1X max 100W 230V
- ** E27
1X max 150W 230V
- *** E27
2X max 150W 230V

Classe II





081

MODUL
ELECTRO
www.modulelectro.ru

Lampada a sospensione in vetro soffiato,
lavorato a mano.

Struttura: metallo cromato.

Colore diffusore: bianco acidato, rosso.

Hand-crafted blown glass hanging lamp.

Frame: polished chrome plated metal.

Glass diffuser color: white satin, red.

Colori / colours

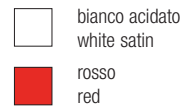

Blow up

082 design
M & M

SO 3117

*

Kg 27,6

pag. 158

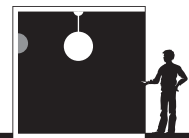

MODULO
ELECTRO
www.modulo.com.ru

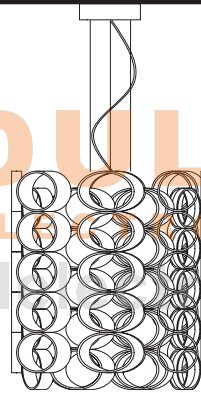

54,6

9

Lampadine / Bulbs

* E27
6X max 60W 230V



Classe I

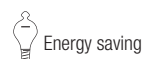



MODUL
ELECTRO
www.modulelectro.ru

MODULO

ELECTRO



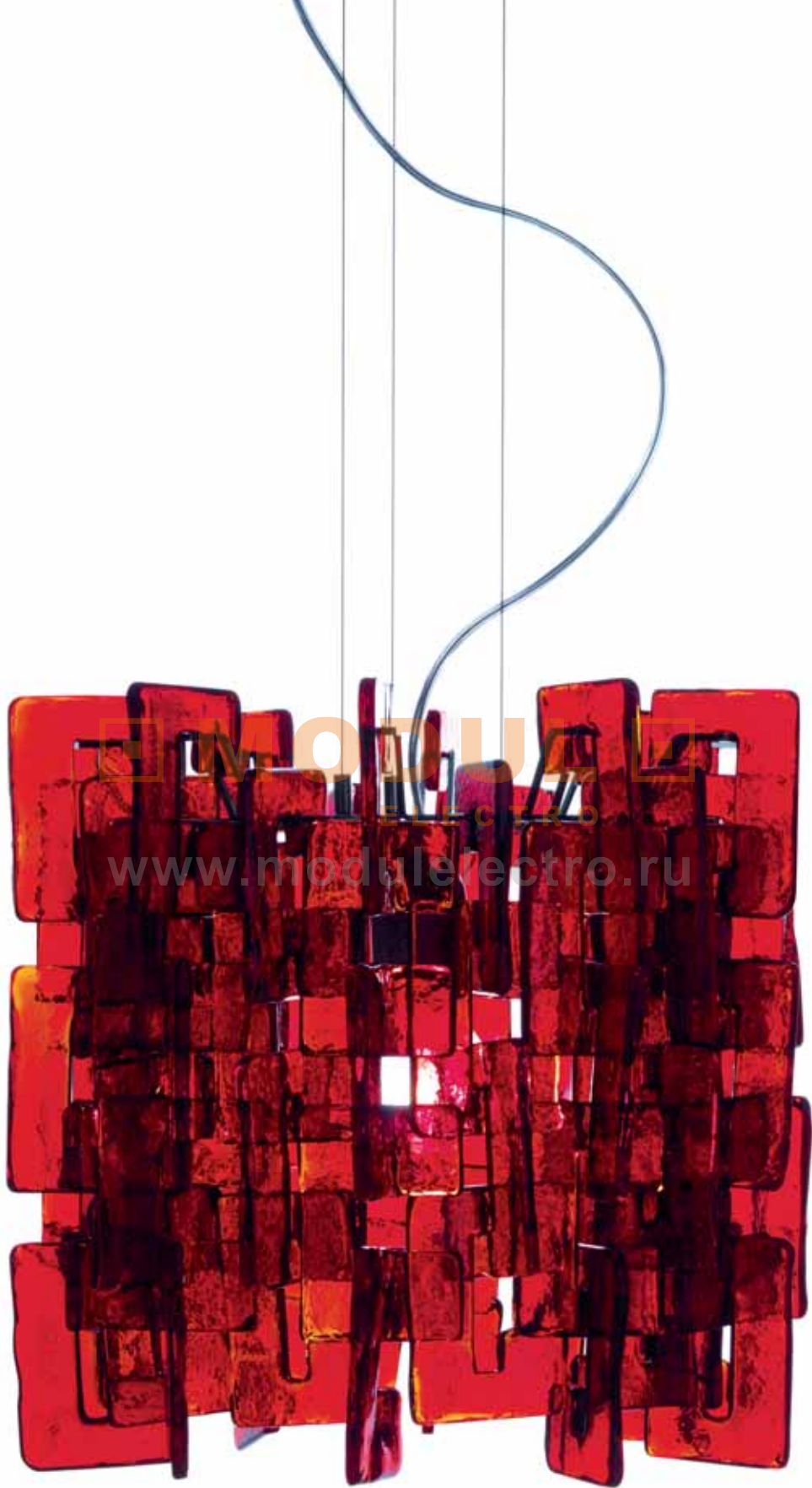

Sixty

085

www.modulelectro.ru

086

MODUL
ELECTRO
www.modulelectro.ru

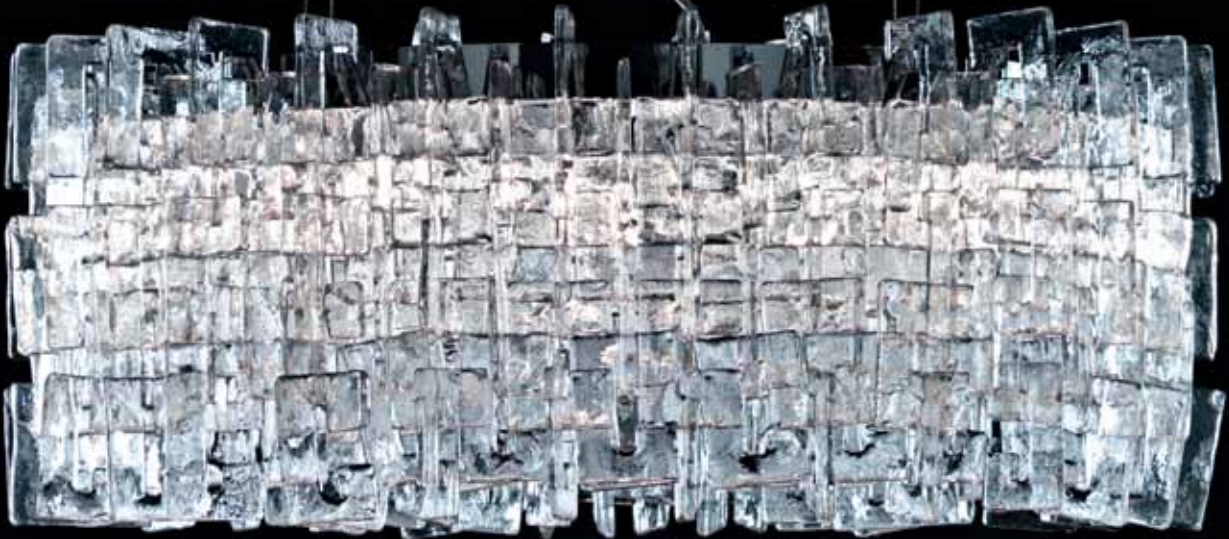



 **MODUL** 
ELECTRO
www.modulelectro.ru

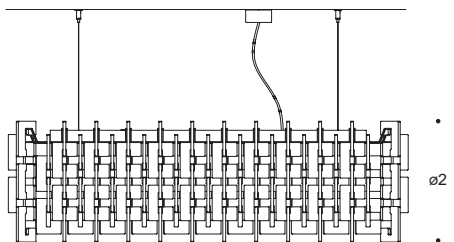

SO 3126

Kg 33

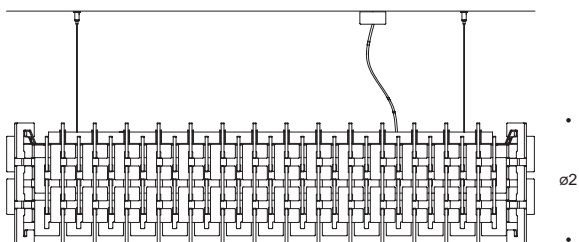

SO 3127

Kg 38

pag. 088 146

120

030



050

Sixty

088 design
Carlo Nason



54, 12

SO 3108

*

Kg 6

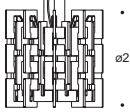

54x2



SO 3106

**

Kg 10

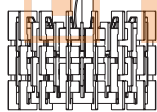

542

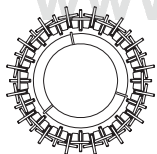

SO 3107

Kg 20

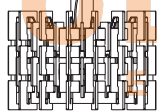

542



SO 3111

Kg 33



548

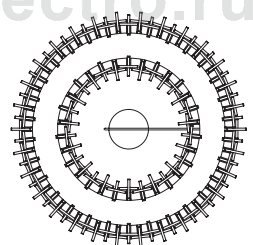

SO 3125

Kg 55

Lampadine / Bulbs

* G9

1X max 60W 230V



** E27

1X max 150W 230V



*** G9

6X max 60W 230V



**** G9

12X max 60W 230V



***** T5

2X max 39W 230V



***** T5

2X max 54W 230V



Classe I



Colori / colours



Lampade a sospensione
in vetro a piastra lavorato a mano.
Colore vetri: cristallo, rosso, nero.
Struttura: metallo cromato.
SO3126, SO3127 fornite di ballast
elettronico dimmerabile.

Hand-crafted glass hanging lamp.
Glass color: crystal, red, black.
Frame: polished chrome plated metal.
SO3126, SO3127 supplied with
dimnable electronic ballast.

SO 3106: N° vetri 90
SO 3107: N° vetri 144
SO 3108: N° vetri 20
SO 3111: N° vetri 220
SO 3125: N° vetri 405
SO 3126: N° vetri 216
SO 3127: N° vetri 288





MODUL
ELECTRO
electro



www.m...ro.ru

LS 150-153

091

 **MODUL** 
ELECTRO
www.modulelectro.ru

BOUTIQUES
LANCEL

LS 150

Kg 116,5

LS 151

**

Kg 51,2

LS 152

*

Kg 33,8

LS 153

*

Kg 25,3

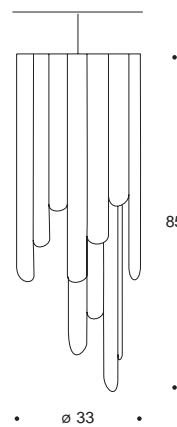
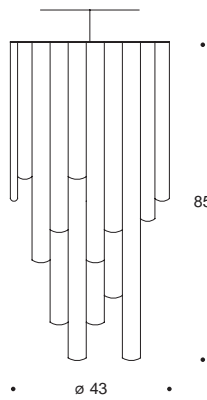
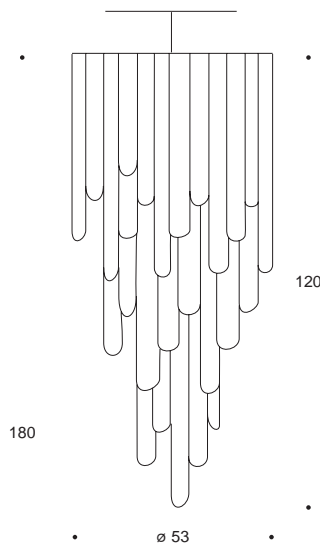
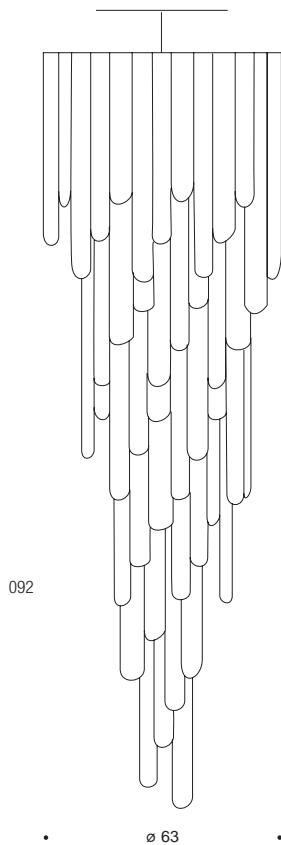

MODUL
ELECTRO

www.modulelectro.ru

pag. 122



LS 150-153

design
Carlo Nason



Sospensione in vetro a piastra
lavorato a mano.
Struttura: metallo cromato.
Colore vetri: cristallo, nero, rosso.

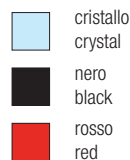

Hand-crafted plate glass chandelier.
Frame: chromed metal.
Glass color: crystal, black, red.



Colori / colours



Lampadine / Bulbs

* E14 + E27
3X max 40W 230V + 1X max 60W 230V
 + 

** E14 + E27
9X max 25W 230V + 1X max 60W 230V
 + 

*** E14 + E27
21X max 25W 230V + 1X max 60W 230V
 + 

Classe I

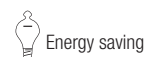



093

MODUL
ELECTRO
www.modulelectro.ru

Sospensione in vetro soffiato incamiciato con il lattimo, con striature lavorate a mano.
Struttura: metallo nichelato e spazzolato.
Colore diffusore: bianco e nero.

Blown glass hanging lamp in milk glass, with handmade streaks.
Frame: brushed nickel plated metal.
Glass diffuser color: white and black.

Colori / colours



bianco/nero
white/black



SO 3048

*

Kg 4,5

pag. 094 148

124

032



056

White&Black

• 588 •

094 design
M & M

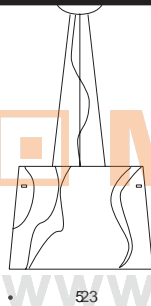
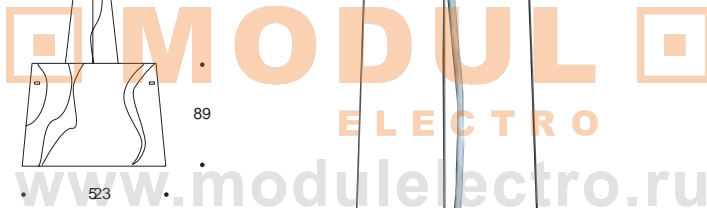

Lampadine / Bulbs

* E27
1X max 150W 230V



Classe II

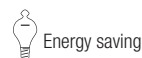

Energy saving

 **MODUL** 
ELECTRO
www.modulelectro.ru

096

MODUL
ELECTRO
www.modulelectro.ru





Point

097

MODULO
ELECTRO
www.modulelectro.ru

Sospensione
in vetro soffiato e satinato.
Struttura: metallo verniciato grigio.
Colore diffusore:
cristallo, ambra, rosso.

Colori / colours



Blown glass hanging lamp
with satin-finish.
Frame: grey painted metal.
Glass diffuser color:
crystal, amber, red.

SO 3038

*

Kg 1,5

SO 3038/S

**

Kg 4,5

Point



098 design
Mauro Marzollo

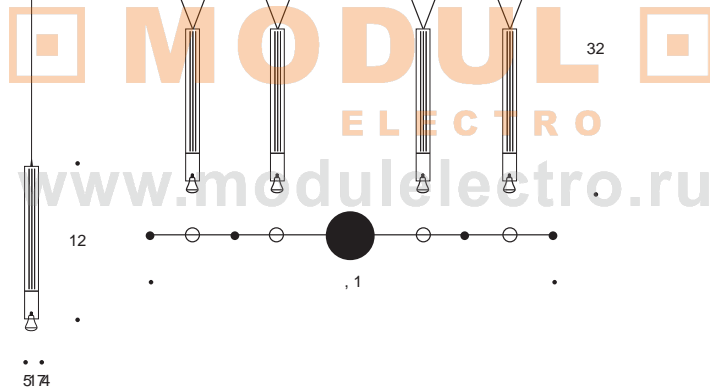

Lampadine / Bulbs

* E14 o/or * GZ10
1X max 40W 230V o/or 1X max 50W 230V





** E14 o/or * GZ10
4X max 40W 230V o/or 4X max 50W 230V

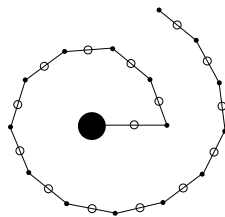

Classe II

a richiesta :
sistema modulare
personalizzabile
on request:
custom made
modular system



 **MODUL** 
ELECTRO
www.modulelectro.ru



Sospensione in vetro soffiato.
Struttura: metallo cromato.
Colore diffusore:
cristallo satinato (SO 3042)
cristallo trasparente (SO 3054)

Colori / colours

SO 3042



cristallo satinato
satin crystal

SO 3054



cristallo trasparente
transparent crystal

Blown glass hanging lamp.
Frame: polished chrome plated metal.
Glass diffuser color:
satin crystal (SO 3042)
transparent crystal (SO 3054)

Ola

SO 3054

SO 3042

*

Kg 6,4

• 12 •



100 design
M & M

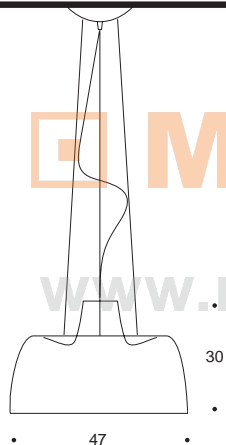

MODUL
ELECTRO

www.modulelectro.ru

Lampadine / Bulbs

* E27

1X max 150W 230V



Classe II



Energy saving



MODUL
ELECTRO

www.modulelectro.ru

Sospensioni orientabili in vetro soffiato incamiciato con il lattimo, molato a mano, satinato.

Struttura: metallo verniciato grigio chiaro.

Colore diffusore: bianco satinato.

Colori / colours

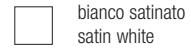

Hand-ground cased blown glass swivelling hanging lamps.

Frame: grey painted metal.

Glassdiffuser colour: satin white.

SO 3058

**

Kg 3

LS 772

*

Kg 2

pag. 126



Luna

102 design

Michele De Lucchi

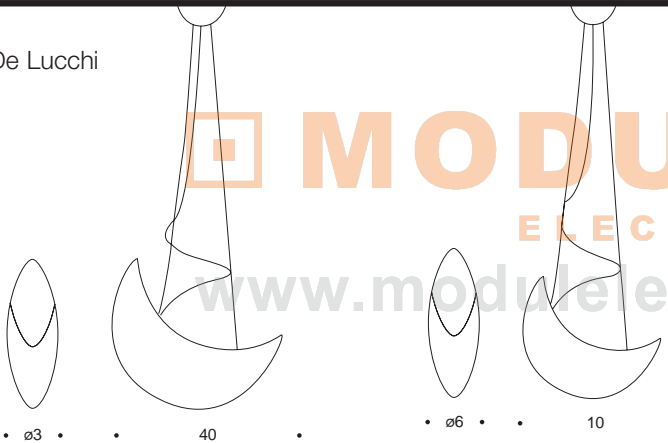

Lampadine / Bulbs

* E27

1X max 100W 230V



** E27

2X max 100W 230V



Classe II



Energy saving

 **MODUL** 
ELECTRO

www.modulelectro.ru



Sospensioni in vetro stampato, interno satinato.
Struttura: metallo verniciato grigio chiaro.
Colore diffusore: cristallo.

Colori / colours

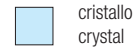

cristallo
crystal

Pressed glass hanging lamps with satin-finish inside.
Frame: grey painted metal.
Glass diffuser colour: crystal.

LS 750 /HA
*
Kg 1,8

SO 3128
**
Kg 8,5

Lilliput



• ø2 •

• 8, •

pag. 132



104 design
Paolo Piva

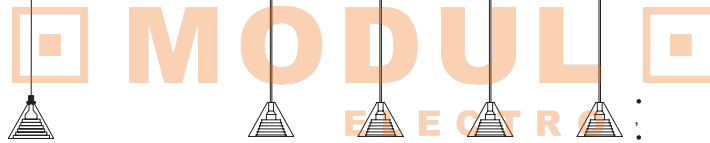

• ø8 •

• 0 •

Lampadine / Bulbs

* G9
1X max 60W 230V



** G9
4X max 60W 230V



Classe II

www.modulelectro.ru

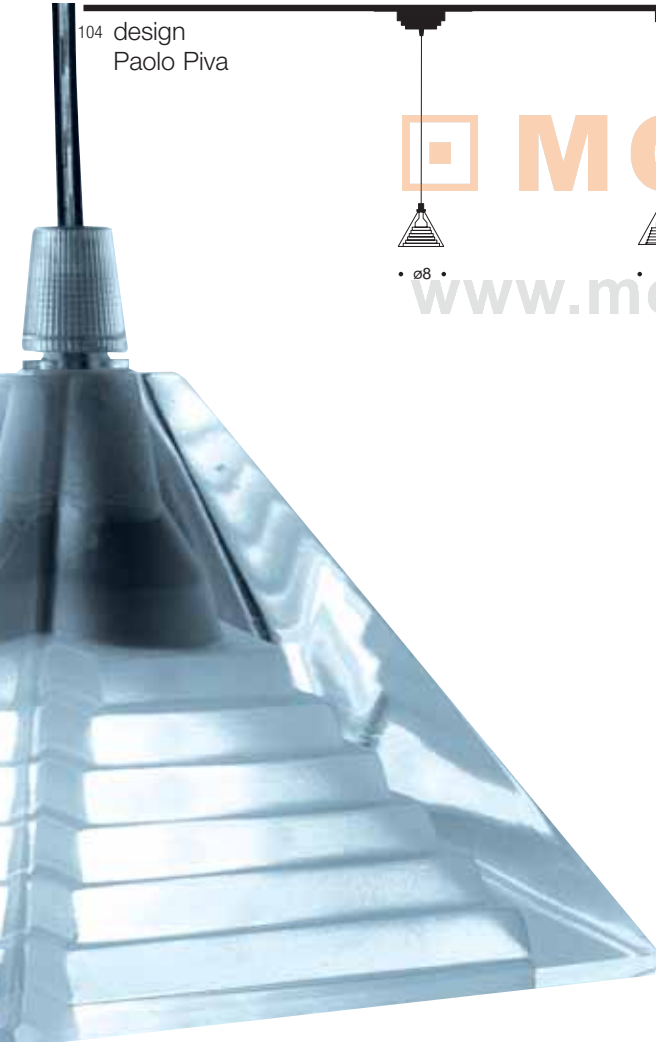

MODUL
ELECTRO
www.modulelectro.ru



MODUL
ELECTRO
www.modulelectro.ru

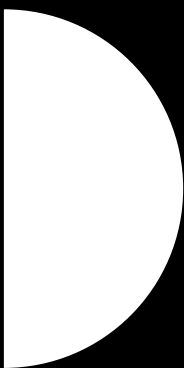

108 Cocco

110 Argo

112 White

114 Teia

116 Blow up

118 Riflessi

120 Sixty

122 LP240-243

124 White&Black

126 Luna

128 Rio

130 Foglio

132 Lilliput

Parete

Wall lamps

ELECTRO
www.modulelectro.ru

Colori / colours

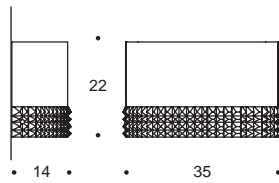
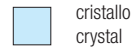

AP 1100
*
Kg 3

pag. 066 136



038

Cocco

108 design
M & M

Lampada da parete in vetro a
piastra lavorato a mano.
Struttura: metallo verniciato bianco.
Colore vetro: cristallo.
Colore paralume: bianco.

Hand-crafted glass wall lamp.
Frame: white painted metal.
Glass color: crystal.
Lampshade color: white.

Lampadine / Bulbs

* E27
1X max 100W 230V



Classe II

MODULO ELECTRO
www.modulelectro.ru



 **MODUL** 
ELECTRO
www.modulelectro.ru



Colori / colours

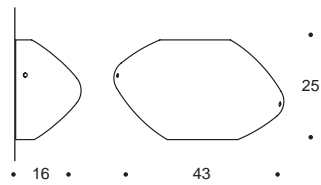
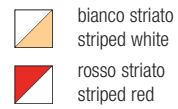

AP 1099
*
Kg 2

pag. 074 142



Argo

110 design
Claudio Marturano
e Paolo Franzin

Lampada da parete in vetro
soffiato incamiciato con il lattimo.
Struttura: metallo verniciato bianco.
Colore diffusore: bianco striato,
rosso striato.

Blown glass lamps in cased milk glass.
Frame: white painted metal.
Glass diffuser color: striped white,
striped red.

Lampadine / Bulbs

* E27
1X max 100W 230V



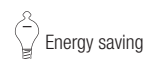

Classe II





111

 **MODUL** 
ELECTRO
www.modulelectro.ru

Colori / colours

 bianco satinato
white satin

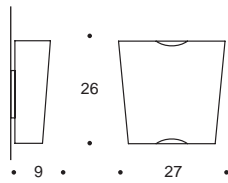

AP 1101
*
Kg 1,6

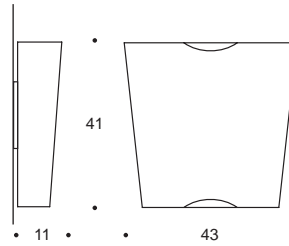

AP 1102
**
Kg 3,5

pag. 138



White

112 design
M & M

Lampada da parete in vetro.
Struttura: metallo nichelato e spazzolato.
Colore vetro: bianco satinato.

Glass wall lamp.
Frame: brushed nickel plated metal.
Glass color: white satin.

MODUL
ELECTRO

www.modulelectro.ru

Lampadine / Bulbs

* E14
2X max 60W 230V



** E27
2X max 100W 230V



Classe II



Energy saving

 **MODUL** 
ELECTRO

www.modul.electro.it



Lampada da parete in vetro a piastra lavorato a mano.
 Struttura: metallo cromato.
 Colori diffusore: cristallo, cristallo satinato, rosso.

Hand-crafted glass wall lamp.
 Frame: polished chrome plated metal.
 Glasdiffuser colours: crystal, satin finish crystal, red.

Colori / colours

-  cristallo
crystal
-  cristallo satinato
satin finish crystal
-  rosso
red

Teia

AP 1094
*
Kg 1,2

AP 1095
**
Kg 1,8

AP 1096

Kg 2,5



114 design
M & M

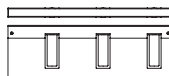
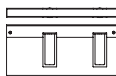

• 2,4
•
• 13,7
•



AP 1094 AP 1095 AP 1096
 L'applicque può essere installata in orizzontale
 The wall lamp can be fixed in horizontal

www.modul-electro.ru

Lampadine / Bulbs

* G9 alogena/halogen
1X max 60W 230V



** G9 alogena/halogen
2X max 60W 230V



*** G9 alogena/halogen
3X max 60W 230V



Classe II





MODUL
ELECTRO

www.modulelectro.ru

Colori / colours

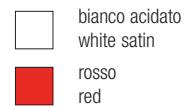
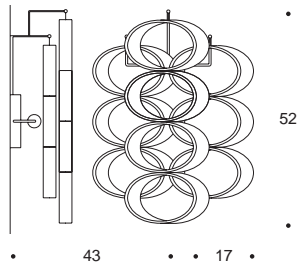

AP 1092
*
Kg 4

pag. 082



Blow up

116 design
M & M

Lampada da parete in vetro soffiato, lavorato a mano.
Struttura: metallo cromato.
Colore diffusore: bianco acidato, rosso.

Hand-groung blown glass wall lamp.
Frame: polished chrome plated metal.
Glass diffuser color: white satin, red.

Lampadine / Bulbs

* R7s 118mm
1X max 150W 230V



Classe II



MODULUM
ELECTRO
www.modulelectrom.com



AP 1068

*

Kg 2,5

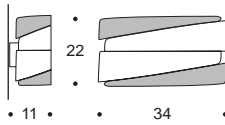

AP 1069

*

Kg 3

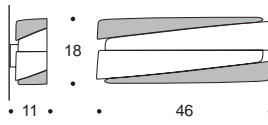

pag. 078 144



026

048

Riflessi

118 design
M & M

Applique in vetro a piastra, lavorato a mano, satinato.
Struttura: metallo verniciato grigio.
Colore diffusore: cristallo satinato.
Colori fasce trasparenti: cristallo, ambra, rosso, argento.

Hand-crafted glass wall lamp with satin finish.
Frame: grey painted metal.
Glass diffuser color: satin crystal.
Transparent bands colours: crystal, amber, red, silver.

Lampadine / Bulbs

* R7s 118mm
1X max 150W 230V



Classe I



MODUL
ELECTRO
www.modulselectro.ru



MODULO
ELECTRO

www.modulelectro.ru

AP 1083

*

Kg 3,5

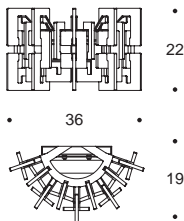

Colori / colours

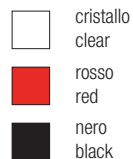

Sixty

pag. 084 146

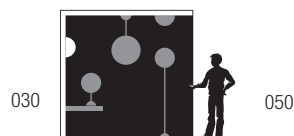

120 design
Carlo Nason

Lampada da parete in vetro a piastra
lavorato a mano.

Colore vetri: cristallo, rosso, nero.

Struttura: metallo cromato.

Hand-crafted glass wall lamp.

Glass color: clear, red, black.

Frame: polished chrome plated metal.



MODULO ELECTRO
www.modulelectro.ru

Lampadine / Bulbs

* R7s 118mm
1X max 150W 230V



Classe I

 **MODUL** 
ELECTRO
www.modulelectro.ru



Applique in vetro a piastra lavorato a mano.
 Struttura: metallo cromato.
 Colore vetri: cristallo, nero, rosso.

Hand-crafted plate glass wall lamp.
 Frame: chrome plated metal.
 Glass color: crystal, black, red.

Colori / colours

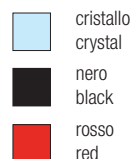

pag. 090



LP 240-243

122 design
 Carlo Nason



LP 240

 Kg 66

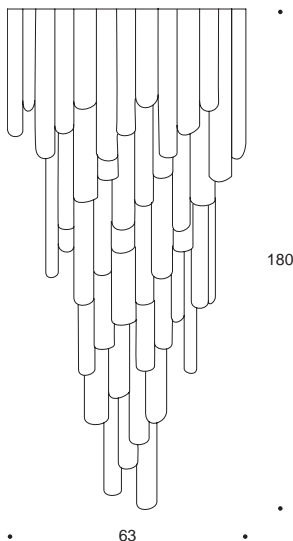

LP 241

 Kg 47

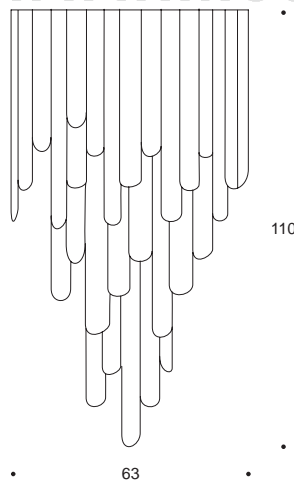

LP 242
 **
 Kg 14

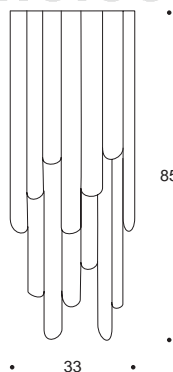

LP 243
 *
 Kg 6,5

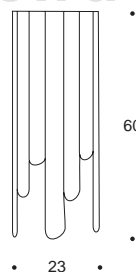

Lampadine / Bulbs

* E14
 2X max 40W 230V



** E14
 4X max 40W 230V



*** E14
 6X max 40W 230V





**** E14
 11X max 40W 230V

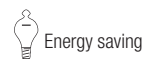

Classe I



A decorative hanging ornament made of red glass strips and a wire mesh vase in the foreground. The background is a blurred outdoor scene with a white fence and green foliage.

 **MODUL** 
ELECTRO
www.modulelectro.ru



AP 1059

*

Kg 1,6

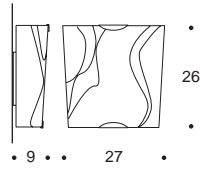

AP 1056

**

Kg 3,5

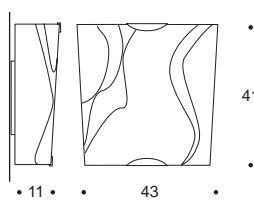

pag. 094 148



White&Black

124 design
M & M

Applique in vetro soffiato incamiciato con il lattimo con striature lavorate a mano.

Struttura: metallo nichelato e spazzolato.

Colore diffusore: bianco e nero.

Blown glass wall lamp in milk glass with handmade streaks.

Frame: brushed nickel plated metal.

Glass diffuser color: white and black.

MODUL
ELECTRO
www.modulelectro.ru

Lampadine / Bulbs

* E14
2X max 60W 230V



** E27
2X max 100W 230V



Classe II

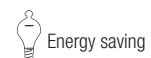



MODUL
ELECTRO
modulelectro.ru

AP 1072

*

Kg 2,8

Colori / colours



bianco
white

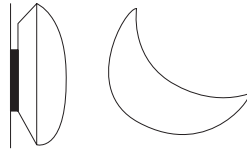

• 15 • • 38 •

pag. 102



Luna

126 design

Michele De Lucchi

Applique in vetro soffiato
incamiciato con il lattimo.

Struttura: metallo verniciato bianco.

Colore diffusore: bianco.

Cased blown glass wall lamp in milk glass.

Frame: white painted metal.

Glass diffuser color: white.

 **MODULO** 
ELECTRO

www.modulelectro.ru

Lampadine / Bulbs

* E27

1X max 100W 230V



Classe I



Energy saving



127

 **MODUL** 

ELECTRO

www.modulelectro.ru



Applique in vetro a piastra, lavorato a mano.
 Struttura: inox satinato.
 Colore diffusore: cristallo satinato.
 Colore inserto: cristallo, ambra, rosso, blu, nero.

Hand-crafted glass wall lamp with satin-finish.
 Frame: satin inox.
 Glass diffuser colour: satin crystal.
 Insert colors: crystal, amber, red, blue, black.

Colori / colours



pag. 150



Rio

128 design
 M & M

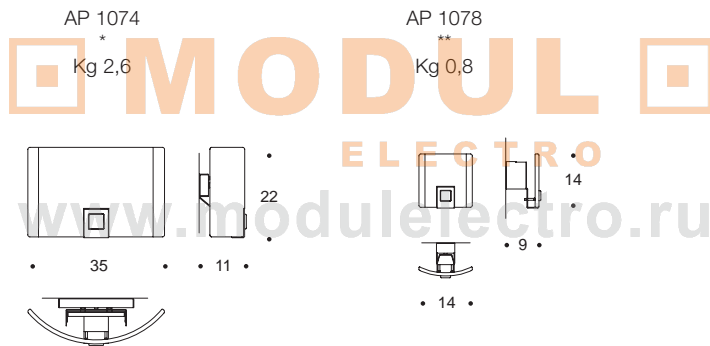

Lampadine / Bulbs

* R7s 118mm
 1X max 150W 230V



** G9
 1X max 60W 230V



Classe I

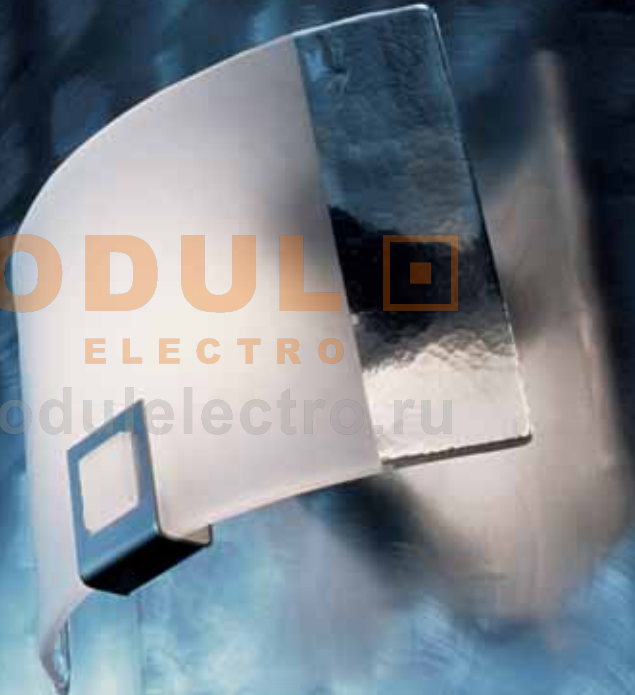

MODULO
ELECTRO
www.modulelectro.ru

Applique in vetro a piastra lavorato a mano.
Struttura: metallo nichelato e spazzolato.
Colore diffusore: cristallo, cristallo satinato.

Hand-crafted glass wall lamp.
Frame: brushed nickel plated metal.
Glassdiffuser colours: crystal, satin crystal.

Colori / colours

AP 1066



cristallo
crystal

AP 1067



cristallo satinato
satin crystal

AP 1066
AP 1067

*
Kg 2,5

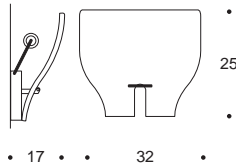



pag. 152



Foglio

130 design
M & M

 **MODUL** 
ELECTRO
www.modulelectro.ru

Lampadine / Bulbs

* R7s 118 mm
1X max 150W 230V



Classe I





MODUL
ELECTRO
www.modulelectro.ru

Applique in vetro stampato.
Colore diffusore: cristallo.
Struttura: metallo verniciato grigio.

Colori / colours

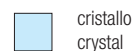

Pressed glass wall lamp.
Glass diffuser color: crystal.
Frame: gray painted metal.

AP 1098

*

Kg 1,7

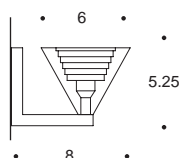

pag. 104



Lilliput

132 design
Paolo Piva

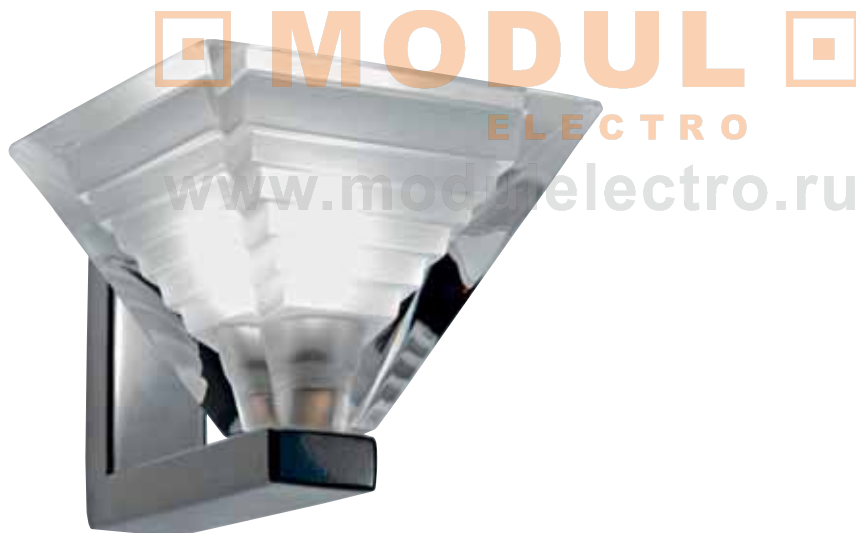



Lampadine / Bulbs

* G9
1X max 60W 230V



Classe I

 **MODUL** 
ELECTRO
www.modulelectro.ru



MODUL
ELECTRO
www.modulelectro.ru

136 Cocco
138 White
140 Forme
142 Argo
144 Riflessi
146 Sixty
148 White&Black
150 Rio
152 Foglio
154 Trio
156 LP 842/842T

The logo for MODULO ELECTRO features the word "MODULO" in a large, bold, sans-serif font, with "ELECTRO" in a smaller font below it. The text is flanked by two square icons, each containing a smaller square. Below the logo, the website address "www.modulelectro.ru" is displayed in a light gray font.

www.modulelectro.ru

Soffitto
Ceiling lamp

Plafoniera in vetro a piastra lavorato a mano.
Struttura: metallo verniciato bianco.
Colore diffusore: cristallo.
Colore diffusore in tessuto: bianco.

Colori / colours

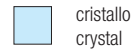

Hand-crafted glass ceiling lamp.
Frame: white painted metal .
Glass diffuser color: crystal.
Fabric diffuser color: white.

Cocco

PL 2062

*

Kg 6

43

pag. 066

108

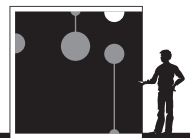

038

136 design
M & M

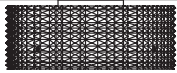

17

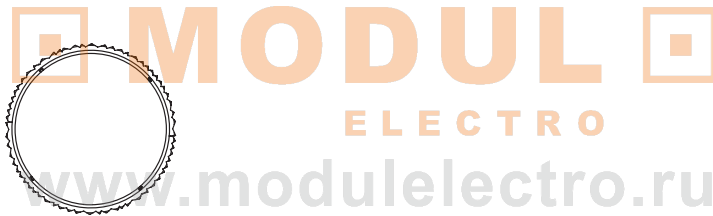

Lampadine / Bulbs

* E27
3X max 75W 230V



Classe I

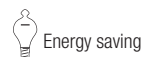



 **MODUL** 

ELECTRO

www.modulelectro.ru



Plafoniera in vetro.
Struttura: metallo nichelato e spazzolato.
Colore diffusore: bianco.

Colori / colours

Glass ceiling lamp.
Frame: brushed nickel plated metal.
Glass diffuser color: white.

 bianco satinato
white satin

White

PL 2061
*
Kg 3,5

pag. 112



138 design
M & M



11

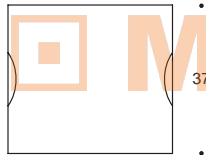

37



41

www.modulelectro.ru

Lampadine / Bulbs

* E27
2X max 150W 230V



Classe II

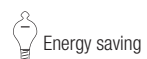



 **MODUL** 
ELECTRO

www.modulelectro.ru

Plafoniera in vetro soffiato, lavorato a mano.
Struttura: metallo verniciato bianco.
Colore diffusore: bianco,
bianco e filigrana nera.

Hand-crafted glass ceiling lamp.
Frame: white painted metal.
Glass diffuser color: white,
white with internal black decorations.

Colori / colours

-  bianco
white
-  bianco e filigrana nera
white with internal black decorations

Forme C
PL 2059
*
Kg 4,6

pag. 070

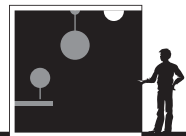

014

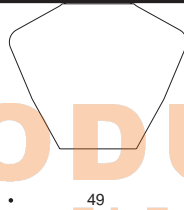

Forme

140 design
Christophe Pillet



 **MODULO** 
ELECTRO

www.modulelectro.ru

Lampadine / Bulbs

* E27
3X max 60W 230V



Classe II

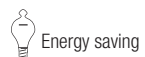



 **MODUL** 
ELECTRO
www.modulelectro.com



Plafoniera in vetro soffiato incamiciato con il lattimo.
Struttura: metallo verniciato bianco.
Colore diffusore: bianco striato, rosso striato.

Blown glass ceiling lamp in cased milk glass.
Frame: white painted metal.
Glass diffuser color: striped white, striped red.

Colori / colours

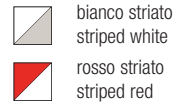

PL 2058
*
Kg 5,6

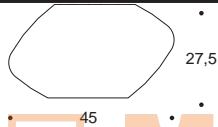
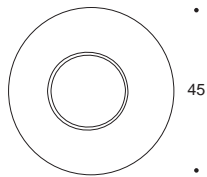

Argo

142 design
Claudio Marturano
e Paolo Franzin

pag. 074

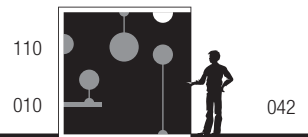

45

MODULO
ELECTRO

www.modulelectro.ru

Lampadine / Bulbs

* E27
3X max 60W 230V



Classe II



143

MODUL
ELECTRO
www.modulelectro.ru



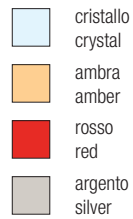

Plafoniera in vetro a piastra, lavorato a mano, satinato.
 Struttura: metallo verniciato grigio.
 Colore diffusore: cristallo satinato.
 Colori fasce trasparenti: cristallo, ambra, rosso, argento.

Hand-crafted glass ceiling lamp with satin finish.
 Frame: gray painted metal.
 Glass diffuser color: satin crystal.
 Transparent bands colours: crystal, amber, red, silver.

Riflessi

PL 2045
 *
 Kg 5,6
 PL 2045/FL
 **
 Kg 6,1

pag. 078



144 design
 M & M

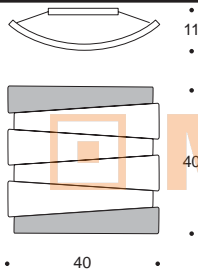

MODUL
 ELECTRO
www.modulelectro.ru

Lampadine / Bulbs

* E14
 4X max 40W 230V



** G24d-3
 2X max 26W 230V



Classe I



MODUL
ELECTRO
www.modulelectro.ru

Plafoniera in vetro a piastra
 lavorato a mano.
 Colore vetri: cristallo, rosso, nero.
 Struttura: metallo cromato.

Hand-crafted glass ceiling lamp.
 Glass color: clear, red, black.
 Frame: polished chrome plated metal.

PL 2052: N° 220 vetri / glass
 PL 2053: N° 86 vetri / glass
 PL 2060: N° 628 vetri / glass

Colori / colours

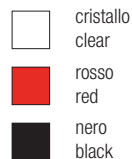

Sixty

PL 2060

 Kg 50

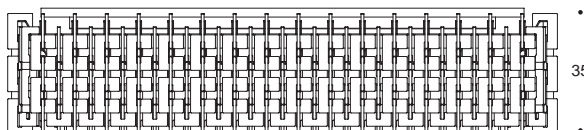

pag. 084

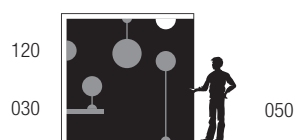

146 design
 Carlo Nason

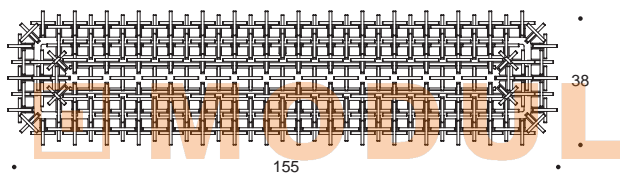

PL 2053
 *
 Kg 9,1

PL 2052
 **
 Kg 18,5

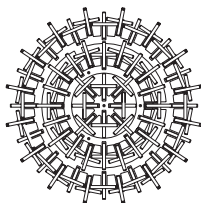
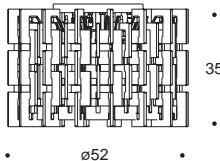
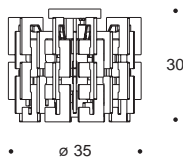

Lampadine / Bulbs

* G9
 3X max 60W 230V

** G9
 6X max 60W 230V

*** T5
 2X max 54W 230V

Classe I

www.modulelectro.ru





MODUL
ELECTRO

Plafoniera in vetro soffiato incamiciato con il lattimo, con striature lavorate a mano.
Struttura: metallo nichelato e spazzolato.
Colore diffusore: bianco e nero.

Blown glass ceiling lamp in milk glass, with handmade streaks.
Frame: brushed nickel plated metal.
Glass diffuser color: white and black.

Colori / colours



bianco/nero
white/black

PL 2037

*

Kg 3,5

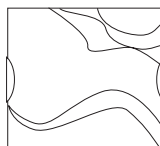

37



11

41

pag. 094

124

032



056

White&Black

148 design
M & M

ELECTRO

www.modulelectro.ru

Lampadine / Bulbs

* E27
2X max 150W 230V



Classe II

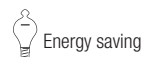



 **MODUL** 
ELECTRO

www.modulelectro.ru



Plafoniera in vetro a piastra, lavorato a mano.
 Struttura: inox satinato.
 Colore diffusore: cristallo satinato.
 Colore inserto: cristallo, ambra, rosso, blu, nero.

Hand-crafted glass ceiling lamp with satin-finish.
 Frame: satin inox.
 Glass diffuser color: satin crystal.
 Insert colors: crystal, amber, red, blue, black.

Colori / colours



PL 2047
*

Kg 7

PL 2048
**

Kg 7,5

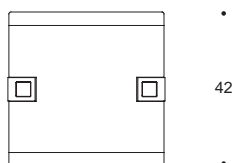

pag. 128



Rio

150 design
M & M

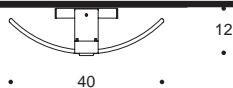

MODULO
ELECTRO
www.modulelectro.ru

Lampadine / Bulbs

* E14
4X max 40W 230V

** G24d-3
2X max 26W 230V



Classe I

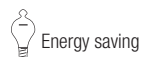

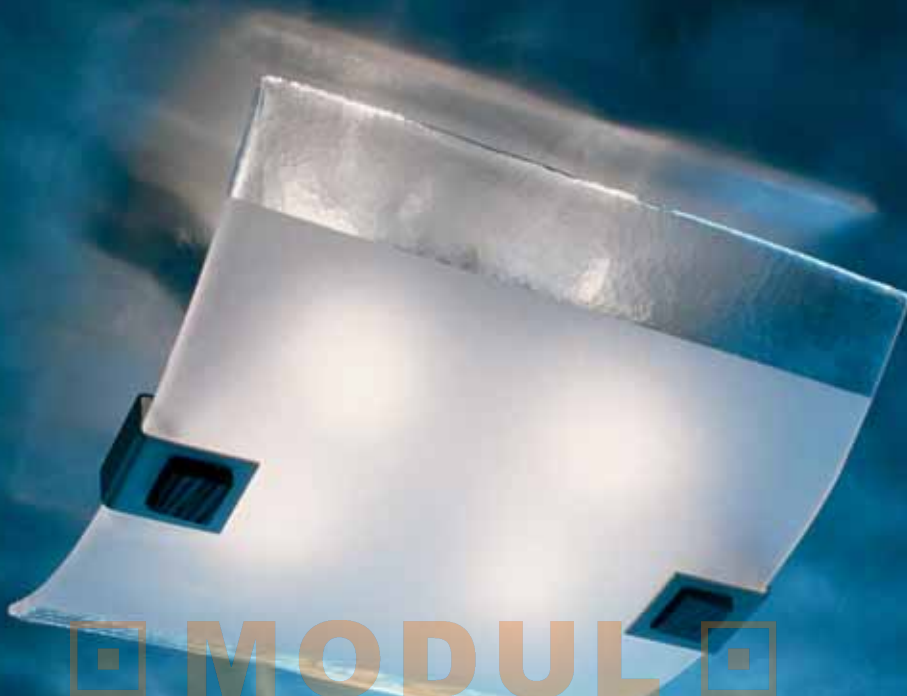

MODUL
ELECTRO
www.modulelectro.ru

Plafoniera in vetro a piastra lavorato a mano.
Struttura: metallo nichelato e spazzolato.
Colore diffusore: cristallo satinato.

Colori / colours

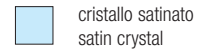

Hand-crafted glass ceiling lamp.
Frame: brushed nickel plated metal.
Glass diffuser color: satin crystal.

Foglio

PL 2046
*

Kg 7

PL 2046/FL
**

Kg 7,5

pag. 130



152 design
M & M



12

•

•



40

MODULO
ELECTRO

www.modulelectro.ru

Lampadine / Bulbs

* E14
4X max 40W 230V





** G24d-3
2X max 26W 230V

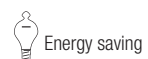

Classe I



 **MODUL** 
ELECTRO
www.modulselectro.ru

Plafoniera in vetro satinato.
Struttura: metallo nichelato e spazzolato.
Colore diffusore: bianco satinato.

Colori / colours

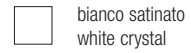

Glass ceiling lamp with satin-finish.
Frame: brushed nickel plated metal.
Glass diffuser colour: satin white.

Trio



154 design
M & M

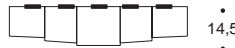

14,5

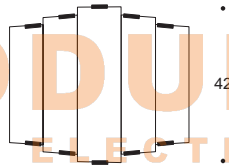

42



48

MODULO
ELECTRO
www.modulelectro.ru

PL 2035
*

Kg 6,5

PL 2035/FL
**

Kg 7,5

Lampadine / Bulbs

* E27
4X max 75W 230V



** G24d-3
4X max 26W 230V



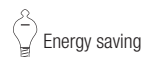

Classe I







155

 **MODUL** 
ELECTRO
www.modulelectro.ru

Plafoniera in vetro soffiato e satinato.
Struttura: metallo cromato.
Colore diffusore:
cristallo satinato (LP 842), cristallo (LP 842/T).

Hand-crafted glass, with satin finish lamp.
Frame: chromed metal.
Glass diffuser colour:
satin crystal (LP 842), crystal (LP 842/T).

Colori / colours

LP 842		cristallo satinato satin crystal
LP 842/T		cristallo crystal

LP 842/842T

LP 842
LP 842/T
*
Kg 0,8



156 design
M & M



12



20

 **MODUL** 
ELECTRO

www.modul-electro.ru



Lampadine / Bulbs

* E14
1X max 60W 230V



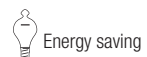

Classe I



Energy saving



157

 **MODUL** 
ELECTRO
www.modulelectro.ru

MODUL
ELECTRO
www.modulelectro.ru

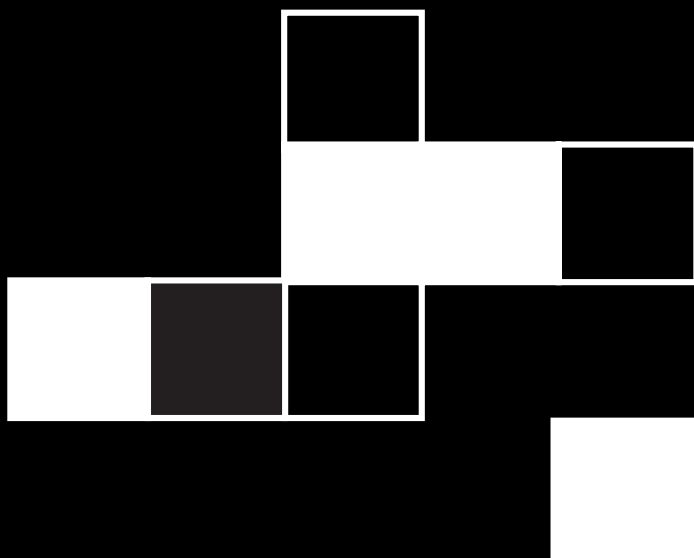

MODUL
ELECTRO

www.modulelectro.ru

160 LP 256-269
164 LP 276

Mo
du
la ri
Mo
du
lar

MODUL
ELECTRO





LP 256-269



161

 **MODUL** 
ELECTRO

www.modul.ro

Plafoniera componibile
 in vetro a piastra lavorato a mano.
 Colori: cristallo/bianco, cristallo/tabacco.

Colori / colours

-  cristallo/bianco
clear/white
-  cristallo/tabacco
clear/tabacco

Hand-crafted glass, modular ceiling lamp.
 Colors: clear/white, clear/tabacco.

LP 256
 *
 Kg 7

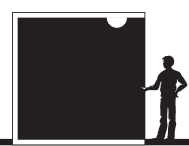

LP 256

162 design
 Carlo Nason

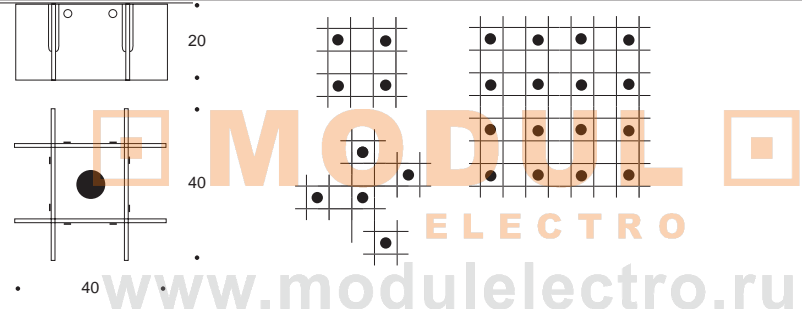

Lampadine / Bulbs

* E27
 1x max 100W 230V



Classe I

 Energy saving

www.modulelectro.ru

LP 269

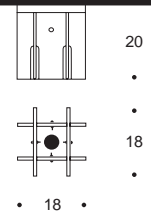
design
 Carlo Nason



LP 269
 **
 Kg 2,9

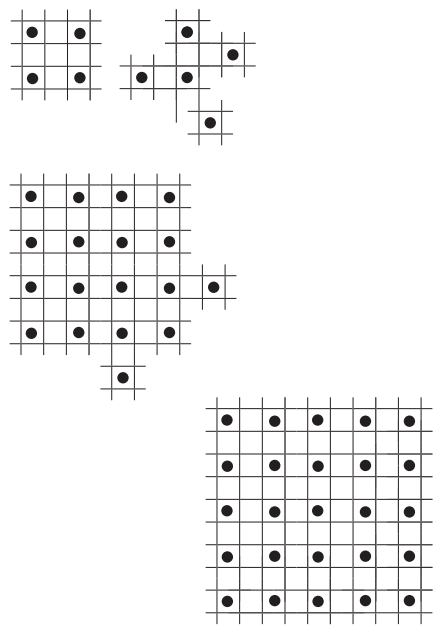

Lampadine / Bulbs

** E14
 1X max 40W 230V

Classe I

 Energy saving



163

MODOL
ELECTRO
odul.electro.ru

Plafoniera componibile
 in vetro a piastra lavorato a mano.
 Struttura: metallo verniciato bianco.
 Colore diffusore: cristallo/sabbia.

Colori / colours



cristallo/sabbia
 crystal/sand

Hand-crafted glass, modular ceiling lamp.
 Frame: white painted metal.
 Glassdiffuser color: crystal/sand.

LP 276

164 design
 Carlo Nason

LP 256
 *
 Kg 3

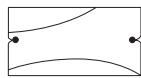

58



52

72

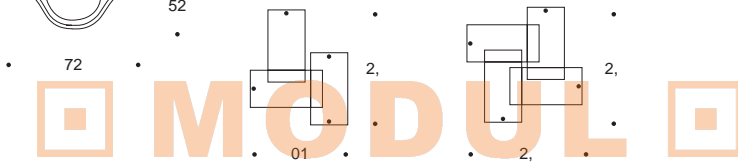

Lampadine / Bulbs

* E14
 2X max 40W 230V



Classe I

MODULO
ELECTRO

www.modulelectro.ru

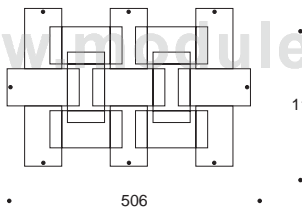

11

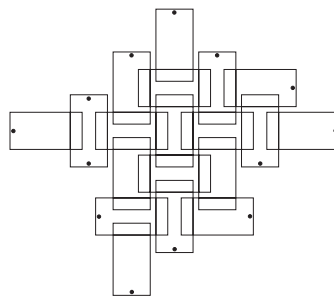

506

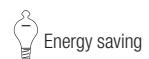

578

5,5



 **MODUL** 
ELECTRO
www.modulelectro.ru

MODUL
ELECTRO
www.modulelectro.ru

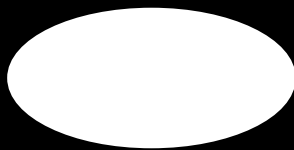
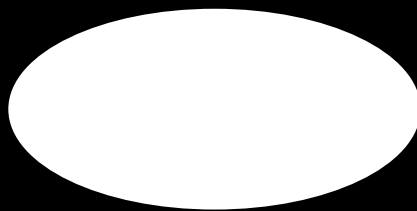

Faretti
Spot lamps

MODUL

ELECTRO

www.modulelectro.ru

- 168 FR 6001
- FR 6002
- FR 6002/HA
- FR 6010
- FR 6011
- FR 6011/HA
- 169 LP 882
- LP 883
- LP 883/HA
- FR 6024
- FR 6024/HA
- 170 FR 6022
- FR 6022/HA
- FR 6013
- FR 6014
- FR 6014/HA
- 171 FR 6023
- FR 6023/HA
- FR 6016
- FR 6017
- FR 6017/HA

FR 6001-6002-6002/HA

168 design
M & M

Faretto in vetro stampato
Colori: cristallo

Pressed glass recessed downlighter
Colours: crystal

FR 6010-6011-6011/HA

design
M & M

Faretto in vetro stampato e satinato
Colori: cristallo

Pressed glass recessed downlighter, with satin finish
Colours: crystal

MODULE
ELECTRO
www.modulelectro.ru

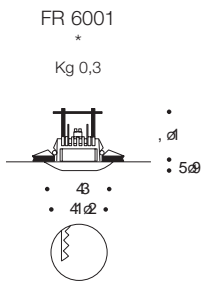

Colori / colours

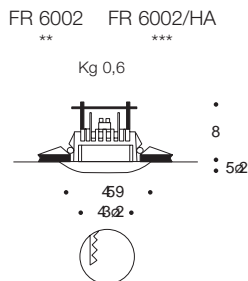

Lampadine / Bulbs

* GY 6,35 o/or GU 4 ø 35,3mm
1X max 35W 12V o/or 1X max 35W 12V
= O/OR =

** GY 6,35 o/or GX 5,3 ø 51mm
1X max 50W 12V o/or 1X max 50W 12V
= O/OR =

Classe III

*** G9
1X max 60W 230V
= =
Classe II

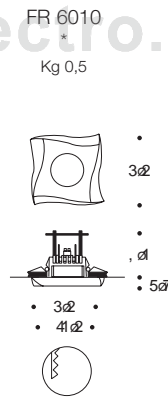

Colori / colours

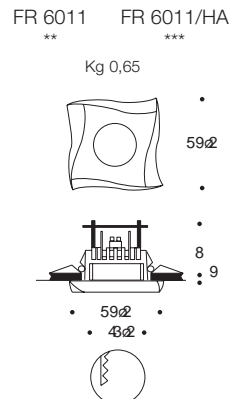

Lampadine / Bulbs

* GY 6,35 o/or GU 4 ø 35,3mm
1X max 35W 12V o/or 1X max 35W 12V
= O/OR =

** GY 6,35 o/or GX 5,3 ø 51 mm
1X max 50W 12V o/or 1X max 50W 12V
= O/OR =

Classe III

*** G9
1X max 60W 230V
= =
Classe II



LP 882-883-883/HA

design
M & M

Faretto in vetro stampato, interno satinato
Colori: cristallo satinato

Pressed glass recessed downlighter with satin finish inside
Colours: satin crystal

LP 882
*
Kg 0,45

LP 883 LP 883/HA
** ***
Kg 0,85

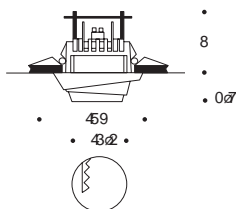
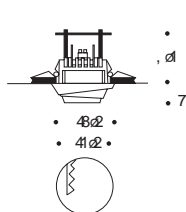

Colori / colours



Lampadine / Bulbs

* GY 6,35 o/or GU 4 ø 35,3mm
1X max 35W 12V o/or 1X max 35W 12V

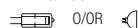

** GY 6,35 o/or GX 5,3 ø 51mm
1X max 50W 12V o/or 1X max 50W 12V

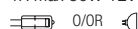

Classe III

*** G9
1X max 60W 230V



Classe II



FR 6024-6024/HA

design
Paolo De Lucchi

169

Faretto in vetro stampato
Colori vetro interno: cristallo satinato,
ambra satinato, acquamarina satinato
Colori vetro esterno: cristallo trasparente

Pressed glass recessed downlighter
Inner glass colours: satin crystal,
satin amber, satin aquamarine
Colour outside glass: transparent crystal

FR 6024 FR 6024/HA
* **
Kg 1,2

Colori / colours

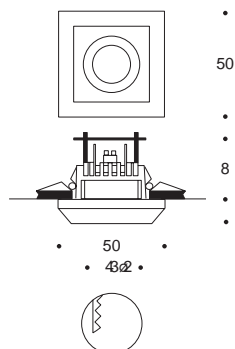

Lampadine / Bulbs

* GY 6,35 o/or GX 5,3 ø 51mm
1X max 50W 12V o/or 1X max 50W 12V

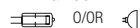

Classe III

** G9
1X max 60W 230V



Classe II



FR 6022-6022/HA

170 design
Paolo De Lucchi

Faretto in vetro stampato
Colori vetro interno: cristallo satinato, ambra satinato, acquamarina satinato
Colori vetro esterno: cristallo trasparente

Pressed glass recessed downlighter
Inner glass colours: satin crystal, satin amber, satin aquamarine
Colour outside glass: transparent crystal

FR 6022 * FR 6022/HA **

Colori / colours

Kg 1,1

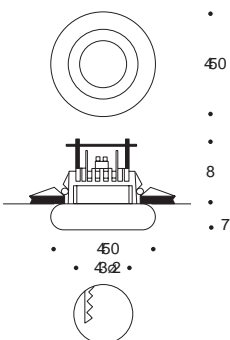

- cristallo crystal
- ambra amber
- acquamarina aquamarine

Lampadine / Bulbs

* GY 6,35 o/or GX 5,3 ø 51mm
1X max 50W 12V o/or 1X max 50W 12V



Classe III

G9
1X max 60W 230V



Classe II



FR 6013-6014-6014/HA

design
M & M

Faretto in vetro stampato
Colori: cristallo

Pressed glass recessed downlighter
Colours: crystal

FR 6013 *

Kg 0,35

FR 6014 ** FR 6014/HA ***

Kg 0,85

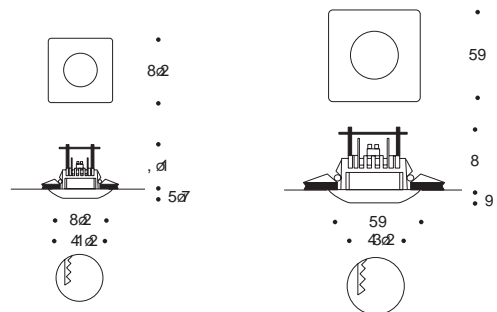

Colori / colours

- cristallo crystal

Lampadine / Bulbs

* GY 6,35 o/or GU 4 ø 35,3mm
1X max 35W 12V o/or 1X max 35W 12V



** GY 6,35 o/or GX 5,3 ø 51 mm
1X max 50W 12V o/or 1X max 50W 12V

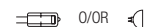

Classe III

*** G9
1X max 60W 230V



Classe II



FR 6023-6023/HA

design
Paolo De Lucchi

Faretto in vetro stampato
Colori vetro interno: cristallo satinato, ambra satinato, acquamarina satinato
Colori vetro esterno: cristallo trasparente

Pressed glass recessed downlighter
Inner glass colours: satin crystal, satin amber, satin aquamarine
Colour outside glass: transparent crystal

FR 6023 * FR 6023/HA **

Kg 1,1

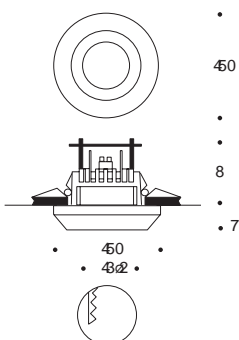

Colori / colours

- cristallo crystal
- ambra amber
- acquamarina aquamarine

Lampadine / Bulbs

* GY 6,35 o/or GX 5,3 ø 51mm
1X max 50W 12V o/or 1X max 50W 12V



Classe III

** G9
1X max 60W 230V



Classe II



FR 6016-6017-6017/HA

design
M & M

171

Faretto in vetro stampato
Colori: cristallo

Pressed glass recessed downlighter
Colours: crystal

FR 6016 * FR 6017 ** FR 6017/HA ***

Kg 0,45

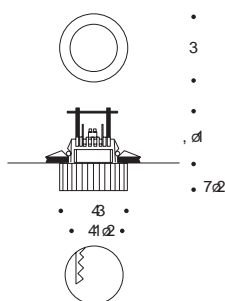

Colori / colours

- cristallo crystal

Kg 0,85

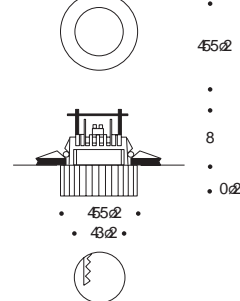

Lampadine / Bulbs

* GY 6,35 o/or GU 4 ø 35,3mm
1X max 35W 12V o/or 1X max 35W 12V
 o/OR

** GY 6,35 o/or GX 5,3 ø 51 mm
1X max 50W 12V o/or 1X max 50W 12V
 o/OR

Classe III

*** G9
1X max 60W 230V



Classe II

Note Notes

AVISO: Le immagini e le descrizioni del presente catalogo si intendono a titolo indicativo e non impegnativo. AVMAZZEGA si riserva la facoltà di modificare in qualunque momento e senza preavviso i prodotti illustrati nel presente catalogo, ferme restando le loro caratteristiche essenziali. I colori dei vetri sono suscettibili di piccole variazioni di tonalità, data la lavorazione artigianale. Tutti i materiali sono omologati CE. Su richiesta è possibile ottenere omologazioni diverse quali UL, SASO, ENEC. AVMAZZEGA è iscritta al consorzio Ecolight; il relativo feed viene da noi onorato, anche quello a carico del cliente. © E vietata, salvo espressa autorizzazione scritta, la riproduzione anche parziale di questo catalogo e dei suoi contenuti in tutte le sue forme, anche elettroniche. Qualora venga concessa la preventiva autorizzazione è fatto obbligo citarne la fonte. Il presente catalogo elimina e sostituisce i precedenti.

ATTENTION: Images and descriptions of this catalog is construed as an indication and not binding. AVMAZZEGA reserves the right to change at any time and without notice the products or accessories shown in this catalog, without prejudice to their essential characteristics. The colors of glass are susceptible to small changes in tone, given the hand-crafted. All materials are CE approved. On request it is possible to obtain various approvals such as UL, SASO, ENEC. AVMAZZEGA Ecolight enrolled in the consortium, its feed is honored by us, even those borne by the customer. © It is forbidden, without the express permission, the partial reproduction of this catalog and its contents in all its forms, including electronic. If prior authorization is granted, this shall cite the source. This catalog annuls and replaces the previous ones.

Marchi Marks

Classe I

Overo apparecchio provvisto di isolamento fondamentale in ogni parte e con parti conduttrici accessibili collegate ad un conduttore supplementare di protezione (messa a terra).

Classe I

appliance fitted with basic insulation throughout and with accessible live parts connected to a supplementary safety circuit (ground).

Classe II

overo apparecchio provvisto di doppio isolamento o isolamento rinforzato senza dispositivi per la messa a terra.

Class II

appliance fitted with double insulation or reinforced insulation without ground connection mise à la terre.

Classe III

overo apparecchio previsto per il funzionamento a bassissima tensione di sicurezza (12V), che non necessita del cavo di terra.

Class III

appliance designed for extra low safety voltage operation (12V), not requiring an earth lead.



Lampadine a basso consumo energetico
Low-energy consumption bulbs

* Gli asterischi a fianco del codice prodotto
** si riferiscono al tipo di lampadine utilizzabili
*** The asterisks next to the product code
**** refer to the type of light bulb that can be used



ELECTRO

www.modulelectro.ru

Graphic design:
Studio Ferruccio Montanari
Layout:
Ufficio Tecnico AVM

Photo:
Alessandro Paderni/studio eye, Studio Pointer,
Studio CSC, IdeaAzione, Fabrizio Bergamo,
Manuel Zublena, Rossi Dorianio.

Styling:
Monti studio
con/with Beppe Mangia
Thanks to: Frag

Printed in Italy by
GMV, Grafiche Marini, Villorba (Treviso)