

LIGHTINGICONS 2010/02

LIGHTINGICONS

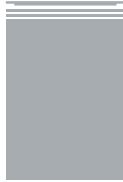

INDEX

8	POLIA
18	URIEL
28	VASILY
40	TECHNICAL DATA

POLIA



Collezione di lampade da parete in metallo verniciato bianco texturizzato o bianco con frontalino grigio basalto oppure con finitura effetto cor-ten. Disponibili in due misure e con lampadina alogena lineare.

Collection of wall lamps in textured white varnished metal or white with basalt grey front section or with cor-ten effect finishing. Available in two sizes and with linear halogen bulb.

Wandleuchtenkollektion aus texturiertem weiß lackiertem Metall, oder weiß mit basaltgrauer Frontblende oder mit cor-ten-Finish. In zwei Größen erhältlich, mit linearer Halogenlampe.

Collection d'appliques de métal vernis blanc texturé ou blanc avec une platine finition gris basalte ou finition effet cor-ten. Disponibles en deux dimensions et équipées d'ampoule halogène linéaire.

Colección de lámparas de pared en metal pintado blanco texturizado o blanco con frontal gris basalto o con acabado efecto cor-ten. Disponibles en dos dimensiones y con bombilla halógena lineal.

Коллекция настенных ламп из металла покрытых белой рябью; также предлагаются те же лампы но уже с передней деталью серо-базальтового цвета, либо другая вариация лампы имитирующая эффект ржавчины. Имеются в двух размерах и с галогеновой линейной лампочкой.









^ AP POLIA P WHITE (DETAIL)
< AP POLIA G COR-TEN
« PG 11: AP POLIA P BASALT GREY

US CODE
^ UA POLIA P WHITE (DETAIL)
< UA POLIA G COR-TEN
« PG 11: UA POLIA P BASALT GREY



^ AP POLIA P BASALT GREY
> AP POLIA P WHITE
» PG 16-17: AP POLIA G / AP POLIA P WHITE AND COR-TEN

US CODE
^ UA POLIA P BASALT GREY
> UA POLIA P WHITE
» PG 16-17: UA POLIA G / UA POLIA P WHITE AND COR-TEN

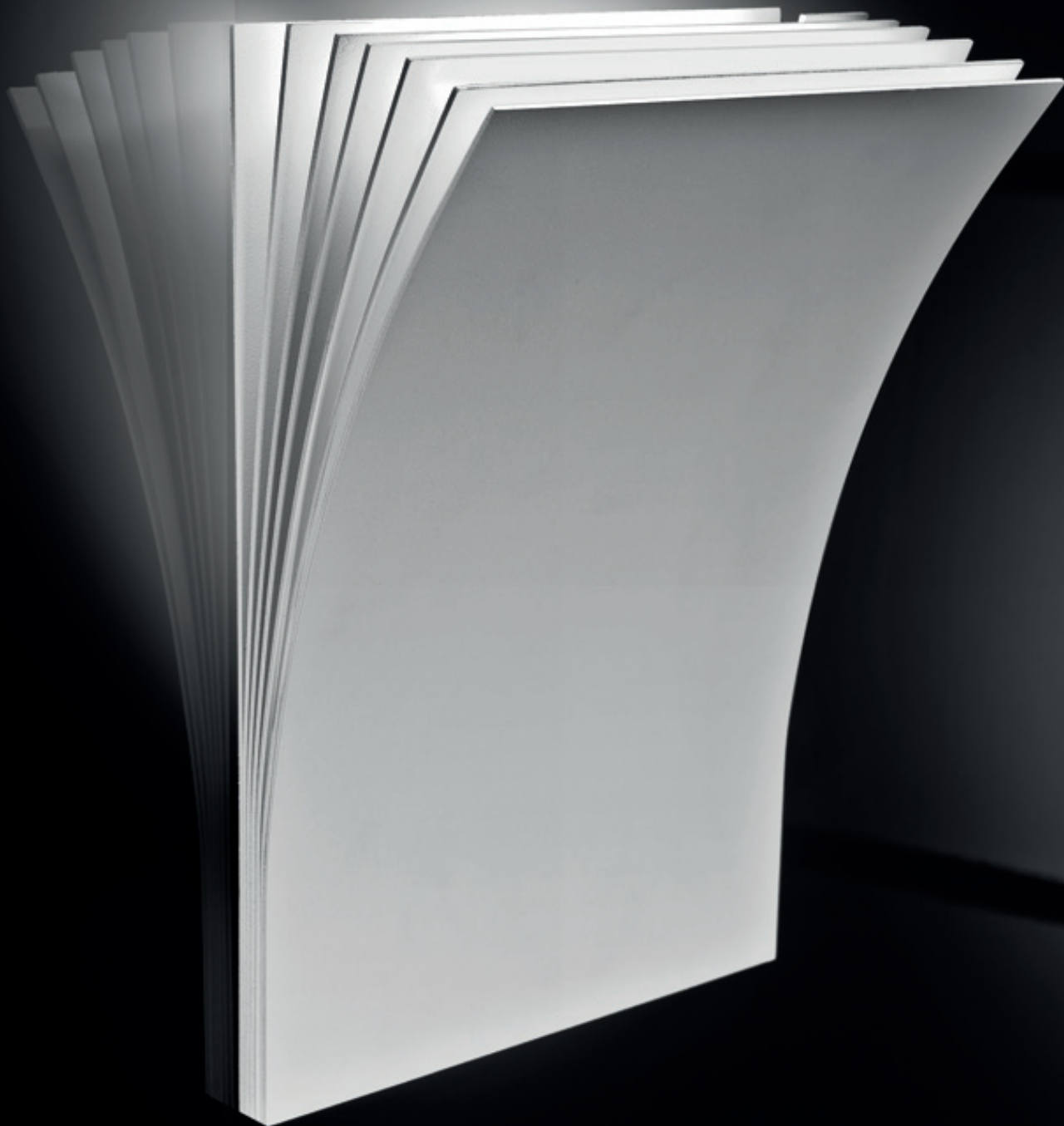







URIEL

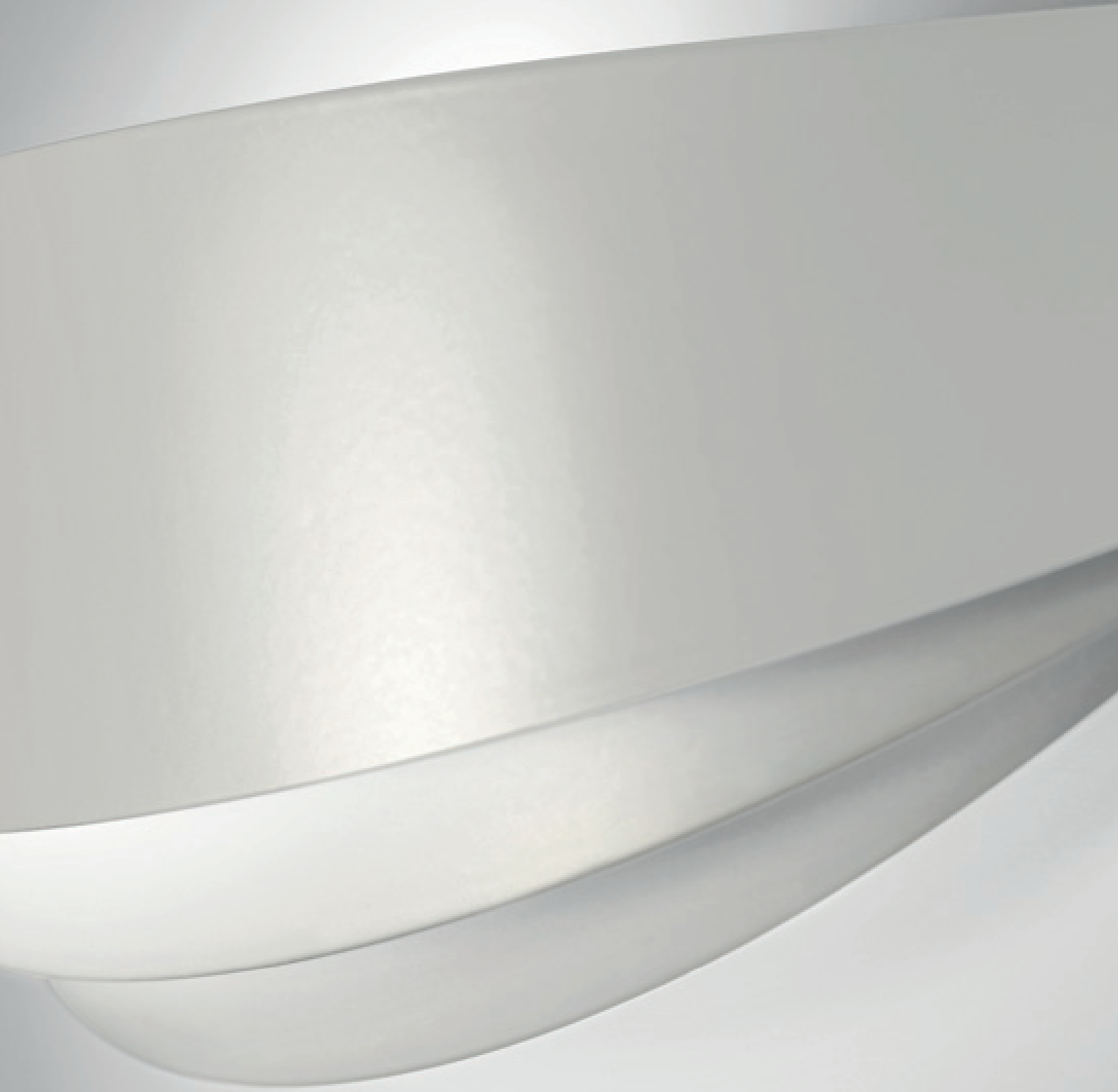

Collezione di lampade da parete in metallo incurvato e verniciato nei colori bianco perla, bronzo o finitura cromo. Disponibili in due misure e con lampadina alogena lineare.

Collection of wall lights in curved metal, varnished in pearl white or bronze colours or available with chrome finishing. Two sizes and linear halogen bulb.

Wandleuchtenkollektion aus gebogenem Metall, lackiert in den Farben Perlweiß, Bronze oder mit Chrom-Finish. In zwei Größen erhältlich, mit linearer Halogenlampe.

Collection d'appliques de métal courbé et vernis dans les couleurs blanc perle, bronze et finition chromée. Disponibles en deux dimensions et équipées d'ampoule halogène linéaire.

Colección de lámparas de pared en metal curvado y pintado en los colores blanco perla, bronce o acabado cromo. Disponibles en dos dimensiones y con bombilla halógena lineal.

Коллекция настенных ламп из искривлённого металла, покрытого цветом: белый жемчуг, бронза, хром. Предлагается в двух размерах с галогеновой линейной лампочкой.

URIEL
DESIGN MANUEL VIVIAN



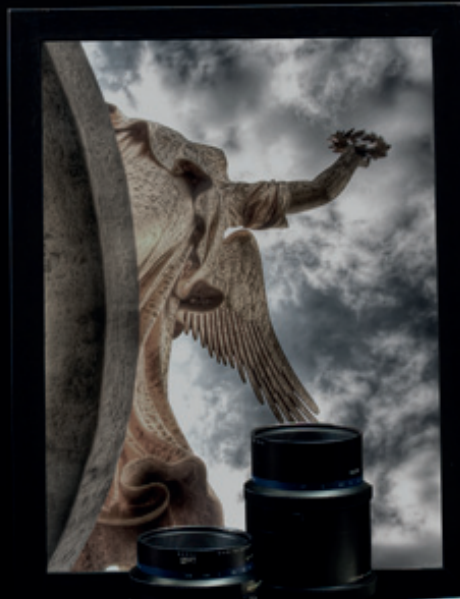





^ AP URIEL P WHITE (DETAIL)
< AP URIEL P CHROME
« PG 21: AP URIEL P WHITE

US CODE
^ UA URIEL P WHITE (DETAIL)
< UA URIEL P CHROME
« PG 21: UA URIEL P WHITE



- ^ AP URIEL P WHITE (DETAIL)
- > AP URIEL P CHROME (DETAIL)

US CODE

- ^ UA URIEL P WHITE (DETAIL)
- > UA URIEL P CHROME (DETAIL)





^ AP URIEL G BRONZE (DETAIL)
> AP URIEL G BRONZE

US CODE

^ UA URIEL G BRONZE (DETAIL)
> UA URIEL G BRONZE





VASILY



Lampada da parete disponibile in metallo verniciato bianco texturizzato o in acciaio lucido. Sorgente luminosa alogena.

Wall light available in textured white varnished metal or in polished steel. Halogen light source.

Wandleuchte erhältlich in texturiertem weiß lackiertem Metall, oder in glänzendem Stahl. Halogenlichtquelle.

Applique disponible en métal vernis blanc texturé ou en acier brillant. Source de lumière halogène.

Lámpara de pared disponible en metal pintado blanco texturizado o en acero. Fuente luminosa halógena.

Настенная лампа из металла покрытого белой рябью, также предлагается модель из блестящей стали. Источник света галогеновый.





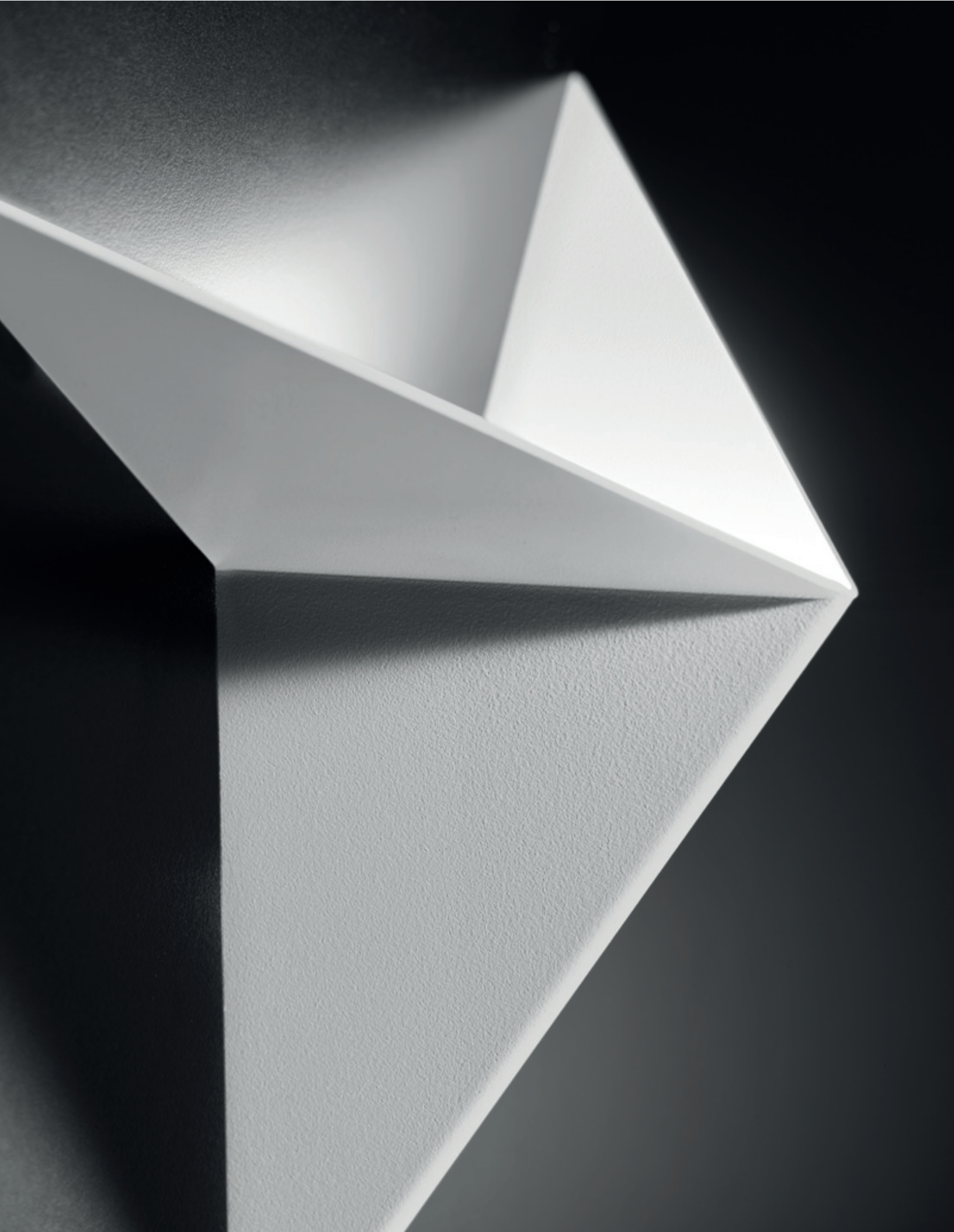



^ AP VASILY WHITE
< AP VASILY WHITE (DETAIL)
« PG 31: AP VASILY WHITE



- ^ AP VASILY STEEL
- ^ AP VASILY STEEL
- > AP VASILY WHITE

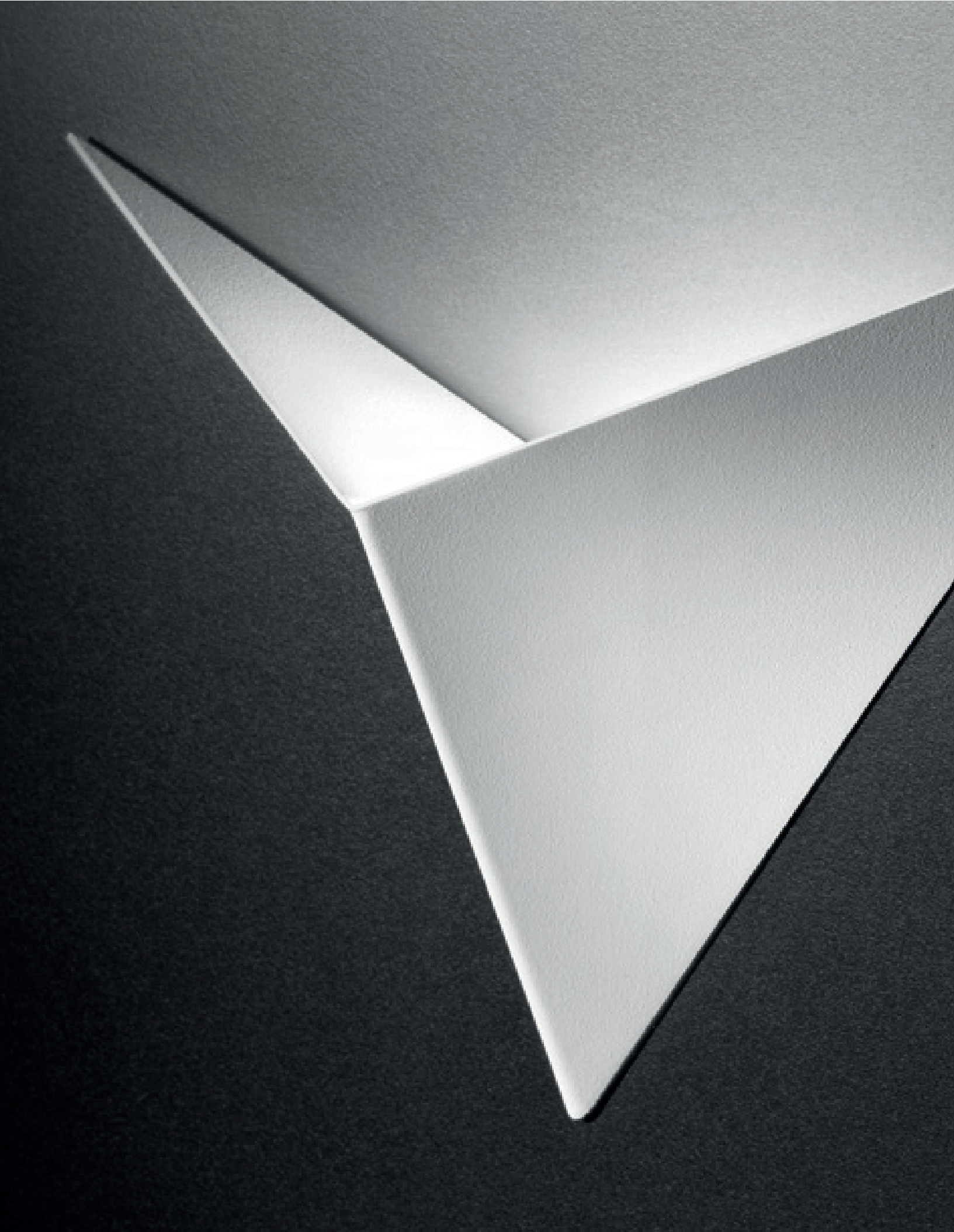





^ AP VASILY STEEL
< AP VASILY STEEL WITH BACKPLATE
» PG 38-39: AP VASILY STEEL

US CODE
< UA VASILY STEEL WITH BACKPLATE





TECHNICAL DATA

CE I nostri prodotti sono tutti sottoposti alle prove di sicurezza elettrica e conformi alle Direttive Comunitarie Europee EN60598-1, LVD 2006/95/EC, EMC 2004/108/EC (ove previsto).

All our products undergo to electric safety tests and conform to ECC Directive EN60598-1, LVD 2006/95/EC, EMC 2004/108/EC (as required).

Entsprechend den Europäischen Normen EN60598-1, LVD 2006/95/EC, EMC 2004/108/EC (sofern vorgesehen), werden alle Produkte den elektrischen Sicherheitsprüfungen unterzogen.

Tous nos produits sont soumis aux tests de sécurité, et sont conformes aux Directives CEE EN60598-1, LVD 2006/95/EC, EMC 2004/108/EC (le cas échéant).

Todos nuestros productos han sido sometidos a las pruebas de seguridad eléctrica y son conformes con las directivas comunitarias europeas EN60598-1, LVD 2006/95/EC, EMC 2004/108/EC (en los casos previstos).

Все наши изделия проходят испытания на электрическую безопасность и соответствуют директивам Европейского Сообщества EN60598-1, LVD 2006/95/EC, EMC 2004/108/EC (в случаях, когда это предусмотрено).

ETL-P Prodotto in fase di certificazione ETL. Contattare Axo Light per ulteriori informazioni e aggiornamenti.

This item is currently undergoing ETL certification. Please contact Axo Light for further information and updates.

Das Produkt wird gerade auf Zulässigkeit zur Führung des ETL-Zeichens geprüft. Für weitere Informationen und Aktualisierungen wenden Sie sich bitte direkt an Axo Light.

Produit en cours de certification ETL. Contacter Axo Light pour toutes informations et mises à jour ultérieures.

Producto en fase de certificación ETL. Póngase en contacto con Axo Light para obtener ulteriores informaciones y actualizaciones.

Изделие на этапе сертификации ETL. Обратиться в Axo Light для получения более подробной и актуальной информации.



Solo isolamento fondamentale;
le parti conduttrici accessibili sono
collegate ad un conduttore di terra.
Messa a terra obbligatoria.

Basic insulation, accessible
conductors are earthed.
Earthing is obligatory.

Grundisolation: berührbare
Metallteile mit Anschlussstelle
für Schutzleiter verbunden.
Netzschutzleiter: vorgeschrieben.

Isolation de base: les parties
conductrices accessibles sont mises
à terre. Mise à terre obligatoire.

Solo aislamiento fundamental;
las partes conductoras accesibles
están conectadas a un conductor
de tierra. Puesta a tierra obligatoria.

Изоляция только базовая. Доступные
проводниковые части подсоединены
к заземлителю. Заземление
обязательно.



Prodotto conforme alla normativa
Usa A.D.A. (protruding objects).



Product conforms to the Usa
A.D.A. standards (protruding objects).















Produkt Gemäss Usa-Regelung
A.D.A. (protruding objects).

Produit conforme à la norme
Usa A.D.A. (protruding objects).

Producto conforme con la normativa
Usa A.D.A. (protruding Objects).

Изделие соответствует нормативам
сша A.D.A. (protruding objects).

	<p>APPLIQUE WALL LAMP</p>	<p>I codici e le note segnalati in rosso fanno riferimento al mercato Nordamericano.</p>
	<p>G9 ALOGENA G9 HALOGEN</p>	<p>Codes and information written in red refer to the North American market.</p>
	<p>R7S ALOGENA R7S HALOGEN</p>	<p>Die Artikelnummern und die Anmerkungen in rot beziehen sich auf den Nordamerikanischen Markt.</p> <p>Les codes et les notes indiqués en rouge se réfèrent au marché Nord-américain.</p> <p>Los códigos y las notas escritas en rojo se refieren al mercado Norteamericano.</p> <p>Коды и примечания, выделенные красным цветом, относятся к североамериканскому рынку.</p>

COLLEZIONE COLLECTION	CODICE CODE	TIPO TYPE	DIMENSIONE DIMENSIONS					LAMPADINE LIGHT BULBS			DATI DATA	PAG	
			DIAMETRO CM	ALTEZZA CM	LARGHEZZA CM	PROFONDITÀ CM	PESO KG	VOLUME M ³	N	TIPO			W MAX
			DIAMETER INCH	HEIGHT INCH	WIDTH INCH	DEPTH INCH	WEIGHT LB	VOLUME FT ³	N	TYPE			W MAX
POLIA	AP POLIA P UA POLIA P		28 11 1/4	19 7 1/2	9.5 3 3/4	2 4.4	0.025 0.88	1	 78 EV	120	 ADA ETL-P	11 13>16	
	AP POLIA G UA POLIA G		28 11 1/4	45 17 3/4	9.5 3 3/4	4.8 10.6	0.04 1.41	1	 118 EV	160	 ADA ETL-P	12 16/17	
URIEL	AP URIEL P UA URIEL P		11 4 3/8	32.5 12 3/4	8.5 3 3/8	1 2.2	0.02 0.71	1	 78 EV	120	 ADA ETL-P	21>25	
	AP URIEL G UA URIEL G		15 5 7/8	61 24	10 4	2.5 5.5	0.08 2.83	1	 118 EV	160	 ADA ETL-P	26/27	
VASILY	AP VASILY UA VASILY		21.5 8 1/2	32 12 5/8	10 4	1 2.2	0.02 0.71	1	 60	60	 ADA ETL-P	31>39	

AP POLIA P
 UA POLIA P

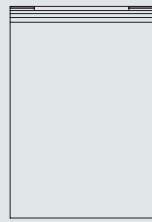

28 - 11 1/4"

19 - 7 1/2"



9.5 - 3 3/4"

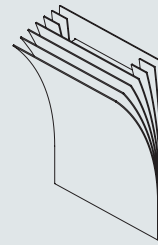

9.5 - 3 3/4"

AP POLIA G
 UA POLIA G

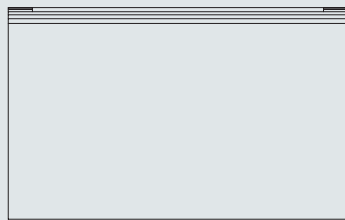

28 - 11 1/4"

45 - 17 3/4"



9.5 - 3 3/4"

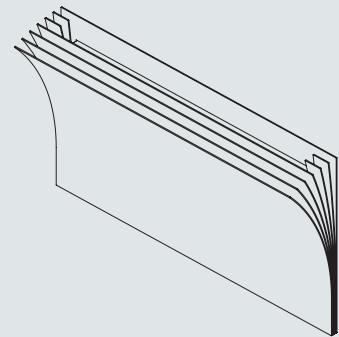

9.5 - 3 3/4"

AP URIEL P



32.5 - 12 3/4"

11 - 4 3/8"

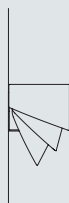

8.5 - 3 3/8"

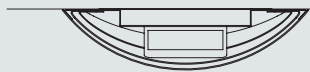
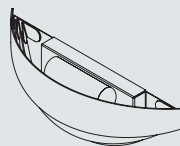

8.5 - 3 3/8"

UA URIEL P



32.5 - 12 3/4"

12 - 4 3/4"

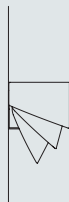

8.5 - 3 3/8"

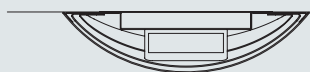
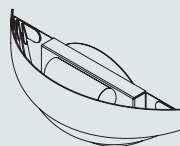

8.5 - 3 3/8"

AP URIEL G
UA URIEL G

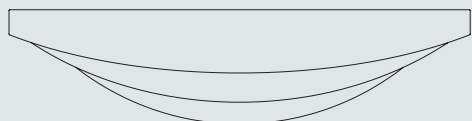

61 - 24"

15 - 5 7/8"

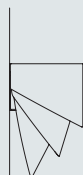

10 - 4"

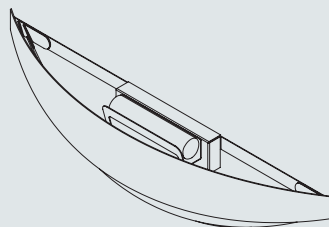

10 - 4"

AP VASILY

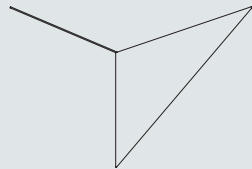

32 - 12 5/8"

21.5 - 8 1/2"



10 - 4"

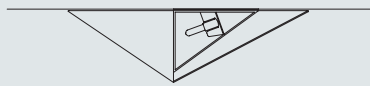
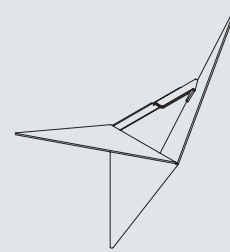

10 - 4"

UA VASILY

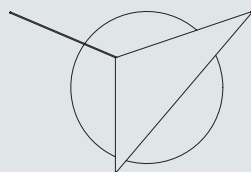

32 - 12 5/8"
backplate Ø 20 - 7 7/8"

21.5 - 8 1/2"



10 - 4"

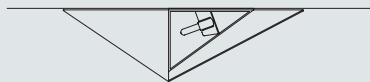
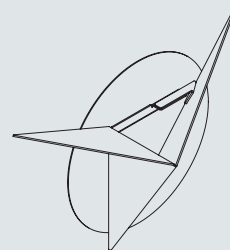

10 - 4"



Axo Light si riserva il diritto di apportare ai modelli, senza alcun preavviso, qualsiasi modifica ritenesse opportuna. Axo Light non risponde per eventuali danni a persone o cose causati da una non corretta installazione dei propri apparecchi d'illuminazione. I dati riportati sono puramente indicativi; è possibile che siano riportati degli errori di stampa.

Axo Light reserves itself the right to introduce any changes to its own models, without prior notice. Axo Light is not liable for injuries or damage due to the incorrect installation of its fixtures. The details given here are intended purely as guidance as errors may have occurred during the printing process.

Axo Light behält sich das Recht vor, jederzeit und ohne Voranmeldung, Änderungen der Kollektion vorzunehmen, ohne jedoch die charakteristischen Eigenschaften der Artikel zu ändern. Axo Light ist nicht verantwortlich für eventuelle Personen- oder Sachschäden, verursacht durch unsachgemäße Installation der Produkte. Aufgrund möglicher Druckfehler, sind die angegebenen Daten lediglich als Richtwerte zu verstehen.

Axo Light se réserve le droit de modifier ses collections à tous moments et sans préavis, dans le respect des caractéristiques de base du produit. Axo Light ne répond pas aux éventuels dommages à personnes ou choses causés par une mauvaise installation de ses appareils d'éclairage. Les coordonnées mentionnées sont purement indicatives; il est possible que des erreurs d'impression y figurent.

Axo Light se reserva el derecho de aportar a los propios modelos, sin ningún preaviso, cualquier modificación que se considere oportuna. Axo Light no responde por los eventuales daños causados a personas o cosas provocados por una incorrecta instalación de los propios aparatos de iluminación. Los datos que aparecen son puramente indicativos; es posible que contengan errores de impresión.

Ахо Light оставляет за собой право вносить модификации моделей без предупреждения, в случае необходимости. Ахо Light не несёт ответственности за ущерб людям или вещам, вызванный некорректной установкой осветительных приборов. Приведенные данные носят иллюстративный характер; возможны опечатки.

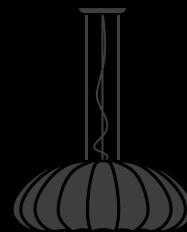
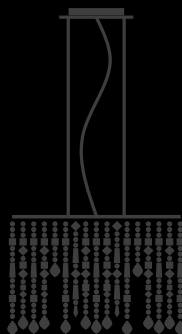
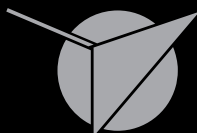
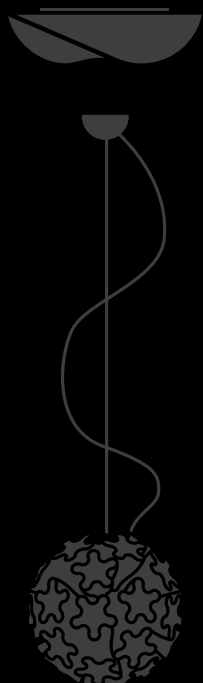
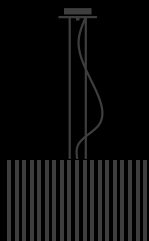

AXO LIGHT SRL
 via Moglianese 44
 30037 Scorzè
 Venezia, Italy
 t +39 041 5845193
 f +39 041 5845060

AXO LIGHT USA INC.
 22 Shelter Rock Lane
 Danbury, CT, 06810 USA
 t +1 (203) 730 0452
 f +1 (203) 730 0460
 info@axolightusa.com

AXO LIGHT ASIA NETWORK
 1911 Jinying Building
 1 Jinying Rd, Tianhe District
 510640 Guangzhou
 Guangdong Prov., PRC
 t +86 20 38316571
 f +86 20 38251165

www.axolight.it
 axolight@axolight.it

