



www.mediuelectro.ru



B.lux

Vanlux















































































deco

MODUL

ELETTRO



www.modulelettro.it

Indice Index Inhalt

3g   ↳P60	bel-la   ↳P174	duna   ↳P180	kanpazar    ↳P88 ↳P108
absid   ↳P166	bellaflor      ↳P20 ↳P66 ↳P98 ↳P160 ↳P172	eliana    ↳P27 ↳P181 ↳P182	kele    ↳P32 ↳P72
adorable   ↳P62 ↳P96	bluebird   ↳P24 ↳P65	emma   ↳P184	kele 2   ↳P73
arku   ↳P63 ↳P167	boletus   ↳P22	globe   ↳P101	luna   ↳P190
ala   ↳P164	boletus-outside   ↳P86	haro   ↳P186	maite   ↳P111
aroa   ↳P168	camelia   ↳P68	helios   ↳P102	mirror    ↳P33 ↳P74 ↳P191
atala   ↳P170	celys   ↳P139	hil   ↳P28	mística   ↳P36
axo   ↳P64	copa    ↳P140 ↳P175	jackie      ↳P29 ↳P70 ↳P110 ↳P188	mm   ↳P34
balart   ↳P138	cubic   ↳P25	jasone   ↳P30	nina & nino     ↳P38 ↳P76 ↳P112 ↳P192
basquet   ↳P18	dolce   ↳P176	julia       ↳P31 ↳P71 ↳P106 ↳P141 ↳P189	nite    ↳P37 ↳P114
batela   ↳P171	dolcetta      ↳P26 ↳P69 ↳P100 ↳P142 ↳P178	julieta      ↳P31 ↳P107 ↳P141 ↳P189	olympia     ↳P75 ↳P116 ↳P196

ovo  >P197

petite    >P40 >P78 >P198

pinot   >P118 >P202

pío pío  >P42 >P200

pisa  >P201

q.bo    >P44 >P144 >P203

quadrat    >P120 >P146 >P204
>P122

regina     >P48 >P79 >P130 >P210

rca     >P46 >P80 >P124 >P206

ronda     >P50 >P82 >P128 >P148

san marco  >P52

sandy  >P208

sare  >P211

skin   >P83 >P132
>P134

sor   >P54 >P212

spring  >P58

taps   >P57 >P85

teide  >P131



tomi  >P43

ura  >P214

veroca  >P150

veroca print  >P154

zentrum   >P158 >P216

zip   >P161 >P216

www.modulelectro.ru

Indice Index Inhalt

luminarias de
mesa
table-lamps
tischleuchten



basquet

página 18



bellaflor

página 20

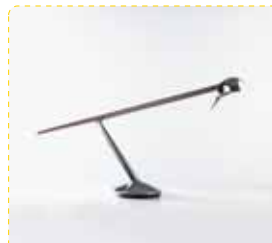

bluebird

página 24



boletus

página 22



cubic

página 25

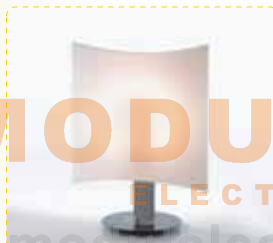

dolcetta

página 26



eliana

página 27

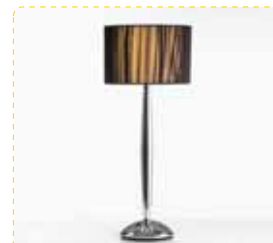

hil

página 28



jackie

página 29



jasone

página 30



julia

página 31



julieta

página 31



kele

página 32



mirror

página 33



mm

página 34



mística

página 36

6

13
diseñadores
designers
designer

14
fabricantes
manufacturers
hersteller



nina & nino página 38

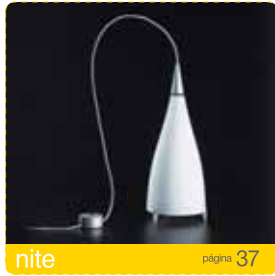

nite página 37



petite página 40



pío pío página 42



q.bo página 44



rca página 46



regina página 48

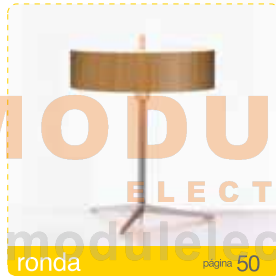

ronda página 50



san marco página 52



skin página 53



sor página 54



spring página 56

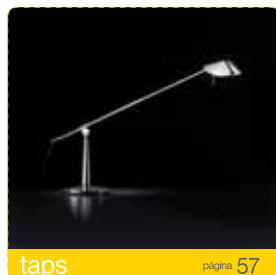

taps página 57



tomi página 43



3G página 60



adorable página 62



arku página 63



axo página 64



bellafior página 66

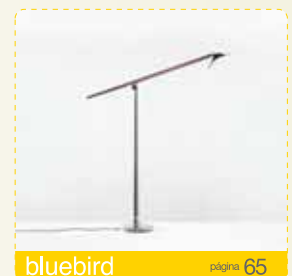

bluebird página 65

MODULO ELECTRO
www.modulelectro.ru

luminarias de pie
Floor lamps
stebbleuchten



camelia

página 68



dolcetta

página 69



jackie

página 70



julia

página 71



kele / kele 2

página 72 / 73



mirror

página 74



nina & nino

página 76

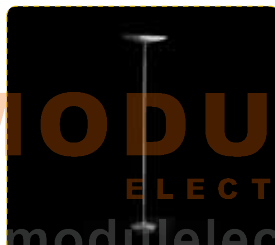

olympia

página 75



petite

página 78



rca

página 80

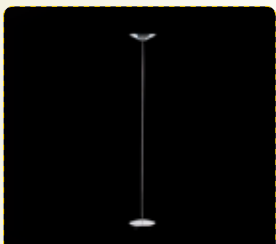

regina

página 79



ronda

página 82



taps

página 85



boletus outside a/b

página 86



kanpazar 150 a/b

página 88



kanpazar 150 c/d

página 90



kanpazar 80 a/b/c

página 92



adorable

página 96



bellafior

página 98



dolcetta

página 100

luminarias de
suspension
suspension lamps
hängelleuchten



globe página 101



helios 60 madera página 102

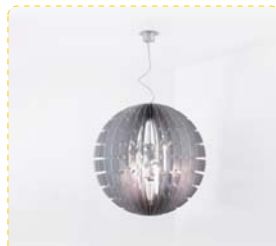

helios 60/90 metal página 104



jackie página 110



julia página 106



julieta 1/2/3 página 107



kanpazar susp. 150/80 página 108

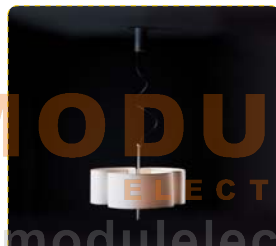

maite página 111

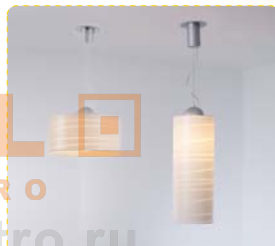

nina & nino página 112



nite 1/2/3 página 114



olympia página 116



olympia billar página 117



pinot 1/2/3 página 118



quadrat 60x60 página 120



quadrat 120x10 página 122



rca s 1/2/3 página 124



rca m 1/2/3 página 126



ronda página 128

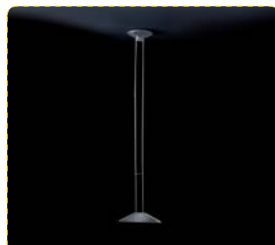

regina página 130



teide página 131

MODULO ELECTRO
www.modulelectro.ru



skin s

página 132



skin c

página 134

plafones
ceiling lamps
deckenleuchten



balart

página 138



bellafior

página 160



celys

página 139



copa

página 140



julia

página 141



julietta

página 141



dolcetta

página 142



q.bo

página 144



quadrat 60x60

página 146



ronda

página 148



veroca

página 150



veroca print

página 154



zentrum

página 158



zip

página 161



absid

página 166



ala

página 164

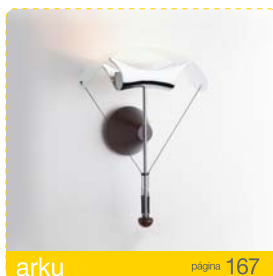

arku

página 167



aroa

página 168

apliques
wall lamps
wandleuchten



atala página 170



batela página 171



bel-la página 174



bellaflor página 172



copa página 175



dolce página 176



dolcetta página 178

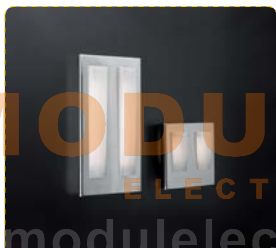

duna página 180

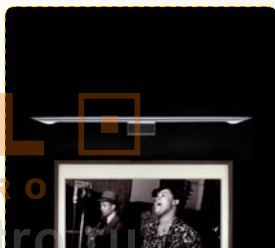

eliana cuadro página 181



eliana aplique página 182



emma página 184



haro página 186



jackie página 188



julia & julieta página 189



luna página 190



mirror página 191



nina & nino página 192



nora página 194



olympia u/d página 196



ovo página 197

MODULO ELECTRO
www.modulelectro.com



petite página 198



pinot página 202



pío pío página 200



pisa página 201



q.bo página 203



quadrat página 204



rca página 206

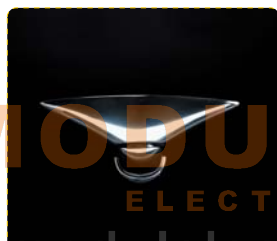

regina página 210



sandy página 208



sare página 211



sor página 212



ura página 214



zentrum página 216



zip página 215

MODULO ELECTRO
www.moduloelectro.ru



aia salazar - navarro



gemma bernal



quim larrea / gonzalo milá



f. j. martínez soto



francesc vilaró



diego fortunato



mario ruiz



josep novell / josep puig



paul bevis



miguel ángel ciganda



jon santacoloma



miguel herranz



jan van lieerde



jorge pensi



jonathan daifuku



eduardo albers



beppe benenti



héctor fernández



carlos serra



c. torrente / p. roviras



m. ybargüengoitia

Diseñadores Designers Designer

diseñadores

Todas las luminarias de B.Lux y Vanlux son fruto de la colaboración con reconocidos diseñadores, en consonancia con nuestro objetivo de canalizar la riqueza creativa de profesionales consagrados y jóvenes promesas. El resultado es la elaboración de una oferta de producto coherente, innovadora y permanentemente actualizada.

designers

All of the B.Lux and Vanlux lights are the fruit of cooperation with recognised designers, in accordance with our objective of channelling the creative wealth of distinguished professionals and promising young designers. The result is a coherent, innovative and constantly updated product range.

designer

Alle Lichtquellen von B.Lux y Vanlux entspringen der Zusammenarbeit anerkannter Designer in Übereinstimmung mit unserem Ziel, den kreativen Reichtum etablierter Profis und junger Talente zu kanalisieren. Das Ergebnis ist die Erstellung eines stimmigen, innovativen und ständig aktualisierten Produktangebots.



MODUL
ELECTRO
www.modulelectro.ru

FABRICANTES

fabricantes

B.Lux y Vanlux (Grupo B.Lux) constituyen uno de los grandes referentes en la fabricación de luminarias a nivel nacional. Cuenta con una planta de fabricación propia de 5.000 m² en el municipio vizcaíno de Gizaburuaga, destinado a la edición, desarrollo, fabricación, mecanizado, pintura y embalaje de las luminarias. La empresa dispone también de otra planta de 1.000 m² en Berriz, donde se encuentran las dependencias del departamento comercial y producto terminado.

Esta infraestructura, junto con los más de 25 años de sólida trayectoria, posicionan a B.Lux y Vanlux como una de las empresas más competentes en el desarrollo, fabricación y comercialización de aparatos de iluminación. Buena muestra de ello es la excelente calidad de los productos fabricados.

manufacturers

B.Lux and Vanlux (B.Lux Group) are one of the leading references in the manufacture of lighting products on a national scale. It has its own 5,000 m² production plant in the Biscayan municipality of Gizaburuaga, for the edition, development, automation, painting and packaging of the lights. The company also has another 1,000 m² plant in Berriz, where the commercial and end-product departments are located.

This infrastructure, combined with more than 25 years of sound experience, position B.Lux and Vanlux as one of the most competent companies in the development, manufacture and marketing of lighting appliances. Proof of this is the excellent quality of the manufactured products.

hersteller



B.Lux y Vanlux (Grupo B.Lux) stellt eine der groen Referenzen der Hersteller von Lichtquellen auf nationaler Ebene dar. Sie verfügt über ein eigenes Werk von 5.000 m² in der Gemeinde Gizaburuaga, die zur Herausgabe, Entwicklung, Herstellung, Bearbeitung, Lackierung und Verpackung von Lichtquellen gedacht ist. Die Firma verfügt auch über ein anderes Werk von 1.000 m² in Berriz, wo sich die Örtlichkeiten der Abteilungen für Vermarktung und gefertigtes Produkt befinden.

Diese Infrastruktur, zusammen mit 25 Jahren solider Karriere, bringt B.Lux y Vanlux auf die Position einer der kompetentesten Firmen bei der Entwicklung, Herstellung und Vermarktung von Beleuchtungsgeräten. Die ausgezeichnete Qualität der hergestellten Produkte ist ein guter Beweis hierfür.





luminarias de mesa
table lamps
tischleuchten

 **MODUL** 
ELECTRO
www.modulelectro.ru





MODUL 
ELECTRO
www.modulelectro.ru



MODUL

ELECTRO

www.modulelectro.ru

básquet

Gemma Bernal

B.lux

básquet

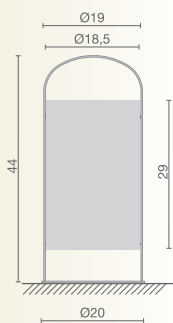

Luminaria de mesa con cuerpo metálico en acabado níquel. La pantalla, de forma cilíndrica, es textil de color gris cálido con acabados metálicos.

Table lamp with nickel-plated metal body. The cylindrical screen is made of warm grey fabric with metal finish.

Tischleuchte mit Textilschirm in Zylinderform. Lampenfuß und Bügel aus Metall.

INC. MÁX. 100W (E27)



MODULO
ELECTRO
www.modulelectro.ru

MODUL
ELECTRO
www.modulelectro.ru

bellaflor

Beppe Benenti

B.lux bellaflor



•P66 •P98 •P160 •P172

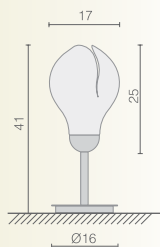

Luminaria de mesa fabricada en metal con acabado gris mate. Su difusor, con forma de flor, es de silicona y está compuesto por hojas amoldables que admiten diferentes posiciones, lo que permite regular la luz. Disponible en color blanco, amarillo, rojo y azul.

Metal table lamp in a matt grey finish. The flower-shaped diffuser has flexible silicon rubber leaves that can be moulded into different positions to regulate the light. Available in white, yellow, red and blue.

Tischleuchte mit mattgrauer Metallhalterung. Den Lampenschirm bilden verformbare Silikonblätter, mit denen sich unterschiedliche Beleuchtungseffekte erzielen lassen. Erhältlich in Weiß, Gelb, Rot und Blau.

 DIMMER
INC. GLOB. MÁX. 60W (E27) Ø120 mm.



MODUL
ELECTRO
www.modulelectro.ru





MODUL
ELECTRO
www.modulelectro.ru

boletus

Jorge Pensi

B.lux®

boletus

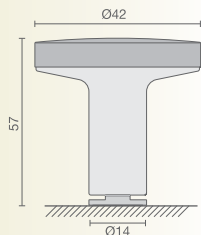

Luminaria de mesa o pie. Su parte superior es de latón repulsado acabado en níquel satin y su cuerpo de cristal triplex.

Table or floor lamp. Its upper part is of bevelled brass, finished in satin nickel and its body is of triplex glass.

Tisch-oder Stehleuchte. Das Oberteil ist aus gedrücktem Messing in satiniertes Nickel ausführung und der Leuchtenkörper ist aus Triplex-Glas.

FLUOR, COMP. CIRC, 22W (E27)
INC. MÁX. 75W (E27)



bluebird

Jorge Pensi

B.lux

bluebird



>P65

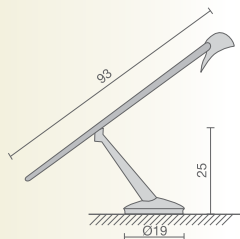

Luminaria de mesa halógena fabricada en zamak y madera lacada. Orientable. Acabados: metal cromado brillante y madera color caoba.

Halogen table lamp produced in zamak and lacquered wood. Adjustable. Finish: bright chrome metal and wood in mahogany colour.

Halogen-Tischleuchte aus Zamak und lackiertem Holz, ausrichtbar. Ausführungen: Verchromtes Metall glänzend und Holz in den Farben Mahagoni.

◇ HALOG. MÁX. 50W 12V (G6,35)



MODUL
ELECTRO
www.modulelectro.ru



Cubic

Jorge Pensi

Vanlux®

cubic

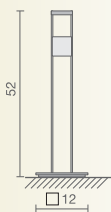

Luminaria
halógena de mesa
en metal cromado
con base gris y
difusor en
policarbonato
blanco.

Halogen table
lamp in chrome
metal with grey
base and white
polycarbonate
diffuser.

Halogen-
Tischleuchte aus
verchromtem
Metall mit grauem
Untergrund und
Diffusor aus
weißem
Polycarbonat.

♦ HALOG. MÁX. 50W 12V (G6,35)

MODULO
ELECTRO
www.modulelectro.ru



dolcetta

Manel Ybargüengoitia

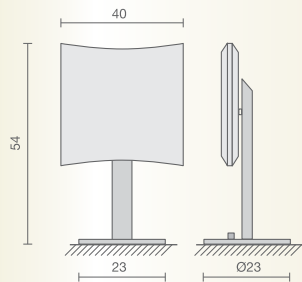

Luminaria de mesa fluorescente. Fuste en aluminio gris mate, base en gris antracita y difusor de tela en color blanco.

Fluorescent table lamp. Stand in matt grey aluminium, base in grey anthracite and textile diffuser in white colour.

Tischleuchte mit Leuchtstoffröhre. Schaft aus Aluminium in matt grau, Untergrund aus Anthrazitgrau und Diffusor aus weißem Stoff.

◇ FLUOR CIRC. 22W (2Gx13)

MODUL
ELECTRO

www.modulelectro.ru



eliana

Manel Ybargüengoitia

B.lux

eliana



>181
>182

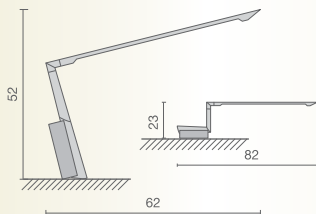

Luminaria de mesa fluorescente de acero y zamak acabada en gris metalizado. Permite dos posiciones de funcionamiento.

Fluorescent table lamp in steel and zamak. Finished in metalized grey. Two positions of function are permitted.

Tischleuchte mit Leuchtstoffröhre aus Stahl und Zamak, Ausführung in grau-metallisiert. Ermöglicht zwei Betriebsstellungen.

◇ FLUOR. 13W (w4,3) Ø7 mm.



MODUL
ELECTRO

www.modulelectro.ru





MODUL
ELECTRO
www.modulelectro.ru



hil

Paul Bevis

B.lux® hil

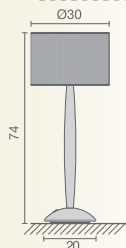

Luminaria de mesa con estructura metálica cromada, interruptor en la base y pantalla de hilos de seda de color tabaco.

Table lamp with a chromed metal structure, switch in the base and silk thread screen in a tobacco colour.

Tischleuchte mit verchromter Metallstruktur, Schalter am Fuß und Schirm aus Seidenfäden in Tabakfarbe.

◆ INC. OPAL MÁX. 100W (E27)

jackie

Josep Novell/Josep Puig

Blux®

jackie



SP70 SP110 SP188

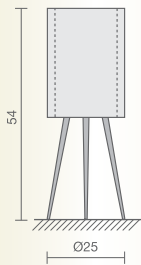

Luminaria de mesa. Difusor-contenedor de doble pared en metacrilato transparente y opalino que sirve para personalizar la luminaria introduciendo diferentes tipos de relleno. Soporte en tubo de acero conificado y cromado brillante.

Table lamp. Container diffuser with double covering in transparent and opaline methacrylate, which makes possible to personalize the lamp filling it up with different motives. Stand in cone shaped steel tubing.

Tischleuchte. Diffusor-Behälter mit doppelter Wand aus durchsichtigem oder opal Acrylglas, mit dem die Leuchte persönlich gestaltet werden kann. Konisch geformter Stahlrohrständer, glänzend, verchromt.

◆ INC. MAX. 100W (E27)
INC. GLOB. MAX. 100W (E27) Ø95 mm.
FLUOR. 23W (E27)



MODULO ELECTRO
www.modulelectro.ru





MODULO
ELECTRO

www.modulelectro.ru



jasone

Miguel Ángel Ciganda

B.lux jasone

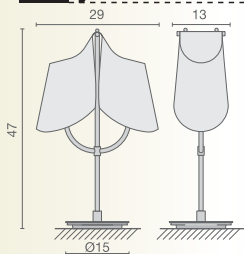

Luminaria de mesa con estructura acabada en acero inoxidable y pantalla de papel contracolado.

Table lamp with a structure finished in stainless steel and a laminated polyester screen.

Tischleuchte mit Struktur in rostfreiem Stahl und Schirm aus gegengeleimtem Papier.

⚡ HALOG, 2 x MÁX. 40W (G9)

julia & julieta

Manel Ybargüengoitia

B.lux®

julia & julieta



SP71 SP106 SP141 SP189
SP107

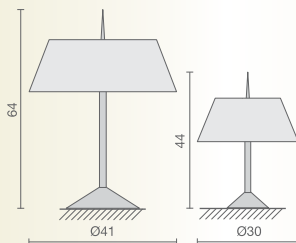

Luminarias fluorescentes de mesa. Metal acabado gris mate y difusor de metacrilato blanco mate que oculta totalmente la fuente de luz.

Fluorescent table lamps. Metal finished in matt grey and matt white methacrylate diffuser, which covers completely the light source.

Tischleuchte mit Leuchtstoffröhre. Metallausführung in matt grau und Diffusor aus matt weißem Acrylglas, das die Lichtquelle vollständig verbirgt.

♦ JULIA: FLUOR CIRC. 55W (2Gx13)
♦ JULIETA: FLUOR CIRC. 22W (2Gx13)



MODUL
ELECTRO
www.modulelectro.ru



MODUL
ELECTRO

www.modulelectro.ru

kele

Miguel Ángel Ciganda

vanlux kele



>P72

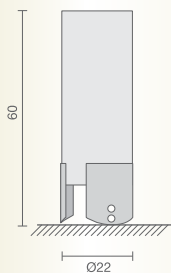

Luminaria fluorescente de mesa con difusor de tela blanca cruda y base de madera de haya curvada.

Fluorescent table lamp with natural white fabric diffuser and rounded beech wood base.

Tischleuchte mit Leuchtstoffröhre mit Diffusor aus roh-weißem Stoff und gekrümmter Untergrund aus Buchenholz.

FLUOR. 36W (2G11)



MODUL

ELECTRO

www.modulelectro.ru

mirror

Jan Van Lierde

B.lux mirror



SP74 SP191

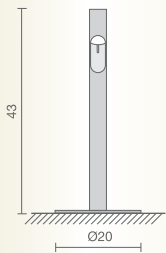

Luminaria de mesa halógena. Aluminio extruido lacado en gris metalizado. Haz de luz orientable mediante espejo reflector.

Halogen table lamp. Extruded aluminium lacquered in metalized grey. Adjustable beam by reflecting mirror.

Halogen-Tischleuchte. Extrudiertes Aluminium in grau-metallisiert. Ausrichtbarer Lichtstrahl mit reflektierendem Spiegel.

HALOG. MR8 MÁX. 20W 12V (Gz4)





mm

Francisco Javier Martínez Soto

B.lux[®] mm

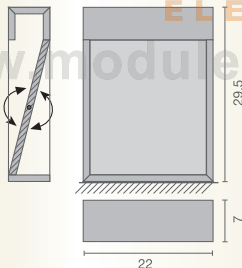

Luminaria de mesa fabricada en madera laminada de roble. Disponible en dos acabados. El acabado wengué dispone de un reflector cubierto de pan de oro, aplicado de manera artesanal, y el acabado en roble natural de pan de plata.

Table lamp made out of oak laminated wood. Available in two finishes. The wenge finish is available with a hand applied gold leaf reflector and the natural oak finish with silver leaf.

Tischleuchte aus Eichen-Schichtholz. Angeboten in zwei Ausführungen. Bei der Ausführung in Wenge ist der Reflektor mit Handwerkskunst vergoldet und bei der Ausführung in Natureiche versilbert.

INC. TUB. MÁX. 25W (E14)



MODULO
ELECTRO
www.modulelectro.ru

mística

Carlos Torrente / Pau Roviras

B.lux®

mística

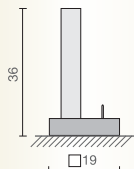

FLUORESCENTE

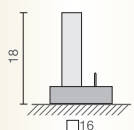

INCANDESCENTE

Luminarias de mesa con base en metal gris y difusor de vidrio opal. Dos versiones: fluorescente e incandescente.

Table lamps with grey metal base and opal glass diffuser. Two versions, fluorescent and incandescent.

Tischleuchte aus Metallfuß und Diffusor aus Opalglas. Zwei Versionen: Leuchtstoffröhre und Glühlampe.

FLUOR. 24W (2G11)
INC. TUB. MÁX. 40W (E14)

MODUL

ELECTRO

www.modulelectro.ru



nite

Jorge Pensi

8.lux*

nite



SPT14

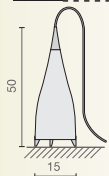

Luminaria de mesa en vidrio
soplado blanco opalino.

Table lamp in white opaline
hand blow glass.

Tischleuchte aus geblasenem
weißem Opalglas.

INC. MAX. 100W (E27)
INC. GLOB. MAX. 100W (E27) Ø95 mm.
FLUOR. 23W (E27)



MODULO
ELECTRO
www.modulelectro.ru



MODULO
ELECTRO
www.modulelectro.ru



nina & nino

MODUL

Gemma Bernal

B.lux®

nina & nino



SP76 SP112 SP192

nina

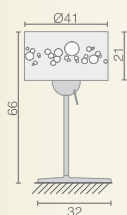

nino

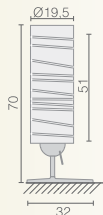

Luminarias de mesa con cuerpo metálico pintado y pantalla serigrafiada. Nina está disponible en dos versiones: fuste marrón combinado con pantalla marrón textil que dibuja círculos y fuste gris brillo combinado con pantalla de policarbonato blanco con rayas impresas. Nino está disponible en una única versión: fuste gris brillo con pantalla de policarbonato blanco con rayas impresas.

Metal table lamps in a matt grey finish with printed screen. The Nina model is available in two finishes: brown shaft with brown fabric screen with circle prints and shiny grey shaft with white polycarbonate screen with printed stripes. The Nino model is available in one finish: shiny grey shaft with white polycarbonate screen with printed stripes.

Tischleuchte mit mattgrauer Metallhalterung und bedrucktem Lampenschirm. Nina ist in zwei Ausführungen lieferbar: braunes Format mit in Kreisen bedrucktem, braunem Lampenschirm oder grauglänzendes Format mit in Strahlen bedrucktem Lampenschirm aus weißem Polycarbonat. Nino ist in einer Ausführung lieferbar: grauglänzendes Format mit in Strahlen bedrucktem Lampenschirm aus weißem Polycarbonat.

DIMMER
INC. GLOB. MÁX. 100W (E27)



petite

Miguel Herranz

 petite



<P78 >P188

Luminaria de mesa articulada y orientable, fabricada en aluminio extruido y compuesta de estructura y soporte. Disponible con pantalla de aluminio y policarbonato o con pantalla textil blanca cruda. Acabados: gris mate o anodizado.

Articulated, directable tabletop light made of extruded aluminium and including a structure and support. Available with an aluminium or polycarbonate screen or with a natural white fabric screen. Finishes: matt or anodised grey.

Tischleuchte mit Gelenken und ausrichtbar, hergestellt aus extrudiertem Aluminium und bestehend aus Struktur und Ständer. Angeboten mit Schirm aus Aluminium und Polycarbonat oder roh-weißem Textilschirm. Ausführungen: Matt grau oder anodisiert.



PETITE 21+, INC. MAX. 60W (E14)
PETITE 22+, INC. MAX. 60W (E27)

PETITE 11+, INC. MAX. 60W (E14)
PETITE 12+, INC. MAX. 60W (E27)



ESTRUCTURAS
STRUCTURES
STRUKTUR

PETITE 21

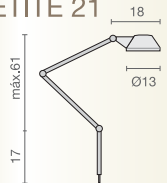

PETITE 22

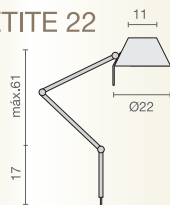

PETITE 11

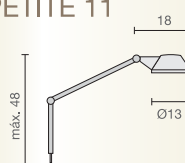

PETITE 12

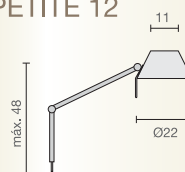

SOPORTES
BRACKETS
STÄNDER

a

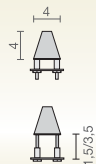

b

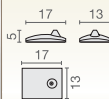

c

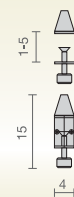

c



MODUL
ELECTRO

www.modulelectro.ru

PETITE 11

PETITE 21

PETITE 12

PETITE 22

πίο πίο

Manel Ybarguengoitia

Vanlux **πίο πίο**



SP200

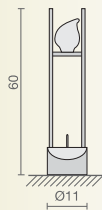

Luminaria halógena de mesa con base cromada y vidrio soplado acidado.

Halogen tabletop light with a chrome base and etched blown glass.

Halogen-Tischleuchte mit verchromtem Untergrund und geätztem, geblasenem Glas.

HALOG. MAX. 50W (G6,35)

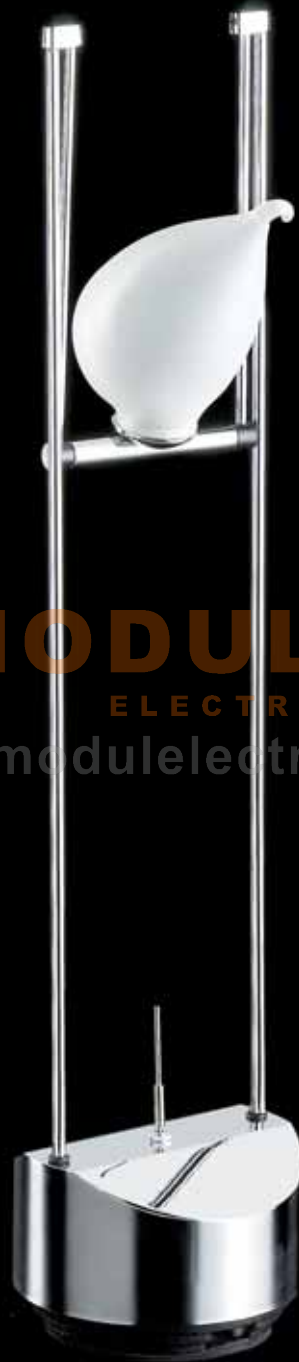

MODULO
ELECTRO
www.modulelectro.ru

tomi

Miguel Ángel Ciganda

B.lux

tomi

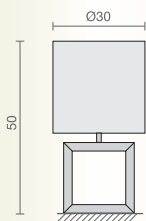

Luminaria de mesa. Metal aluminio gris mate y difusor de tela blanco crudo.

Table lamp. Matt aluminium metal grey and natural white textile diffuser.

Tischleuchte. Metall-Aluminium matt grau und Diffusor aus roh-weißem Stoff.

INC. MAX. 100W (E27)



MODULO ELECTRO

www.modulelectro.ru



MODUL
ELECTRO
www.modulselectro.ru

q.bo

Carlos Serra/Antonio Herrero

Vanlux® q.bo



SP144 SP203

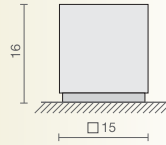

Luminaria de mesa con difusor de policarbonato. Permite incorporar pictogramas.

Table lamp with polycarbonate diffuser that permits the incorporation of pictograms.

Tischleuchte mit Diffusor aus Polycarbonat. Bietet die Möglichkeit, Piktogramme einzufügen.

FLUOR. 18W (Gx24 d-2)

MODUL
ELECTRO
www.modulelectro.ru



rca

Gemma Bernal

Blux® rca



SP80 SP124 SP206

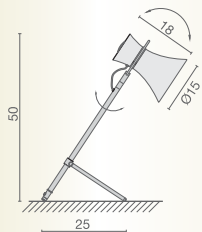

Luminaria de mesa con trípode metálico de acabado cromado. La pantalla, fabricada en aluminio pulido con acabado anodizado mate, es orientable.

Table lamp with a chrome finished metal tripod. The screen, made out of polished aluminium finished in anodized matt is adjustable.

made out of polished aluminium finished in anodized matt is adjustable.

Tischleuchte mit Metallfuß in verchromter Ausführung. Der Schirm ist aus poliertem und matt anodisiertem Aluminium und lässt sich in der Richtung ändern.

- ◆ INC. REFLECTORA MAX. 60W (E27)
- ◆ FLUOR. MASTER PL-E 15W (E27)
- ◆ FLUOR. DULUX EL LL 15W (E27)

MODULO
ELECTRO
www.modulelectro.ru





 **MODUL** 
ELECTRO
www.modulelectro.ru



MODUL
ELECTRO
www.modulelectro.ru



regina

Jorge Pensi

Blux® regina



SP79 SP130 SP210

MODUL ELECTRO

www.modulelectro.com

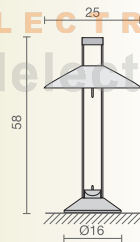

Luminaria de mesa halógena fabricada en aluminio pulido brillante. También vidrio blanco o azul.

Halogen table lamp produced in polished bright aluminium. Aluminium shade or glass in white or blue colour.

Halogen-Tischleuchte aus glänzend poliertem Aluminium. Weißes oder blaues Glas.

HALOG. 2 x MÁX. 20W 12V (G6,35)



MODUL
ELECTRO
www.modulelectro.ru



ronda

Jorge Pensi

B.lux®

ronda



SP82 SP128 SP148

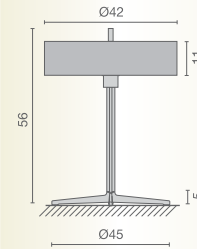

Luminaria de mesa con fuste y trípode de aluminio extruido inyectado, acabados en gris claro mate. Pantalla de madera curvada acabada en roble natural o wengué, con dos difusores de poliamida opal mate.

Table lamp with a shaft and tripod of injected extruded aluminium, in a light grey matt finish. Curved wooden screen finished in natural oak or wenge, with two opal matt polyamide diffusers.

Tischleuchte mit Schaft und Fuß aus extrudiertem, eingespritztem Aluminium, Ausführung in matt hellgrau. Gebogener Holzschirm aus Natureiche oder Wenge, mit zwei Diffusoren aus Polyamid in opal-matt.

FLUOR. CIRC. 40W (2Gx13)

MODULO ELECTRO
www.modulelectro.ru

San marco

Quim Larrea / Gonzalo Milá

B.lux®

san marco 16W / 22W / 26W

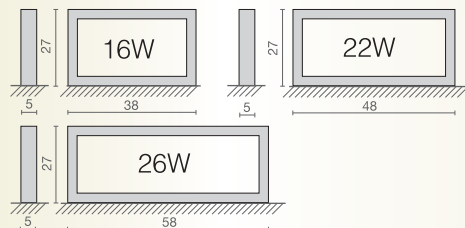

Luminaria de mesa realizada en aluminio extruido. Acabados: anodizado o antracita.

Table lamp produced in extruded aluminium. Finish: anodised or anthracite.

Tischleuchte aus extrudiertem Aluminium. Ausführungen: Anodisiert oder Anthrazit.

- 16W: FLUOR. 2 x 8W (w4,3) Ø7 mm.
- 22W: FLUOR. 2 x 11W (w4,3) Ø7 mm.
- 26W: FLUOR. 2 x 13W (w4,3) Ø7 mm.



MODULO
ELECTRO
www.moduloelectro.com



skin

AIA Salazar-Navarro

B.lux®

skin



SP132

SP134



Luminaria de mesa realizada en polimetacrilato opalino en blanco satinado, recubierto por una malla metálica cilíndrica de acero inox, lacada en acabados acero o bronce. Dispone de un asa para su transporte.

Table lamp made out of opaline polymethacrylate in satin white, coated in a stainless steel, cylindrical metal mesh, lacquered in steel or bronze finishes. Available with a handle for transportation

Tischleuchte aus Polyacrylglas in opal-weiß satiniert, überzogen mit einem zylinderförmigen Metallnetz aus Inox-Stahl, lackiert in den Ausführungen Stahl oder Bronze. Mit Transporthalter.

FLUOR. COMP. 2 x 36W (2G11)

MODULO ELECTRO
www.modulelectro.ru



MODUL
ELECTRO
www.modulelectro.ru

SOR

Jorge Pensi

Vanlux® SOR



SP212

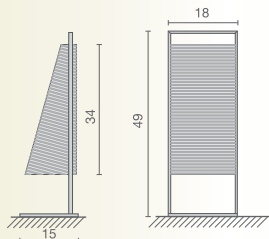

Luminaria de mesa de estructura metálica con acabado níquel satinado y pantalla realizada en poliéster contracolado.

Table lamp with a satin nickel finished metal structure, and laminated polyester screen.

Tischleuchte mit Metallstruktur in satiniertes Nickel ausführung und Schirm aus gegengeleimtem Polyester.

INC. OPAL MÁX. 60W (E27)





spring

Jorge Pensi

B.lux*

spring

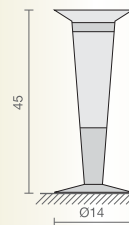

Luminaria de mesa. Acabado: vidrio transparente y metal en gris mate. Permite la colocación de flores u otros objetos en el recipiente de cristal.

Table lamp. Finish: transparent glass and metal in matt grey. It permits been decorated with flowers or different motives inside the glass container.

Tischleuchte. Ausführung: durchsichtiges Glas und Metall in matt grau. Bietet die Möglichkeit, Blumen oder andere Gegenstände in den Glasbehälter zu stellen.

MODUL
ELECTRO
modulelectro.ru

HALOSPOT 48 MÁX. 20W 12V (Gy 4)



taps

Jorge Pensi

B.lux

taps



>P88

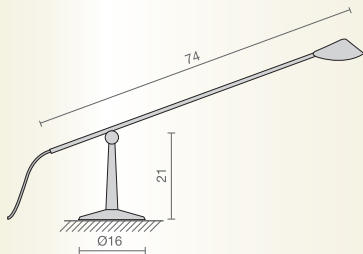

Luminaria de mesa halógena. Acabado en cromado brillante.

Halogen table lamp finished in bright chrome.

Halogen-Tischleuchte. Ausführung in glänzend verchromt.



◇ HALOG. MÁX. 50W 12V (G6,35)

MODUL
ELECTRO
www.modulelectro.ru





luminarias de pie
floor lamps
stehleuchten

 **MODUL** 
ELECTRO
www.modulelectro.ru

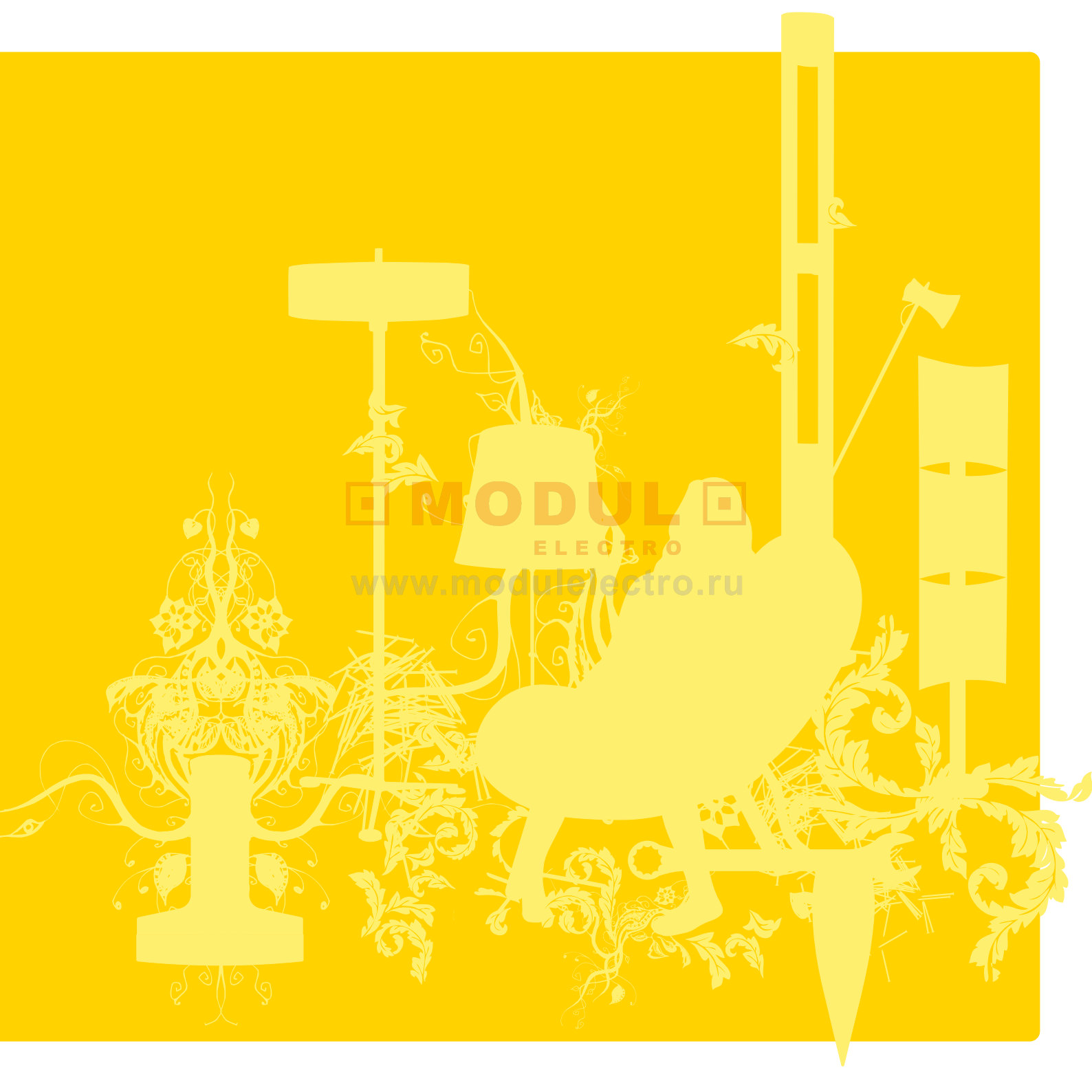

MODULO
ELECTRO
www.modulelectro.ru

3G

Mario Ruiz

B.lux® 3G

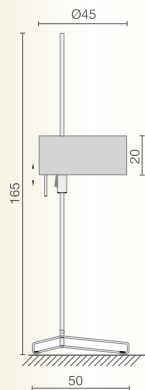

Luminaria de pie formada por un cuerpo y una pantalla cilíndrica, ambos fabricados en aluminio, con acabado blanco. Su base, con forma de X, está fabricada con barra de metal plegado. La pantalla de 3G posee mecanismo sube-baja.

Floor lamp with aluminium body and cylindrical screen in a white finish. It has an X-shaped base made of folded metal. The screen of the 3G is height adjustable.

Stehleuchte. Fuß und zylindrischer Lampenschirm aus weißem Aluminium. Gestell in Form eines X mit einem mechanischen Metallhebel. Der Lampenschirm der 3G lässt sich mechanisch anheben und absenken.

DIMMER

HALOG. MÁX. 100W (E27)

INC. GLOB. MÁX. 100W (E27)

MODULO
ELECTRO
www.modulelectro.ro

60





MODUL
ELECTRO
www.modulelectro.ru

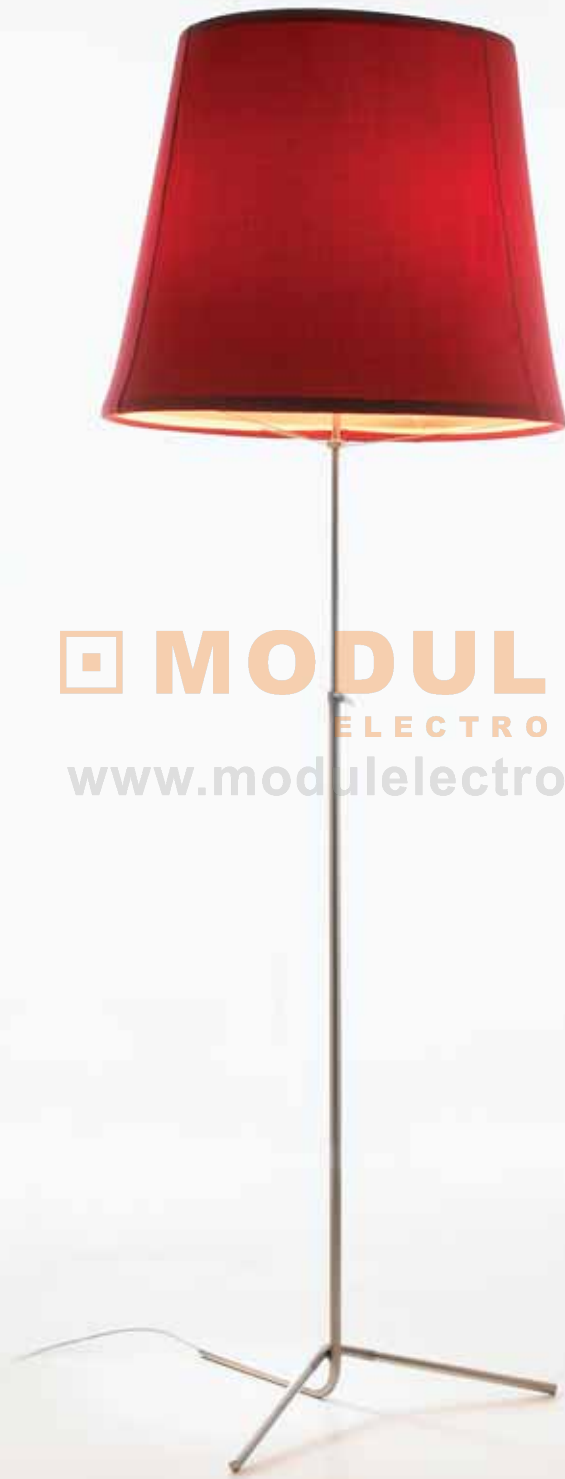

adorable

Diego Fortunato

B.lux

adorable



PF36

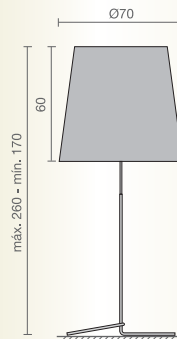

Luminaria de pie con pantalla de lana elástica negra, cruda o roja ignífuga. Fuste en acero inoxidable, regulable en altura.

Floor lamp with fireproof black, natural white or red stretch wool shade. Stand produced in stainless steel, being adjustable in height.

Stehleuchte mit elastischem Wollschirm in schwarz, roh oder rot, feuerfest. Schaft aus rostfreiem Stahl, in der Höhe verstellbar.

MODUL ELECTRO



DIMMER
INC. GLOB. 3 x MÁX. 100W (E27) Ø120 mm.

www.modulelectro.ru



arku

Miguel Ángel Ciganda

B.lux®

arku



EP167

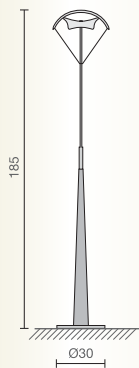

Luminaria halógena de pie fabricada en metal cromado brillante, cristal y madera acabado caoba.

Halogen floor lamp produced in bright chromed metal, glass and wood in mahogany finish.

Halogen-Stehleuchte aus glänzendem, verchromtem Metall, Glas und Holz in den Ausführungen Mahagoni.



DIMMER

HALOG. MAX. 250W (R7s) (L=78 mm.)

MODULO

ELECTRO

www.modulelectro.ru



axo

Miguel Ángel Ciganda

Blux®

axo

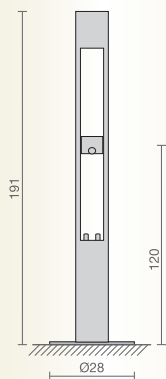

Luminaria de pie indirecta y de lectura, orientable. Acabado en gris mate.

Indirect floor lamp and adjustable hanging lamp. Finished in matt grey.

Stehleuchte mit indirektem Licht und ausrichtbarer Leselampe. Ausführung in matt grau.



DIMMER
HALOG. MAX. 300W (R7s)
DICR. 35W 12V (Gu4) Ø35 mm.

MODUL
ELECTRO

www.modulelectro.ru

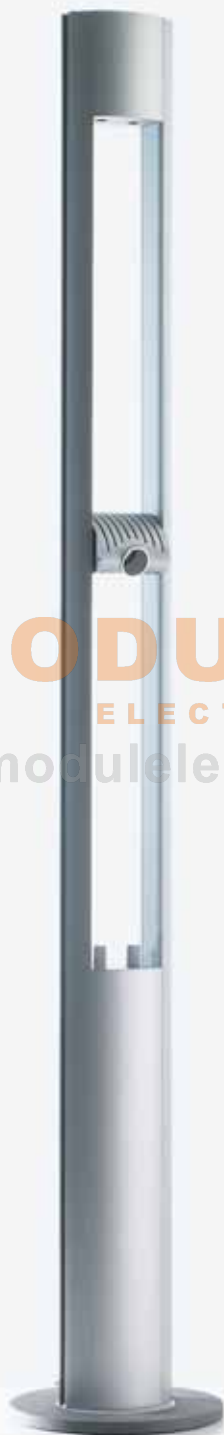



MODULO
ELECTRO
www.modulelectro.ru

bluebird

Jorge Pensi

B.lux®

bluebird



SP24

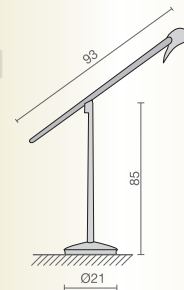

Luminaria de pie halógena fabricada en zamak y madera lacada. Orientable. Acabados: metal cromado brillante y madera color caoba.

Halogen floor lamp produced in zamak and lacquered wood. Adjustable. Finish: bright chrome metal and wood in mahogany colour.

Halogen-Stehleuchte aus Zamak und lackiertem Holz, ausrichtbar. Ausführungen: Verchromtes Metall glänzend und Holz in den Farben Mahagoni.

HALOG. MÁX. 50W 12V (G6,35)

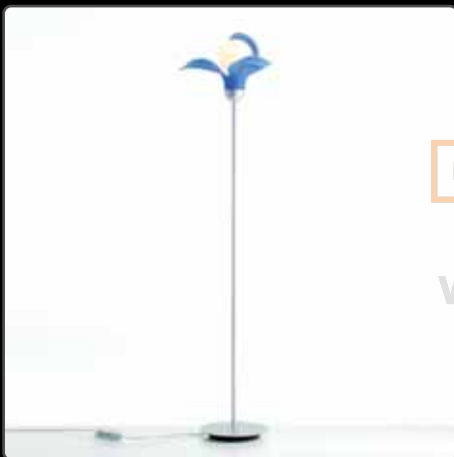

bellaflor

Beppe Benenti

B.lux

bellaflor



>P20 >P38 >P160 >P172

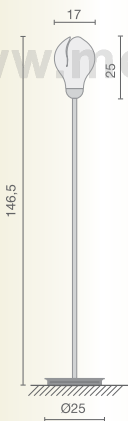

Luminaria de pie fabricada en metal con acabado gris mate. Su difusor, con forma de flor, es de silicona y está compuesto por hojas amoldables que admiten diferentes posiciones, lo que permite regular la luz. Disponible en color blanco, amarillo, rojo y azul.

Metal floor lamp in a matt grey finish. The flower-shaped diffuser has flexible silicon rubber leaves that can be moulded into different positions to regulate the light. Available in white, yellow, red and blue.

Stehlampe mit mattgrauer Metallhalterung. Den Lampenschirm bilden verformbare Silikonblätter, mit denen sich unterschiedliche Beleuchtungseffekte erzielen lassen. Erhältlich in Weiß, Gelb, Rot und Blau.



DIMMER

INC. GLOB. 100W (E27) Ø120 mm.



MODUL
ELECTRO
www.modulelectro.ru





Camelia

Miguel Ángel Ciganda

B.lux®

camelia

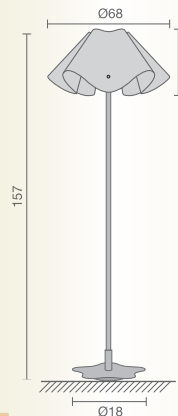

Luminaria de pie realizada en acero inoxidable, con pantalla de papel contracolado en color blanco crudo.

Stainless steel floor lamp with a laminated paper screen in a natural white colour.

Stehlampe aus rostfreiem Stahl mit Schirm aus gegengeleimtem Papier in roh-weißer Farbe.

INC, OPAL MÁX. 100W (E27)

MODUL
ELECTRO
www.modulelectro.ru





dolcetta

Manel Ybargüengoitia



Vanlux®

dolcetta

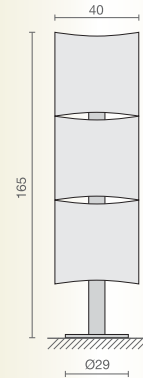

Luminaria de pie fluorescente. Fuste en aluminio gris mate, base en gris antracita y difusor de tela en color blanco.

Fluorescent floor lamp. Stand in matt grey aluminium, base in grey anthracite and textile diffuser in white colour.

Stehleuchte mit Leuchtstoffröhre. Schaft aus Aluminium in matt grau, Untergrund aus Anthrazitgrau und Diffusor aus weißem Stoff.

FLUOR. CIRC. 3 x 22W (2Gx13)

MODULO
ELECTRO
www.modulelectro.ru

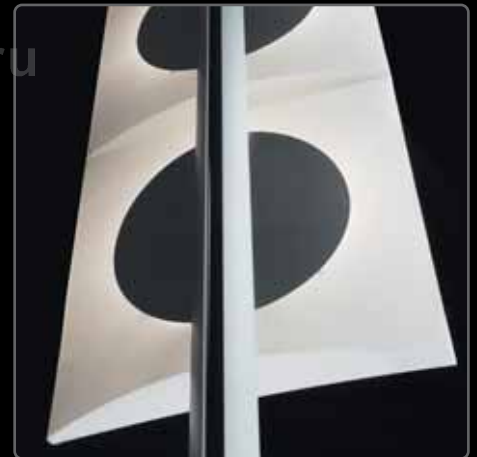



MODULO
ELECTRO
www.modulelectro.ru

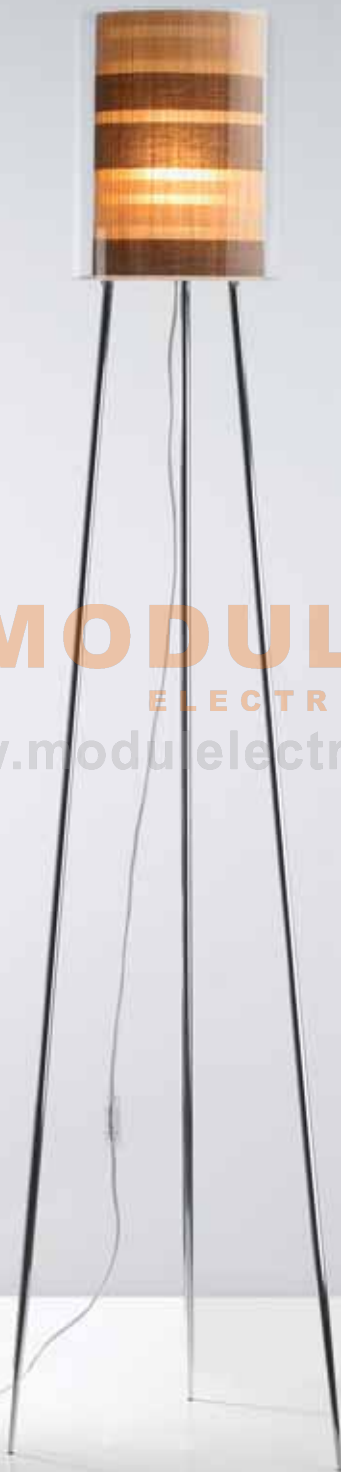

jackie

Josep Novell/Josep Puig

B.lux®

jackie



>P29 >P110 >P188

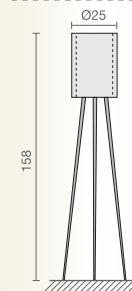

Luminaria de pie. Difusor-contenedor de doble pared en metacrilato transparente y opalino que sirve para personalizar la luminaria introduciendo diferentes tipos de relleno. Soporte en tubo de acero conificado y cromado brillante.

Container diffuser with double covering in transparent and opaline methacrylate, which makes possible to personalize the lamp filling it up with different motives. Stand in cone shaped steel tubing.

Stehleuchte. Diffusor-Behälter mit doppelter Wand aus durchsichtigem oder opal Acrylglas, mit dem die Leuchte durch verschiedene Füllungen persönlich gestaltet werden kann. Konisch geformter Stahlrohrständer, glänzend, verchromt.

- ◆ INC. MAX. 100W (E27)
- ◆ INC. GLOB. MÁX. 100W (E27) Ø95 mm.
- ◆ FLUOR. 23W (E27)



MODULO
ELECTRO
www.modulelectro.ru

julia

Manel Ybargüengoitia

B.lux®

julia



SP31 SP103 SP141 SP189

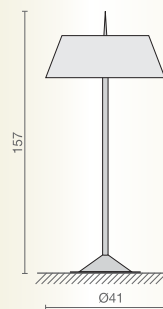

Luminaria de pie fluorescente. Metal acabado gris mate y difusor de metacrilato blanco mate que oculta totalmente la luz.

Fluorescent floor lamp. Metal finished in matt grey and matt white methacrylate diffuser, which covers completely the light source.

Stehleuchte mit Leuchtstoffröhre. Metallausführung in matt grau und Diffusor aus matt weißem Acrylglas, das die Lichtquelle vollständig verbirgt.

FLUOR. CIRC. 55W (2Gx13)

kele

Miguel Ángel Ciganda

Vanlux

kele



>P32

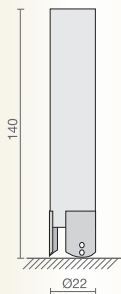

Luminaria fluorescente de pie con difusor de tela blanca cruda y base de madera de haya curvada.

Fluorescent floor lamp with natural white fabric diffuser and rounded beech wood base.

Stehleuchte mit Leuchtstoffröhre mit Diffusor aus roh-weißem Stoff und gekrümmter Untergrund aus Buchenholz.

FLUOR. 2 x 36W (G13)

MODUL
ELECTRO
www.modulelectro.ru





kele 2

Miguel Ángel Ciganda

B.lux

kele 2

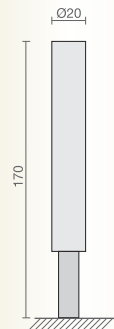

Luminaria fluorescente de pie. Difusor de tela blanco y base de metal acabado gris mate.

Fluorescent floor lamp with white fabric diffuser and metal base finished in matt aluminium.

Stehleuchte mit Leuchtstoffröhre. Diffusor aus weißem Stoff und Untergrund aus Metall in der Ausführung matt grau.

FLUOR. 2 x 36W (G13)

MODUL
ELECTRO
www.modulelectro.ru



mirror

Jan Van Lierde

B.lux®

mirror



SP33

SP191

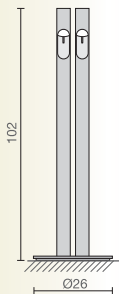

Luminaria de pie halógena.
Aluminio extruido lacado en gris
metalizado. Haz de luz orientable
mediante espejo reflector.

Halogen floor lamp. Extruded
aluminium lacquered in metalized
grey. Adjustable beam by reflecting
mirror.

Halogen-Stehleuchte. Extrudiertes
Aluminium in grau-metallisiert.
Ausrichtbarer Lichtstrahl mit
reflektierendem Spiegel.



HALOG. MR8 2 x MÁX. 20W 12V (Gz4)

MODULO
ELECTRO
www.modulelectro.ru



olympia

Jorge Pensi

B.lux®

olympia



SP116 SP193



Luminaria halógena de pie fabricada en aluminio pulido brillante.

Halogen floor lamp produced in polished bright aluminium.

Halogen-Stehleuchte aus glänzend poliertem Aluminium.



DIMMER
HALOG. 2 x MÁX. 200W (R7s)



MODULO
ELECTRO
www.modulelectro.ru





76



MODUL
ELECTRO
www.modulelectro.ru

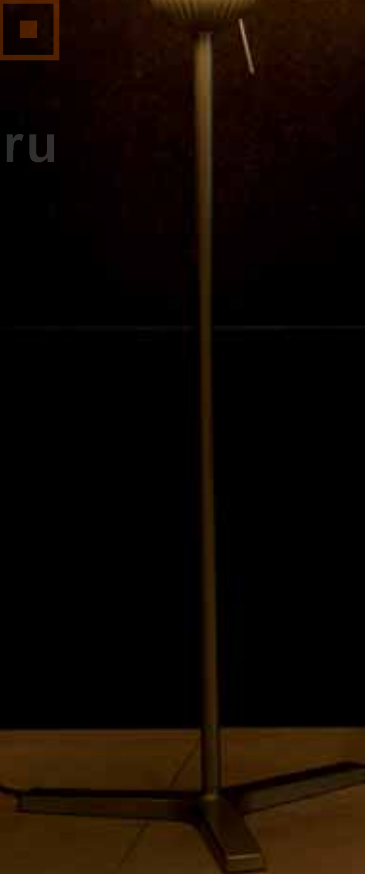

MODUL

ELECTRO

www.modulelectro.ru

nina & nino

Gemma Bernal

B.lux

nina & nino



>P38 >P112 >P192

nina



nino

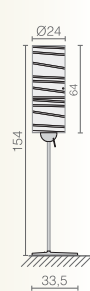

Luminarias de pie con cuerpo metálico pintado y pantalla serigrafiada. Nina está disponible en dos versiones: fuste marrón combinado con pantalla marrón textil que dibuja círculos y fuste gris brillo combinado con pantalla de policarbonato blanco con rayas impresas. Nino está disponible en una única versión: fuste gris brillo con pantalla de policarbonato blanco con rayas impresas.

Metal floor lamps with painted metal body and printed screen. The Nina model is available in two finishes: brown shaft with brown fabric screen with circle prints and shiny grey shaft with white polycarbonate screen with printed stripes. The Nino model is available in one finish: shiny grey shaft with white polycarbonate screen with printed stripes.

Stehlampen mit mattgrauer Metallhalterung und bedrucktem Lampenschirm. Nina ist in zwei Ausführungen lieferbar: braunes Format mit in Kreisen bedrucktem braunem Lampenschirm oder grauglänzendes Format mit in Strahlen bedrucktem Lampenschirm aus weißem Polycarbonat. Nino ist in einer Ausführung lieferbar: grauglänzendes Format mit in Strahlen bedrucktem Lampenschirm aus weißem Polycarbonat.



DIMMER
INC. GLOB. MÁX 100W (E27)

petite

Miguel Herranz

B.lux® petite



SP40

SP198

PETITE 22

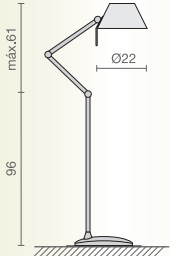

Luminarias de pie articuladas, fabricadas en aluminio extruido. Pantalla textil blanca cruda. Acabados: gris mate o anodizado brillante.

Articulated and adjustable floor lamps. Produced in extruded aluminium. Natural white fabric screen. Finish: matt grey or anodized.

PETITE 12

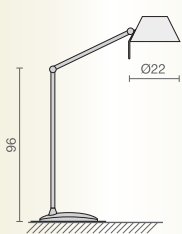

Stehleuchten mit Gelenken, hergestellt aus extrudiertem Aluminium. Roh-weißer Textilschirm. Ausführungen: Matt grau oder glänzend anodisiert.



PETITE 22+: INC. MAX. 60W (E27)
PETITE 12+: INC. MAX. 60W (E27)

MODUL
ELECTRO
www.modulelectro.ru



regina

Jorge Pensi

B.lux

regina



SP48 SP130 SP210

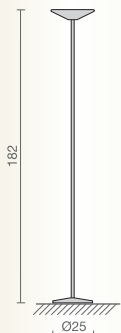

Luminaria de pie halógena fabricada en aluminio pulido brillante. Pantalla de aluminio o vidrio blanco o azul.

Halogen floor lamp produced in polished bright aluminium. Aluminium shade or glass in white or blue colour.

Halogen-Stehleuchte aus glänzend poliertem Aluminium. Schirm aus Aluminium oder weißem oder blauem Glas.

DIMMER
HALOG. MAX. 300W (R7s)

MODULO
ELECTRO
www.modulelectro.ru



rca

Gemma Bernal

Blux® rca



SP46 SP124 SP206

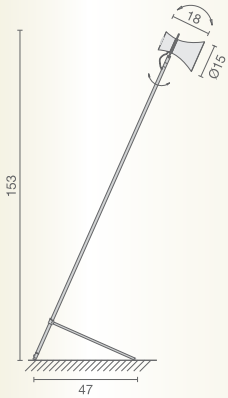

Luminaria de pie con trípode metálico de acabado cromado. La pantalla está fabricada en aluminio pulido con acabado anodizado mate y es orientable.

Floor lamp with a chrome finished metal tripod. The screen, made out of polished aluminium finished in anodized matt is adjustable.

Stehleuchte mit Metallfuß in verchromter Ausführung. Der Schirm ist aus poliertem und matt anodisiertem Aluminium und ausrichtbar.



- INC. REFLECTORA MAX. 60W (E27)
- FLUOR. MASTER PL-E 15W (E27)
- FLUOR. DULUX EL LL 15W (E27)



MODULO
ELECTRO
www.modulelectro.ru





 **MODUL** 
ELECTRO
www.modulselectro.ru

ronda

Jorge Pensi

Blux®

ronda



SP50 SP128 SP148

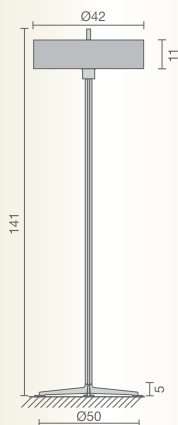

Luminaria de pie con fuste y trípode de aluminio extruido inyectado, acabados en gris claro mate. Pantalla de madera curvada acabada en roble natural o wengué, con dos difusores de poliamida opal mate.

Floor lamp with a shaft and tripod of injected extruded aluminium, in a light grey matt finish. Curved wooden screen finished in natural oak or wenge, with two opal matt polyamide diffusers.

Stehleuchte mit Schaft und Fuß aus extrudiertem, eingespritztem Aluminium, Ausführung in matt hellgrau. Gebogener Holzschirm aus Natureiche oder Wenge, mit zwei Diffusoren aus Polyamid in opal-matt.

FLUOR. CIRC. 40W (2Gx13)

MODULO
ELECTRO
www.modulelectro.ru



MODULO
ELECTRO
www.modulelectro.ru

ronda

Jorge Pensi

B.lux

ronda



>P50

>P128

>P148



MODULO
ELECTRO
www.modulelectro.ru



MODUL
ELECTRO
www.modulelectro.ru

85

taps

Jorge Pensi

B.lux taps



SP57

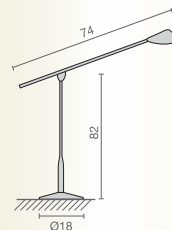

Luminaria de pie
halógena. Acabado en
cromado brillante.

Halogen floor lamp
finished in bright chrome.

Halogen-Stehleuchte.
Ausführung in glänzend
verchromt.

HALOG, MÁX. 50W 12V (G6,35)



 **MODUL** 
ELECTRO
www.modulelectro.ru



boletus outside

Jorge Pensi

B.lux

boletus outside a/b

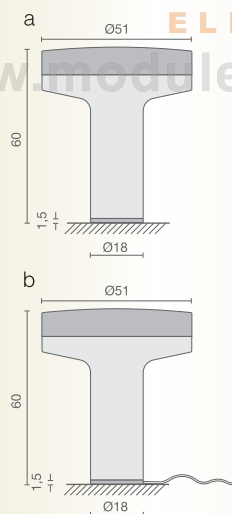

Luminaria de exterior. Su parte superior está fabricada en aluminio con acabado anodizado natural y su cuerpo en PE antivandálico blanco opalino liso resistente UVA. Boletus Outside A se fija al suelo coincidiendo con una acometida prevista. Boletus Outside B es portátil y posee una longitud de acometida máxima de 3,5 metros

Exterior lamp. The upper part is made of aluminium with a natural anodised finish and the body is manufactured from UV stabilised smooth opal white vandal proof polyethylene. Boletus Outside A is fixed to the ground and hard wired. Boletus Outside B is portable, with a maximum wiring connection of 3,5 metres.

Außenleuchte. Oberer Teil aus anodisiertem Aluminium, Körper aus vandalismussicherem und UV-beständigem PE, opalweiß glänzend. Boletus Outside A: Wird über dem vorgesehenen Stromanschluss im Boden verankert. Boletus Outside B: Tragbare. Die maximale Kabellänge beträgt 3,5 Meter.

IP54



FLUOR. 2 x 36W (2G11)

MODUL

ELECTRO

www.modulelectro.ru

Jon Santacoloma

kanpazar 150 a/b



S-P109

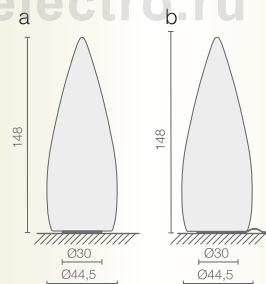

Luminaria para exterior e interior fabricada en PE antivandálico blanco opalino liso resistente UVA. Kanpazar A se fija al suelo coincidiendo con una acometida prevista, mientras que Kanpazar B es portátil y posee una longitud de acometida máxima de 3,5 metros. Ambas están disponibles con dos versiones de luz fluorescente: 2G11 y G5. Esta última permite el empleo de tubos de color.

Indoor and outdoor lamps, in a smooth white frosted finish, made from vandal proof UV resistant polyethylene. Kanpazar A is fixed to the ground and hard wired, while Kanpazar B is portable and has a maximum wiring connection of 3,5 metres. Both are available in two types: 2G11 and G5. The G5 can hold coloured tubes.

Lampe für Innenräume und Außenbereiche aus vandalismussicherem PE, opalweiss glänzend, UV-beständig. Kanpazar A wird abhängig vom vorhandenen Elektroanschluss auf dem Boden befestigt, während Kanpazar B tragbar ist und eine Anschlusslänge von maximal 3,5 Metern besitzt. Beide sind in zwei Ausführungen von Leuchtstoffröhren erhältlich, 2G11 und G5. Letztere kann mit farbigen Hülsen kombiniert werden.

IP54

FLUOR, 2 x 55W (2G11) o
FLUOR, 2 x 21W (G5)



 **MODULO** 
ELECTRO
www.modulelectro.ru





MODUL
ELECTRO
www.modulelectro.ru



kanpazar

Jon Santacoloma

kanpazar 150 c/d



SP103

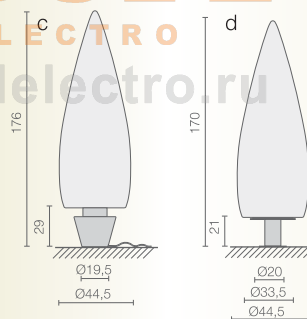

Luminaria para exterior e interior fabricada en PE antivandálico blanco opalino liso resistente UVA. Kanpazar C, que tiene una base de hormigón, es portátil y posee una longitud de acometida máxima de 3,5 metros. Kanpazar D posee una base de acero inoxidable que se fija al suelo coincidiendo con una acometida prevista. Ambas están disponibles con dos versiones de luz fluorescente: 2G11 y G5. Esta última permite el empleo de tubos de color.

Indoor and outdoor lamps, in a smooth white frosted finish, made from vandal proof UV resistant polyethylene. Kanpazar C, which has a concrete base, is portable and has a maximum wiring connection of 3,5 metres. Kanpazar D has a stainless steel base that is secured to the ground with the connection provided. Both are available in two types: 2G11 and G5. The G5 can hold coloured tubes.

Lampe für Innenräume und Außenbereiche aus vandalismussicherem PE, opalweiss glänzend, UV-beständig. Kanpazar C, dass ein Betonfußgestell hat, ist tragbar und hat eine Anschlusslänge von maximal 3,5 Metern. Kanpazar D hat ein rostfreies Stahlfußgestell, dass abhängig vom vorhandenen Elektroanschluss auf dem Boden befestigt wird. Beide sind in zwei Ausführungen von Leuchtstoffröhren erhältlich, 2G11 und G5. Letztere kann mit farbigen Hülsen kombiniert werden.

IP54



FLUOR. 2 x 55W (2G11) o
FLUOR. 2 x 21W (G5)

MODUL
ELECTRO
www.modulelectro.ru



kanpazar

Jon Santacoloma

E.lux kanpazar 80 a/b/c



IP54

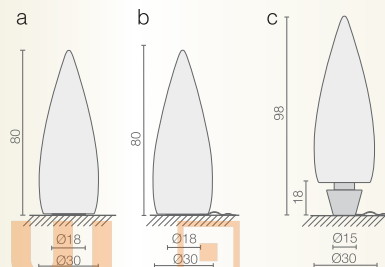

Luminaria para exterior e interior de 80 centímetros de altura, fabricada en PE antivandálico blanco opalino liso resistente UVA. Kanpazar A se fija al suelo coincidiendo con una acometida prevista, mientras que Kanpazar B es portátil y posee una longitud de acometida máxima de 3,5 metros. Kanpazar C, que tiene una base de hormigón, es portátil y posee también una longitud de acometida máxima de 3,5 metros.

Indoor and outdoor lamps, 80 cm high, in a smooth white frosted finish, made from vandal proof UV resistant polyethylene. Kanpazar A is fixed to the ground and hard wired, while Kanpazar B is portable and has a maximum wiring connection of 3,5 metres. Kanpazar C, which has a concrete base, is portable and has a maximum wiring connection of 3,5 metres.



Lampe für Innenräume und Außenbereiche, 80 cm hoch, aus vandalismussicherem PE, opalweiß glänzend, UV-beständig. Kanpazar A wird abhängig vom vorhandenen Elektroanschluss auf dem Boden festgemacht, während Kanpazar B tragbar ist und eine Anschlusslänge von maximal 3,5 Metern besitzt. Kanpazar C, dass ein Betonfußgestell hat, ist tragbar und hat eine Anschlusslänge von maximal 3,5 Metern.

IP54

FLUOR. 2 x 36W (2G11)



luminarias de suspensión
suspension lamps
hängeleuchten

 **MODUL** 
ELECTRO
www.modulelectro.ru





MODUL
ELECTRO
www.modulelectro.ru

adorable

Diego Fortunato

B.lux® adorable



SP62

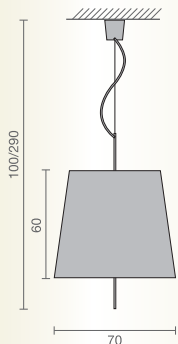

Luminaria de suspensión con sistema sube y baja. Pantalla de lana elástica ignífuga negra, cruda o roja. Metal acabado en gris.

Suspension lamp with a raising and lowering device. Black, natural white or red fireproof stretch wool shade. Metal finished in grey.

Hängeleuchte mit System zum Hinauf- und Hinunterschieben. Schirm aus elastischer, feuerfester Wolle in schwarz, roh oder rot. Metallausführung in grau.

INC. GLOB. 3 x MÁX. 100W (E27) Ø120 mm.

MODULO ELECTRO

www.modulelectro.ru





MODUL
ELECTRO
www.modulelectro.ru

bellafior

Beppe Benenti

B.lux*

bellafior

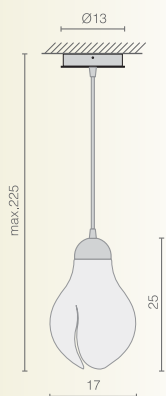

Luminaria de suspensión fabricada en metal con acabado gris mate. Su difusor, con forma de flor, es de silicona y está compuesto por hojas amoldables que admiten diferentes posiciones, lo que permite regular la luz. Disponible en color blanco, amarillo, rojo y azul.

Metal suspension lamp in a matt grey finish. The flower-shaped diffuser has flexible silicon rubber leaves that can be moulded into different positions to regulate the light. Available in white, yellow, red and blue.

Hängelampe mit mattgrauer Metallhalterung. Den Lampenschirm bilden verformbare Silikonblätter, mit denen sich unterschiedliche Beleuchtungseffekte erzielen lassen. Erhältlich in Weiß, Gelb, Rot und Blau.

INC. GLOB. MÁX. 100W (E27) Ø120 mm.





MODUL
ELECTRO
www.modulelectro.ru



MODULO
ELECTRO
www.modulelectro.ru

dolcetta

Manel Ybargüengoitia

Varlux dolcetta 2/3

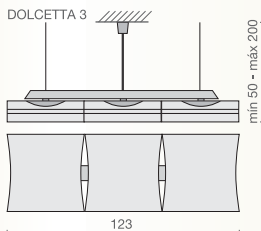
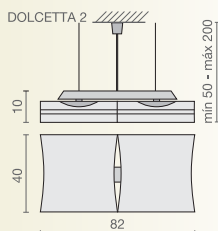

Luminaria de suspensión de 2 y 3 elementos fluorescentes.
Estructura en aluminio gris mate y difusor de tela en color blanco.

Suspension lamp with two and three fluorescent fittings.
Structure in matt grey aluminium, base in grey anthracite and textile diffuser in white colour.

Hängeleuchte mit 2 und 3 Leuchtstoffelementen.
Struktur aus Aluminium und matt grau und Diffusor aus Stoff in weißer Farbe.

- ◆ DOLCETTA 2: FLUOR. CIRC. 2 x 22W (2Gx13)
- ◆ DOLCETTA 3: FLUOR. CIRC. 3 x 22W (2Gx13)

globe

Jan Van Lierde

B.lux

globe

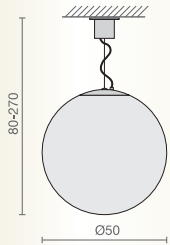

Luminaria de suspensión realizada en vidrio de Murano bicapa blanco mate.

Suspension lamp produced in two covers murano glass in matt white.

Hängeleuchte aus Muranoglas, in zwei Schichten, matt weiß.

INC. GLOB. MAX. 100W (E27) Ø80 mm.

MODULO
ELECTRO
www.modulelectro.ru

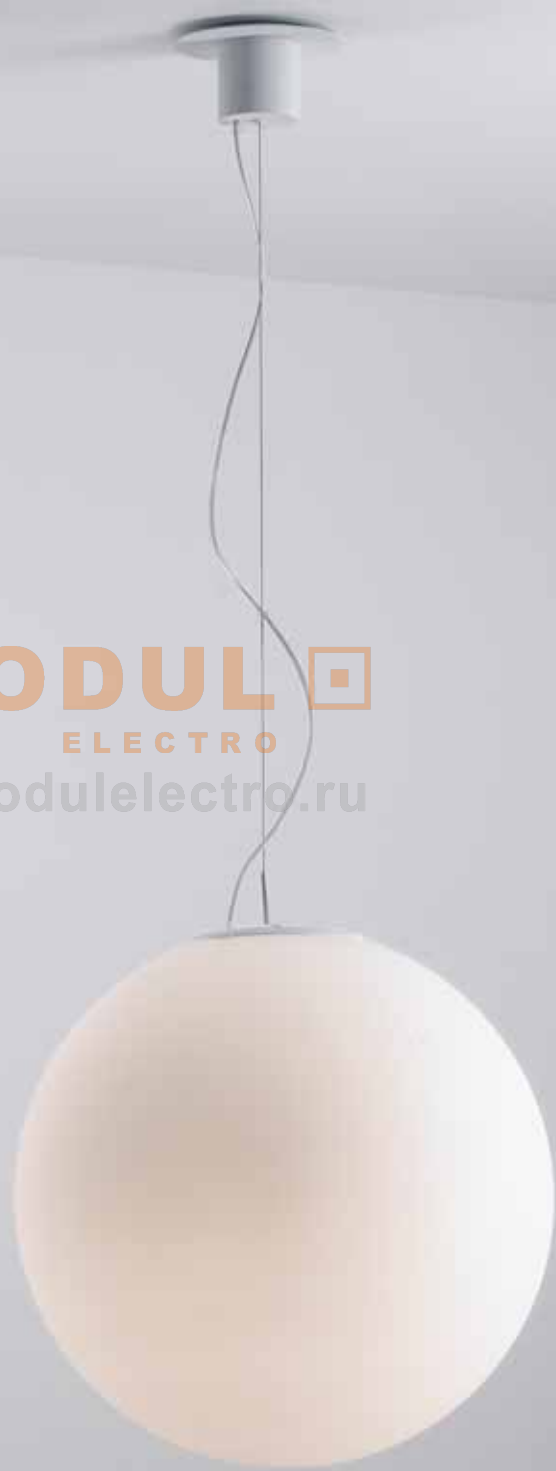

helios

Manel Ybargüengoitia

B.lux®

helios madera

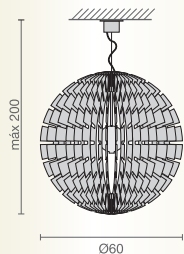



Luminaria de suspensión fabricada en madera con barniz natural mate. Núcleo acabado en aluminio mate.

Suspension lamp produced in wood with natural matt varnishing. Nucleus finished in matt aluminium.

Hängeleuchte aus Holz mit mattem Naturlack. Kern aus Aluminium, in matter Ausführung.

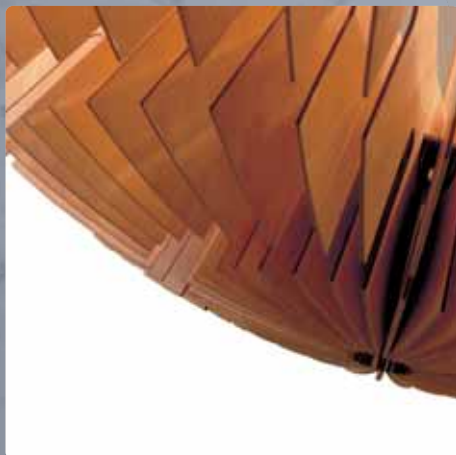

INC. 7 x MÁX. 60W (E14)



 **MODUL** 
ELECTRO
www.modulelectro.ru





 **MODUL** 
ELECTRO
www.modulelectro.ru



MODUL
ELECTRO
www.modulelectro.ru



MODULO
ELECTRO
www.modul-electro.ru

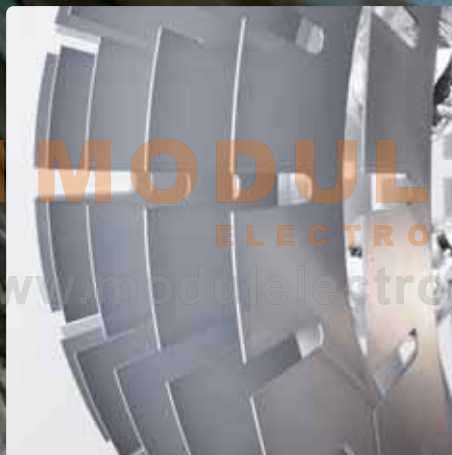

helios

Manel Ybargüengoitia

B.lux®

helios metal 60/90

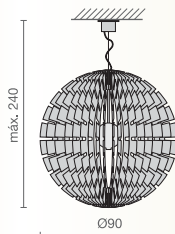
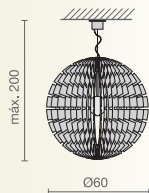

Luminaria de suspensión fabricada en aluminio. Acabada en gris mate.

Suspension lamp produced in aluminium. Finished in matt grey.

Hängeleuchte aus Aluminium. Ausführung in matt grau.

♦ HELIOS 60: INC. 7 x MÁX. 60W (E14)
HELIOS 90: INC. 7 x MÁX. 60W (E27)

julia

Manel Ybargüengoitia

B.lux®

julia



SP31 SP71 SP141 SP189

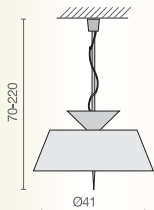

Luminaria de suspensión fluorescente con mecanismo de sube y baja. Metal acabado gris mate y difusor de metacrilato blanco mate que oculta totalmente la fuente de luz.

Fluorescent suspension lamp with raising and lowering device. Metal finished in matt grey and matt white methacrylate diffuser, which covers completely the light source.

Hängeleuchte mit Leuchtstoffröhre mit System zum Hinauf- und Hinunterschieben. Metallausführung in matt grau und Diffusor aus matt weißem Acrylglas, das die Lichtquelle vollständig verbirgt.

FLUOR. CIRC. 55W (2Gx13)

MODUL
ELECTRO
www.modulelectro.ru





MODULO
ELECTRO
www.modulelectro.ru

julieta

Manel Ybargüengoitia

B.lux® julieta 1/2/3



>P31 5P141 5P189

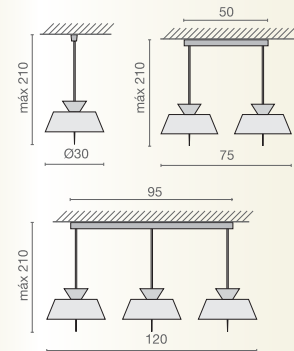

Luminaria de suspensión fluorescente. Metal acabado gris mate y difusor de metacrilato blanco mate que oculta totalmente la fuente de luz.

Fluorescent suspension lamp. Metal finished in matt grey and matt white methacrylate diffuser, which covers completely the light source.

Hängeleuchte mit Leuchtstoffröhre. Metallausführung in matt grau und Diffusor aus matt weißem Acrylglas, das die Lichtquelle vollständig verbirgt.

- ♦ JULIETA: FLUOR. CRC. 22W (2Gx13)
- ♦ JULIETA 2: FLUOR. CRC. 2 x 22W (2Gx13)
- ♦ JULIETA 3: FLUOR. CRC. 3 x 22W (2Gx13)



kanpazar

Jon Santacoloma

B.lux

kanpazar suspensión 150/80



≤P88

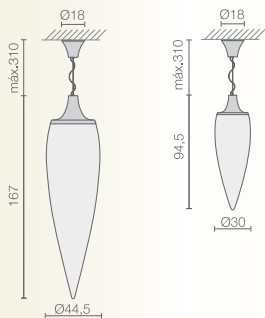

Luminaria de suspensión de interior y exterior fabricada en PE antivandálico blanco opalino liso resistente UVA. Disponible en dos tamaños. Kanpazar suspensión 150 está disponible con dos versiones de luz fluorescente: 2G11 y G5. Ésta última permite el empleo de tubos de color.

Indoor and outdoor pendant lamps, in a smooth white frosted finish, made from vandal proof UV resistant polyethylene. Available in two sizes. Kanpazar suspension 150 is available in two types: 2G11 and G5. The G5 can hold coloured tubes.

Hängelampe für Innenräume und Außenbereiche aus vandalismussicherem PE, opalweiß glänzend, UV-beständig. In zwei Größen lieferbar. Kanpazar Wandlampen sind in zwei Ausführungen von Leuchtstoffröhren erhältlich, 2G11 und G5. Letztere kann mit farbigen Hülsen kombiniert werden.

150: FLUOR. 2 x 55W (2G11) o FLUOR. 2 x 21W (G5)
80: FLUOR. 2 x 36W (2G11)

ELECTRO

www.modulelectro.ru





 **MODUL** 
ELECTRO

www.modul.electro.ru

jackie

Josep Novell/Josep Puig

B.Lux

jackie



SP29

SP70

SP188

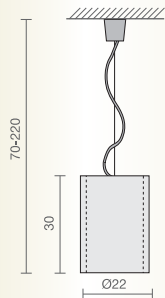

Luminaria de suspensió. Difusor-contenedor de doble pared en metacrilato transparente y opalino que sirve para personalizar la luminaria introduciendo diferentes tipos de relleno.

Suspension lamp. Container diffuser with double covering in transparent and opaline methacrylate, which makes possible to personalize the lamp filling it up with different motives.

Hängeleuchte. Diffusor-Behälter mit doppelter Wand aus durchsichtigem oder opal Acrylglas, mit dem die Leuchte durch verschiedene Füllungen persönlich gestaltet werden kann.

- INC. MAX. 100W (E27)
- INC. GLOB. MAX. 100W (E27) Ø95 mm.
- FLUOR. 23W (E27)

MODULO ELECTRO

www.modulelectro.ru



waite

Miguel Ángel Ciganda

Blux*

maite

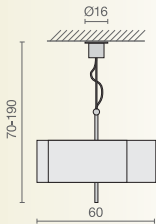

Luminaria de suspensión con sistema sube y baja. Acabado en gris metalizado y pantalla en blanco crudo.

Suspension lamp with raising and lowering device. Finished in metallized grey and shade in natural white.

Hängeleuchte mit System zum Hinauf- und Hinunterschieben. Ausführung in grau metallisiert und Schirm in roh-weiß.



INC. GLOB. 3 x MÁX. 100W (E27)



MODUL
ELECTRO

www.modulelectro.ru





MODUL
ELECTRO
www.modulelectro.ru

nina & nino

Gemma Bernal

B.lux®

nina & nino



P38 P76

P162

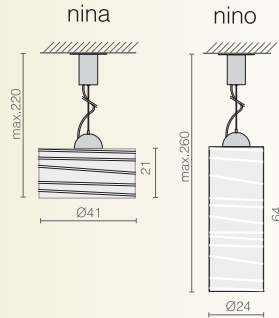

Luminarias de suspensión con cuerpo metálico pintado y pantalla serigrafiada. Nina está disponible en dos versiones: acabado marrón combinado con pantalla marrón textil que dibuja círculos y acabado gris brillo combinado con pantalla de policarbonato blanco con rayas impresas. Nino está disponible en una única versión: acabado gris brillo con pantalla de policarbonato blanco con rayas impresas.

Metal suspension lamps with painted metal body and printed screen. The Nina model is available in two finishes: brown with brown fabric screen with circle prints and shiny grey with white polycarbonate screen with printed stripes. The Nino model is available in one finish: shiny grey with white polycarbonate screen with printed stripes.

Hängelampe mit lackierter Metallstruktur und bedrucktem Lampenschirm. Nina ist in zwei Ausführungen lieferbar: braune Struktur und mit Kreisen bedruckter, brauner Lampenschirm - oder Graumetallik und mit Linien bedruckter Lampenschirm aus weißem Polycarbonat. Nino ist in nur einer Ausführung lieferbar: Graumetallik, Lampenschirm aus weißem Polycarbonat, bedruckt mit Linien.

INC, GLOB, MÁX. 100W (E27)



MODULE
ELECTRO
www.moduleelectro.it



MODUL
ELECTRO
www.modulselectro.ru

nite

Jorge Pensi

B.lux® nite 1/2/3

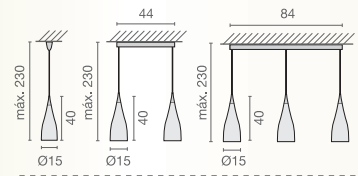

Luminaria de suspensión en vidrio soplado blanco opalino.
Suspension lamp in white opaline hand blow glass.
Hängeleuchte aus geblasenem weißem Opalglas.



- ◆ NITE 1: INC. MÁX. 100W (E27) / INC GLOB. MÁX. 100W (E27) Ø95 mm. / FLUOR. 23W (E27)
- ◆ NITE 2: INC. 2 x MÁX. 100W (E27) / INC GLOB. 2 x MÁX. 100W (E27) Ø95 mm. / FLUOR. 2 x 23W (E27)
- ◆ NITE 3: INC. 3 x MÁX. 100W (E27) / INC GLOB. 3 x MÁX. 100W (E27) Ø95 mm. / FLUOR. 3 x 23W (E27)

MODUL

ELECTRO

nite p

Barra de unión de 36 cm para conectar suspensiones estándar de dos o tres elementos formando líneas.

36 cm length bar for connecting standard suspension with two or three lighting fittings.

36 cm lange Stange, mit der Standardhängeleuchten aus zwei oder drei Elementen miteinander zu Linien verbunden werden.

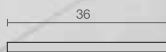

nite f

Florón con dos salidas de cable para acometer a conjuntos de suspensión.

Canopi with two ways out cables for connecting to the lighting fittings.

Zierstück mit zwei Kabelausgängen für miteinander verbundene Hängeleuchten.

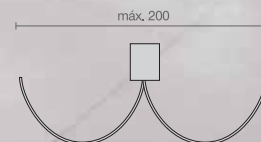

olympia

Jorge Pensi

B.lux®

olympia



SP75

SP198



Luminaria halógena de
suspensión fabricada en
aluminio pulido brillante.

Halogen suspension lamp
produced in bright polished
aluminium.

Halogen-Hängeleuchte aus
glänzend poliertem Aluminium.

HALOG. 2 x MÁX. 150W (R7s)

MODUL
ELECTRO
www.modulelectro.ru

olympia

Jorge Pensi

B.lux®

olympia billar



SP75

SP193

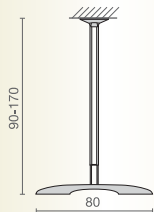

Luminaria halógena de suspensión fabricada en aluminio pulido brillante.

Halogen suspension lamp produced in bright polished aluminium.

Halogen-Hängeleuchte aus glänzend poliertem Aluminium.

HALOG. 2 x MÁX. 150W (R7s)



MODUL
ELECTRO
www.modulelectro.ru



pinot

Jan Van Lierde

Blux

pinot 1/2/3



SP202

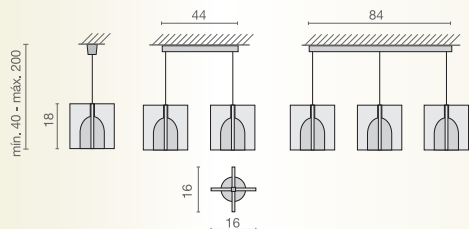

Luminaria
halógena de
suspensión
fabricada en
cristal y metal.
Acabado
blanco opal o
rojo.

Halogen-
suspension
lamp
produced in
glass and
metal. Opal
white or red
finish.

Halogen-
Hängeleuchte
aus Glas und
Metall.
Ausführung
Opalweiß
oder Rot.

HALOG. MÁX. 75W (G9)



MODUL
ELECTRO
www.modulelectro.ru



MODULO
ELECTRO
www.modulelectro.ru

FINE
IRIAN
D.O. RIBERA DEL DUERO
-DOMINIO DE LONGA
D.O. CARIÑENA
-PAGO MALVARINA
D.O.C. RIOJA
-RAMIRO'S
D.O. RIBERA DEL DUERO

quadrat

Jorge Pensi

B.lux®

quadrat 60x60



SP146 SP204

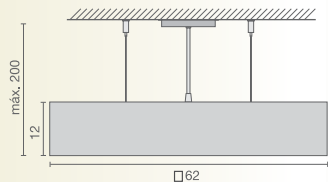

Luminaria de suspensión, fabricada en madera laminada de roble. Disponible en dos acabados: roble natural y wengué. Difusor de film termorretráctil.

Suspension lamp, made out of oak laminated wood. Available in two finishes: natural oak and wenge. Thermo retractable film diffuser.



Hängeleuchte aus Eichen-Schichtholz. In zwei Ausführungen angeboten: Natureiche und Wenge. Difusor aus wärmeschrumpfender Folie.

◇ FLUOR, 4 x 24W (G5)



MODULO
ELECTRO
www.modulelectro.ru



 **MODUL** 
ELECTRO
www.modulelectro.ru



quadrat

Jorge Pensi

B.lux®

quadrat 120x10

MOD



SP148 SP204

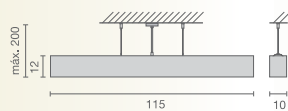



Luminaria de suspensión, fabricada en madera laminada de roble. Disponible en dos acabados: roble natural y wengué. Difusor de film termorretráctil.

Suspension lamp, made out of oak laminated wood. Available in two finishes: natural oak and wenge. Thermo retractable film diffuser.

Hängeleuchte aus Eichen-Schichtholz. In zwei Ausführungen angeboten: Natureiche und Wenge. Difussor aus wärmeschrumpfender Folie.

FLUOR, 2 x 55W (2G11)



 **MODUL** 
ELECTRO
www.modulelectro.ru

MODUL
ELECTRO
www.modulelectro.ru

124



MODULO
ELECTRO
www.modulelectro.ru

rca

Gemma Bernal

B.lux®

rca s

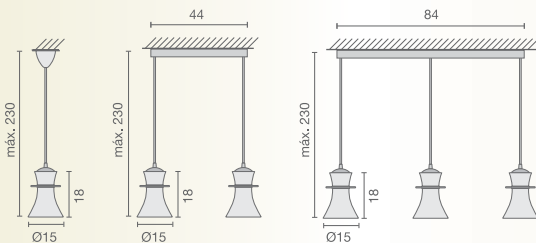

Luminaria de suspensión disponible en dos tamaños de pantalla, ambas realizadas en aluminio pulido con acabado anodizado mate.

Suspension light available in two screen sizes, both made out of polished aluminium finishes in anodized matt.

Hängeleuchte, verfügbar mit zwei Schirmgrößen, beide aus poliertem und matt anodisiertem Aluminium.



INC. REFLECTORA MÁX. 60W (E27)
FLUOR. MASTER PL E 15W (E27)
FLUOR. DULUX EL LL 15W (E27)



MODUL
ELECTRO
www.modulelectro.ru



MODULO
ELECTRO
www.modulelectro.ru



127

rca

Blux® rca m

Gemma Bernal

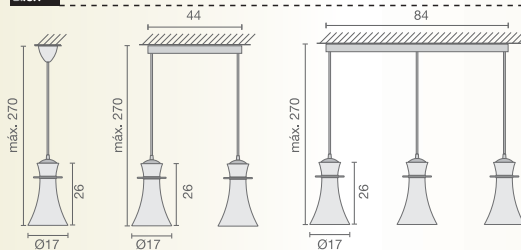

Luminaria de suspensión disponible en dos tamaños de pantalla, ambas realizadas en aluminio pulido con acabado anodizado mate.

Suspension light available in two screen sizes, both made out of polished aluminium finishes in anodized matt.

Hängeleuchte, verfügbar mit zwei Schirmgrößen, beide aus poliertem und matt anodisiertem Aluminium.

FLUOR. 23W (E27)

MODUL
ELECTRO

www.modul-electro.ru

128

ronda

Jorge Pensi

B.lux®

ronda

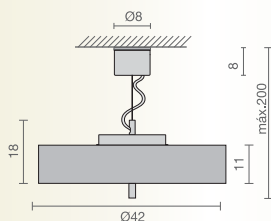
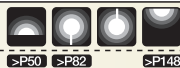

Luminaria de suspensión. La pantalla es de madera curvada acabada en roble natural o wengué, con dos difusores de poliamida opal mate.

Suspension light. The screen is of curved wood, finished in natural oak or wenge, with two opal matt polyamide diffusers.

Hängeleuchte. Der Schirm ist aus gebogenem Holz in der Ausführung Natureiche oder Wenge, mit zwei Diffusoren aus Polyamid in opal-matt.

FLUOR. CIRC. 40W (2Gx13)



MODUL
ELECTRO
www.modulselectro.ru

129



regina

Jorge Pensi

Blux®

regina



•P48

•P79

•P210

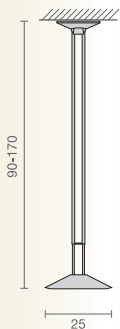

Luminaria de suspensión halógena fabricada en aluminio pulido brillante, Pantalla de aluminio o vidrio blanco o azul.

Halogen suspension lamp produced in polished bright aluminium. Aluminium shade or glass in white or blue colour.

Halogen-Hängeleuchte aus glänzend poliertem Aluminium. Schirm aus Aluminium oder weißem oder blauem Glas.

◇ HALOG. MÁX. 150W (R7s)



MODUL
ELECTRO
www.modulelectro.ru

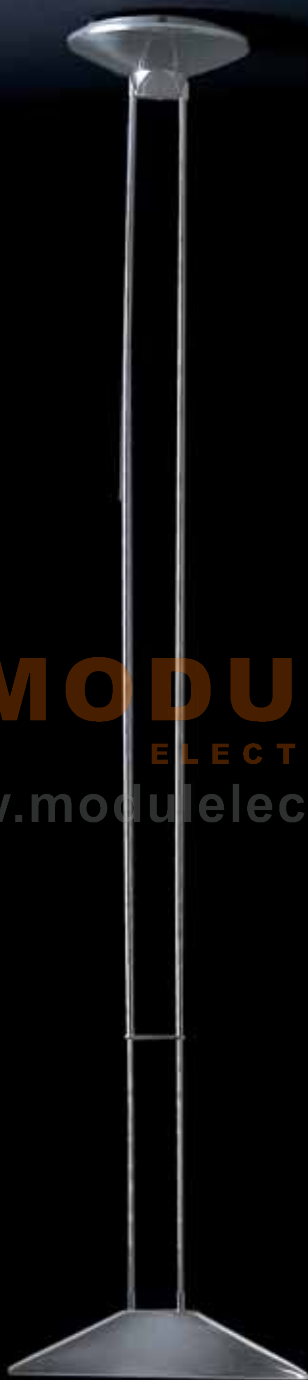

teide

Manel Ybargüengoitia

B.Lux*

teide

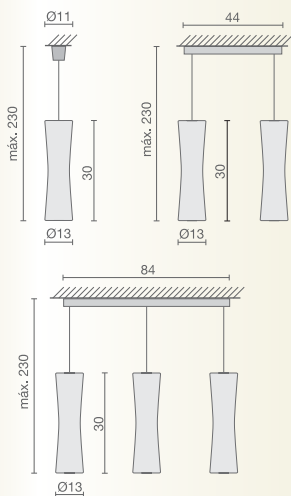

Luminaria de suspensión fabricada en cerámica blanca.

Suspension lamp produced in white ceramic.

Hängeleuchte aus weißer Keramik.

FLUOR, 23W (E27)

MODULO
ELECTRO
www.modulelectro.ru

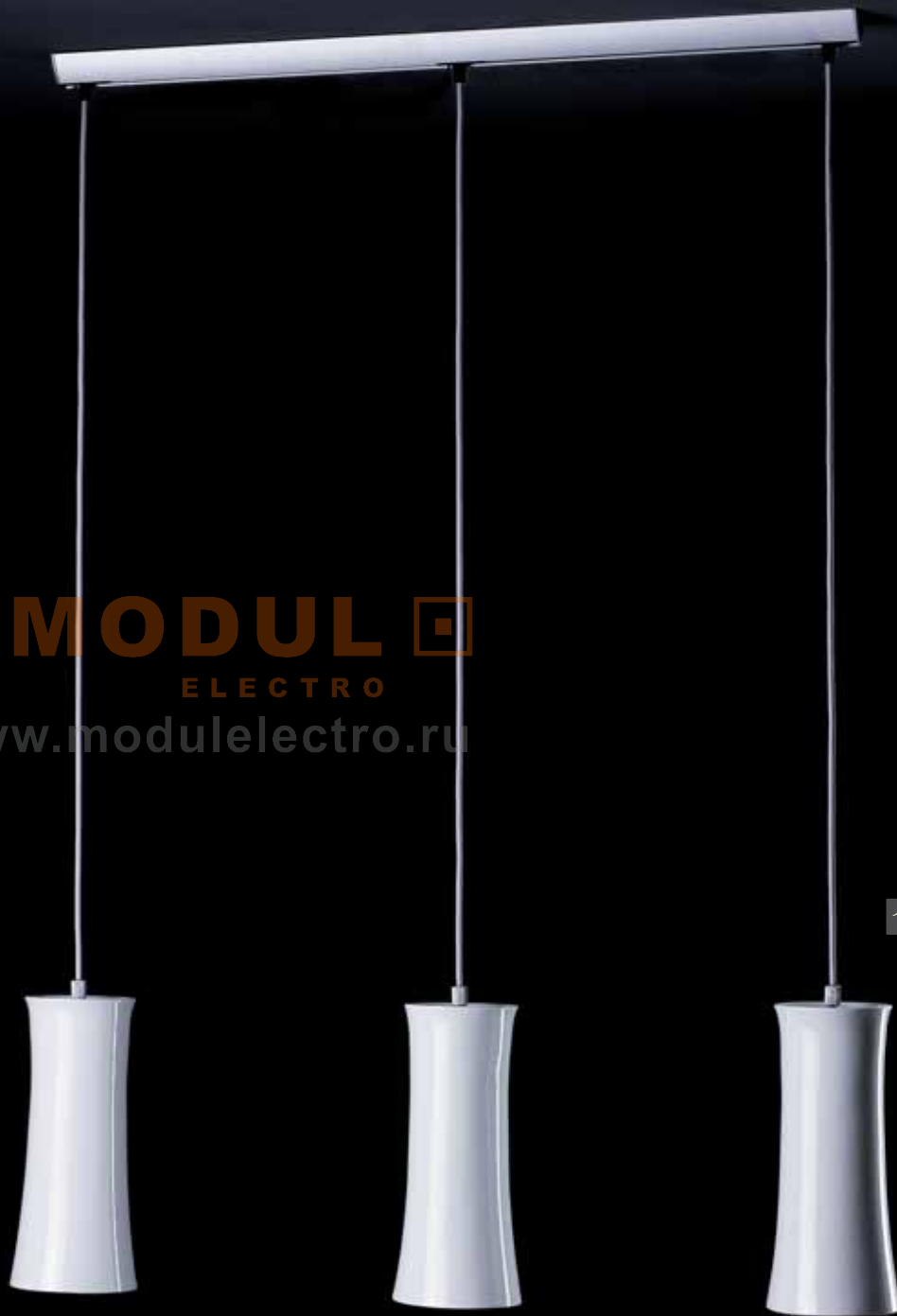



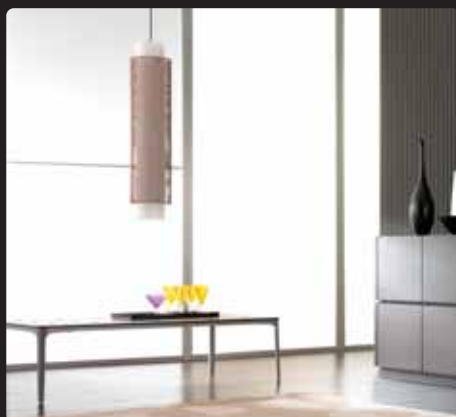

MODUL
ELECTRO
www.modulelectro.ru



skin

AIA Salazar – Navarro

B.lux® skin s  
70/100/130/160 >P53

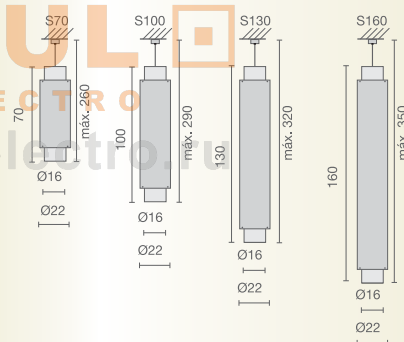

Luminaria de suspensión realizada en polimetacrilato opalino en blanco satinado, recubierto por una malla metálica cilíndrica de acero inox, lacada en acabados acero o bronce.

Suspension light made out of opaline polymethacrylate in satin white, coated in a stainless steel, cylindrical metal mesh, lacquered in steel or bronze finishes.

Hängeleuchte aus Polyacrylglas in opal-weiß satiniert, überzogen mit einem zylinderförmigen Metallnetz aus Inox-Stahl, lackiert in den Ausführungen Stahl oder Bronze.

- ◆ SKIN S 70: FLUOR. 2 x 14W (G5)
- ◆ SKIN S 100: FLUOR. 2 x 21W (G5)
- ◆ SKIN S 130: FLUOR. 2 x 28W (G5)
- ◆ SKIN S 160: FLUOR. 2 x 35W (G5)



MODULO
ELECTRO
www.modulelectro.ru

134

skin

AIA Salazar – Navarro

Blux skin c 130/160



SP53

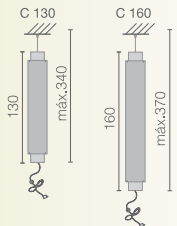

Luminaria de suspensión realizada en polimetacrilato opalino en blanco satinado, recubierto por una malla metálica cilíndrica de acero inox, lacada en acabados acero o bronce. Versión con clavija (C), con un largo de manguera de 2,5 m.

Suspension light made out of opaline polymethacrylate in satin white, coated in a stainless steel, cylindrical metal mesh, lacquered in steel or bronze finishes. Version with a connector (C), with 2.5 m of cable.

Hängeleuchte aus Polyacrylglas in opal-weiß satiniert, überzogen mit einem zylinderförmigen Metallnetz aus Inox-Stahl, lackiert in den Ausführungen Stahl oder Bronze. Version mit Stecker (C). Kabellänge: 2,5 m.



◆ SKIN C 130: FLUOR, 2 x 28W (G5)
SKIN C 160: FLUOR, 2 x 35W (G5)



MODUL
ELECTRO
www.modulelectro.ru



plafones
ceiling lamps
deckenleuchten

 **MODUL** 
ELECTRO
www.modulelectro.ru





 **MODULE** 
ELECTRO
www.modulestro.ru



MODULO
ELECTRO
www.modulelectro.ru

138

balart

Jorge Pensi

B.lux®

balart

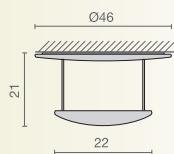

Luminaria halógena de techo. Acabado: aluminio pulido y difusor mate.

Halogen ceiling lamp. Finish: polished aluminium and matt diffuser.

Halogen-Deckenleuchte. Ausführung: Poliertes Aluminium und Diffusor in matt.

HALOG, MAX. 200W (R7s)

MODULO
ELECTRO
www.modulelectro.ru

139

celys

Jorge Pensi

Vanlux

celys

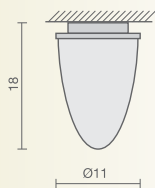

Luminaria fabricada en metal cromado y difusor de policarbonato blanco. Cerquillo blanco, azul o rojo.

Lamp produced in chrome metal and white polycarbonate diffuser. Ring: white, blue, or red.

Leuchte aus verchromtem Metall und Diffusor aus weißem Polycarbonat. Rahmen weiß, blau oder rot.

INC. MAX. 60W (E27)

MODUL
ELECTRO
www.modulelectro.ru

Copa

Gemma Bernal / Ramón Isern

B.lux **copa**



SP178

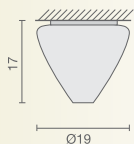

Luminaria de techo. Difusor en vidrio blanco.

Ceiling lamp. Diffuser produced in white glass.

Deckenleuchte, Diffusor aus weißem Glas.

INC. MAX. 75W (E27)

julia & julieta

Manel Ybargüengoitia



JULIA

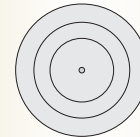
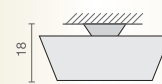

JULIETA

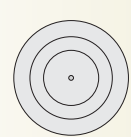
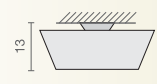

Luminarias de techo fluorescentes. Metal acabado gris mate y difusor de metacrilato blanco mate que oculta totalmente la fuente de luz.

Fluorescent ceiling lamps. Metal finished in matt grey and matt white methacrylate diffuser, which covers completely the light source.

Deckenleuchte mit Leuchtstoffröhre. Metallausführung in matt grau und Diffusor aus matt weißem Acrylglas, das die Lichtquelle vollständig verbirgt.

♦ JULIA: FLUOR. CIRC. 55W (2Gx13)
♦ JULIETA: FLUOR. CIRC. 22W (2Gx13)

MODULO ELECTRO
www.modulelectro.ru

dolcetta

Manel Ybargüengoitia

Vanlux **dolcetta**



>P26 >P69 >P100 >P178

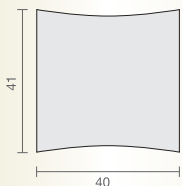

Luminaria de techo fluorescente. Difusor de tela en color blanco. Fácilmente combinable en diferentes composiciones.

Fluorescent ceiling lamp. Textile diffuser in white colour. Easy to combine in many special ways.

Deckenleuchte mit Leuchtstoffröhre. Diffusor aus weißem Stoff. Leicht zu kombinieren in verschiedenen Zusammensetzungen.

FLUOR. CIRC. 22W (2Gx13)

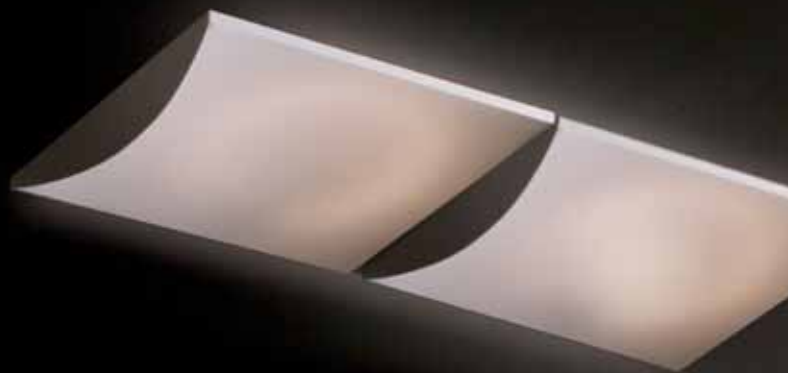

MODUL
ELECTRO

www.modulelectro.ru

A photograph of a modern office interior. In the foreground, a dark desk holds a silver laptop. A chair is partially visible on the left. A large window in the background offers a view of a landscape with mountains and a building. The room is lit with warm, ambient light, and a shadow is cast on the wall. The company logo and website are overlaid on the image.

MODUL
ELECTRO
www.modulelectro.ru



MODUL
ELECTRO
www.modulelectro.ru

q.bo

Carlos Serra / Antonio Herrero

Vanlux®

q.bo



SP44

SP203

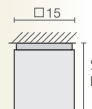

Aplique y plafón con difusor de policarbonato, permite incorporar pictogramas.

Wall and ceiling lamp with polycarbonate diffuser, permits the incorporation of pictograms.

Wand- und Deckenleuchte mit Diffusor aus Polycarbonat, bietet die Möglichkeit, Piktogramme einzufügen.

FLUOR, 18W (Gx24 d-2)

MODULO ELECTRO

www.modulselectro.ru



quadrat

Jorge Pensi

B.lux®

quadrat 60x60



SP120

SP122

SP204

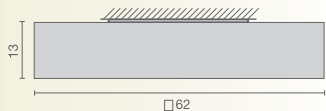

Luminaria de techo fabricada en madera laminada de roble y disponible en acabado roble natural y wengué. Difusor de film termorretráctil.

Ceiling light made out of oak laminated wood and available in natural oak and wenge finishes. Thermo retractable film diffuser.

Deckenleuchte aus Eichen-Schichtholz und verfügbar in den Ausführungen Natureiche und Wenge. Difusor aus wärmeschrumpfender Folie.

FLUOR. 4 x 24W (G5)



MODULO
ELECTRO
www.modulelestro.ru



MODUL
ELECTRO
www.modulelectro.ru



MODUL
ELECTRO
www.modulelectro.ru



ronda

Jorge Pensi

Blux ronda



>P50 >P82 >P128

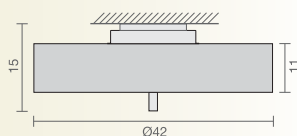

Luminaria de techo. La pantalla es de madera curvada acabada en roble natural o wengué, con difusor de poliamida opal mate.

Ceiling lamp. The screen is of curved wood, finished in natural oak or wenge, with opal matt polyamide diffuser.

Deckenleuchte. Der Schirm ist aus gebogenem Holz in der Ausführung Natureiche oder Wenge, mit Diffusoren aus Polyamid in opal-matt.

FLUOR, CIRC, 40W (2Gx13)



MODUL
ELECTRO
www.modulelectro.ru

veroca

Miguel Ángel Ciganda



veroca 1/2/3/4



MODUL
ELECTRO
www.modulelectro.ru



MODUL
ELECTRO
www.modulelectro.ru

 **MODUL** 
ELECTRO

www.modullectro.it



veroca

MODUL

Verlux® veroca 1/2/3/4

Miguel Ángel Ciganda



Luminaria fluorescente de techo, compuesta por un difusor textil ignífugo, un cuerpo luminico y cuatro muelles tensores, con sus respectivos soportes. El difusor textil puede lavarse a máquina y plancharse, sin perder sus características. La combinación de varios difusores textiles permite múltiples composiciones. Disponible en color blanco o crudo. Todos los tamaños están disponibles con equipo convencional, electrónico o electrónico-dimable.

Fluorescent ceiling light, comprising a fire resistant textile diffuser, a light body and four tension springs, with their respective supports. The textile diffuser is machine washable and can be ironed without losing its characteristics. The combination of various textile diffusers allows multiple compositions. Available in white or a natural colour. All sizes are available with conventional, electronic or electronic-dimable equipment.

Leuchtstoff-Deckenlampe, bestehend aus einem feuerfesten Textildiffusor, einem Leuchtkörper und vier Federn zum Spannen mit ihren jeweiligen Haltern. Der Textildiffusor ist waschmaschinenfest und kann gebügelt werden, ohne seine Eigenschaften zu verlieren. Wenn man mehrere Textildiffusoren kombiniert, lassen sich vielfältige Kompositionen erzielen. Verfügbar in Weiß oder Roh. Alle Größen sind mit konventioneller oder elektronischer Ausrüstung oder mit Elektronik-Dimmer verfügbar.

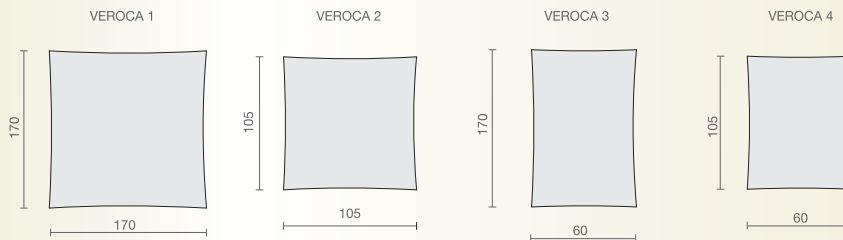

VEROCA 1:

FLUOR. 6 x 36W (G13) FLUOR. 6 x 55W (2G11)

VEROCA 2:

FLUOR. 4 x 18W (G13) FLUOR. 4 x 36W (2G11)

VEROCA 3:

FLUOR. 2 x 36W (G13)

VEROCA 4:

FLUOR. 2 x 18W (G13)



MODUL
ELECTRO
www.modulelectro.ru

veroca

Miguel Ángel Ciganda



veroca PRINT



MODUL
ELECTRO
www.modulelectro.ru

veroca

Miguel Ángel Ciganda

Verlux*

veroca PRINT



Además de fabricarse en blanco y crudo, las versiones 1 y 2 de Veroca están disponibles en versión serigrafiada. Se puede optar entre los 8 modelos estándar o personalizarla a gusto del consumidor, con la imagen deseada. Para personalizar la Veroca 3 y 4 consultar.

In addition to coming in white or natural colour, versions 1 and 2 of Veroca are available in a silk-screen printed version. Opt between the 8 standard models or personalized with the desired image of the consumer's choice. Consult to personalize Veroca 3 and 4.

Die Modelle 1 und 2 von Veroca sind neben den Versionen in weiß oder roh auch mit Siebdruckfarbe verfügbar. Es stehen 8 Standardmodelle zur Auswahl oder man kann das Modell nach eigenem Geschmack mit einem Bild nach Wunsch persönlich gestalten. Bitte fragen Sie nach, wenn Sie die Modelle Veroca 3 und 4 persönlich gestalten möchten.

Cómo realizar un pedido:

- 1 Enviar un archivo digitalizado (eps/tif) de unos 30 cm. de lado y a 300 ppp de resolución e indicar el encuadre elegido.
- 2 Indicar la cantidad.
- 3 Especificar nombre, tamaño y potencia.
- 4 Concretar el tipo de equipo: convencional, electrónico o electrónico-dimable.

*La imagen reproducida en soporte papel no es exacta a la reproducción en soporte de tela.

How to order:

- 1 Send a digitalized file (eps/tif) of approximately 30 cm. long and with a resolution of 300 dpi and indicate the chosen framing.
- 2 Indicate the quantity.
- 3 Specify the name, size and power.
- 4 Define the type of equipment: conventional, electronic or electronic-dimable.

* The reproduced image on paper is not exactly the same as the reproduction on cloth.

Sie können folgendermaßen bestellen:

- 1 Schicken Sie eine Digitaldatei (eps/tif) mit ca. 30 cm Seitenlänge und mit einer Auflösung von 300 ppp ein und geben Sie den gewählten Bildausschnitt an.
- 2 Geben Sie die Menge an.
- 3 Geben Sie Namen, Größe und Leistung an.
- 4 Konkretisieren Sie die Geräteart: konventionell, elektronisch oder Elektronik-Dimmer.

* Das Bild auf einem Papieruntergrund ist nicht genau das gleiche wie die Wiedergabe auf Textil.

VEROCA PRINT 1

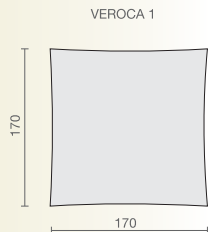

VEROCA PRINT 2

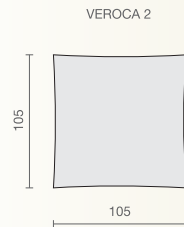

Para serigrafías de tonalidades muy oscuras se recomienda la utilización del cuerpo lumínico de mayor rendimiento.

The use of the high performance light body is recommended for silk-screen prints in dark shades.

Für Serigraphien in sehr dunklen Tönen wird die Verwendung eines Leuchtkörpers höherer Leistung empfohlen.

FLUOR. 6 x 36W (G13)
FLUOR. 6 x 55W (2G11)

FLUOR. 4 x 18W (G13)
FLUOR. 4 x 36W (2G11)



pareja



cielo



gotas



otoño



globos

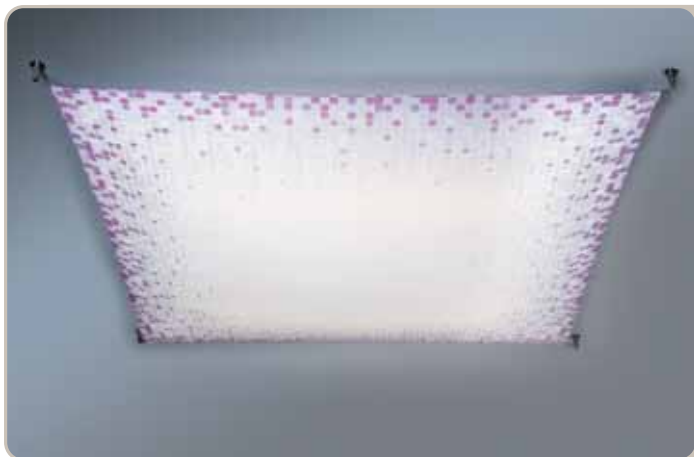

vidriera



cristalera



MODULO
ELECTRO
www.modulelectro.ru

zentrum

Jorge Pensi

Blux®

zentrum 1/2/3/4



5216

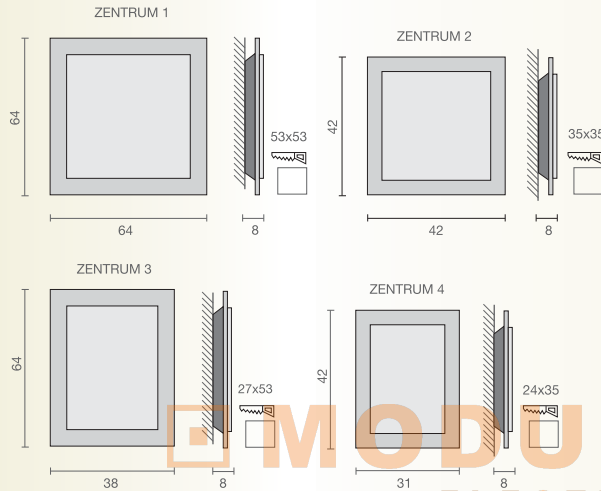

Luminaria fluorescente para techo. Versiones: de superficie o encastrada. Acabado: gris aluminio mate. Difusor de metacrilato opalino blanco de alto rendimiento lumínico. Sistema magnético de sujeción del difusor para fácil acceso a las lámparas. Equipada con balastos electrónicos.

Fluorescent ceiling lamp. Versions: surface or recessed mounted. Finish: matt aluminium grey. White opaline diffuser produced in methacrylate with a high luminous efficiency. Diffuser magnetic subsection system for easy access to the inner part. Equipped with electronic ballast.

Leuchte für die Decke mit Leuchtstoffröhre. Versionen: Auf der Oberfläche oder unter Putz. Ausführung: Aluminium matt grau. Diffusor aus Acrylglas, Opalweiß, mit hoher Leuchtkraft. Magnetisches Haltesystem des Diffusors zum leichten Zugriff auf die Lampen. Mit elektronischen Vorschaltgeräten.

- ZENTRUM 1: FLUOR, 4 x 36W (2G11)
- ZENTRUM 2: FLUOR, 4 x 18W (2G11)
- ZENTRUM 3: FLUOR, 2 x 36W (2G11)
- ZENTRUM 4: FLUOR, 2 x 18W (2G11)

www.modulelectro.ru





bellaflor

Beppe Benenti

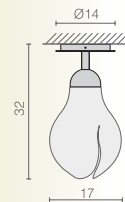

Plafón fabricado en metal con acabado gris mate. Su difusor, con forma de flor, es de silicona y está compuesto por hojas amoldables que admiten diferentes posiciones, lo que permite regular la luz. Disponible en color blanco, amarillo, rojo y azul.

Metal ceiling lamp in a matt grey finish. The flower-shaped diffuser has flexible silicon rubber leaves that can be moulded into different positions to regulate the light. Available in white, yellow, red and blue.

Deckenleuchte mit mattgrauer Metallhalterung. Den Lampenschirm bilden zwei verformbare Silikonblätter, mit denen sich unterschiedliche Beleuchtungseffekte erzielen lassen. Erhältlich in Weiß, Gelb, Rot und Blau.

◆ INC. GLOB. MÁX. 100W (E27) Ø120 mm.

MODULO
ELECTRO
www.modulelectro.ru



zip

Jonathan Daifuku

B.lux*

zip



SP216

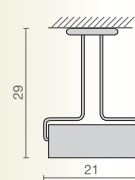

Luminaria halógena de techo.
En metal cromado y pantalla
níquelada, perforada y
orientable 140°.

Halogen ceiling lamp, in
chrome metal and nickel-
plated shade adjustable 140°.



Halogen-Deckenleuchte. Aus
verchromtem Metall, Schirm
vernickelt, perforiert und 140°
ausrichtbar.

HALOG. MAX. 200W (R7s) (L=78 mm.)

MODUL
ELECTRO
www.modulelectro.ru



apliques
wall lamps
wandleuchten

 **MODUL** 
ELECTRO
www.modulelectro.ru





МОДУЛЬ
www.modulelect.ru



ala

Beppe Benenti

Vanlux

ala 70/100/130/160

MODUL

ELECTRO

modulelectro.ru

ala 70

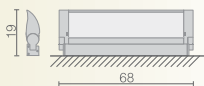

Aplicque orientable en cinco posiciones, fabricado por extrusión de aluminio de alta calidad. Su difusor es de policarbonato opal. Se fabrica en tres acabados: negro brillante, gris y blanco satinado. Disponible en cuatro tamaños.

ala 100

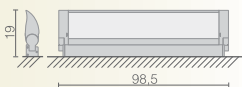

Adjustable wall lamp, in five positions, made from high quality extruded aluminium. The diffuser is opal polycarbonate. It comes in three finishes: shiny black, grey and satin white. Available in four sizes.

ala 130

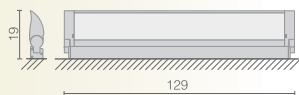

Verstellbare Wandleuchte mit fünf Positionen, aus hochwertigem, stranggepresstem Aluminium. Die Difusor-Scheibe ist aus opalweißem Polycarbonat. Oberfläche in drei Ausführungen erhältlich: Schwarz glänzend, Grau und Weiß satiniert. Lieferbar in vier Größen.

ala 160

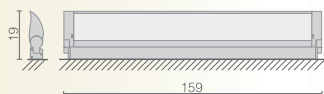

- ◇ 70: T8 FLUOR. 18W (G13)
- ◇ 100: T8 FLUOR. 30W (G13)
- ◇ 130: T8 FLUOR. 36W (G13)
- ◇ 160: T8 FLUOR. 58W (G13)



MODUL
ELECTRO
www.modulelectro.ru

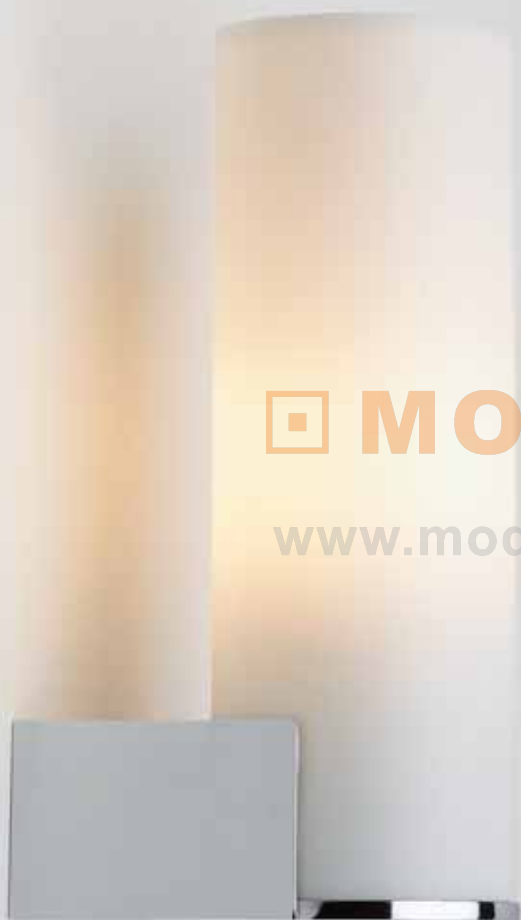

absid

Tabula Rasa

Ventux absid FLUOR / INC

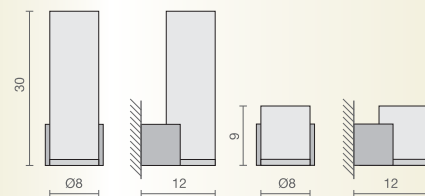

Aplicae en policarbonato y zamak cromado.
Versiones: fluorescente e incandescente.

Wall lamp produced in polycarbonate and
chromed zamak. Fluorescent and
incandescent versions.

Wandleuchte aus Polycarbonat und
verchromtem Zamak. Versionen:
Leuchtstoffröhre und Glühlampe.

FLUOR.: FLUOR, 20W (E27)
INC.: INC, MAX, 60W (E14)

MODULO ELECTRO

www.modulelectro.ru





MODULO
ELECTRO
www.modulelectro.ru

arku

Miguel Ángel Ciganda

Blux arku



<P63

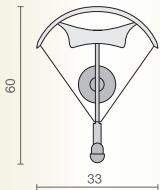

Aplique halógeno fabricado en metal, cristal y madera. Acabado: metal cromado brillante y madera en color caoba.

Halogen wall lamp produced in metal, glass and wood. Finish: bright chrome metal and wood in mahogany.

Halogen-Wandleuchte aus Metall, Glas und Holz. Ausführungen: Verchromtes Metall glänzend und Holz in den Farben Mahagoni.

HALOG. MAX. 250W (R7s) (L=78 mm.)



MODUL
ELECTRO
www.modul.electro.nu



MODULO
ELECTRO
www.modulelectro.ru

aeroa

Eduardo Albors

B.lux **aeroa**

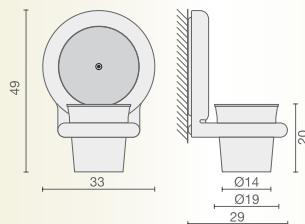

Luminaria de pared para interior y exterior, con dos fuentes de luz. Se trata de un conjunto formado por un aplique y una maceta para plantas, fabricado en PE antivandálico y resistente UVA, con acabado blanco satinado. Doble encendido.

Indoor and outdoor wall lamp with two light sources. It is a light plus plant pot holder, in a white satin finish, made from vandal proof UV resistant polyethylene. Double switch.

Wandleuchte für Innenräume und Außenbereiche, zwei getrennte Lichtquellen. Das Set besteht aus einer Halterung mit Blumentopf aus vandalismussicher und UV-beständigem Polyethylen, Weiß satiniert. Getrennt zu schalten.

IP54

FLUOR. CIRC. 22W (2Gx13) (840) + TIRA DE LED 2,4W 12V 3500° K



170

atala

Jorge Pensi

B.lux

atala

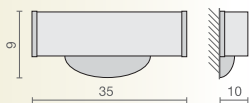

Aplicque halógeno en metal y vidrio curvado arenado.
Acabado en cromado o gris mate.

Halogen wall lamp produced in metal and curved
sanded glass. Finished in chrome or matt grey.

Halogen-Wandleuchte aus Metall und
sandgestrahltem, gebogenem Glas. Ausführung
in verchromt oder matt grau.



HALOG. MAX. 200W (R7s)



MODULO
ELECTRO
www.moduloelectro.ru

batela

Jorge Pensi

B.lux®

batela

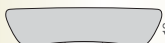

28

Aplique halógeno fabricado en aluminio pulido.



16

Halogen wall lamp produced in polished aluminium.

Halogen-Wandleuchte aus poliertem Aluminium.



HALOG. MAX. 300W (R7s)

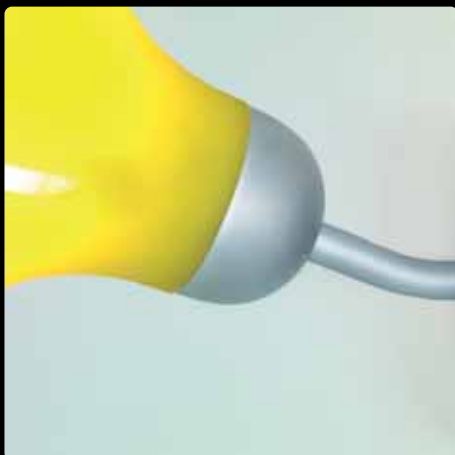

bellaflor

Beppe Benenti

B.lux®

bellaflor



SP20 SP68 SP98 SP160

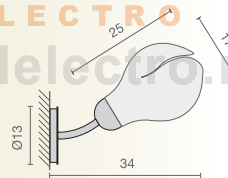

Aplicque fabricado en metal con acabado gris mate. Su difusor, con forma de flor, es de silicona y está compuesto por hojas amoldables que admiten diferentes posiciones, lo que permite regular la luz.

Disponibile en color blanco, amarillo, rojo y azul.

Metal wall lamp in a matt grey finish. The flower-shaped diffuser has flexible silicon rubber leaves that can be moulded into different positions to regulate the light. Available in white, yellow, red and blue.

Wandleuchte mit mattgrauer Metallhalterung. Den Lampenschirm bilden zwei verformbare Silikonblätter, mit denen sich unterschiedliche Beleuchtungseffekte erzielen lassen. Erhältlich in Weiß, Gelb, Rot und Blau.

INC. GLOB. MÁX. 100W (E27) Ø120 mm.

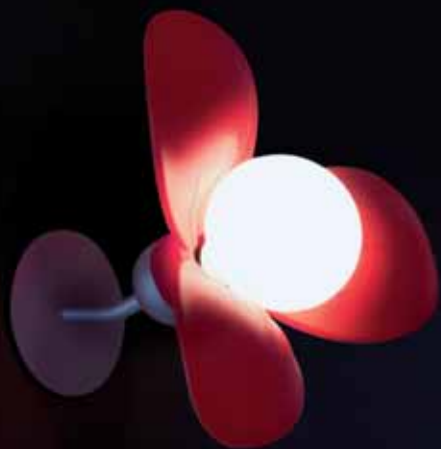

MODUL
ELECTRO
www.modulelectro.ru

bel-la

Manel Ybargüengoitia

Vanlux®

bel-la

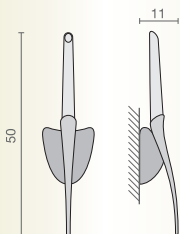

Aplique halógeno en vidrio acidado termorresistente. Cuerpo y base en cromo.

Halogen wall lamp produced in acid etched heat resistant glass. Body and base in chrome.

Halogen-Wandleuchte aus geätzttem, hitzebeständigem Glas. Lampenkörper verchromt und Untergrund aus verchromt.

HALOG. MÁX. 50W (G6,35)

MODUL

ELECTRO

www.modulelectro.ru

Copa

Gemma Bernal / Ramón Isern

Blux®

copa



SP140

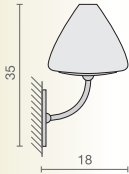

Aplique con difusor en vidrio blanco y metal color níquel.

Wall lamp with diffuser in glass white and metal in nickel colour.

Wandleuchte mit Diffusor aus weißem Glas und Metall in Nickelfarbe.

INC. MAX. 75W (E27)

MODUL
ELECTRO
www.modulelectro.ru





MODUL
ELECTRO
www.modulelectro.ru



MODULO
ELECTRO

www.modulelectro.ru

dolce

Miguel Ángel Ciganda



dolce 1/2/3

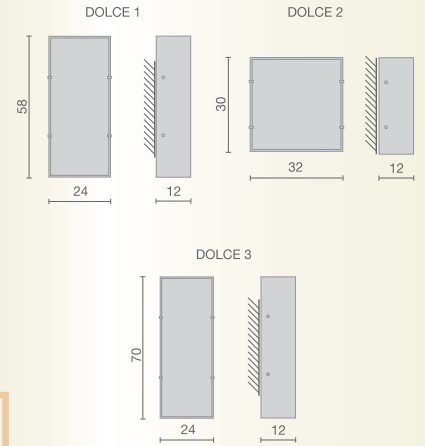

Appliques fluorescentes con difusor de tela en blanco crudo.

Fluorescent wall lamps with natural white textile diffuser.

Wandleuchten mit Leuchtstoffröhre, mit Diffusor aus roh-weißem Stoff.

- ⦿ DOLCE 1: FLUOR, 36W (2G11)
- DOLCE 2: FLUOR, 2 x 18W (2G11)
- DOLCE 3: FLUOR, 3 x 18W (G13)





MODUL
ELECTRO
www.modulelectro.ru

MODUL
ELECTRO
www.modulelectro.ru



179

dolcetta

Manel Ybargüengoitia

Vanlux **dolcetta**



>P26 >P69 >P100 >P142

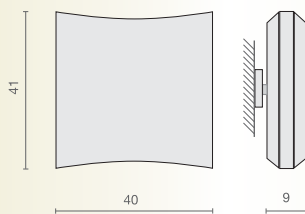

Aplicue fluorescente con difusor de tela en color blanco.
Fácilmente combinable en diferentes composiciones.

Fluorescent wall lamp. Textile diffuser in white colour. Easy to combine in many special ways.

Wandleuchte mit Leuchtstoffröhre mit Diffusor aus weißem Stoff. Leicht zu kombinieren in verschiedenen Zusammensetzungen.

FLUOR, CIRC, 22W (2Gx13)

duna

Jorge Pensi

Vanlux

duna 11/5



DUNA 11

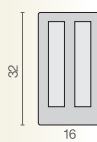

Apliques fluorescentes de superficie. Difusores de policarbonato pintado y metal cromado.

Fluorescent wall lamps surface mounted. Painted polycarbonate and chrome metal diffusers.

DUNA 5



Wandleuchten mit Leuchtstoffröhre auf der Oberfläche. Difusoren aus gestrichenem Polycarbonat und verchromtem Metall.



DUNA 11: FLUOR. 2 x 11W (G23)
DUNA 5: FLUOR. 2 x 5W (G23)



MODUL
ELECTRO
www.modulelectro.ru

eliana

Manel Ybargüengoitia

B.lux®

eliana cuadro



527



Aplique fluorescente de inox y zamak acabado en gris metalizado.

Fluorescent wall lamp produced in stainless and zamak. Finished in metalized grey.

Wandleuchten mit Leuchtstoffröhre aus Innox und Zamak, Ausführung in grau metallisiert.

FLUOR. 13W (w4,3) Ø7 mm.

MODUL

ELECTRO

www.modulelectro.ru





eliana

Manel Ybargüengoitia

B.lux® eliana applique



>P27

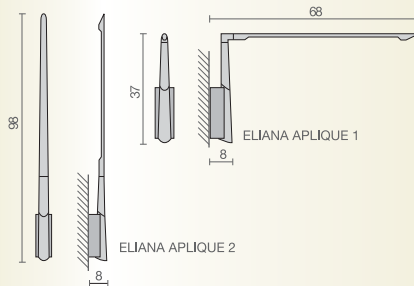

Apliques fluorescentes de inox y zamak acabado en gris metalizado.

Fluorescent wall lamps produced in stainless and zamak. Finished in metalized grey.

Wandleuchten mit Leuchtstoffröhre aus Inox und Zamak, Ausführung in grau metallisiert.

FLUOR. 13W (w4,3) Ø7 mm.

MODULO
ELECTRO
www.moduloelectro.com



MODULO
ELECTRO
www.modulelectro.ru



MODUL
ELECTRO
www.modulelectro.ru



MODULO
ELECTRO
www.modulelectro.ru



emma

Miguel Ángel Ciganda

B.Lux®

emma

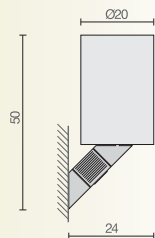

Aplique con difusor de tela blanco crudo. Metal acabado en gris mate. Iluminación ambiental y puntual para lectura.

Wall lamp with textile diffuser in natural white. Metal finished in matt grey. Diffused light and adjustable beam for reading.

Wandleuchte mit Diffusor aus roh-weißem Stoff. Metallausführung in matt grau. Indirekte Beleuchtung und Leselampe.



INC. MÁX. 100W (E27)
HALOSPOT MÁX. 20W 12V (Gy4)

MODUL
ELECTRO
www.modulelectro.ru

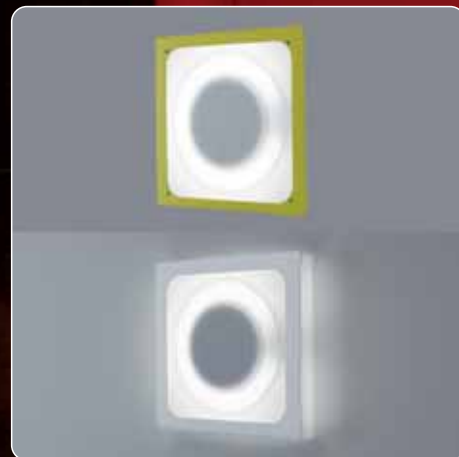
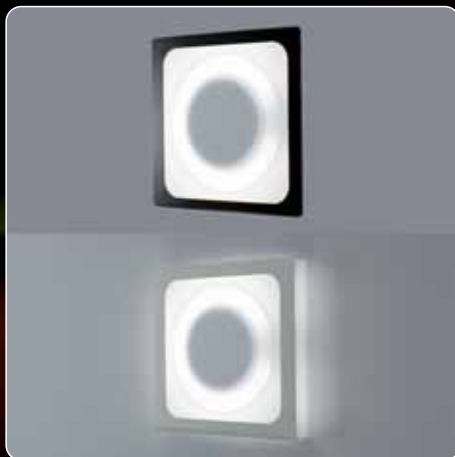

haro

Francesc Vilaró

haro superficie/empotrado

superficie



empotrado

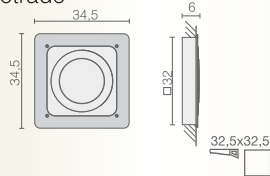

Profundidad mínima 65 mm.

Aplic de interior y exterior compuesto por un cuerpo de PE antivandálico blanco opalino liso resistente UVA enmarcado por un elemento de acero inoxidable de forma cuadrada. Disponible en acabados inoxidable, verde, blanco y negro. Todos ellos se comercializan en versión superficie y empotrada.

Indoor and outdoor wall lamp, in a smooth white frosted finish, made from vandal proof UV resistant polyethylene with a square stainless steel frame. Available in stainless steel, green, white and black finishes. All models are available in surface and embedded versions.

Wandleuchte für Innenräume und Außenbereiche, Leuchtkörper aus vandalismussicherem und UV-beständigem PE, eingefasst in einen quadratischen Edelstahlrahmen. Rostfreie Oberfläche, in Grün, Weiß und Schwarz. Erhältlich als Außenleuchte oder als Einbauleuchte.

FLUOR, CIRC, 22W (2Gx13)

jackie

Josep Novell/Josep Puig

B.lux® jackie



SP29 SP70 SP110

80
23
11

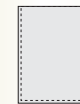

Aplique con difusor
contenedor de doble pared
en metacrilato transparente
y opalino que sirve para
personalizar la luminaria
introduciendo diferentes tipos
de relleno.

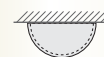

Wall lamp with container
diffuser with double covering
in transparent and opaline methacrylate which
makes possible to personalize the lamp filling
it up with different motives.

Wandleuchte mit Diffusor-Behälter mit doppelter
Wand aus durchsichtigem oder opal Acrylglas,
mit dem die Leuchte durch verschiedene
Füllungen persönlich gestaltet werden kann.

FLUOR. 18W (2G11)



MODUL
ELECTRO
www.modulelectro.ru





MODUL
ELECTRO
www.modulelectro.ru



julia & julieta

Manel Ybargüengoitia

Blux julia & julieta



SP31 SP71 SP106 SP141
SP107

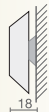

Luminarias de aplique fluorescentes. Metal acabado gris mate y difusor de metacrilato blanco mate que oculta totalmente la fuente de luz.

Fluorescent wall lamps. Metal finished in matt grey and matt white methacrylate diffuser, which covers completely the light source.

Wandleuchte mit Leuchtstoffröhre. Metallausführung in matt grau und Diffusor aus matt weißem Acrylglas, das die Lichtquelle vollständig verbirgt.

JULIA: FLUOR, CIRC, 55W (2Gx13)
JULIETA: FLUOR, CIRC, 22W (2Gx13)

luna

Jorge Pensi

B.lux*

luna

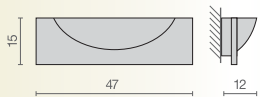



Aplicado de aluminio.
Acabado en gris mate.
Adecuado para
iluminación indirecta de
grandes espacios. Tres
versiones.

Wall lamp in aluminium.
Finished in matt grey.
Adequated for indirect
illumination of big areas.

Wandleuchte aus
Aluminium. Ausführung
in matt grau. Geeignet
für die indirekte
Beleuchtung in großen
Räumen. Drei
Versionen.



HQI-TS MÁX. 150W (Rx7s-24)
HQI-TS MÁX. 70W (Rx7s)
HALOG. LINEAL MÁX. 300W (R7s)

 **MODUL** 
ELECTRO
www.modulelectro.ru

mirror

Jan Van Lierde

B.lux*

mirror 1/2/3



SP33 SP74

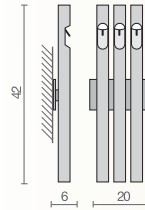
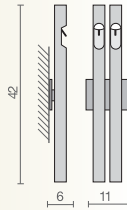
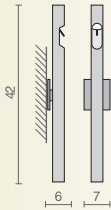

Aplique halógeno.
Aluminio extruido lacado
en gris metalizado. Haz
de luz orientable
mediante espejo
reflector.

Halogen wall lamp.
Extruded aluminium,
lacquered in metalized
grey. Adjustable beam
by reflecting mirror.

Halogen-Wandleuchte.
Extrudiertes Aluminium
in grau-metallisiert.
Ausrichtbarer Lichtstrahl
mit reflektierendem
Spiegel.

- MIRROR 1: HALOG. MR8 MÁX. 20W 12V (Gz4)
- MIRROR 2: HALOG. MR8 2 x MÁX. 20W 12V (Gz4)
- MIRROR 3: HALOG. MR8 3 x MÁX. 20W 12V (Gz4)





MODUL
ELECTRO
www.modulelectro.ru



MODUL

nina & nino ELECTRO

www.modulselectro.ru

B.lux

nina & nino

Gemma Bernal



>P38 >P76 >P112

nina

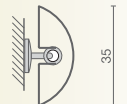
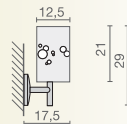

nino

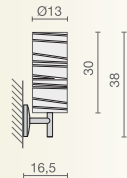

Apliques con cuerpo metálico pintado y pantalla serigrafiada. Nina está disponible en un único acabado: marrón combinado con pantalla marrón textil que dibuja círculos. Nino está disponible en acabado gris brillo combinado con pantalla de policarbonato blanco con rayas impresas.

Wall lamps with painted metal body and printed screen. The Nina model is available in one finish: brown with brown fabric screen with circle prints. The Nino model is available in shiny grey finish with white polycarbonate screen with printed stripes.

Wandleuchten mit lackierter Metallstruktur und bedrucktem Lampenschirm. Nina ist in braune Struktur und mit Kreisen bedruckter, brauner Lampenschirm. Nino ist in nur einer Ausführung lieferbar: Graumetallik, Lampenschirm aus weißem Polycarbonat, bedruckt mit Linien.

INC. GLOB. MÁX. 100W (E27)



MODUL
ELECTRO
www.modulelectro.ru





MODUL
ELECTRO
www.modulelectro.ru

nora



nora

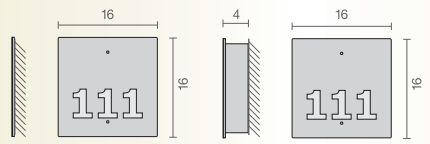

Aplique de superficie o empotrado, realizado en acero inox y difusor de policarbonato. Permite incorporar múltiples pictogramas.
**Colocación con plaster kit o concrete box.*

Surface or recessed wall light, made out of stainless steel and a polycarbonate diffuser. Multiple pictograms may be incorporated.
**Mounting with plaster kit or concrete box.*

Wandleuchte auf der Oberfläche oder unter Putz aus Inox-Stahl, mit Difusor aus Polycarbonat. Bietet die Möglichkeit, Piktogramme einzufügen.
**Anbringung mit Plaster kit oder Concrete box.*

FLUOR. COMP. 7W (Gx53)

MODUL
ELECTRO
www.modulelectro.ru

196



Olympia

Jorge Pensi

B.lux*

olympia U/D



S-P75 S-P116



OLYMPIA U

Aplicado halógeno fabricado en aluminio pulido.

Halogen wall lamp produced in polished aluminium.

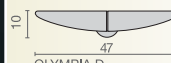

OLYMPIA D

Halogen-Wandleuchte aus poliertem Aluminium.



OLYMPIA U: HALOG, MÁX. 200W (R7s)
OLYMPIA D: HALOG, 2 x MÁX. 200W (R7s)

MODULO
ELECTRO
www.modulelectro.ru

ovo

Gemma Bernal / Ramón Isem

B.Lux

OVO

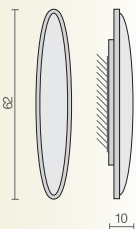

Aplicue
fluorescente
realizado en metal
acabado en gris
mate.

Fluorescent wall
light in matt grey
finish metal.

Wandleuchte mit
Leuchtstoffröhre
aus Metall in der
Ausführung matt
grau.

IP44

FLUOR. 36W (2G11)

petite

Miguel Herranz

B.lux

petite



P40 >P78

Luminaria de aplique articulada y orientable, fabricada en aluminio extruido y compuesta de estructura y soporte. Disponible con pantalla de aluminio y policarbonato o con pantalla textil blanca cruda. Acabados: gris mate o anodizado.

Wall lamp structure, articulated and adjustable. Produced in extruded aluminium. Available with an aluminium or polycarbonate screen or with a natural white fabric screen. Finish: matt grey or anodized.

Wandleuchte mit Gelenken und ausrichtbar, hergestellt aus extrudiertem Aluminium und bestehend aus Struktur und Halter. Angeboten mit Schirm aus Aluminium und Polycarbonat oder roh-weißem Stoffschirm. Ausführungen: matt grau oder anodisiert.

- ◊ PETITE 21+: INC. MAX. 60W (E14)
- PETITE 22+: INC. MAX. 60W (E27)
- PETITE 11+: INC. MAX. 60W (E14)
- PETITE 12+: INC. MAX. 60W (E27)

ESTRUCTURAS
STRUCTURES
STRUKTUR

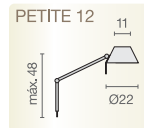
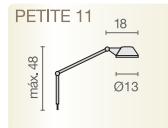
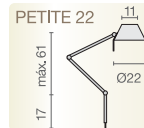
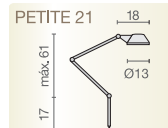

SOPORTES
BRACKETS
STÄNDER

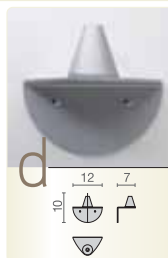

MODULO
ELECTRO
www.modulelectro.ru



MODULO
ELECTRO

www.modullectro.ru

petite

Miguel Herranz

B.Lux* petite PINZA 

>P40 >P78

Pantalla textil blanca.
Acabado en gris mate.



White textile diffuser.
Matt grey finish.



Lampenschirm aus
weißem Stoff.
Ausführung in matt grau.



 INC. MAX. 60W (E27)



MODUL
ELECTRO
www.modulelectro.ru

პიპიო

Manel Ybargüengoitia

Vanlux® **pío pío** 
S-P42

117



Aplic de halògeno amb braç d'alumini en gris i carcassa negra texturada i vidre soplado acidado.

Halogen wall light with grey aluminium arm and texture black and etched blown glass casing.

Halogen-Wandleuchte mit Aluminiumarm in grau und schwarzem Gehäuse mit Textur und geätztem, geblasenem Glas.

 HALOG. 3 x MÁX. 20W (G4)



MODULO
ELECTRO
www.modulelectro.ru

pisa

Carlos Torrente / Pau Roviras

Blux® **pisa**

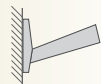

Aplicado halógeno en metal. Acabado en gris mate.

Halogen wall lamp in metal. Matt grey finish.

Halogen-Wandleuchte aus Metall. Ausführung in matt grau.

□ 11 24

◇ HALOG. MÁX. 150W (R7s)



MODUL
ELECTRO
www.modulelectro.ru



pinot

Jan Van Lierde

B.lux® **pinot c/s**



SP18

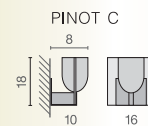

Aplicado halógeno fabricado en vidrio y acero inoxidable. Acabado blanco opal o rojo.

Halogen wall lamp produced in glass and stainless steel. Opal white and red finish.

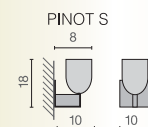

Halogen-Wandleuchte aus Glas und rostfreiem Stahl. Ausführung Opalweiß oder Rot.



HALOG. MÁX. 75W (G9)

q.bo

Carlos Serra / Antonio Herrero

Vanlux® q.bo



SP44 SP144

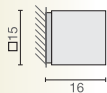

Aplicado y plafón con difusor de policarbonato, permite incorporar pictogramas.

Wall and ceiling lamp with polycarbonate diffuser, permits the incorporation of pictograms.

Wand- und Deckenleuchte mit Diffusor aus Polycarbonat, bietet die Möglichkeit, Piktogramme einzufügen.

FLUOR. 18W (Gx24 d-2)



1



2



3



4



5



6



7



8



9



10



11



12



13



14



15



16

MODULO
ELECTRO
www.modulelectro.ru

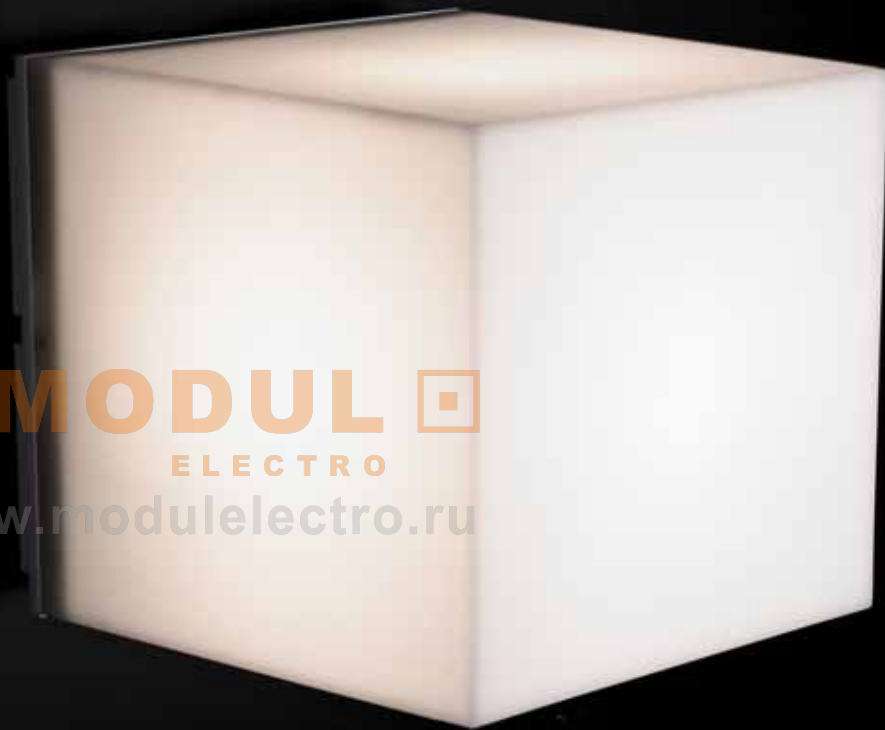

quadrat

Jorge Pensi

Blux*

quadrat

120x10



SP120 SP146
SP122



Aplique fabricado en madera laminada de roble y disponible en dos acabados: roble natural y wengué. Difusor de film termorretráctil.

Wall light made out of oak and available in two finishes: natural oak and wenge. Thermo retractable film diffuser.

Wandleuchte aus Eichen-Schichtholz und verfügbar in zwei Ausführungen: Natureiche und Wenge. Difusor aus wärmeschumpfender Folie.

FLUOR, 2 x 55W (2G11)



MODUL
ELECTRO
www.modulelectro.ru





MODUL
ELECTRO
www.modulelectro.ru

rca

Gemma Bernal

B.Lux® rca



SP46 SP80 SP124

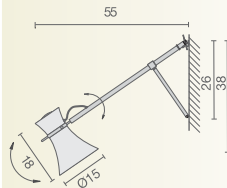

Aplique con trípode metálico de acabado cromado. La pantalla, fabricada en aluminio pulido con acabado anodizado mate, es orientable.

Wall light with a chrome finished metal tripod. The screen, made out of polished aluminium with anodized matt finish is adjustable.

Wandleuchte mit Metallhalter in verchromter Ausführung. Der Schirm ist aus poliertem und matt anodisiertem Aluminium und lässt sich in der Richtung ändern.

- ◆ INC. REFLECTORA MÁX. 60W (E27)
- ◆ FLUOR. MASTER PL-E 15W (E27)
- ◆ FLUOR. DULUX EL LL 15W (E27)



MODULO ELECTRO
www.moduloelectro.ru



MODUL
ELECTRO
www.modulelectro.ru



MODUL
ELECTRO

www.modulelectro.ru

OFFICE DESIGN

Foster



sandy

Eduardo Albers

Vanlux

sandy

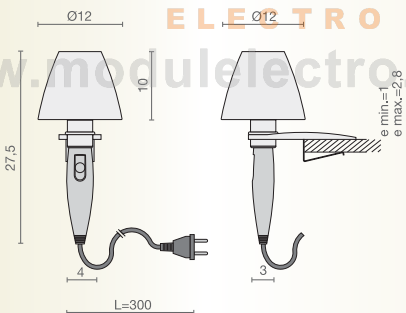

Aplicador con pinza fabricado en policarbonato. Su pantalla es bicolor para evitar el deslumbramiento del usuario. Está disponible en dos acabados: blanco-rojo o blanco-azul. Portátil. Largo de manguera de 3 metros.

Wall lamp with polycarbonate clip. It has a two-tone screen to prevent glare. It is available in two finishes: white-red or white-blue. Portable. Cord length of 3 metres.

Wandlampe mit Klemme aus Polycarbonat. Ihr Schirm ist zweifarbig, damit der Verbraucher nicht geblendet wird. In zwei Ausführungen erhältlich: Weiß-rot oder Weiß-blau. Tragbar. Anschlusslänge von 3 Metern.

INC. MÁX. 40W (E14)



MODULO
ELECTRO
www.modulelectro.ru

210

regina

Jorge Pensi

Blux regina



>P48 >P79 >P130



Aplique halógeno fabricado en aluminio pulido brillante. Pantalla de aluminio o vidrio blanco o azul.

Halogen wall lamp produced in bright polished aluminium. Aluminium shade or blue or white glass.

Halogen-Wandleuchte aus poliertem Aluminium. Schirm aus Aluminium oder weißem oder blauem Glas.

HALOG. MAX. 200W (R7s)





MODULO
ELECTRO
www.modulelectro.ru

sare

Héctor Fernández

Blux sare

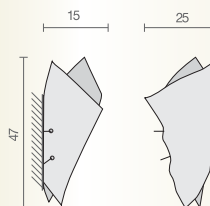

Aplique halógeno con doble apantallamiento de nomex y tela metálica inoxidable.

Halogen wall lamp with double shade produced in nomex and stainless metallic textile.

Halogen-Wandleuchte mit doppeltem Schirm aus Nomex und rostfreiem Metallstoff.

♦ HALOG. MÁX. 70W +
HALOG. MÁX. 40W (G9)



MODUL
ELECTRO
www.modulelectro.ru



MODULO ELECTRO

www.modulelectro.ru

sor

Jorge Pensi

Vanlux®

sor



>P54

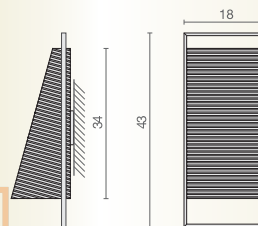

Aplic de estructura metálica con acabado níquel satinado y pantalla realizada en poliéster contracolado.

Wall light with a satin nickel finished metal structure, and laminated polyester screen.

Wandleuchte mit Metallstruktur in satiniertes Nickelausführung und Schirm aus gegengeleimtem Polyester.

INC. OPAL MÁX. 60W (E27)



MODULO
ELECTRO
www.modulelectro.ru



ura

Miguel Ángel Ciganda

B.lux* **ura**

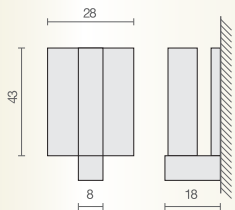

Aplique fluorescente de aluminio lacado en blanco mate. Iluminación ambiental y puntual para lectura.

Fluorescent wall lamp produced in lacquered aluminium in matt white. Diffused light and adjustable beam for reading.

Wandleuchte mit Leuchtstoffröhre aus lackiertem Aluminium in matt weiß. Indirekte Beleuchtung und Leselampe.

FLUOR, 24W (2G11)
 HALOSPOT MÁX. 20W 12V (Gy4)



MODULO
ELECTRO
www.modulelectro.ru

zip

Jonathan Daifuku

B.lux® zip



SP161

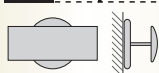

21

14

Aplique halógeno. En metal cromado y pantalla niquelada, perforada orientable 140°.

Halogen wall lamp in chrome metal and nickel shade, perforated and adjustable 140°.

Halogen-Wandleuchte. Aus verchromtem Metall, Schirm vernickelt, perforiert und 140° ausrichtbar.



HALOG. MAX. 200W (R7s) (L=78 mm.)

zentrum

Jorge Pensi

B.lux® **zentrum1/2/3/4** 
 SP158

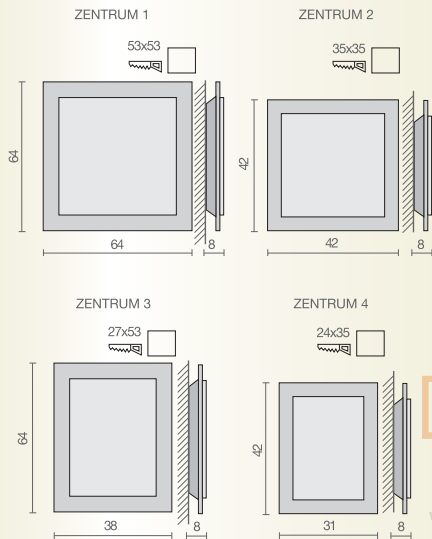

Luminaria fluorescente para aplique de pared.
 Versiones: de superficie o encastrada.
 Acabado: gris mate. Difusor de metacrilato
 opalino blanco de alto rendimiento lumínico.
 Sistema magnético de sujeción del difusor
 para fácil acceso a las lámparas. Equipada
 con balastos electrónicos.

Fluorescent wall lamp. Versions: surface or
 recessed mounted. Finish: matt grey. White
 opaline diffuser produced in methacrylate
 with a high luminous efficiency. Diffuser mag-
 netic subjection system for easy access to the
 inner part. Equipped with electronic ballast.

Leuchte mit Leuchtstoffröhre für Wandlampe.
 Versionen: Auf der Oberfläche oder unter Putz.
 Ausführung: Matt grau. Diffusor aus Acrylglas,
 opalweiß, mit hoher Leuchtkraft. Magnetisches
 Haltesystem des Diffusors zum leichten Zugriff
 auf die Lampen. Mit elektronischen
 Vorschaltgeräten.

- ◆ ZENTRUM 1: FLUOR, 4 x 36W (2G11)
- ◆ ZENTRUM 2: FLUOR, 4 x 18W (2G11)
- ◆ ZENTRUM 3: FLUOR, 2 x 36W (2G11)
- ◆ ZENTRUM 4: FLUOR, 2 x 18W (2G11)

MODUL
 ELECTRO
www.modulelectro.ru





MODUL
ELECTRO
www.modulelectro.ru

DISEÑO Y MAQUETACIÓN
Moriwase

DEPÓSITO LEGAL
BI-2605-2010

B.lux

Vanlux

COMERCIAL

Polígono Eitua, 70.

48240 Berriz, Spain

T. (+34) 902 10 77 35 | F. (+34) 902 10 77 96

info@grupoblux.com

FACTORY

Polígono Industrial Okamika, 11

48289 Gizaburuaga, Spain

T. (+34) 94 684 29 50 | F. (+34) 94 624 36 99

info@grupoblux.com



MODUL
ELECTRO
www.modulelectro.ru

Agradecimientos

Jorge Oteiza Fundazio Museoa

Txema G. Amiano

Azkoitiko Udala

Bokado Restaurante

Lukas Gourmet

Arteleku

Hotel Marqués de Riscal

Hotel Hesperia Bilbao

Itzia Decoración

Gakoak

Hotel Zenit Bilbao

