

BRUMBERG®
— Licht seit Generationen —

BRUMBERG®
— Licht seit Generationen —

MODUL
ELECTRO
www.modulelectro.ru

BRUMBERG Leuchten GmbH & Co. KG · Hellefelder Str. 63 · 59846 Sundern · Tel. +49 (0) 29 34 / 96 11 -0 · Fax: 96 11 -96

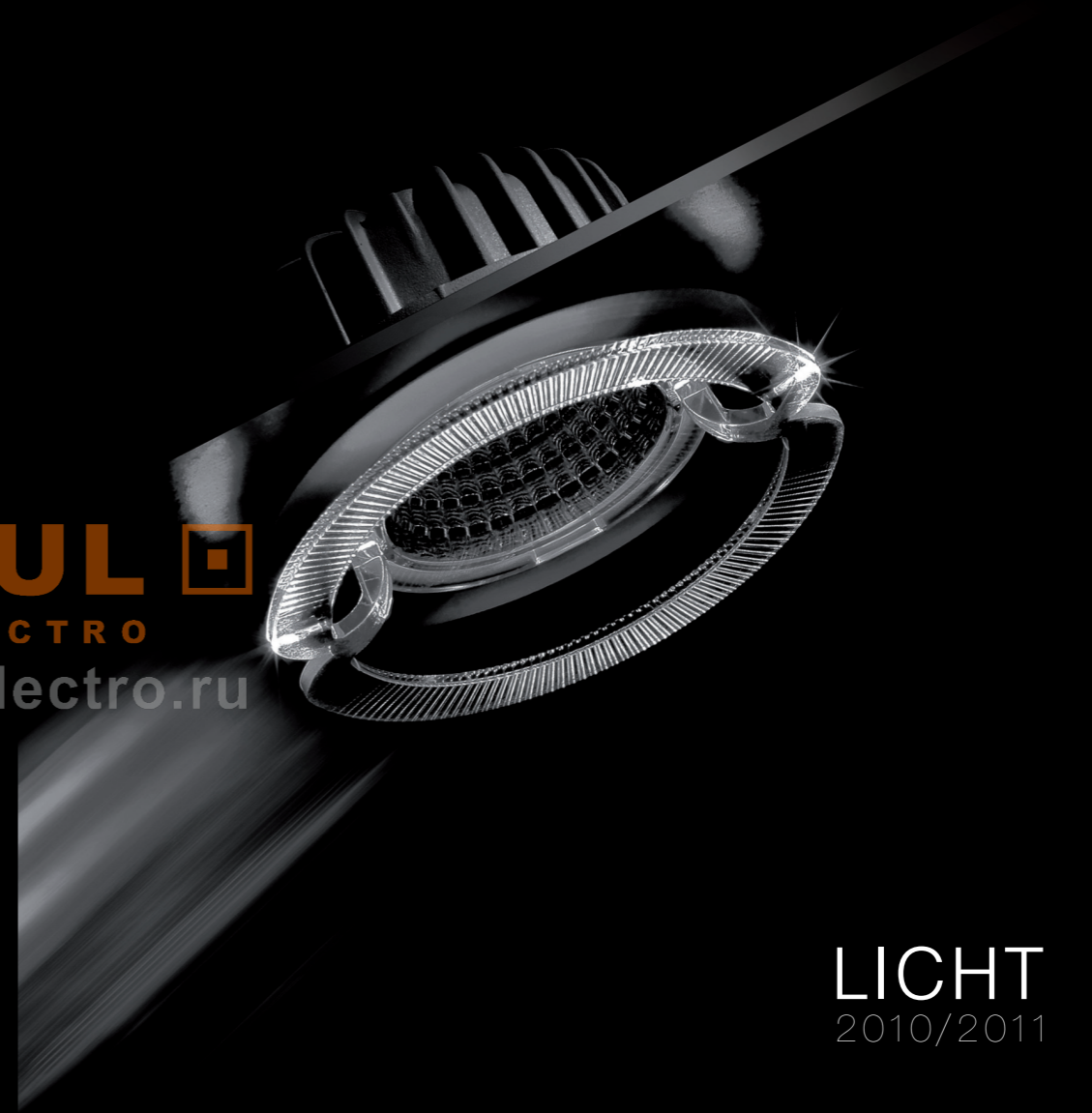

LICHT
2010/2011

BRUMBERG®

— Licht seit Generationen —

 **MODULO** LICHT 2010/2011
ELECTRO
www.modulelectro.ru

UNIVERSAL DESIGN SPOT

36 - 45



SL501WW4 38 SL503WW4 39 SL600WW4 40

Beau for Brumberg

46 - 71

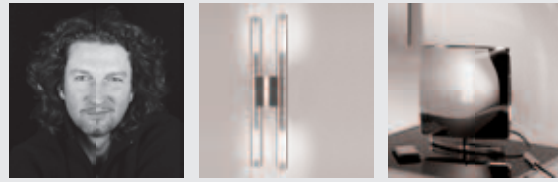

One 48 Reveal 49 Reflection 54

LED Leuchten

LED lights

72 - 187



Einsätze inserts 79 Deckenspots ceiling spots 90 Aufbauleuchten surface mounted lights 106

LED/RGB Leuchten

LED/RGB lights

188 - 209

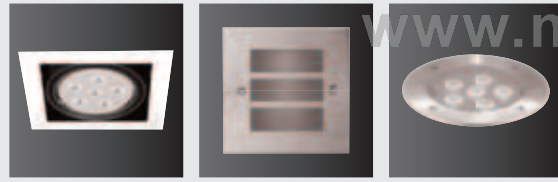

Deckenspots ceiling spots 188 Wandeinbauleuchten recessed wall lights 196 Bodeneinbauleuchten recessed in-ground lights 198

Spots

spots

210 - 317

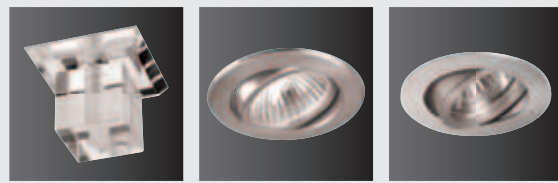

Sternenhimmel / Lichtpunkte 220 starry sky / light spots Eisen iron 226 Guss cast 234

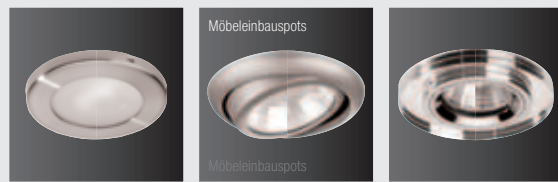

Möbeleinbauspots mit erhöhter Schutzart 268 with high degree of protection mit niedriger Einbautiefe 278 with low installation depth Deko & Objekt deco & object 286

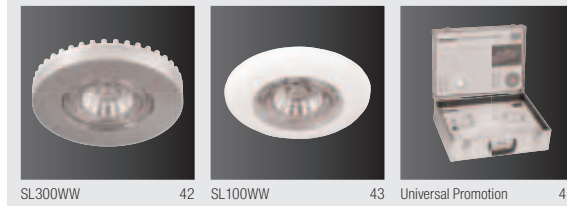

SL300WW 42 SL100WW 43 Universal Promotion 44

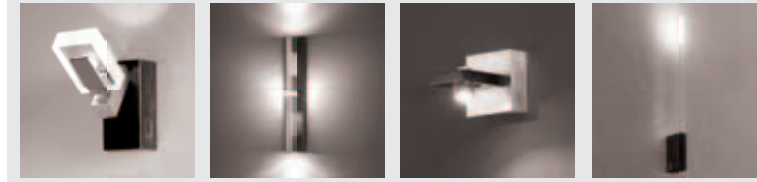

Glow 56 Ray 60 BOMAC 62 ICICLE 68

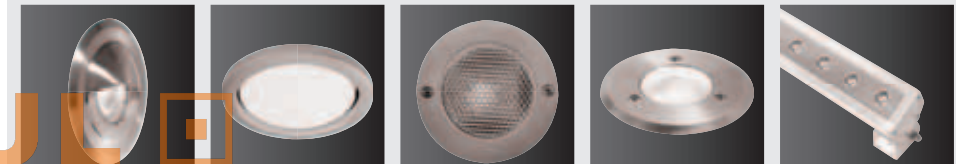

Lichtpunkte light points 108 mit niedriger Einbautiefe with low installation depth 124 Wandeinbauleuchten recessed wall lights 128 Bodeneinbauleuchten recessed in-ground lights 160 Profile profiles 175



Profile profiles 202

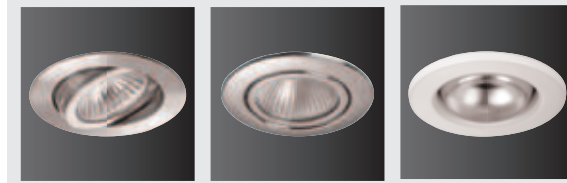

Reiner Edelstahl pure stainless steel 248 Rein Messing pure brass 254 Hochvolt high voltage 260

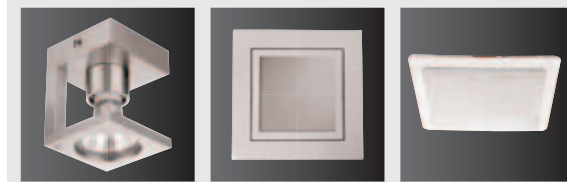

Deckenaufbau surface mounted lights 300 Wand- & Orientierung wall- & orientation 306 Lautsprecher loudspeaker 310

MODULO
ELECTRO
www.modulelectro.ru

Downlight

318 - 343



Mini-Downlights 320



Downlights 322

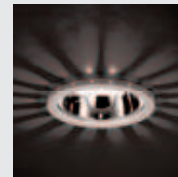

Lichtoptik light optics 328

Faseroptik
fibre optics

344 - 381

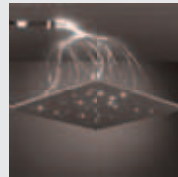

Sets 350

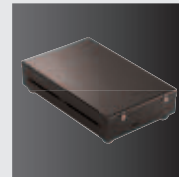

Effekt-Projektoren effect-projectors 356



Exklusiv-Sets exclusive sets 359

Außenleuchten
outdoor lights

382 - 405

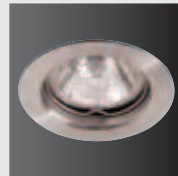

Deckenspots ceiling spots 384



Wandeinbauleuchten recessed wall lights 388



Bodeneinbauleuchten recessed in-ground lights 390

Gips-Leuchten
plaster lights

406 - 413



Wandleuchten wall lights 408

Objekt
object

414 - 439



Palladium 416



Deckenleuchten ceiling lights 420



Pendelleuchten pendant lights 430

Zubehör
accessories

440 - 475



LED-Zubehör LED-accessories 442



LED/RGB-Zubehör LED/RGB-accessories 452

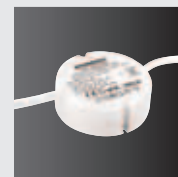

NV-Zubehör low voltage-accessories 460

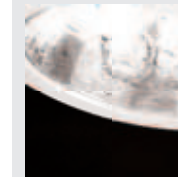

IP44 330



Bajonettssystem bajonett system 333



Quadratisch square 336

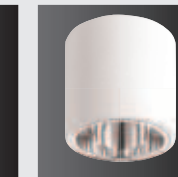

Aufbaudownlights surface mounted downlights 340

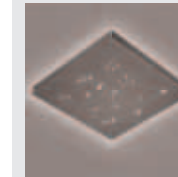

Fertigelemente complete elements 360

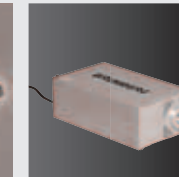

Projektoren projectors 362

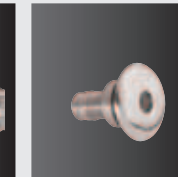

Zubehör accessories 369

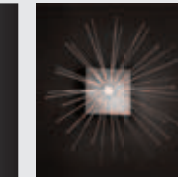

Lichtobjekte light objects 378



Objektleuchten object lights 396

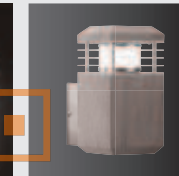

Nature 398

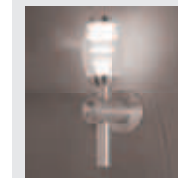

Wandleuchten wall lights 432



AMP-Zubehör AMP-accessories 470



Leuchtmittel bulbs 472

MODULO
ELECTRO
www.modulelectro.ru

Generation Licht / generation light

Licht ist mehr als nur elektromagnetische Strahlung. Licht ist Leben.
Licht ist Wärme, weckt Emotionen und unterstützt das Wohlbefinden.

Das Ergebnis sind innovative, effiziente und langlebige Lichtkonzepte aus dem Hause Brumberg.

Light is more than only electromagnetic radiation. Light is life.
Light is coziness, it creates emotions and supports our well-being.



Mitgliedschaften / memberships:

ZVEI: licht.de DIALux

www.modulelectro.ru



Kompetenz seit 1873 / competence since 1873

Bereits seit fünf Generationen bietet Brumberg Leuchten höchste Kompetenz rund um das Thema Leuchten. Durch stetige Weiterentwicklungen und Innovationen konnte sich das Unternehmen auch in schwierigen Zeiten am Markt behaupten. Weg von der reinen Leuchtenmontage hin zur Elektrotechnik und Lichtplanung war ein großer und bedeutender Schritt.

Durch eine besonders hohe Flexibilität des gesamten Unternehmens ist eine schnelle Reaktion auf Schwankungen am Markt möglich.

Since five generations already, BRUMBERG deals with light at the highest stage. Despite difficult economic climate, the company could assert its position in the market by current developments and innovations. Leaving the solely luminaire assembly up to electrical engineering and light planning was a big and important step forward.

Occurred by an exceptionally high flexibility of the whole company a fast reaction to the market's fluctuations is feasible.



von links: **Benedikt Brumberg** - Leitung Einkauf, **Antoinette Brumberg** - Geschäftsleitung
Johannes Brumberg - Gechäftsleitung, **Johannes Brumberg Junior** - Gechäftsleitung

from the left: **Benedikt Brumberg** - CPO, **Antoinette Brumberg** - CEO
Johannes Brumberg - CEO, **Johannes Brumberg Junior** - CEO



MODUL
 ELECTRO
www.modulelectro.ru

Lichtkompetenz
seit mehr als 130 Jahren
light competence
since more than 130 years

1892
Die 2. Generation

Nach dem Tode des Firmengründers im Jahre 1892 führte sein Sohn Josef die Geschäfte erfolgreich weiter und schon gegen Ende des 19. Jahrhunderts erlangte das mittlerweile recht umfangreich gewordene Programm ein hohes Ansehen in der Leuchtenbranche.

1892
The second generation

After the death of the company's founder in 1892, his son Josef managed the business successfully. By the end of the 19th century already, the considerable range had an excellent reputation within the lighting branch.

1933
Die 3. Generation

Nach einigen Rückschlägen übernahmen die Söhne Josef und Walter Brumberg im Jahre 1933 das Unternehmen.

1933
The third generation

After some setbacks the sons Josef and Walter Brumberg overtook the company in 1933.

1950
Erneut Großbrand

Im Jahre 1950 zerstörte erneut ein Großbrand die Fabrik und mit ihr viele wichtige Unterlagen wie Konstruktionszeichnungen u.ä.. Trotzdem konnte das Unternehmen wiederum gerettet werden.

1950
A fire again

In 1950 a fire destroyed the company and its most important documents and files as well as design drawings again. Nevertheless, the enterprise could be recovered in turn.

1985
Neugründung

Infolge einer wirtschaftlichen Krise und den damit verbundenen Differenzen wurde die Lampenfabrik Josef Brumberg im Jahre 1985 aufgelöst, aber noch im gleichen Jahr setzte die neugegründete Brumberg Leuchten GmbH & Co.KG die Familientradition fort.

1985
New foundation

Due to an economic crisis, associated with differences the lighting company Josef Brumberg was liquidated in 1985. However, in the same year the new founded Brumberg-Leuchten GmbH & Co. KG continued with the family's tradition.

2007
Johannes Brumberg jun. wird Geschäftsführer

Johannes Brumberg jun. wird Geschäftsführer und unterstützt damit die Geschicke seiner Eltern Antoinette und Johannes Brumberg.

2007
Johannes Brumberg jr. became CEO

Johannes Brumberg jr. became CEO and facilitated the skills of his parents Antoinette and Johannes Brumberg.

2008
DIAL

Brumberg wird Premium Mitglied bei DIAL..

2008
DIAL
Brumberg became a member of DIAL..



www.modulelectro.ru



1873
Firmengründung

Im Jahre 1873 gründete der aus einer alten Bauern- und Händlerfamilie stammende Kaufmann Hermann Josef Brumberg die gleichnamige Metallwarenfabrik als eine der ersten dieses Industriezweiges in Sundern.

1873
company foundation

In 1873 the merchant Hermann Josef Brumberg, born in an old peasant and trader family, founded the homonymous metal ware company as one of the first industries in Sundern.

1875
Petroleumlampen

Da im nahegelegenen Neheim bereits Petroleumlampen für den im Sauerland rege betriebenen Erzbergbau hergestellt wurden, stellte man 1875 den Betrieb zunächst auf Zubehörtelle, später dann auch auf komplette Petroleumlampen um.

1875
Oil lamps

In Neheim, which is nearby to Sundern, oil lamps were already produced for the ore mining in the Sauerland area. Therefore, the company was initially adapted to accessories for oil lamps in 1875, afterwards it was changed to the complete production of oil lamps.

1890
Rückschläge für Brumberg

Im Jahre 1890 vernichtet eine Flutkatastrophe im Röhrtal fast die gesamte Produktion.

1890
Setbacks for Brumberg

In 1890 a flood disaster in the valley of the Röhre river ruined almost the whole production.

1914
Brand zerstört Werksanlagen

1914 zerstörte ein Großbrand die kompletten Werksanlagen, doch auch der erste Weltkrieg mit der darauf folgenden Wirtschaftskrise wurde überwunden.

1914
Fire destroyed plants

In 1914 a big fire destroyed the complete factory buildings, but also the First World War with its following economic crisis was overcome.

1945
Der 2. Weltkrieg

Im zweiten Weltkrieg mußte dann die Produktion auf Wehrmachtsbedarf umgestellt werden, so daß im Jahre 1945 auf Anordnung der Besatzungsmacht zunächst die Firmengebäude geräumt wurden.

1945
The Second World War

During the Second World War the production was compelled to be changed for German Armed Forces needs. This implicated the clearing of the factory buildings by order of the occupying power in 1945.

1972
Die 4. Generation

Übergabe der Firmenleitung an die Brüder Hermann Josef und Johannes Brumberg im Jahre 1972.

1972
The fourth generation

The company was passed to the brothers Hermann Josef and Johannes Brumberg in 1972.

2003
Verstärkung

Dipl.-Kfm. Johannes Brumberg jun. unterstützt das Unternehmen seiner Eltern nach seinem erfolgreich absolvierten Studium der Betriebswirtschaft in Münster und Hannover.

2003
Support
Johannes Brumberg jr., bachelor of commerce, supported his parent's enterprise after his successfully finished studies of business administration in Münster and Hannover.

2010
Kooperation mit Hella
cooperation with Hella

2009
Verstärkung

Dipl.-Kfm. Benedikt Brumberg unterstützt das Familienunternehmen und übernimmt die Leitung des Einkaufs.

2009
Support

Bachelor of commerce Benedikt Brumberg supported his parent's enterprise and is responsible for the purchase department.

2009
myBRUMBERG

Das erste Online Portal für Lichtprofis geht online.

2009
myBRUMBERG

The first web portal gave access to light professionals.

Innovation & Design

Wir sind ein Familienunternehmen mit einem eigenen persönlichen Charakter.

Die gesamte Wertschöpfungskette sowie daran angegliederte Prozesse werden intern umgesetzt. Die Vielschichtigkeit des Unternehmens basiert auf einem leistungsfähigen und motivierten Team.

Der zukunftsorientierte Ausbau der Personalressourcen und die Spezialisierung der Mitarbeiter gewährleisten eine hohe Personalkompetenz, modernste Technik und höchste Qualität.

Brumberg Leuchten is a family business with a very particular individual character.

The whole value added chain as well as the incorporated processes are implemented internally.

The company's complexity is based on a powerful and motivated team. The current increase in human resources and the specialisation of the staff ensure latest technologies and top quality.

MODUL
ELECTRO
www.modulelectro.ru

Das Konzept / the concept



Design ist der gerade Weg von der Idee zum erfolgreichen Serienprodukt. Mit viel Fingerspitzengefühl für das fokussierte Marktsegment arbeiten wir an Produkten – von der reduzierten Form bis zum extravaganten Designobjekt. Design ist entscheidend für Innovation, Differenzierung im Wettbewerb und Wertschöpfung.

Design is the straight way from the originated idea to the successful repetition part. With sure instinct for the focussed market segment, we work on products which range from reduced forms to extraordinary design objects. Design is essential for innovation, to be able to stand out from the competition and value added.

Um außergewöhnliche und einzigartige Ideen zu schaffen, gehen wir neue Wege. Die Bereiche Forschung und Technik sind dabei von besonderer Bedeutung. Neueste Technologie in Verbindung mit hochwertigen Materialien bilden die Basis des Erfolgs.

We break new grounds to create exceptional and unique ideas. The fields of research and technology are of particular importance. Latest technologies in connection with high-class materials found the base of success.

Unsere Produkte stehen für höchste Qualität. Eine stetige Kontrolle und Verbesserung unserer Arbeitsprozesse bilden die Basis dafür.

Our products stand out for highest quality. A current control and improvement of our operating processes provides the base.

Technik / technology

Unsere langjährige Erfahrung in der Lichtwelt macht es uns möglich, unseren Kunden optimalen technischen Support, lichttechnische Planung und Produktentwicklung zu bieten. Unsere Ingenieure prüfen, entwickeln und berechnen individuelle und kreative Lichtkonzepte nach dem aktuellsten Stand der Technik. So entstehen hochtechnische Lösungen.

Our long lasting experience with the world of light enables us to offer ideal technical support as well as planning and product development in light engineering to our clients. On the base of the latest technology, our engineers control, develop and calculate individual and creative light concepts. This results high-end solutions.



MODUL
ELECTRO
www.modulelectro.ru



Lichtdesign & Lichtplanung lighting design & light planning

Licht ist ein starkes Gestaltungsmedium, das plan- und beherrschbar ist. Professionelle Lichtplanung ist eine Kombination aus Lichtberechnung und praktischer Erfahrung der Planer.

Der Mensch verbringt heutzutage nahezu 90% seiner Lebenszeit in geschlossenen Räumen. Daher versuchen wir künstliches Licht zu schaffen, das dem Tageslicht sehr nahe kommt.

Für uns hat Lichtplanung das Wohlbefinden der Menschen zum Ziel. Licht erzeugt Stimmungen, weckt Emotionen und schafft Atmosphäre. Ein schlüssiges Lichtkonzept kann beispielsweise Gebäude aufwerten und gekonnt architektonische Highlights hervorheben. Eine gut geplante Beleuchtung hilft aber auch bei der Orientierung und kann den Energieverbrauch reduzieren.

Wir als Premium-Partner bei DIAL nutzen zur Lichtberechnung die Software DIALux. Es können somit realistische Darstellungen unserer Planung erstellt werden. Eine 3D-Darstellung ermöglicht es, erste Eindrücke visuell erlebbar zu machen.

Light is a strong medium for creation, which is predictable and controllable. Professional light planning is a combination of light calculation and practical experience of the planner.

Nowadays, a human spends its lifetime almost 90% within indoor areas. For this reason, we attempt to create artificial light which is very close to natural daylight.

Our main target within the light planning is the human's well-being. Light raises emotions and brings ambience. A conclusive light concept is suitable for a building upgrade and to emphasize architectural highlights on their best. Well-planned lighting helps for orientation and is able to reduce the energy consumption.

As a premium partner of DIAL, we use the DIALUX software for light planning. This enables us to make realistic presentations of our plannings. A presentation in three-dimensional form allows to give first impressions in a visual way.

Brumberg ist DIAL Premium-Partner
Seit Dezember 2007 sind wir Premium-Mitglied und bieten einen eigenen DIALux-Katalog an.

DIALux ist das Programm zur Berechnung und Visualisierung von Innen- und Außenbeleuchtungsanlagen. Es ermöglicht eine praxisnahe Beleuchtungsplanung – flexibel und herstellerübergreifend durch direkten Zugriff auf aktuelle Datenbanken der Leuchtenhersteller.

Durch den Entschluss, DIAL Premium-Partner zu werden, können wir Planern und Architekten einen umfassenden Service bieten.

Auf unserer Homepage www.brumberg.com können Sie die DIALux-Software kostenlos downloaden; das aktuelle PlugIn finden Sie dort ebenfalls.

BRUMBERG is DIAL premium member
Since the 21st December 2007 Brumberg has been DIAL premium member and offers now its own DIALux catalogue.

Dialux is a lighting planning program for calculation and visualisation for indoor and outdoor lighting installations. This program offers a practical and flexible lighting planning which is manufacturer spanning through direct access to all current lighting databases of all lighting manufacturers.

By taking the decision to become a DIAL premium member, we are now able to offer a comprehensive service to our planners and architects.

You can free download the software and the current PlugIn on www.brumberg.com

DIALux
Premiumpartner



Fertigung / production

Eine hochmoderne und flexibel aufgestellte Metallverarbeitung ermöglicht es uns, auch kurzfristig auf Kundenwünsche zu reagieren. Von der 3D-Konstruktion bis zum fertigen Produkt setzen wir hier unsere Ideen in die Realität um.

Customized demands can also be realized immediately, because of a metal working which is drawn to a production on the base of best flexibility and latest technology.

From a three-dimensional construction up to the finished product we put our ideas into effect.

Die Fertigung ist ausgestattet mit:
The production contains:

- Laseranlagen / laser systems
- CNC-Abkantbänke / CNC machines
- Schweißrobotern / Welding robots
- Punktschweißmaschinen / Electron beam welding machines
- CNC-Drückmaschinen / CNC spinning machines
- Stanz- und Tiefziehpressen / Drawing and stamping presses
- und einem angegliederten Montagebereich / and an affiliated assembling area.



Unser Partnerunternehmen: Firma Keinhorst, Sundern (Hellefeld)

Montage / assembly

Die Aufgabenbereiche innerhalb der Montage sind klar gegliedert. Ob die Endmontage der Halbleiter, die separate LED-Montage, die Konfektionierung und Fertigung von fasertechnischen Anlagen oder gar die Qualitätskontrolle – sämtliche Arbeitsschritte sind optimal aufeinander abgestimmt.

Ausgebildete Elektroniker bauen und verdrahten in der separaten LED-Montage hochtechnische Projektlösungen.

The scope of duties is clearly structured within the assembly department. Whether the final completion of the semi-finished product parts, the separate LED assembling, the customizing and manufacturing of fibre optic sets or the quality control – all production steps are optimally arranged.

Skilled electronic technicians wire and complete project solutions on a high level of technology.

MODUL
ELECTRO
www.modulelectro.ru

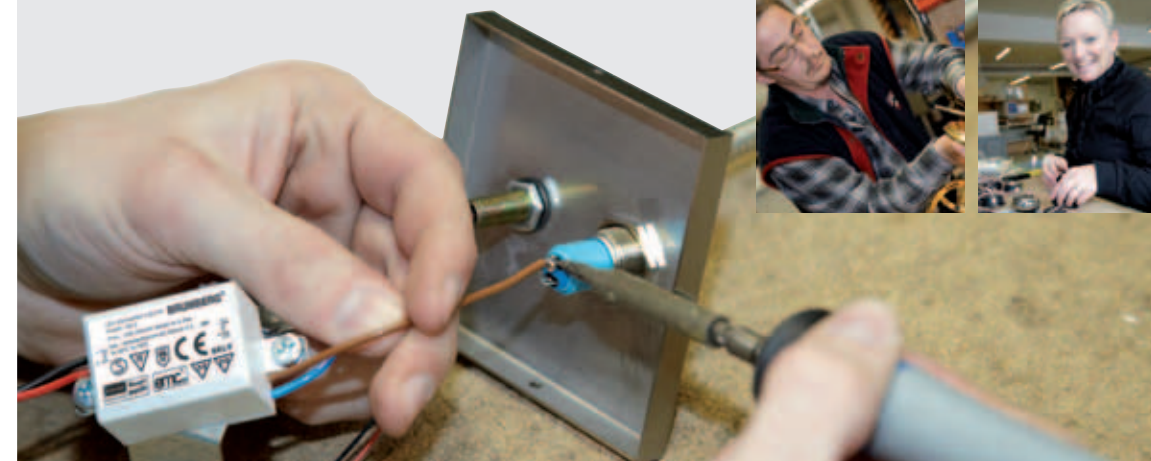
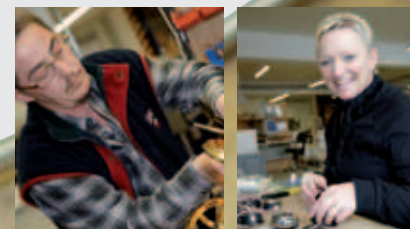
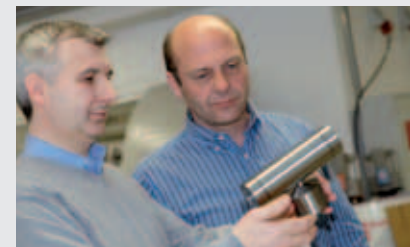

Vertrieb & Export / sales & export

Wir sind weltweit in über 40 Ländern tätig.

Um den technischen Anforderungen und Fragen unserer Kunden gerecht zu werden, setzen wir im Vertrieb zunehmend auf Mitarbeiter mit elektronischem Wissen bzw. mit akademischem Hintergrund.

Unser Innendienst wird vor Ort durch ein flächendeckendes Netz von reisenden Angestellten unterstützt. Diese bieten unseren Kunden eine exzellente Beratung und stehen bei Problemfällen mit Rat und Tat zu Seite.

Internationale Kontakte werden durch die Exportabteilung betreut. Neben der länderspezifischen administrativen Bearbeitung und überdurchschnittlichen Serviceleistungen in verschiedenen Sprachen, gehört die Erstellung sämtlicher, exportrelevanter Dokumente zum Aufgabenbereich. Durch hohen Anspruch an eine gute Zusammenarbeit mit unseren Partnern, konsequenten Ausbau der BRUMBERG-Messepräsenz in den Hauptabnehmer-Ländern und Kundens Schulungen vor Ort und im Hause Brumberg runden wir unsere Kundenpflege ab.

Zur optimalen Unterstützung unserer Vertriebspartner und Kunden haben wir in eine ETIM gestützte Datenbank investiert, somit können wir auf Anfrage Produktdaten als BMEcat zur Verfügung stellen.

Zudem haben unsere Kunden, insbesondere der Fach- und Großhandel die Möglichkeit Geschäftsdaten via EDI auszutauschen.

We operate in more than 40 countries world-wide.

To be in the position to meet with our client's requirements and questions on the technical fields, we turn our attention to employees which have electronic knowledge, respectively with academic background.

Our customer service on the Brumberg premises is supported by a comprehensive network of an employed field staff. They offer an excellent consulting to our clients and help with words and deeds if problems occur.

International contacts are served by the export department. Besides the country-specific and administrative work as well as superior services in different languages, the preparation of export-relevant documents is within the scope of duties. Caused by a high claim to a best possible cooperation with our partners, current increase of a fair participation of BRUMBERG in the countries of principal customers and customer trainings on location and on the Brumberg premises, perfect our customer care.

For an optimal support of our sales partners and clients we invested into the ETIM database. This offers the possibility to provide product data as BMEcat if required.

Our customers, especially the specialized traders and wholesalers, are additionally in the position to exchange their business data via EDI.

MODUL
ELECTRO
www.modulelectro.ru



Jürgen Knappstein
Leitung Vertrieb



Thorsten Oliver Stamm
Leitung Export



Judith Rüter
Vertrieb



Francesco Capristo
Export

Marketing & Design

Unser Team aus Spezialisten aus verschiedenen Bereichen des Designs und der Kommunikation hat ein und denselben Anspruch: optimale Qualität!

Das Know-How reicht vom Entwurf und Layouten von Printobjekten, Aufbereitung der Daten für die digitale Druckvorstufe, der Fotografie, bis zur Planung und dem 3D-Entwurf der Messestände.

Alle unternehmens-relevante Medien werden von unserem eigenen Team erstellt. Zudem erarbeiten wir für unsere Kunden individuelle Unterlagen und unterstützen unsere Partner bei ihren Marketing-Aufgaben.

Auch die Bereiche Online-Marketing und Werbetechnik werden intern abgedeckt. Dadurch können alle Kommunikationsaufgaben kreativ und effizient gelöst werden.

Das Design der Produktpalette erarbeiten wir größtenteils mit eigenem Team. Zudem steht uns ein professionelles Netzwerk von externen Designbüros zur Verfügung. Zahlreiche Auszeichnungen belegen die exzellente Symbiose.

One team of specialists from different fields of design and communication aim for the one and only requirement: excellent quality!

The know-how reaches from drafts and layouts of print objects, data processing for the digital pre-press and photography up to the planning of an exhibition stand in three-dimensional form.

All business-related media are realized by our own team. We additionally prepare individual documents for our clients and support our partners in their marketing businesses.

Both fields: online marketing and advertising engineering are internally covered. Due to this fact, all communication jobs can be solved creatively and efficiently.

The design of the product range is mostly acquired by our own team. In addition, a professional network of external design companies is at our disposal. Countless awards prove the excellent symbiosis.



MODUL
ELECTRO
www.modulelectro.ru



Marketing & Design

Seit 2010 sind wir mit der Online-Plattform „myBRUMBERG“ online - ein bisher einzigartiges Projekt in der Lichtbranche.

Wir bieten Installateuren, Architekten, Planern sowie dem Groß- und Fachhandel die Möglichkeit, sich auf der Plattform www.mybrumberg.com zu registrieren.

Als Brumberg-Partner profitieren diese anschließend von vielen attraktiven Vorteilen. myBRUMBERG bietet vielerlei hilfreiche Tools, aktuelle News und kompetente Unterstützung im Bereich der Lichtkonzeption.

One team of specialists from different fields of design and communication aim for the one and only requirement: excellent quality!

The know-how reaches from drafts and layouts of print objects, data processing for the digital pre-press and photography up to the planning of an exhibition stand in three-dimensional form.

All business-related media are realized by our own team. We additionally prepare individual documentations for our clients and support our partners in their marketing businesses.

Both fields: online marketing and advertising engineering are internally covered. Due to this fact, all your communication jobs can be solved creatively and efficiently.

The design of the product range is mostly acquired by our own team. In addition, a professional network of external design companies is at our disposal. Countless awards prove the excellent symbiosis.



myBRUMBERG®
Das Portal für Lichtprofis.

Vorteile

Systempartner:

- ✓ Kostenloses Starterpaket
- ✓ Mitgliedsurkunde
- ✓ Eintrag im Brumberg-Händlernachweis
- ✓ exklusiver Informationsvorsprung
- ✓ Ihr persönlicher Werbeartikel-Shop
- ✓ Weihnachtsüberraschung
- ✓ automatische Gewinnspielteilnahme

Systempartner Plus:

- ✓ kostenlose Inhouse-Schulung
- ✓ Internetadresse im Händlernachweis
- ✓ Erweitertes Firmenprofil
- ✓ kostenloser Eintritt zu Messen
- ✓ Clubjahreskonferenz inkl. Übernachtung
- ✓ 1x kostenloser Workshop
- ✓ 5% Rabatt auf alle Werbeartikel

Competence Partner:

Sie wollen Licht mit uns gemeinsam erfahrbar machen – und zugleich mit einer einzigartigen, professionellen Warenpräsentation in einem CompetenceCenter die eigenen Umsätze steigern!?

Brumberg Leuchten bietet Ihnen als myBrumberg CompetencePartner exklusive Unterstützung bei der Ausstattung eines CompetenceCenters.

Sprechen Sie uns an!



MODUL
ELECTRO
www.modulelectro.ru

Marketing & Design

Im Online Bereich bieten wir unseren Kunden viele interessante und hilfreiche Tools. Auf www.brumberg.com können die aktuellsten Kataloge einfach und bequem als PDF heruntergeladen werden.

Unsere Homepage bietet eine optimierte Suchfunktion, die auf einer ETIM gestützten Datenbank basiert, die es Lichtinteressierten ermöglicht, nach Produkten aber auch nach Synonymen wie beispielsweise Farbe oder Material zu suchen.

Über das neue Online-Bestellsystem können Waren direkt bestellt werden. Dem 3-stufigen Vertriebsweg bleiben wir hierbei selbstverständlich treu.

Zum Thema „Energiesparen“ bieten wir unseren Wirtschaftlichkeitsberechner. So läßt sich beispielsweise das Energiesparpotenzial der herkömmlichen Halogenleuchte zu dem neuen MR16 LED Einsatz in den verschiedenen Wattagen errechnen. Es kann individuell angegeben werden, welche Halogenleuchte im Einsatz ist und wie lange diese genutzt wird. Auf Basis der eingegebenen Daten wird dann das Einsparpotenzial ausgegeben.

Within the web portal we offer a lot of very interesting and helpful tools to our clients. On www.brumberg.com it is possible to make a download of the latest catalogues as PDF file, e.g.

In addition our homepage provides an optimized search function. This is grounded on an ETIM data base, which enables people interested in light to search for products or synonyms like colour our material.

Via the new online order system, goods can be ordered directly. Of course, we keep our three-stage distribution channel.

In the matter of ‚energy saving‘, we offer our cost-effectiveness calculator. With this calculator you can for example calculate the potential of energy saving of a conventional halogen lamp in comparison to the new MR 16 LED insert within the different wattages.

You can individually put the data in, which halogen lamp is in use and how long it is operating. On the basis of the entered data, possible savings are issued.



MODUL
ELECTRO
www.modulelectro.ru

www.brumberg.com

Messebau / booth construction

Wir sind national wie international jährlich auf zahlreichen Messen vertreten. Die Nähe zum Kunden ist für uns das Wichtigste!

Die außergewöhnlich hohe Messepräsenz bietet uns eine gute Möglichkeit zur Kontaktpflege. Die Produktpräsentation ist für uns die optimale Möglichkeit, ein Feedback auf unser Portfolio zu bekommen.

Der Standbau, wie auch die gesamte Messelogistik werden von der hausinternen Messeabteilung bewältigt.

Annually, we are presented on countless national and international fairs. The closeness to our clients is our main target!

The extraordinary presence on fairs serves an excellent opportunity for public relations and product presentation. In addition, this is a perfect possibility to get a feedback about our portfolio.

The construction of our exhibition booth as well as the fair logistics are handled in-house.

A precise implementation of the showroom and on the premises and of the presentation systems are also fields of duty of our department for booth construction.

MODUL
ELECTRO
www.modulelectro.ru

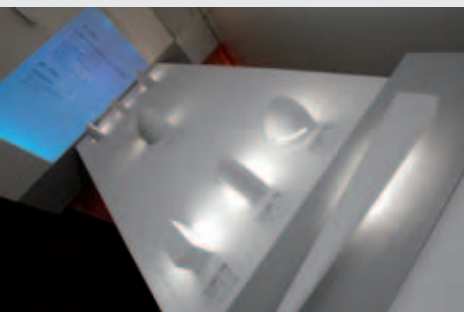

Lager und Versand / storage and shipment

Durch unsere computergesteuerten Paternostersysteme in bis zu 8 Metern Höhe ist es uns möglich, auf kleinster Fläche eine extrem hohe Anzahl an Artikeln zu lagern. Somit erreichen wir über äußerst kurze Wege ein sehr breites und schnell abrufbares Lieferspektrum.

Wir sind in der Lage den Großteil unseres Sortiments in wenigen Werktagen zum Kunden zu liefern.

By means of computer-controlled paternoster systems which are up to 8 m high, we are able to store in minimum space an extremely high quantity of articles. Hence, we reach for an available scope of delivery which is because of its very short distances very large and fast.

We are in the position to deliver a big part of our range to our customers within a few working days.



LED Competence Centre

Wir gehen neue Wege der Präsentation und geben unseren Kunden und Interessenten die Möglichkeit, Lichtfarben, Lichtstärken und Lichtszenarien mit den dazugehörigen Steuerungsmöglichkeiten in Anwendung zu betrachten.

Unter dem Motto „Licht in Anwendung“ zeigen wir in einzigartigen Räumlichkeiten außergewöhnliche Beleuchtungslösungen.

Auf mehr als 1200 Quadratmetern präsentieren wir Ihnen über 90 verschiedene Lichtszenarien in unterschiedliche Themenbereiche aufgliedert.

Ob im Wellnessbereich, Badezimmer, in der Hotelsuite, im Shop oder im Outdoorbereich – die LED schafft ein angenehmes Ambiente und Atmosphäre.

We strike new paths of presentation and give our clients and interested parties the possibility to gaze at the application of light colours, light intensity and light scenarios with the corresponding possibilities of control.

True to the motto “Light in application” we show extraordinary lighting solutions in unique premises.

More than 90 different lighting scenarios are presented in different subject areas on more than 1200 square meters.

Whether in the spa area, bathroom, in the hotel suite, shop or outdoor area – the LED creates a comfortable ambience and creates atmosphere.

MODUL
ELECTRO

www.modulelectro.ru



LED Competence Centre, Brumberg
Schaufenstersituation

LED Competence Training

Jährlich schulen wir rund 2.000 Kunden und Partner in hausinternen Seminaren. Vermittelt werden die Grundlagen innovativer Lichttechniken wie der LED- und Fasertechnik.

Neben der theoretischen Schulung bieten wir unseren Schulungsteilnehmern die Möglichkeit, das zuvor Gelernte durch praktische Umsetzung zu vertiefen. An den eingerichteten Werkbänken können Steuerung gebaut und Lichtsituationen simuliert werden.

About 2.000 clients and partners are annually instructed in in-house trainings. The backgrounds of innovative lighting techniques as LED and fibre technique were communicated.

Besides the theoretic trainings we offer our training members the possibility to deepen the afore learned by practice. Controls can be manufactured and lighting situations can be simulated at arranged work benches.



Schulungszentrum, Brumberg

MODUL
ELECTRO
www.modulelectro.ru

BRUMBERG

Aufbau einer Hochleistungs-LED

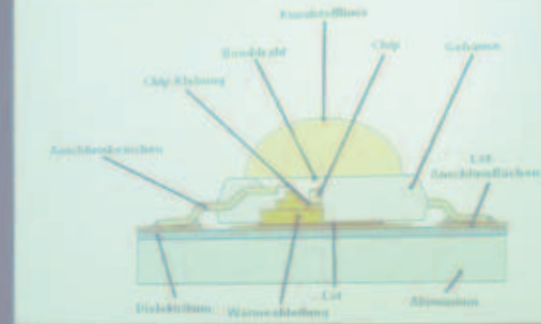

Let's go green

Mit unseren Lichtkonzepten können Sie bis zu 90% der vorhandene Energiekosten einsparen. Ihre Wartungskosten werden stark minimiert.

Zudem reduzieren Sie den CO²-Ausstoß um bis zu 86% durch den Einsatz von zukunftsweisenden Lichttechniken. Durch den Einsatz neuer Beleuchtungskonzepte leisten Sie einen aktiven Beitrag zum Umweltschutz!

With our lighting concept you can save up to 90% of the present energy costs. Your maintenance costs will be highly minimized.

Furthermore the CO² emission is reduced up to 86% by the application of forward-looking lighting techniques. By employment of new lighting concepts you make an active contribution to the environment protection!

MODUL
ELECTRO
www.modulelectro.ru



LED

Vorteile:

- ✓ geringer Energieverbrauch
- ✓ geringe Wärmeentwicklung
- ✓ extrem hohe Lebensdauer
- ✓ sehr geringe Wartungskosten
- ✓ keine UV- / IR-Strahlung
- ✓ statischer u. dynamischer Farbwechsel möglich

Advantages:

- ✓ Low energy consumption
- ✓ Low generation of heat
- ✓ Extremely high durability
- ✓ Very low maintenance costs
- ✓ No UV- / IR- radiation
- ✓ Possibility of static and dynamic change of colours





BRUMBERG®
— Licht seit Generationen —

VERTRIEBSPARTNER VON



- Optimale Ausnutzung von Ressourcen
- Maximum utilization of resources
- Know-how für gemeinsame Entwicklungen nutzen
- To benefit from mutual know-how for common developments
- Implementierung der LED-Produktlinie
- Implementation of the LED product line
- Integration von technischen Lösungen aus dem Bereich „Non Automotive Solutions by Hella“
- Integration of technical solutions from the range „Non automotive solutions by Hella“
- Optimale Möglichkeiten der Lichtlenkung und Lichtverteilung
- Ideal options of light direction and light distribution

MODUL
ELECTRONIC
www.modulelectronic.com

know-how
Know-how
synergies
Synergien
common resources
gemeinsame Ressourcen

DIE KOOPERATION DER ZUKUNFT!

Hella ist führender Hersteller im Bereich Licht und Elektronik mit anspruchsvollen Steuerungssystemen für die Automobilindustrie. In keiner anderen Branche sind die Qualitätsanforderungen so hoch wie in der Automobilindustrie. Das sind einmalige Voraussetzungen um die ausgereiften Technologien im Non-Automotivebereich einzusetzen.

Ziel der Partnerschaft ist es, vorhandene Ressourcen optimal auszunutzen und das Know-How und die spezifischen Stärken zu bündeln. Für Brumberg Leuchten ist Hella der ideale Partner für zukunftsweisende Entwicklungen.

Wir liefern diese Universal Design Spots mit innen- und außenliegendem Ambientlicht in den Lichtfarben amber, blau und weiß.

Mit einem 1-10V Dimmer können die Leuchten gedimmt werden. Wird das Licht unter 2V herunter gedimmt, so schaltet sich automatisch das Ambientlicht ein. Bei Verwendung eines Serienschalters schaltet sich das Ambientlicht automatisch aus, sobald das Hauptlicht eingeschaltet wird.

Zusätzliche technische Erläuterungen sowie weitere Ausführungen finden Sie unter www.brumberg.com

Hella is a leading producer with ambitious control systems for the automobile industry within the light and electronic fields. In no other branch the quality demands are as high as within the automobile industry. This is a unique precondition to take this well-engineered technology for the non automotive use.

The main target of this cooperation is to benefit from existing resources optimally and to concentrate the know-how and the specific strengths. For Brumberg-Leuchten, Hella is the ideal partner for forward-looking developments.

We deliver these universal design spots with an inner and outer ambient light in amber, blue and white.

The luminaires can be regulated by a 1-10 V dimmer. If the light is turned down to less than 2V, the ambient light is switched on automatically. As soon as the main light is switched on, the ambient light automatically switches off, if a series connection is used.

Additional technical descriptions as well as further information you can find on our website www.brumberg.com

BRUMBERG®
— Licht seit Generationen —



SL508WW4

SPOT MIT AUSSENLIEGENDER AMBIENTLICHT-FUNKTION, LED-FARBE WEISS
SPOT WITH OUTER AMBIENT LIGHT
LED COLOUR WHITE



SL507WW4

SPOT MIT INNENLIEGENDER AMBIENTLICHT-FUNKTION, LED-FARBE WEISS
SPOT WITH INNER AMBIENT LIGHT
LED COLOUR WHITE

VERTRIEBSPARTNER VON



UNIVERSAL DESIGN SPOT

UNIVERSAL DESIGN / SPOT

MIT INNENLIEGENDEM AMBIENTELEICHT / WITH INNER AMBIENT LIGHT

8W



10° schwenkbar / 10° pivoting



LIGHT
Leuchtmittel: LED.
Hervorragende Farbwiedergabe,
CRI >85, Lichtstrom 350 lm.
Illuminant: LED Excellent colour
rendering, CRI > 85, Luminous
flux 350 lm.



IP
Schutzart IP20
Die Leuchten sind für Feuchträu-
me nicht geeignet.
Degree of protection IP20.
The luminaires are not suitable for
humid areas.



TEMP
Lichtfarbe: warmweiß
Farbtemperatur 2900 K.
light colour: warm white
colour temperature
2900K.



HOURS
Langlebig im täglichen Einsatz.
Ständiges Ein-/Aussschalten, zum
Beispiel durch einen Bewegungs-
melder, hat keine Auswirkung auf
die Lebensdauer.
Longevity during daily use. Constant
on / off switching, e.g. by motion
detector, has no impact on the
durability.



POWER
Geringer Stromverbrauch: 8W
Konstantstrom 700 mA.
Low power consumption: 8W,
Constant power 700 mA.

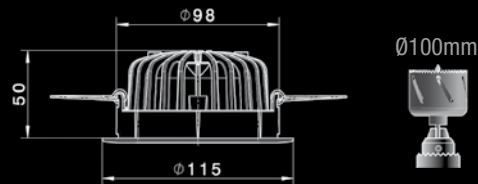
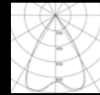

NEU
new

Art.-Nr. art.-no.	Gehäusefarbe housing colour	Abstrahlung radiation	Leistung power	Ambiente-Einfassung ambiente bordering	Ambiente-Farbtön ambient colouring	Preis € price €
SL501WW4	weiß / white	40°	8W	innen / inside	Amber / amber	179,00
SL505WW4	weiß / white	40°	8W	innen / inside	Blau / blue	179,00
SL507WW4	weiß / white	40°	8W	innen / inside	Weiß / white	179,00

Art.-Nr. art.-no.	Gehäusefarbe housing colour	Leistung power	Dimmung dimmable	Beschreibung description	Preis € price €
SL3517	grau / grey	16W	1-10V	LED Stromquelle (Konverter) für max. 2 Spots, 700mA LED current source (converter) for max. 2 spots, 700mA	98,00
SL3518	grau / grey	50W	1-10V	LED Stromquelle (Konverter) für max. 4 Spots, 700mA LED current source (converter) for max. 4 spots, 700mA	138,00

Konverter sh. S.447 / for converters pls. comp. page 447

patented by hella

UNIVERSAL DESIGN SPOT

UNIVERSAL DESIGN / SPOT

MIT AUSSENLIEGENDEM AMBIENTELEICHT / WITH OUTER AMBIENT LIGHT

8W

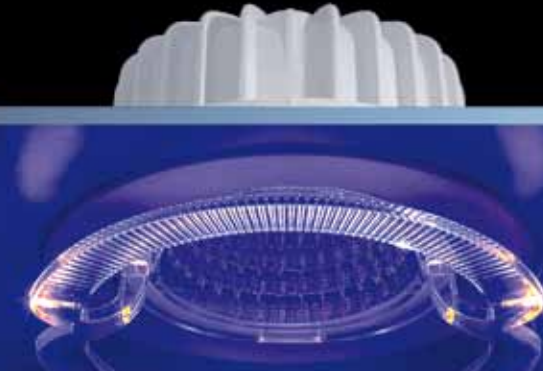

10° schwenkbar / 10° pivoting



LIGHT
Leuchtmittel: LED.
Hervorragende Farbwiedergabe,
CRI >85, Lichtstrom 350 lm.
Illuminant: LED Excellent colour
rendering, CRI > 85, Luminous
flux 350 lm.



IP
Schutzart IP20.
Die Leuchten sind für Feuchträu-
me nicht geeignet.
Degree of protection IP20.
The luminaires are not suitable for
humid areas.



TEMP
Lichtfarbe: warmweiß
Farbtemperatur 2900 K.
light colour: warm white
colour temperature
2900K.



HOURS
Langlebig im täglichen Einsatz.
Ständiges Ein-/Aussschalten, zum
Beispiel durch einen Bewegungs-
melder, hat keine Auswirkung auf
die Lebensdauer.
Longevity during daily use. Constant
on / off switching, e.g. by motion
detector, has no impact on the
durability.



POWER
Geringer Stromverbrauch: 8W
Konstantstrom 700 mA.
Low power consumption: 8W,
Constant power 700 mA.

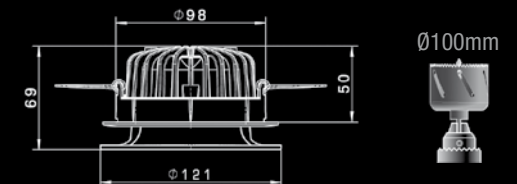

NEU
new

Art.-Nr. art.-no.	Gehäusefarbe housing colour	Abstrahlung radiation	Leistung power	Ambiente-Einfassung ambiente bordering	Ambiente-Farbtön ambient colouring	Preis € price €
SL503WW4	weiß / white	40°	8W	außen / outside	Amber / amber	189,00
SL506WW4	weiß / white	40°	8W	außen / outside	Blau / blue	189,00
SL508WW4	weiß / white	40°	8W	außen / outside	Weiß / white	189,00

Art.-Nr. art.-no.	Gehäusefarbe housing colour	Leistung power	Dimmung dimmable	Beschreibung description	Preis € price €
SL3517	grau / grey	16W	1-10V	LED Stromquelle (Konverter) für max. 2 Spots, 700mA LED current source (converter) for max. 2 spots, 700mA	98,00
SL3518	grau / grey	50W	1-10V	LED Stromquelle (Konverter) für max. 4 Spots, 700mA LED current source (converter) for max. 4 spots, 700mA	138,00

Konverter sh. S.447 / for converters pls. comp. page 447

patented by hella



10° schwenkbar / 10° pivoting



LIGHT
Leuchtmittel: LED.
Hervorragende Farbwiedergabe, CRI >85, Lichtstrom 700 lm.
Illuminant: LED Excellent colour rendering, CRI > 85, Luminous flux 700 lm.



IP
Schutzart IP20.
Die Leuchten sind für Feuchträume nicht geeignet.
Degree of protection IP20.
The luminaires are not suitable for humid areas.



TEMP
Lichtfarbe: neutralweiß
Farbtemperatur 4000 K.
light colour: neutral white
colour temperature 4000K.



HOURS
Langlebig im täglichen Einsatz. Ständiges Ein-/Ausschalten, zum Beispiel durch einen Bewegungsmelder, hat keine Auswirkung auf die Lebensdauer.
Longevity during daily use. Constant on / off switching, e.g. by motion detector, has no impact on the durability.



POWER
Geringer Stromverbrauch: 15W
Konstantstrom 700 mA.
Low power consumption: 15W,
Constant power 700 mA.

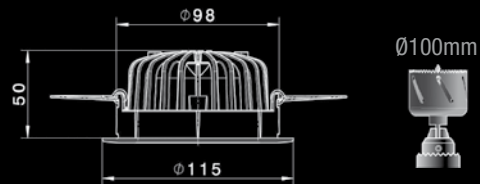

Art.-Nr. art-no.	Gehäusefarbe housing colour	Abstrahlung radiation	Leistung power	Ambiente-Einfassung ambient colouring	Preis € price €
SL600WW4	weiß / white	40°	15W	keine / without	219,00

Art.-Nr. art-no.	Gehäusefarbe housing colour	Leistung power	Dimmung dimmable	Beschreibung description	Preis € price €
SL3517	grau / grey	16W	1-10V	LED Stromquelle (Konverter) für max. 1 Spot, 700mA LED current source (converter) for max. 1 spot, 700mA	98,00
SL3518	grau / grey	50W	1-10V	LED Stromquelle (Konverter) für max. 2 Spots, 700mA LED current source (converter) for max. 2 spots, 700mA	138,00

ANSCHLUSSBEISPIELE / EXAMPLES OF CONNECTIONS

Leuchtenaufbau für max. 2 Spots (SL50...)

concept for max. 2 spots (SL50...)



Leuchtenaufbau für max. 4 Spots (SL50...)

concept for max. 4 spots (SL50...)

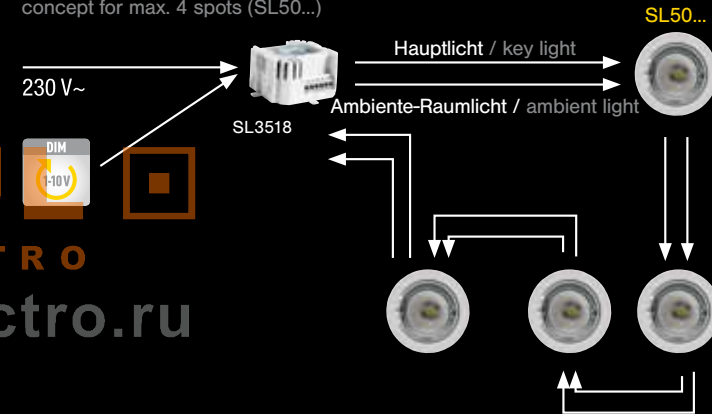

Leuchtenaufbau für max. 1 Spot (SL600NW)

concept for max. 1 spot (SL600NW)

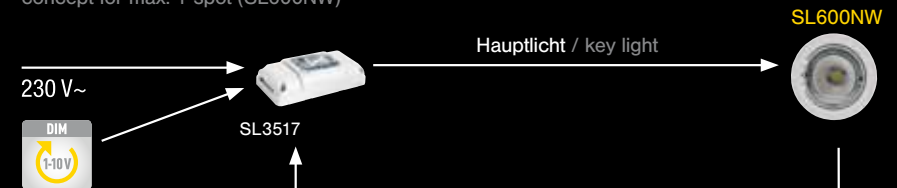

Leuchtenaufbau für max. 2 Spots (SL600NW)

concept for max. 2 spots (SL600NW)



UNIVERSAL DESIGN SPOT

UNIVERSAL DESIGN / SPOT

MÖBELEINBAUSPOT / RECESSED FURNITURE SPOT

3W



IP 54

LIGHT

LED

Leuchtmittel: LED. Hervorragende Farbwiedergabe, CRI >80, Lichtstrom 60 lm/W. Illuminant: LED Excellent colour rendering, CRI > 80, Luminous flux 60 lm/W.

IP

54

Schutzart IP54. Die Leuchten sind für Feuchträume geeignet. Degree of protection IP54. The luminaires are suitable for humid areas.

TEMP

WARM LIGHT 2900K

Lichtfarbe: warmweiß Farbtemperatur 2900 K. light colour: warm white colour temperature 2900K.

HOURS

50.000h

Langlebig im täglichen Einsatz. Ständiges Ein-/Ausschalten, zum Beispiel durch einen Bewegungsmelder, hat keine Auswirkung auf die Lebensdauer. Longevity during daily use. Constant on / off switching, e.g. by motion detector, has no impact on the durability.

POWER

3 W

Geringer Stromverbrauch: 3W Konstantstrom 700 mA. Low power consumption: 3W, Constant power 700 mA.

NEU
new

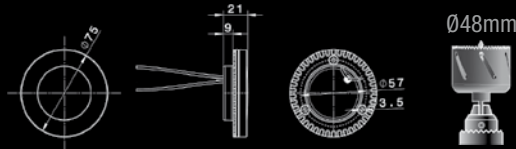

Art.-Nr. art.-no.	Gehäusefarbe housing colour	Abstrahlung radiation	Leistung power	Ambiente-Einfassung ambient bordering	Preis € price €
SL300WW	silber / silver	50°	3W	keine / without	96,00

Art.-Nr. art.-no.	Gehäusefarbe housing colour	Leistung power	Dimmung dimmable	Beschreibung description	Preis € price €
3517	weiß / white	9W	keine / without	LED Stromquelle (Konverter) für 1-3 Power-LED, 700mA LED current source (converter) for max. 1-3 Power-LED, 700mA	24,90
3518	weiß / white	18W	keine / without	LED Stromquelle (Konverter) für 1-6 Power-LED, 700mA LED current source (converter) for max. 1-6 Power-LED, 700mA	32,50
3519	weiß / white	36W	keine / without	LED Stromquelle (Konverter) für 1-12 Power-LED, 700mA LED current source (converter) for max. 1-12 Power-LED, 700mA	49,90

patented by hella

UNIVERSAL DESIGN SPOT

UNIVERSAL DESIGN / SPOT

MÖBELEINBAUSPOT / RECESSED FURNITURE SPOT

1,5W



LIGHT

LED

Leuchtmittel: LED. Hervorragende Farbwiedergabe, CRI >80, Lichtstrom 60 lm/W. Illuminant: LED Excellent colour rendering, CRI > 85, Luminous flux 60 lm/W.

IP

20

Schutzart IP20. Die Leuchten sind für Feuchträume nicht geeignet. Degree of protection IP20. The luminaires are not suitable for humid areas.

TEMP

WARM LIGHT 2900K

Lichtfarbe: warmweiß Farbtemperatur 2900 K. light colour: warm white colour temperature 2900K.

HOURS

50.000h

Langlebig im täglichen Einsatz. Ständiges Ein-/Ausschalten, zum Beispiel durch einen Bewegungsmelder, hat keine Auswirkung auf die Lebensdauer. Longevity during daily use. Constant on / off switching, e.g. by motion detector, has no impact on the durability.

POWER

1,5 W

Geringer Stromverbrauch: 1,5W Konstantstrom 350 mA. Low power consumption: 1,5W, Constant power 350 mA.

NEU
new



Art.-Nr. art.-no.	Gehäusefarbe housing colour	Abstrahlung radiation	Leistung power	Ambiente-Einfassung ambient bordering	Preis € price €
SL100WW	weiß / white	50°	1,5W	keine / without	39,00

Art.-Nr. art.-no.	Gehäusefarbe housing colour	Leistung power	Dimmung dimmable	Beschreibung description	Preis € price €
3513	weiß / white	3,6W	keine / without	LED Stromquelle (Konverter) für 1-2 Power-LED, 350mA LED current source (converter) for 1-2 Power-LED, 350mA	24,90
3505	weiß / white	11W	keine / without	LED Stromquelle (Konverter) für 1-6 Power-LED, 350mA LED current source (converter) for 1-6 Power-LED, 350mA	29,90

patented by hella

MODUL
ELECTRO
www.modulelectro.ru

UNIVERSAL DESIGN / SPOT

UNIVERSAL DESIGN / SPOT



Art. 91341 - Tischdisplay
Art.-No. 91341 - Counter display

- steckerfertig; bestehend aus:
Ready for plug-in; consisting of:
- 1x Thekenaufsteller 280x120x340mm
inkl. Digitaldruck
Counter display 280 x 120 x 340 mm
Incl. digital print
 - 1x SL503WW4
 - 1x SL3517
 - 1x 1-10V Tastdimmer
1-10V push-button dimmer

Preis auf Anfrage / price on request

UNIVERSAL PROMOTION

MODUL ELECTRO
www.modulelectro.ru

Art. 91340 - Präsentationskoffer
Art.-No. 91340 - Sample case

- steckerfertig; bestehend aus:
Ready for plug-in; consisting of:
- 1x Aluminiumkoffer 440x320x120mm
inkl. Acryleinlagen mit Digitaldruck
Aluminium case 440 x 320 x 120 mm
Incl. acrylic inlays with digital print
 - 1x SL100WW
 - 1x SL302WW
 - 1x SL501WW4
 - 1x SL503WW4
 - 2x SL3517
 - 1x 3513
 - 1x 1-10V Tastdimmer
1-10V push-button dimmer

Preis auf Anfrage / price on request



Art. 91342 - Präsentationsständer
Art.-No. 91342 - Promotional display

- steckerfertig; bestehend aus:
Ready for plug-in; consisting of:
- 1x Standdisplay 500x550x2100mm
inkl. Beschriftung
Display 500 x 550 x 2100 mm
Incl. marking
 - 1x SL600NW4
 - 1x SL100WW
 - 1x SL300WW
 - 1x SL507WW4
 - 1x SL506WW4
 - 1x SL501WW4
 - 3x SL3517
 - 1x 3517
 - 1x 3513
 - 1x 1-10V Tastdimmer
1-10V push-button dimmer

Preis auf Anfrage / price on request



Beau McClellan
for **BRUMBERG**®

MODUL
ELECTRO
www.modulelectro.ru

collection
2010

www.beauforbrumberg.com

beau McClellan
for BRUMBERG



MODUL
ELECTRO
www.modulelectro.ru

NEU
new

One Wall lamp

Ø 55mm - H 1230mm - AL 94mm / Ø 55mm - height 1230mm - projection 94mm
inkl. elektr. Transformator / incl. electr. transformer
inkl. Leuchtmittel / incl. bulb

ONE

Art.-Nr. art.-no.	Preis € price €
B4B01400	747,00

Material material	Bestückung lamp	Leistung power	Schutzart degree of protection	Schutzklasse protection class
Aluminium-Glas (teilbedampft) (aluminium-glass partially evaporated)	2x Osram Ministar	20W	IP20	I



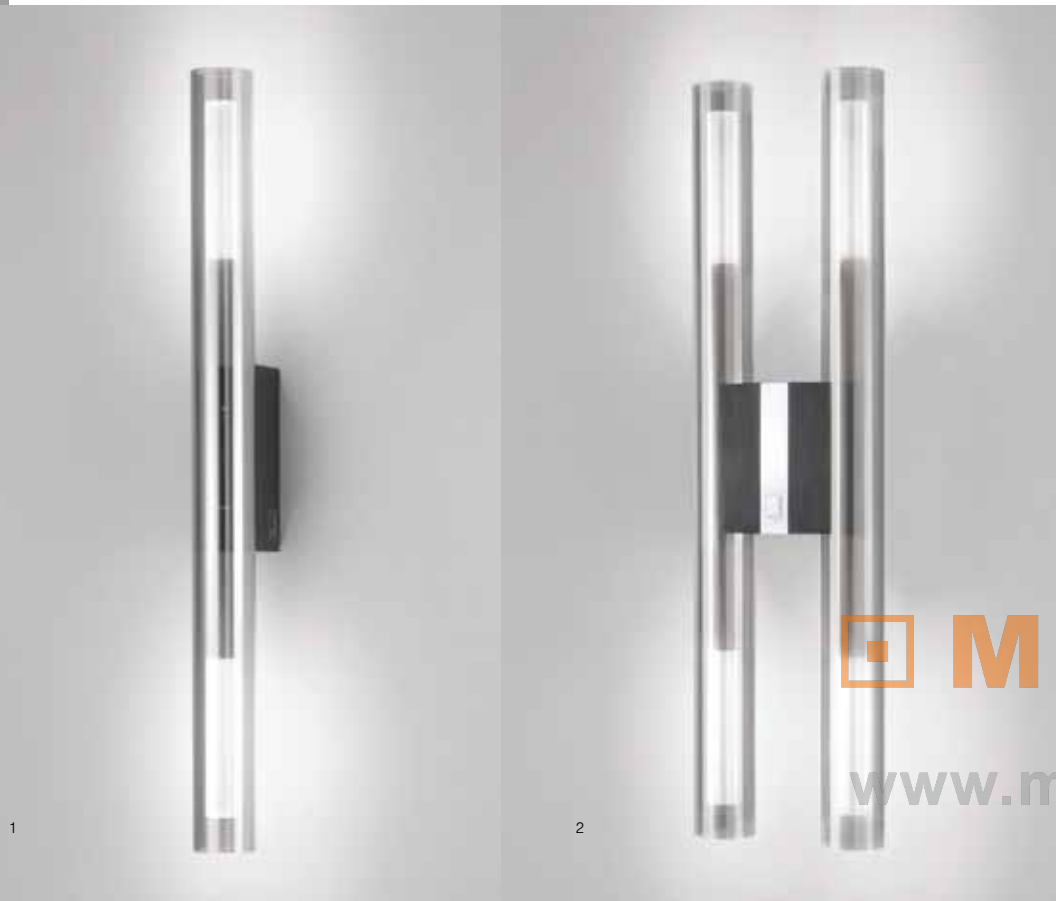

1

2

MODUL
ELECTRO
www.modulelectro.ru

1. Reveal Wall

Lichtfarbe: kaltweiß / light colour: cold white
H 500mm - AL 71mm - Glas: Ø 40mm / height 500 - projection 71mm - glass: Ø 40mm

reveal

Art.-Nr. art-no.	Preis € price €
B4B009KW	359,00

Material material	Bestückung lamp	Leistung power	Schutzart degree of protection	Schutzklasse protection class
Aluminium schwarz - Kristall + Glas (teilbedampft) (aluminium black - crystal + glass partially evaporated)	2x Power-LED	je ca. 1,0W about 1,0W each	IP20	I

2. Reveal Double

Lichtfarbe: kaltweiß / light colour: cold white
H 500mm - B 130mm - AL 71mm - Glas: Ø 40mm / height 500mm - width 130mm - projection 71mm - glass: Ø 40mm

Art.-Nr. art-no.	Preis € price €
B4B010KW	717,00

Material material	Bestückung lamp	Leistung power	Schutzart degree of protection	Schutzklasse protection class
Aluminium schwarz - Kristall + Glas (teilbedampft) (aluminium black - crystal + glass partially evaporated)	4x Power-LED	je ca. 1,0W about 1,0W each	IP20	I



beau McClellan
for BRUMBERG

Reveal Table

Ø 55mm - H 513mm / Ø 55mm - height 513mm
Glas (Lichtaustritt) über Stellschraube drehbar / glass (light exit) rotatable by setscrew
Lichtaustritt dimmbar über Touchdimmer, inkl. Leuchtmittel / light exit dimmable by touch-dimmer, incl. bulb

reveal

Art.-Nr. art-no.	Preis € price €
B4B01100	500,00

Material material	Bestückung lamp	Leistung power	Schutzart degree of protection	Schutzklasse protection class
Aluminium schwarz - Kristall + Glas (teilbedampft) (aluminium black - crystal + glass partially evaporated)	1x Osram Ministar	35W	IP20	I

beau McClellan
for BRUMBERG



MODUL
ELECTRO
www.modulelectro.ru

Reveal Chandelier

Ø 200mm - H max. 3000mm / Ø 200mm - height max. 3000mm
inkl. Transformator / incl. transformer
inkl. Leuchtmittel / incl. bulb

reveal

Art.-Nr. art.-no.	Preis € price €
B4B01200	1.798,00

Material material	Bestückung lamp	Leistung power	Schutzart degree of protection	Schutzklasse protection class
Aluminium schwarz + Glas (bedampft) aluminium black + glass (evaporated)	5x Osram Ministar	35W	IP20	I



beau McClellan
for BRUMBERG



Reflection Table lamp

H 280mm - B 250mm - T 80mm / height 280mm - width 250mm - depth 80mm
mit Touch-Dimmer, Gläser mit unterschiedlicher Lichtdurchlässigkeit (Gläser drehbar)
with touch-dimmer, glasses with different light transmission (glasses pivotable)
inkl. elektr. Transformator (Stecker-Trafo), inkl. Leuchtmittel / incl. electr. transformer (plug-trafo), incl. bulb

Art.-Nr. art.-no.	Preis € price €
B4B00700	449,00

Material material	Bestückung lamp	Leistung power	Schutzart degree of protection	Schutzklasse protection class
Aluminium schwarz - Kristall + Glas aluminium black - crystal + glass	1x Osram Ministar	35W	IP20	III

reflection

beau McClellan
for BRUMBERG



Reflection Wall lamp

H 250mm - B 250mm (Wandschild 80 x 80mm) / height 250mm - width 250mm (wall plate 80 x 80mm)
inkl. elektr. Transformator / incl. electr. transformer
zur Installation in Hohlwandmontagedosen (nicht im Lieferumfang enthalten)
for installation into mounting sleeve for cavity wall (not included in delivery)

Art.-Nr. art.-no.	Preis € price €
B4B00800	317,00

Material material	Bestückung lamp	Leistung power	Schutzart degree of protection	Schutzklasse protection class
Aluminium schwarz - Kristall + Glas aluminium black - crystal + glass	1x Osram Ministar	35W	IP20	I

reflection

MODUL
ELECTRO
www.modulelectro.ru

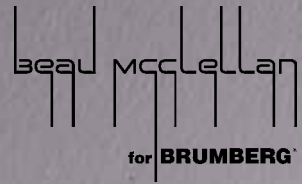

Wechsel-LED-Chip für „Glow - small“
removeable LED chip for „Glow - small“

Art.-Nr. art-no.	Lichtfarbe light colour	Preis € price €
B4B900KW	kaltweiß / cold white	30,00
B4B900BL	blau / blue	30,00
B4B900RO	rot / red	30,00



Glow small

Lichtfarbe: warmweiß, H max. 145mm (inkl. Glas), Wandschild: B 40mm - H 80mm - AL 90mm
light colour: warm white, height max. 145mm (incl. glass), wall plate: width 40mm - height 80mm - projection 90mm
inkl. Konverter, für 230V-Direktanschluss / incl. converter, for 230V-direct connexion
LED-Kopf dreh-/ schwenkbar, wechselbarer LED-Chip (werkzeuglos) / LED-head pivotable and rotatable, changeable LED-chip (without tools)

Art.-Nr. art-no.	Preis € price €
B4B003WW	213,00

Material material	Bestückung lamp	Leistung power	Schutzart degree of protection	Schutzklasse protection class
Aluminium schwarz - Kristall aluminium black - crystal	1x Power-LED	ca. 1,0W about 1,0W	IP20	I

GLOW

MODUL
ELECTRO
www.modulelectro.ru

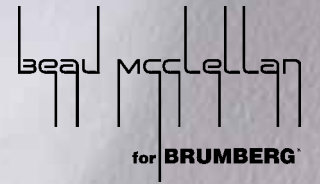

Wechsel-LED-Chip für „Glow - big“
removeable LED chip for „Glow - big“

Art.-Nr. art-no.	Lichtfarbe light colour	Preis € price €
B4B901KW	kaltweiß / cold white	46,00
B4B901BL	blau / blue	46,00
B4B901RO	rot / red	46,00



Glow big

Lichtfarbe: warm weiß, H max. 210mm (inkl. Glas), Wandschild: B 80mm - H 120mm - AL 115mm
light colour: warm white, height max. 210mm (incl. glass), wall plate: width 80mm - height 120mm - projection 115mm
inkl. Konverter, für 230V-Direktanschluss / incl. converter, for 230V-direct connexion
LED-Kopf dreh-/ schwenkbar, wechselbarer LED-Chip (werkzeuglos) / LED-head pivotable and rotatable, changeable LED-chip (without tools)

Art.-Nr. art-no.	Preis € price €
B4B004WW	319,00

Material material	Bestückung lamp	Leistung power	Schutzart degree of protection	Schutzklasse protection class
Aluminium schwarz - Kristall aluminium black - crystal	2x Power-LED	ca. 1,0W about 1,0W	IP20	I

GLOW

beau McClellan
for BRUMBERG



Wechsel-LED-Chip für „Glow - oval“
removeable LED chip for „Glow - small“

Art.-Nr. art.-no.	Lichtfarbe light colour	Preis € price €
B4B900KW	kaltweiß / cold white	30,00
B4B900BL	blau / blue	30,00
B4B900RO	rot / red	30,00

Glow oval

Lichtfarbe: warmweiß, H 250mm - B 125mm - AL 125mm, Wandschild B 80mm - H 100mm
light colour: warm white, height 250mm - width 125mm - projection 125mm, wall plate: width 80mm - height 80mm
inkl. Konverter, für 230V-Direktanschluss / incl. converter, for 230V-direct connexion
LED-Kopf schwenkbar, wechselbarer LED-Chip (werkzeuglos) / LED-head rotatable, changeable LED-chip (without tools)

Art.-Nr. art.-no.	Preis € price €
B4B005WW	449,00

Material material	Bestückung lamp	Leistung power	Schutzart degree of protection	Schutzklasse protection class
Aluminium schwarz - Kristall aluminium black - crystal	2x Power-LED	ca. 1,0W about 1,0W	IP20	I

MODUL
ELECTRO
www.modulelectro.ru

beau McClellan
for BRUMBERG



Wechsel-LED-Chip für „Glow - double“
removeable LED chip for „Glow - double“

Art.-Nr. art.-no.	Lichtfarbe light colour	Preis € price €
B4B901KW	kaltweiß / cold white	46,00
B4B901BL	blau / blue	46,00
B4B901RO	rot / red	46,00

Glow double

Lichtfarbe: warm weiß, H 250mm, Wandschild: B 80mm - H 100mm
light colour: warm white, height 250mm, wall plate: width 80mm - height 100mm
inkl. Konverter, für 230V-Direktanschluss / incl. converter, for 230V-direct connexion
LED-Kopf dreh-/ schwenkbar, wechselbarer LED-Chip (werkzeuglos) / LED-head pivotable and rotatable, changeable LED-chip (without tools)

Art.-Nr. art.-no.	Preis € price €
B4B006WW	533,00

Material material	Bestückung lamp	Leistung power	Schutzart degree of protection	Schutzklasse protection class
Aluminium schwarz - Kristall aluminium black - crystal	4x Power-LED	ca. 1,0W about 1,0W	IP20	I

GLOW

beau McClellan
for BRUMBERG



MODUL
ELECTRO
www.modulelectro.ru

Ray

Lichtfarbe: kaltweiß / light colour: cold white
H 500mm - B 100mm - AL 105mm / height 500mm - width 100mm - projection 105mm
inkl. Konverter, für 230V-Direktanschluss / incl. converter, for 230V-direct connexion

RAY

Art.-Nr. art.-no.	Preis € price €
B4B001KW	355,00

Material material	Bestückung lamp	Leistung power	Schutzart degree of protection	Schutzklasse protection class
Aluminium schwarz - Kristall aluminium black - crystal	3x Power-LED	je ca. 1,0W about 1,0W each	IP20	I



BOMAC2.2

B@mac



Wandleuchte / wall lamp

Maße: 80x80mm - AL 104mm / dimensions: 80x80mm - projection 104mm
 Lichtfarbe: kaltweiß / light colour: cold white
 Farbe: aluminium / schwarz / colour: aluminium / black
 inkl. Linsen mit Strahlungswinkel 10° + 35°, Leuchtenkopf beweglich
 incl. lenses with radiation angle 10° + 35°, head of light is moveable
 inkl. Konverter / incl. converter
 Für 230V-Direktanschluss / for 230V-direct connexion

Art.-Nr. art.-no.	Preis € price €
BOMAC2.2	195,00

Material material	Bestückung lamp	Leistung power	Schutzart degree of protection	Schutzklasse protection class
Aluminium / aluminium	1x Power-LED	ca. 1,0W about 1,0W	IP20	I



MODUL
ELECTRO

www.modulelectro.ru

BOMAC2.4

B@mac



Wandleuchte / wall lamp

Maße: 80x80mm - AL 104mm / dimensions: 80x80mm - projection 104mm
 Lichtfarbe: kaltweiß / light colour: cold white
 Farbe: schwarz / colour: black
 inkl. Linsen mit Strahlungswinkel 10° + 35°, Leuchtenkopf beweglich
 incl. lenses with radiation angle 10° + 35°, head of light is moveable
 inkl. Konverter / incl. converter
 Für 230V-Direktanschluss / for 230V-direct connexion

Art.-Nr. art.-no.	Preis € price €
BOMAC2.4	195,00

Material material	Bestückung lamp	Leistung power	Schutzart degree of protection	Schutzklasse protection class
Aluminium / aluminium	1x Power-LED	ca. 1,0W about 1,0W	IP20	I



Lieferung in exklusiver Verpackung
 delivery in exclusive package

Foto: Paschen Bibliotheken

BOMAC3.2

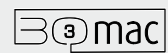

Wandleuchte / wall lamp

Maße: 80x80mm - AL 88mm / dimensions: 80x80mm - projection 88mm
 Lichtfarbe: kaltweiß / light colour: cold white
 Farbe: aluminium / schwarz / colour: aluminium / black
 Leuchtenkopf drehbar
 head of light is rotatable
 inkl. Konverter / incl. converter
 Für 230V-Direktanschluss / for 230V-direct connexion

Art-Nr. art-no.	Preis € price €
BOMAC3.2	230,00

Material material	Bestückung lamp	Leistung power	Schutzart degree of protection	Schutzklasse protection class
Aluminium / aluminium	2x Power-LED	je ca. 1,0W about 1,0W each	IP20	I



www.modulelectro.ru

BOMAC3.4

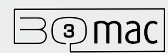

Wandleuchte / wall lamp

Maße: 80x80mm - AL 88mm / dimensions: 80x80mm - projection 88mm
 Lichtfarbe: kaltweiß / light colour: cold white
 Farbe: schwarz / colour: black
 Leuchtenkopf drehbar
 head of light is rotatable
 inkl. Konverter / incl. converter
 Für 230V-Direktanschluss / for 230V-direct connexion

Art-Nr. art-no.	Preis € price €
BOMAC3.4	230,00

Material material	Bestückung lamp	Leistung power	Schutzart degree of protection	Schutzklasse protection class
Aluminium / aluminium	2x Power-LED	je ca. 1,0W about 1,0W each	IP20	I



Lieferung in exklusiver Verpackung
 delivery in exclusive package



Foto: Paschen Bibliotheken

BOMAC4.2

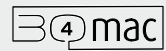

Wandleuchte / wall lamp

Maße: 80x80mm - AL 104mm / dimensions: 80x80mm - projection 104mm
 Lichtfarbe: kaltweiß / light colour: cold white
 Farbe: aluminium / schwarz / colour: aluminium / black
 inkl. Linsen mit Strahlungswinkel 10° + 35°, Leuchtenkopf beweglich
 incl. lenses with radiation angle 10° + 35°, head of light is moveable
 inkl. Konverter / incl. converter
 Für 230V-Direktanschluss / for 230V-direct connexion

Art.-Nr. art.-no.	Preis € price €
BOMAC4.2	230,00

Material material	Bestückung lamp	Leistung power	Schutzart degree of protection	Schutzklasse protection class
Aluminium / aluminium	2x Power-LED	je ca. 1,0W about 1,0W each	IP20	I



www.modulelectro.ru

BOMAC4.4

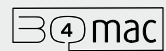

Wandleuchte / wall lamp

Maße: 80x80mm - AL 104mm / dimensions: 80x80mm - projection 104mm
 Lichtfarbe: kaltweiß / light colour: cold white
 Farbe: schwarz / colour: black
 inkl. Linsen mit Strahlungswinkel 10° + 35°, Leuchtenkopf beweglich
 incl. lenses with radiation angle 10° + 35°, head of light is moveable
 inkl. Konverter / incl. converter
 Für 230V-Direktanschluss / for 230V-direct connexion

Art.-Nr. art.-no.	Preis € price €
BOMAC4.4	230,00

Material material	Bestückung lamp	Leistung power	Schutzart degree of protection	Schutzklasse protection class
Aluminium / aluminium	2x Power-LED	je ca. 1,0W about 1,0W each	IP20	I



Lieferung in exklusiver Verpackung
 delivery in exclusive package

Foto: Paschen Bibliotheken

ICICLE1.2

ic|cle

Wandleuchte / wall lamp

Maße: 385 x 28mm - AL 55mm / dimensions: 385 x 28cm - projection 55mm
 Lichtfarbe: kaltweiß / light colour: cold white
 Farbe: schwarz / colour: black
 inkl. Konverter / incl. converter
 Für 230V-Direktanschluss / for 230V-direct connexion



Art.-Nr. art-no.	Preis € price €
ICICLE1.2	276,00

Material material	Bestückung lamp	Leistung power	Schutzart degree of protection	Schutzklasse protection class
Aluminium-Kristall aluminium-crystal	1x Power-LED	ca. 1,0W about 1,0W	IP20	I



ICICLE2.2

ic|cle

Wandleuchte / wall lamp

Maße: 685 x 28mm - AL 55mm / dimensions: 685 x 28mm - projection 55mm
 Lichtfarbe: kaltweiß / light colour: cold white
 Farbe: schwarz / colour: black
 inkl. Konverter / incl. converter
 Für 230V-Direktanschluss / for 230V-direct connexion



Art.-Nr. art-no.	Preis € price €
ICICLE2.2	342,00

Material material	Bestückung lamp	Leistung power	Schutzart degree of protection	Schutzklasse protection class
Aluminium-Kristall aluminium-crystal	2x Power-LED	je ca. 1,0W about 1,0W each	IP20	I



www.modulelectro.ru

ICICLE2.1

ic|cle

Wandleuchte / wall lamp

Maße: 685 x 28mm - AL 55mm / dimensions: 685 x 28mm - projection 55mm
 Lichtfarbe: kaltweiß / light colour: cold white
 Farbe: aluminium / colour: aluminium
 inkl. Konverter / incl. converter
 Für 230V-Direktanschluss / for 230V-direct connexion



Art.-Nr. art-no.	Preis € price €
ICICLE2.1	342,00

Material material	Bestückung lamp	Leistung power	Schutzart degree of protection	Schutzklasse protection class
Aluminium-Kristall aluminium-crystal	2x Power-LED	je ca. 1,0W about 1,0W	IP20	I



ic|cle

1 Leuchte - 8 Möglichkeiten! 1 luminaire - 8 possibilities!

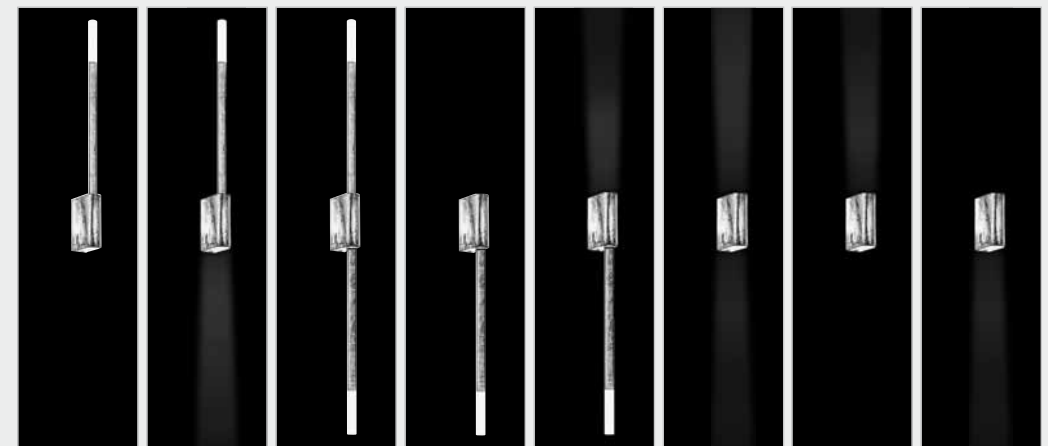

Lieferung in exklusiver Verpackung
 delivery in exclusive package

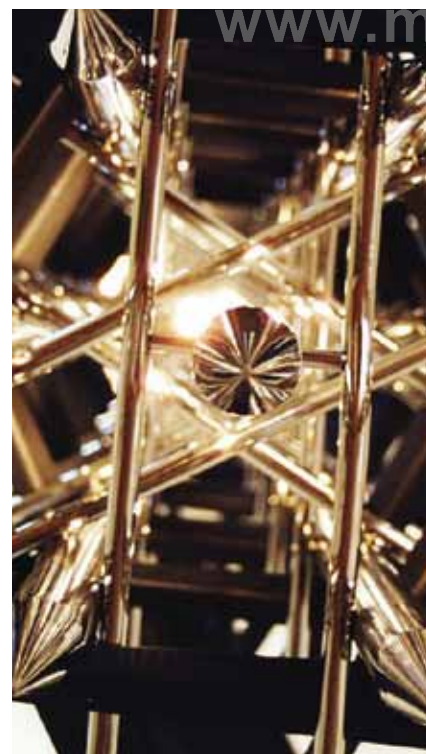

EXKLUSIVES DESIGN

Hier sehen Sie einen Auszug von diversen, bereits realisierten Sonderlösungen. Bei diesen Lichtobjekten handelt es sich um technisch hochkomplexe Lichtlösungen in Kombination mit einem unverwechselbaren Design.

Neben trendigen Materialien und Oberflächen kommt in der Regel neueste LED-Technik zum Einsatz. Bei der Ansteuerung der LED-Komponenten gibt es nahezu keine Grenzen.

Exklusivität bedeutet nicht nur eine hochwertige und exzellente Verarbeitung; der Kunde legt vielmehr Wert darauf, etwas Einzigartiges zu besitzen. Oftmals werden selbst Kleinigkeiten wie z.B. Schrauben oder andere mechanische Bauteile individuell angefertigt.

Schon für die Entwurfsphase ist es unserem Designer wichtig, dass er in direktem Kontakt zum Investor steht. Nur so können Wünsche und Ideenverlustfrei in das Lichtobjekt einfließen.

Here an abstract of diversly realized special solutions is presented. With respect to these light objects, it is a question of very complex light solutions on the technical side in combination with a unique design.

Besides trendy materials and surfaces, the latest LED technology is used. There are almost no limits for the control of the LED components.

Exclusivity doesn't only mean a high-class and excellent workmanship, but the client rather attaches importance to own something unique. Oftentimes, also odds and ends like screws or other mechanical components are individually manufactured.

Already for the design phase, it is important to our designer to be in contact with the investor, directly. By the way of conversation, all wishes and ideas can be implemented to the light object without loss.

www.beauforbrumberg.com

MODUL ELECTRO
www.modulelectro.com

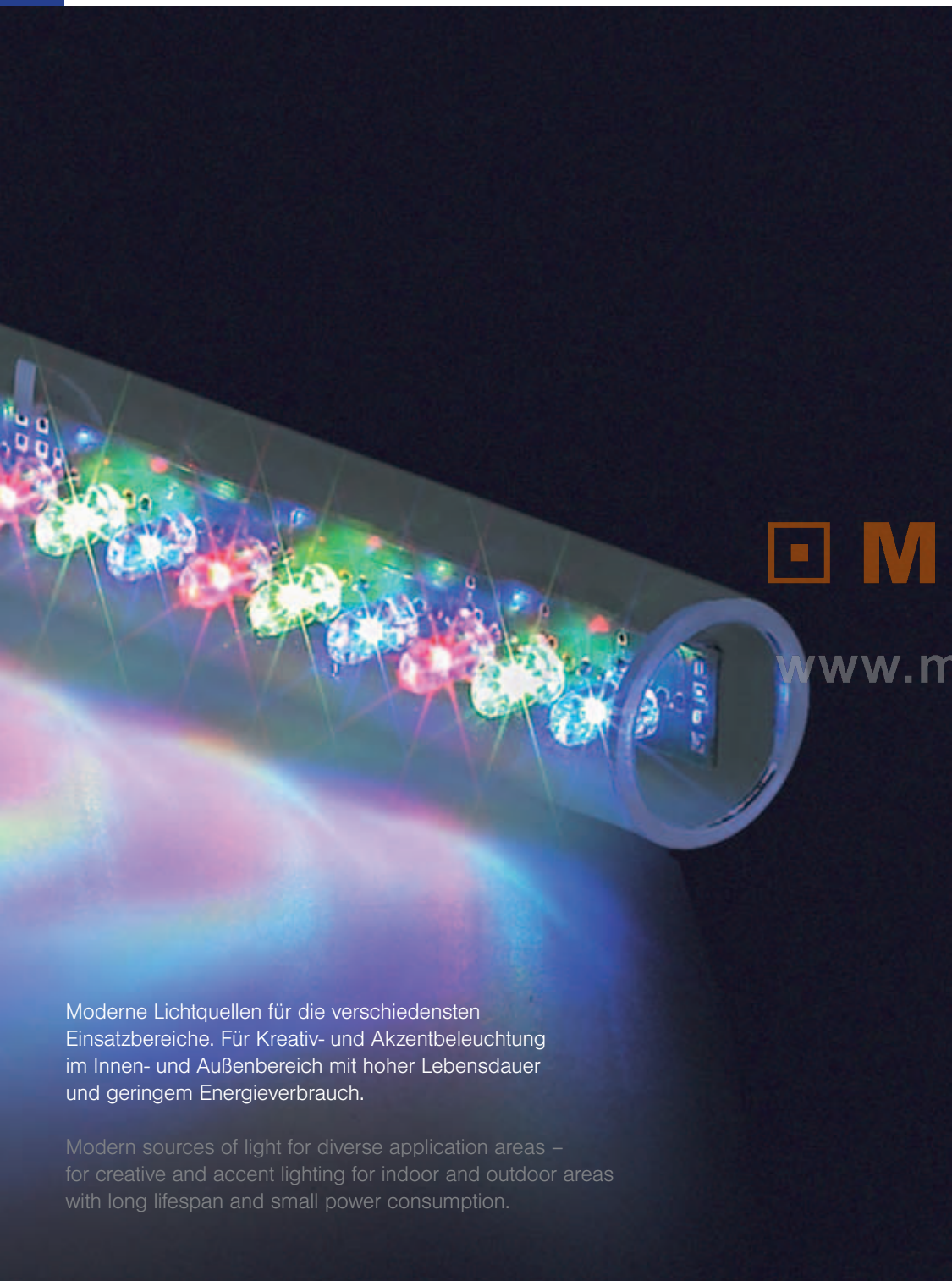

Moderne Lichtquellen für die verschiedensten Einsatzbereiche. Für Kreativ- und Akzentbeleuchtung im Innen- und Außenbereich mit hoher Lebensdauer und geringem Energieverbrauch.

Modern sources of light for diverse application areas – for creative and accent lighting for indoor and outdoor areas with long lifespan and small power consumption.

MODUL
ELECTRO
www.modulelectro.ru



Produktionsgebäude Mennekes, Kirchhundem

LED Technische Daten

Der Vorteil dieser Hochleistungsdioden, betrieben mit einem Konstantstrom von 350mA, liegt in einer bedeutend größeren Lichtstärke gegenüber den herkömmlichen LED und einer bedeutend größeren Effizienz von bis zu 90 Lumen pro Watt.

Reihenschaltung
Diese LEDs werden mit einem Konstantstrom von 350mA betrieben. Hierdurch bedingt müssen mehrere Leuchtdioden in -Reihenschaltung (alle LED werden vom gleichen Strom I durchflossen) angeschlossen werden. Eine Parallelschaltung ist nicht möglich!

Höchster Lichtstrom für LED
Mittlere Lebensdauer ca. 50.000 Stunden bei optimalen Betriebsbedingungen, d.h. dass nach ca. 50.000 Stunden der Lichtstrom der LED noch bei ca. 70% der Ausgangsleistung liegt.
Optimale Betriebsbedingungen erhalten Sie unter Einsatz der kompletten Brumberg Komponenten (Konverter, LED, Leuchten) und durch Einhaltung der Installationsvorschriften.

LED-Qualitäten:
Im Gegensatz zu anderen Lichtquellen gibt es bei LEDs keine standardisierte Farbtemperaturen. Jede einzelne LED wird nach drei Kriterien selektiert: Lichtstrom, Farbort und Farbtemperatur sowie Vorwärtsspannung der einzelnen LED. Diese Selektion wird auch Binning genannt. Alle Metallkernleiterplatten werden grundsätzlich mit der Angabe der eingesetzten LED-Type und des entsprechenden Binnings gekennzeichnet. Soweit nicht anders vereinbart, garantieren wir pro Lieferung die gleiche Selektion des Lichtstroms und der Farbtemperatur bzw. der Wellenlänge. Insbesondere bei Projekten, die verschiedene Lieferungen (z. B. unterschiedliche Bauabschnitte) bedingen, ist es wichtig, daß der entsprechende Bin (Selektion) bei einer Nachbestellung angegeben wird. Wir werden uns dann bemühen, entsprechende Selektionen nachzuliefern, sofern diese verfügbar sind.

Unsere Partner auf dem Gebiet der Hochleistungs-LED:

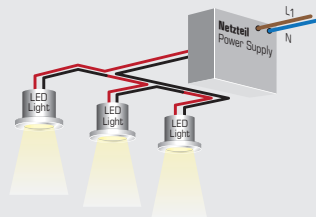

LED-Daten CREE

	kaltweiß	neutral-weiß	warm-weiß
Strom	350mA	350mA	350mA
Lumen	90 lm	90 lm	65 lm
Leistung	ca. 1,2W	ca. 1,2W	ca. 1,2W
Spannung Vf	3,3 - 3,9V	3,3 - 3,9V	3,3 - 3,9V
Farbtemperatur	6.500 K	4.100 K	3.100 K
Abstrahlwinkel	90°	90°	90°

LED Technical data

The advantage of these high-performance diodes operating with a constant power of 350mA is the considerable increase in light efficiency in comparison to conventional LED and a significant raise in efficiency up to 90 lumen per watt.

Series connection
These LED are powered by a constant current of 350mA. Hereby several LED are to be connected in series connection (all LED are flown through by the same power I). A parallel connection is impossible!

Highest luminous flux for LED
Average durability about 50.000 hours in case of optimal operating conditions. This means an output power of at least 70 % of the luminous flux after 50.000 hours operation.
Optimal operation conditions are maintained by a complete use of Brumberg components (converter, LED, luminaires) and the compliance with installation rules.

LED qualities
In contrast to other light sources for LED there are no standardized colour temperatures. Each LED is selected in accordance to three criteria: luminous flux, colour locus and colour temperature as well as forward voltage of each LED. This selection is also binning.

All metal core circuit boards are generally marked with information about LED type and the according binning. Unless otherwise agreed we ensure the same luminous flux selection and colour temperature respectively wavelength. Particularly with regard to projects which require different deliveries (varying phases of construction, e.g.), it is important to state the according binning code (selection) when a repeat order is placed. We will make an effort to supply corresponding selections later if available.

Our partners in the high performance LED field are:

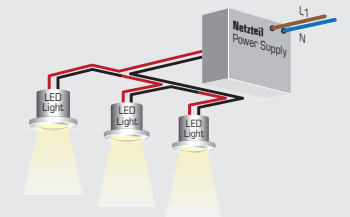

CREE XR-E

LED	cold white	neutral white	warm white
current	350mA	350mA	350mA
Lumen	90 lm	90 lm	65 lm
power	about 1,2W	about 1,2W	about 1,2W
voltage Vf	3,3 - 3,9V	3,3 - 3,9V	3,3 - 3,9V
colour temperature	6.500 K	4.100 K	3.000 K
angle of reflected beam	90°	90°	90°

www.modulelectronic.de

LED Technische Daten

LED – Binning:

Im Gegensatz zu „herkömmlichen“ Leuchtmitteln wie Halogen oder Keramikkampen haben die LED's unterschiedliche Farbtemperaturen im weiß-Bereich sowie unterschiedliche Wellenlängen im Bereich der farbigen LED's. Hier gibt es gerade im Bereich der RGB-Farbmischungen zum Teil Farbunterschiede bei den Wellenlängen um bis 20 nm.

Die einzelnen LED's haben unterschiedliche Vorwärtsspannungen (Vf) im Bereich von 2,31V bis 3,99V.

Bei den RGB-Leiterplatten werden deshalb jeweils angepasste Widerstände je LED-Farbe (rot, grün + blau) eingesetzt, um eine Betriebsspannung von 12V zu gewährleisten.

Ein drittes Kriterium bei der Selektion einzelner LED's ist der Lichtstrom (Lumen) bzw. die Lichtstärke (Candela).

Dies ist Stand der Technik und leider ist die Halbleiterphysik nicht zu umgehen. Weiterhin kann eine Weißfarbe durch Farbmischung nur annähernd simuliert werden; nicht jedoch exakt garantiert werden.

Bei den von uns gelieferten Leiterplatten garantieren wir Ihnen grundsätzlich folgendes, sofern keine anderen Absprachen getroffen werden:

- je Lieferung gleiche Fertigungscharge
- je Lieferung gleiche Wellenlängen bzw. Farbtemperaturen
- je Lieferung gleiche entsprechend angepasste Widerstände

Für Projekte mit unterschiedlichen Bauabschnitten ist es unbedingt erforderlich, kundenseitig hierauf hinzuweisen, um entsprechende Lagerbestände zu „disponieren“.

LED-Daten Luxeon

Lichtfarbe	Lichtstrom / LED	Farbtemperatur bzw. Wellenlänge			Vorwärtsspannung			Abstrahlwinkel
		min.	typisch	max.	min.	typisch	max.	
kaltweiß	80-89 Lumen	4500K	6500K	10.000K	2,55V	3,15V	3,99V	140°
neutralweiß	80-89 Lumen	3500K	4100K	4500K	2,55V	3,15V	3,99V	140°
warmweiß	50-60 Lumen	2670K	3100K	3500K	2,55V	3,15V	3,99V	140°
royalblau	275mW	440nm	455nm	460nm	2,55V	3,15V	3,99V	140°
rot	30-39 Lumen	621nm	627nm	645nm	2,31V	2,90V	3,51V	140°
amber	30-39 Lumen	585nm	590nm	597nm	2,31V	2,90V	3,51V	140°
grün	50-59 Lumen	520nm	530nm	550nm	2,55V	3,15V	3,99V	140°

LED Technical data

LED – Binning:

In contrary to ‚conventional‘ illuminants as halogene or ceramic lamps, the LED's possess different colour temperatures within the achromatic spectrum, as well as different wavelengths within the spectrum of the coloured LED's. Precisely in the field of RGB colour mixtures, there are partly colour differences concerning wavelengths of up to about 20 nm.

Furthermore, the single LED's have diverse forward biases from 2,31V up to 3,99V.

To ensure an operating voltage of 12V, particularly adapted resistors are used for the RGB conductor boards per LED colour (red, green + blue).

A third criterion for the selection of single LED's is the luminous flux (lumen), respectively the luminous intensity (candela). This is the state of the technology and therefore, the semi-conductor physics unfortunately cannot be avoid. In addition, an achromatic colour can only nearly be simulated by colour mixtures, but not be guaranteed, exactly.

As far as not agreed otherwise, for conductor boards delivered by us, we generally guarantee the following:

- identical production lots per delivery
- identical wavelengths, respectively colour temperatures per delivery
- identical resistors which are particularly adapted per delivery

For projects with different construction stages it is absolutely essential to pay attention to this important fact on the customers side, to be able to ‚bloc‘ concerning stocks.

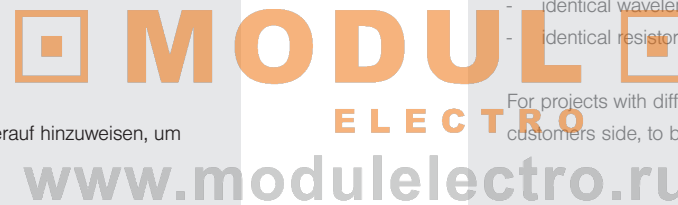

REBEL

light colour	luminous flux / LED	colour temperature or rather wavelength			forward bias			angle of reflected beam
		min.	characteristic	max.	characteristic	typical	max.	
cold white	80-89 Lumen	4500K	6500K	10.000K	2,55V	3,15V	3,99V	140°
neutral white	80-89 Lumen	3500K	4100K	4500K	2,55V	3,15V	3,99V	140°
warm white	50-60 Lumen	2670K	3100K	3500K	2,55V	3,15V	3,99V	140°
royal blue	275mW	440nm	455nm	460nm	2,55V	3,15V	3,99V	140°
red	30-39 Lumen	621nm	627nm	645nm	2,31V	2,90V	3,51V	140°
amber	30-39 Lumen	585nm	590nm	597nm	2,31V	2,90V	3,51V	140°
green	50-59 Lumen	520nm	530nm	550nm	2,55V	3,15V	3,99V	140°



LED Competence Centre, Brumberg

LED-Leuchtmittel / LED luminaire

Material: Aluminium / Kunststoff / material: aluminium / plastic
 Bestückung: 1x Hochleistungs-LED / GU10, Leistung: ca. 1,2 W
 lamp: 1x high performance-LED / GU10, power: ca. 1,2 W

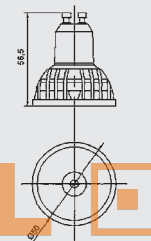
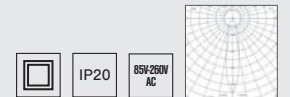

Art.-Nr. art.-no.	Lichtfarbe light colour	Farbtemperatur colour temperature	Linse lense	Preis € price €
B3010W	kaltweiß / white	6500K	15°	25,70
B3010WW	warmweiß / warm white	3100K	15°	25,70

MODULE
ELECTRO

www.modulelectro.ru

LED-Leuchtmittel / LED luminaire

Material: Aluminium / Kunststoff / material: aluminium / plastic
 Bestückung: 3x Hochleistungs-LED / GU10, Leistung: ca. 3,6 W
 lamp: 3x high performance-LED / GU10, power: ca. 3,6 W

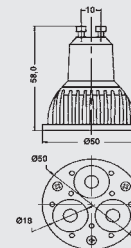
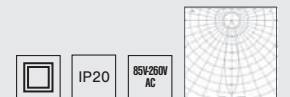

Art.-Nr. art.-no.	Lichtfarbe light colour	Farbtemperatur colour temperature	Linse lense	Preis € price €
B3030W	kaltweiß / white	6500K	15°	49,00
B3030WW	warmweiß / warm white	3100K	15°	49,00

LED-Einsatz | LED-insert

R3700...



Hochleistungs-LED-Einsatz / high performance LED insert

Materiale: Aluminium / Kunststoff / material: aluminium / plastic
 Bestückung: 3x Hochleistungs-LED, Leistung: ca. 3,6W
 lamp: 3x high performance LED, power: approx. 3,6W
 Lichtausbeute / light efficiency: 300lm

→ Konverter siehe Seite 442-445
 → converter see pages 442-445

NEU
new



Art.-Nr. art-no.	Lichtfarbe light colour	Farbtemperatur colour temperature	Linse lense	Preis € price €
R3700NW4	neutralweiß / neutral white	4100K	40°	69,00
R3700W4	kaltweiß / cold white	6500K	40°	69,00
R3700WW4	warmweiß / warm white	3100K	40°	69,00

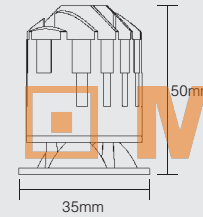
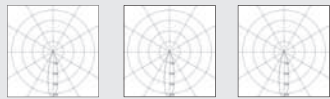

www.modulelectro.ru

Anschlussbeispiel / connexion-example

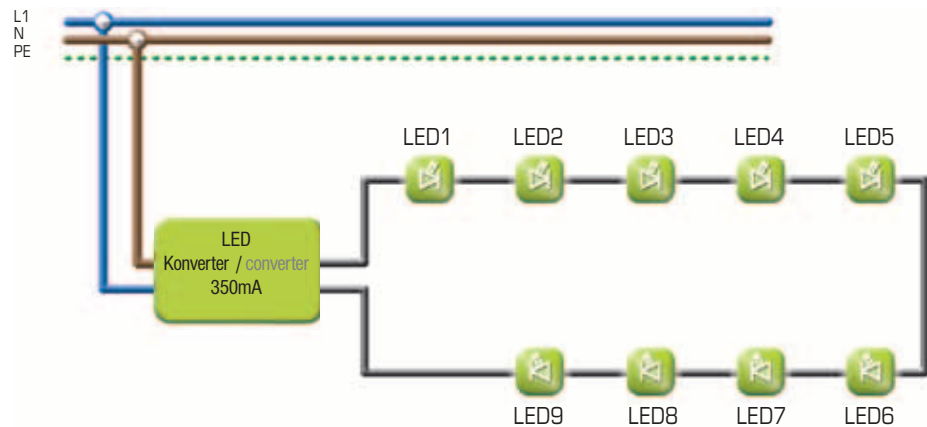

max. Leitungslänge sekundärseitig 10m
 max. connexion length on the secondary 10m

LED-Deckenspots mit R3700 | LED-ceiling lights with R3700

LED-Deckeneinbaustrahler / LED recessed ceiling light

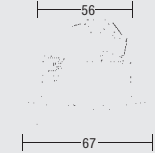

Materiale: Eisen / material: iron
 Farbe: nickel matt / colour: nickel satin

Art.-Nr. art-no.	Lichtfarbe light colour	Preis € price €
R3000NW4	neutralweiß / neutral white	89,00
R3000W4	kaltweiß / cold white	89,00
R3000WW4	warmweiß / warm white	89,00



R3000...



LED-Deckeneinbaustrahler / LED recessed ceiling light



Materiale: Aluminium / material: aluminium
 Farbe: aluminium / colour: aluminium

Art.-Nr. art-no.	Lichtfarbe light colour	Preis € price €
R6700NW4	neutralweiß / neutral white	82,50
R6700W4	kaltweiß / cold white	82,50
R6700WW4	warmweiß / warm white	82,50

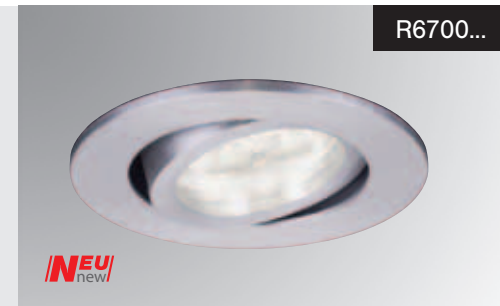

R6700...



LED-Deckeneinbaustrahler / LED recessed ceiling light

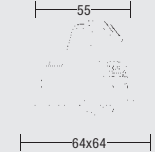

Materiale: Aluminium / material: aluminium
 Farbe: aluminium / colour: aluminium

Art.-Nr. art-no.	Lichtfarbe light colour	Preis € price €
R6800NW4	neutralweiß / neutral white	84,50
R6800W4	kaltweiß / cold white	84,50
R6800WW4	warmweiß / warm white	84,50

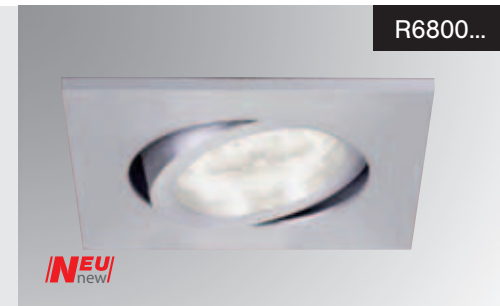

R6800...



LED-Deckeneinbaustrahler / LED recessed ceiling light

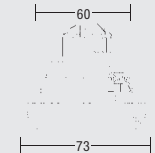

Materiale: Aluminium / material: aluminium
 Farbe: aluminium / colour: aluminium

Art.-Nr. art-no.	Lichtfarbe light colour	Preis € price €
R7100NW4	neutralweiß / neutral white	95,00
R7100W4	kaltweiß / cold white	95,00
R7100WW4	warmweiß / warm white	95,00

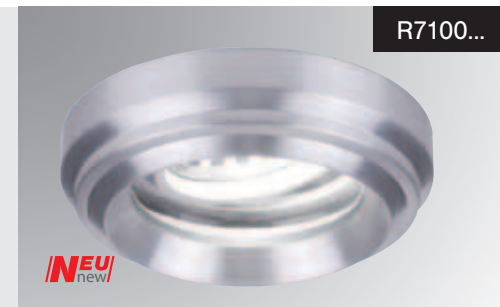

R7100...

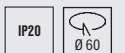

LED-Einsatz | LED-insert

LED-Deckenspots mit R3711 | LED-ceiling lights with R3711

R3711...



Hochleistungs-LED-Einsatz / high performance LED insert

Materiale: Aluminium / Kunststoff / material: aluminium / plastic
 Bestückung: 3x Hochleistungs-LED, Leistung: ca. 4,2W
 lamp: 3x high performance LED, power: approx. 4,2W
 Lichtausbeute / light efficiency: ca. 300lm

→ Konverter siehe Seite 450-451
 → converter see pages 450-451

NEU
new

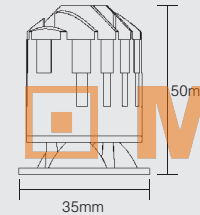

Art.-Nr. art-no.	Lichtfarbe light colour	Farbtemperatur colour temperature	Linse lense	Preis € price €
R3711NW4	neutralweiß / neutral white	4100K	40°	75,00
R3711W4	kaltweiß / cold white	6500K	40°	75,00
R3711WW4	warmweiß / warm white	3100K	40°	75,00



Anschlussbeispiel / connexion-example

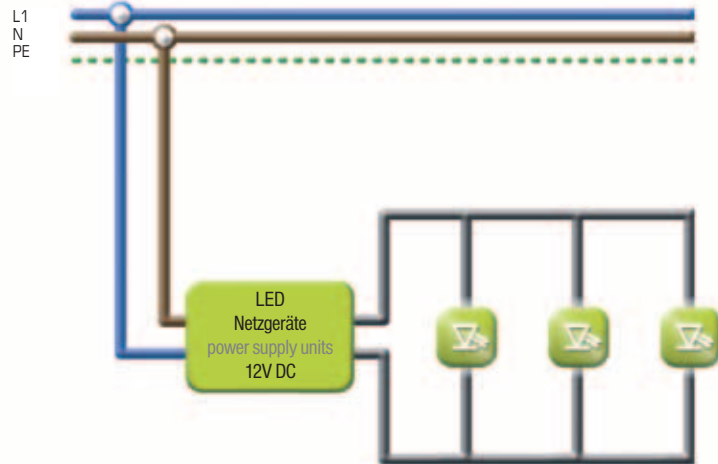

LED-Deckeneinbaustrahler / LED recessed ceiling light



Materiale: Eisen / material: iron
 Farbe: nickel matt / colour: nickel satin

Art.-Nr. art-no.	Lichtfarbe light colour	Preis € price €
R3011NW4	neutralweiß / neutral white	95,00
R3011W4	kaltweiß / cold white	95,00
R3011WW4	warmweiß / warm white	95,00

R3011...



NEU
new



LED-Deckeneinbaustrahler / LED recessed ceiling light



Materiale: Aluminium / material: aluminium
 Farbe: aluminium / colour: aluminium

Art.-Nr. art-no.	Lichtfarbe light colour	Preis € price €
R6711NW4	neutralweiß / neutral white	88,50
R6711W4	kaltweiß / cold white	88,50
R6711WW4	warmweiß / warm white	88,50

R6711...

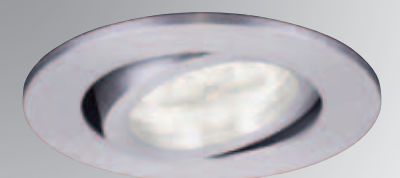

NEU
new



LED-Deckeneinbaustrahler / LED recessed ceiling light



Materiale: Aluminium / material: aluminium
 Farbe: aluminium / colour: aluminium

Art.-Nr. art-no.	Lichtfarbe light colour	Preis € price €
R6811NW4	neutralweiß / neutral white	90,50
R6811W4	kaltweiß / cold white	90,50
R6811WW4	warmweiß / warm white	90,50

R6800...



NEU
new



LED-Deckeneinbaustrahler / LED recessed ceiling light

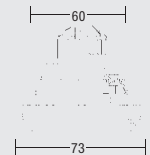

Materiale: Aluminium / Glas / material: aluminium / glass
 Farbe: aluminium / colour: aluminium

Art.-Nr. art-no.	Lichtfarbe light colour	Preis € price €
R7111NW4	neutralweiß / neutral white	104,00
R7111W4	kaltweiß / cold white	104,00
R7111WW4	warmweiß / warm white	104,00

R7100...

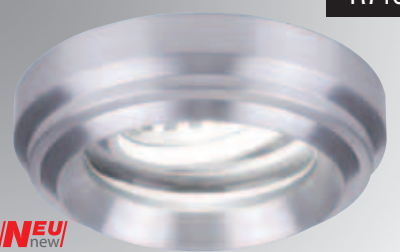

NEU
new



MODUL
ELECTRO
www.modulelectro.ru

LED-Einsatz | LED-insert

LED-Deckenspots mit R3705 | LED-ceiling lights with R3705

R3705...



Hochleistungs-LED-Einsatz / high performance LED insert

Material: Aluminium / Kunststoff / material: aluminium / plastic
 Bestückung: 3x Hochleistungs-LED, Leistung: ca. 3,6W
 lamp: 3x high performance LED, power: approx. 3,6W
 Lichtausbeute / light efficiency: ca. 270lm/W

→ Konverter siehe Seite 442-445
 → converter see pages 442-445



Art.-Nr. art-no.	Lichtfarbe light colour	Farbtemperatur colour temperature	Linse lense	Preis € price €
R3705NW2	neutralweiß / neutral white	4100K	25°	55,70
R3705NW4	neutralweiß / neutral white	4100K	45°	55,70
R3705NW6	neutralweiß / neutral white	4100K	60°	55,70
R3705W2	kaltweiß / cold white	6500K	25°	55,70
R3705W4	kaltweiß / cold white	6500K	45°	55,70
R3705W6	kaltweiß / cold white	6500K	60°	55,70
R3705WW2	warmweiß / warm white	3100K	25°	55,70
R3705WW4	warmweiß / warm white	3100K	45°	55,70
R3705WW6	warmweiß / warm white	3100K	60°	55,70

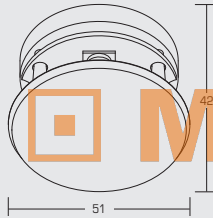

www.modulelectro.ru

Anschlussbeispiel / connexion-example

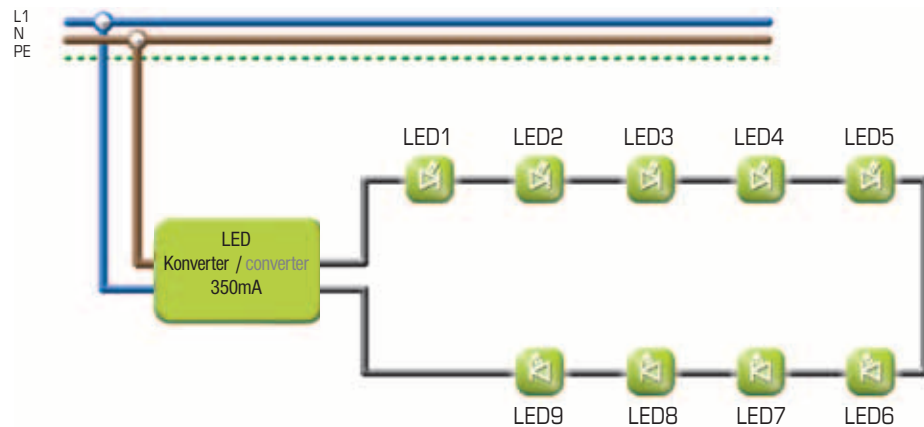

max. Leitungslänge sekundärseitig 10m
 max. connexion length on the secondary 10m

LED-Deckeneinbastrahler / LED recessed ceiling light

Material: Eisen / Aluminium / Kunststoff / material: iron / aluminium / plastic
 Farbe: nickel matt / colour: nickel satin

Art.-Nr. art-no.	Lichtfarbe light colour	Farbtemperatur colour temperature	Linse lense	Preis € price €
R3005NW2	neutralweiß / neutral white	4100K	25°	78,30
R3005NW4	neutralweiß / neutral white	4100K	45°	78,30
R3005NW6	neutralweiß / neutral white	4100K	60°	78,30
R3005W2	kaltweiß / cold white	6500K	25°	78,30
R3005W4	kaltweiß / cold white	6500K	45°	78,30
R3005W6	kaltweiß / cold white	6500K	60°	78,30
R3005WW2	warmweiß / warm white	3100K	25°	78,30
R3005WW4	warmweiß / warm white	3100K	45°	78,30
R3005WW6	warmweiß / warm white	3100K	60°	78,30

R3005...

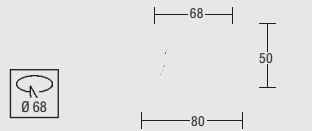
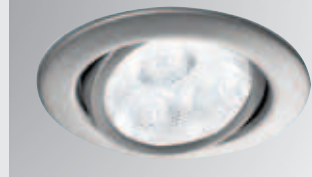

LED-Deckeneinbastrahler / LED recessed ceiling light

Material: Aluminium / Kunststoff / material: aluminium / plastic
 Farbe: aluminium / colour: aluminium

Art.-Nr. art-no.	Lichtfarbe light colour	Farbtemperatur colour temperature	Linse lense	Preis € price €
R0065NW2	neutralweiß / neutral white	4100K	25°	71,10
R0065NW4	neutralweiß / neutral white	4100K	45°	71,10
R0065NW6	neutralweiß / neutral white	4100K	60°	71,10
R0065W2	kaltweiß / cold white	6500K	25°	71,10
R0065W4	kaltweiß / cold white	6500K	45°	71,10
R0065W6	kaltweiß / cold white	6500K	60°	71,10
R0065WW2	warmweiß / warm white	3100K	25°	71,10
R0065WW4	warmweiß / warm white	3100K	45°	71,10
R0065WW6	warmweiß / warm white	3100K	60°	71,10

R0065...

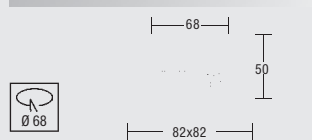

LED-Deckeneinbastrahler / LED recessed ceiling light

Material: Aluminium / Kunststoff / material: aluminium / plastic
 Farbe: aluminium / colour: aluminium

Art.-Nr. art-no.	Lichtfarbe light colour	Farbtemperatur colour temperature	Linse lense	Preis € price €
R0063NW2	neutralweiß / neutral white	4100K	25°	70,10
R0063NW4	neutralweiß / neutral white	4100K	45°	70,10
R0063NW6	neutralweiß / neutral white	4100K	60°	70,10
R0063W2	kaltweiß / cold white	6500K	25°	70,10
R0063W4	kaltweiß / cold white	6500K	45°	70,10
R0063W6	kaltweiß / cold white	6500K	60°	70,10
R0063WW2	warmweiß / warm white	3100K	25°	70,10
R0063WW4	warmweiß / warm white	3100K	45°	70,10
R0063WW6	warmweiß / warm white	3100K	60°	70,10

R0063...



LED-Deckeneinbastrahler / LED recessed ceiling light

Material: Aluminiumguss / Glas klar / material: aluminium cast / glass clear
 Farbe: chrom / colour: chrome

Art.-Nr. art-no.	Lichtfarbe light colour	Farbtemperatur colour temperature	Linse lense	Preis € price €
R2671NW2	neutralweiß / neutral white	4100K	25°	95,30
R2671NW4	neutralweiß / neutral white	4100K	45°	95,30
R2671NW6	neutralweiß / neutral white	4100K	60°	95,30
R2671W2	kaltweiß / cold white	6500K	25°	95,30
R2671W4	kaltweiß / cold white	6500K	45°	95,30
R2671W6	kaltweiß / cold white	6500K	60°	95,30
R2671WW2	warmweiß / warm white	3100K	25°	95,30
R2671WW4	warmweiß / warm white	3100K	45°	95,30
R2671WW6	warmweiß / warm white	3100K	60°	95,30

R2671...



LED-Einsatz | LED-insert

LED-Deckenspots mit R3704 | LED-ceiling lights with R3704

R3704...



Hochleistungs-LED-Einsatz / high performance LED insert

Material: Aluminium / Kunststoff / material: aluminium / plastic
 Bestückung: 3x Hochleistungs-LED, Leistung: ca. 5,4W
 lamp: 3x high performance LED, power: approx. 5,4W
 Lichtausbeute / light efficiency: ca. 350lm

→ Konverter siehe Seite 450-451
 → converter see pages 450-451



Art.-Nr. art-no.	Lichtfarbe light colour	Farbtemperatur colour temperature	Linse lense	Preis € price €
R3704NW2	neutralweiß / neutral white	4100K	25°	69,90
R3704NW4	neutralweiß / neutral white	4100K	45°	69,90
R3704NW6	neutralweiß / neutral white	4100K	60°	69,90
R3704W2	kaltweiß / cold white	6500K	25°	69,90
R3704W4	kaltweiß / cold white	6500K	45°	69,90
R3704W6	kaltweiß / cold white	6500K	60°	69,90
R3704WW2	warmweiß / warm white	3100K	25°	69,90
R3704WW4	warmweiß / warm white	3100K	45°	69,90
R3704WW6	warmweiß / warm white	3100K	60°	69,90

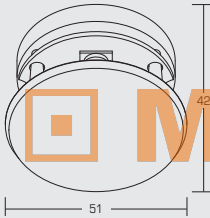

www.modulelectro.ru

Anschlussbeispiel / connexion-example

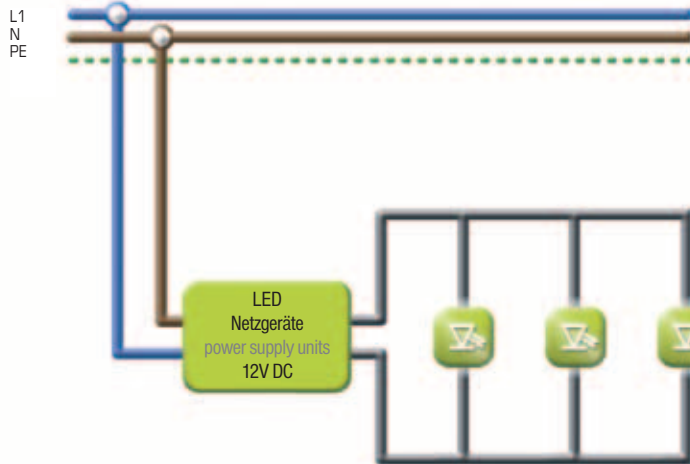

LED-Deckeneinbastrahler / LED recessed ceiling light

Material: Eisen / Aluminium / Kunststoff / material: iron / aluminium / plastic
 Farbe: nickel matt / colour: nickel satin

Art.-Nr. art-no.	Lichtfarbe light colour	Farbtemperatur colour temperature	Linse lense	Preis € price €
R3004NW2	neutralweiß / neutral white	4100K	25°	93,00
R3004NW4	neutralweiß / neutral white	4100K	45°	93,00
R3004NW6	neutralweiß / neutral white	4100K	60°	93,00
R3004W2	kaltweiß / cold white	6500K	25°	93,00
R3004W4	kaltweiß / cold white	6500K	45°	93,00
R3004W6	kaltweiß / cold white	6500K	60°	93,00
R3004WW2	warmweiß / warm white	3100K	25°	93,00
R3004WW4	warmweiß / warm white	3100K	45°	93,00
R3004WW6	warmweiß / warm white	3100K	60°	93,00

R3004...

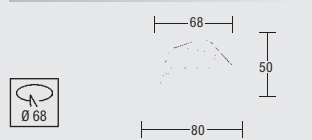
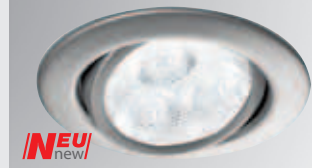

LED-Deckeneinbastrahler / LED recessed ceiling light

Material: Aluminium / Kunststoff / material: aluminium / plastic
 Farbe: aluminium / colour: aluminium

Art.-Nr. art-no.	Lichtfarbe light colour	Farbtemperatur colour temperature	Linse lense	Preis € price €
R6504NW2	neutralweiß / neutral white	4100K	25°	84,90
R6504NW4	neutralweiß / neutral white	4100K	45°	84,90
R6504NW6	neutralweiß / neutral white	4100K	60°	84,90
R6504W2	kaltweiß / cold white	6500K	25°	84,90
R6504W4	kaltweiß / cold white	6500K	45°	84,90
R6504W6	kaltweiß / cold white	6500K	60°	84,90
R6504WW2	warmweiß / warm white	3100K	25°	84,90
R6504WW4	warmweiß / warm white	3100K	45°	84,90
R6504WW6	warmweiß / warm white	3100K	60°	84,90

R6504...

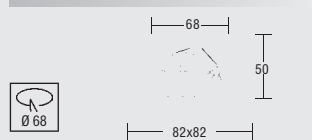

LED-Deckeneinbastrahler / LED recessed ceiling light

Material: Aluminium / Kunststoff / material: aluminium / plastic
 Farbe: aluminium / colour: aluminium

Art.-Nr. art-no.	Lichtfarbe light colour	Farbtemperatur colour temperature	Linse lense	Preis € price €
R6304NW2	neutralweiß / neutral white	4100K	25°	83,90
R6304NW4	neutralweiß / neutral white	4100K	45°	83,90
R6304NW6	neutralweiß / neutral white	4100K	60°	83,90
R6304W2	kaltweiß / cold white	6500K	25°	83,90
R6304W4	kaltweiß / cold white	6500K	45°	83,90
R6304W6	kaltweiß / cold white	6500K	60°	83,90
R6304WW2	warmweiß / warm white	3100K	25°	83,90
R6304WW4	warmweiß / warm white	3100K	45°	83,90
R6304WW6	warmweiß / warm white	3100K	60°	83,90

R6304...



LED-Deckeneinbastrahler / LED recessed ceiling light

Material: Aluminiumguss / Glas klar / material: aluminium cast / glass clear
 Farbe: chrom / colour: chrome

Art.-Nr. art-no.	Lichtfarbe light colour	Farbtemperatur colour temperature	Linse lense	Preis € price €
R7104NW2	neutralweiß / neutral white	4100K	25°	96,00
R7104NW4	neutralweiß / neutral white	4100K	45°	96,00
R7104NW6	neutralweiß / neutral white	4100K	60°	96,00
R7104W2	kaltweiß / cold white	6500K	25°	96,00
R7104W4	kaltweiß / cold white	6500K	45°	96,00
R7104W6	kaltweiß / cold white	6500K	60°	96,00
R7104WW2	warmweiß / warm white	3100K	25°	96,00
R7104WW4	warmweiß / warm white	3100K	45°	96,00
R7104WW6	warmweiß / warm white	3100K	60°	96,00

R7104...

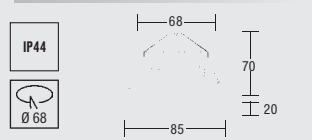

R3701...



Hochleistungs-LED-Einsatz / high performance LED insert

Material: Aluminium / Kunststoff / material: aluminium / plastic
 Bestückung: 3x Hochleistungs-LED, Leistung: ca. 7,2W
 lamp: 3x high performance LED, power: approx. 7,2W
 Lichtausbeute / light efficiency: ca. 500lm

→ Konverter siehe Seite 446
 → converter see pages 446



Art.-Nr. art-no.	Lichtfarbe light colour	Farbtemperatur colour temperature	Linse lense	Preis € price €
R3701NW2	neutralweiß / neutral white	4100K	25°	75,00
R3701NW4	neutralweiß / neutral white	4100K	45°	75,00
R3701NW6	neutralweiß / neutral white	4100K	60°	75,00
R3701W2	kaltweiß / cold white	6500K	25°	75,00
R3701W4	kaltweiß / cold white	6500K	45°	75,00
R3701W6	kaltweiß / cold white	6500K	60°	75,00
R3701WW2	warmweiß / warm white	3100K	25°	75,00
R3701WW4	warmweiß / warm white	3100K	45°	75,00
R3701WW6	warmweiß / warm white	3100K	60°	75,00

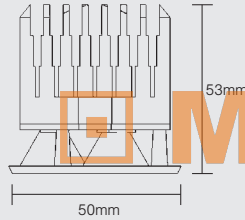
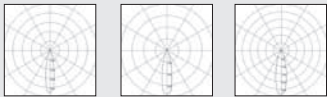

www.modulelectro.ru

Anschlussbeispiel / connexion-example

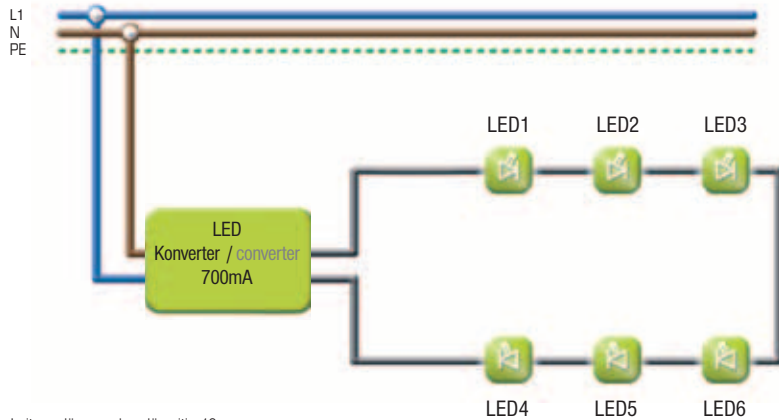

max. Leitungslänge sekundärseitig 10m
 max. connexion length on the secondary 10m

LED-Deckeneinbastrahler / LED recessed ceiling light

Material: Eisen / Aluminium / Kunststoff / material: iron / aluminium / plastic
 Farbe: nickel matt / colour: nickel satin

Art.-Nr. art-no.	Lichtfarbe light colour	Farbtemperatur colour temperature	Linse lense	Preis € price €
R3001NW2	neutralweiß / neutral white	4100K	25°	98,00
R3001NW4	neutralweiß / neutral white	4100K	45°	98,00
R3001NW6	neutralweiß / neutral white	4100K	60°	98,00
R3001W2	kaltweiß / cold white	6500K	25°	98,00
R3001W4	kaltweiß / cold white	6500K	45°	98,00
R3001W6	kaltweiß / cold white	6500K	60°	98,00
R3001WW2	warmweiß / warm white	3100K	25°	98,00
R3001WW4	warmweiß / warm white	3100K	45°	98,00
R3001WW6	warmweiß / warm white	3100K	60°	98,00

R3001...



LED-Deckeneinbastrahler / LED recessed ceiling light

Material: Aluminium / Kunststoff / material: aluminium / plastic
 Farbe: aluminium / colour: aluminium

Art.-Nr. art-no.	Lichtfarbe light colour	Farbtemperatur colour temperature	Linse lense	Preis € price €
R6501NW2	neutralweiß / neutral white	4100K	25°	90,00
R6501NW4	neutralweiß / neutral white	4100K	45°	90,00
R6501NW6	neutralweiß / neutral white	4100K	60°	90,00
R6501W2	kaltweiß / cold white	6500K	25°	90,00
R6501W4	kaltweiß / cold white	6500K	45°	90,00
R6501W6	kaltweiß / cold white	6500K	60°	90,00
R6501WW2	warmweiß / warm white	3100K	25°	90,00
R6501WW4	warmweiß / warm white	3100K	45°	90,00
R6501WW6	warmweiß / warm white	3100K	60°	90,00

R6501...



LED-Deckeneinbastrahler / LED recessed ceiling light

Material: Aluminium / Kunststoff / material: aluminium / plastic
 Farbe: aluminium / colour: aluminium

Art.-Nr. art-no.	Lichtfarbe light colour	Farbtemperatur colour temperature	Linse lense	Preis € price €
R6301NW2	neutralweiß / neutral white	4100K	25°	89,00
R6301NW4	neutralweiß / neutral white	4100K	45°	89,00
R6301NW6	neutralweiß / neutral white	4100K	60°	89,00
R6301W2	kaltweiß / cold white	6500K	25°	89,00
R6301W4	kaltweiß / cold white	6500K	45°	89,00
R6301W6	kaltweiß / cold white	6500K	60°	89,00
R6301WW2	warmweiß / warm white	3100K	25°	89,00
R6301WW4	warmweiß / warm white	3100K	45°	89,00
R6301WW6	warmweiß / warm white	3100K	60°	89,00

R6301...

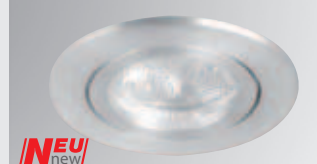

LED-Deckeneinbastrahler / LED recessed ceiling light

Material: Aluminiumguss / Glas klar / material: aluminium cast / glass clear
 Farbe: chrom / colour: chrome

Art.-Nr. art-no.	Lichtfarbe light colour	Farbtemperatur colour temperature	Linse lense	Preis € price €
R7101NW2	neutralweiß / neutral white	4100K	25°	99,00
R7101NW4	neutralweiß / neutral white	4100K	45°	99,00
R7101NW6	neutralweiß / neutral white	4100K	60°	99,00
R7101W2	kaltweiß / cold white	6500K	25°	99,00
R7101W4	kaltweiß / cold white	6500K	45°	99,00
R7101W6	kaltweiß / cold white	6500K	60°	99,00
R7101WW2	warmweiß / warm white	3100K	25°	99,00
R7101WW4	warmweiß / warm white	3100K	45°	99,00
R7101WW6	warmweiß / warm white	3100K	60°	99,00

R7101...

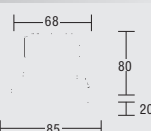

P3627...



LED-Deckeneinbauleuchte / LED recessed ceiling light

Material: Eisen / Aluminium / Kunststoff / material: iron / aluminium / plastic
 Farbe: weiß / colour: white
 Bestückung: 3x Hochleistungs-LED, Leistung: ca. 3,0W
 lamp: 3x high performance LED, power: approx. 3,0W
 schwenkbar / rotatable

→ Konverter siehe Seite 442-445
 → converter see pages 442-445

NEU
new



Art.-Nr. art-no.	Lichtfarbe light colour	Farbtemperatur colour temperatur	Preis € price €
P3627W	kaltweiß / cold white ●	6500K	169,00

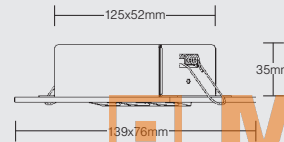

MODUL
ELECTRO
www.modulelectro.ru

P3628...



LED-Deckeneinbauleuchte / LED recessed ceiling light

Material: Eisen / Aluminium / Kunststoff / material: iron / aluminium / plastic
 Farbe: nickel matt / colour: nickel satin
 Bestückung: 3x Hochleistungs-LED, Leistung: ca. 3,0W
 lamp: 3x high performance LED, power: approx. 3,0W
 schwenkbar / rotatable

→ Konverter siehe Seite / → converter see pages

NEU
new



Art.-Nr. art-no.	Lichtfarbe light colour	Farbtemperatur colour temperatur	Preis € price €
P3628W	kaltweiß / cold white ●	6500K	169,00

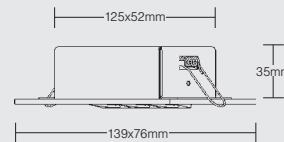

H3005...



LED-Deckeneinbaustrahler / LED recessed ceiling light

Material: Eisen / Aluminium / Kunststoff / material: iron / aluminium / plastic
 Bestückung: 3x Hochleistungs-LED, Leistung: ca. 3,6W
 lamp: 3x high performance LED, power: approx. 3,6W
 schwenkbar / rotatable

Montage in Hohldecken mit Federbefestigung
 Installation into suspended ceilings by spring fixation

Leuchte ist für 230V-Direktanschluss.
 luminaire for 230V-direct connection.
 inkl. Konverter / incl. converter

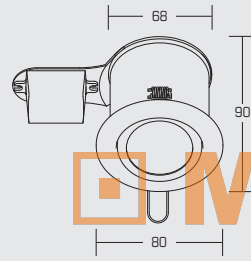

Art.-Nr. art.-no.	Lichtfarbe light colour	Farbtemperatur colour temperature	Linse lense	Preis € price €
H3005NW2	neutralweiß / neutral white	4100K	25°	133,00
H3005NW4	neutralweiß / neutral white	4100K	45°	133,00
H3005NW6	neutralweiß / neutral white	4100K	60°	133,00
H3005W2	kaltweiß / cold white	6500K	25°	133,00
H3005W4	kaltweiß / cold white	6500K	45°	133,00
H3005W6	kaltweiß / cold white	6500K	60°	133,00
H3005WW2	warmweiß / warm white	3100K	25°	133,00
H3005WW4	warmweiß / warm white	3100K	45°	133,00
H3005WW6	warmweiß / warm white	3100K	60°	133,00

H0065...



LED-Deckeneinbaustrahler / LED recessed ceiling light

Material: Aluminium / Kunststoff / material: aluminium / plastic
 Farbe: aluminium / colour: aluminium
 Bestückung: 3x Hochleistungs-LED, Leistung: ca. 3,6W
 lamp: 3x high performance LED, power: approx. 3,6W
 schwenkbar / rotatable

Montage in Hohldecken mit Federbefestigung
 Installation into suspended ceilings by spring fixation

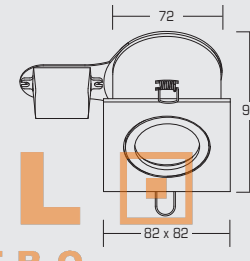

Leuchte ist für 230V-Direktanschluss.
 luminaire for 230V-direct connection.
 inkl. Konverter / incl. converter



Art.-Nr. art.-no.	Lichtfarbe light colour	Farbtemperatur colour temperature	Linse lense	Preis € price €
H0065NW2	neutralweiß / neutral white	4100K	25°	119,50
H0065NW4	neutralweiß / neutral white	4100K	45°	119,50
H0065NW6	neutralweiß / neutral white	4100K	60°	119,50
H0065W2	kaltweiß / cold white	6500K	25°	119,50
H0065W4	kaltweiß / cold white	6500K	45°	119,50
H0065W6	kaltweiß / cold white	6500K	60°	119,50
H0065WW2	warmweiß / warm white	3100K	25°	119,50
H0065WW4	warmweiß / warm white	3100K	45°	119,50
H0065WW6	warmweiß / warm white	3100K	60°	119,50

H0063...

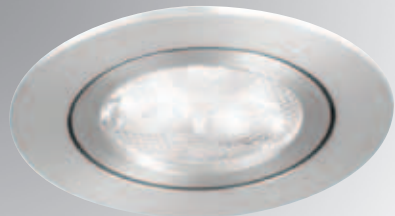

LED-Deckeneinbaustrahler / LED recessed ceiling light

Material: Aluminium / Kunststoff / material: aluminium / plastic
 Bestückung: 3x Hochleistungs-LED, Leistung: ca. 3,6W
 lamp: 3x high performance LED, power: approx. 3,6W
 schwenkbar / rotatable

Montage in Hohldecken mit Federbefestigung
 Installation into suspended ceilings by spring fixation

Leuchte ist für 230V-Direktanschluss.
 luminaire for 230V-direct connection.
 inkl. Konverter / incl. converter

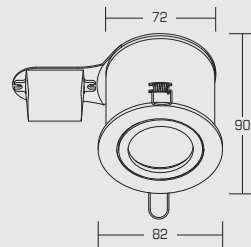

Art.-Nr. art.-no.	Lichtfarbe light colour	Farbtemperatur colour temperature	Linse lense	Preis € price €
H0063NW2	neutralweiß / neutral white	4100K	25°	118,50
H0063NW4	neutralweiß / neutral white	4100K	45°	118,50
H0063NW6	neutralweiß / neutral white	4100K	60°	118,50
H0063W2	kaltweiß / cold white	6500K	25°	118,50
H0063W4	kaltweiß / cold white	6500K	45°	118,50
H0063W6	kaltweiß / cold white	6500K	60°	118,50
H0063WW2	warmweiß / warm white	3100K	25°	118,50
H0063WW4	warmweiß / warm white	3100K	45°	118,50
H0063WW6	warmweiß / warm white	3100K	60°	118,50

H2671...



LED-Deckeneinbaustrahler / LED recessed ceiling light

Material: Aluminiumguss / Glas klar / material: aluminium cast / glass clear
 Farbe: chrom / colour: chrome
 Bestückung: 3x Hochleistungs-LED, Leistung: ca. 3,6W
 lamp: 3x high performance LED, power: approx. 3,6W

Montage in Hohldecken mit Federbefestigung
 Installation into suspended ceilings by spring fixation

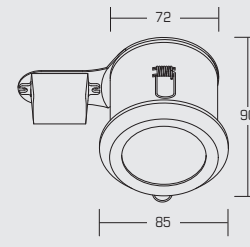

Leuchte ist für 230V-Direktanschluss.
 luminaire for 230V-direct connection.
 inkl. Konverter / incl. converter



Art.-Nr. art.-no.	Lichtfarbe light colour	Farbtemperatur colour temperature	Linse lense	Preis € price €
H2671NW2	neutralweiß / neutral white	4100K	25°	133,00
H2671NW4	neutralweiß / neutral white	4100K	45°	133,00
H2671NW6	neutralweiß / neutral white	4100K	60°	133,00
H2671W2	kaltweiß / cold white	6500K	25°	133,00
H2671W4	kaltweiß / cold white	6500K	45°	133,00
H2671W6	kaltweiß / cold white	6500K	60°	133,00
H2671WW2	warmweiß / warm white	3100K	25°	133,00
H2671WW4	warmweiß / warm white	3100K	45°	133,00
H2671WW6	warmweiß / warm white	3100K	60°	133,00

www.modulelectro.ru



R3020...



LED-Deckeneinbaustrahler / LED recessed ceiling light

Material: Edelstahl / Kunststoff / material: stainless steel / plastic
 Farbe: strukturweiß / colour: structure white
 Bestückung: 3x Hochleistungs-LED, Leistung: ca. 3,6W
 lamp: 3x high performance LED, power: approx. 3,6W
 25° schwenkbar / 25° rotatable

Inkl. Hohlwand-Montagedose / incl. built-in box

→ Konverter siehe Seite 442-445
 → converter see pages 442-445

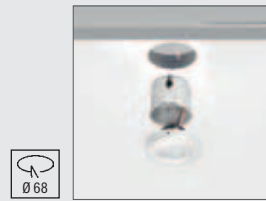

Art.-Nr. art-no.	Lichtfarbe light colour	Farbtemperatur colour temperature	Linse lense	Preis € price €
R3020NW2	neutralweiß / neutral white	4100K	25°	122,60
R3020NW4	neutralweiß / neutral white	4100K	45°	122,60
R3020NW6	neutralweiß / neutral white	4100K	60°	122,60
R3020W2	kaltweiß / cold white	6500K	25°	122,60
R3020W4	kaltweiß / cold white	6500K	45°	122,60
R3020W6	kaltweiß / cold white	6500K	60°	122,60
R3020WW2	warmweiß / warm white	3100K	25°	122,60
R3020WW4	warmweiß / warm white	3100K	45°	122,60
R3020WW6	warmweiß / warm white	3100K	60°	122,60

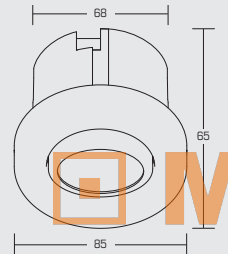

R3008...



LED-Deckeneinbaustrahler / LED recessed ceiling light

Material: Aluminium / Kunststoff / material: aluminium / plastic
 Farbe: aluminium / colour: aluminium
 Bestückung: 3x Hochleistungs-LED, Leistung: ca. 3,6W
 lamp: 3x high performance LED, power: approx. 3,6W

Montage in Hohlräumen mit Blattfeder

installation in suspended ceilings by leaf spring fixation

→ Konverter siehe Seite 442-445
 → converter see pages 442-445

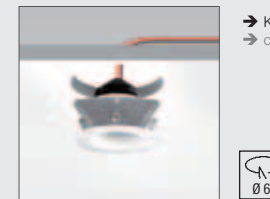

Art.-Nr. art-no.	Lichtfarbe light colour	Farbtemperatur colour temperature	Linse lense	Preis € price €
R3008NW2	neutralweiß / neutral white	4100K	25°	99,00
R3008NW4	neutralweiß / neutral white	4100K	45°	99,00
R3008W2	kaltweiß / cold white	6500K	25°	99,00
R3008W4	kaltweiß / cold white	6500K	45°	99,00
R3008WW2	warmweiß / warm white	3100K	25°	99,00
R3008WW4	warmweiß / warm white	3100K	45°	99,00

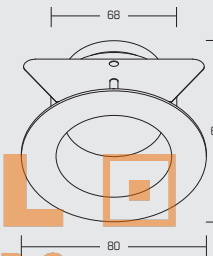

www.modulelectro.ru

R3021...



LED-Deckeneinbaustrahler / LED recessed ceiling light

Material: Edelstahl / Kunststoff / material: stainless steel / plastic
 Farbe: strukturweiß / colour: structure white
 Bestückung: 3x Hochleistungs-LED, Leistung: ca. 3,6W
 lamp: 3x high performance LED, power: approx. 3,6W
 25° schwenkbar / 25° rotatable

Inkl. Hohlwand-Montagedose / incl. built-in box

→ Konverter siehe Seite 442-445
 → converter see pages 442-445

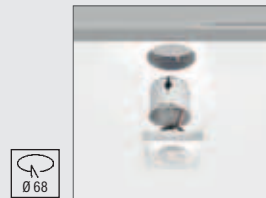

Art.-Nr. art-no.	Lichtfarbe light colour	Farbtemperatur colour temperature	Linse lense	Preis € price €
R3021NW2	neutralweiß / neutral white	4100K	25°	128,80
R3021NW4	neutralweiß / neutral white	4100K	45°	128,80
R3021NW6	neutralweiß / neutral white	4100K	60°	128,80
R3021W2	kaltweiß / cold white	6500K	25°	128,80
R3021W4	kaltweiß / cold white	6500K	45°	128,80
R3021W6	kaltweiß / cold white	6500K	60°	128,80
R3021WW2	warmweiß / warm white	3100K	25°	128,80
R3021WW4	warmweiß / warm white	3100K	45°	128,80
R3021WW6	warmweiß / warm white	3100K	60°	128,80

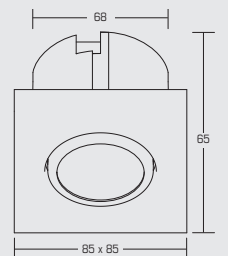

R3009...



LED-Deckeneinbaustrahler / LED recessed ceiling light

Material: Aluminium / Kunststoff / material: aluminium / plastic
 Farbe: weiß / colour: white
 Bestückung: 6x Hochleistungs-LED, Leistung: ca. 8,0W
 lamp: 6x high performance LED, power: approx. 8,0W

Montage in Hohlräumen mit Blattfeder

installation in suspended ceilings by leaf spring fixation

→ Konverter siehe Seite 442-445
 → converter see pages 442-445

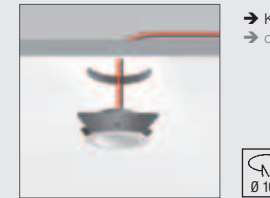

Art.-Nr. art-no.	Lichtfarbe light colour	Farbtemperatur colour temperature	Linse lense	Preis € price €
R3009NW2	neutralweiß / neutral white	4100K	25°	229,00
R3009NW4	neutralweiß / neutral white	4100K	45°	229,00
R3009W2	kaltweiß / cold white	6500K	25°	229,00
R3009W4	kaltweiß / cold white	6500K	45°	229,00
R3009WW2	warmweiß / warm white	3100K	25°	229,00
R3009WW4	warmweiß / warm white	3100K	45°	229,00

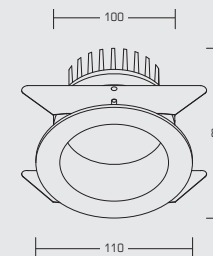

LED-Deckenspots | LED-ceiling lights

LED-Deckenspots | LED-ceiling lights

R3706...



LED-Einsatz / LED insert

Material: Aluminiumguss / Kunststoff / material: aluminium cast / plastic
 Farbe: aluminium / colour: aluminium
 Bestückung: 6x Hochleistungs-LED, Leistung: ca. 13,0W
 lamp: 6x high performance LED, power: approx. 13,0W

→ Konverter siehe Seite 450-451
 → converter see pages 450-451

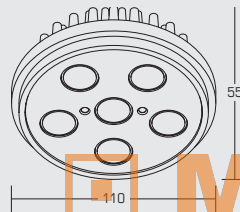

Art.-Nr. art.-no.	Lichtfarbe light colour	Farbtemperatur colour temperature	Linse lense	Preis € price €
R3706NW1	neutralweiß / neutral white	4100K	10°	199,00
R3706NW3	neutralweiß / neutral white	4100K	30°	199,00
R3706W1	kaltweiß / cold white	6500K	10°	199,00
R3706W3	kaltweiß / cold white	6500K	30°	199,00
R3706WW1	warmweiß / warm white	3100K	10°	199,00
R3706WW3	warmweiß / warm white	3100K	30°	199,00

R3010...



LED-Deckeneinbaustrahler / LED recessed ceiling light

Material: Aluminiumguss / Metall / Kunststoff / material: aluminium cast / metal / plastic
 Farbe: schwarz weiß / colour: black white
 Bestückung: 6x Hochleistungs-LED, Leistung: ca. 13,0W
 lamp: 6x high performance LED, power: approx. 13,0W

kardanische Aufhängung / gimbaled mounting

Montage in Hohldecken mit Federbefestigung
 Installation into suspended ceilings by spring fixation

→ Konverter siehe Seite 450-451
 → converter see pages 450-451

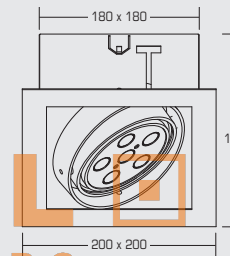

Art.-Nr. art.-no.	Lichtfarbe light colour	Farbtemperatur colour temperature	Linse lense	Preis € price €
R3010NW1	neutralweiß / neutral white	4100K	10°	249,00
R3010NW3	neutralweiß / neutral white	4100K	30°	249,00
R3010W1	kaltweiß / cold white	6500K	10°	249,00
R3010W3	kaltweiß / cold white	6500K	30°	249,00
R3010WW1	warmweiß / warm white	3100K	10°	249,00
R3010WW3	warmweiß / warm white	3100K	30°	249,00



www.modulelectro.ru

R3006...



LED-Deckeneinbaustrahler / LED recessed ceiling light

Material: Aluminiumguss / Kunststoff / material: aluminium cast / plastic
 Farbe: strukturweiß / colour: structure white
 Bestückung: 6x Hochleistungs-LED, Leistung: ca. 13,0W
 lamp: 6x high performance LED, power: approx. 13,0W
 schwenkbar / rotatable

Montage in Hohldecken mit Federbefestigung
 Installation into suspended ceilings by spring fixation

→ Konverter siehe Seite 450-451
 → converter see pages 450-451

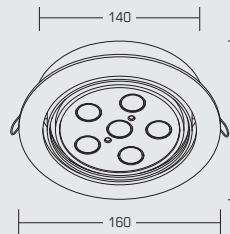
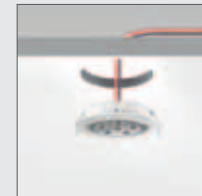

Art.-Nr. art.-no.	Lichtfarbe light colour	Farbtemperatur colour temperature	Linse lense	Preis € price €
R3006NW1	neutralweiß / neutral white	4100K	10°	229,00
R3006NW3	neutralweiß / neutral white	4100K	30°	229,00
R3006W1	kaltweiß / cold white	6500K	10°	229,00
R3006W3	kaltweiß / cold white	6500K	30°	229,00
R3006WW1	warmweiß / warm white	3100K	10°	229,00
R3006WW3	warmweiß / warm white	3100K	30°	229,00

LED-Einbaudownlight | LED recessed downlight

LED-Einbaudownlight | LED recessed downlight

H3011...



NEU new

LED-Einbaudownlight / LED recessed downlight

Material: Stahl / Aluminium / Kunststoff / material: steel / aluminium / plastic
 Farbe: weiß, Reflektor mattglanz silber / colour: white, reflector satin silver
 Bestückung: 1x Bridgelux-LED Einsatz, Leistung: ca. 21,6W
 lamp: 1x Bridgelux-LED insert, power: approx. 21,6W

Leuchte ist für 230V-Direktanschluss.
 luminaire for 230V-direct connection.
 inkl. Konverter / incl. converter

angebauter Geräteträger / built-on equipment rack

Auf Anfrage auch mit separatem Geräteträger (ET120mm) lieferbar.
 also available with separate equipment rack on request (installation depth 120mm).

Art.-Nr. art.-no.	Lichtfarbe light colour	Farbtemperatur colour temperature	Linse lense	Preis € price €
H3011NW	neutralweiß / neutral white	4100K	40°	298,00
H3011W	kaltweiß / cold white	6500K	40°	298,00
H3011WW	warmweiß / warm white	3100K	40°	298,00

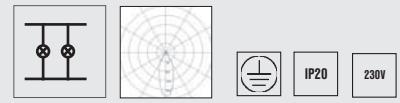

B145EWK



NEU new

Vorsatzelement für LED-Einbaudownlight Schutzscheibe, klar
 attachment element for LED recessed downlight safety disc, clear

Material: Stahl / Glas / material: steel / glass
 Farbe: weiß / colour: white

Maße: H 8mm - Ø 145mm
 dimensions: height 8mm - Ø 145mm

Mit dieser Schutzscheibe: Schutzart IP44 bei Einbau in geschlossenen Decken.
 With this safety disc: degree of protection IP44 by mounting in closed ceilings.

Art.-Nr. art.-no.	Preis € price €
B145EWK	40,60

IP44

B145EWT



NEU new

Vorsatzelement für LED-Einbaudownlight Schutzscheibe, teilmattiert
 attachment element for LED recessed downlight safety disc, partially frosted

Material: Stahl / Glas / material: steel / glass
 Farbe: weiß / colour: white

Maße: H 8mm - Ø 145mm
 dimensions: height 8mm - Ø 145mm

Mit dieser Schutzscheibe: Schutzart IP44 bei Einbau in geschlossenen Decken.
 With this safety disc: degree of protection IP44 by mounting in closed ceilings.

Art.-Nr. art.-no.	Preis € price €
B145EWT	40,60

IP44

B145EWM



NEU new

Vorsatzelement für LED-Einbaudownlight Schutzscheibe, vollmattiert
 attachment element for LED recessed downlight safety disc, completely frosted

Material: Stahl / Glas / material: steel / glass
 Farbe: weiß / colour: white

Maße: H 8mm - Ø 145mm / dimensions: height 8mm - Ø 145mm

Mit dieser Schutzscheibe: Schutzart IP44 bei Einbau in geschlossenen Decken.
 With this safety disc: degree of protection IP44 by mounting in closed ceilings.

Art.-Nr. art.-no.	Preis € price €
B145EWM	40,60

IP44

B145PWY

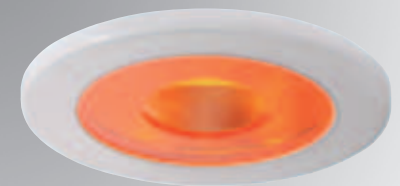

NEU new

Vorsatzelement für LED-Einbaudownlight, Prunellerring, orange
 attachment element for LED recessed downlight, prunella ring, orange

Material: Stahl / Kunststoff / material: steel / plastic
 Farbe: weiß / colour: white

Maße: H 8mm - Ø 145mm / dimensions: height 8mm - Ø 145mm

Art.-Nr. art.-no.	Preis € price €
B145PWY	32,20

IP20

B145SW2



NEU new

Vorsatzelement für LED-Einbaudownlight Floatglasscheibe, teilmattiert
 attachment element for LED recessed downlight floatglass disc, partially frosted

Material: Stahl / Glas / material: steel / glass
 Farbe: weiß / colour: white

Maße: H total 27mm - Ø 145mm / dimensions: height total 27mm - Ø 145mm

Art.-Nr. art.-no.	Preis € price €
B145SW2	38,90

IP20

B145ZWP

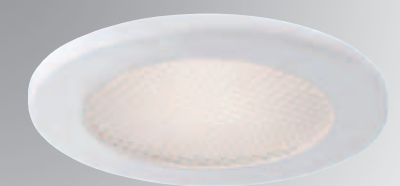

NEU new

Vorsatzelement für LED-Einbaudownlight Prismenscheibe
 attachment element for LED recessed downlight prism disc

Material: Stahl / Kunststoff / material: steel / plastic
 Farbe: weiß / colour: white

Maße: H 8mm - Ø 145mm / dimensions: height 8mm - Ø 145mm

Mit dieser Schutzscheibe: Schutzart IP44 bei Einbau in geschlossenen Decken.
 With this safety disc: degree of protection IP44 by mounting in closed ceilings.

Art.-Nr. art.-no.	Preis € price €
B145ZWP	28,80

IP44

MODULO ELECTRO
 www.modulelectro.ru

B3001...



NEU
new

LED-Deckeneinbaustrahler / LED recessed ceiling light

Material: Aluminium / material: aluminium
 Farbe: aluminium matt / colour: aluminium satin
 Bestückung: 1x QR111 Hochleistungs-LED Einsatz, Leistung: ca. 21,6 W
 lamp: 1x QR111 high performance-LED insert, power: approx. 21,6 W

dreh- und schwenkbar / pivotable and rotatable

→ Konverter siehe Seite 447
 → converter see pages 447



Art.-Nr. art.-no.	Lichtfarbe light colour	Farbtemperatur colour temperature	Reflektor reflector	Preis € price €
B3001NW	neutralweiß / neutral white	4100K	40°	289,00
B3001WW	warmweiß / warm white	3100K	40°	289,00

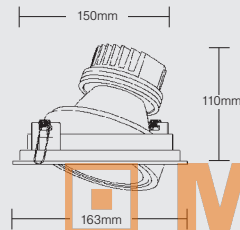
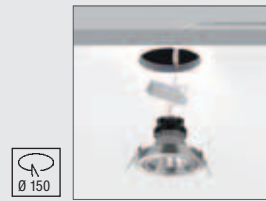

LED-Deckeneinbaudownlight / LED recessed ceiling downlight

Material: Metall-Acryl / material: metal-acryl
 Farbe: silber / colour: silver
 Bestückung: 12x Hochleistungs-LED, Leistung: ca. 17,0W
 lamp: 12x high performance LED, power: approx. 17,0W

Montage in Hohldecken mit Federbefestigung
 Installation into suspended ceilings by spring fixation



→ Konverter siehe Seite 450-451
 → converter see pages 450-451

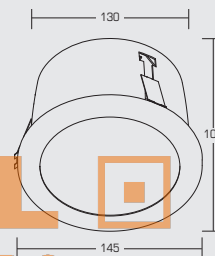

R3012...

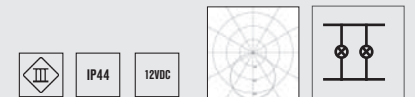

Art.-Nr. art.-no.	Lichtfarbe light colour	Farbtemperatur colour temperature	Preis € price €
R3012NW	neutralweiß / neutral white	4100K	309,00
R3012W	kaltweiß / cold white	6500K	309,00
R3012WW	warmweiß / warm white	3100K	309,00

B3002...



NEU
new

LED-Deckeneinbaustrahler / LED recessed ceiling light

Material: Aluminium / material: aluminium
 Farbe: aluminium matt / colour: aluminium satin
 Bestückung: 1x QR111 Hochleistungs-LED Einsatz, Leistung: ca. 21,6 W
 lamp: 1x QR111 high performance-LED insert, power: approx. 21,6 W

dreh- und schwenkbar / pivotable and rotatable

→ Konverter siehe Seite 447
 → converter see pages 447



Art.-Nr. art.-no.	Lichtfarbe light colour	Farbtemperatur colour temperature	Reflektor reflector	Preis € price €
B3002NW	neutralweiß / neutral white	4100K	40°	294,00
B3002WW	warmweiß / warm white	3100K	40°	294,00

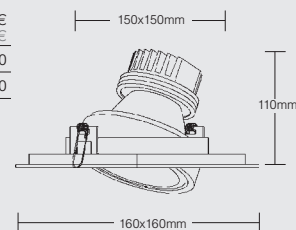
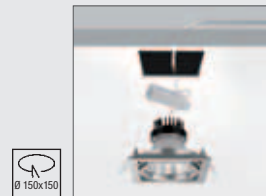

LED-Deckeneinbaudownlight / LED recessed ceiling downlight

Material: Metall-Acryl / material: metal-acryl
 Farbe: silber / colour: silver
 Bestückung: 12x Hochleistungs-LED, Leistung: ca. 17,0W
 lamp: 12x high performance LED, power: approx. 17,0W

Montage in Hohldecken mit Federbefestigung
 Installation into suspended ceilings by spring fixation



→ Konverter siehe Seite 450-451
 → converter see pages 450-451

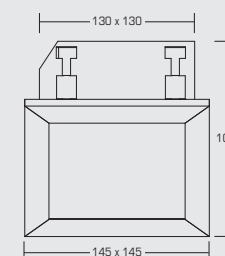

R3013...

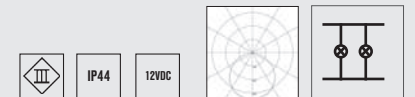
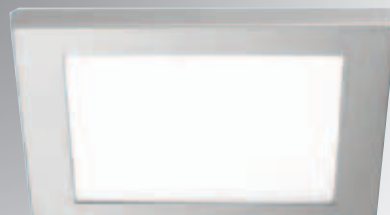

Art.-Nr. art.-no.	Lichtfarbe light colour	Farbtemperatur colour temperature	Preis € price €
R3013NW	neutralweiß / neutral white	4100K	309,00
R3013W	kaltweiß / cold white	6500K	309,00
R3013WW	warmweiß / warm white	3100K	309,00

www.modulelectro.ru

MODULO
ELECTRO

R3025...



LED-Deckenleuchte / LED ceiling light

Material: Edelstahl / Aluminium / Kunststoff
material: stainless steel / aluminium / plastic
Farbe: edelstahl / colour: stainless steel
Bestückung: 3x Hochleistungs-LED, Leistung: ca. 3,6W
lamp: 3x high performance LED, power: approx. 3,6W

Inkl. Hohlwand-Montagedose / incl. built-in box

Leuchte ist für 230V-Direktanschluss.
 luminaire for 230V-direct connection.
 inkl. Konverter / incl. converter



Art.-Nr. art-no.	Lichtfarbe light colour	Farbtemperatur colour temperature	Linse lense	Preis € price €
R3025NW2	neutralweiß / neutral white	4100K	25°	204,00
R3025NW4	neutralweiß / neutral white	4100K	45°	204,00
R3025NW6	neutralweiß / neutral white	4100K	60°	204,00
R3025W2	kaltweiß / cold white	6500K	25°	204,00
R3025W4	kaltweiß / cold white	6500K	45°	204,00
R3025W4	kaltweiß / cold white	6500K	60°	204,00
R3025WW2	warmweiß / warm white	3100K	25°	204,00
R3025WW4	warmweiß / warm white	3100K	45°	204,00
R3025WW6	warmweiß / warm white	3100K	60°	204,00

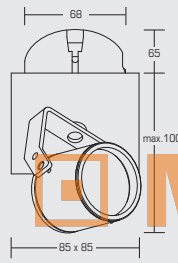

MODUL
ELECTRO
www.modulelectro.ru

R3026...

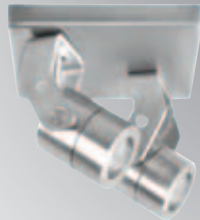

LED-Deckenleuchte / LED ceiling light

Material: Edelstahl / Aluminium / Kunststoff
material: stainless steel / aluminium / plastic
Farbe: edelstahl / colour: stainless steel
Bestückung: 2x Hochleistungs-LED, Leistung: ca. 2,0W
lamp: 2x high performance LED, power: approx. 2,0W

Inkl. Hohlwand-Montagedose / incl. built-in box

Leuchte ist für 230V-Direktanschluss.
 luminaire for 230V-direct connection.
 inkl. Konverter / incl. converter



Art.-Nr. art-no.	Lichtfarbe light colour	Farbtemperatur colour temperature	Linse lense	Preis € price €
R3026NW	neutralweiß / neutral white	4100K	10°	184,40
R3026W	kaltweiß / cold white	6500K	10°	184,40
R3026WW	warmweiß / warm white	3100K	10°	184,40

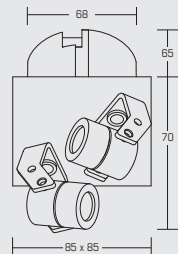

LED-Deckenspots | LED-ceiling lights

LED-Deckenspots | LED-ceiling lights

3380...

LED-Einbaufächenleuchte / LED ceiling light

Material: Aluminiumguss / Glas satiniert / material: aluminium cast / glass satin
 Farbe: silber matt / colour: silver satin
 Bestückung: 90x SMD-LED, Leistung: ca. 10,0 W
 lamp: 90x SMD-LED, power: ca. 10,0 W

Leuchte ist für 230V-Direktanschluss.
 luminaire for 230V-direct connection.
 inkl. sep. Konverter / incl. sep. converter

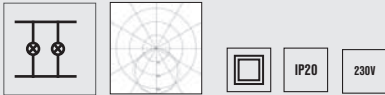

Art.-Nr. art-no.	Lichtfarbe light colour	Farbtemperatur colour temperatur	Preis € price €
3380NW	neutralweiß / neutral white	4100K	169,00
3380WW	warmweiß / warm white	3100K	169,00

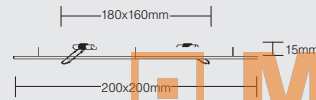

3383...

LED-Einbaufächenleuchte / LED ceiling light

Material: Aluminiumguss / Glas satiniert / material: aluminium cast / glass satin
 Farbe: silber matt / colour: silver satin
 Bestückung: 372x SMD-LED, Leistung: ca. 40,0 W
 lamp: 372x SMD-LED, power: ca. 40,0 W

geeignet für Rasterdecken 62,5 x 62,5cm (auf Anfrage für Rasterdecken 60x60cm)
 suitable for grid ceiling 62,5 x 62,5cm (on request for grid ceilings 60x60cm)

Leuchte ist für 230V-Direktanschluss.
 luminaire for 230V-direct connection.
 inkl. sep. Konverter / incl. sep. converter



Art.-Nr. art-no.	Lichtfarbe light colour	Farbtemperatur colour temperatur	Maße dimensions	Preis € price €
3383NW	neutralweiß / neutral white	4100K	62,5 x 62,5cm	649,00
3383WW	warmweiß / warm white	3100K	62,5 x 62,5cm	649,00

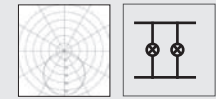

3381...

LED-Einbaufächenleuchte / LED ceiling light

Material: Aluminiumguss / Glas satiniert / material: aluminium cast / glass satin
 Farbe: silber matt / colour: silver satin
 Bestückung: 90x SMD-LED, Leistung: ca. 10,0 W
 lamp: 90x SMD-LED, power: ca. 10,0 W

Leuchte ist für 230V-Direktanschluss.
 luminaire for 230V-direct connection.
 inkl. sep. Konverter / incl. sep. converter



Art.-Nr. art-no.	Lichtfarbe light colour	Farbtemperatur colour temperatur	Preis € price €
3381NW	neutralweiß / neutral white	3100K	169,00
3381WW	warmweiß / warm white	4100K	169,00

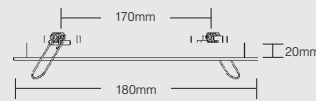
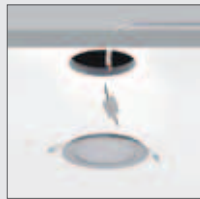

MODULO
ELECTRO

www.modulelectro.ru



2316LED



LED-Deckenaufbauleuchte / LED build-up ceiling light

Material: Edelstahl V4A / material: stainless steel V4A
 Farbe: edelstahl / colour: stainless steel
 Bestückung: 3x Hochleistungs-LED, Leistung: ca. 3,0W
 lamp: 3x high performance LED, power: approx. 3,0W

Leuchte ist für 230V-Direktanschluss.
 luminaire for 230V-direct connection.

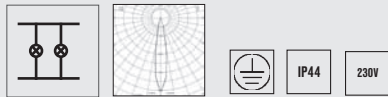
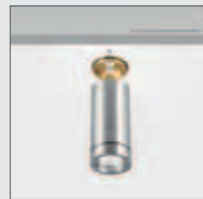

Art.-Nr. art-no.	Lichtfarbe light colour	Farbtemperatur colour temperatur	Preis € price €
2316LED	kaltweiß / cold white ●	6500K	143,20

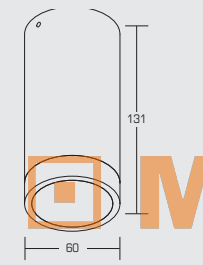

www.modulelectro.ru

LED-Deckenaufbauleuchte / LED build-up ceiling light

Material: Aluminium / material: aluminium
 Farbe: aluminium / colour: aluminium
 Bestückung: 3x Hochleistungs-LED, Leistung: ca. 3,6 W
 lamp: 3x high performance-LED, power: ca. 3,6 W

355° drehbar / 355° pivotable

230V-Direktanschluss inkl. Konverter / 230V-direct connexion incl. converter

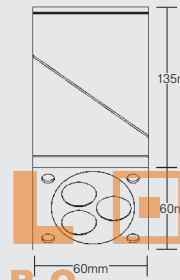

Art.-Nr. art-no.	Lichtfarbe light colour	Farbtemperatur colour temperature	Linse lense	Preis € price €
R3027NW4	neutralweiß / neutral white ●	4100K	40°	222,00
R3027W4	kaltweiß / cold white ●	6500K	40°	222,00
R3027WW4	warmweiß / warm white ●	3100K	40°	222,00

R3027...



NEU new



2315LED



LED-Deckenaufbauleuchte / LED build-up ceiling light

Material: Edelstahl V4A / material: stainless steel V4A
 Farbe: edelstahl / colour: stainless steel
 Bestückung: 3x Hochleistungs-LED, Leistung: ca. 3,0W
 lamp: 3x high performance LED, power: approx. 3,0W

Leuchte ist für 230V-Direktanschluss.
 luminaire for 230V-direct connection.



Art.-Nr. art-no.	Lichtfarbe light colour	Farbtemperatur colour temperatur	Preis € price €
2315LED	kaltweiß / cold white ●	6500K	194,80

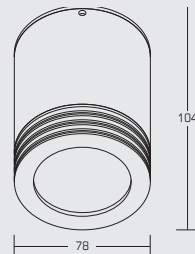

Dekorative LED-Aufbauleuchte / Decorative LED surface-mounted light

Material: Aluminium / material: aluminium
 Farbe: aluminium / colour: aluminium
 Bestückung: 1x Hochleistungs-LED Einsatz, Leistung: ca. 3,6W
 lamp: 2x high performance LED application, power: approx. 3,6W

Inkl. Konverter für 230V Direktanschluss
 Converter for direct connection 230V incl.

Leuchtenkopf dreh- und schwenkbar
 head of light rotatable and pivotable

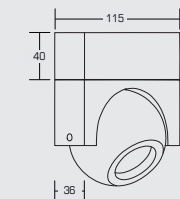

Art.-Nr. art-no.	Lichtfarbe light colour	Farbtemperatur colour temperature	Linse lense	Preis € price €
R3037NW4	neutralweiß / neutral white ●	4100K	40°	249,00
R3037W4	kaltweiß / cold white ●	6500K	40°	249,00
R3037WW4	warmweiß / warm white ●	3100K	40°	249,00

R3037...



NEU new



P3605...

LED-Lichtpunkt / LED-light point

Material: Kunststoff / material: plastic
 Farbe: alu glänzend / colour: aluminium bright
 Bestückung: 1x Hochleistungs-LED, Leistung: ca. 1,0W
 lamp: 1x high performance LED, power: approx. 1,0W

Montage in Hohlräume mit geringer Einbautiefe
 Installation into suspended ceilings with low installation depth

→ Konverter siehe Seite 442-445
 → converter see pages 442-445



Art.-Nr. art.-no.	Lichtfarbe light colour	Farbtemperatur colour temperature	Preis € price €
P3605W	kaltweiß / cold white	6500K	24,20
P3605WW	warmweiß / warm white	3100K	24,20
P3605B	blau / blue		24,20
P3605R	rot / red		24,20
P3605Y	orange / orange		24,20
P3605G	grün / green		24,20

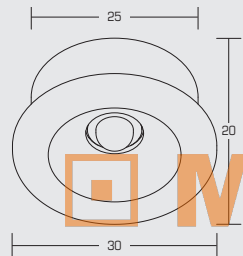
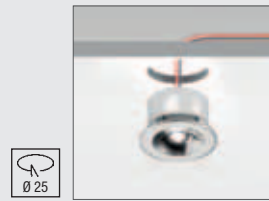

P3654...

LED-Lichtpunkt / LED-light point

Material: Kunststoff / material: plastic
 Farbe: alu glänzend / colour: aluminium bright
 Bestückung: 1x Hochleistungs-LED, Leistung: ca. 1,0W
 lamp: 1x high performance LED, power: approx. 1,0W

Montage in Hohlräume mit geringer Einbautiefe
 Installation into suspended ceilings with low installation depth



inkl. optischer Linse 10° / 10° optical lens incl.

→ Konverter siehe Seite 442-445
 → converter see pages 442-445

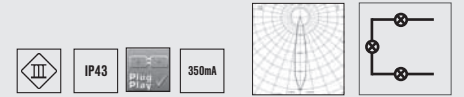

Art.-Nr. art.-no.	Lichtfarbe light colour	Farbtemperatur colour temperature	Linse lens	Preis € price €
P3654W	kaltweiß / cold white	6500K	10°	28,40
P3654WW	warmweiß / warm white	3100K	10°	28,40
P3654B	blau / blue		10°	28,40
P3654R	rot / red		10°	28,40
P3654Y	orange / orange		10°	28,40
P3654G	grün / green		10°	28,40

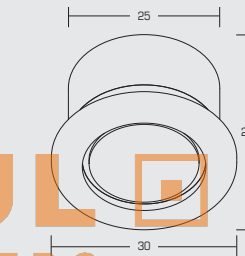

P3653...

LED-Lichtpunkt / LED-light point

Material: Kunststoff / material: plastic
 Farbe: alu glänzend / colour: aluminium bright
 Bestückung: 1x Hochleistungs-LED, Leistung: ca. 1,0W
 lamp: 1x high performance LED, power: approx. 1,0W

Montage in Hohlräume mit geringer Einbautiefe
 Installation into suspended ceilings with low installation depth

inkl. optischer Linse 30° / 30° optical lens incl.

→ Konverter siehe Seite 442-445
 → converter see pages 442-445



Art.-Nr. art.-no.	Lichtfarbe light colour	Farbtemperatur colour temperature	Linse lens	Preis € price €
P3653W	kaltweiß / cold white	6500K	30°	28,40
P3653WW	warmweiß / warm white	3100K	30°	28,40
P3653B	blau / blue		30°	28,40
P3653R	rot / red		30°	28,40
P3653Y	orange / orange		30°	28,40
P3653G	grün / green		30°	28,40

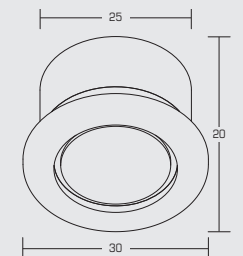
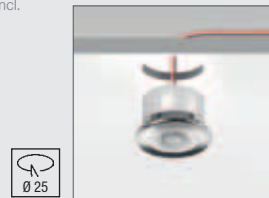

www.modulelectro.ru

LED-Lichtpunkt / LED-light point

Material: Edelstahl-Glas satiniert / material: stainless steel - glass satin
 Farbe: edelstahl / colour: stainless steel
 Bestückung: 1x Hochleistungs-LED, Leistung: ca. 1,0W
 lamp: 1x high performance LED, power: approx. 1,0W

Montage in Hohldecken mit Blattfeder
 installation in suspended ceilings by leaf spring fixation



→ Konverter siehe Seite 442-445
 → converter see pages 442-445

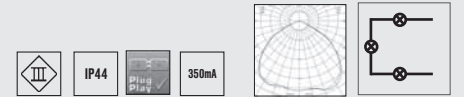

Art.-Nr. art.-no.	Lichtfarbe light colour	Farbtemperatur colour temperature	Preis € price €
P3659W	kaltweiß / cold white	6500K	68,30
P3659WW	warmweiß / warm white	3100K	68,30
P3659B	blau / blue		68,30
P3659R	rot / red		68,30
P3659Y	orange / orange		68,30
P3659G	grün / green		68,30

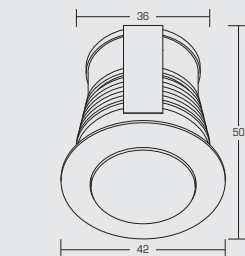

P3659...



P3650...

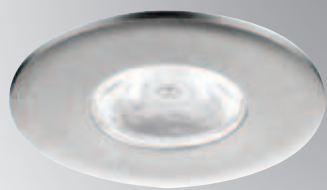

LED-Lichtpunkt / LED-light point

Material: Messing / material: brass
 Farbe: chrom matt / colour: chrome satin
 Bestückung: 1x Hochleistungs-LED, Leistung: ca. 1,0W
 lamp: 1x high performance LED, power: approx. 1,0W

Montage in Hohldecken mit Federbefestigung
 Installation into suspended ceilings by spring fixation

inkl. optischer Linse 10° / 10° optical lens incl.

→ Konverter siehe Seite 442-445
 → converter see pages 442-445



Art.-Nr. art.-no.	Lichtfarbe light colour	Farbtemperatur colour temperature	Linse lense	Preis € price €
P3650W	kaltweiß / cold white	6500K	10°	67,10
P3650WW	warmweiß / warm white	3100K	10°	67,10
P3650B	blau / blue		10°	67,10
P3650R	rot / red		10°	67,10
P3650Y	orange / orange		10°	67,10
P3650G	grün / green		10°	67,10

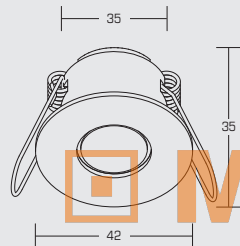

MODUL
ELECTRO
www.modulelectro.ru

P3651...



LED-Lichtpunkt / LED-light point

Material: Messing / material: brass
 Farbe: chrom matt / colour: chrome satin
 Bestückung: 1x Hochleistungs-LED, Leistung: ca. 1,0W
 lamp: 1x high performance LED, power: approx. 1,0W

Montage in Hohldecken mit Federbefestigung
 Installation into suspended ceilings by spring fixation

inkl. optischer Linse 10° / 10° optical lens incl.

→ Konverter siehe Seite 442-445
 → converter see pages 442-445



Art.-Nr. art.-no.	Lichtfarbe light colour	Farbtemperatur colour temperature	Linse lense	Preis € price €				
P3651W	kaltweiß / cold white	6500K	10°	67,10				
P3651WW	warmweiß / warm white	3100K	10°	67,10				
P3651B	blau / blue		10°	67,10				
P3651R	rot / red		10°	67,10				
P3651Y	orange / orange		10° </tr <tr> <td>P3651G</td> <td>grün / green</td> <td></td> <td>10°</td> <td>67,10</td> </tr>	P3651G	grün / green		10°	67,10
P3651G	grün / green		10°	67,10				

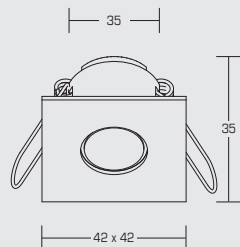

Senckenberg Museum, Frankfurt

P3834...

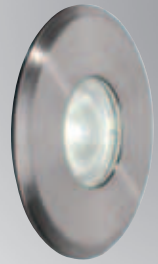

LED-Lichtpunkt / LED-light point

Material: Edelstahl V4A / Glas / material: stainless steel V4A / glass
 Farbe: edelstahl / colour: stainless steel
 Bestückung: 1x Hochleistungs-LED, Leistung: ca. 1,5 W
 lamp: 1x high performance-LED, power: ca. 1,5 W

Montage in Hohlräumen mit Blattfeder
 installation in suspended ceilings by leaf spring fixation

- passende 12V-Konverter siehe Seite 450-451
- compatible 12V-converter see pages 450-451

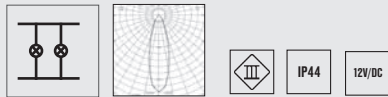
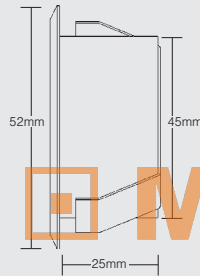

Art.-Nr. art-no.	Lichtfarbe light colour	Farbtemperatur colour temperature	Linse lense	Preis € price €
P3834NW	neutralweiß / neutral white ●	4100K	30°	82,00

3833

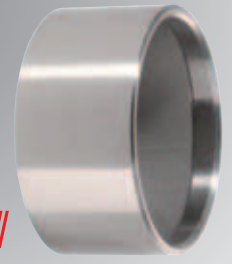

Aufputzgehäuse / wall-mounted box

für die Leuchten P3834NW und P3835NW
 for the lights P3834NW and P3835NW

Material: Edelstahl V4A / material: stainless steel V4A
 Farbe: edelstahl / colour: stainless steel

Befestigung mit Schraubenmontage / mounting with screws



Art.-Nr. art-no.	Preis € price €
3833	24,00

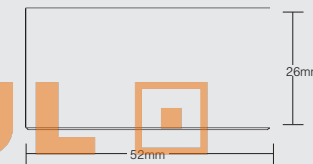

MODULO
ELECTRO

www.modulelectro.ru

P3835...

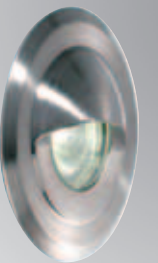

LED-Lichtpunkt / LED-light point

Material: Edelstahl V4A / Glas / material: stainless steel V4A / glass
 Farbe: edelstahl / colour: stainless steel
 Bestückung: 1x Hochleistungs-LED, Leistung: ca. 1,5 W
 lamp: 1x high performance-LED, power: ca. 1,5 W

Montage in Hohlräumen mit Blattfeder
 installation in suspended ceilings by leaf spring fixation

- passende 12V-Konverter siehe Seite 450-451
- compatible 12V-converter see pages 450-451

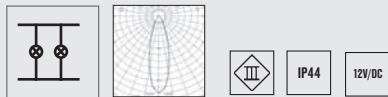
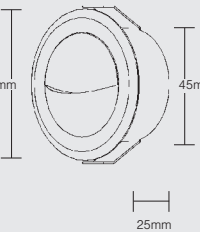

Art.-Nr. art-no.	Lichtfarbe light colour	Farbtemperatur colour temperature	Linse lense	Preis € price €
P3835NW	neutralweiß / neutral white ●	4100K	30°	84,00



P3680...

LED-Lichtpunkt / LED-light point

Material: Aluminium / Kunststoff / material: aluminium / plastic
 Farbe: aluminium / colour: aluminium
 Bestückung: 1x Hochleistungs-LED, Leistung: ca. 1,0W
 lamp: 1x high performance LED, power: approx. 1,0W
 schwenkbar / rotatable

Montage in Hohldecken mit Federbefestigung
 Installation into suspended ceilings by spring fixation

inkl. optischer Linse 38° / 38° optical lens incl.

→ Konverter siehe Seite 442-445
 → converter see pages 442-445



Art.-Nr. art-no.	Lichtfarbe light colour	Farbtemperatur light temperature	Linse lense	Preis € price €
P3680NW	neutralweiß / neutral white ●	4100K	38°	36,80

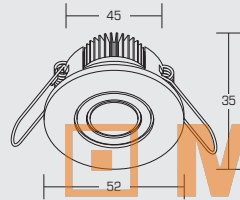

P3682...

LED-Lichtpunkt / LED-light point

Material: Aluminium / Kunststoff / material: aluminium / plastic
 Farbe: aluminium / colour: aluminium
 Bestückung: 1x Hochleistungs-LED, Leistung: ca. 1,0W
 lamp: 1x high performance LED, power: approx. 1,0W
 schwenkbar / rotatable

Montage in Hohldecken mit Federbefestigung
 Installation into suspended ceilings by spring fixation

inkl. optischer Linse 38° / 38° optical lens incl.

→ Konverter siehe Seite 442-445
 → converter see pages 442-445

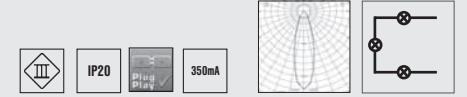

Art.-Nr. art-no.	Lichtfarbe light colour	Farbtemperatur colour temperature	Linse lense	Preis € price €
P3682NW	neutralweiß / neutral white ●	4100K	38°	41,00

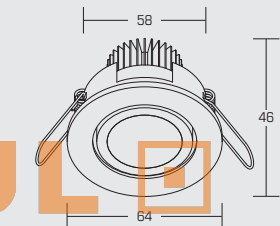

www.modulelectro.ru

P3681...

LED-Lichtpunkt / LED-light point

Material: Aluminium / Kunststoff / material: aluminium / plastic
 Farbe: aluminium / colour: aluminium
 Bestückung: 1x Hochleistungs-LED, Leistung: ca. 1,0W
 lamp: 1x high performance LED, power: approx. 1,0W
 schwenkbar / rotatable

Montage in Hohldecken mit Federbefestigung
 Installation into suspended ceilings by spring fixation

inkl. optischer Linse 38° / 38° optical lens incl.

→ Konverter siehe Seite 442-445
 → converter see pages 442-445



Art.-Nr. art-no.	Lichtfarbe light colour	Farbtemperatur light temperature	Linse lense	Preis € price €
P3681NW	neutralweiß / neutral white ●	4100K	38°	38,90

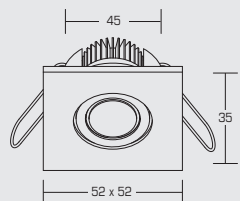
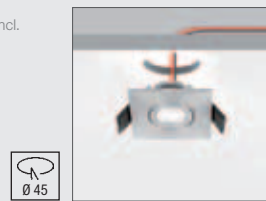

P3683...

LED-Deckenleuchte / LED ceiling lights

Material: Aluminium / Kunststoff / material: aluminium / plastic
 Farbe: aluminium / colour: aluminium
 Bestückung: 1x Hochleistungs-LED, Leistung: ca. 1,0W
 lamp: 1x high performance LED, power: approx. 1,0W
 schwenkbar / rotatable

Montage in Hohldecken mit Federbefestigung
 Installation into suspended ceilings by spring fixation

inkl. optischer Linse 38° / 38° optical lens incl.

→ Konverter siehe Seite 442-445
 → converter see pages 442-445

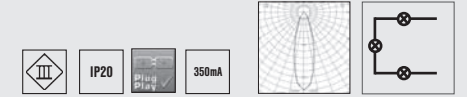

Art.-Nr. art-no.	Lichtfarbe light colour	Farbtemperatur colour temperature	Linse lense	Preis € price €
P3683NW	neutralweiß / neutral white ●	4100K	38°	43,10

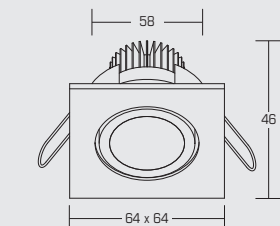

P3301W3

LED-Lichtpunkte 3er-Set / LED lightpoints pack of 3

Material: Kunststoff / material: plastic
 Farbe: alu glänzend / colour: aluminium bright
 Bestückung: je 1x Hochleistungs-LED, Leistung: je ca. 1,0W
 lamp: each 1x high performance LED, power: each approx. 1,0W

inkl. optischer Linse 10° / 10° optical lens incl.
 inkl. 50 cm Anschlussleitung / 50 cm connecting cable incl.
 Verteiler mit Stecksystem / splitter with plug system

Leuchten sind für 230V-Direktanschluss.
 luminaires for 230V-direct connection
 inkl. sep. Konverter / incl. sep. converter

inkl. Installationsanweisung
 installation instructions incl.
 inkl. 3-fach Verteiler / triple cable splitter incl.
 inkl. Verbindungsleitungen
 connecting cables incl.
 inkl. Konverter (52x26x22mm)
 converter incl.

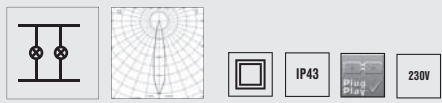
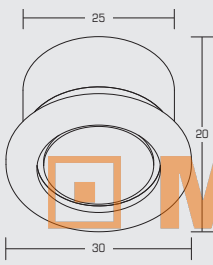
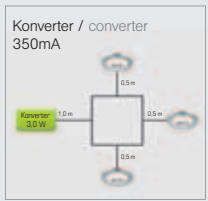

Art.-Nr. art-no.	Lichtfarbe light colour	Farbtemperatur colour temperature	Linse lens	Preis € price €
P3301W3	kaltweiß / cold white ●	6500K	10°	117,90

P3302W3

LED-Lichtpunkte 3er-Set / LED lightpoints pack of 3

Material: Aluminium / Kunststoff material: aluminium / plastic
 Farbe: aluminium / colour: aluminium
 Bestückung: je 1x Hochleistungs-LED, Leistung: je ca. 1,0W
 lamp: each 1x high performance LED, power: each approx. 1,0W

inkl. optischer Linse 15° / 15° optical lens incl.
 inkl. 50 cm Anschlussleitung / 50 cm connecting cable incl.
 Verteiler mit Stecksystem / splitter with plug system

Leuchten sind für 230V-Direktanschluss.
 luminaires for 230V-direct connection
 inkl. sep. Konverter / incl. sep. converter

inkl. Installationsanweisung
 installation instructions incl.
 inkl. 3-fach Verteiler / triple cable splitter incl.
 inkl. Verbindungsleitungen
 connecting cables incl.
 inkl. Konverter (52x26x22mm) / converter incl.

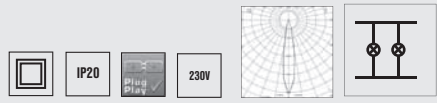
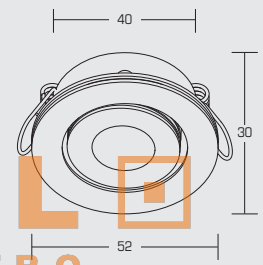
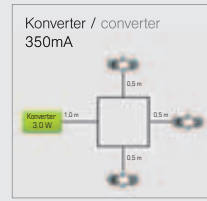

Art.-Nr. art-no.	Lichtfarbe light colour	Farbtemperatur colour temperature	Linse lens	Preis € price €
P3302W3	kaltweiß / cold white ●	6500K	15°	170,90

P3301W3

LED-Lichtpunkte 6er-Set / LED lightpoints pack of 6

Material: Kunststoff / material: plastic
 Farbe: alu glänzend / colour: aluminium bright
 Bestückung: je 1x Hochleistungs-LED, Leistung: je ca. 1,0W
 lamp: each 1x high performance LED, power: each approx. 1,0W

inkl. optischer Linse 10° / 10° optical lens incl.
 inkl. 50 cm Anschlussleitung / 50 cm connecting cable incl.
 Verteiler mit Stecksystem / splitter with plug system

Leuchten sind für 230V-Direktanschluss.
 luminaires for 230V-direct connection
 inkl. sep. Konverter / incl. sep. converter

inkl. Installationsanweisung
 installation instructions incl.
 inkl. 6-fach Verteiler / sixfold cable splitter incl.
 inkl. Verbindungsleitungen
 connecting cables incl.
 inkl. Konverter (115x34x19mm)
 converter incl.

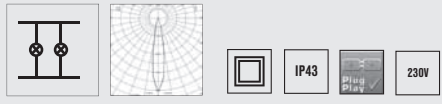
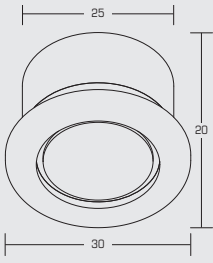
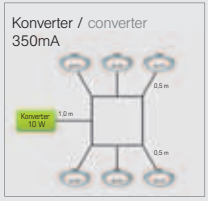

Art.-Nr. art-no.	Lichtfarbe light colour	Farbtemperatur colour temperature	Linse lens	Preis € price €
P3301W6	kaltweiß / cold white ●	6500K	10°	200,10

P3302W6

LED-Lichtpunkte 6er-Set / LED lightpoints pack of 6

Material: Aluminium / Kunststoff material: aluminium / plastic
 Farbe: aluminium / colour: aluminium
 Bestückung: je 1x Hochleistungs-LED, Leistung: je ca. 1,0W
 lamp: each 1x high performance LED, power: each approx. 1,0W

inkl. optischer Linse 15° / 15° optical lens incl.
 inkl. 50 cm Anschlussleitung / 50 cm connecting cable incl.
 Verteiler mit Stecksystem / splitter with plug system

Leuchten sind für 230V-Direktanschluss.
 luminaires for 230V-direct connection
 inkl. sep. Konverter / incl. sep. converter

inkl. Installationsanweisung
 installation instructions incl.
 inkl. 6-fach Verteiler / sixfold cable splitter incl.
 inkl. Verbindungsleitungen
 connecting cables incl.
 inkl. Konverter (52x26x22mm) / converter incl.

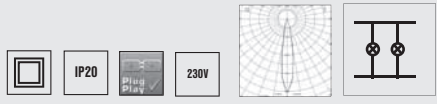
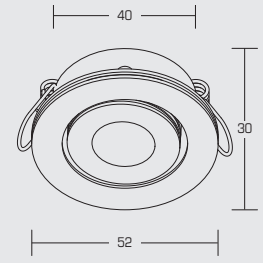
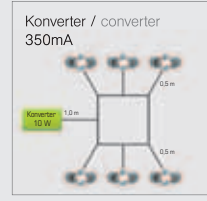

Art.-Nr. art-no.	Lichtfarbe light colour	Farbtemperatur colour temperature	Linse lens	Preis € price €
P3302W6	kaltweiß / cold white ●	6500K	15°	301,80



www.modulelectro.ru

LED Effekt-Lichtpunkte | LED effect-light points

LED Effekt-Lichtpunkte | LED effectlight points

P3719...



Effekt-Lichtpunkt / effect lightpoint

Material: Aluminium-Kristall / material: aluminium-crystal
 Bestückung: 1x Hochleistungs-LED, Leistung: ca. 1,0W
 lamp: 1x high performance LED, power: approx. 1,0W

Montage in Hohldecken mit Federbefestigung
 Installation into suspended ceilings by spring fixation.

→ Konverter siehe Seite 442-445
 → converter see pages 442-445

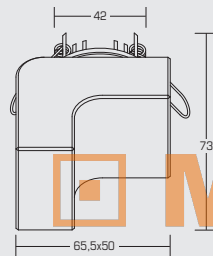

Art.-Nr. art.-no.	Lichtfarbe light colour	Farbtemperatur colour temperatur	Preis € price €
P3719W	kaltweiß / cold white	6500K	46,00
P3719WW	warmweiß / warm white	3100K	46,00
P3719B	blau / blue		46,00
P3719R	rot / red		46,00
P3719Y	orange / orange		46,00
P3719G	grün / green		46,00

P3721...



Effekt-Lichtpunkt / effect lightpoint

Material: Aluminium-Kristall / material: aluminium-crystal
 Bestückung: 1x Hochleistungs-LED, Leistung: ca. 1,0W
 lamp: 1x high performance LED, power: approx. 1,0W

Montage in Hohldecken mit Federbefestigung
 Installation into suspended ceilings by spring fixation.

→ Konverter siehe Seite 442-445
 → converter see pages 442-445

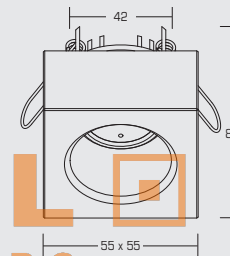

Art.-Nr. art.-no.	Lichtfarbe light colour	Farbtemperatur colour temperatur	Preis € price €
P3721W	kaltweiß / cold white	6500K	46,00
P3721WW	warmweiß / warm white	3100K	46,00
P3721B	blau / blue		46,00
P3721R	rot / red		46,00
P3721Y	orange / orange		46,00
P3721G	grün / green		46,00

P3718...



Effekt-Lichtpunkt / effect lightpoint

Material: Aluminium-Kristall / material: aluminium-crystal
 Bestückung: 1x Hochleistungs-LED, Leistung: ca. 1,0W
 lamp: 1x high performance LED, power: approx. 1,0W

Montage in Hohldecken mit Federbefestigung
 Installation into suspended ceilings by spring fixation.

→ Konverter siehe Seite 442-445
 → converter see pages 442-445

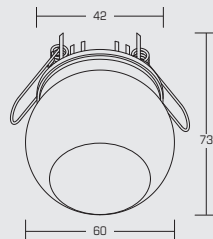

Art.-Nr. art.-no.	Lichtfarbe light colour	Farbtemperatur colour temperatur	Preis € price €
P3718W	kaltweiß / cold white	6500K	42,00
P3718WW	warmweiß / warm white	3100K	42,00
P3718B	blau / blue		42,00
P3718R	rot / red		42,00
P3718Y	orange / orange		42,00
P3718G	grün / green		42,00

Effekt-Lichtpunkt / effect lightpoint

Material: Aluminium-Acryl / material: aluminium-acryl
 Bestückung: 1x Hochleistungs-LED, Leistung: ca. 1,0W
 lamp: 1x high performance LED, power: approx. 1,0W

Montage in Hohldecken mit Federbefestigung
 Installation into suspended ceilings by spring fixation.

→ Konverter siehe Seite 442-445
 → converter see pages 442-445

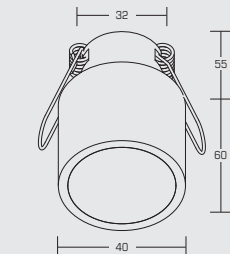

Art.-Nr. art.-no.	Lichtfarbe light colour	Farbtemperatur colour temperatur	Preis € price €
P3669W	kaltweiß / cold white	6500K	47,70
P3669WW	warmweiß / warm white	3100K	47,70
P3669B	blau / blue		47,70
P3669R	rot / red		47,70
P3669Y	orange / orange		47,70
P3669G	grün / green		47,70

P3669...

www.modulelectro.ru

MODUL
ELECTRO

P3647...



Ein- und Aufbau-Minispot / recessed and surface mounted-minispot

Material: Guss / Kunststoff material: cast / plastic
 Farbe: titan / colour: titanium
 Bestückung: 1x Hochleistungs-LED, Leistung: ca. 1,0W
 lamp: 1x high performance LED, power: approx. 1,0W

Montage in Hohldecken mit Blattfederbefestigung bzw. Aufbau über separates Gehäuse
 Installation into suspended ceilings by spring fixation or by means of surface-mounting by separate housing

inkl. optischer Linse 15° / 15° optical lens incl.

→ Konverter siehe Seite 442-445
 → converter see pages 442-445

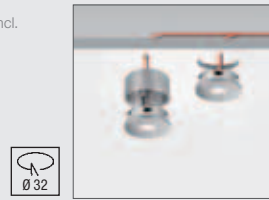

Art.-Nr. art-no.	Lichtfarbe light colour	Farbtemperatur colour temperature	Linse lense	Preis € price €
P3647W	kaltweiß / cold white ●	6500K	10°	46,40

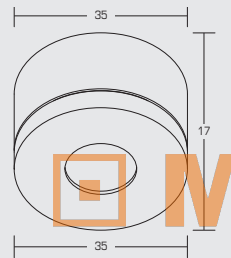

P3648...



Ein- und Aufbau-Minispot / recessed and surface mounted-minispot

Material: Guss / Kunststoff material: cast / plastic
 Bestückung: 1x Hochleistungs-LED, Leistung: ca. 1,0W
 lamp: 1x high performance LED, power: approx. 1,0W

Montage in Hohldecken mit Blattfederbefestigung bzw. Aufbau über separates Gehäuse
 Installation into suspended ceilings by spring fixation or by means of surface-mounting by separate housing

inkl. optischer Linse 15° / 15° optical lens incl.

→ Konverter siehe Seite 442-445
 → converter see pages 442-445

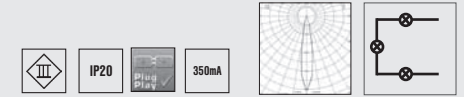

Art.-Nr. art-no.	Lichtfarbe light colour	Farbtemperatur colour temperature	Linse lense	Preis € price €
P3648W	kaltweiß / cold white ●	6500K	15°	46,40

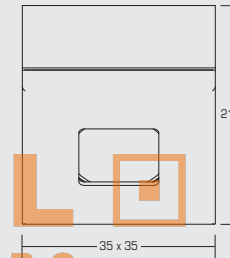

P3649...



Ein- und Aufbau-Minispot / recessed and surface mounted-minispot

Material: Guss / Kunststoff material: cast / plastic
 Farbe: titan / colour: titanium
 Bestückung: 1x Hochleistungs-LED, Leistung: ca. 1,0W
 lamp: 1x high performance LED, power: approx. 1,0W
 schwenkbar / rotatable

Montage in Hohldecken mit Blattfederbefestigung bzw. Aufbau über separates Gehäuse
 Installation into suspended ceilings by spring fixation or by means of surface-mounting by separate housing

inkl. optischer Linse 15° / 15° optical lens incl.

→ Konverter siehe Seite 442-445
 → converter see pages 442-445

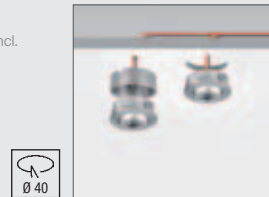

Art.-Nr. art-no.	Lichtfarbe light colour	Farbtemperatur colour temperature	Linse lense	Preis € price €
P3649W	kaltweiß / cold white ●	6500K	10°	67,00

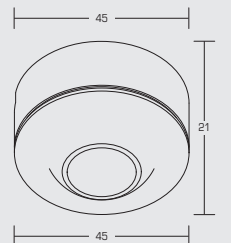

MODUL
ELECTRO
www.modulelectro.ru



P3645...

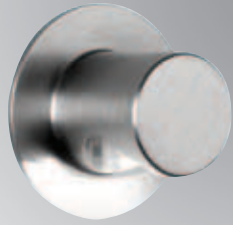

LED-Wandeinbauleuchte / LED-recessed wall luminaire

Material: Messing / material: brass
 Farbe: chrom matt / colour: chrome satin
 Bestückung: 1x Hochleistungs-LED, Leistung: ca. 1,0W
 lamp: 1x high performance LED, power: approx. 1,0W

inkl. Hohlwand-Montagedose 35 mm Ø / ET40
 Built-in box 35 mm Ø / installation depth 40 mm incl.

→ Konverter siehe Seite 442-445
 → converter see pages 442-445

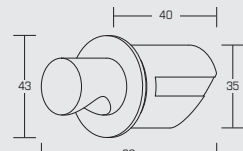

Art.-Nr. art.-no.	Lichtfarbe light colour	Farbtemperatur colour temperatur	Preis € price €
P3645W	kaltweiß / cold white	6500K	91,40
P3645WW	warmweiß / warm white	3100K	91,40
P3645B	blau / blue		91,40
P3645R	rot / red		91,40
P3645Y	orange / orange		91,40
P3645G	grün / green		91,40

MODUL
ELECTRO
www.modulelectro.ru

P3626...

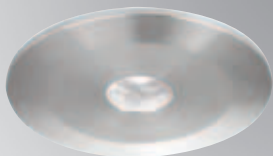

LED-Einbauleuchte / LED-recessed luminaire

Material: Edelstahl / Messing / material: stainless steel-brass
 Farbe: edelstahl / colour: stainless steel
 Bestückung: 1x Hochleistungs-LED, Leistung: ca. 1,0W
 lamp: 1x high performance LED, power: approx. 1,0W

inkl. Hohlwand-Montagedose 35 mm Ø / ET40
 Built-in box 35 mm Ø / installation depth 40 mm incl.

→ Konverter siehe Seite 442-445
 → converter see pages 442-445

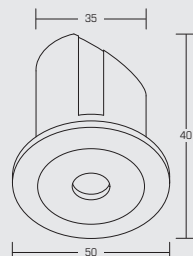
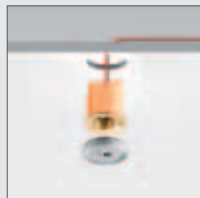

Art.-Nr. art.-no.	Lichtfarbe light colour	Farbtemperatur colour temperatur	Preis € price €
P3626W	kaltweiß / cold white	6500K	99,00
P3626WW	warmweiß / warm white	3100K	99,00
P3626B	blau / blue		99,00
P3626R	rot / red		99,00
P3626Y	orange / orange		99,00
P3626G	grün / green		99,00



LED-Möbeleinbauleuchten | LED-recessed furniture lights

LED-Möbeleinbauleuchten | LED-recessed furniture lights

2445.15...



NEU
new

LED-Möbeleinbauleuchte / LED-recessed furniture light
 Material: Guss / Kunststoff / Glas mattiert / material: cast / plastic / glas satin
 Farbe: titan / colour: titanium
 Bestückung: 1x Flächen-Hochleistungs-LED, Leistung: ca. 4,0 W
 lamp: 1x plain - high performance-LED, power: ca. 4,0 W
 → Konverter siehe Seite 450-451
 → converter see pages 450-451



Art.-Nr. art-no.	Lichtfarbe light colour	Farbtemperatur colour temperature	Preis € price €
2445.15W	kaltweiß / cold white	6500K	96,00
2445.15WW	warmweiß / warm white	3100K	96,00

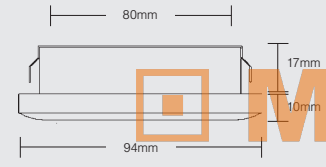

2446.15...

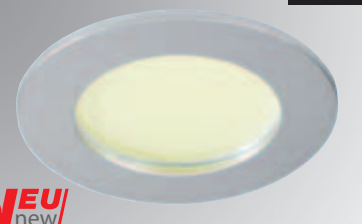

NEU
new

LED-Möbeleinbauleuchte / LED-recessed furniture light
 Material: Guss / Kunststoff / Glas mattiert / material: cast / plastic / glas satin
 Farbe: titan / colour: titanium
 Bestückung: 1x Flächen-Hochleistungs-LED, Leistung: ca. 2,5 W
 lamp: 1x plain - high performance-LED, power: ca. 2,5 W
 Zeichen: F, MM / sign: F, MM
 → Konverter siehe Seite 450-451
 → converter see pages 450-451



→ Konverter siehe Seite 450-451
 → converter see pages 450-451

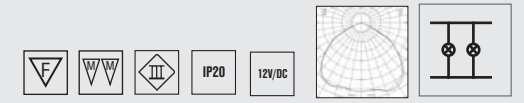

Art.-Nr. art-no.	Lichtfarbe light colour	Farbtemperatur colour temperature	Preis € price €
2446.15W	kaltweiß / cold white	6500K	78,00
2446.15WW	warmweiß / warm white	3100K	78,00

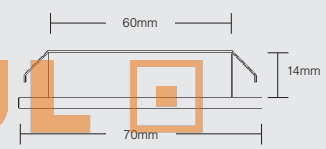

2444.15...



NEU
new

LED-Möbeleinbauleuchte / LED-recessed furniture light
 Material: Guss / Kunststoff / Glas mattiert / material: cast / plastic / glas satin
 Farbe: titan / colour: titanium
 Bestückung: 1x Flächen-Hochleistungs-LED, Leistung: ca. 4,0 W
 lamp: 1x plain - high performance-LED, power: ca. 4,0 W
 → Konverter siehe Seite 450-451
 → converter see pages 450-451



Art.-Nr. art-no.	Lichtfarbe light colour	Farbtemperatur colour temperature	Preis € price €
2444.15W	kaltweiß / cold white	6000K	98,00
2444.15WW	warmweiß / warm white	3100K	98,00

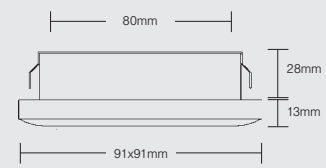

www.modulelectro.ru



P2037...



LED-Möbeleinbaustrahler / LED-recessed furniture light

Material: Edelstahl-Glas klar / material: stainless steel - glass clear
 Farbe: edelstahl / colour: stainless steel
 Bestückung: 1x Hochleistungs-LED, Leistung: ca. 1,0W
 lamp: 1x high performance LED, power: approx. 1,0W
 schwenkbar / rotatable

Montage in Hohlräumen mit Blattfeder
 installation in suspended ceilings by leaf spring fixation

→ Konverter siehe Seite 442-445
 → converter see pages 442-445



Art.-Nr. art.-no.	Lichtfarbe light colour	Farbtemperatur colour temperature	Preis € price €
P2037W	kaltweiß / cold white	6500K	69,00
P2037WW	warmweiß / warm white	3100K	69,00

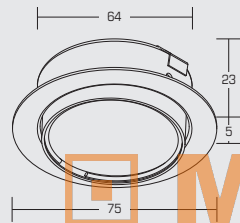

MODUL
ELECTRO
www.modulelectro.ru

P2269...



LED-Deckeneinbaulichtpunkt / LED-ceiling light point

Material: Guss / material: cast
 Farbe: nickel matt / colour: nickel satin
 Bestückung: 1x Hochleistungs-LED, Leistung: ca. 1,0W
 lamp: 1x high performance LED, power: approx. 1,0W
 schwenkbar / rotatable

inkl. optischer Linse 15° / 15° optical lens incl.

Montage in Hohldecken mit Federbefestigung
 Installation in hollow ceilings by leaf spring fixation

→ Konverter siehe Seite 442-445
 → converter see pages 442-445

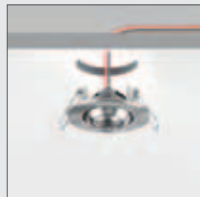

Art.-Nr. art.-no.	Lichtfarbe light colour	Farbtemperatur colour temperature	Linse lens	Preis € price €
P2269W	kaltweiß / cold white	6500K	15°	45,60
P2269WW	warmweiß / warm white	3100K	15°	45,60

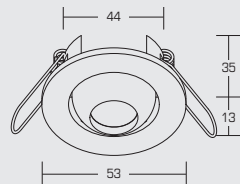

LED-Wandeinbauleuchten | LED-recessed wall lights

LED-Wandeinbauleuchten | LED-recessed wall lights

R3940...

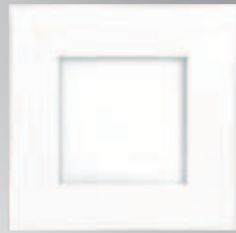

LED-Wandeinbauleuchte / LED-recessed wall light

Material: Edelstahl / Acryl opal / material: stainless steel / acryl opal
 Farbe: struktur weiß / colour: structure white
 Bestückung: 1x Hochleistungs-LED, Leistung: ca. 1,2W
 lamp: 1x high performance LED, power: approx. 1,2W

inkl. Konverter für 230V Direktanschluss / Converter for direct connection 230V incl.
 inkl. Hohlwand-Montagedose 68 mm Ø/ET65
 Built-in box 68 mm Ø / installation depth 65 mm incl.
 inkl. BJB-Wechselfassung
 incl. BJB-removable LED socket

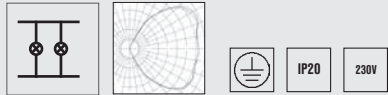

Art.-Nr. art-no.	Lichtfarbe light colour	Farbtemperatur colour temperature	Preis € price €
R3940W	kaltweiß / cold white	6500K	95,00
R3940WW	warmweiß / warm white	3100K	95,00
R3940B	blau / blue		95,00
R3940R	rot / red		95,00
R3940Y	orange / orange		95,00
R3940G	grün / green		95,00

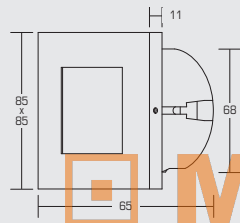

P3930...



LED-Wandeinbauleuchte / recessed wall lamp

Material: Edelstahl / Acryl opal / material: stainless steel / acryl opal
 Farbe: edelstahl / colour: stainless steel
 Bestückung: 1x Hochleistungs-LED, Leistung: ca. 1,0W
 lamp: 1x high performance LED, power: approx. 1,0W

inkl. Konverter für 230V Direktanschluss / Converter for direct connection 230V incl.
 inkl. Hohlwand-Montagedose 68 mm Ø/ET65
 Built-in box 68 mm Ø / installation depth 65 mm incl.



Art.-Nr. art-no.	Lichtfarbe light colour	Farbtemperatur colour temperature	Preis € price €
P3930W	kaltweiß / cold white	6500K	104,00
P3930WW	warmweiß / warm white	3100K	104,00
P3930B	blau / blue		104,00
P3930R	rot / red		104,00
P3930Y	orange / orange		104,00
P3930G	grün / green		104,00

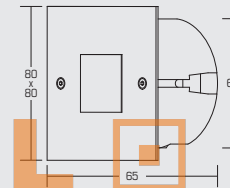

MODUL ELECTRO
www.modulelectro.ru

R3941...



LED-Wandeinbauleuchte / LED-recessed wall light

Material: Edelstahl / Acryl opal / material: stainless steel / acryl opal
 Farbe: struktur weiß / colour: structure white
 Bestückung: 1x Hochleistungs-LED, Leistung: ca. 1,2W
 lamp: 1x high performance LED, power: approx. 1,2W

inkl. Konverter für 230V Direktanschluss / Converter for direct connection 230V incl.
 inkl. Hohlwand-Montagedose 68 mm Ø/ET65
 Built-in box 68 mm Ø / installation depth 65 mm incl.
 inkl. BJB-Wechselfassung
 incl. BJB-removable LED socket

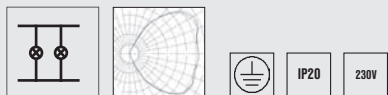
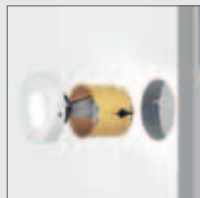

Art.-Nr. art-no.	Lichtfarbe light colour	Farbtemperatur colour temperature	Preis € price €
R3941W	kaltweiß / cold white	6500K	95,00
R3941WW	warmweiß / warm white	3100K	95,00
R3941B	blau / blue		95,00
R3941R	rot / red		95,00
R3941Y	orange / orange		95,00
R3941G	grün / green		95,00

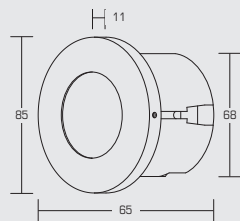

P3937...



LED-Wandeinbauleuchte / recessed wall lamp

Material: Edelstahl / Acryl opal / material: stainless steel / acryl opal
 Farbe: edelstahl / colour: stainless steel
 Bestückung: 1x Hochleistungs-LED, Leistung: ca. 1,0W
 lamp: 1x high performance LED, power: approx. 1,0W

inkl. Konverter für 230V Direktanschluss / Converter for direct connection 230V incl.
 inkl. Hohlwand-Montagedose 68 mm Ø/ET65
 Built-in box 68 mm Ø / installation depth 65 mm incl.



Art.-Nr. art-no.	Lichtfarbe light colour	Farbtemperatur colour temperature	Preis € price €
P3937W	kaltweiß / cold white	6500K	104,00
P3937WW	warmweiß / warm white	3100K	104,00
P3937B	blau / blue		104,00
P3937R	rot / red		104,00
P3937Y	orange / orange		104,00
P3937G	grün / green		104,00

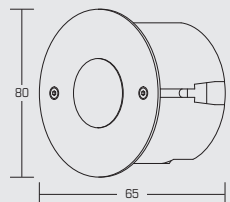

LED-Wandeinbauleuchten | LED-recessed wall lights

LED-Wandeinbauleuchten | LED-recessed wall lights

P3938...

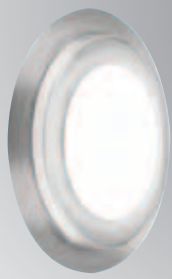

LED-Wandeinbauleuchte / LED-recessed wall light

Material: Edelstahl / Glas teilmattiert / material: stainless steel / glass partially frosted
 Farbe: edelstahl / colour: stainless steel
 Bestückung: 1x Hochleistungs-LED, Leistung: ca. 1,0W
 lamp: 1x high performance LED, power: approx. 1,0W

inkl. Konverter für 230V Direktanschluss / Converter for direct connection 230V incl.
 inkl. Hohlwand-Montagedose 68 mm Ø/ET65
 Built-in box 68 mm Ø / installation depth 65 mm incl.

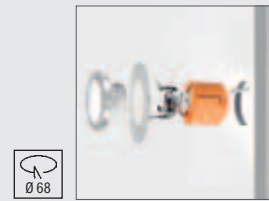
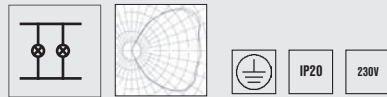

Art.-Nr. art.-no.	Lichtfarbe light colour	Farbtemperatur colour temperature	Preis € price €
P3938W	kaltweiß / cold white	6500K	114,60
P3938WW	warmweiß / warm white	3100K	114,60
P3938B	blau / blue		114,60
P3938R	rot / red		114,60
P3938Y	orange / orange		114,60
P3938G	grün / green		114,60

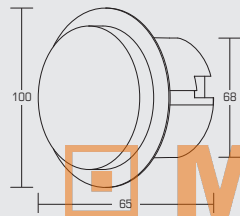

LED-Hinweisleuchte „Non-Smoking“ / LED-sign light „Non-Smoking“

Material: Edelstahl / Acryl opal / material: stainless steel / acryl opal
 Farbe: edelstahl / colour: stainless steel
 Bestückung: 1x Hochleistungs-LED, Leistung: ca. 1,0W
 lamp: 1x high performance LED, power: approx. 1,0W

inkl. Konverter für 230V Direktanschluss / Converter for direct connection 230V incl.
 inkl. Hohlwand-Montagedose 68 mm Ø/ET65
 Built-in box 68 mm Ø / installation depth 65 mm incl.



inkl. BJB-Wechselfassung
 incl. BJB-removable LED socket

Andere Piktogramme auf Anfrage!
 Other pictographs on request!



R3950...



Art.-Nr. art.-no.	Lichtfarbe light colour	Farbtemperatur colour temperature	Preis € price €
R3950W	kaltweiß / cold white	6500K	109,00
R3950WW	warmweiß / warm white	3100K	109,00
R3950B	blau / blue		109,00
R3950R	rot / red		109,00
R3950Y	orange / orange		109,00
R3950G	grün / green		109,00

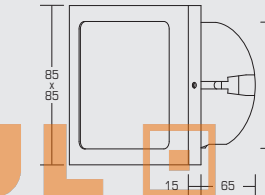

P3939...



LED-Möbeleinbaustrahler / LED-recessed furniture light

Material: Edelstahl / Glas teilmattiert / material: stainless steel / glass partially frosted
 Farbe: edelstahl / colour: stainless steel
 Bestückung: 1x Hochleistungs-LED, Leistung: ca. 1,0W
 lamp: 1x high performance LED, power: approx. 1,0W

inkl. Konverter für 230V Direktanschluss / Converter for direct connection 230V incl.
 inkl. Hohlwand-Montagedose 68 mm Ø/ET65
 Built-in box 68 mm Ø / installation depth 65 mm incl.

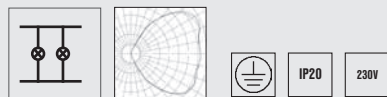

Art.-Nr. art.-no.	Lichtfarbe light colour	Farbtemperatur colour temperature	Preis € price €
P3939W	kaltweiß / cold white	6500K	114,60
P3939WW	warmweiß / warm white	3100K	114,60
P3939B	blau / blue		114,60
P3939R	rot / red		114,60
P3939Y	orange / orange		114,60
P3939G	grün / green		114,60

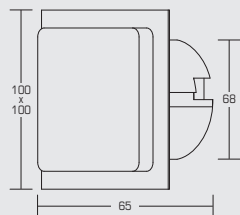

LED-Hinweisleuchte / LED-sign light

Material: Edelstahl / Acryl opal / material: stainless steel / acryl opal
 Farbe: edelstahl / colour: stainless steel
 Bestückung: 2x Hochleistungs-LED, Leistung: ca. 2,0W
 lamp: 2x high performance LED, power: approx. 2,0W

inkl. Konverter für 230V Direktanschluss / Converter for direct connection 230V incl.
 inkl. Hohlwand-Montagedose 2x 68 mm Ø/ET65
 Built-in box 2x 68 mm Ø / installation depth 65 mm incl.



inkl. BJB-Wechselfassung
 incl. BJB-removable LED socket

Andere Piktogramme auf Anfrage!
 Other pictographs on request!



R3952...



Art.-Nr. art.-no.	Lichtfarbe light colour	Farbtemperatur colour temperature	Preis € price €
R3952W	kaltweiß / cold white	6500K	149,00
R3952WW	warmweiß / warm white	3100K	149,00
R3952B	blau / blue		149,00
R3952R	rot / red		149,00
R3952Y	orange / orange		149,00
R3952G	grün / green		149,00

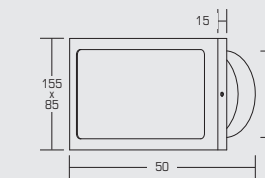

www.modulelectro.ru

MODUL ELECTRO

LED-Wandeinbauleuchten | LED-recessed wall lights

LED-Wandeinbauleuchten | LED-recessed wall lights

R3929...



LED-Wandeinbauleuchte / LED-recessed wall light

Material: Edelstahl / material: stainless steel
 Farbe: struktur weiß / colour: structure white
 Bestückung: 1x Hochleistungs-LED, Leistung: ca. 1,0W
 lamp: 1x high performance LED, power: approx. 1,0W

inkl. Konverter für 230V Direktanschluss / Converter for direct connection 230V incl.
 inkl. Hohlwand-Montagedose 68 mm Ø/ET65
 Built-in box 68 mm Ø / installation depth 65 mm incl.

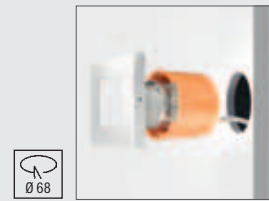

Art.-Nr. art.-no.	Lichtfarbe light colour	Farbtemperatur colour temperature	Preis € price €
R3929W	kaltweiß / cold white	6500K	109,00
R3929WW	warmweiß / warm white	3100K	109,00
R3929B	blau / blue		109,00
R3929R	rot / red		109,00
R3929Y	orange / orange		109,00
R3929G	grün / green		109,00

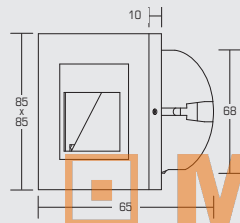

P3729...



LED-Wandeinbauleuchte / LED-recessed wall light

Material: Aluminium / material: aluminium
 Farbe: alu matt / colour: aluminium satin
 Bestückung: 1x Hochleistungs-LED, Leistung: ca. 1,0W
 lamp: 1x high performance LED, power: approx. 1,0W

Einputzgehäuse (nicht im Lieferumfang) Art. 3702 (72x70xET54mm)
 in-wall box (not included in delivery) art. 3702 (72x70x installation depth 54mm)



→ Konverter siehe Seite 442-445
 → converter see pages 442-445

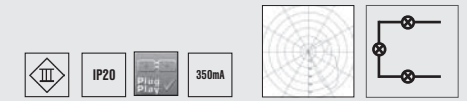

Art.-Nr. art.-no.	Lichtfarbe light colour	Farbtemperatur colour temperature	Preis € price €
P3729W	kaltweiß / cold white	6500K	51,40
P3729WW	warmweiß / warm white	3100K	51,40
P3729B	blau / blue		51,40
P3729R	rot / red		51,40
P3729Y	orange / orange		51,40
P3729G	grün / green		51,40

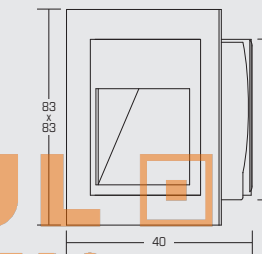

R3928...



LED-Wandeinbauleuchte / LED-recessed wall light

Material: Edelstahl / material: stainless steel
 Farbe: struktur weiß / colour: structure white
 Bestückung: 1x Hochleistungs-LED, Leistung: ca. 1,0W
 lamp: 1x high performance LED, power: approx. 1,0W

inkl. Konverter für 230V Direktanschluss / Converter for direct connection 230V incl.
 inkl. Hohlwand-Montagedose 68 mm Ø/ET65
 Built-in box 68 mm Ø / installation depth 65 mm incl.

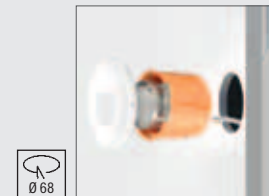

Art.-Nr. art.-no.	Lichtfarbe light colour	Farbtemperatur colour temperature	Preis € price €
R3928W	kaltweiß / cold white	6500K	89,00
R3928WW	warmweiß / warm white	3100K	89,00
R3928B	blau / blue		89,00
R3928R	rot / red		89,00
R3928Y	orange / orange		89,00
R3928G	grün / green		89,00

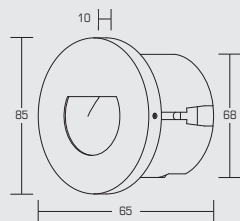

P3730...



LED-Wandeinbauleuchte / LED-recessed wall light

Material: Aluminium / material: aluminium
 Farbe: alu matt / colour: aluminium satin
 Bestückung: 1x Hochleistungs-LED, Leistung: ca. 1,0W
 lamp: 1x high performance LED, power: approx. 1,0W

Einputzgehäuse (nicht im Lieferumfang) Art. 3702 (76x76xET75mm)
 in-wall box (not included in delivery) art. 3702 (76x76x installation depth 54mm)



→ Konverter siehe Seite 442-445
 → converter see pages 442-445

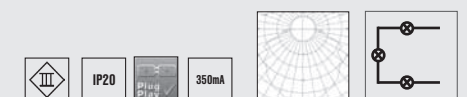

Art.-Nr. art.-no.	Lichtfarbe light colour	Farbtemperatur colour temperature	Preis € price €
P3730W	kaltweiß / cold white	6500K	62,00
P3730WW	warmweiß / warm white	3100K	62,00
P3730B	blau / blue		62,00
P3730R	rot / red		62,00
P3730Y	orange / orange		62,00
P3730G	grün / green		62,00

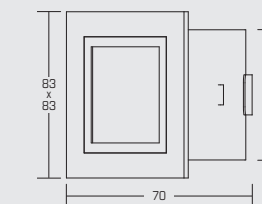

www.modulelectro.ru

MODUL ELECTRO

LED-Wandeinbauleuchten | LED-recessed wall lights

LED-Wandeinbauleuchten | LED-recessed wall lights

P3601...



LED-Wandeinbauleuchte / LED-recessed wall light

Material: Aluminium / Glas opalisiert / material: aluminium / glass opal
 Farbe: alu matt / colour: alu satin
 Bestückung: 1x Hochleistungs-LED, Leistung: ca. 1,0W
 lamp: 1x high performance LED, power: approx. 1,0W

Montage in Hohlräumen mit Blattfeder
 installation in suspended ceilings by leaf spring fixation

Einputzgehäuse für Leuchte und Konverter,
 Artikel 554700 (205 x 85 x 65 mm)
 In-wall box for luminaires and converter,
 article 554700 (205 x 85 x 65 mm)

→ Konverter siehe Seite 442-445
 → converter see pages 442-445



Art.-Nr. art.-no.	Lichtfarbe light colour	Farbtemperatur colour temperatur	Preis € price €
P3601W	kaltweiß / cold white	6500K	114,60
P3601WW	warmweiß / warm white	3100K	114,60
P3601B	blau / blue		114,60
P3601R	rot / red		114,60
P3601Y	orange / orange		114,60
P3601G	grün / green		114,60

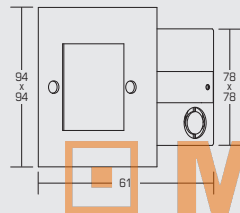

P3732...



LED-Wandeinbauleuchte / LED-recessed wall light

Material: Aluminium / Glas / material: aluminium / glass
 Farbe: alu matt / colour: aluminium satin
 Bestückung: 1x Hochleistungs-LED, Leistung: ca. 1,0W
 lamp: 1x high performance LED, power: approx. 1,0W

Einputzgehäuse (nicht im Lieferumfang) Art. 3701 (76x76xET75mm)
 in-wall box (not included in delivery) art. 3701 (76x76 installation depth 75mm)



→ Konverter siehe Seite 442-445
 → converter see pages 442-445

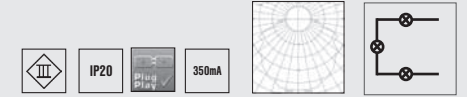

Art.-Nr. art.-no.	Lichtfarbe light colour	Farbtemperatur colour temperatur	Preis € price €
P3732W	kaltweiß / cold white	6500K	62,00
P3732WW	warmweiß / warm white	3100K	62,00
P3732B	blau / blue		62,00
P3732R	rot / red		62,00
P3732Y	orange / orange		62,00
P3732G	grün / green		62,00

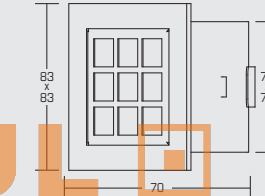

MODUL
ELECTRO

www.modulelectro.ru

P3611...

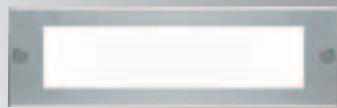

LED-Wandeinbauleuchte / LED-recessed wall light

Material: Aluminium / Glas opalisiert / material: aluminium / glass opal
 Farbe: alu matt / colour: alu satin
 Bestückung: 2x Hochleistungs-LED, Leistung: ca. 2,0W
 lamp: 2x high performance LED, power: approx. 2,0W

Montage in Hohlräumen mit Blattfeder
 installation in suspended ceilings by leaf spring fixation

→ Konverter siehe Seite 442-445
 → converter see pages 442-445

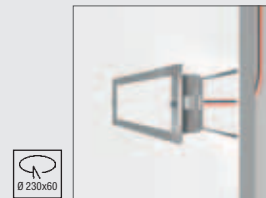

Art.-Nr. art.-no.	Lichtfarbe light colour	Farbtemperatur colour temperatur	Preis € price €
P3611W	kaltweiß / cold white	6500K	149,50
P3611WW	warmweiß / warm white	3100K	149,50
P3611B	blau / blue		149,50
P3611R	rot / red		149,50
P3611Y	orange / orange		149,50
P3611G	grün / green		149,50

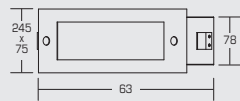

LED-Wandeinbauleuchten | LED-recessed wall lights

LED-Wandeinbauleuchten | LED-recessed wall lights

P3615...



LED-Wandeinbauleuchte / LED-recessed wall light

Material: Edelstahl / Aluminium / material: stainless steel / aluminium
Farbe: edelstahl / colour: stainless steel
Bestückung: 1x Hochleistungs-LED, Leistung: ca. 1,0W
 lamp: 1x high performance LED, power: approx. 1,0W

Montage in Hohlräumen mit Blattfeder
 installation in suspended ceilings by leaf spring fixation

Einputzgehäuse für Leuchte und Konverter,
 Artikel 554500 (85 x 170 x 65 mm)
 In-wall box for luminaires and converter,
 article 554500 (85 x 170 x 65 mm)

Einputzgehäuse, Artikel 555500 (Ø80 x H67 mm)
 In-wall box, article 555500 (Ø 80 x H 67 mm)

→ Konverter siehe Seite 442-445
 → converter see pages 442-445

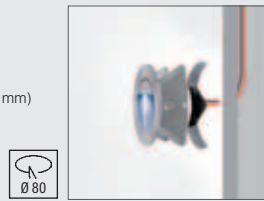

Art.-Nr. art.-no.	Lichtfarbe light colour	Farbtemperatur colour temperatur	Preis € price €
P3615W	kaltweiß / cold white	6500K	149,50
P3615WW	warmweiß / warm white	3100K	149,50
P3615B	blau / blue		149,50
P3615R	rot / red		149,50
P3615Y	orange / orange		149,50
P3615G	grün / green		149,50

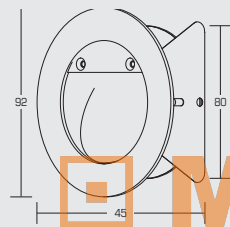

P3617...

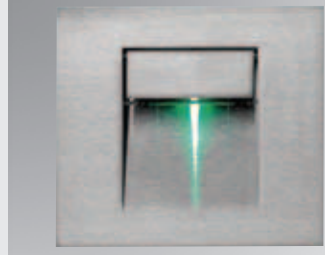

LED-Wandeinbauleuchte / LED-recessed wall light

Material: Edelstahl / Aluminium / material: stainless steel / aluminium
Farbe: edelstahl / colour: stainless steel
Bestückung: 1x Hochleistungs-LED, Leistung: ca. 1,0W
 lamp: 1x high performance LED, power: approx. 1,0W

Montage in Hohlräumen mit Blattfeder
 installation in suspended ceilings by leaf spring fixation

Einputzgehäuse für Leuchte und Konverter,
 Artikel 554700 (85 x 205 x 60 mm)
 In-wall box for luminaires and converter,
 article 554700 (85 x 205 x 60 mm)

Einputzgehäuse, Artikel 555700 (85 x 80 x 65 mm)
 In-wall box, article 555700 (85 x 80 x 65 mm)

→ Konverter siehe Seite 442-445
 → converter see pages 442-445



Art.-Nr. art.-no.	Lichtfarbe light colour	Farbtemperatur colour temperatur	Preis € price €
P3617W	kaltweiß / cold white	6500K	207,50
P3617WW	warmweiß / warm white	3100K	207,50
P3617B	blau / blue		207,50
P3617R	rot / red		207,50
P3617Y	orange / orange		207,50
P3617G	grün / green		207,50

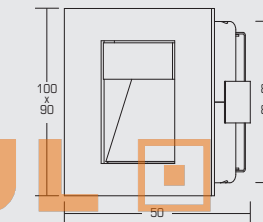

www.modulelectro.ru

MODULO
ELECTRO

P3616...

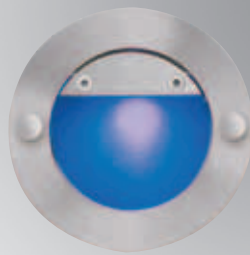

LED-Wandeinbauleuchte / LED-recessed wall light

Material: Edelstahl / Glas teilsatiniert / material: stainless steel / glass partially satined
Farbe: edelstahl / colour: stainless steel
Bestückung: 1x Hochleistungs-LED, Leistung: ca. 1,0W
 lamp: 1x high performance LED, power: approx. 1,0W

Montage in Hohlräumen mit Blattfeder
 installation in suspended ceilings by leaf spring fixation

Einputzgehäuse für Leuchte und Konverter,
 Artikel 554500 (85 x 170 x 65 mm)
 In-wall box for luminaires and converter,
 article 554500 (85 x 170 x 65 mm)

Einputzgehäuse, Artikel 555500 (Ø80 x H67 mm)
 In-wall box, article 555500 (Ø 80 x H 67 mm)

Ersatzglas, Artikel 570500
 replacement glass, article 570500

→ Konverter siehe Seite 442-445
 → converter see pages 442-445



Art.-Nr. art.-no.	Lichtfarbe light colour	Farbtemperatur colour temperatur	Preis € price €
P3616W	kaltweiß / cold white	6500K	207,50
P3616WW	warmweiß / warm white	3100K	207,50
P3616B	blau / blue		207,50
P3616R	rot / red		207,50
P3616Y	orange / orange		207,50
P3616G	grün / green		207,50

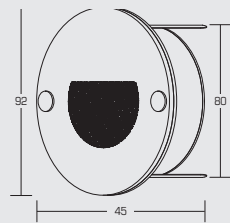

P3618...



LED-Wandeinbauleuchte / LED-recessed wall light

Material: Edelstahl / Glas teilsatiniert / material: stainless steel / glass partially satined
Farbe: edelstahl / colour: stainless steel
Bestückung: 1x Hochleistungs-LED, Leistung: ca. 1,0W
 lamp: 1x high performance LED, power: approx. 1,0W

Montage in Hohlräumen mit Blattfeder
 installation in suspended ceilings by leaf spring fixation

Einputzgehäuse für Leuchte und Konverter,
 Artikel 554700 (85 x 205 x 60 mm)
 In-wall box for luminaires and converter,
 article 554700 (85 x 205 x 60 mm)

Einputzgehäuse, Artikel 555700 (85 x 80 x 65 mm)
 In-wall box, article 555700 (85 x 80 x 65 mm)

Ersatzglas, Artikel 570600 / replacement glass, article 570600

→ Konverter siehe Seite 442-445
 → converter see pages 442-445

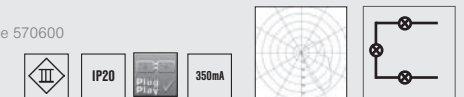
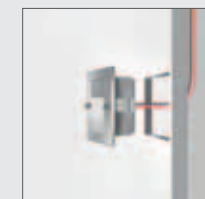

Art.-Nr. art.-no.	Lichtfarbe light colour	Farbtemperatur colour temperatur	Preis € price €
P3618W	kaltweiß / cold white	6500K	253,40
P3618WW	warmweiß / warm white	3100K	253,40
P3618B	blau / blue		253,40
P3618R	rot / red		253,40
P3618Y	orange / orange		253,40
P3618G	grün / green		253,40

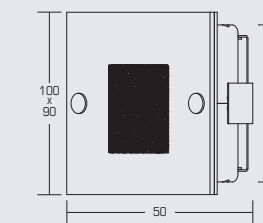

LED-Wandeinbauleuchten | LED-recessed wall lights

P3673WW

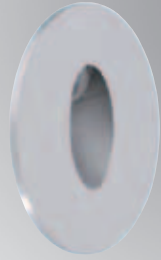

NEU NEW NEU NEW NEU NEW NEU

LED-Wandeinbauleuchte / LED-recessed wall light

Material: Aluminium / material: aluminium
 Farbe: aluminium / colour: aluminium
 Bestückung: 1x Hochleistungs-LED, Leistung: ca. 1,0W
 lamp: 1x high performance LED, power: approx. 1,0W

Montage in Hohlräumen mit Blattfeder
 installation in suspended ceilings by leaf spring fixation

inkl. Einputzhülse 73 mm Ø/ET55
 incl. in-wall box 73 mm Ø / installation depth 55 mm

→ Konverter siehe Seite 442-445
 → converter see pages 442-445

NEU new



Art.-Nr. art.-no.	Lichtfarbe light colour	Farbtemperatur colour temperature	Preis € price €
P3673WW	warmweiß / warm white	3100K	72,00

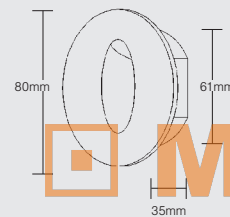

P3674WW



NEU NEW NEU NEW NEU NEW NEU

LED-Wandeinbauleuchte / LED-recessed wall light

Material: Aluminium / material: aluminium
 Farbe: aluminium / colour: aluminium
 Bestückung: 2x Hochleistungs-LED, Leistung: ca. 2,0W
 lamp: 2x high performance LED, power: approx. 2,0W

Montage in Hohlräumen mit Blattfeder
 installation in suspended ceilings by leaf spring fixation

inkl. Einputzhülse 90 mm Ø/ET50
 incl. in-wall box 90 mm Ø / installation depth 50 mm

→ Konverter siehe Seite 442-445
 → converter see pages 442-445

NEU new

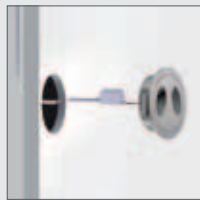

Art.-Nr. art.-no.	Lichtfarbe light colour	Farbtemperatur colour temperature	Preis € price €
P3674WW	warmweiß / warm white	3100K	84,00

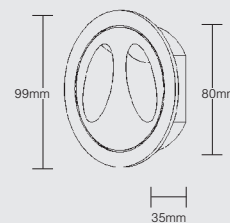

LED-Wandeinbauleuchten | LED-recessed wall lights



MODUL ELECTRO
 www.modulelectro.ru

LED-Wandeinbauleuchten IP65 | LED-recessed wall lights IP65

LED-Wandeinbauleuchten IP65 | LED-recessed wall lights IP65

P3620...



LED-Wandeinbauleuchte mit erhöhter Schutzart
LED-recessed wall light with raised degree of protection

Material: Aluminium / Kunststoff / material: aluminium / plastic
Farbe: alu matt / colour: aluminium satin
Bestückung: 1x Hochleistungs-LED, Leistung: ca. 1,0W
lamp: 1x high performance LED, power: approx. 1,0W

Inklusive Einputzgehäuse / incl. in-wall box

→ Konverter siehe Seite 442-445
→ converter see pages 442-445

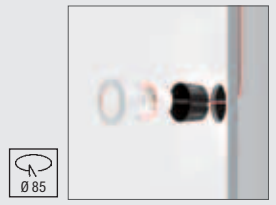

Art.-Nr. art-no.	Lichtfarbe light colour	Farbtemperatur colour temperature	Preis € price €
P3620W	kaltweiß / cold white	6500K	126,10
P3620WW	warmweiß / warm white	3100K	126,10
P3620B	blau / blue		126,10
P3620R	rot / red		126,10
P3620Y	orange / orange		126,10
P3620G	grün / green		126,10

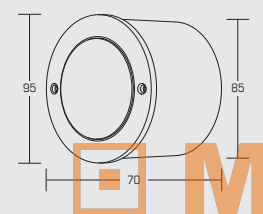

P3622...

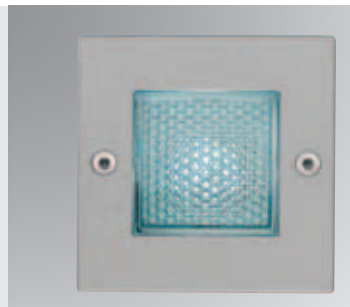

LED-Wandeinbauleuchte mit erhöhter Schutzart
LED-recessed wall light with raised degree of protection

Material: Aluminium / Kunststoff / material: aluminium / plastic
Farbe: alu matt / colour: aluminium satin
Bestückung: 1x Hochleistungs-LED, Leistung: ca. 1,0W
lamp: 1x high performance LED, power: approx. 1,0W

Inklusive Einputzgehäuse / incl. in-wall box

→ Konverter siehe Seite 442-445
→ converter see pages 442-445

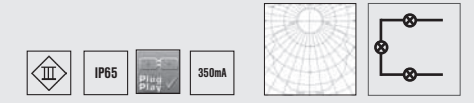

Art.-Nr. art-no.	Lichtfarbe light colour	Farbtemperatur colour temperature	Preis € price €
P3622W	kaltweiß / cold white	6500K	126,10
P3622WW	warmweiß / warm white	3100K	126,10
P3622B	blau / blue		126,10
P3622R	rot / red		126,10
P3622Y	orange / orange		126,10
P3622G	grün / green		126,10

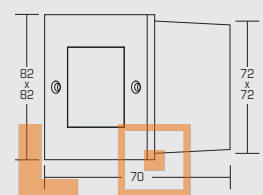

P3621...

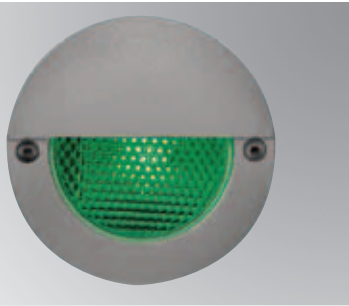

LED-Wandeinbauleuchte mit erhöhter Schutzart
LED-recessed wall light with raised degree of protection

Material: Aluminium / Kunststoff / material: aluminium / plastic
Farbe: alu matt / colour: aluminium satin
Bestückung: 1x Hochleistungs-LED, Leistung: ca. 1,0W
lamp: 1x high performance LED, power: approx. 1,0W

Inklusive Einputzgehäuse / incl. in-wall box

→ Konverter siehe Seite 442-445
→ converter see pages 442-445

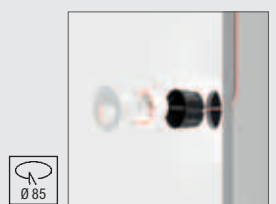

Art.-Nr. art-no.	Lichtfarbe light colour	Farbtemperatur colour temperature	Preis € price €
P3621W	kaltweiß / cold white	6500K	126,10
P3621WW	warmweiß / warm white	3100K	126,10
P3621B	blau / blue		126,10
P3621R	rot / red		126,10
P3621Y	orange / orange		126,10
P3621G	grün / green		126,10

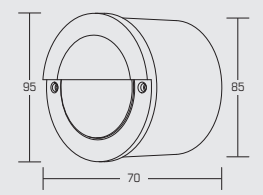

MODUL
ELECTRO
www.modulelectro.ru

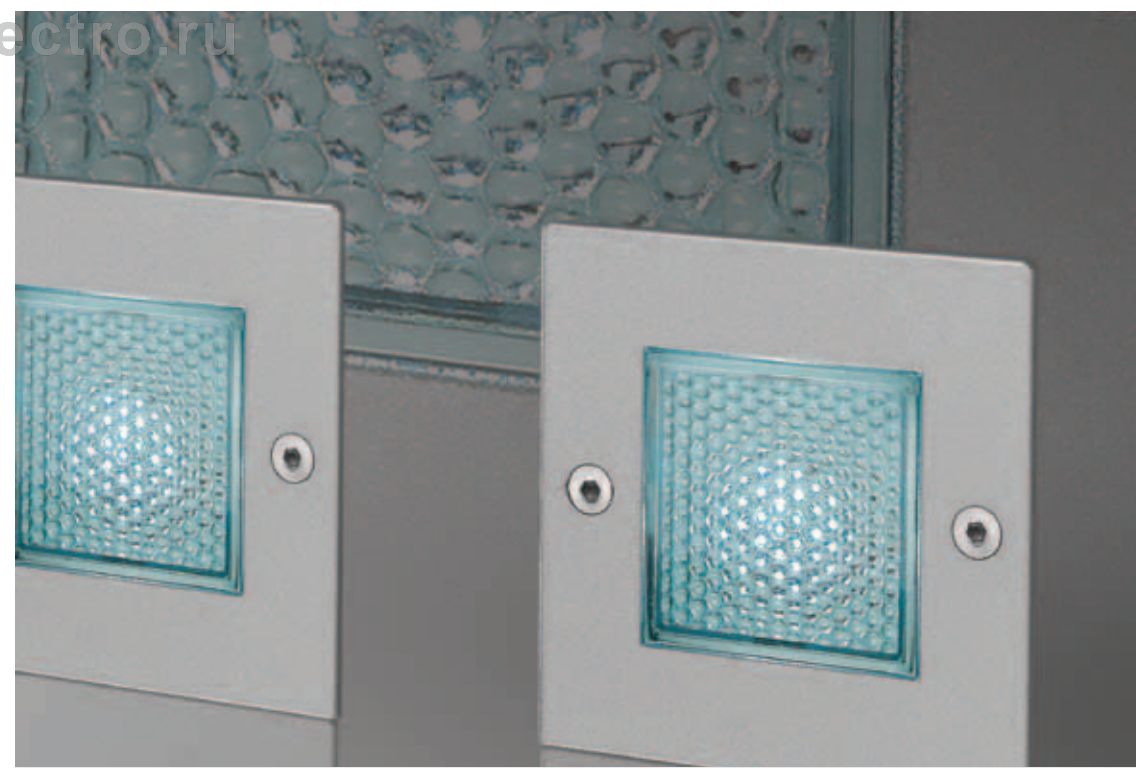

R3713...



LED-Leseleuchte „Flexarm“ / LED-reading lamp „flexible arm“
 Material: Edelstahl / Messing / Acryl / material: stainless steel / brass / acryl
 Farbe: edelstahl / colour: stainless steel
 Bestückung: 3x Hochleistungs-LED, Leistung: ca. 4,2W
 lamp: 3x high performance LED, power: approx. 4,2W
 inkl. integriertem Ein-/Ausschalter / Integrated on-/off-switch incl.
 inkl. Konverter für 230V Direktanschluss / Converter for direct connection 230V incl.
 inkl. Hohlwand-Montagedose 68 mm Ø/ET65
 Built-in box 68 mm Ø / installation depth 65 mm incl.

Andere Gehäusefarben auf Anfrage
 other colours of cabinet available on request



Art.-Nr. art-no.	Lichtfarbe light colour	Farbtemperatur colour temperature	Preis € price €
R3713W	kaltweiß / cold white	6500K	194,70
R3713NW	neutralweiß / neutral white	4100K	194,70
R3713WW	warmweiß / warm white	3100K	194,70

Andere Gehäusefarben auf Anfrage / other colours of cabinet available on request

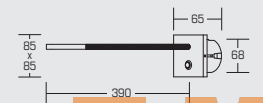

R3715...

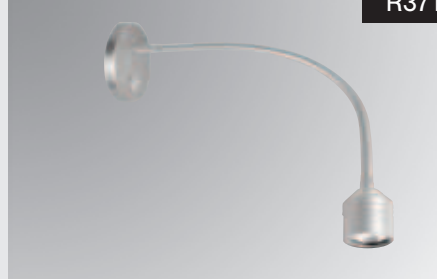

LED-Leseleuchte „Flexarm“ / LED-reading lamp „flexible arm“
 Material: Edelstahl / Messing / Acryl / material: stainless steel / brass / acryl
 Farbe: edelstahl / colour: stainless steel
 Bestückung: 3x Hochleistungs-LED, Leistung: ca. 3,6W
 lamp: 3x high performance LED, power: approx. 3,6W
 inkl. integriertem Ein-/Ausschalter / Integrated on-/off-switch incl.
 inkl. Konverter für 230V Direktanschluss / Converter for direct connection 230V incl.

inkl. Hohlwand-Montagedose 68 mm Ø/ET65
 Built-in box 68 mm Ø / installation depth 65 mm incl.

Linse: 80° / lens: 80°

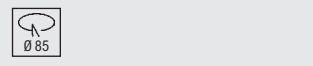

Art.-Nr. art-no.	Lichtfarbe light colour	Farbtemperatur colour temperature	Linse lense	Preis € price €
R3715W	kaltweiß / cold white	6500K	80°	174,10
R3715NW	neutralweiß / neutral white	4100K	80°	174,10
R3715WW	warmweiß / warm white	3100K	80°	174,10

Andere Gehäusefarben auf Anfrage / other colours of cabinet available on request

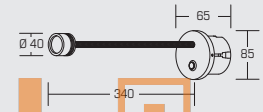

R3714...

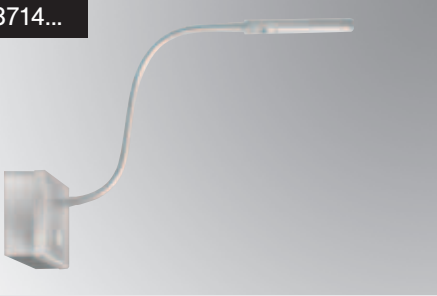

LED-Aufbau-Leseleuchte „Flexarm“
 LED-surface mounted reading lamp „flexible arm“
 Material: Edelstahl / Messing / Acryl / material: stainless steel / brass / acryl
 Farbe: edelstahl / colour: stainless steel
 Bestückung: 3x Hochleistungs-LED, Leistung: ca. 4,2W
 lamp: 3x high performance LED, power: approx. 4,2W
 inkl. integriertem Ein-/Ausschalter / Integrated on-/off-switch incl.
 inkl. Konverter für 230V Direktanschluss / Converter for direct connection 230V incl.

Andere Gehäusefarben auf Anfrage
 other colours of cabinet available on request



Art.-Nr. art-no.	Lichtfarbe light colour	Farbtemperatur colour temperature	Preis € price €
R3714W	kaltweiß / cold white	6500K	204,00
R3714NW	neutralweiß / neutral white	4100K	204,00
R3714WW	warmweiß / warm white	3100K	204,00

Andere Gehäusefarben auf Anfrage / other colours of cabinet available on request

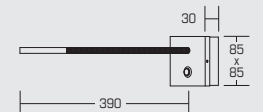

R3716...

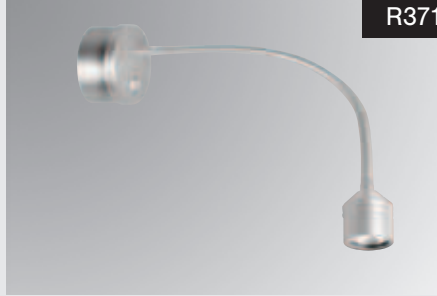

LED-Aufbau-Leseleuchte „Flexarm“
 LED-surface mounted reading lamp „flexible arm“
 Material: Edelstahl / Messing / Acryl / material: stainless steel / brass / acryl
 Farbe: edelstahl / colour: stainless steel
 Bestückung: 3x Hochleistungs-LED, Leistung: ca. 3,6W
 lamp: 3x high performance LED, power: approx. 3,6W
 inkl. integriertem Ein-/Ausschalter / Integrated on-/off-switch incl.
 inkl. Konverter für 230V Direktanschluss / Converter for direct connection 230V incl.

Linse: 80° / lens: 80°

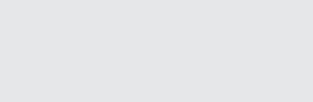

Art.-Nr. art-no.	Lichtfarbe light colour	Farbtemperatur colour temperature	Linse lense	Preis € price €
R3716W	kaltweiß / cold white	6500K	80°	194,70
R3716NW	neutralweiß / neutral white	4100K	80°	194,70
R3716WW	warmweiß / warm white	3100K	80°	194,70

Andere Gehäusefarben auf Anfrage / other colours of cabinet available on request

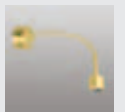
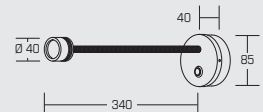

MODULO ELECTRO
 www.modulelectro.ru

Deko LED-Wandeinbauleuchten | Deco LED-recessed wall lights

Deko LED-Wandeinbauleuchten | Deco LED-recessed wall lights

P3643...



Dekorative LED-Wandeinbauleuchte / Decorative LED-recessed wall light

Material: Aluminium / Messing / Acryl / material: aluminium / brass / acryl
 Farbe: chrom / colour: chrome
 Bestückung: 2x Hochleistungs-LED, Leistung: ca. 2,0W
 lamp: 2x high performance LED, power: approx. 2,0W

inkl. Konverter für 230V Direktanschluss / Converter for direct connection 230V incl.
 inkl. Hohlwand-Montagedose 68 mm Ø / ET65
 Built-in box 68 mm Ø / installation depth 65 mm incl.

up and down

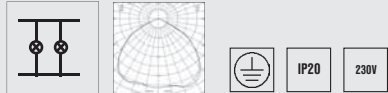
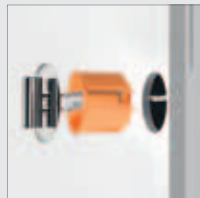

Art.-Nr. art-no.	Lichtfarbe light colour	Farbtemperatur colour temperature	Preis € price €
P3643W	kaltweiß / cold white	6500K	172,50
P3643WW	warmweiß / warm white	3100K	172,50
P3643B	blau / blue		172,50
P3643R	rot / red		172,50
P3643Y	orange / orange		172,50
P3643G	grün / green		172,50

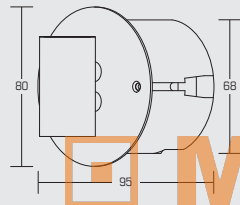

P3962...



Dekorative LED-Wandeinbauleuchte / Decorative LED-recessed wall light

Material: Aluminium / Messing / Acryl / material: aluminium / brass / acryl
 Farbe: chrom / colour: chrome
 Bestückung: 2x Hochleistungs-LED, Leistung: ca. 2,0W
 lamp: 2x high performance LED, power: approx. 2,0W

inkl. Konverter für 230V Direktanschluss
 Converter for direct connection 230V incl.

inkl. Hohlwand-Montagedose 68 mm Ø / ET65
 Built-in box 68 mm Ø / installation depth 65 mm incl.

up and down

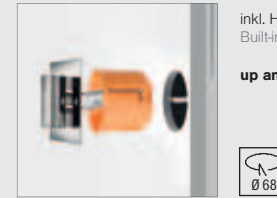

Art.-Nr. art-no.	Lichtfarbe light colour	Farbtemperatur colour temperature	Preis € price €
P3962W	kaltweiß / cold white	6500K	184,00
P3962WW	warmweiß / warm white	3100K	184,00
P3962B	blau / blue		184,00
P3962R	rot / red		184,00
P3962Y	orange / orange		184,00
P3962G	grün / green		184,00

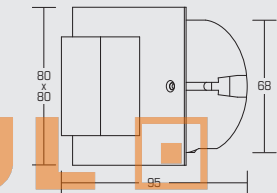

www.modulelectro.ru

P3677...



Dekorative LED-Wandeinbauleuchte / Decorative LED-recessed wall light

Material: Edelstahl / Messing / Acryl
 material: brass / aluminium / acryl
 Farbe: chrom / colour: chrome
 Bestückung: 2x Hochleistungs-LED, Leistung: ca. 2,0W
 lamp: 2x high performance LED, power: approx. 2,0W

230V-Direktanschluss mit integriertem Konverter
 230V-direct connexion with integrated converter

Inkl. Hohlwand-Montagedose D 68mm / ET 65mm
 built-in box 68 mm Ø / installation depth 65 mm incl.

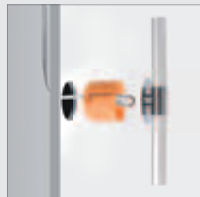

Art.-Nr. art-no.	Lichtfarbe light colour	Farbtemperatur colour temperature	Preis € price €
P3677W	kaltweiß / cold white	3500K	198,00
P3677B	blau / blue		198,00

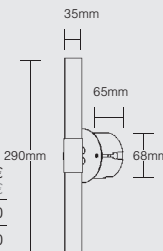

500245W



Dekorative LED-Wandeinbauleuchte / Decorative LED-recessed wall light

Material: Aluminium / Kunststoff / material: aluminium / plastic
 Farbe: aluminium / colour: aluminium
 Bestückung: 2x Hochleistungs-LED, Leistung: ca. 2,0W
 lamp: 2x high performance LED, power: approx. 2,0W

230V-Direktanschluss mit integriertem Konverter
 230V-direct connexion with integrated converter

Inkl. Hohlwand-Montagedose / incl. built-in box

NEU
new



Art.-Nr. art-no.	Lichtfarbe light colour	Farbtemperatur colour temperature	Preis € price €
500245W	kaltweiß / cold white	6500K	98,00

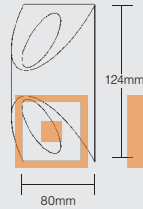
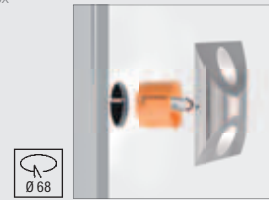

Dekorative LED-Wandeinbauleuchte / Decorative LED-recessed wall light

Material: Aluminium / Acryl / material: aluminium / acryl
 Farbe: aluminium / colour: aluminium
 Bestückung: 1x Hochleistungs-LED, Leistung: ca. 1,0W
 lamp: 1x high performance LED, power: approx. 1,0W

Inkl. Konverter für 230V Direktanschluss
 Converter for direct connection 230V incl.

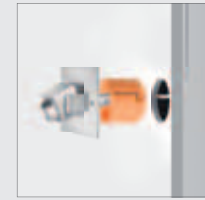

Inkl. Hohlwand-Montagedose 68 mm Ø/ET65
 Built-in box 68mm Ø / installation depth 65 mm incl.

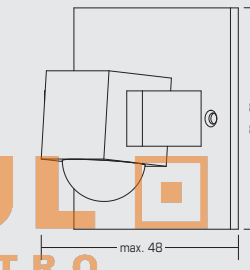

Art.-Nr. art-no.	Lichtfarbe light colour	Farbtemperatur colour temperature	Preis € price €
P3630W	kaltweiß / cold white	6500K	89,00
P3630WW	warmweiß / warm white	3100K	89,00
P3630B	blau / blue		89,00
P3630R	rot / red		89,00
P3630Y	orange / orange		89,00
P3630G	grün / green		89,00

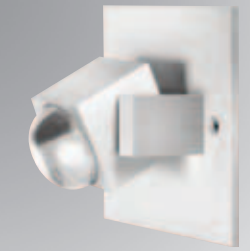

P3630...



500246W



Dekorative LED-Wandeinbauleuchte / Decorative LED-recessed wall light

Material: Aluminium / Kunststoff / material: aluminium / plastic
 Farbe: struktur weiß / colour: structure white
 Bestückung: 2x Hochleistungs-LED, Leistung: ca. 2,0W
 lamp: 2x high performance LED, power: approx. 2,0W

230V-Direktanschluss mit integriertem Konverter
 230V-direct connexion with integrated converter

Inkl. Hohlwand-Montagedose / incl. built-in box

NEU
new



Art.-Nr. art-no.	Lichtfarbe light colour	Farbtemperatur colour temperature	Preis € price €
500246W	kaltweiß / cold white	6500K	92,00

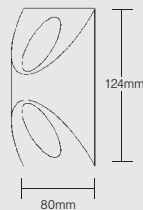
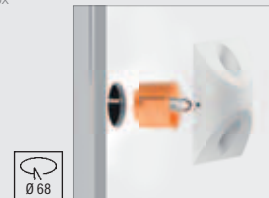

Dekorative LED-Wandeinbauleuchte / Decorative LED-recessed wall light

Material: Aluminium / Acryl / material: aluminium / acryl
 Farbe: aluminium / colour: aluminium
 Bestückung: 2x Hochleistungs-LED, Leistung: ca. 2,0W
 lamp: 2x high performance LED, power: approx. 2,0W

Inkl. Konverter für 230V Direktanschluss
 Converter for direct connection 230V incl.



Inkl. Hohlwand-Montagedose 68 mm Ø/ET65
 Built-in box 68mm Ø / installation depth 65 mm incl.

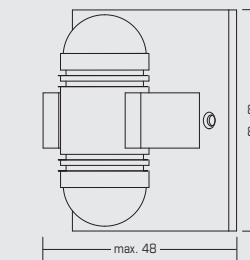

Art.-Nr. art-no.	Lichtfarbe light colour	Farbtemperatur colour temperature	Preis € price €
P3631W	kaltweiß / cold white	6500K	139,00
P3631WW	warmweiß / warm white	3100K	139,00
P3631B	blau / blue		139,00
P3631R	rot / red		139,00
P3631Y	orange / orange		139,00
P3631G	grün / green		139,00



P3631...



MODUL
ELECTRO
www.modulelectro.ru



Dekorative LED-Wandaufbauleuchte / Decorative LED-wall light

Material: Aluminium / Acryl / material: aluminium / acryl
 Farbe: aluminium / colour: aluminium
 Bestückung: 3x Hochleistungs-LED, Leistung: ca. 3,0W
 lamp: 3x high performance LED, power: approx. 3,0W

inkl. Konverter für 230V Direktanschluss / Converter for direct connection 230V incl.

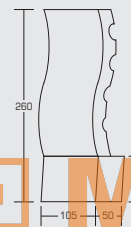

Art.-Nr. art.-no.	Lichtfarbe light colour	Farbtemperatur colour temp.	Preis € price €
500920W	kaltweiß / cold white	6500K	249,00

MODUL
ELECTRO

www.modulelectro.ru



Dekorative LED-Wandaufbauleuchte / Decorative LED-wall light

Material: Aluminium / Acryl / material: aluminium / acryl
 Farbe: chrom / colour: chrome
 Bestückung: 3x Hochleistungs-LED, Leistung: ca. 3,0W
 lamp: 3x high performance LED, power: approx. 3,0W

inkl. Konverter für 230V Direktanschluss / Converter for direct connection 230V incl.

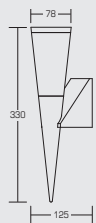
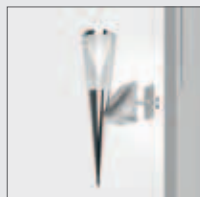

Art.-Nr. art.-no.	Lichtfarbe light colour	Farbtemperatur colour temp.	Preis € price €
500950W	kaltweiß / cold white	6500K	247,00

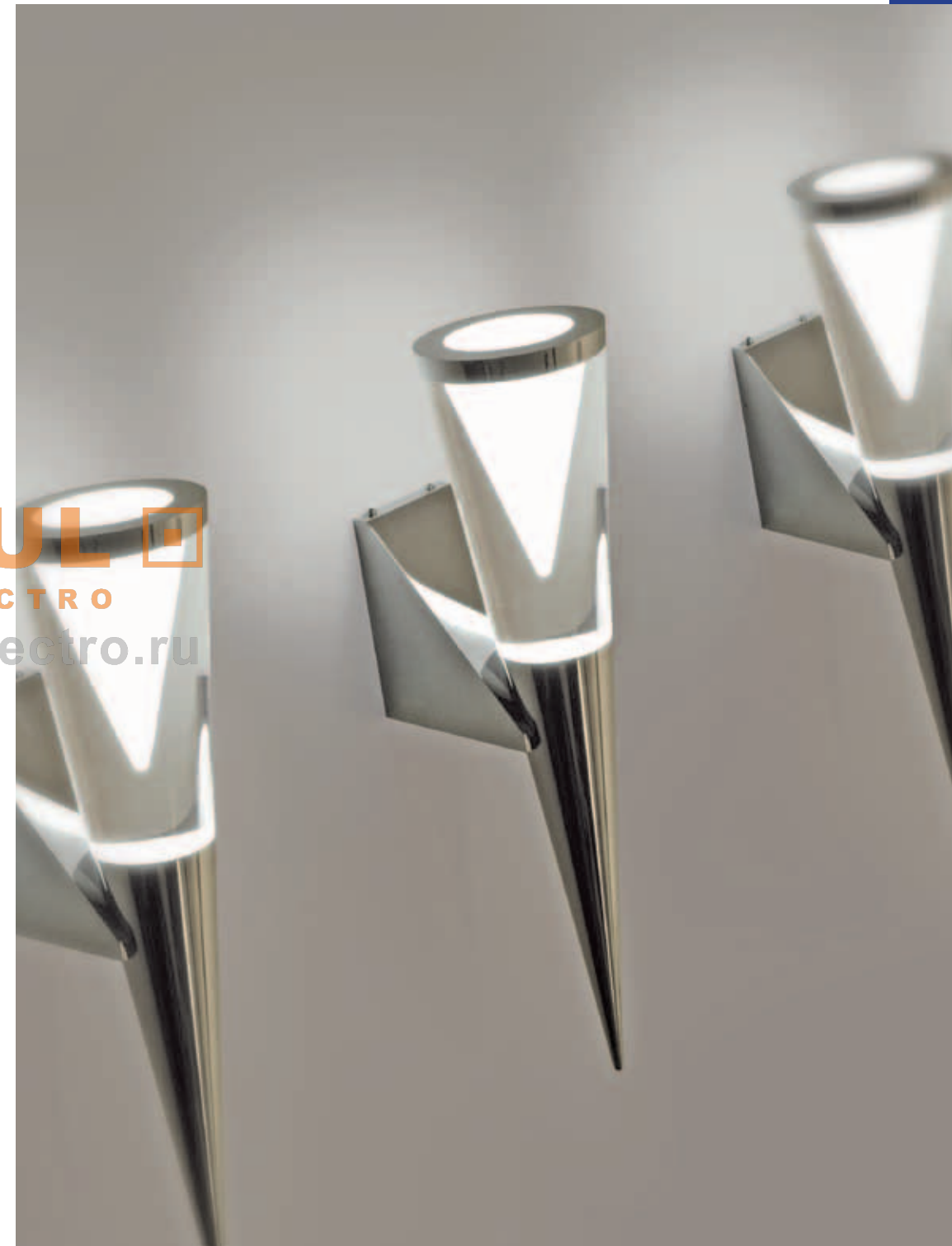



MODULO
ELECTRO
www.modulelectro.ru

Dekorative LED-Wandaufbauleuchte / Decorative LED-wall light

Material: Aluminium / Acryl Perlenoptik / material: aluminium / acryl pearl optic
 Farbe: aluminium / colour: aluminium
 Bestückung: 3x Hochleistungs-LED, Leistung: ca. 3,0W
 lamp: 3x high performance LED, power: approx. 3,0W

Inkl. Konverter für 230V Direktanschluss
 Converter for direct connection 230V incl.

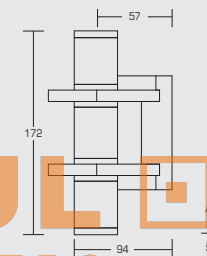

Art.-Nr. art.-no.	Lichtfarbe light colour	Farbtemperatur colour temp.	Preis € price €
500915W	kaltweiß / cold white	6500K	239,00

500915W



Dekorative LED-Wandaufbauleuchte / Decorative LED-wall light

Material: Aluminium / Acryl mattiert / material: aluminium / acryl satin
 Farbe: aluminium / colour: aluminium
 Bestückung: 3x Hochleistungs-LED, Leistung: ca. 3,0W
 lamp: 3x high performance LED, power: approx. 3,0W

Inkl. Konverter für 230V Direktanschluss
 Converter for direct connection 230V incl.

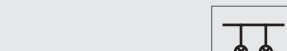
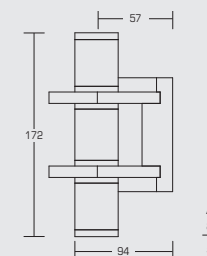

Art.-Nr. art.-no.	Lichtfarbe light colour	Farbtemperatur colour temp.	Preis € price €
500916W	kaltweiß / cold white	6500K	239,00

500916W





Dekorative LED-Wandaufbauleuchte / Decorative LED-wall light

Material: Aluminium / Kristallglas teilsatiniert / material: aluminium / crystal partially satined
 Farbe: chrom / colour: chrome
 Bestückung: 1x Hochleistungs-LED, Leistung: ca. 1,0W
 lamp: 1x high performance LED, power: approx. 1,0W

Inkl. Konverter für 230V Direktanschluss / Converter for direct connection 230V incl.

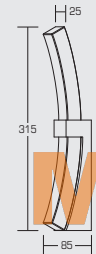
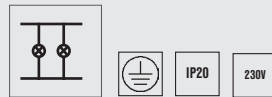

Art.-Nr. art.-no.	Lichtfarbe light colour	Farbtemperatur colour temp.	Preis € price €
500940W	kaltweiß / cold white	6500K	249,00

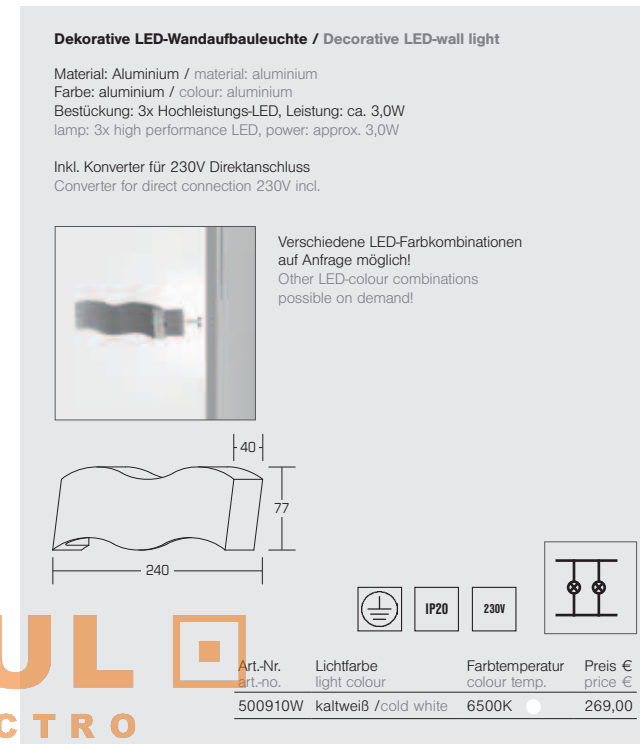

Dekorative LED-Wandaufbauleuchte / Decorative LED-wall light

Material: Aluminium / material: aluminium
 Farbe: aluminium / colour: aluminium
 Bestückung: 3x Hochleistungs-LED, Leistung: ca. 3,0W
 lamp: 3x high performance LED, power: approx. 3,0W

Inkl. Konverter für 230V Direktanschluss
 Converter for direct connection 230V incl.



Verschiedene LED-Farbkombinationen
 auf Anfrage möglich!
 Other LED-colour combinations
 possible on demand!

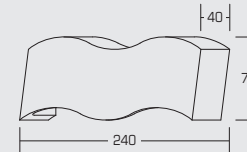

Art.-Nr. art.-no.	Lichtfarbe light colour	Farbtemperatur colour temp.	Preis € price €
500910W	kaltweiß / cold white	6500K	269,00



Dekorative LED-Wandaufbauleuchte / Decorative LED-wall light

Material: Aluminium / Acryl teilsatiniert / material: aluminium / acryl partially satined
 Farbe: aluminium / colour: aluminium
 Bestückung: 3x Hochleistungs-LED, Leistung: ca. 3,0W
 lamp: 3x high performance LED, power: approx. 3,0W

Inkl. Konverter für 230V Direktanschluss / Converter for direct connection 230V incl.

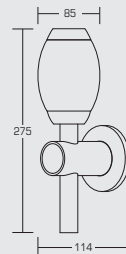
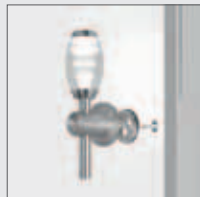

Art.-Nr. art.-no.	Lichtfarbe light colour	Farbtemperatur colour temp.	Preis € price €
500925W	warmweiß warmwhite	3100K	269,00

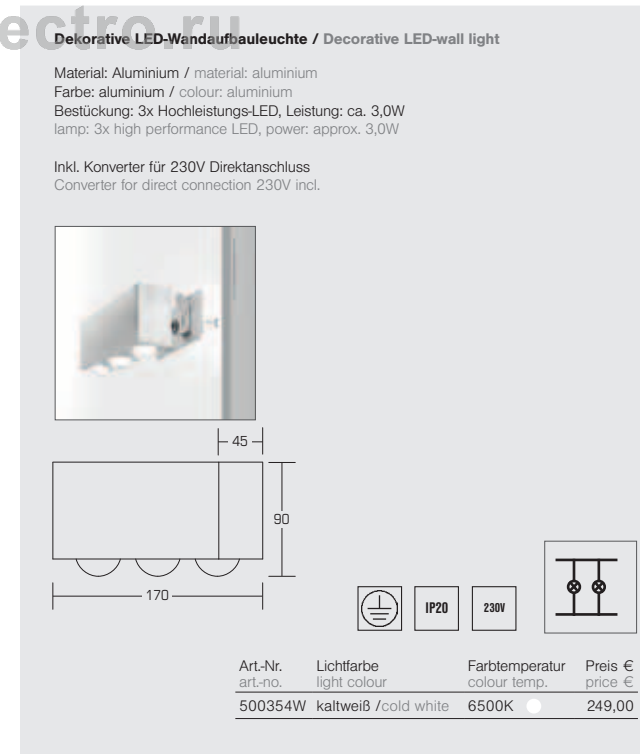

Dekorative LED-Wandaufbauleuchte / Decorative LED-wall light

Material: Aluminium / material: aluminium
 Farbe: aluminium / colour: aluminium
 Bestückung: 3x Hochleistungs-LED, Leistung: ca. 3,0W
 lamp: 3x high performance LED, power: approx. 3,0W

Inkl. Konverter für 230V Direktanschluss
 Converter for direct connection 230V incl.

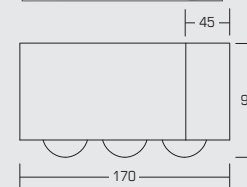

Art.-Nr. art.-no.	Lichtfarbe light colour	Farbtemperatur colour temp.	Preis € price €
500354W	kaltweiß / cold white	6500K	249,00

MODULO
ELECTRO
www.modulelectro.ru

500951W



Dekorative LED-Wandaufbauleuchte / Decorative LED-wall light

Material: Aluminium / Acryl teilmattiert / material: aluminium / acryl partially satined
 Farbe: chrom / colour: chrome
 Bestückung: 3x Hochleistungs-LED, Leistung: ca. 3,0W
 lamp: 3x high performance LED, power: approx. 3,0W

inkl. Konverter für 230V Direktanschluss / Converter for direct connection 230V incl.



Art.-Nr. art-no.	Lichtfarbe light colour	Farbtemperatur colour temperature	Preis € price €
500951W	kaltweiß / cold white ●	6500K	167,00

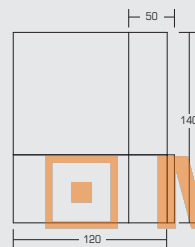

MODUL
ELECTRO

www.modulelectro.ru

500952W



Dekorative LED-Wandaufbauleuchte / Decorative LED-wall light

Material: Aluminium / Acryl teilmattiert / material: aluminium / acryl partially satined
 Farbe: chrom / colour: chrome
 Bestückung: 3x Hochleistungs-LED, Leistung: ca. 3,0W
 lamp: 3x high performance LED, power: approx. 3,0W

inkl. Konverter für 230V Direktanschluss / Converter for direct connection 230V incl.



Art.-Nr. art-no.	Lichtfarbe light colour	Farbtemperatur colour temperature	Preis € price €
500952W	kaltweiß / cold white ●	6500K	186,00

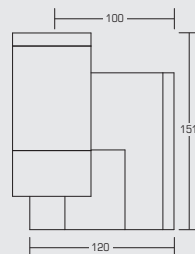

Deko LED-Wandaufbauleuchten | Deco LED-wall lights

Deko LED-Wandaufbauleuchten | Deco LED-wall lights

500350W



Dekorative LED-Wandaufbauleuchte / Decorative LED-wall light

Material: Aluminium / Acryl / material: aluminium/ acryl
 Farbe: aluminium / colour: aluminium
 Bestückung: 1x Hochleistungs-LED, Leistung: ca. 1,0W
 lamp: 1x high performance LED, power: approx. 1,0W

inkl. Konverter für 230V Direktanschluss / Converter for direct connection 230V incl.

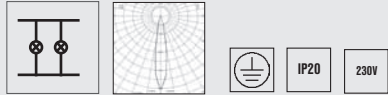

Art.-Nr. art-no.	Lichtfarbe light colour	Farbtemperatur colour temperature	Linse lense	Preis € price €
500350W	kaltweiß /cold white ●	6500K	10°	119,00

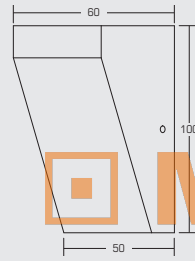

500235W



Dekorative LED-Wandaufbauleuchte / Decorative LED-wall light

Material: Aluminium / Kunststoff / material: aluminium / plastic
 Farbe: aluminium / colour: aluminium
 Bestückung: 1x Hochleistungs-LED, Leistung: ca. 1,0W
 lamp: 1x high performance LED, power: approx. 1,0W

inkl. Konverter für 230V Direktanschluss
 Converter for direct connection 230V incl.



Art.-Nr. art-no.	Lichtfarbe light colour	Farbtemperatur colour temperature	Linse lense	Preis € price €
500235W	kaltweiß /cold white ●	6500K	10°	129,00

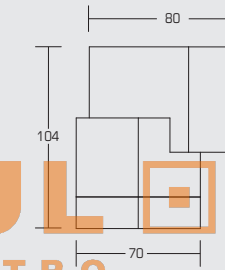

500238W

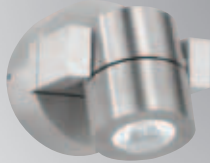

Dekorative LED-Wandaufbauleuchte / Decorative LED-wall light

Material: Aluminium / material: aluminium
 Farbe: aluminium / colour: aluminium
 Bestückung: 1x Hochleistungs-LED, Leistung: ca. 1,0W
 lamp: 1x high performance LED, power: approx. 1,0W

inkl. Konverter für 230V Direktanschluss / Converter for direct connection 230V incl.

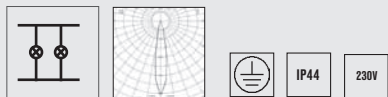

Art.-Nr. art-no.	Lichtfarbe light colour	Farbtemperatur colour temperature	Linse lense	Preis € price €
500238W	kaltweiß /cold white ●	6500K	10°	139,00

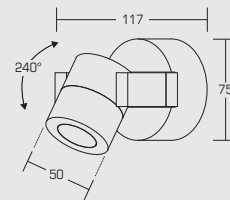

500236W



Dekorative LED-Wandaufbauleuchte / Decorative LED-wall light

Material: Aluminium / Kunststoff / material: aluminium / plastic
 Farbe: aluminium / colour: aluminium
 Bestückung: 2x Hochleistungs-LED, Leistung: ca. 2,0W
 lamp: 2x high performance LED, power: approx. 2,0W

inkl. Konverter für 230V Direktanschluss
 Converter for direct connection 230V incl.



Art.-Nr. art-no.	Lichtfarbe light colour	Farbtemperatur colour temperature	Linse lense	Preis € price €
500236W	kaltweiß /cold white ●	6500K	10°	189,00

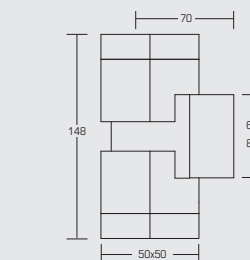

www.modulelectro.ru

Deko LED-Wandaufbauleuchten | Deco LED-wall lights

500352W



Dekorative LED-Wandaufbauleuchte / Decorative LED-wall light

Material: Aluminium / Kunststoff / material: aluminium / plastic
 Farbe: aluminium / colour: aluminium
 Bestückung: 2x Hochleistungs-LED, Leistung: ca. 2,0W
 lamp: 2x high performance LED, power: approx. 2,0W

Inkl. Konverter für 230V Direktanschluss / Converter for direct connection 230V incl.

up and down

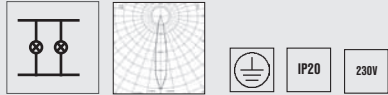

Art.-Nr. art-no.	Lichtfarbe light colour	Farbtemperatur colour temperature	Linse lense	Preis € price €
500352W	kaltweiß / cold white ●	6500K	10°	159,00

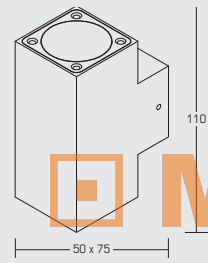

LED-Hausnummernleuchten | LED-house number lights

3908W



LED-Hausnummernleuchte / LED-house number light

Material: Aluminium / Acryl / material: aluminium / acryl
 Farbe: alu matt / colour: aluminium satin
 Bestückung: 1x Hochleistungs-LED, Leistung: ca. 1,0W
 lamp: 1x high performance LED, power: approx. 1,0W

Inkl. Konverter für 230V Direktanschluss
 Converter for direct connection 230V incl.

Beschriftung wahlweise / marking optional
 Weitere Lichtfarben auf Anfrage!
 other light colours on demand!



Art.-Nr. art-no.	Lichtfarbe light colour	Farbtemperatur colour temperature	Preis € price €
3908W	kaltweiß / cold white ●	6500K	254,00

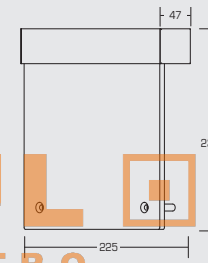

3177LED



V4A Edelstahl-Wandanbauleuchte / V4A stainless steel LED-wall light

Material: V4A Edelstahl / Glas / material: V4A stainless steel / glass
 Farbe: edelstahl / colour: stainless steel
 Bestückung: 2x GU10 LED (3x1W), Leistung: ca. 6,0W
 lamp: 2x GU10 LED (3x1W), power: approx. 6,0W

für 230V Direktanschluss / for direct connection 230V

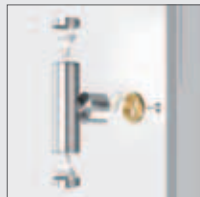

Art.-Nr. art-no.	Lichtfarbe light colour	Farbtemperatur colour temperature	Preis € price €
3177LED	kaltweiß / cold white ●	6500K	282,50

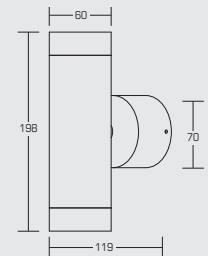

LED-Hinweisleuchte / LED-advice light

Material: Aluminium / Acryl / material: aluminium / acryl
 Farbe: alu matt / colour: aluminium satin
 Bestückung: 1x Hochleistungs-LED, Leistung: ca. 1,0W
 lamp: 1x high performance LED, power: approx. 1,0W

Inkl. Konverter für 230V Direktanschluss
 Converter for direct connection 230V incl.

Beschriftung wahlweise / marking optional
 Weitere Lichtfarben auf Anfrage!
 other light colours on demand!



3917W



Art.-Nr. art-no.	Lichtfarbe light colour	Farbtemperatur colour temperature	Preis € price €
3917W	kaltweiß / cold white ●	6500K	312,00

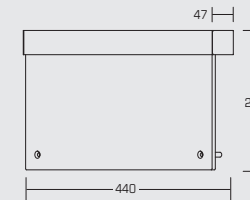

MODUL
ELECTRO
www.modulelectro.ru

3900W

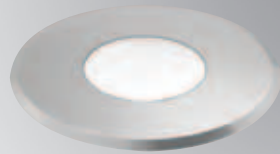

INDOOR

LED-Bodeneinbauleuchte / LED-in-ground light

Material: Edelstahl / Acryl / material: stainless steel / acryl
 Farbe: edelstahl / colour: stainless steel
 Bestückung: 3x SMD-LED, Leistung: ca. 0,4W
 lamp: 3x SMD-LED, power: approx. 0,4W

Die Anschlussleitung Artikel 3714 und Verbindungsleitung Artikel 3715 müssen separat bestellt werden (siehe folgend)!
 the connecting cable article 3714 and coupler article 3715 must be ordered separately (see following)!



Art.-Nr. art.-no.	Lichtfarbe light colour	Farbtemperatur colour temperature	Preis € price €
3900W	kaltweiß / cold white	6500K	59,00

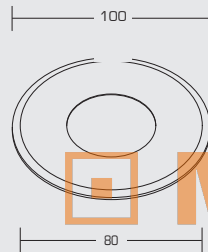

3711

**Unterputzdose (rund) für Artikel 3900W
in-wall box (round) for article 3900W**

Farbe: grau / colour: grey
 Schutzart: IP20 / degree of protection: IP20
 Maße: Ø 84 x ET 56mm
 dimensions: Ø 84 x installation depth 56mm

Art.-Nr. art.-no.	Preis € price €
3711	5,80



3559

**Rundtrafo 10W
round transformer 10W**

Leitungslänge: prim. 90 mm, sek. 80 mm / cable length: prim. 90 mm, sec. 80 mm
 AMP-Kupplung, prim. 230V, sek. 12V/DC / AMP-connector, prim. 230V, sec. 12V/DC

Farbe: blau / colour: blue
 Schutzart: IP20 / degree of protection: IP20
 Schutzklasse: II / protection class: II
 Maße: Ø 57,5 x ET 19mm
 dimensions: Ø 57,5 x installation depth 19mm

Art.-Nr. art.-no.	Preis € price €
3559	59,00



MODUL
ELECTRO
www.modulelectro.ru

3713

**Unterputzdose für Rundtrafo, 2-teilig
in-wall box for round transformer, 2-pieces**

zur Unterputz-Montage hinter Sockelleiste / for in-wall mounting behind baseboard

Farbe: grau / colour: grey
 Schutzart: IP20 / degree of protection: IP20
 Maße: Ø 84 x ET 62,5mm
 dimensions: Ø 84 x installation depth 62,5mm

Art.-Nr. art.-no.	Preis € price €
3713	3,90



3714/3715

**Anschlussleitung / Verbindungsleitung
connection / coupler**

3714: Leitung 2x 0,34 schwarz, Länge 5000 mm, zum Anschluss von Trafo (sekundär) zur ersten Leuchte, JST-Kupplung für Leuchtenanschluss, AMP-Stecker zum Trafo-Anschluss
 3714: Cable 2 x 0,34 black, 5000 mm length, for connection between transformer (secondary) and first luminaire, JST coupler for lamp connection, AMP-plug for transformer connection

3715: Leitung 2x 0,34 schwarz, Länge 2000 mm, zum Verbinden von Leuchte zu Leuchte
 3715: Cable 2 x 0,34 black, 2000 mm length, for connection among lamps

Art.-Nr. art.-no.	Preis € price €
3714	6,80
3715	6,80

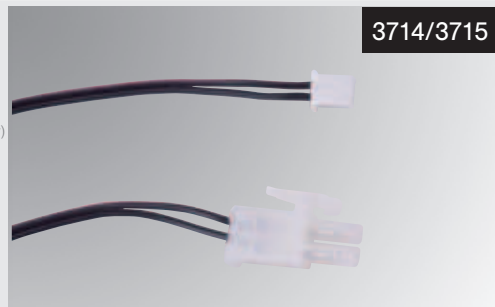

3901W



INDOOR

LED-Bodeneinbauleuchte / LED-in-ground light

Material: Edelstahl / Acryl / material: stainless steel / acryl
 Farbe: edelstahl / colour: stainless steel
 Bestückung: 3x SMD-LED, Leistung: ca. 0,4W
 lamp: 3x SMD-LED, power: approx. 0,4W

Die Anschlussleitung Artikel 3714 und Verbindungsleitung Artikel 3715 müssen separat bestellt werden (siehe folgend)!
 the connecting cable article 3714 and coupler article 3715 must be ordered separatly (see following)!



Art.-Nr. art.-no.	Lichtfarbe light colour	Farbtemperatur colour temperature	Preis € price €
3901W	kaltweiß /cold white ●	6500K	59,00

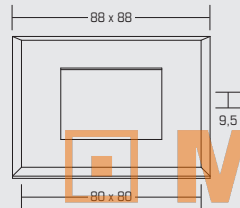

www.modulelectro.ru

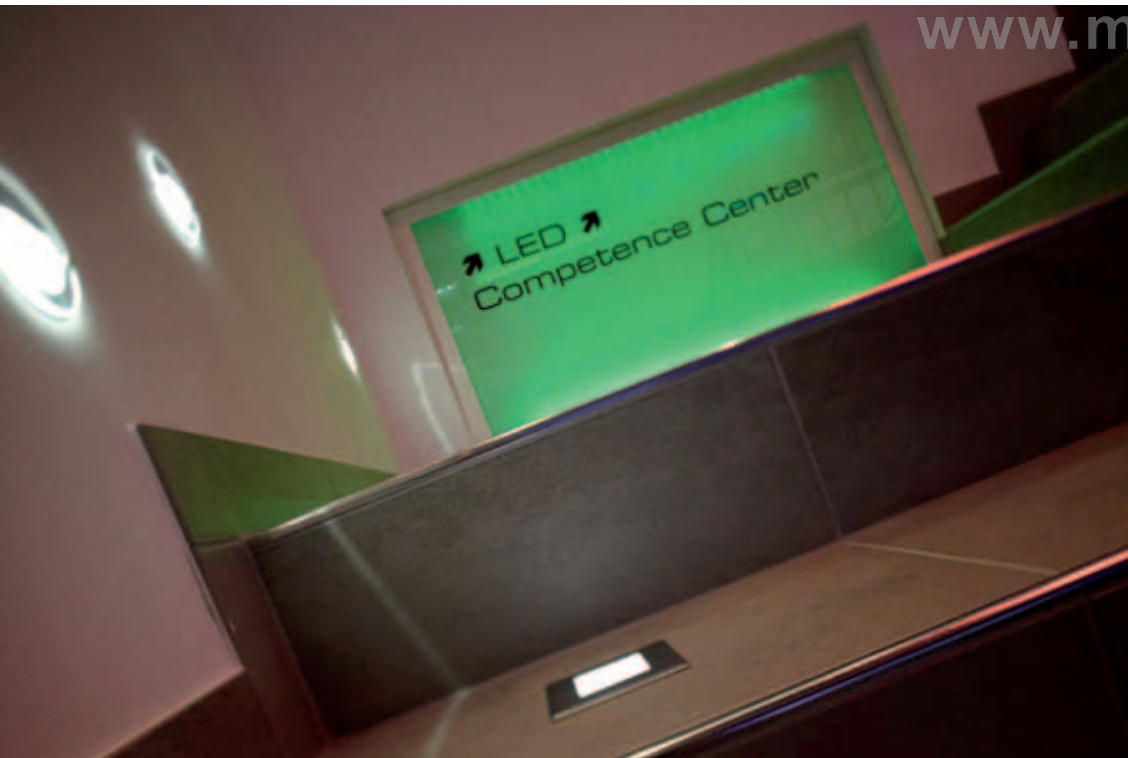

**Unterputzdose (rund) für Artikel 3900W
 in-wall box (round) for article 3900W**

Farbe: grau / colour: grey
 Schutzart: IP20 / degree of protection: IP20
 Maße: Ø 84 x ET 56mm
 dimensions: Ø 84 x installation depth 56mm

Art.-Nr. art.-no.	Preis € price €
3712	5,80

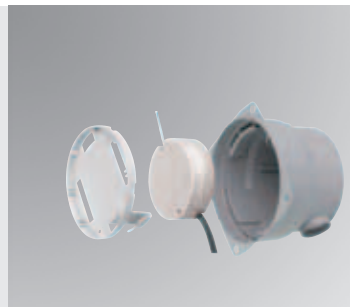

3712

**Rundtrafo 10W
 round transformer 10W**

Leitungslänge: prim. 90 mm, sek. 80 mm / cable length: prim. 90 mm, sec. 80 mm
 AMP-Kupplung, prim. 230V, sek. 12V/DC / AMP-connector, prim. 230V, sec. 12V/DC

Farbe: blau / colour: blue
 Schutzart: IP20 / degree of protection: IP20
 Schutzklasse: II / protection class: II
 Maße: Ø 57,5 x ET 19mm
 dimensions: Ø 57,5 x installation depth 19mm

Art.-Nr. art.-no.	Preis € price €
3559	59,00

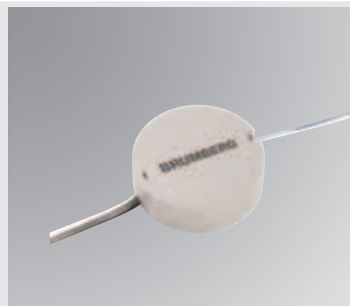

3559

**Unterputzdose für Rundtrafo, 2-teilig
 in-wall box for round transformer, 2-pieces**

zur Unterputz-Montage hinter Sockelleiste / for in-wall mounting behind baseboard

Farbe: grau / colour: grey
 Schutzart: IP20 / degree of protection: IP20
 Maße: Ø 84 x ET 62,5mm
 dimensions: Ø 84 x installation depth 62,5mm

Art.-Nr. art.-no.	Preis € price €
3713	3,90

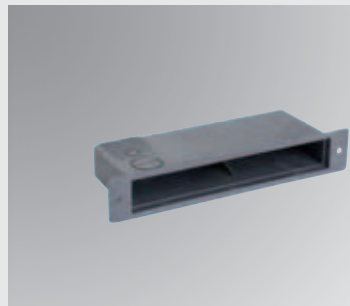

3713

**Anschlussleitung / Verbindungsleitung
 connection / coupler**

3714: Leitung 2x 0,34 schwarz, Länge 5000 mm, zum Anschluss von Trafo (sekundär) zur ersten Leuchte, JST-Kupplung für Leuchtenanschluss, AMP-Stecker zum Trafo-Anschluss
 3714: Cable 2 x 0,34 black, 5000 mm length, for connection between transformer (secondary) and first luminaire, JST coupler for lamp connection, AMP-plug for transformer connection

3715: Leitung 2x 0,34 schwarz, Länge 2000 mm, zum Verbinden von Leuchte zu Leuchte
 3715: Cable 2 x 0,34 black, 2000 mm length, for connection among lamps

Art.-Nr. art.-no.	Preis € price €
3714	6,80
3715	6,80

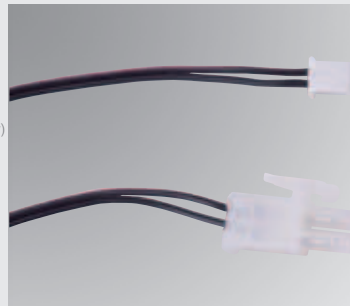

3714/3715

LED-Bodeneinbauleuchten | LED-in-ground lights

LED-Bodeneinbauleuchten | LED-in-ground lights

P3817...

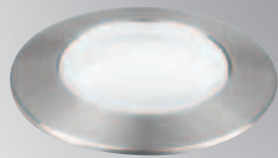

LED-Bodeneinbauleuchte / LED-in-ground light

Material: Aluminium / Edelstahl / Glas satiniert
material: aluminium / stainless steel / glass satined
Farbe: edelstahl / colour: stainless steel
Bestückung: 1x Hochleistungs-LED, Leistung: ca. 1,0W
lamp: 1x high performance LED, power: approx. 1,0W

Belastbar bis 1000 kg / load capacity up to 1000 kg

inkl. Montagehülse / incl. mounting sleeve

→ Konverter siehe Seite 442,445
 → converter see pages 442-445

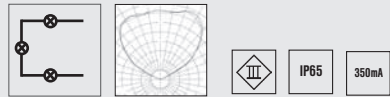
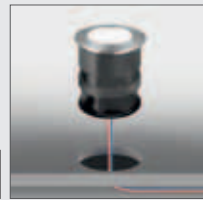

Art.-Nr. art-no.	Lichtfarbe light colour	Farbtemperatur colour temperature	Preis € price €
P3817W	kaltweiß / cold white	6500K	99,80
P3817WW	warmweiß / warm white	3100K	99,80
P3817B	blau / blue		99,80
P3817R	rot / red		99,80
P3817Y	orange / orange		99,80
P3817G	grün / green		99,80

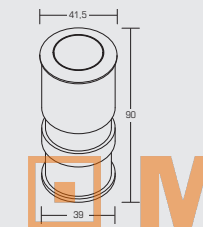

P3803...

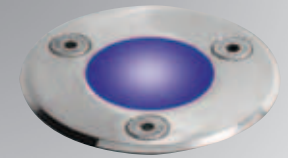

LED-Bodeneinbauleuchte / LED-in-ground light

Material: Aluminium / Edelstahl / Glas satiniert
material: aluminium / stainless steel / glass satined
Farbe: edelstahl / colour: stainless steel
Bestückung: 1x Hochleistungs-LED, Leistung: ca. 1,0W
lamp: 1x high performance LED, power: approx. 1,0W

Belastbar bis 1000 kg / load capacity up to 1000 kg

inkl. Montagehülse / incl. mounting sleeve

→ Konverter siehe Seite 442,445
 → converter see pages 442-445

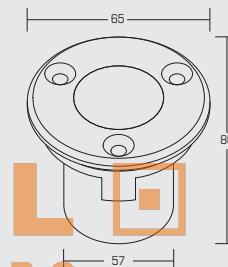
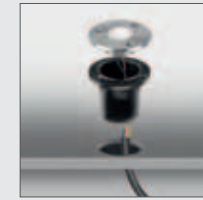

Art.-Nr. art-no.	Lichtfarbe light colour	Farbtemperatur colour temperature	Preis € price €
P3803W	kaltweiß / cold white	6500K	139,50
P3803WW	warmweiß / warm white	3100K	139,50
P3803B	blau / blue		139,50
P3803R	rot / red		139,50
P3803Y	orange / orange		139,50
P3803G	grün / green		139,50

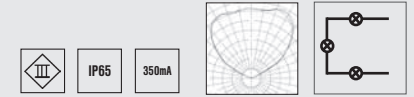

P3816...

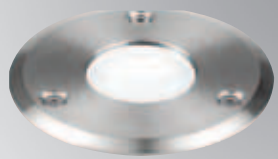

LED-Bodeneinbauleuchte / LED-in-ground light

Material: Aluminium / Edelstahl / Glas satiniert
material: aluminium / stainless steel / glass satined
Farbe: edelstahl / colour: stainless steel
Bestückung: 1x Hochleistungs-LED, Leistung: ca. 1,0W
lamp: 1x high performance LED, power: approx. 1,0W

Belastbar bis 1000 kg / load capacity up to 1000 kg

inkl. Montagehülse / incl. mounting sleeve

→ Konverter siehe Seite 442,445
 → converter see pages 442-445

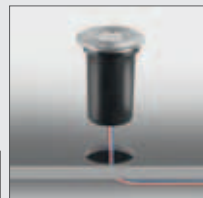

Art.-Nr. art-no.	Lichtfarbe light colour	Farbtemperatur colour temperature	Preis € price €
P3816W	kaltweiß / cold white	6500K	99,80
P3816WW	warmweiß / warm white	3100K	99,80
P3816B	blau / blue		99,80
P3816R	rot / red		99,80
P3816Y	orange / orange		99,80
P3816G	grün / green		99,80

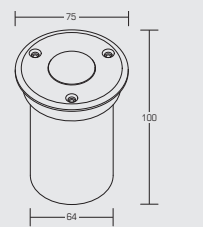

P3801...

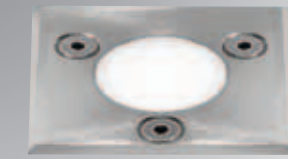

LED-Bodeneinbauleuchte / LED-in-ground light

Material: Aluminium / Edelstahl / Glas satiniert
material: aluminium / stainless steel / glass satined
Farbe: edelstahl / colour: stainless steel
Bestückung: 1x Hochleistungs-LED, Leistung: ca. 1,0W
lamp: 1x high performance LED, power: approx. 1,0W

Belastbar bis 1000 kg / load capacity up to 1000 kg

inkl. Montagehülse / incl. mounting sleeve

→ Konverter siehe Seite 442,445
 → converter see pages 442-445

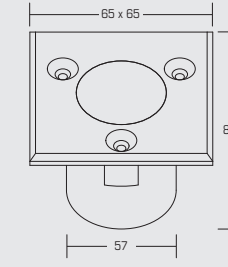

Art.-Nr. art-no.	Lichtfarbe light colour	Farbtemperatur colour temperature	Preis € price €
P3801W	kaltweiß / cold white	6500K	139,50
P3801WW	warmweiß / warm white	3100K	139,50
P3801B	blau / blue		139,50
P3801R	rot / red		139,50
P3801Y	orange / orange		139,50
P3801G	grün / green		139,50

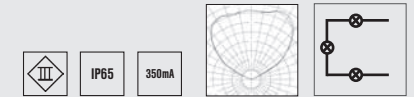

www.modulelectro.ru

MODUL ELECTRO

LED-Bodeneinbauleuchten | LED-in-ground lights

LED-Bodeneinbauleuchten | LED-in-ground lights

R3861...



LED-Bodeneinbauleuchte / LED-in-ground light

Material: Aluminium / Edelstahl / Glas satiniert
material: aluminium / stainless steel / glass satined
Farbe: edelstahl / colour: stainless steel
Bestückung: 3x Hochleistungs-LED, Leistung: ca. 4,2W
lamp: 3x high performance LED, power: approx. 4,2W

Belastbar bis 1000 kg / load capacity up to 1000 kg

inkl. Montagehülse (bei Verwendung der Montagehülse Bodenausschnitt 112mm)
 incl. mounting sleeve (ground cut-out 112mm when using mounting sleeve)

→ Konverter siehe Seite 450-451
 → converter see pages 450-451

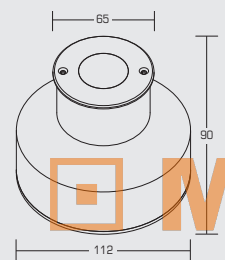

Art.-Nr. art.-no.	Lichtfarbe light colour	Farbtemperatur colour temperature	Preis € price €
R3861W	kaltweiß / cold white	6500K	112,30
R3861WW	warmweiß / warm white	3100K	112,30
R3861B	blau / blue		112,30
R3861R	rot / red		112,30
R3861Y	orange / orange		112,30
R3861G	grün / green		112,30

P3807...

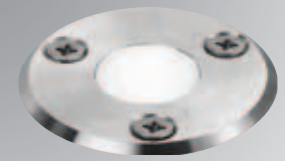

LED-Bodeneinbauleuchte / LED-in-ground light

Material: Aluminium / Edelstahl / Glas opalisiert
material: aluminium / stainless steel / glass opal
Farbe: edelstahl / colour: stainless steel
Bestückung: 1x Hochleistungs-LED, Leistung: ca. 1,0W
lamp: 1x high performance LED, power: approx. 1,0W

Belastbar bis 1000 kg (nur in Verbindung mit Art. 3807)
 load capacity up to 1000 kg (only in combination with art. 3807)

Montagehülse 3807 muss separat bestellt werden, dann Schutzart IP65
 mounting sleeve 3807 must be ordered separately, then protection class IP65

→ Konverter siehe Seite 442-445
 → converter see pages 442-445

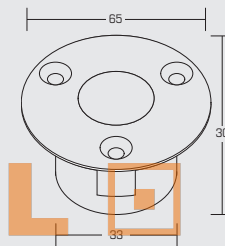

Art.-Nr. art.-no.	Lichtfarbe light colour	Farbtemperatur colour temperature	Preis € price €
P3807W	kaltweiß / cold white	6500K	96,30
P3807WW	warmweiß / warm white	3100K	96,30
P3807B	blau / blue		96,30
P3807R	rot / red		96,30
P3807Y	orange / orange		96,30
P3807G	grün / green		96,30
3807			17,30



www.modulelectro.ru

R3862...



LED-Bodeneinbauleuchte / LED-in-ground light

Material: Aluminium / Edelstahl / Glas satiniert
material: aluminium / stainless steel / glass satined
Farbe: edelstahl / colour: stainless steel
Bestückung: 3x Hochleistungs-LED, Leistung: ca. 4,2W
lamp: 3x high performance LED, power: approx. 4,2W

Belastbar bis 1000 kg / load capacity up to 1000 kg

inkl. Montagehülse (bei Verwendung der Montagehülse Bodenausschnitt 112mm)
 incl. mounting sleeve (ground cut-out 112mm when using mounting sleeve)

→ Konverter siehe Seite 450-451
 → converter see pages 450-451

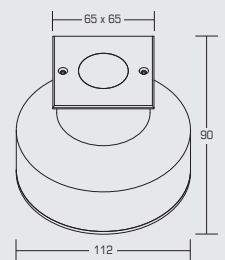

Art.-Nr. art.-no.	Lichtfarbe light colour	Farbtemperatur colour temperature	Preis € price €
R3862W	kaltweiß / cold white	6500K	112,30
R3862WW	warmweiß / warm white	3100K	112,30
R3862B	blau / blue		112,30
R3862R	rot / red		112,30
R3862Y	orange / orange		112,30
R3862G	grün / green		112,30



Weingut Schmidt, Obermoschel a.d. Nahe

LED-Bodeneinbauleuchten | LED-in-ground lights

LED-Bodeneinbauleuchten | LED-in-ground lights

P3863...



LED-Bodeneinbauleuchte / LED-in-ground light

Material: Edelstahl / Aluminium / Kunststoff
material: stainless steel / aluminium / plastic
Farbe: edelstahl / colour: stainless steel
Bestückung: 3x Hochleistungs-LED, Leistung: ca. 4,2W
lamp: 3x high performance LED, power: approx. 4,2W

Belastbar bis 1000 kg / load capacity up to 1000 kg

inkl. Montagehülse / incl. mounting sleeve

inkl. 1,0m Anschlussleitung
 incl. 1,0m connexion cable

→ passende 12V-Konverter siehe Seite 450-451
 → compatible 12V-converter see pages 450-451

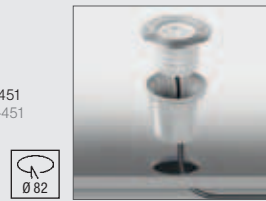
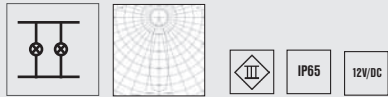

Art.-Nr. art.-no.	Lichtfarbe light colour	Farbtemperatur colour temperature	Preis € price €
P3863W	kaltweiß / cold white	6500K	174,10
P3863NW	neutralweiß / neutral white	4100K	174,10
P3863WW	warmweiß / warm white	3100K	174,10

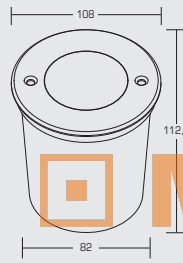

P3867...



LED-Bodeneinbauleuchte / LED-in-ground light

Material: Edelstahl / Aluminium
material: stainless steel / aluminium
Farbe: edelstahl / colour: stainless steel
Bestückung: 3x Hochleistungs-LED, Leistung: ca. 4,2W
lamp: 3x high performance LED, power: approx. 4,2W

inkl. Montagehülse / mounting sleeve incl.

inkl. 1,0m Anschlussleitung
 incl. 1,0m connexion cable

→ passende 12V-Konverter siehe Seite 450-451
 → compatible 12V-converter see pages 450-451

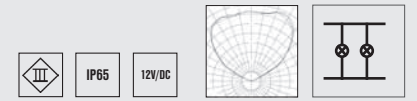
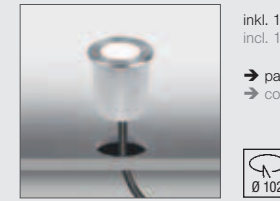

Art.-Nr. art.-no.	Lichtfarbe light colour	Farbtemperatur colour temperature	Preis € price €
P3867W	kaltweiß / cold white	6500K	174,10
P3867NW	neutralweiß / neutral white	4100K	174,10
P3867WW	warmweiß / warm white	3100K	174,10

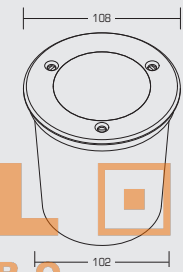

www.modulelectro.ru

P3864...



LED-Erdspießstrahler / LED peg

Material: Edelstahl / Aluminium / Kunststoff
material: stainless steel / aluminium / plastic
Farbe: edelstahl / RAL 9006 / colour: stainless steel / RAL 9006
Bestückung: 3x Hochleistungs-LED, Leistung: ca. 4,2W
lamp: 3x high performance LED, power: approx. 4,2W

inkl. 5m Anschlussleitung / incl. 5m connexion cable

→ passende 12V-Konverter siehe Seite 450-451
 → compatible 12V-converter see pages 450-451



Art.-Nr. art.-no.	Lichtfarbe light colour	Farbtemperatur colour temperature	Preis € price €
P3864W	kaltweiß / cold white	6500K	174,10
P3864NW	neutralweiß / neutral white	4100K	174,10
P3864WW	warmweiß / warm white	3100K	174,10



P3868...



LED-Bodeneinbauleuchte / LED-in-ground light

Material: Edelstahl / Aluminium
material: stainless steel / aluminium
Farbe: edelstahl / colour: stainless steel
Bestückung: 3x Hochleistungs-LED, Leistung: ca. 4,2W
lamp: 3x high performance LED, power: approx. 4,2W

inkl. Montagehülse / mounting sleeve incl.

inkl. 1,0m Anschlussleitung
 incl. 1,0m connexion cable

→ passende 12V-Konverter siehe Seite 450-451
 → compatible 12V-converter see pages 450-451

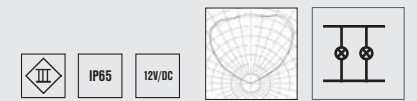

Art.-Nr. art.-no.	Lichtfarbe light colour	Farbtemperatur colour temperature	Preis € price €
P3868W	kaltweiß / cold white	6500K	184,40
P3868NW	neutralweiß / neutral white	4100K	184,40
P3868WW	warmweiß / warm white	3100K	184,40

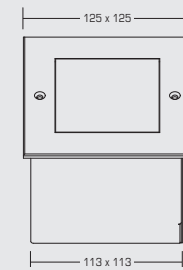

LED-Bodeneinbauleuchten | LED-in-ground lights

LED-Bodeneinbauleuchten | LED-in-ground lights

P3825...



LED-Bodeneinbauleuchte / LED-in-ground light

Material: Edelstahl / Kunststoff / Glas klar
 material: stainless steel / plastic / glass clear
Farbe: edelstahl / colour: stainless steel
Bestückung: 1x Hochleistungs-LED, Leistung: ca. 1,0W
 lamp: 1x high performance LED, power: approx. 1,0W

Belastbar bis 1000 kg / load capacity up to 1000 kg

inkl. Montagehülse / incl. mounting sleeve

inkl. Konverter für 230V-Direktanschluss
 incl. converter for 230V-direct connexion

2x M20 Verschraubung für Durchgangsverdrahtung
 2x M20 fitting for Feed-through wiring

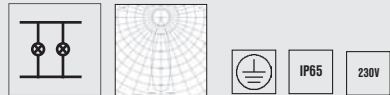
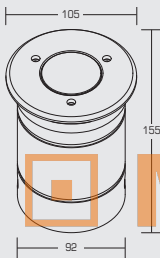

Art.-Nr. art-no.	Lichtfarbe light colour	Farbtemperatur colour temperature	Linse lense	Preis € price €
P3825W	kaltweiß / cold white	6500K	10°	176,00
P3825WW	warmweiß / warm white	3100K	10°	176,00
P3825B	blau / blue		10°	176,00
P3825R	rot / red		10°	176,00
P3825Y	orange / orange		10°	176,00
P3825G	grün / green		10°	176,00

P3804...



LED-Bodeneinbauleuchte / LED-in-ground light

Material: Edelstahl / Kunststoff / Acryl opal
 material: stainless steel / plastic / acryl opal
Farbe: edelstahl / colour: stainless steel
Bestückung: 1x Hochleistungs-LED, Leistung: ca. 1,0W
 lamp: 1x high performance LED, power: approx. 1,0W

Belastbar bis 1000 kg / load capacity up to 1000 kg

inkl. Montagehülse / incl. mounting sleeve

inkl. Konverter für 230V-Direktanschluss
 incl. converter for 230V-direct connexion

1x M20 Verschraubung
 1x M20 fitting

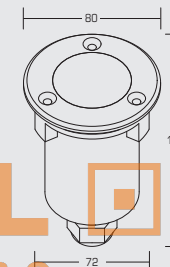
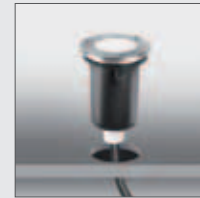

Art.-Nr. art-no.	Lichtfarbe light colour	Farbtemperatur colour temperature	Preis € price €
P3804W	kaltweiß / cold white	6500K	188,00
P3804WW	warmweiß / warm white	3100K	188,00
P3804B	blau / blue		188,00
P3804R	rot / red		188,00
P3804Y	orange / orange		188,00
P3804G	grün / green		188,00

P3826...

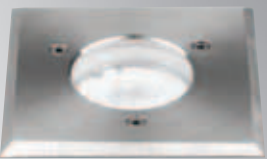

LED-Bodeneinbauleuchte / LED-in-ground light

Material: Edelstahl / Kunststoff / Glas klar
 material: stainless steel / plastic / glass clear
Farbe: edelstahl / colour: stainless steel
Bestückung: 1x Hochleistungs-LED, Leistung: ca. 1,0W
 lamp: 1x high performance LED, power: approx. 1,0W

Belastbar bis 1000 kg / load capacity up to 1000 kg

inkl. Montagehülse / incl. mounting sleeve

inkl. Konverter für 230V-Direktanschluss
 incl. converter for 230V-direct connexion

2x M20 Verschraubung für Durchgangsverdrahtung
 2x M20 fitting for Feed-through wiring

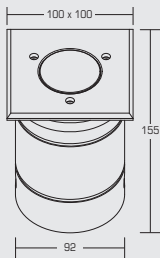

Art.-Nr. art-no.	Lichtfarbe light colour	Farbtemperatur colour temperature	Linse lense	Preis € price €
P3826W	kaltweiß / cold white	6500K	10°	176,00
P3826WW	warmweiß / warm white	3100K	10°	176,00
P3826B	blau / blue		10°	176,00
P3826R	rot / red		10°	176,00
P3826Y	orange / orange		10°	176,00
P3826G	grün / green		10°	176,00

www.modulelectro.ru

LED-Bodeneinbauleuchte / LED-in-ground light

Material: Edelstahl / Kunststoff / Acryl opal
 material: stainless steel / plastic / acryl opal
Farbe: edelstahl / colour: stainless steel
Bestückung: 1x Hochleistungs-LED, Leistung: ca. 1,0W
 lamp: 1x high performance LED, power: approx. 1,0W

Belastbar bis 1000 kg / load capacity up to 1000 kg

inkl. Montagehülse / incl. mounting sleeve

inkl. Konverter für 230V-Direktanschluss
 incl. converter for 230V-direct connexion

1x M20 Verschraubung
 1x M20 fitting

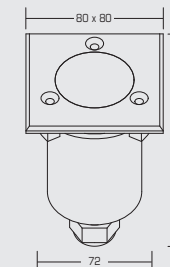

Art.-Nr. art-no.	Lichtfarbe light colour	Farbtemperatur colour temperature	Preis € price €
P3802W	kaltweiß / cold white	6500K	188,00
P3802WW	warmweiß / warm white	3100K	188,00
P3802B	blau / blue		188,00
P3802R	rot / red		188,00
P3802Y	orange / orange		188,00
P3802G	grün / green		188,00

P3802...

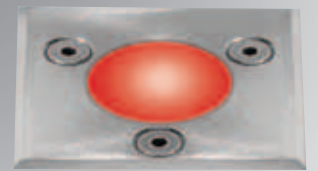

LED-Bodeneinbauleuchten | LED-in-ground lights

LED-Bodeneinbauleuchten | LED-in-ground lights

R3825...



LED-Bodeneinbauleuchte / LED-in-ground light

Material: Edelstahl / Glas klar
 material: stainless steel / glass clear
Farbe: edelstahl / colour: stainless steel
Bestückung: 3x Hochleistungs-LED, Leistung: ca. 3,6W
 lamp: 3x high performance LED, power: approx. 4,2W

Belastbar bis 1000 kg / load capacity up to 1000 kg

inkl. Montagehülse / incl. mounting sleeve

inkl. Konverter für 230V-Direktanschluss
 incl. converter for 230V-direct connexion

2x M20 Verschraubung für Durchgangsverdrahtung
 2x M20 fitting for Feed-through wiring

andere Lichtfarben auf Anfrage erhältlich
 other light colours available on demand

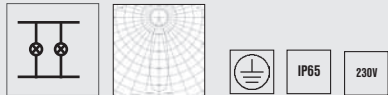
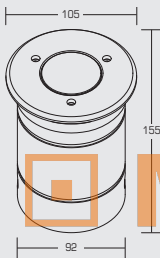
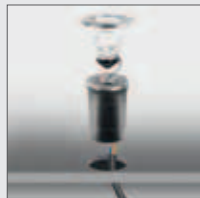

Art.-Nr. art-no.	Lichtfarbe light colour	Farbtemperatur colour temperature	Linse lense	Preis € price €
R3825W	kaltweiß / cold white	6500K	45°	188,00
R3825NW	neutralweiß / neutral white	4100K	45°	188,00
R3825WW	warmweiß / warmwhite	3100K	45°	188,00

P3859...



LED-Bodeneinbauleuchte / LED-in-ground light

Material: Edelstahl / Kunststoff / Glas klar
 material: stainless steel / plastic / glass clear
Farbe: edelstahl / colour: stainless steel
Bestückung: 9x Hochleistungs-LED, Leistung: ca. 9,0W
 lamp: 9x high performance LED, power: approx. 9,0W

Belastbar bis 1000 kg / load capacity up to 1000 kg

inkl. Montagehülse / incl. mounting sleeve

inkl. optischer Linsen 10° / incl. optical lenses 10°

inkl. Konverter für 230V-Direktanschluss
 incl. converter for 230V-direct connexion

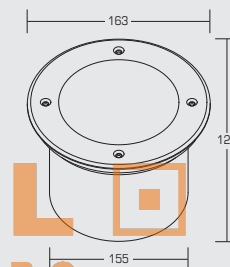

Art.-Nr. art-no.	Lichtfarbe light colour	Farbtemperatur colour temperature	Linse lense	Preis € price €
P3859W	kaltweiß / cold white	6500K	10°	486,00
P3859WW	warmweiß / warm white	3100K	10°	486,00
P3859B	blau / blue		10°	486,00
P3859R	rot / red		10°	486,00
P3859Y	orange / orange		10°	486,00
P3859G	grün / green		10°	486,00



R3826...



LED-Bodeneinbauleuchte / LED-in-ground light

Material: Edelstahl / Glas klar
 material: stainless steel / glass clear
Farbe: edelstahl / colour: stainless steel
Bestückung: 3x Hochleistungs-LED, Leistung: ca. 3,6W
 lamp: 3x high performance LED, power: approx. 4,6W

Belastbar bis 1000 kg / load capacity up to 1000 kg

inkl. Montagehülse / incl. mounting sleeve

inkl. Konverter für 230V-Direktanschluss
 incl. converter for 230V-direct connexion

2x M20 Verschraubung für Durchgangsverdrahtung
 2x M20 fitting for Feed-through wiring

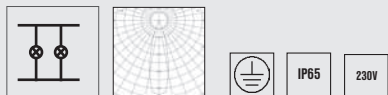
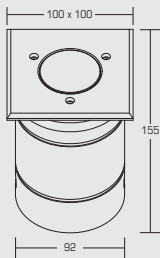
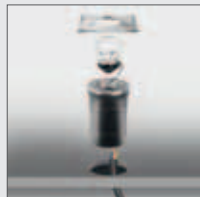

Art.-Nr. art-no.	Lichtfarbe light colour	Farbtemperatur colour temperature	Linse lense	Preis € price €
R3826W	kaltweiß / cold white	6500K	45°	188,00
R3826NW	neutralweiß / neutral white	4100K	45°	188,00
R3826WW	warmweiß / warmwhite	3100K	45°	188,00

LED-Wand- / Deckenanbauleuchte / LED-wall / ceiling light

Material: Edelstahl / Kunststoff / Glas klar
 material: stainless steel / plastic / glass clear
Farbe: edelstahl / colour: stainless steel
Bestückung: 9x Hochleistungs-LED, Leistung: ca. 9,0W
 lamp: 9x high performance LED, power: approx. 9,0W

inkl. optischer Linsen 10° / incl. optical lenses 10°

inkl. 5m Anschlussleitung / incl. 5m connexion cable

→ Konverter siehe Seite 442-445
 → converter see pages 442-445

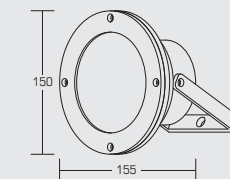

Art.-Nr. art-no.	Lichtfarbe light colour	Farbtemperatur colour temperature	Linse lense	Preis € price €
P3860W	kaltweiß / cold white	6500K	10°	498,00
P3860WW	warmweiß / warm white	3100K	10°	498,00
P3860B	blau / blue		10°	498,00
P3860R	rot / red		10°	498,00
P3860Y	orange / orange		10°	498,00
P3860G	grün / green		10°	498,00

P3860...

www.modulelectro.ru



LED-Profil | LED-profiles

3847...

LED-Profil / LED-profile

Material: Aluminium / Kunststoff (mattiert) / material: aluminium / plastic (satin)
 Bestückung: 60x SMD-LED, Leistung: ca. 4,8W / Meter
 lamp: 60x high performance LED, power: approx. 4,8W / meter
 Maße / dimensions: 1000 x 18 x 19mm

Weitere Profillängen auf Anfrage / other profile length on demand
 Länge min. 50mm - max. 2000mm / length min. 50mm - max. 2000mm

→ Konverter siehe Seite 450-451
 → converter see pages 450-451

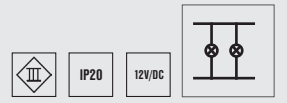

Art.-Nr. art.-no.	Lichtfarbe light colour	Farbtemperatur colour temperature	Preis € price €
3847W	kaltweiß / cold white	6500K	185,00
3847WW	warmweiß / warm white	3100K	185,00
3847B	blau / blue		185,00
3847R	rot / red		185,00
3847Y	orange / orange		185,00
3847G	grün / green		185,00

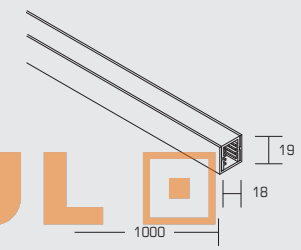

MODUL
ELECTRO

www.modulelectro.ru

3849...

LED-Profil / LED-profile

Material: Aluminium / Kunststoff (mattiert) / material: aluminium / plastic (satin)
 Bestückung: 60x SMD-LED, Leistung: ca. 4,8W / Meter
 lamp: 60x high performance LED, power: approx. 4,8W / meter
 Maße / dimensions: 1000 x 35 x 24,5mm

Weitere Profillängen auf Anfrage / other profile length on demand
 Länge min. 50mm - max. 2000mm / length min. 50mm - max. 2000mm

→ Konverter siehe Seite 450-451
 → converter see pages 450-451

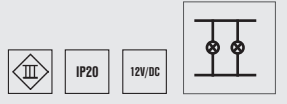
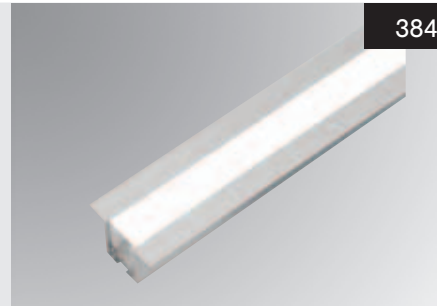

Art.-Nr. art.-no.	Lichtfarbe light colour	Farbtemperatur colour temperature	Preis € price €
3849W	kaltweiß / cold white	6500K	195,00
3849WW	warmweiß / warm white	3100K	195,00
3849B	blau / blue		195,00
3849R	rot / red		195,00
3849Y	orange / orange		195,00
3849G	grün / green		195,00

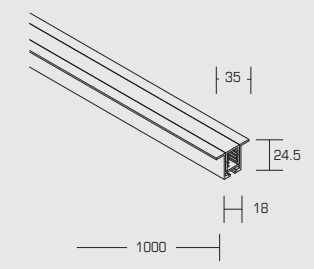

3841...

LED-Profil / LED-profile

Materiale: Aluminium / Acryl / material: aluminium / acryl
chemische Nickel-Goldoberfläche / chemical nickel-gold surface
Bestückung: 50x UHB-SMD-LED, Leistung: ca. 6,25W
Lampe: 50x UHB-SMD-LED LED, power: approx. 6,25W

Weitere Profillängen auf Anfrage / other profile length on demand
Länge min. 40mm - max. 2000mm / length min. 40mm - max. 2000mm

Abstrahlwinkel / angle of reflected beam: 90°
Umgebungstemperatur / operating temperature: 0° bis +45°C
Maße LED-Profil / dimensions LED-profile: 1000 x 13,5 x 11 mm
Maße Unterprofil / dimensions sub-profile: 1000 x 16,5 x 15,5 mm

inkl. Montageprofil / installation profile incl.

→ Konverter siehe Seite 450-451
→ converter see pages 450-451



Art.-Nr. art-no.	Lichtfarbe light colour	Farbtemperatur colour temperature	Preis € price €
3841W50	kaltweiß / cold white	6500K	249,00
3841WW50	warmweiß / warm white	3100K	249,00
3841B50	blau / blue		249,00
3841R50	rot / red		249,00
3841Y50	orange / orange		249,00
3841G50	grün / green		249,00

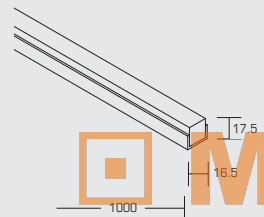

3842...

LED-Profil / LED-profile

Materiale: Aluminium / Acryl / material: aluminium / acryl
chemische Nickel-Goldoberfläche / chemical nickel-gold surface
Bestückung: 50x UHB-SMD-LED, Leistung: ca. 6,25W
Lampe: 50x UHB-SMD-LED LED, power: approx. 6,25W

Weitere Profillängen auf Anfrage / other profile length on demand
Länge min. 50mm - max. 2010mm / length min. 50mm - max. 2010mm

Abstrahlwinkel / angle of reflected beam: 90°
Umgebungstemperatur / operating temperature: 0° bis +45°C

inkl. Montageclips zum Aufschrauben / installation clips to be screwed incl.

→ Konverter siehe Seite 450-451
→ converter see pages 450-451



Art.-Nr. art-no.	Lichtfarbe light colour	Farbtemperatur colour temperature	Preis € price €
3842W50	kaltweiß / cold white	6500K	289,00
3842WW50	warmweiß / warm white	3100K	303,00
3842B50	blau / blue		289,00
3842R50	rot / red		289,00
3842Y50	orange / orange		289,00
3842G50	grün / green		289,00

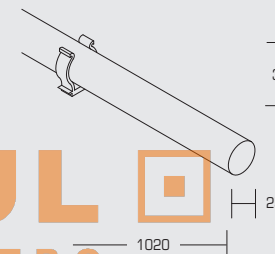

www.modulelectro.ru

3841...IP

LED-Profil / LED-profile

Materiale: Aluminium / Acryl / material: aluminium / acryl
chemische Nickel-Goldoberfläche / chemical nickel-gold surface
Bestückung: 50x UHB-SMD-LED, Leistung: ca. 6,25W
Lampe: 50x UHB-SMD-LED LED, power: approx. 6,25W

Weitere Profillängen auf Anfrage / other profile length on demand
Länge min. 50mm - max. 1010mm / length min. 50mm - max. 1010mm

Abstrahlwinkel / angle of reflected beam: 90°
Umgebungstemperatur / operating temperature: 0° bis +45°C
Maße LED-Profil / dimensions LED-profile: 1010 x 13,5 x 11 mm
Maße Unterprofil / dimensions sub-profile: 1010 x 16,5 x 15,5 mm

inkl. Montageprofil / installation profile incl.

→ Konverter siehe Seite 450-451
→ converter see pages 450-451



Art.-Nr. art-no.	Lichtfarbe light colour	Farbtemperatur colour temperature	Preis € price €
3841WIP	kaltweiß / cold white	6500K	398,00
3841WWIP	warmweiß / warm white	3100K	398,00
3841BIP	blau / blue		398,00
3841RIP	rot / red		398,00
3841YIP	orange / orange		398,00
3841GIP	grün / green		398,00

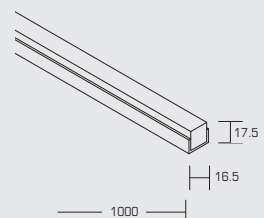

3842...IP

LED-Profil / LED-profile

Materiale: Aluminium / Acryl / material: aluminium / acryl
chemische Nickel-Goldoberfläche / chemical nickel-gold surface
Bestückung: 50x UHB-SMD-LED, Leistung: ca. 6,25W
Lampe: 50x UHB-SMD-LED LED, power: approx. 6,25W

Weitere Profillängen auf Anfrage / other profile length on demand
Länge min. 60mm - max. 1020mm / length min. 60mm - max. 1020mm

Abstrahlwinkel / angle of reflected beam: 90°
Umgebungstemperatur / operating temperature: 0° bis +45°C

inkl. Montageclips zum Aufschrauben / installation clips to be screwed incl.

→ Konverter siehe Seite 450-451
→ converter see pages 450-451



Art.-Nr. art-no.	Lichtfarbe light colour	Farbtemperatur colour temperature	Preis € price €
3842WIP	kaltweiß / cold white	6500K	498,00
3842WWIP	warmweiß / warm white	3100K	532,00
3842BIP	blau / blue		498,00
3842RIP	rot / red		498,00
3842YIP	orange / orange		498,00
3842GIP	grün / green		498,00

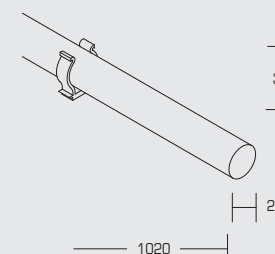



MODUL
ELECTRO
www.modul-electro.ru

3843...

LED-Profil / LED-profile

Material: Aluminium / Acryl / material: aluminium / acryl
chemische Nickel-Goldoberfläche / chemical nickel-gold surface
Bestückung: 100x UHB-SMD-LED, Leistung: ca. 12,5W
lamp: 100x UHB-SMD-LED LED, power: approx. 12,5W

Weitere Profillängen auf Anfrage / other profile length on demand
Länge min. 40mm - max. 2000mm / length min. 40mm - max. 2000mm

Abstrahlwinkel / angle of reflected beam: 90°
Umgebungstemperatur / operating temperature: 0° bis +45°C
Maße LED-Profil / dimensions LED-profile: 1000 x 13,5 x 11 mm
Maße Unterprofil / dimensions sub-profile: 1000 x 16,5 x 15,5 mm

inkl. Montageprofil / installation profile incl.

→ Konverter siehe Seite 450-451
→ converter see pages 450-451



Art.-Nr. art.-no.	Lichtfarbe light colour	Farbtemperatur colour temperature	Preis € price €
3843W10	kaltweiß / cold white	6500K	398,00
3843WW10	warmweiß / warm white	3100K	398,00
3843B10	blau / blue		398,00
3843R10	rot / red		398,00
3843Y10	orange / orange		398,00
3843G10	grün / green		398,00

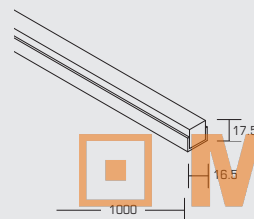

3844...

LED-Profil / LED-profile

Material: Aluminium / Acryl / material: aluminium / acryl
chemische Nickel-Goldoberfläche / chemical nickel-gold surface
Bestückung: 100x UHB-SMD-LED, Leistung: ca. 12,5W
lamp: 100x UHB-SMD-LED LED, power: approx. 12,5W

Weitere Profillängen auf Anfrage / other profile length on demand
Länge min. 50mm - max. 2010mm / length min. 50mm - max. 2010mm

Abstrahlwinkel / angle of reflected beam: 90°
Umgebungstemperatur / operating temperature: 0° bis +45°C

inkl. Montageclips zum Aufschrauben / installation clips to be screwed incl.

→ Konverter siehe Seite 450-451
→ converter see pages 450-451



Art.-Nr. art.-no.	Lichtfarbe light colour	Farbtemperatur colour temperature	Preis € price €
3844W10	kaltweiß / cold white	6500K	449,00
3844WW10	warmweiß / warm white	3100K	449,00
3844B10	blau / blue		449,00
3844R10	rot / red		449,00
3844Y10	orange / orange		449,00
3844G10	grün / green		449,00

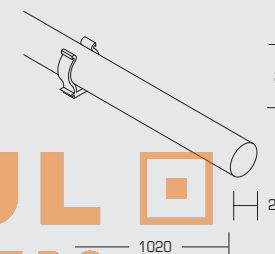

www.modulelectro.ru

MODUL
ELECTRO

3843...IP

LED-Profil / LED-profile

Material: Aluminium / Acryl / material: aluminium / acryl
chemische Nickel-Goldoberfläche / chemical nickel-gold surface
Bestückung: 100x UHB-SMD-LED, Leistung: ca. 12,5W
lamp: 100x UHB-SMD-LED LED, power: approx. 12,5W

Weitere Profillängen auf Anfrage / other profile length on demand
Länge min. 50mm - max. 1010mm / length min. 50mm - max. 1010mm

Abstrahlwinkel / angle of reflected beam: 90°
Umgebungstemperatur / operating temperature: 0° bis +45°C
Maße LED-Profil / dimensions LED-profile: 1000 x 13,5 x 11 mm
Maße Unterprofil / dimensions sub-profile: 1000 x 16,5 x 15,5 mm

inkl. Montageprofil / installation profile incl.

→ Konverter siehe Seite 450-451
→ converter see pages 450-451



Art.-Nr. art.-no.	Lichtfarbe light colour	Farbtemperatur colour temperature	Preis € price €
3843WIP	kaltweiß / cold white	6500K	598,00
3843WWIP	warmweiß / warm white	3100K	640,00
3843BIP	blau / blue		598,00
3843RIP	rot / red		598,00
3843YIP	orange / orange		598,00
3843GIP	grün / green		598,00

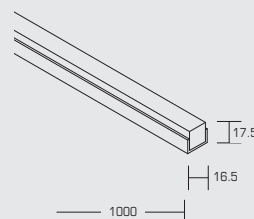

3844...IP

LED-Profil / LED-profile

Material: Aluminium / Acryl / material: aluminium / acryl
chemische Nickel-Goldoberfläche / chemical nickel-gold surface
Bestückung: 100x UHB-SMD-LED, Leistung: ca. 12,5W
lamp: 100x UHB-SMD-LED LED, power: approx. 12,5W

Weitere Profillängen auf Anfrage / other profile length on demand
Länge min. 60mm - max. 1020mm / length min. 60mm - max. 1020mm

Abstrahlwinkel / angle of reflected beam: 90°
Umgebungstemperatur / operating temperature: 0° bis +45°C

inkl. Montageclips zum Aufschrauben / installation clips to be screwed incl.

→ Konverter siehe Seite 450-451
→ converter see pages 450-451



Art.-Nr. art.-no.	Lichtfarbe light colour	Farbtemperatur colour temperature	Preis € price €
3844WIP	kaltweiß / cold white	6500K	698,00
3844WWIP	warmweiß / warm white	3100K	698,00
3844BIP	blau / blue		698,00
3844RIP	rot / red		698,00
3844YIP	orange / orange		698,00
3844GIP	grün / green		698,00

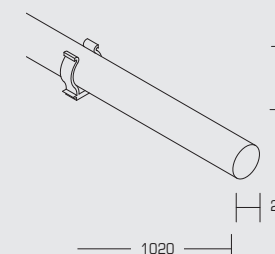

R3833...3



LED-Profil / LED-profile
 Material: Aluminium / material: aluminium
 Farbe: aluminium / colour: aluminium
 Bestückung: 9x Hochleistungs-LED, Leistung: ca. 13,0W
 lamp: 9x high-performance LED, power: approx. 13,0W
 Maße / dimensions: 485 x 31 x 45mm
 inkl. optischer Linsen / incl. optical lenses: 30°
 → Konverter siehe Seite 450-451
 → converter see pages 450-451

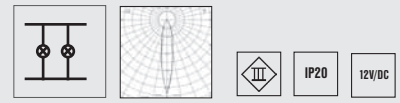

Art.-Nr. art-no.	Lichtfarbe light colour	Farbtemperatur colour temperature	Preis € price €
R3833W3	kaltweiß / cold white	6500K	328,00
R3833NW3	neutralweiß / neutral white	4100K	328,00
R3833WW3	warmweiß / warm white	3100K	328,00

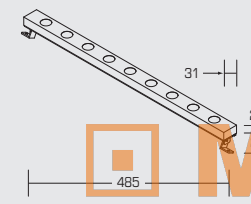

R3833...6

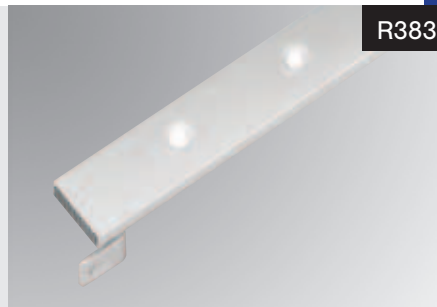

LED-Profil / LED-profile
 Material: Aluminium / Kunststoff / material: aluminium / plastic
 Farbe: aluminium / colour: aluminium
 Bestückung: 9x Hochleistungs-LED, Leistung: ca. 13,0W
 lamp: 9x Rebel-high performance-LED, power: approx. 13,0W
 Maße / dimensions: 485 x 31 x 45mm
 inkl. optischer Linsen / incl. optical lenses: 60°
 → Konverter siehe Seite 450-451
 → converter see pages 450-451

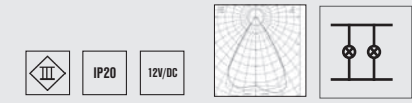

Art.-Nr. art-no.	Lichtfarbe light colour	Farbtemperatur colour temperature	Preis € price €
R3833W6	kaltweiß / cold white	6500K	298,00
R3833NW6	neutralweiß / neutral white	4100K	298,00
R3833WW6	warmweiß / warm white	3100K	298,00

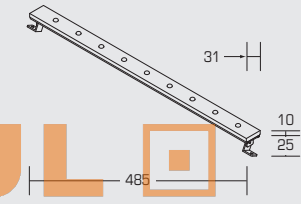

R3834...3

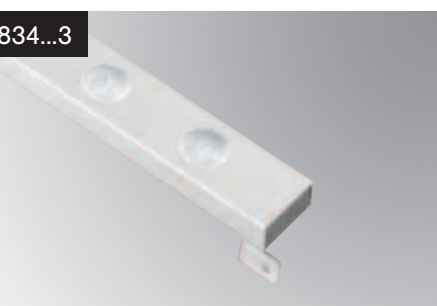

LED-Profil / LED-profile
 Material: Aluminium / material: aluminium
 Farbe: aluminium / colour: aluminium
 Bestückung: 18x Hochleistungs-LED, Leistung: ca. 26,0W
 lamp: 18x high-performance LED, power: approx. 26,0W
 Maße / dimensions: 935 x 31 x 45mm
 inkl. optischer Linsen / incl. optical lenses: 30°
 → Konverter siehe Seite 450-451
 → converter see pages 450-451

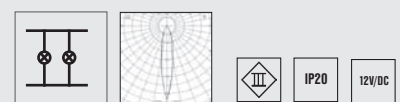

Art.-Nr. art-no.	Lichtfarbe light colour	Farbtemperatur colour temperature	Preis € price €
R3834W3	kaltweiß / cold white	6500K	558,00
R3834NW3	neutralweiß / neutral white	4100K	558,00
R3834WW3	warmweiß / warm white	3100K	558,00

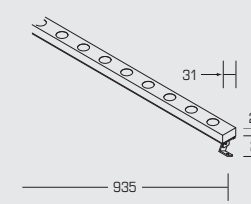

R3834...6

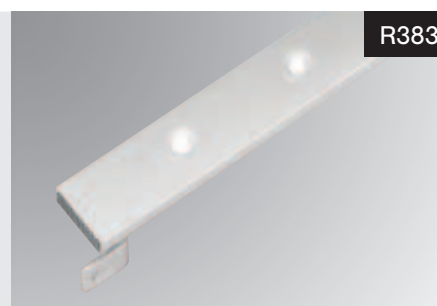

LED-Profil / LED-profile
 Material: Aluminium / Kunststoff / material: aluminium / plastic
 Farbe: aluminium / colour: aluminium
 Bestückung: 18x Hochleistungs-LED, Leistung: ca. 26,0W
 lamp: 18x Rebel-high performance-LED, power: approx. 26,0W
 Maße / dimensions: 935 x 31 x 45mm
 inkl. optischer Linsen / incl. optical lenses: 60°
 → Konverter siehe Seite 450-451
 → converter see pages 450-451

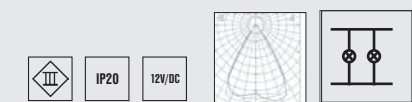

Art.-Nr. art-no.	Lichtfarbe light colour	Farbtemperatur colour temperature	Preis € price €
R3834W6	kaltweiß / cold white	6500K	508,00
R3834NW6	neutralweiß / neutral white	4100K	508,00
R3834WW6	warmweiß / warm white	3100K	508,00

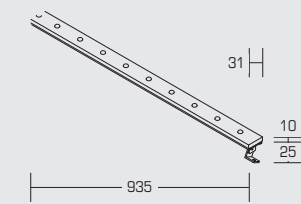

MODULO
ELECTRO
www.modulelectro.ru

R3870...

LED-Profil / LED-profile

Materiale: Aluminium / Acrylglas / material: aluminium / acryl glass
 Bestückung: 9x Hochleistungs-LED, Leistung: ca. 26,0W
 lamp: 9x high-performance LED, power: approx. 26,0W
 Maße / dimensions: 480 x 130 x 68mm

inkl. optischer Linsen / incl. optical lenses: 10°
 inkl. 5,0m Anschlussleitung / incl. 5,0m connexion cable

→ Konverter siehe Seite 450-451
 → converter see pages 450-451

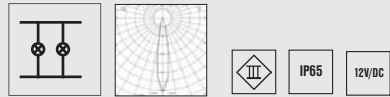

Art.-Nr. art-no.	Lichtfarbe light colour	Farbtemperatur colour temperature	Linse lense	Preis € price €
R3870W	kaltweiß / cold white	6500K	10°	498,00
R3870NW	neutralweiß / neutral white	4100K	10°	498,00
R3870WW	warmweiß / warm white	3100K	10°	498,00

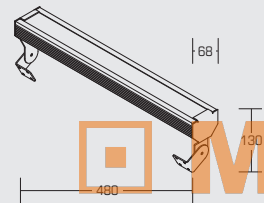

3820/21

LED-Profil / LED-profile

Materiale: Aluminium / material: aluminium

Farben: 3820W = silber, 3821W = gold matt
 colours: 3820W = silver, 3821W = gold satin

Bestückung: 10x SMD-LED / lamp: 10x SMD-LED

LED-Abstand: 10cm im Kunststoff-Vierkant-rohr transparent
 LED-distance: 10cm in plastic-square tube clear

Länge: 1000mm (maximale Länge: 4000mm, min. 300mm)
 length: 1000mm (maximum length: 4000mm, min. 300mm)

Separater Konverter im Lieferumfang!
 Separate converter included!

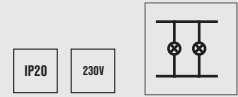
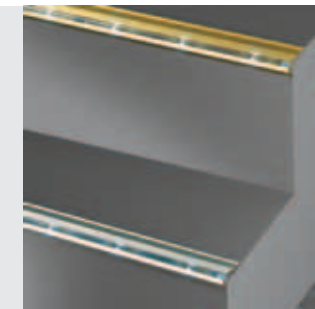

Art.-Nr. art-no.	Lichtfarbe light colour	Farbtemperatur colour temperature	Farbe colour	Preis € price €
3820W	kaltweiß / cold white	6500K	silber / silver	214,50
3821W	kaltweiß / cold white	6500K	gold matt / gold satin	214,50

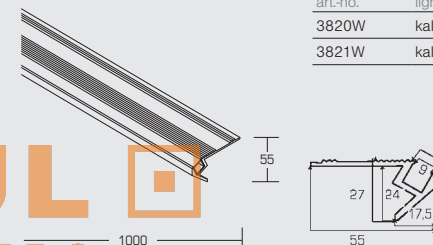

www.modulelectro.ru

R3871...

LED-Profil / LED-profile

Materiale: Aluminium / Acrylglas / material: aluminium / acryl glass
 Bestückung: 9x Hochleistungs-LED, Leistung: ca. 26,0W
 lamp: 9x high-performance LED, power: approx. 26,0W
 Maße / dimensions: 930 x 130 x 68mm

inkl. optischer Linsen / incl. optical lenses: 10°
 inkl. 5,0m Anschlussleitung / incl. 5,0m connexion cable

→ Konverter siehe Seite 450-451
 → converter see pages 450-451



Art.-Nr. art-no.	Lichtfarbe light colour	Farbtemperatur colour temperature	Linse lense	Preis € price €
R3871W	kaltweiß / cold white	6500K	10°	798,00
R3871NW	neutralweiß / neutral white	4100K	10°	798,00
R3871WW	warmweiß / warm white	3100K	10°	798,00

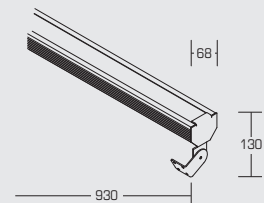

3818/19

LED-Profil / LED-profile

Materiale: Kunststoff / material: plastic

Bestückung: 3818W = 10x SMD-LED, 3819W = 20x SMD-LED
 lamp: 3818W = 10x SMD-LED, 3819W = 20x SMD-LED

LED-Abstand: 10 cm im Kunststoff-Vierkant-rohr transparent
 LED-distance: 10 cm in plastic-square tube clear

Länge: 1000mm (maximale Länge: 4000mm, min. 300mm)
 length: 1000mm (maximum length: 4000mm, min. 300mm)

Separater Konverter im Lieferumfang!
 Separate converter included!

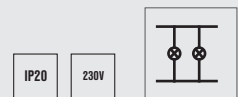
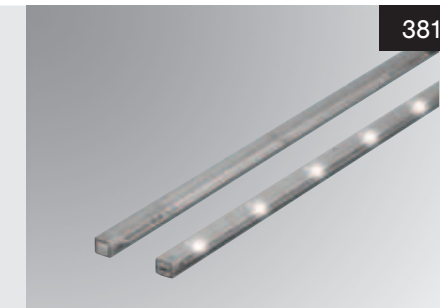

Art.-Nr. art-no.	Lichtfarbe light colour	Farbtemperatur colour temperature	Bestückung lamp	Preis € price €
3818W	kaltweiß / cold white	6500K	10x SMD-LED	149,50
3819W	kaltweiß / cold white	6500K	20x SMD-LED	172,50

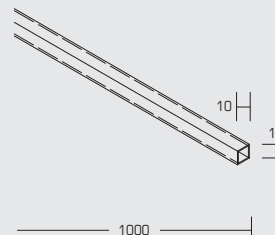

LED-Flexplatine | LED-flexible conductor board

LED-Flexplatine | LED-flexible conductor board

3850...

LED-Flexplatine / LED-flexible conductor board

Bestückung: 300x SMD-LED (60 pro Meter / 5,0W), Leistung: ca. 25,0W
 lamp: 300x SMD - LED (60 per metre / 5,0W), power: approx. 25,0W

Abstrahlwinkel / angle of reflected beam: 120°

teilbar alle 50 mm / scissile every 50 mm

Länge: 5m / length: 5m

→ Konverter siehe Seite 450-451
 → converter see pages 450-451



Art.-Nr. art-no.	Lichtfarbe light colour	Farbtemperatur colour temperature	Abstrahlwinkel angle of reflected beam	Preis € price €
3850W	kaltweiß / cold white	6500K	120°	199,00
3850WW	warmweiß / warm white	3100K	120°	199,00
3850B	blau / blue		120°	199,00
3850R	rot / red		120°	199,00
3850Y	orange / orange		120°	199,00
3850G	grün / green		120°	199,00

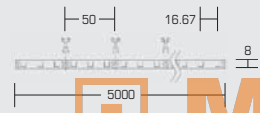

3854...

LED-Flexplatine / LED-flexible conductor board

Material: Kunststoff / material: plastic
 Bestückung: 21 Module à 6 SMD-LED, Leistung: ca. 10,5W
 lamp: 21 modules à 6 SMD-LED, power: approx. 10,5W

Abstrahlwinkel / angle of reflected beam: 120°

→ Konverter siehe Seite 450-451
 → converter see pages 450-451



Art.-Nr. art-no.	Lichtfarbe light colour	Farbtemperatur colour temperature	Abstrahlwinkel angle of reflected beam	Preis € price €
3854W	kaltweiß / cold white	6500K	120°	339,00
3854WW	warmweiß / warm white	3100K	120°	339,00
3854B	blau / blue		120°	339,00
3854R	rot / red		120°	339,00
3854Y	orange / orange		120°	339,00
3854G	grün / green		120°	339,00



3851...

LED-Flexplatine / LED-flexible conductor board

Bestückung: 300x SMD-LED (60 pro Meter / 5,0W), Leistung: ca. 25,0W
 lamp: 300x SMD - LED (60 per metre / 5,0W), power: approx. 25,0W

Abstrahlwinkel / angle of reflected beam: 120°

teilbar alle 50 mm / scissile every 50 mm

Länge: 5m / length: 5m

Bei Trennung der Leiterplatte ist der Installateur für die Einhaltung der Schutzart IP65 verantwortlich!
 The installer becomes liable for maintaining the degree of protection IP65 when cutting the conductor board!

→ Konverter siehe Seite 450-451
 → converter see pages 450-451



Art.-Nr. art-no.	Lichtfarbe light colour	Farbtemperatur colour temperature	Abstrahlwinkel angle of reflected beam	Preis € price €
3851W	kaltweiß / cold white	6500K	120°	249,00
3851WW	warmweiß / warm white	3100K	120°	249,00
3851B	blau / blue		120°	249,00
3851R	rot / red		120°	249,00
3851Y	orange / orange		120°	249,00
3851G	grün / green		120°	249,00

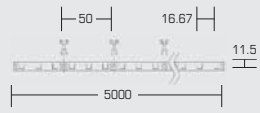

MODUL
ELECTRO

www.modulelectro.ru



Kochschule Johann Lafer, Guldental

2020RGB



NEU new

LED/RGB Einbaulichtpunkt / LED/RGB recessed light point

Material: Messing / Acryl / material: brass / acryl
Farbe: weiß / colour: white
Bestückung: 3x RGB-LED fullcolour, Leistung: ca. 1,2W
lamp: 3x RGB-LED fullcolour, power: approx. 1,2W

Montage in Hohldecken mit Federbefestigung
 Installation into suspended ceilings by spring fixation

inkl. 1,0m Anschlussleitung
 incl. 1,0m connexion cable

Planungshinweis für Systemkomponenten:
Ansteuerung: positiv (gemeinsame Kathode)
 Technical advice for system-components:
 control: positive (combined cathode)

→ Konverter siehe Seite 450-459
 → converter see pages 450-459

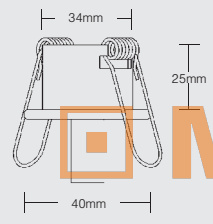

Art.-Nr. art-no.	Lichtfarbe light colour	Preis € price €
2020RGB	rot-grün-blau / red-green-blue	98,00

LED/RGB Deckeneinbaustrahler / LED/RGB recessed ceiling light

Material: Eisen / Aluminium / Kunststoff material: iron / aluminium / plastic
Farbe: nickel matt / colour: nickel satin
Bestückung: 3x RGB-LED fullcolour, Leistung: ca. 13,8W
lamp: 3x RGB-LED fullcolour, power: approx. 13,8W

Montage in Hohldecken mit Federbefestigung
 Installation into suspended ceilings by spring fixation

inkl. optischer Linse 45°
 incl. optical lens 45°

inkl. 1,0m Anschlussleitung
 incl. 1,0m connexion cable

Planungshinweis für Systemkomponenten:
Ansteuerung: positiv (gemeinsame Kathode)
 Technical advice for system-components:
 control: positive (combined cathode)

→ Konverter siehe Seite 450-459
 → converter see pages 450-459

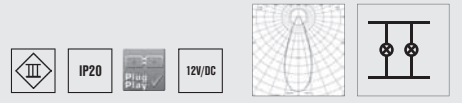
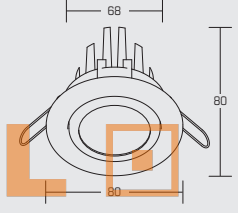

Art.-Nr. art-no.	Lichtfarbe light colour	Preis € price €
3523RGB	rot-grün-blau / red-green-blue	144,90

3522RGB



LED/RGB Leuchteneinsatz / LED/RGB luminaire insert

Material: Aluminium / Kunststoff / material: aluminium / plastic
Bestückung: 3x RGB-LED fullcolour, Leistung: ca. 13,8W
lamp: 3x RGB-LED fullcolour, power: approx. 13,8W

Planungshinweis für Systemkomponenten:
Ansteuerung: positiv (gemeinsame Kathode)
 Technical advice for system-components:
 control: positive (combined cathode)

inkl. optischer Linse 45° / incl. optical lens 45°

→ Konverter siehe Seite 450-459
 → converter see pages 450-459

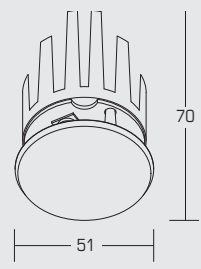

Art.-Nr. art-no.	Lichtfarbe light colour	Linse lense	Preis € price €
3522RGB	rot-grün-blau / red-green-blue	45°	123,90

LED/RGB Deckeneinbaustrahler / LED/RGB recessed ceiling light

Material: Guss / Aluminium / Glas / Kunststoff material: cast / aluminium / glass / plastic
Farbe: chrom / colour: chrome
Bestückung: 3x RGB-LED fullcolour, Leistung: ca. 13,8W
lamp: 3x RGB-LED fullcolour, power: approx. 13,8W

Montage in Hohldecken mit Federbefestigung
 Installation into suspended ceilings by spring fixation

inkl. optischer Linse 45°
 incl. optical lens 45°

inkl. 1,0m Anschlussleitung
 incl. 1,0m connexion cable

Planungshinweis für Systemkomponenten:
Ansteuerung: positiv (gemeinsame Kathode)
 Technical advice for system-components:
 control: positive (combined cathode)

→ Konverter siehe Seite 450-459
 → converter see pages 450-459

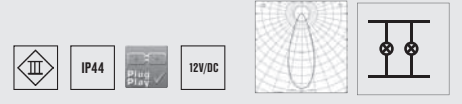
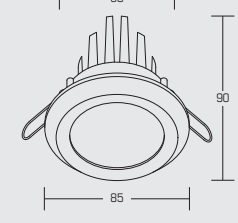
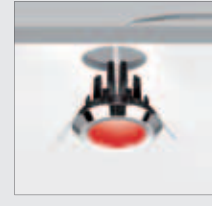

Art.-Nr. art-no.	Lichtfarbe light colour	Preis € price €
3524RGB	rot-grün-blau / red-green-blue	155,40

MODULO ELECTRO

www.modulelectro.ru

3706RGB



LED/RGB Leuchteneinsatz / LED/RGB luminaire insert

Material: Aluminiumguss / material: aluminium cast
 Bestückung: 6x RGB-LED fullcolour, Leistung: ca. 28,0W
 lamp: 6x RGB-LED fullcolour, power: approx. 28,0W

Planungshinweis für Systemkomponenten:
 Ansteuerung: positiv (gemeinsame Kathode)
 Technical advice for system-components:
 control: positive (combined cathode)

→ Konverter siehe Seite 450-459
 → converter see pages 450-459



Art.-Nr. art-no.	Lichtfarbe light colour	Linse lense	Preis € price €
3706RGB	rot-grün-blau / red-green-blue	30°	279,00

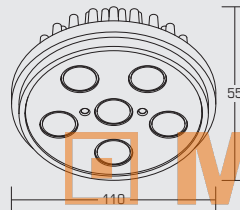

3010RGB



LED/RGB Einbauleuchte / LED/RGB recessed light

Material: Aluminiumguss / Metall / material: aluminium cast / cast
 Farbe: weiß / schwarz / colour: white / black
 Bestückung: 6x RGB-LED fullcolour, Leistung: ca. 28,0W
 lamp: 6x RGB-LED fullcolour, power: approx. 28,0W

Montage in Hohldecken mit Federbefestigung
 Installation into suspended ceilings by spring fixation



Planungshinweis für Systemkomponenten:
 Ansteuerung: positiv (gemeinsame Kathode)
 Technical advice for system-components:
 control: positive (combined cathode)

kardanische Aufhängung
 gimbal mounting

→ Konverter siehe Seite 450-459
 → converter see pages 450-459



Art.-Nr. art-no.	Lichtfarbe light colour	Linse lense	Preis € price €
3010RGB	rot-grün-blau / red-green-blue	30°	339,00

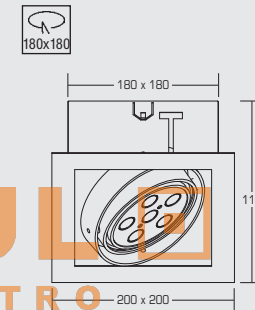

3006RGB



LED/RGB Einbauleuchte / LED/RGB recessed light

Material: Aluminiumguss / material: aluminium cast
 Farbe: weiß / colour: white
 Bestückung: 6x RGB-LED fullcolour, Leistung: ca. 28,0W
 lamp: 6x RGB-LED fullcolour, power: approx. 28,0W
 schwenkbar / rotatable

Montage in Hohldecken mit Federbefestigung
 Installation into suspended ceilings by spring fixation

Planungshinweis für Systemkomponenten:
 Ansteuerung: positiv (gemeinsame Kathode)
 Technical advice for system-components:
 control: positive (combined cathode)

→ Konverter siehe Seite 450-459
 → converter see pages 450-459

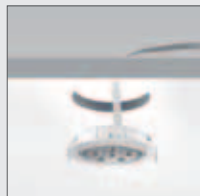

Art.-Nr. art-no.	Lichtfarbe light colour	Linse lense	Preis € price €
3006RGB	rot-grün-blau / red-green-blue	30°	319,00

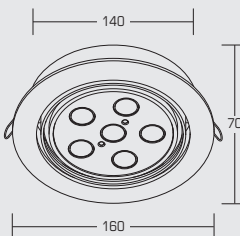

www.modulelectro.ru

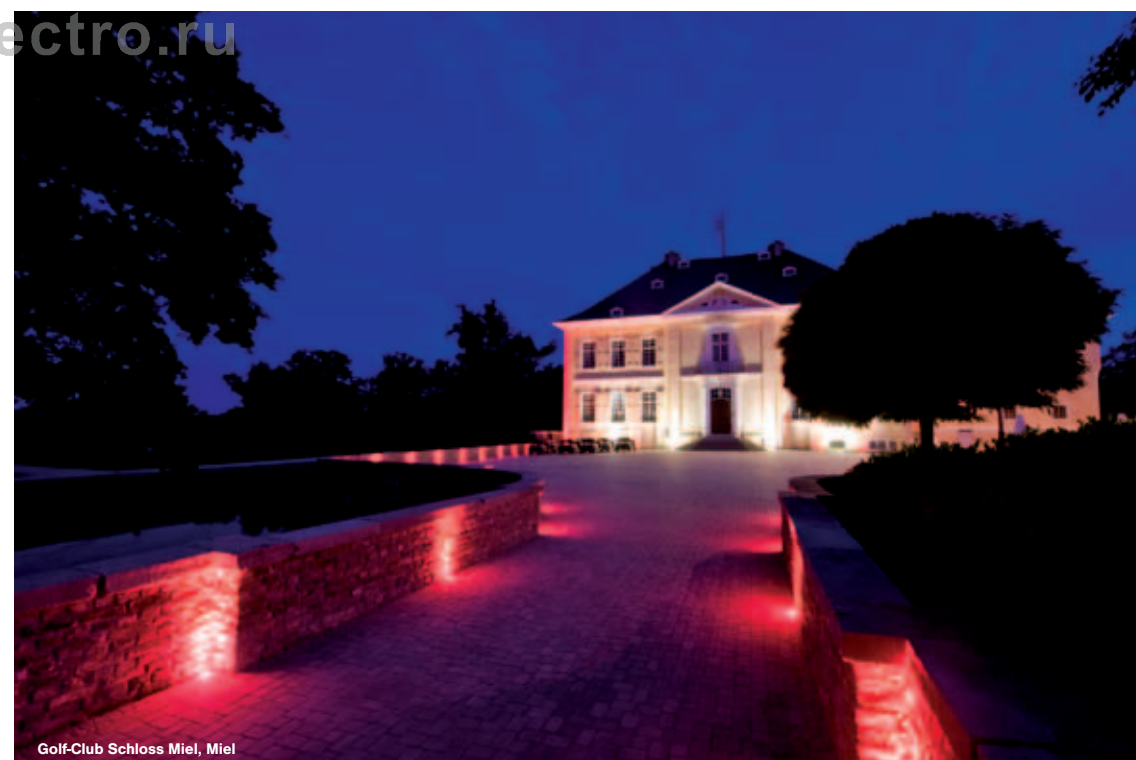

Golf-Club Schloss Miel, Miel

3012RGB

LED/RGB Einbauleuchte / LED/RGB recessed light

Material: Stahl / Acryl opalisiert / material: steel / acryl opal
 Farbe: silber / colour: silver
 Bestückung: 3x RGB-LED fullcolour, Leistung: ca. 13,8W
 lamp: 3x RGB-LED fullcolour, power: approx. 13,8W

Montage in Hohldecken mit Federbefestigung
 Installation into suspended ceilings by spring fixation

Planungshinweis für Systemkomponenten:
 Ansteuerung: positiv (gemeinsame Kathode)
 Technical advice for system-components:
 control: positive (combined cathode)

→ Konverter siehe Seite 450-459
 → converter see pages 450-459

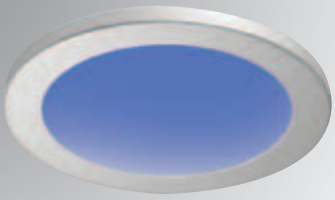

Art.-Nr. art-no.	Lichtfarbe light colour	Preis € price €
3012RGB	rot-grün-blau / red-green-blue	219,00

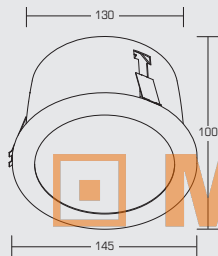

3013RGB

LED/RGB Einbauleuchte / LED/RGB recessed light

Material: Stahl / Acryl opalisiert / material: steel / acryl opal
 Farbe: silber / colour: silver
 Bestückung: 3x RGB-LED fullcolour, Leistung: ca. 13,8W
 lamp: 3x RGB-LED fullcolour, power: approx. 13,8W

Montage in Hohldecken mit Federbefestigung
 Installation into suspended ceilings by spring fixation

Planungshinweis für Systemkomponenten:
 Ansteuerung: positiv (gemeinsame Kathode)
 Technical advice for system-components:
 control: positive (combined cathode)

→ Konverter siehe Seite 450-459
 → converter see pages 450-459

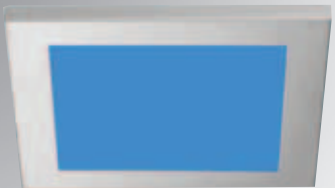

Art.-Nr. art-no.	Lichtfarbe light colour	Preis € price €
3013RGB	rot-grün-blau / red-green-blue	219,00

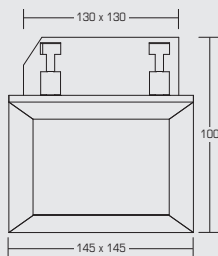
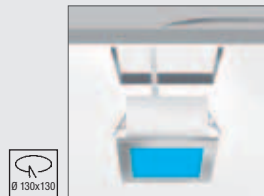

MODUL
ELECTRO
www.modulelectro.ru



Luxusliner Celebrity Equinox (Meyer Werft, Papenburg)

LED/RGB-Leuchten | LED-RGB lights

3381RGB

LED/RGB Einbaufächenleuchte / LED/RGB recessed plain light

Material: Aluminiumguss / Kunststoff / material: aluminium cast / plastic
 Farbe: silber / colour: silver
 Bestückung: 30x RGB-SMD 3-1, Leistung: ca. 8,0W
 lamp: 30x RGB-SMD 3-1, power: approx. 8,0W

Planungshinweis für Systemkomponenten:
 Ansteuerung: positiv (gemeinsame Kathode)
 Technical advice for system-components:
 control: positive (combined cathode)

→ Konverter siehe Seite 450/451/457
 → converter see pages 450/451/457

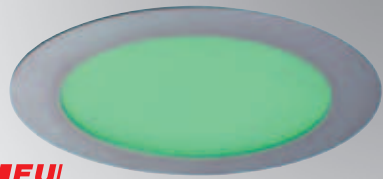

NEU
new

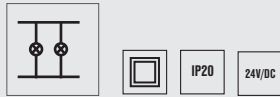

Art.-Nr. art-no.	Lichtfarbe light colour	Preis € price €
3381RGB	rot-grün-blau / red-green-blue	189,00

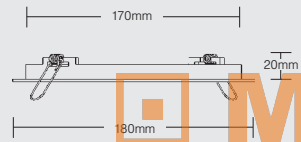

LED/RGB-Leuchten | LED-RGB lights

3383RGB

LED/RGB Einbaufächenleuchte / LED/RGB recessed plain light

Material: Aluminiumguss / Kunststoff / material: aluminium cast / plastic
 Farbe: silber / colour: silver
 Bestückung: 84x RGB-SMD 3-1, Leistung: ca. 24,0W
 lamp: 84x RGB-SMD 3-1, power: approx. 24,0W

geeignet für Rasterdecken 62,5 x 62,5cm (Art.-Nr. 3384 für Rasterdecken 60x60cm)
 suitable for grid ceiling 62,5 x 62,5cm (art-no. 3384 for grid ceilings 60x60cm)

Planungshinweis für Systemkomponenten:
 Ansteuerung: positiv (gemeinsame Kathode)
 Technical advice for system-components:
 control: positive (combined cathode)

→ Konverter siehe Seite 450/451/457
 → converter see pages 450/451/457

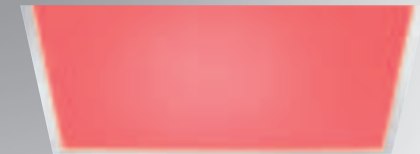

NEU
new



Art.-Nr. art-no.	Lichtfarbe light colour	Maße dimensions	Preis € price €
3383RGB	rot-grün-blau / red-green-blue	62,5 x 62,5cm	698,00
3384RGB	rot-grün-blau / red-green-blue	60 x 60cm	698,00

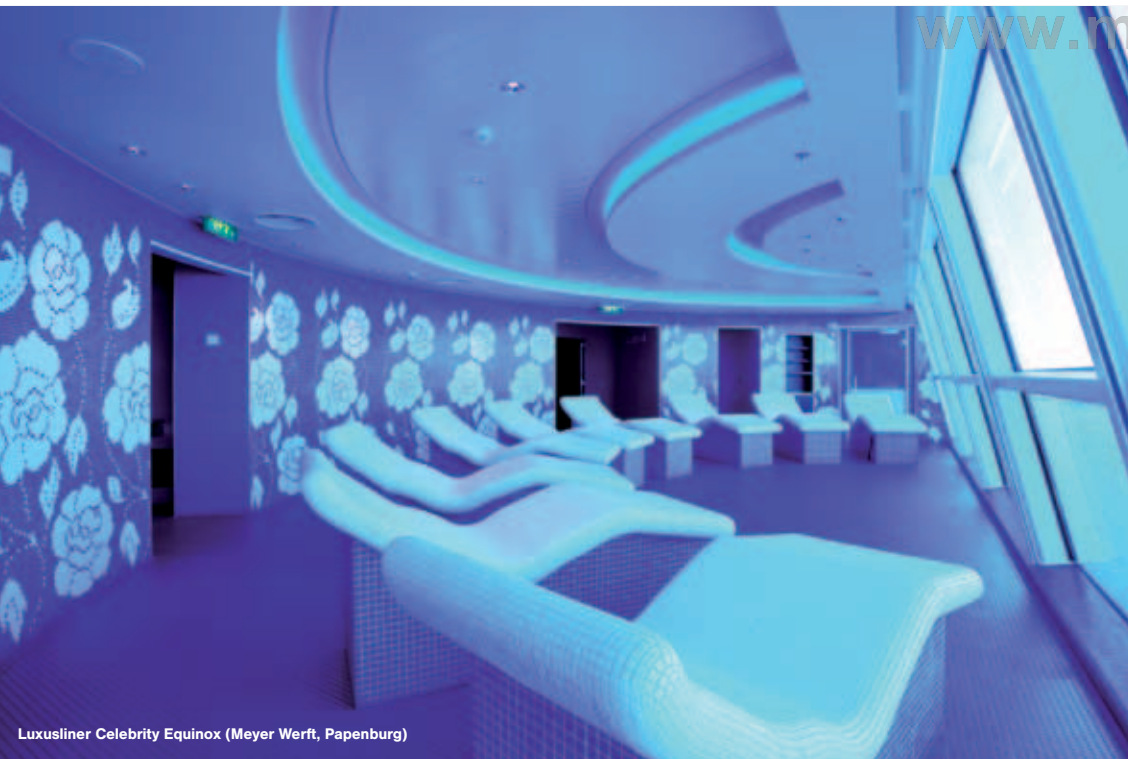

www.modulelectro.ru



3661RGB

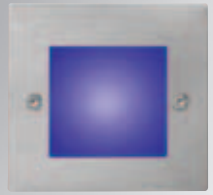

LED/RGB Wandeinbauleuchte / LED/RGB recessed wall light

Material: Eisen / Edelstahl / Acryl opal / material: iron / stainless steel / acryl opal
 Farbe: edelstahl / colour: stainless steel
 Bestückung: 1x RGB-LED Multicolour, Leistung: ca. 2,5W
 lamp: 1x RGB-LED multicolour, power: approx. 2,5W

Montage in Hohlräume mit Federbefestigung
 Installation into suspended cavities by spring fixation

Planungshinweis für Systemkomponenten:
 Ansteuerung: positiv (gemeinsame Kathode)
 Technical advice for system-components:
 control: positive (combined cathode)

Individuell gelaserte Blenden auf Anfrage möglich!
 individual lasered covers available on request!

→ Konverter siehe Seite 450-459
 → converter see pages 450-459



Art.-Nr. art-no.	Lichtfarbe light colour	Preis € price €
3661RGB	rot-grün-blau / red-green-blue	198,50

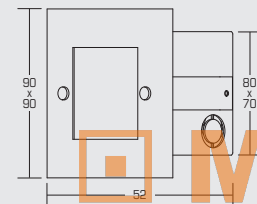

3662RGB



LED/RGB Wandeinbauleuchte / LED/RGB recessed wall light

Material: Eisen / Edelstahl / Acryl opal / material: iron / stainless steel / acryl opal
 Farbe: edelstahl / colour: stainless steel
 Bestückung: 1x RGB-LED Multicolour, Leistung: ca. 2,5W
 lamp: 1x RGB-LED multicolour, power: approx. 2,5W

Montage in Hohlräume mit Federbefestigung
 Installation into suspended cavities by spring fixation

Planungshinweis für Systemkomponenten:
 Ansteuerung: positiv (gemeinsame Kathode)
 Technical advice for system-components:
 control: positive (combined cathode)

→ Konverter siehe Seite 450-459
 → converter see pages 450-459



Art.-Nr. art-no.	Lichtfarbe light colour	Preis € price €
3662RGB	rot-grün-blau / red-green-blue	198,50

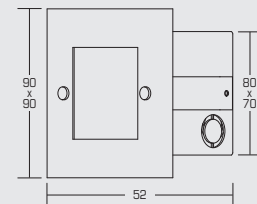

MODUL
ELECTRO
www.modulelectro.ru



3867RGB

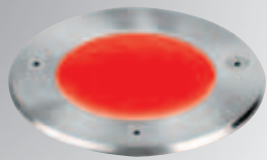

LED/RGB Bodeneinbauleuchte / LED-RGB in-ground light

Material: Edelstahl / Aluminium / Glas satiniert
 material: stainless steel / aluminium / glass frosted
 Farbe: edelstahl / colour: stainless steel
 Bestückung: 6x LED-SMD fullcolour, Leistung: ca. 1,5W
 lamp: 6x LED-SMD fullcolour, power: approx. 1,5W

Belastbar bis 1000 kg / load capacity up to 1000 kg

inkl. Montagehülse (Ø 102 x 111mm)
 incl. mounting sleeve (Ø 102 x 111mm)

inkl. 1,0m Anschlussleitung
 incl. 1,0m connexion cable

Planungshinweis für Systemkomponenten:
 Ansteuerung: positiv (gemeinsame Kathode)
 Technical advice for system-components:
 control: positive (combined cathode)

→ Konverter siehe Seite 450-459
 → converter see pages 450-459

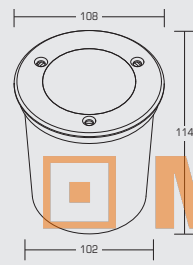

Art.-Nr. art-no.	Lichtfarbe light colour	Preis € price €
3867RGB	rot-grün-blau / red-green-blue	159,00

3804RGB

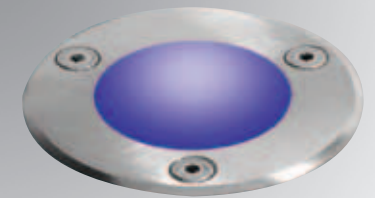

LED/RGB Bodeneinbauleuchte / LED-RGB in-ground light

Material: Edelstahl / Kunststoff / Acryl opalisiert
 material: stainless steel / plastic / acryl opal
 Farbe: edelstahl / colour: stainless steel
 Bestückung: 30x UHB-COB-LED, Leistung: ca. 2,5W
 lamp: 30x UHB-COB-LED, power: approx. 2,5W

Belastbar bis 1000 kg / load capacity up to 1000 kg

inkl. Montagehülse (Ø 72 x 116mm)
 incl. mounting sleeve (Ø 72 x 116mm)

inkl. 1,0m Anschlussleitung
 incl. 1,0m connexion cable

Planungshinweis für Systemkomponenten:
 Ansteuerung: positiv (gemeinsame Kathode)
 Technical advice for system-components:
 control: positive (combined cathode)

→ Konverter siehe Seite 450-459
 → converter see pages 450-459

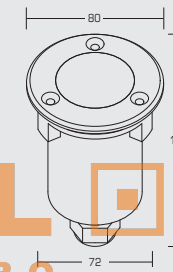
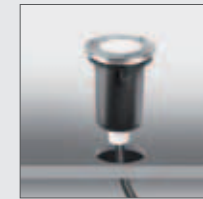

Art.-Nr. art-no.	Lichtfarbe light colour	Preis € price €
3804RGB	rot-grün-blau / red-green-blue	241,40

3868RGB



LED/RGB Bodeneinbauleuchte / LED-RGB in-ground light

Material: Edelstahl / Aluminium / Glas satiniert
 material: stainless steel / aluminium / glass frosted
 Farbe: edelstahl / colour: stainless steel
 Bestückung: 6x LED-SMD fullcolour, Leistung: ca. 1,5W
 lamp: 6x LED-SMD fullcolour, power: approx. 1,5W

Belastbar bis 1000 kg / load capacity up to 1000 kg

inkl. Montagehülse (113 x 113 x 96mm)
 incl. mounting sleeve (113 x 113 x 96mm)

inkl. 1,0m Anschlussleitung
 incl. 1,0m connexion cable

Planungshinweis für Systemkomponenten:
 Ansteuerung: positiv (gemeinsame Kathode)
 Technical advice for system-components:
 control: positive (combined cathode)

→ Konverter siehe Seite 450-459
 → converter see pages 450-459

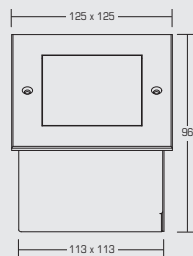

Art.-Nr. art-no.	Lichtfarbe light colour	Preis € price €
3868RGB	rot-grün-blau / red-green-blue	169,00

3802RGB

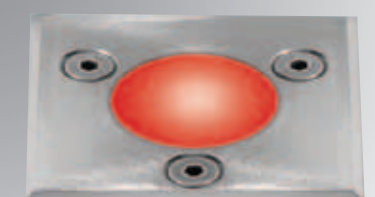

LED/RGB Bodeneinbauleuchte / LED-RGB in-ground light

Material: Edelstahl / Kunststoff / Acryl opalisiert
 material: stainless steel / plastic / acryl opal
 Farbe: edelstahl / colour: stainless steel
 Bestückung: 30x UHB-COB-LED, Leistung: ca. 2,5W
 lamp: 30x UHB-COB-LED, power: approx. 2,5W

Belastbar bis 1000 kg / load capacity up to 1000 kg

inkl. Montagehülse (Ø 72 x 116mm)
 incl. mounting sleeve (Ø 72 x 116mm)

inkl. 1,0m Anschlussleitung
 incl. 1,0m connexion cable

Planungshinweis für Systemkomponenten:
 Ansteuerung: positiv (gemeinsame Kathode)
 Technical advice for system-components:
 control: positive (combined cathode)

→ Konverter siehe Seite 450-459
 → converter see pages 450-459

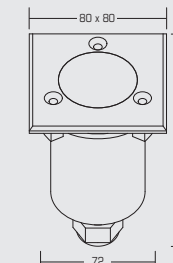

Art.-Nr. art-no.	Lichtfarbe light colour	Preis € price €
3802RGB	rot-grün-blau / red-green-blue	241,40

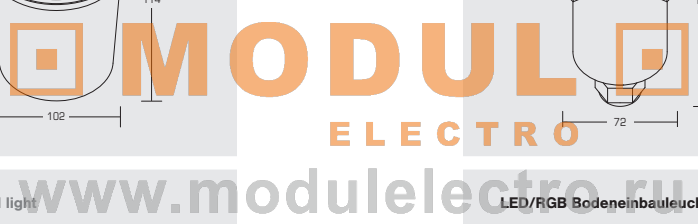

3800RGB

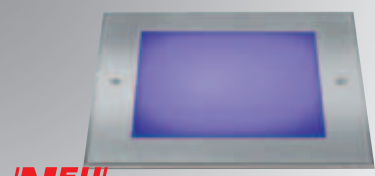

NEU
new

LED/RGB Bodeneinbauleuchte / LED/RGB in-ground light

Material: Edelstahl / Aluminium / Glas / material: stainless steel / aluminium / glass
Farbe: edelstahl / colour: stainless steel
Bestückung: 3x RGB-LED fullcolour, Leistung: ca. 13,8W
 lamp: 3x RGB-LED fullcolour, power: approx. 13,8W

inkl. Montagehülse (153 x 153 x 118mm)
 incl. mounting sleeve (153 x 153 x 118mm)

inkl. 1,0m Anschlussleitung
 incl. 1,0m connexion cable

Planungshinweis für Systemkomponenten:
 Ansteuerung: positiv (gemeinsame Kathode)
 Technical advice for system-components:
 control: positive (combined cathode)

→ Konverter siehe Seite 450-459
 → converter see pages 450-459

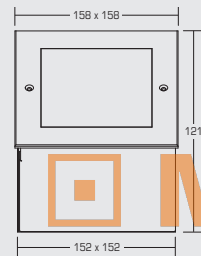

Art.-Nr. art.-no.	Lichtfarbe light colour	Preis € price €
3800RGB	rot-grün-blau / red-green-blue	256,50

3863RGB

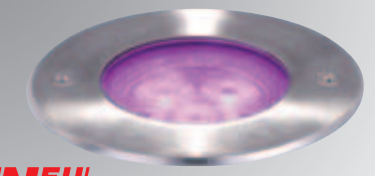

NEU
new

LED/RGB Bodeneinbauleuchte / LED/RGB in-ground light

Material: Edelstahl / Aluminium / Glas
 material: stainless steel / aluminium / glass
Farbe: edelstahl / colour: stainless steel
Bestückung: 3x RGB-LED fullcolour, Leistung: ca. 13,8W
 lamp: 3x RGB-LED fullcolour, power: approx. 13,8W

Belastbar bis 1000 kg / load capacity up to 1000 kg



inkl. Montagehülse (Ø 102 x 111mm)
 incl. mounting sleeve (Ø 102 x 111mm)

inkl. 1,0m Anschlussleitung
 incl. 1,0m connexion cable

Planungshinweis für Systemkomponenten:
 Ansteuerung: positiv (gemeinsame Kathode)
 Technical advice for system-components:
 control: positive (combined cathode)

→ Konverter siehe Seite 450-459
 → converter see pages 450-459

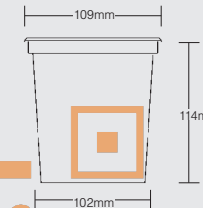

Art.-Nr. art.-no.	Lichtfarbe light colour	Linse lense	Preis € price €
3863RGB	rot-grün-blau / red-green-blue	45°	219,00

P3859RGB



LED/RGB Bodeneinbauleuchte / LED/RGB in-ground light

Material: Edelstahl / Kunststoff / Glas klar
 material: stainless steel / plastic / glass clear
Farbe: edelstahl / colour: stainless steel
Bestückung: 9x Hochleistungs-LED, Leistung: ca. 9,0W
 lamp: 9x high performance LED, power: approx. 9,0W

inkl. separater Montagehülse (Ø 156 x 112mm)
 incl. separate mounting sleeve (Ø 156 x 112mm)

inkl. optischer Linse 10° / incl. optical lenses 10°

inkl. 5m Anschlussleitung / incl. 5m connexion cable

Planungshinweis für Systemkomponenten:
 Ansteuerung: positiv (gemeinsame Kathode)
 Technical advice for system-components:
 control: positive (combined cathode)

→ Konverter siehe Seite 450-459
 → converter see pages 450-459

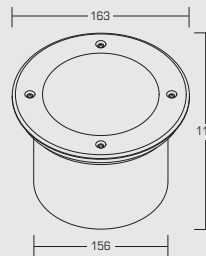

Art.-Nr. art.-no.	Lichtfarbe light colour	Linse lense	Preis € price €
P3859RGB	rot-grün-blau / red-green-blue	10°	468,00

3865RGB



NEU
new

LED/RGB Bodeneinbauleuchte / LED/RGB in-ground light

Material: Aluminium / Kunststoff / Glas
 material: aluminium / plastic / glass
Farbe: edelstahl / colour: stainless steel
Bestückung: 6x RGB-LED fullcolour Platine, Leistung: ca. 28,0W
 lamp: 6x RGB-LED fullcolour platine, power: approx. 28,0W

Belastbar bis 1000 kg / load capacity up to 1000 kg



inkl. Montagehülse (Ø 156 x 112mm)
 incl. mounting sleeve (Ø 156 x 112mm)

inkl. 1,0m Anschlussleitung
 incl. 1,0m connexion cable

Planungshinweis für Systemkomponenten:
 Ansteuerung: positiv (gemeinsame Kathode)
 Technical advice for system-components:
 control: positive (combined cathode)

→ Konverter siehe Seite 450-459
 → converter see pages 450-459

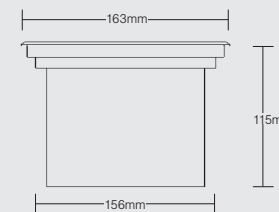

Art.-Nr. art.-no.	Lichtfarbe light colour	Linse lense	Preis € price €
3865RGB	rot-grün-blau / red-green-blue	30°	398,00

MODUL
ELECTRO
www.modulelectro.ru

P3860RGB



LED/RGB Wand- / Deckenanbauleuchte / LED/RGB-wall / ceiling light

Material: Guss / Edelstahl / Glas
 material: cast / stainless steel / glass
 Farbe: edelstahl / colour: stainless steel
 Bestückung: 9x Hochleistungs-LED, Leistung: ca. 9,0W
 lamp: 9x high performance LED, power: approx. 9,0W

inkl. optischer Linsen 10° / incl. optical lenses 10°

inkl. 5m Anschlussleitung / incl. 5m connexion cable

Planungshinweis für Systemkomponenten:
 Ansteuerung: positiv (gemeinsame Kathode)
 Technical advice for system-components:
 control: positive (combined cathode)

→ Konverter siehe Seite 450-459
 → converter see pages 450-459

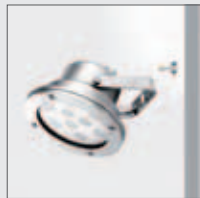

Art.-Nr. art-no.	Lichtfarbe light colour	Linse lense	Preis € price €
P3860RGB	rot-grün-blau / red-green-blue	10°	498,00

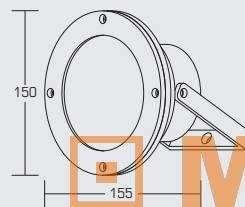

3875RGB

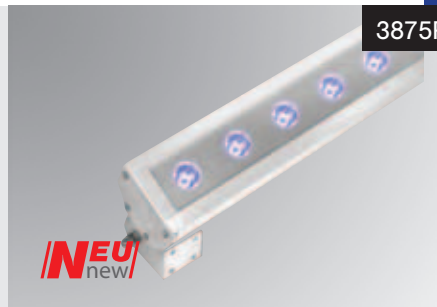

LED/RGB Aufbauprofil / LED/RGB built-on profile

Material: Aluminium / Acrylglas
 material: aluminium / acrylic glass
 Bestückung: 6x Hochleistungs – LED 3-1 (Fullcolour), Leistung: ca. 28W
 lamp: 6x high performance – LED 3-1 (Fullcolour), power: approx. 28W

inkl. optischer Linsen / incl. optical lenses: 30°

inkl. 5,0m Anschlussleitung
 incl. 5,0m connexion cable

Planungshinweis für Systemkomponenten:
 Ansteuerung: negativ (gemeinsame Anode)
 Technical advice for system-components:
 control: negative (combined anode)

→ Konverter siehe Seite 450, 451, 457
 → converter see pages 450, 451, 457

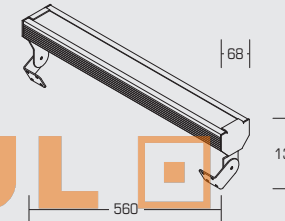

Art.-Nr. art-no.	Lichtfarbe light colour	Linse lense	Preis € price €
3875RGB	rot-grün-blau / red-green-blue	30°	598,00

MODUL
ELECTRO

www.modulelectro.ru

3876RGB

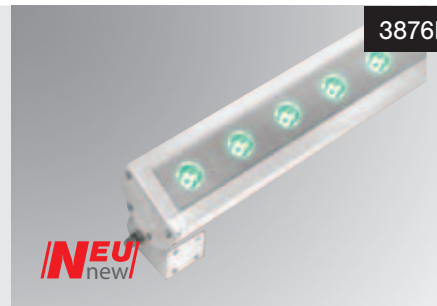

LED/RGB Aufbauprofil / LED/RGB built-on profile

Material: Aluminium / Acrylglas
 material: aluminium / acrylic glass
 Bestückung: 12x Hochleistungs – LED 3-1 (Fullcolour), Leistung: ca. 56W
 lamp: 12x high performance – LED 3-1 (Fullcolour), power: approx. 56W

inkl. optischer Linsen / incl. optical lenses: 30°

inkl. 5,0m Anschlussleitung
 incl. 5,0m connexion cable

Planungshinweis für Systemkomponenten:
 Ansteuerung: negativ (gemeinsame Anode)
 Technical advice for system-components:
 control: negative (combined anode)

→ Konverter siehe Seite 450, 451, 457
 → converter see pages 450, 451, 457

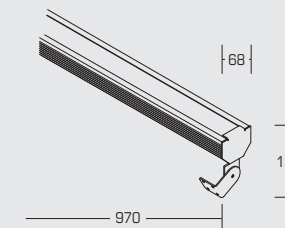

Art.-Nr. art-no.	Lichtfarbe light colour	Linse lense	Preis € price €
3876RGB	rot-grün-blau / red-green-blue	30°	898,00

3847RGB

LED/RGB Profil / LED-RGB profile

Material: Aluminium / Kunststoff
 material: aluminium / plastic
 Bestückung: 60x SMD LED/RGB, Leistung: ca. 14,4W
 lamp: 60x SMD LED/RGB, power: approx. 14,4W

inkl. 1,0m Anschlussleitung
 incl. 1,0m connexion cable

Planungshinweis für Systemkomponenten:
 Ansteuerung: positiv (gemeinsame Kathode)
 Technical advice for system-components:
 control: positive (combined cathode)

Weitere Profillängen auf Anfrage / other profile length on demand
 Länge min. 50 - max. 2000mm / length min. 50 - max. 2000mm

→ Konverter siehe Seite 450-459
 → converter see pages 450-459



Art.-Nr. art-no.	Lichtfarbe light colour	Preis € price €
3847RGB	rot-grün-blau / red-green-blue	298,00

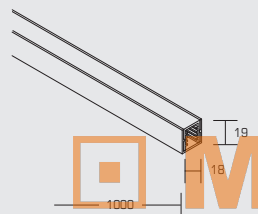

3849RGB

LED/RGB Flügelprofil / LED-RGB wing profile

Material: Aluminium / Kunststoff
 material: aluminium / plastic
 Bestückung: 60x SMD LED/RGB, Leistung: ca. 14,4W
 lamp: 60x SMD LED/RGB, power: approx. 14,4W

inkl. 1,0m Anschlussleitung
 incl. 1,0m connexion cable

Planungshinweis für Systemkomponenten:
 Ansteuerung: positiv (gemeinsame Kathode)
 Technical advice for system-components:
 control: positive (combined cathode)

Weitere Profillängen auf Anfrage / other profile length on demand
 Länge min. 50 - max. 2000mm / length min. 50 - max. 2000mm

→ Konverter siehe Seite 450-459
 → converter see pages 450-459

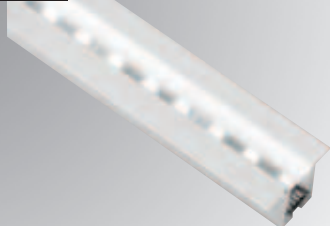

Art.-Nr. art-no.	Lichtfarbe light colour	Preis € price €
3849RGB	rot-grün-blau / red-green-blue	298,00

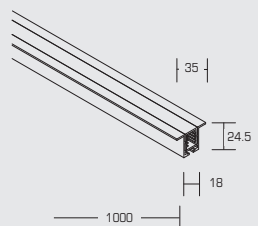

MODUL ELECTRO
 www.modulelectro.ru



Restaurant: Leuchtturm am Biggedamm, Attendorf

3841RGB

LED-Profil / LED-profile

Material: Aluminium / Acryl / material: aluminium / acryl
chemische Nickel-Goldoberfläche / chemical nickel-gold surface
Bestückung: 50x UHB-RGB 3-1 RGB-SMD (Fullcolour), Leistung: ca. 12,5W
lamp: 50x UHB-RGB 3-1 RGB-SMD (Fullcolour), power: approx. 12,5W

inkl. Montageprofil / installation profile incl.

Weitere Profillängen auf Anfrage / other profile length on demand
Länge min. 200 - max. 2000mm / length min. 200 - max. 2000mm

Abstrahlwinkel / angle of reflected beam: 90°
Umgebungstemperatur / operating temperature: 0° bis +45°C
Maße LED-Profil / dimensions LED-profile: 1000 x 13,5 x 11 mm
Maße Unterprofil / dimensions sub-profile: 1000 x 16,5 x 15,5 mm

Planungshinweis für Systemkomponenten:
Ansteuerung: positiv (gemeinsame Kathode)
Technical advice for system-components:
control: positive (combined cathode)

→ Konverter siehe Seite 450-459
→ converter see pages 450-459



Art.-Nr. art-no.	Lichtfarbe light colour	Abstrahlwinkel angle of reflected beam	Preis € price €
3841RGB	rot-grün-blau / red-green-blue	90°	538,00

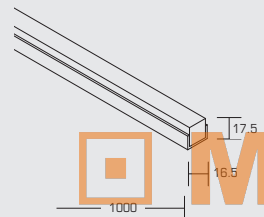

3842RGB

LED-Profil / LED-profile

Material: Aluminium / Acryl / material: aluminium / acryl
chemische Nickel-Goldoberfläche / chemical nickel-gold surface
Bestückung: 50x UHB-RGB 3-1 RGB-SMD (Fullcolour), Leistung: ca. 12,5W
lamp: 50x UHB-RGB 3-1 RGB-SMD (Fullcolour), power: approx. 12,5W

Weitere Profillängen auf Anfrage / other profile length on demand
Länge min. 210 - max. 2010mm / length min. 210 - max. 2010mm

Abstrahlwinkel / angle of reflected beam: 90°
Umgebungstemperatur / operating temperature: 0° bis +45°C

inkl. Montageclips zum Aufschrauben / installation clips to be screwed incl.

LED-Lichtrichtung ist nach der Montage beliebig ausrichtbar
The LED light direction is variable at will after installation.

Planungshinweis für Systemkomponenten:
Ansteuerung: positiv (gemeinsame Kathode)
Technical advice for system-components:
control: positive (combined cathode)

→ Konverter siehe Seite 450-459
→ converter see pages 450-459



Art.-Nr. art-no.	Lichtfarbe light colour	Abstrahlwinkel angle of reflected beam	Preis € price €
3842RGB	rot-grün-blau / red-green-blue	90°	549,00

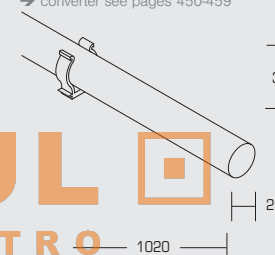

3841RGBI

LED-Profil / LED-profile

Material: Aluminium / Acryl / material: aluminium / acryl
chemische Nickel-Goldoberfläche / chemical nickel-gold surface
Bestückung: 50x UHB-RGB 3-1 RGB-SMD (Fullcolour), Leistung: ca. 12,5W
lamp: 50x UHB-RGB 3-1 RGB-SMD (Fullcolour), power: approx. 12,5W

inkl. Montageprofil / installation profile incl.

Weitere Profillängen auf Anfrage / other profile length on demand
Länge min. 210 - max. 1010mm / length min. 210 - max. 1010mm

Abstrahlwinkel / angle of reflected beam: 90°
Umgebungstemperatur / operating temperature: 0° bis +45°C
Maße LED-Profil / dimensions LED-profile: 1010 x 13,5 x 11 mm
Maße Unterprofil / dimensions sub-profile: 1000 x 16,5 x 15,5 mm

Planungshinweis für Systemkomponenten:
Ansteuerung: positiv (gemeinsame Kathode)
Technical advice for system-components:
control: positive (combined cathode)

→ Konverter siehe Seite 450-459
→ converter see pages 450-459



Art.-Nr. art-no.	Lichtfarbe light colour	Abstrahlwinkel angle of reflected beam	Preis € price €
3841RGBI	rot-grün-blau / red-green-blue	90°	598,00

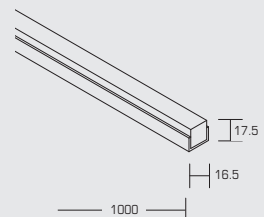

3842RGBIP

LED-Profil / LED-profile

Material: Aluminium / Acryl / material: aluminium / acryl
chemische Nickel-Goldoberfläche / chemical nickel-gold surface
Bestückung: 50x UHB-SMD-LED, Leistung: ca. 6,25W
lamp: 50x UHB-SMD-LED LED, power: approx. 6,25W

Weitere Profillängen auf Anfrage / other profile length on demand
Länge min. 220 - max. 1020mm / length min. 220 - max. 1020mm

Abstrahlwinkel / angle of reflected beam: 90°
Umgebungstemperatur / operating temperature: 0° bis +45°C

inkl. Montageclips zum Aufschrauben / installation clips to be screwed incl.

LED-Lichtrichtung ist nach der Montage beliebig ausrichtbar
The LED light direction is variable at will after installation.

Planungshinweis für Systemkomponenten:
Ansteuerung: positiv (gemeinsame Kathode)
Technical advice for system-components:
control: positive (combined cathode)

→ Konverter siehe Seite 450-459
→ converter see pages 450-459



Art.-Nr. art-no.	Lichtfarbe light colour	Abstrahlwinkel angle of reflected beam	Preis € price €
3842RGBI	rot-grün-blau / red-green-blue	90°	698,00

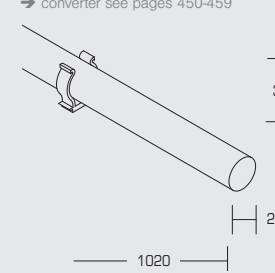

www.modulelectro.ru

MODUL ELECTRO

3855RGB

LED/RGB-Flexplatine / LED-RGB flexible conductor board

Bestückung: 150x RGB-SMD (30 pro Meter / 7,2W), Leistung: ca. 36,0W
 lamp: 150x RGB-SMD (30 per metre / 7,2W), power: approx. 36,0W

Abstrahlwinkel / angle of reflected beam: 120°

Ansteuerung: positiv (gemeinsame Kathode)
 control: positive (combined cathode)

teilbar alle 100 mm / scissile every 100 mm

Planungshinweis für Systemkomponenten:
 Ansteuerung: positiv (gemeinsame Kathode)
 Technical advice for system-components:
 control: positive (combined cathode)

→ Konverter siehe Seite 450-459
 → converter see pages 450-459



Art.-Nr. art-no.	Lichtfarbe light colour	Abstrahlwinkel angle of reflected beam	Preis € price €
3855RGB	rot-grün-blau / red-green-blue	120°	339,00

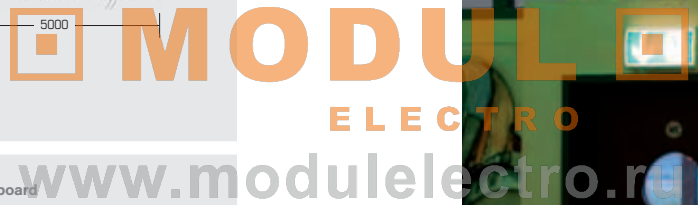
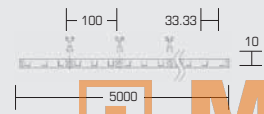

3856RGB

LED/RGB-Flexplatine / LED-RGB flexible conductor board

Bestückung: 150x RGB-SMD (30 pro Meter / 7,2W), Leistung: ca. 36,0W
 lamp: 150x RGB-SMD (30 per metre / 7,2W), power: approx. 36,0W

Abstrahlwinkel / angle of reflected beam: 120°

Ansteuerung: positiv (gemeinsame Kathode)
 control: positive (combined cathode)

teilbar alle 100 mm / scissile every 100 mm

Bei Trennung der Leiterplatte ist der Installateur für die Einhaltung der Schutzart IP65 verantwortlich!
 The installer becomes liable for maintaining the degree of protection IP65 when cutting the conductor board!

Planungshinweis für Systemkomponenten:
 Ansteuerung: positiv (gemeinsame Kathode)
 Technical advice for system-components:
 control: positive (combined cathode)

→ Konverter siehe Seite 450-459
 → converter see pages 450-459



Art.-Nr. art-no.	Lichtfarbe light colour	Abstrahlwinkel angle of reflected beam	Preis € price €
3856RGB	rot-grün-blau / red-green-blue	120°	369,00

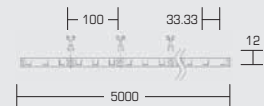

Restaurant: Leuchtturm am Biggedamm, Attendorf

Strahler für alle Fälle, und mehr...
Vom funkelnden Sternenhimmel, über entspannende Wellnessbeleuchtung
bis hin zur stilvollen Wohnraumbeleuchtung -
hier ist garantiert für jeden Geschmack etwas dabei!

Spots for all events, and more...
From twinkling starry sky, beyond calming spa atmosphere
to stylish living quarter lighting -
a guarantee for all-purpose taste is given!.



MODUL
ELECTRO
www.modulelectro.ru



Farbcode / colour code

	00 = messing / brass		15 = nickel matt / nickel satin
	01 = messing matt / brass satin		17 = strukturweiß / white structure
	02 = chrom / chrome		19 = kupfer / copper
	03 = chrom matt / chrome satin		20 = edelstahl klar gepulvert / stainless steel clear powdered
	04 = bronze / bronze		22 = edelstahl / stainless steel
	05 = gold / gold		25 = alu matt / alu satin
	06 = gold matt / gold satin		26 = stahl matt / steel satin
	07 = weiß / white		27 = edelstahl weiß gepulvert / stainless steel white powdered
	08 = schwarz / black		35 = velourchrom / velour chrome
	09 = schwarzchrom / black chrome		42 = edelstahl V4A / stainless steel V4A

Andere Farben auf Anfrage möglich. Aus drucktechnischen Gründen kann es zu Farbabweichungen kommen.
 Farbabstimmungen sollten deshalb nur anhand von Originalmustern vorgenommen werden.
 Other colours are available on request. Colour variation can occur due to typographic reasons.
 Therefore colour matching should only be done by original samples.

Lichtpunkte / Sternenhimmel light spots / starry sky	Seite page	220 - 225
Material - Eisen material - iron	Seite page	226 - 233
Material - Guss / Aluminium material - cast / aluminium	Seite page	234 - 247
Material - Rein Edelstahl material - pure stainless steel	Seite page	248 - 253
Material - Rein Messing material - pure brass	Seite page	254 - 259
Hochvolt high voltage	Seite page	260 - 267
Spots mit erhöhter Schutzart spots with high degree of protection	Seite page	268 - 277
Spots mit geringer Einbautiefe / Möbeleinbausspots spots with low installation depth / recessed spots for furnitures	Seite page	278 - 285
Deko und Objekt decorative and object	Seite page	286 - 299
Deckenaufbauleuchten surface mounted lights	Seite page	300 - 305
Wand- und Orientierungsleuchten wall- and orientation lights	Seite page	306 - 309
Lautsprecher loudspeaker	Seite page	310 - 317

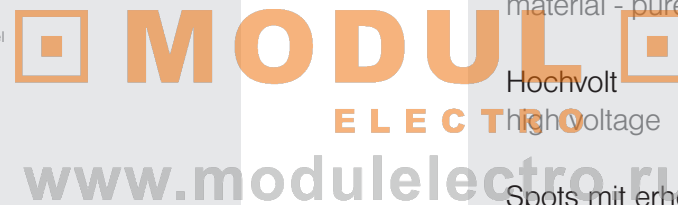

Produktfoto
photograph

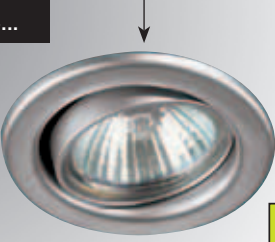

2034...

technische Skizze
technical drawing

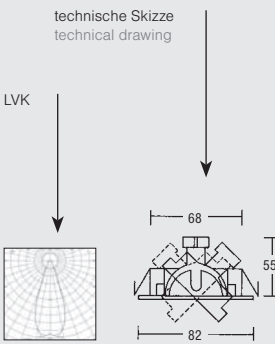

LVK

Niedervolt-Strahler / low voltage spot

Artikel-Nr. article-no.	Preis € price €
2034.02	14,60
2034.03	17,80
2034.04	21,50
2034.05	15,20
2034.06	17,90
2034.07	10,30
2034.08	12,20

Material material	Bestückung lamp	Leistung power	Schutzart degree of protection	Schutzklasse protection class
Eisen-Messing iron-brass	1x GX5,3 QRBC51	max. 50W	IP20	III

Piktogramme für die technischen Informationen. (Nähere Erläuterung auf der nächste Seite)
pictography for technical information (you will find more details on the next page)





↑ Artikel-Nr. + Farbschlüssel + Preis (brutto ohne MwSt.)
↑ Tabellarische Materialbeschreibung, etc. (scheduler description of material, etc.)

↑ Aufzählung der lagermäßig geführten Farben zu diesem Artikel
↑ article-no. + colour code + price (without tax)
↑ list of available colours

Piktogrammbeschreibung / pictograph description

-  Deckenausschnitt in mm für den Artikel
ceiling cut-out in mm for the article
-  Schwenkwinkel in °
pivoting angle in °
-  Drehwinkel in °
Rotation in °
-  ENEC - Zertifizierung
ENEC - Certification
-  Angabe des verwendbaren Einputztopfes (EPT) für den Artikel
Code of suitable box for lamp
-  Angabe des verwendbaren Übertopfes (ÜT) für den Artikel
Code of cache-pot for article
-  Angabe des verwendbaren Bügels für den Artikel
Code of shackle for this article
-  Leuchtmittelhalterung OHNE Sprengring
Fitting of illuminant without circlip
-  Eignung des Artikels zur Direktmontage auf oder an normal entflammaren Materialien.
This article is suitable for a direct installation on or at standard inflammable materials.
-  Leuchte darf nach Montage mit Wärmedämm-Matten bedeckt werden.
Lights could be covered with heat-insulating tiles.
-  Leuchten zum Einbau in Möbel aus Materialien mit unbekanntem Brandverhalten.
Lights to be installed into furnitures consisting of material with unknown fire behaviour.
-  Artikel ist spritzwassergeschützt
Article is splash-proofed
-  Beschreibt die für die Leuchte typische Lichtverteilung
Description of the typical light distribution for the luminaire

MODUL ELECTRO
www.modulelectro.ru

-  Die für Deckenausschnitt Ø 68 geeigneten Strahler sind gesondert gekennzeichnet.
All items with the cut-out of Ø 68 are specially marked.
-  **ACHTUNG:**
Die NV-Leuchten werden generell OHNE Bügel geliefert, bei Bedarf bitte zusätzlich bestellen.
ATTENTION:
The low pressure lamps will generally be delivered without shackle, please order separately.
-  Dieser Artikel kann alternativ mit unserem Rebel-Einsatz R3705... (siehe Seite 42 im LED-Bereich) bestückt werden.
This article can alternatively be equipped with our rebel insert R3705... (see page 42 in the LED section).

ZULASSUNG ZUR MONTAGE AUF NORMAL BRENNBAREN MATERIALIEN

Leuchten mit Eignung zur Direktmontage auf oder an normal entflammaren Materialien tragen das F-Zeichen. Normal brennbar nach DIN 4102 bedeutet, dass die Brennbarkeit des Materials bei 200°C beginnt. Ferner können Leuchten mit dem M- oder MM-Zeichen ausgestattet sein, das die Zulassung der Leuchte in Möbeln anzeigt.



Leuchten zugelassen zum Einbau in Möbel aus schwer entflammaren oder normal brennbaren Materialien.



Leuchten zugelassen zum Einbau in Möbel aus Materialien mit unbekanntem Brandverhalten.



Die im Katalog angegebenen Leuchten mit ENEC 05 - Zeichen erfüllen die ENEC- Bedingungen nur in Verbindung mit den Bügeln 5364/5366.









IP-KLASSIFIZIERUNG; SCHUTZART

Die Schutzart einer Leuchte kennzeichnet den Schutz gegen Eindringen von Fremdkörpern und Feuchtigkeit. Dabei gibt die erste Ziffer den Fremdkörperschutz und die zweite Ziffer den Schutz gegen eindringendes Wasser an; z.B. IP 44 bedeutet geschützt gegen Fremdkörper > 1 mm und gegen Spritzwasser.

Ziffer 1 Erklärung (Fremdkörperschutz)

- 0 ungeschützt
- 1 Fremdkörper > 50 mm.
- 2 Fremdkörper > 12 mm.
- 3 Fremdkörper > 2,5 mm.
- 4 Fremdkörper > 1 mm.
-  5 staubgeschützt
-  6 staubdicht

Ziffer 2 Erklärung (Feuchtigkeitsschutz)

-  0 ungeschützt
-  1 Tropfwasser < 0°
-  2 Tropfwasser < 15°
-  3 Sprühwasser
-  4 Spritzwasser
-  5 Strahlwasser
-  6 Überflutung
-  7 Eintauchen (ohne Druckangabe)
-  8 Untertauchen (mit Druckangabe)

ADMISSION FOR INSTALLATION ON STANDARD FLAMMABLE MATERIALS

Lights which are suitable for a direct installation on or at standard flammable materials bear the F-mark. Standard flammable according to DIN 4102 means that the flammability of the material begins at 200°C. Furthermore, the lights can be provided with the M- or MM-mark which shows the admission of the light.



Lights to be installed into furniture of heavily inflammable or standard flammable materials.



Lights to be installed into furniture consisting of material with unknown fire behaviour.



The lights with ENEC 05-label indicated in the catalogue, satisfy the ENEC-requirement combined with shackles 5364/5366.









IP-CLASSIFICATION, PROTECTION CLASS

The protection class characterises the protection against the infiltration of foreign bodies and dampness. The first cypher specifies the protection against foreign bodies, the second cypher the protection against the ingress of moisture, e.g., IP 44 means: protected against foreign bodies > 1 mm and against splash water.

No. 1 Description (protection against foreign bodies)

- 0 Unprotected
- 1 Foreign body > 50 mm.
- 2 Foreign body > 12 mm.
- 3 Foreign body > 2,5 mm.
- 4 Foreign body > 1 mm.
-  5 Protected against dust
-  6 Dust-proof

No. 2 Description (protection against dampness)

-  0 Unprotected
-  1 Dripping water < 0°
-  2 Dripping water < 15°
-  3 Spraying water
-  4 Splash water
-  5 Water-jet
-  6 Flooding
-  7 Dipping (pressure not specified)
-  8 Impersion (pressure not specified)

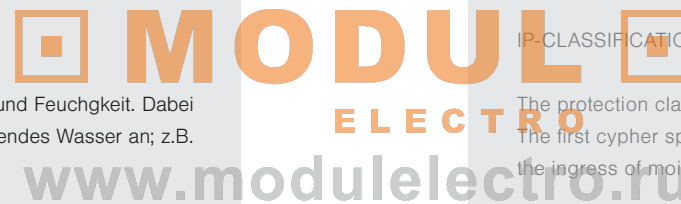

INSTALLATION DER LEUCHTE

Da es zurzeit noch keine DIN – VDE – Bestimmungen für den Einsatz von Niedervolt – Halogenlampen gibt, muss ein Errichter die Anlage auf eigene Verantwortung installieren. Zu beachten ist, dass bei NV – Leuchten etwa 85 % der zugeführten elektrischen Energie in Wärme umgesetzt wird.

Dabei können am Lampenkolben Temperaturen von mehr als 500 °C und am Reflektor mehr als 200 °C auftreten.

EINSATZ DER LEUCHTMITTEL

Die Leuchtmittel dürfen beim Einsatz nicht beschädigt werden. Auf sachgerechten Einsatz in die Fassung ist zu achten. Die Lampe immer bündig in die Fassung einsetzen. Es müssen Leuchtmittel mit den ordnungsgemäßen elektrischen Daten (Sockel, Spannung und Wattage) eingesetzt werden. Defekte Leuchtmittel sofort, aber nur im abgeschalteten Zustand ersetzen (neue Fassung verwenden).

ERHÖHUNG DER LAMPENLEBENSDAUER

Eine Lichtstromminderung von 10 – 15 % erhöht die Lebensdauer der Lampe wesentlich. Die max. zulässigen Spannungswerte, z.B. 12V / 24V, dürfen auf keinen Fall am Leuchtmittel überschritten werden. Es ist auf gleichmäßigen Spannungsabfall der Leitungen zum Leuchtmittel zu achten.

Die im Katalog angegebenen Leuchteinbaumaße geben das Leuchtenmaß inkl. Leuchtmittel an. Die Errichtervorschriften hinsichtlich der Einbautiefen müssen beachtet werden.

INSTALLATION OF LAMPS

As there are currently no DIN-VDE-regulations available for the use of low-voltage halogen lamps, the electrician has to install the equipment at his own risk. It has to be noted that in the case of low-voltage lamps about 85% of the electric energy supplied is converted into thermal energy.

As a result temperatures higher than 500 °C at the bulb and higher than 200 °C at the reflector may occur.

INSERTION OF LIGHTING FIXTURES

Lighting fixtures must not be damaged when inserted. The proper insertion into the socket is mandatory. The lamp must always be inserted into the socket shortly. It is mandatory to insert lighting fixtures only with correct electric data (socket, voltage, wattage). Defective lighting fixtures have to be replaced immediately, but only when switched off

(New socket to be used).

INCREASING THE LIFESPAN OF A LAMP

A reduction in electric currency for lighting of 10-15% increases the lifespan of a lamp considerably. The maximum permitted voltage, e.g. 12V / 24V, must under no circumstance be exceeded at the lighting fixtures. An even voltage drop in the wires leading to the lighting fixtures has to be ensured.

The measures for downlights indicated in the catalogue state the measures of the light and the bulb. The particular built-in standards in reference to the built-in depths must be followed.



**Ruck
Zuck**

LEUCHTMITTELWECHSEL

- Innenring herausziehen
- Leuchtmittel austauschen
- Innenring wieder einclipen

CHANGE OF HALOGEN LAMP

- pull out the interior ring
- change halogen lamp
- reinsert the interior ring

MODUL
ELECTRO
www.modulelectro.ru
Clip IN

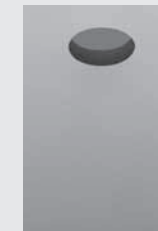

Separates Deckenteil des Strahlers ermöglicht Vorinstallation der Leuchte, zum Renovieren der Decke wird nur das Vorderteil abgezogen.

Separate ceiling-ring provides easy installation. The front can be removed for renovation of the ceiling.



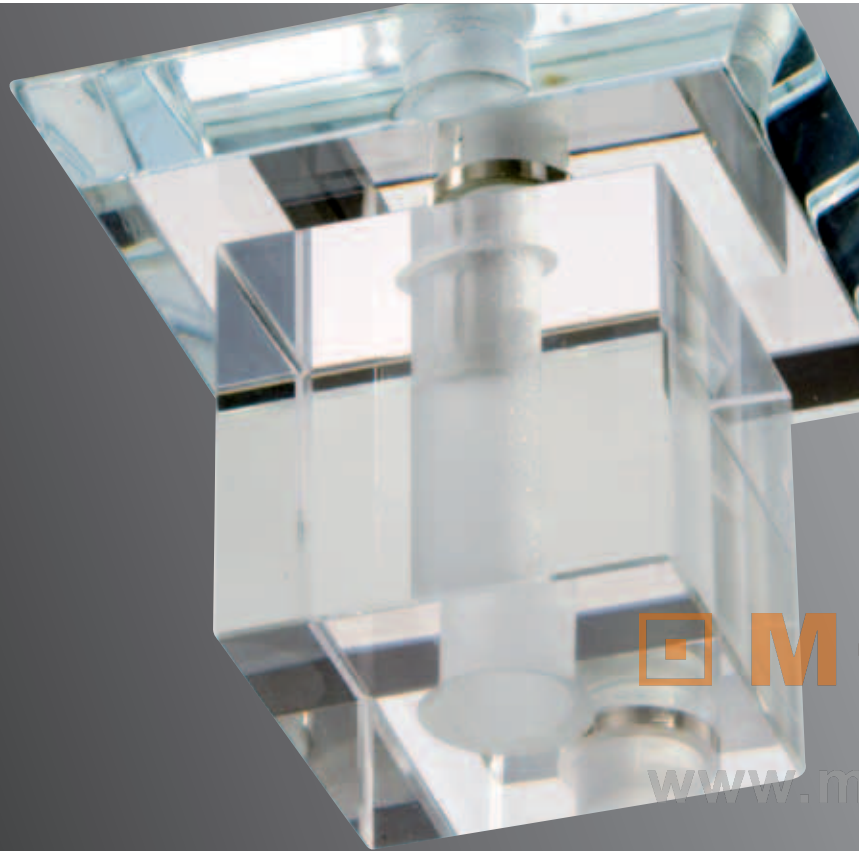

Vorteil:

- kleine Baugröße
- interessante Effekte

Anwendung:

- Flure, Foyers, Gastronomie, Privaträume, Orientierungslinien, Vitrinenbeleuchtung

Advantage:

- small installations size
- interesting effects

Application:

- halls, lounges, gastronomy, private rooms, guidelines, showcase lighting



MODUL
ELECTRO
www.modulelectro.ru

Lichtpunkte / Sternenhimmel | light spots / starry sky

Lichtpunkte / Sternenhimmel | light spots / starry sky

2030...



Lichtpunkt / light spot

Artikel-Nr. article-no.	Preis € price €
2030.02	6,50
2030.03	8,20
2030.05	7,00
2030.07	6,00
2030.08	6,60

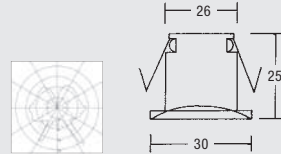

Material material	Bestückung lamp	Leistung power	Schutzart degree of protection	Schutzklasse protection class
Guss / cast	1x G4 QT9	max. 20W	IP20	III



2020...



Lichtpunkt / light spot

Artikel-Nr. article-no.	Preis € price €
2020.00	22,70
2020.02	24,70
2020.03	27,50
2020.07	19,80

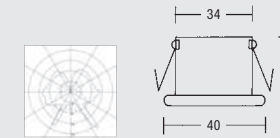

Material material	Bestückung lamp	Leistung power	Schutzart degree of protection	Schutzklasse protection class
Messing / brass	1x G4 QT9	max. 20W	IP20	III



2031...



Lichtpunkt / light spot

Artikel-Nr. article-no.	Preis € price €
2031.02	7,40
2031.03	9,00
2031.05	7,90
2031.07	6,70

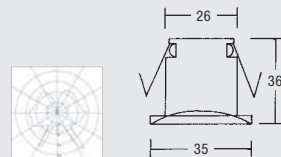

Material material	Bestückung lamp	Leistung power	Schutzart degree of protection	Schutzklasse protection class
Guss / cast	1x G4 QT9	max. 20W	IP20	III



303500

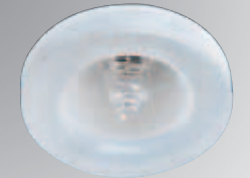

Lichtpunkt / light spot

Artikel-Nr. article-no.	Preis € price €
303500	32,00

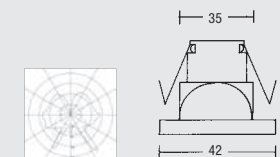

Material material	Bestückung lamp	Leistung power	Schutzart degree of protection	Schutzklasse protection class
Eisen-Glas satiniert iron-glass satin	1x G4 QT9	max. 10W	IP20	III



2039...



Lichtpunkt / light spot

Artikel-Nr. article-no.	Preis € price €
2039.05	19,90

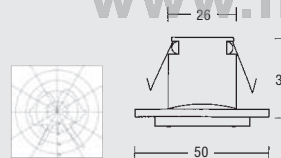

Material material	Bestückung lamp	Leistung power	Schutzart degree of protection	Schutzklasse protection class
Guss-Messing / cast-brass	1x G4 QT9	max. 20W	IP20	III



innen gold, außen chrom
inside gold, outside chrom
bicolour

0232...



Lichtpunkt / light spot

Artikel-Nr. article-no.	Preis € price €
0232.02	15,10
0232.03	17,10

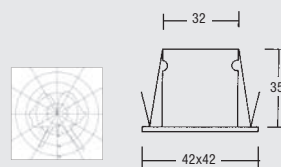

Material material	Bestückung lamp	Leistung power	Schutzart degree of protection	Schutzklasse protection class
Eisen / iron	1x G4 QT9	max. 20W	IP20	III



MODUL
ELECTRO
www.modulelectro.ru



Lichtpunkte / Sternenhimmel | light spots / starry sky

Lichtpunkte / Sternenhimmel | light spots / starry sky

0240.00



Lichtpunkt / light spot

Artikel-Nr. article-no.	Preis € price €
024000	19,10

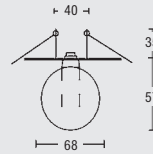

Farbe: Glas klar
colour: glass clear

Material material	Bestückung lamp	Leistung power	Schutzart degree of protection	Schutzklasse protection class
Eisen-Glas / iron glass	1x G4 QT9	max. 20W	IP20	III



Lieferung inkl. AMP-Stecker
AMP Zubehör siehe Seite 470
delivery incl. AMP-plug
AMP accessories see page 470

0241.00



Lichtpunkt / light spot

Artikel-Nr. article-no.	Preis € price €
024100	17,90

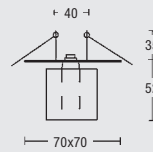

Farbe: Glas klar
colour: glass clear

Material material	Bestückung lamp	Leistung power	Schutzart degree of protection	Schutzklasse protection class
Eisen-Glas / iron glass	1x G4 QT9	max. 20W	IP20	III



Lieferung inkl. AMP-Stecker
AMP Zubehör siehe Seite 470
delivery incl. AMP-plug
AMP accessories see page 470

0237.02

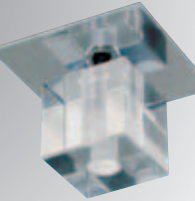

Lichtpunkt / light spot

Artikel-Nr. article-no.	Preis € price €
0237.02	18,30

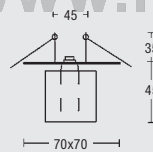

Farbe: Glas klar
colour: glass clear

Material material	Bestückung lamp	Leistung power	Schutzart degree of protection	Schutzklasse protection class
Eisen-Glas / iron glass	1x G4 QT9	max. 20W	IP20	III



Lieferung inkl. AMP-Stecker
AMP Zubehör siehe Seite 470
delivery incl. AMP-plug
AMP accessories see page 470

0238.02

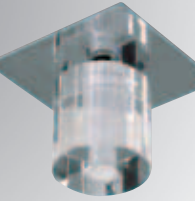

Lichtpunkt / light spot

Artikel-Nr. article-no.	Preis € price €
0238.02	18,30

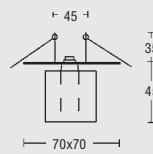
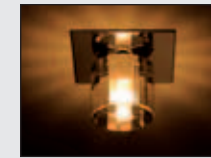

Farbe: Glas klar
colour: glass clear

Material material	Bestückung lamp	Leistung power	Schutzart degree of protection	Schutzklasse protection class
Eisen-Glas / iron glass	1x G4 QT9	max. 20W	IP20	III



Lieferung inkl. AMP-Stecker
AMP Zubehör siehe Seite 470
delivery incl. AMP-plug
AMP accessories see page 470



Maritim Hotel, Düsseldorf

MODUL
ELECTRO
www.modulelectro.ru



MODUL
ELECTRO
www.modulelectro.ru

Vorteil:

- Preisgünstig
- Farbvarianten

Anwendung:

- Trockenräume wie Foyers, Flure, Schaufenster, Büros, Wohn- und Esszimmer, usw.

Advantage:

- Well - priced
- Colour variants

Application:

- Dry rooms like lounges, halls, shop windows offices, living- and dining rooms, etc.



Hotel Ochsenwirthshof, Bad Rippoldsau

2047...



Niedervolt-Strahler / low voltage spot

Artikel-Nr. article-no.	Preis € price €
2047.02	8,10
2047.03	9,80
2047.05	8,60
2047.07	6,80

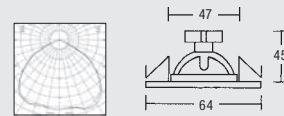

Material material	Bestückung lamp	Leistung power	Schutzart degree of protection	Schutzklasse protection class
Eisen / iron	1x GZ4 QRCBC35	max. 35W	IP20	III



2019...



Niedervolt-Strahler / low voltage spot

Artikel-Nr. article-no.	Preis € price €
2019.02	15,40
2019.03	16,60
2019.07	11,20

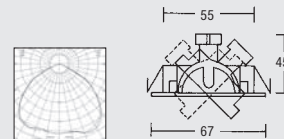

Material material	Bestückung lamp	Leistung power	Schutzart degree of protection	Schutzklasse protection class
Eisen-Messing / iron-brass	1x GZ4 QRCBC35	max. 35W	IP20	III



1926...



Niedervolt-Strahler / low voltage spot

Artikel-Nr. article-no.	Preis € price €
1926.02	20,90
1926.07	18,30

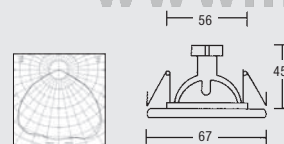

Material material	Bestückung lamp	Leistung power	Schutzart degree of protection	Schutzklasse protection class
Eisen / iron	1x GZ4 QRCBC35	max. 35W	IP20	III



1927...

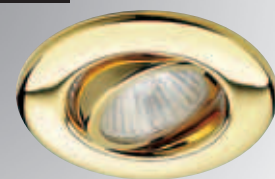

Niedervolt-Strahler / low voltage spot

Artikel-Nr. article-no.	Preis € price €
1927.05	26,10
1927.07	21,50
1927.15	29,10

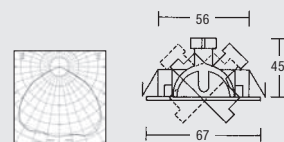

Material material	Bestückung lamp	Leistung power	Schutzart degree of protection	Schutzklasse protection class
Eisen / iron	1x GZ4 QRCBC35	max. 35W	IP20	III



Niedervolt-Strahler / low voltage spot

Artikel-Nr. article-no.	Preis € price €
1935.02	23,50
1935.07	21,70
1935.26	26,70

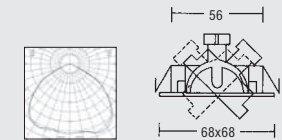

Material material	Bestückung lamp	Leistung power	Schutzart degree of protection	Schutzklasse protection class
Eisen / iron	1x GZ4 QRCBC35	max. 35W	IP20	III



1935...



Niedervolt-Strahler / low voltage spot

Artikel-Nr. article-no.	Preis € price €
2011.02	8,80
2011.05	9,40
2011.06	9,70
2011.07	7,30
2011.15	9,90

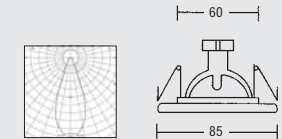

Material material	Bestückung lamp	Leistung power	Schutzart degree of protection	Schutzklasse protection class
Eisen / iron	1x GX5,3 QRCBC51	max. 50W	IP20	III



2011...



www.modulelectro.ru

Niedervolt-Strahler / low voltage spot

Artikel-Nr. article-no.	Preis € price €
2017.02	8,70
2017.03	12,40
2017.04	18,70
2017.05	9,20
2017.06	10,95
2017.07	7,60

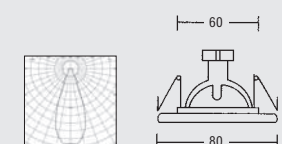

Material material	Bestückung lamp	Leistung power	Schutzart degree of protection	Schutzklasse protection class
Eisen / iron	1x GX5,3 QRCBC51	max. 50W	IP20	III



2017...



Niedervolt-Strahler / low voltage spot

Artikel-Nr. article-no.	Preis € price €
1938.02	19,40
1938.05	22,10
1938.07	18,30
1938.15	24,80

Blendungsbegrenzung durch tief liegendes Leuchtmittel
limitation of glare by inside-mounted bulb



Material material	Bestückung lamp	Leistung power	Schutzart degree of protection	Schutzklasse protection class
Eisen / iron	1x GX5,3 QRCBC51	max. 50W	IP20	III



1938...

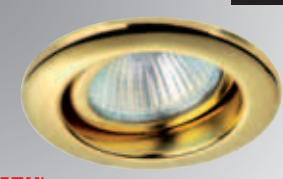

NEU new!

2034...



Niedervolt-Strahler / low voltage spot

Artikel-Nr. article-no.	Preis € price €
2034.02	14,60
2034.03	17,80
2034.04	21,50
2034.05	15,20
2034.06	17,90
2034.07	10,30
2034.08	12,20

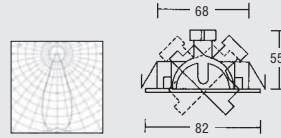

Material material	Bestückung lamp	Leistung power	Schutzart degree of protection	Schutzklasse protection class
Eisen-Messing iron-brass	1x GX5,3 QRCBC51	max. 50W	IP20	III



2052...



Niedervolt-Strahler / low voltage spot

Artikel-Nr. article-no.	Preis € price €
2052.00	20,30
2052.02	18,30
2052.03	22,70
2052.07	14,30

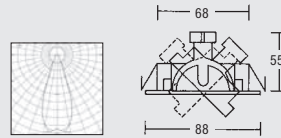

Material material	Bestückung lamp	Leistung power	Schutzart degree of protection	Schutzklasse protection class
Eisen-Messing / iron-brass	1x GX5,3 QRCBC51	max. 50W	IP20	III



2000...



Niedervolt-Strahler / low voltage spot

Artikel-Nr. article-no.	Preis € price €
2000.00	15,00
2000.02	13,10
2000.03	16,20
2000.07	11,30

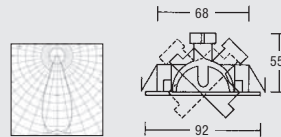

Material material	Bestückung lamp	Leistung power	Schutzart degree of protection	Schutzklasse protection class
Eisen-Messing / iron-brass	1x GX5,3 QRCBC51	max. 50W	IP20	III



2012...



Niedervolt-Strahler / low voltage spot

Artikel-Nr. article-no.	Preis € price €
2012.02	14,40
2012.05	15,60
2012.07	10,20
2012.15	16,20

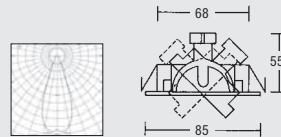

Material material	Bestückung lamp	Leistung power	Schutzart degree of protection	Schutzklasse protection class
Eisen / iron	1x GX5,3 QRCBC51	max. 50W	IP20	III



Niederdrucklampen / low pressure lamps

Artikel-Nr. article-no.	Preis € price €
2046.02	37,70
2046.03	39,80
2046.05	38,70
2046.07	35,40

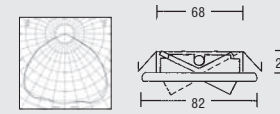

Material material	Bestückung lamp	Leistung power	Schutzart degree of protection	Schutzklasse protection class
Eisen-Messing-Glas klar iron-brass-glass clear	1x G4 QT9	max. 20W	IP20	III

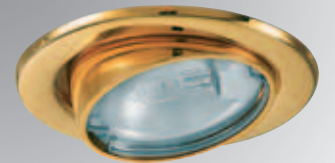

Für flache Einbautiefen
For low installation depth

2046...

Niedervolt-Strahler / low voltage spot

Artikel-Nr. article-no.	Preis € price €
2295.00	11,70
2295.02	11,10
2295.07	8,30
2295.15	11,70

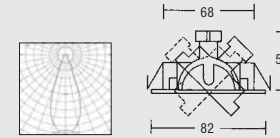

Material material	Bestückung lamp	Leistung power	Schutzart degree of protection	Schutzklasse protection class
Eisen / iron	1x GX5,3 QRCBC51	max. 50W	IP20	III



2295...



MODULO ELECTRO
www.modulelectro.ru

Niedervolt-Strahler / low voltage spot

Artikel-Nr. article-no.	Preis € price €
2296.00	12,40
2296.02	11,50
2296.07	8,90
2296.15	12,40

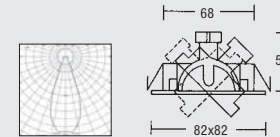

Material material	Bestückung lamp	Leistung power	Schutzart degree of protection	Schutzklasse protection class
Eisen / iron	1x GX5,3 QRCBC51	max. 50W	IP20	III



2296...



Niedervolt-Strahler / low voltage spot

Artikel-Nr. article-no.	Preis € price €
1996.02	16,90
1996.05	18,10
1996.06	32,70
1996.07	14,60
1996.15	21,40

Ruck
Zuck

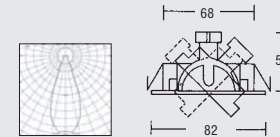

Material material	Bestückung lamp	Leistung power	Schutzart degree of protection	Schutzklasse protection class
Eisen / iron	1x GX5,3 QRCBC51	max. 50W	IP20	III



1996...



1998...



Niedervolt-Strahler / low voltage spot

Artikel-Nr. article-no.	Preis € price €
1998.02	53,80
1998.07	48,30
1998.15	61,50

Ruck
Zuck

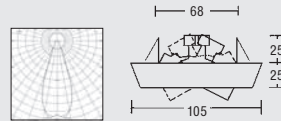

Material material	Bestückung lamp	Leistung power	Schutzart degree of protection	Schutzklasse protection class
Eisen / iron	1x GX5,3 QRCBC51	max. 50W	IP20	III



1925.17

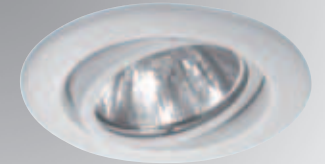

Niedervolt-Strahler / low voltage spot

Artikel-Nr. article-no.	Preis € price €
1925.17	17,60

Clip

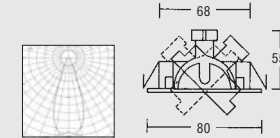

Farbe: struktur-weiß / colour: structure white

Material material	Bestückung lamp	Leistung power	Schutzart degree of protection	Schutzklasse protection class
Eisen / iron	1x GX5,3 QRCBC51	max. 50W	IP20	III



1924...

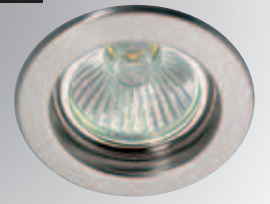

Niedervolt-Strahler / low voltage spot

Artikel-Nr. article-no.	Preis € price €
1924.02	20,30
1924.07	17,60
1924.15	26,10

Clip

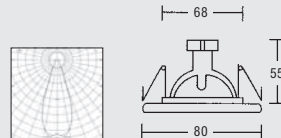

Material material	Bestückung lamp	Leistung power	Schutzart degree of protection	Schutzklasse protection class
Eisen / iron	1x GX5,3 QRCBC51	max. 50W	IP20	III



1996.51



Niedervolt-Strahler / low voltage spot

Artikel-Nr. article-no.	Preis € price €
1996.51	23,50

Ruck
Zuck

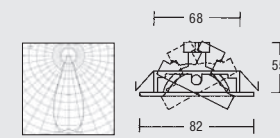

Farbe: gold-weiß / colour: gold-white

Material material	Bestückung lamp	Leistung power	Schutzart degree of protection	Schutzklasse protection class
Eisen / iron	1x GX5,3 QRCBC51	max. 50W	IP20	III



1925...

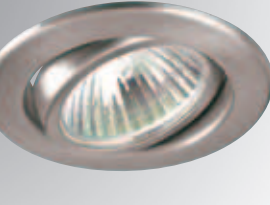

Niedervolt-Strahler / low voltage spot

Artikel-Nr. article-no.	Preis € price €
1925.02	18,40
1925.05	21,10
1925.06	29,70
1925.07	17,30
1925.15	23,80

Clip

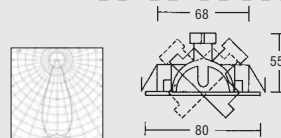

Material material	Bestückung lamp	Leistung power	Schutzart degree of protection	Schutzklasse protection class
Eisen / iron	1x GX5,3 QRCBC51	max. 50W	IP20	III



2050...

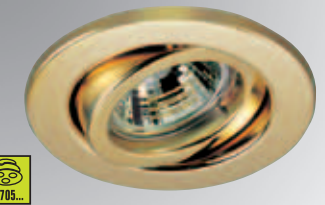

Niedervolt-Strahler / low voltage spot

Artikel-Nr. article-no.	Preis € price €
2050.02	18,50
2050.03	22,40
2050.04	21,20
2050.05	19,80
2050.07	14,80

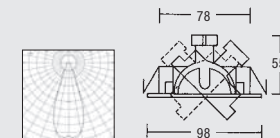

Material material	Bestückung lamp	Leistung power	Schutzart degree of protection	Schutzklasse protection class
Eisen / iron	1x GX5,3 QRCBC51	max. 50W	IP20	III



1936...



Niedervolt-Strahler / low voltage spot

Artikel-Nr. article-no.	Preis € price €
1936.02	20,80
1936.05	23,80
1936.07	18,50
1936.26	24,20

Clip

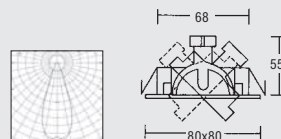

Material material	Bestückung lamp	Leistung power	Schutzart degree of protection	Schutzklasse protection class
Eisen / iron	1x GX5,3 QRCBC51	max. 50W	IP20	III



2048...

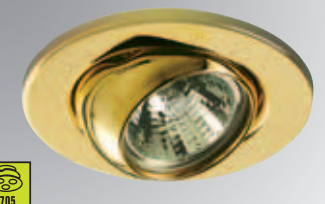

Niedervolt-Strahler / low voltage spot

Artikel-Nr. article-no.	Preis € price €
2048.02	18,20
2048.03	20,80
2048.05	19,40
2048.07	13,10

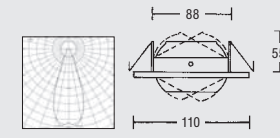

Material material	Bestückung lamp	Leistung power	Schutzart degree of protection	Schutzklasse protection class
Eisen / iron	1x GX5,3 QRCBC51	max. 50W	IP20	III



MODULO
ELECTRO
www.modulelectro.ru



Vorteil:

- Preisgünstig
- Formen- und Designvielfalt

Anwendung:

- Trockenräume wie Foyers, Flure, Schaufenster, Büros, Wohn- und Esszimmer, usw.

Advantage:

- Well - priced
- A great variety of shape and design

Application:

- Dry rooms like lounges, halls, shop windows offices, living- and dining rooms, etc.



MODUL
ELECTRO
www.modulelectro.ru

2003...



Niedervolt-Strahler / low voltage spot

Artikel-Nr. article-no.	Preis € price €
2003.02	10,10
2003.03	12,60
2003.05	11,40
2003.07	8,80

Rand gewölbt
edge vaulted

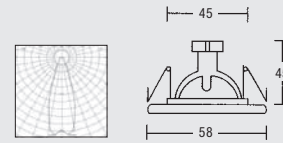

Material material	Bestückung lamp	Leistung power	Schutzart degree of protection	Schutzklasse protection class
Guss / cast	1x GZ4 QRCBC35	max. 20W	IP20	III

2104...

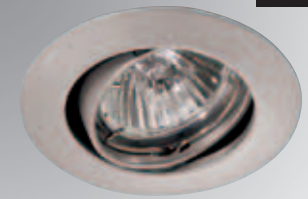

Niedervolt-Strahler / low voltage spot

Artikel-Nr. article-no.	Preis € price €
2104.01	17,10
2104.02	13,40
2104.03	18,00
2104.05	15,90
2104.07	10,10

Rand schräg
edge angular

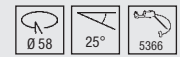
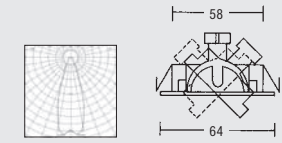

Material material	Bestückung lamp	Leistung power	Schutzart degree of protection	Schutzklasse protection class
Guss / cast	1x GZ4 QRCBC35	max. 35W	IP20	III

2103...



Niedervolt-Strahler / low voltage spot

Artikel-Nr. article-no.	Preis € price €
2103.01	11,00
2103.02	8,90
2103.03	11,70
2103.04	11,80
2103.05	10,30
2103.07	7,90

Rand schräg
edge angular

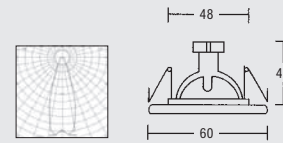

Material material	Bestückung lamp	Leistung power	Schutzart degree of protection	Schutzklasse protection class
Guss / cast	1x GZ4 QRCBC35	max. 35W	IP20	III

2013...

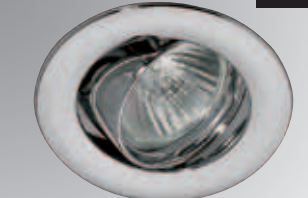

Niedervolt-Strahler / low voltage spot

Artikel-Nr. article-no.	Preis € price €
2013.02	15,30
2013.03	19,90
2013.05	18,00
2013.07	12,10

Rand gewölbt
edge vaulted

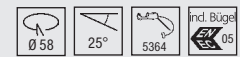
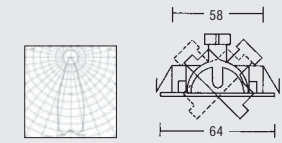

Material material	Bestückung lamp	Leistung power	Schutzart degree of protection	Schutzklasse protection class
Guss / cast	1x GZ4 QRCBC35	max. 20W	IP20	III

0067...



Niedervolt-Strahler / low voltage spot

Artikel-Nr. article-no.	Preis € price €
0067.25	13,50

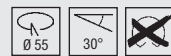
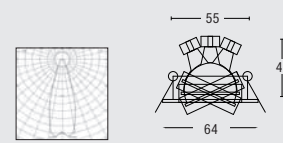

Material material	Bestückung lamp	Leistung power	Schutzart degree of protection	Schutzklasse protection class
Aluminium / aluminium	1x GZ4 QRCBC35	max. 35W	IP20	III

2033...

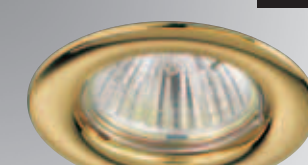

Niedervolt-Strahler / low voltage spot

Artikel-Nr. article-no.	Preis € price €
2033.02	10,80
2033.03	14,10
2033.05	12,10
2033.07	9,50

Rand gewölbt
edge vaulted

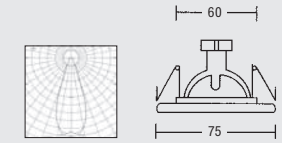

Material material	Bestückung lamp	Leistung power	Schutzart degree of protection	Schutzklasse protection class
Guss / cast	1x GX5,3 QRCBC51	max. 50W	IP20	III

0068...



Niedervolt-Strahler / low voltage spot

Artikel-Nr. article-no.	Preis € price €
0068.25	15,50

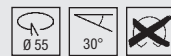
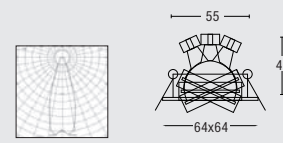

Material material	Bestückung lamp	Leistung power	Schutzart degree of protection	Schutzklasse protection class
Aluminium / aluminium	1x GZ4 QRCBC35	max. 35W	IP20	III

2203...



Niedervolt-Strahler / low voltage spot

Artikel-Nr. article-no.	Preis € price €
2203.02	12,60
2203.03	13,40
2203.05	12,90

Rand gewölbt
edge vaulted

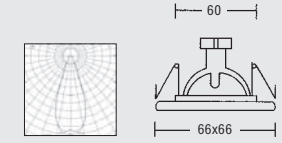

Material material	Bestückung lamp	Leistung power	Schutzart degree of protection	Schutzklasse protection class
Guss / cast	1x GX5,3 QRCBC51	max. 50W	IP20	III

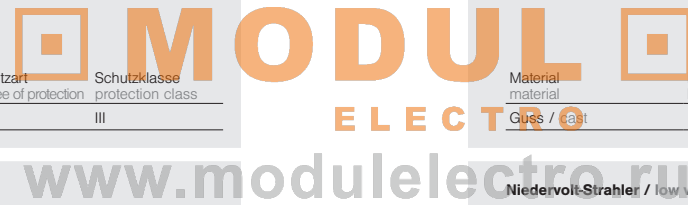

ONE for ALL - Ein Strahler für alle gängigen Leuchtmittel

Der Wunsch unserer Partner war es, ein Strahler für alle gängigen Leuchtmittel zu entwickeln. Hier ist die Lösung! Zwei Geometrien, vier Oberflächen und vier Bügel stehen zur Verfügung. Konfigurieren Sie sich den Strahlern nach Ihren Wünschen. Vom Hochvolt-Halogen Leuchtmittel bis zum effizienten LED-Einsatz – hiermit ist alles möglich! Mit diesem Strahler kann man auf 6 verschiedene Lichtquellen (GX5,3 / GU10 / GZ10 / LED 12V / LED 350mA / LED 700mA) zurückgreifen.

ONE for ALL - One spot for all established illuminants

Our partners requested for the development of one spot for all kind of illuminants. Here it is! Two different designs, four surface variations and four diverse clamps are available. Create your own spot. From a high-voltage lamp up to an efficient LED insert – there are no limits! This spot offers 6 options of light sources (GX5,3 / GU10 / GZ10 / LED 12V / LED 350mA / LED 700 mA).

2110...

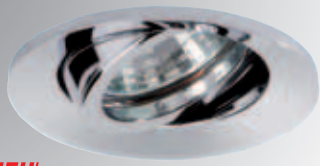

Niedervolt-Strahler / low voltage spot

Artikel-Nr. article-no.	Preis € price €
2110.02	19,40
2110.05	22,10
2110.07	18,30
2110.15	24,80

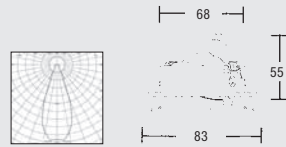

Rand konisch zurückgesetzt / border conical recessed

Material material	Bestückung lamp	Leistung power	Schutzart degree of protection	Schutzklasse protection class
Aluminiumguss / alu cast	1x GX5,3 QRCBC51	max. 50W	IP20	III



! Separate Bügel Seite 239
! Separate clamp page 239

2111...



Niedervolt-Strahler / low voltage spot

Artikel-Nr. article-no.	Preis € price €
2111.02	20,40
2111.05	23,10
2111.07	19,30
2111.15	25,80

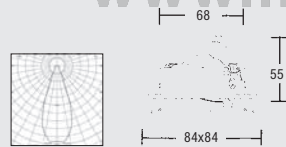

Rand konisch zurückgesetzt / border conical recessed

Material material	Bestückung lamp	Leistung power	Schutzart degree of protection	Schutzklasse protection class
Aluminiumguss / alu cast	1x GX5,3 QRCBC51	max. 50W	IP20	III



! Separate Bügel Seite 239
! Separate clamp page 239

Patentiertes System / patented system

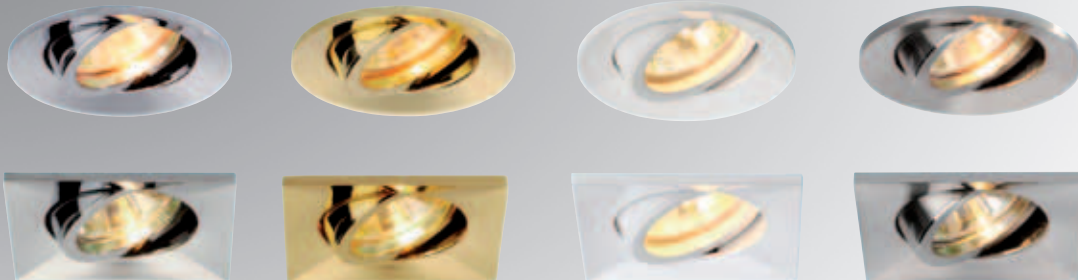

Bügel für Einbaustrahler „One for All“ / clamp for recessed ceiling spot „One for all“

Artikel-Nr. article-no.	Preis € price €
5387	4,30

Bügel für die Einbaustrahler „One for All“ Artikel 2110 und 2111 mit Niedervoltfassung GX5,3 und beidseitiger Zugentlastung. Clamp for recessed ceiling spot „One for all“, article-no. 2110 and 2111 with low-voltage socket GX5,3 and two-sided strain relief.

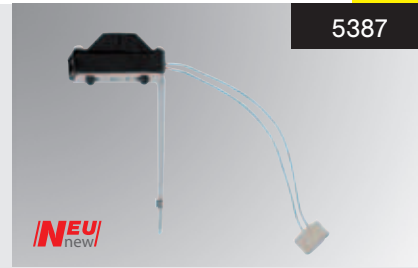

5387

Bügel für Einbaustrahler „One for All“ / clamp for recessed ceiling spot „One for all“

Artikel-Nr. article-no.	Preis € price €
5397	6,30

Bügel für die Einbaustrahler „One for All“ Artikel 2110 und 2111 mit Hochvoltfassung GZ10 und beidseitiger Zugentlastung. Clamp for recessed ceiling spot „One for all“, article-no. 2110 and 2111 with high-voltage socket GX5,3 and two-sided strain relief.



5397

Bügel für Einbaustrahler „One for All“ / clamp for recessed ceiling spot „One for all“

Artikel-Nr. article-no.	Preis € price €
5388	6,90

Bügel für die Einbaustrahler „One for All“ Artikel 2110 und 2111 LED Anschluss 350mA mit beidseitiger Zugentlastung Plug & Play = Anschlüsse mit Stecksystem. Clamp for recessed ceiling spot „One for all“, article-no. 2110 and 2111 with LED connection 350mA with two-sided strain relief „Plug & Play“ = connections with plug-in system.

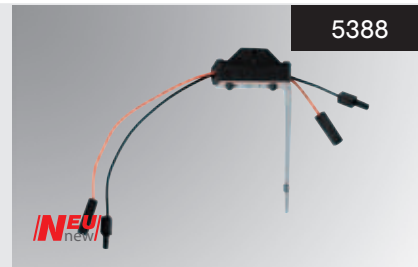

5388

Bügel für Einbaustrahler „One for All“ / clamp for recessed ceiling spot „One for all“

Artikel-Nr. article-no.	Preis € price €
5398	6,90

Bügel für die Einbaustrahler „One for All“ Artikel 2110 und 2111 LED Anschluss 700mA mit beidseitiger Zugentlastung Plug & Play = Anschlüsse mit Stecksystem. Clamp for recessed ceiling spot „One for all“, article-no. 2110 and 2111 with LED connection 700mA with two-sided strain relief „Plug & Play“ = connections with plug-in system.

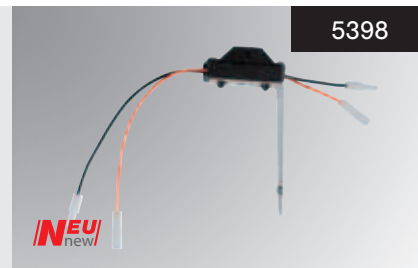

5398

MODUL
ELECTRO
www.modulelectro.ru

2183...

Niedervolt-Strahler / low voltage spot



Artikel-Nr. article-no.	Preis € price €
2183.25	27,30

Rand schräg
edge angular

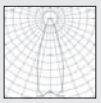
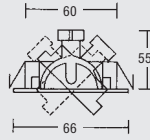



Material material	Bestückung lamp	Leistung power	Schutzart degree of protection	Schutzklasse protection class
Aluminiumguss aluminium cast	1x GX4 QRCBC35	max. 35W	IP20	III



1928...

Niedervolt-Strahler / low voltage spot



Clip

Rand schräg
edge angular

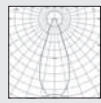
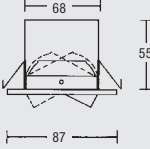
Artikel-Nr. article-no.	Preis € price €
1928.02	20,20
1928.05	21,10
1928.06	20,30
1928.07	17,20
1928.15	21,10

Material material	Bestückung lamp	Leistung power	Schutzart degree of protection	Schutzklasse protection class
Guss-Eisen / cast-iron	1x GX5,3 QRCBC51	max. 50W	IP20	III



2117...

Niedervolt-Strahler / low voltage spot



Artikel-Nr. article-no.	Preis € price €
2117.01	10,80
2117.02	8,10
2117.03	9,80
2117.05	9,20
2117.07	7,00

Rand schräg
edge angular

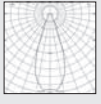
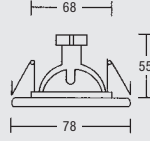



Material material	Bestückung lamp	Leistung power	Schutzart degree of protection	Schutzklasse protection class
Guss / cast	1x GX5,3 QRCBC51	max. 50W	IP20	III



2169...

Niedervolt-Strahler / low voltage spot

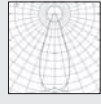
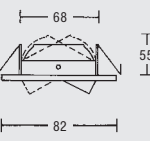

Rand schräg
edge angular

Artikel-Nr. article-no.	Preis € price €
2169.02	16,70
2169.03	18,60
2169.05	18,00
2169.07	11,90
2169.35	18,90

Material material	Bestückung lamp	Leistung power	Schutzart degree of protection	Schutzklasse protection class
Guss / cast	1x GX5,3 QRCBC51	max. 50W	IP20	III

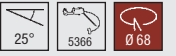

2170...

Niedervolt-Strahler / low voltage spot



Artikel-Nr. article-no.	Preis € price €
2170.02	32,90
2170.05	32,90
2170.25	25,90

Rand schräg
edge angular





Material material	Bestückung lamp	Leistung power	Schutzart degree of protection	Schutzklasse protection class
Aluminiumguss aluminium cast	1x GX5,3 QRCBC51	max. 50W	IP20	III



2540...

Niedervolt-Strahler / low voltage spot



Artikel-Nr. article-no.	Preis € price €
2540.25	26,70

Rand schräg
edge angular

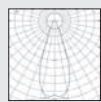
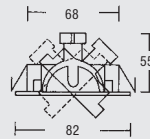
Material material	Bestückung lamp	Leistung power	Schutzart degree of protection	Schutzklasse protection class
Aluminium / aluminium	1x GX5,3 QRCBC51	max. 50W	IP20	III



2535...

Niedervolt-Strahler / low voltage spot



Artikel-Nr. article-no.	Preis € price €
2535.25	44,00

Rand schräg
edge angular





Material material	Bestückung lamp	Leistung power	Schutzart degree of protection	Schutzklasse protection class
Aluminium / aluminium	1x GX5,3 QRCBC51	max. 50W	IP20	III



2542...

Niedervolt-Strahler / low voltage spot



Artikel-Nr. article-no.	Preis € price €
2542.25	28,50

Rand schräg
edge angular

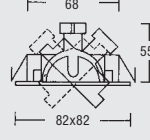
Material material	Bestückung lamp	Leistung power	Schutzart degree of protection	Schutzklasse protection class
Aluminium / aluminium	1x GX5,3 QRCBC51	max. 50W	IP20	III



MODULO
ELECTRO
www.modulelectro.ru

0064...

Niedervolt-Strahler / low voltage spot



Artikel-Nr. / article-no. Preis € / price €
0064.00 15,50





Farbe: schwarz-alu / colour: black-alu

Material / material	Bestückung / lamp	Leistung / power	Schutzart / degree of protection	Schutzklasse / protection class
Aluminium / aluminium	1x GX5,3 QRCBC51	max. 50W	IP20	III

30°  

2094...

Niedervolt-Strahler / low voltage spot



Artikel-Nr. / article-no. Preis € / price €
2094.25 32,10

Blendungsbegrenzung durch tiefliegendes Leuchtmittel / limitation of glare by inside-mounted bulb

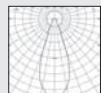
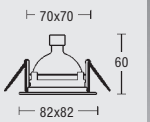
Farbe: alu-schwarz / colour: alu-black

Material / material	Bestückung / lamp	Leistung / power	Schutzart / degree of protection	Schutzklasse / protection class
Aluminiumguss / aluminium cast	1x GX5,3 QRCBC51	max. 50W	IP20	III

 Ø 70x70

0066...

Niedervolt-Strahler / low voltage spot



Artikel-Nr. / article-no. Preis € / price €
0066.00 19,60





Farbe: schwarz-alu / colour: black-alu

Material / material	Bestückung / lamp	Leistung / power	Schutzart / degree of protection	Schutzklasse / protection class
Aluminium / aluminium	1x GX5,3 QRCBC51	max. 50W	IP20	III

30°  



2392...

Niedervolt-Strahler / low voltage spot

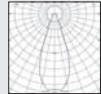

Artikel-Nr. / article-no. Preis € / price €
2392.07 13,50
2392.15 14,50

Blendungsbegrenzung durch tiefliegendes Leuchtmittel / limitation of glare by inside-mounted bulb

Farbe: schwarz-alu / colour: black-alu

Material / material	Bestückung / lamp	Leistung / power	Schutzart / degree of protection	Schutzklasse / protection class
Guss / Kunststoff / cast / plastic	1x GX5,3 QRCBC51	max. 50W	IP20	III

 Ø 72

0063...

Niedervolt-Strahler / low voltage spot



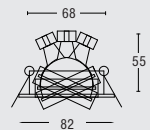

Artikel-Nr. / article-no. Preis € / price €
0063.25 14,50

Farbe: schwarz-alu / colour: black-alu

Material / material	Bestückung / lamp	Leistung / power	Schutzart / degree of protection	Schutzklasse / protection class
Aluminium / aluminium	1x GX5,3 QRCBC51	max. 50W	IP20	III

30°  

2118...

Niedervolt-Strahler / low voltage spot



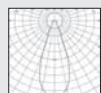
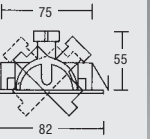

Artikel-Nr. / article-no. Preis € / price €
2118.01 17,30
2118.02 13,50
2118.03 15,10
2118.04 15,60
2118.05 14,60
2118.07 9,20

Rand schräg / edge angular

Farbe: schwarz-alu / colour: black-alu

Material / material	Bestückung / lamp	Leistung / power	Schutzart / degree of protection	Schutzklasse / protection class
Guss / cast	1x GX5,3 QRCBC51	max. 50W	IP20	III

 Ø 75 25°  5366

0065...

Niedervolt-Strahler / low voltage spot



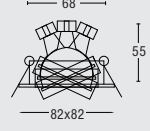

Artikel-Nr. / article-no. Preis € / price €
0065.25 16,50

Farbe: schwarz-alu / colour: black-alu

Material / material	Bestückung / lamp	Leistung / power	Schutzart / degree of protection	Schutzklasse / protection class
Aluminium / aluminium	1x GX5,3 QRCBC51	max. 50W	IP20	III

30°  

2093...

Niedervolt-Strahler / low voltage spot





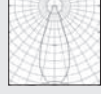
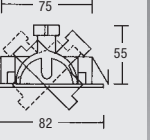

Artikel-Nr. / article-no. Preis € / price €
2093.02 18,00
2093.03 19,90
2093.04 20,60
2093.05 19,30
2093.07 12,90

Rand gewölbt / edge vaulted

Farbe: schwarz-alu / colour: black-alu

Material / material	Bestückung / lamp	Leistung / power	Schutzart / degree of protection	Schutzklasse / protection class
Guss / cast	1x GX5,3 QRCBC51	max. 50W	IP20	III

 Ø 75 25°  5314  5363  5364  Ind. Bügel 05

MODUL
ELECTRO
www.modulelectro.ru

2204...



Niedervolt-Strahler / low voltage spot

Artikel-Nr. article-no.	Preis € price €
2204.02	19,60
2204.03	20,10
2204.05	20,60
2204.07	16,70

Rand gewölbt
edge vaulted

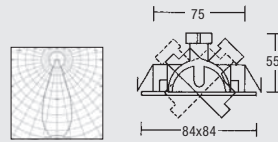

Material material	Bestückung lamp	Leistung power	Schutzart degree of protection	Schutzklasse protection class
Guss / cast	1x GX5,3 QRCBC51	max. 50W	IP20	III



2186...



Niedervolt-Strahler / low voltage spot

Artikel-Nr. article-no.	Preis € price €
2186.25	33,80

Rand schräg
edge angular

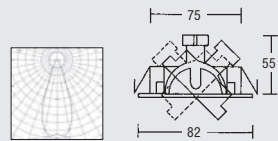

Material material	Bestückung lamp	Leistung power	Schutzart degree of protection	Schutzklasse protection class
Aluminiumguss aluminium cast	1x GX5,3 QRCBC51	max. 50W	IP20	III



0069...



Niedervolt-Strahler / low voltage spot

Artikel-Nr. article-no.	Preis € price €
0069.25	18,50

**Ruck
Zuck**

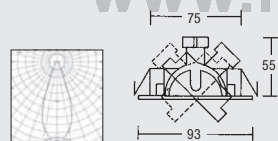

Material material	Bestückung lamp	Leistung power	Schutzart degree of protection	Schutzklasse protection class
Aluminium aluminium	1x GX5,3 QRCBC51	max. 50W	IP20	III



NEU
new

0070...



Niedervolt-Strahler / low voltage spot

Artikel-Nr. article-no.	Preis € price €
0070.25	20,50

**Ruck
Zuck**

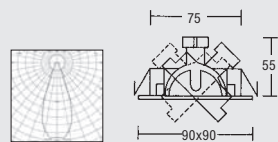

Material material	Bestückung lamp	Leistung power	Schutzart degree of protection	Schutzklasse protection class
Aluminium aluminium	1x GX5,3 QRCBC51	max. 50W	IP20	III



NEU
new



Niedervolt-Strahler / low voltage spot

Artikel-Nr. article-no.	Preis € price €
2174.25	33,20

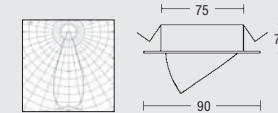

Material material	Bestückung lamp	Leistung power	Schutzart degree of protection	Schutzklasse protection class
Aluminiumguss aluminium cast	1x GX5,3 QRCBC51	max. 50W	IP20	III



2174...



MODULO
ELECTRO

www.modulelectro.ru

Niedervolt-Strahler / low voltage spot

Artikel-Nr. article-no.	Preis € price €
2159.25	53,40

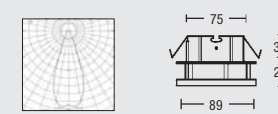

Material material	Bestückung lamp	Leistung power	Schutzart degree of protection	Schutzklasse protection class
Guss-Aluminium cast-aluminium	1x GX5,3 QRCBC51	max. 50W	IP20	III



2159...



Niedervolt-Strahler / low voltage spot

Artikel-Nr. article-no.	Preis € price €
2547.22	57,80

Blendungsbegrenzung
durch tiefliegendes
Leuchtmittel
limitation of glare
by inside-mounted bulb

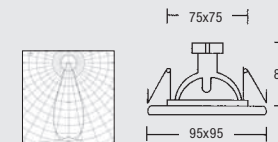

Farbe: edelstahl-schwarz / colour: stainless steel-black

Material material	Bestückung lamp	Leistung power	Schutzart degree of protection	Schutzklasse protection class
Edelstahl / stainless steel	1x GX5,3 QRCBC51	max. 50W	IP20	III



2547...

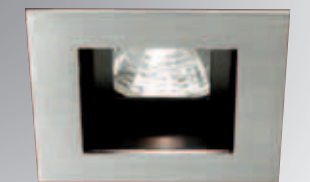

Guss / Aluminium | cast / aluminium

Guss / Aluminium | cast / aluminium

2538...



Niedervolt-Strahler / low voltage spot

Artikel-Nr. article-no.	Preis € price €
2538.25	29,00

kardanische
Aufhängung
gimballed mounting

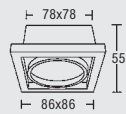

Material material	Bestückung lamp	Leistung power	Schutzart degree of protection	Schutzklasse protection class
Aluminium / aluminium	1x GX5,3 QRCBC51	max. 50W	IP20	III



1929...

Niedervolt-Strahler / low voltage spot

Artikel-Nr. article-no.	Preis € price €
1929.02	39,00
1929.07	36,00
1929.15	42,00

Nur Aluminium Reflektor-
lampen einsetzen!
Only use aluminium
reflector lamps!

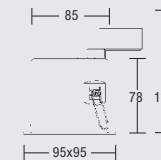
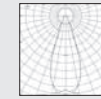

UK Patent GB2426321. Integriertes intumeszentes (dämmschichtbildendes) Material dichtet das Downlight und den Deckenausschnitt im Fall eines Feuers ab. Getestet für BS EN ISO 140-3: 1995 & BS EN ISO 140-6: 1998 (Akustik). Diese bestätigen, dass der Schallschutz für ein internes oder separates Stockwerk gewährleistet wird.
UK Patent GB2426321. Integrated intumescent material completely seals the downlight and cut-out in case of fire. Tested to BS EN ISO 140-3: 1995 & BS EN ISO 140-6: 1998 (Acoustics). They are confirming that they maintain the ability for an internal or separating floor to provide sound insulation.

Material material	Bestückung lamp	Leistung power	Schutzart degree of protection	Schutzklasse protection class
Aluminiumguss / Stahl aluminium cast / steel	1x GX5,3 QRCBC51	max. 50W	IP65	III



2147...



Clip

Niedervolt-Strahler / low voltage spot

Artikel-Nr. article-no.	Preis € price €
2147.15	25,10

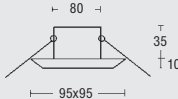

Material material	Bestückung lamp	Leistung power	Schutzart degree of protection	Schutzklasse protection class
Guss - Glas satiniert cast - glass satined	1x GY6,35 QT12	max. 35W	IP20	III



2132...

Niedervolt-Strahler / low voltage spot

Artikel-Nr. article-no.	Preis € price €
2132.07	23,60
2132.15	30,80

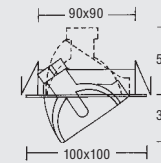
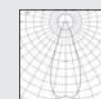

Material material	Bestückung lamp	Leistung power	Schutzart degree of protection	Schutzklasse protection class
Aluminiumguss aluminium cast	1x GX5,3 QRCBC51	max. 50W	IP20	III



1969...



Niedervolt-Strahler / low voltage spot

Artikel-Nr. article-no.	Preis € price €
1969.17	23,00

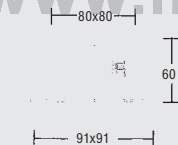

Farbe: struktur-weiß / colour: structure white

Material material	Bestückung lamp	Leistung power	Schutzart degree of protection	Schutzklasse protection class
Guss - Glas satiniert cast - glass satin	1x GY6,35/QT12	max. 35W	IP20	III



2139...

Niedervolt-Strahler / low voltage spot

Artikel-Nr. article-no.	Preis € price €
2139.02	30,60
2139.03	34,20
2139.07	26,20

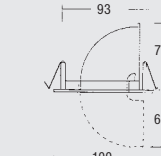

Material material	Bestückung lamp	Leistung power	Schutzart degree of protection	Schutzklasse protection class
Guss / cast	1x GX5,3 QRCBC51	max. 50W	IP20	III

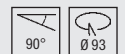

2154...

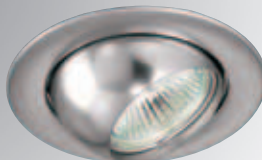

Niedervolt-Strahler / low voltage spot

Artikel-Nr. article-no.	Preis € price €
2154.02	32,90
2154.03	39,90
2154.05	38,70
2154.07	25,00

Rand gewölbt
edge vaulted

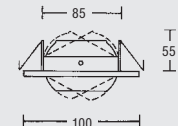

Material material	Bestückung lamp	Leistung power	Schutzart degree of protection	Schutzklasse protection class
Guss / cast	1x GX5,3 QRCBC51	max. 50W	IP20	III



2100...

Niedervolt-Strahler / low voltage spot

Artikel-Nr. article-no.	Preis € price €
2100.07	26,00
2100.15	36,00

Clip

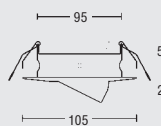

Material material	Bestückung lamp	Leistung power	Schutzart degree of protection	Schutzklasse protection class
Guss / cast	1x GX5,3 QRCBC51	max. 50W	IP20	III





MODUL
ELECTRO
www.modulelectro.ru

Vorteil:

- Hochwertig
- Haltbarkeit

Anwendung:

- Wellness-Bereich, Feuchtraum, Schaufenster, Vordächer, Garagen, Küchen bzw. Kochzonen.

Hinweis: In Küstennähe bitte Oberfläche .20 oder Material V4A bestellen!

Advantage:

- High quality
- Durability

Application:

- spa areas, humid location, shop windows, porches, garages, kitchens or cooking zones

Advice: For goods installed inshore, please order the article with key .20 or material V4A!



Reiner Edelstahl | pure stainless steel

Reiner Edelstahl | pure stainless steel

1196...

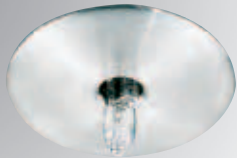

Sternenhimmel für Niederdrucklampen / starry sky for low pressure lamps

Artikel-Nr. article-no.	Preis € price €
1196.07	28,40
1196.20	28,40
1196.22	26,70

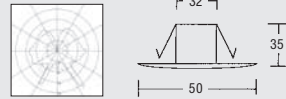

Material material	Bestückung lamp	Leistung power	Schutzart degree of protection	Schutzklasse protection class
Rein Edelstahl pure stainless steel	1x G4 QT9	max. 20W	IP20	III



1194...

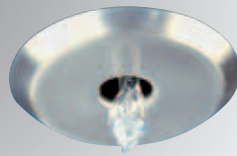

Sternenhimmel für Niederdrucklampen / starry sky for low pressure lamps

Artikel-Nr. article-no.	Preis € price €
1194.22	33,60

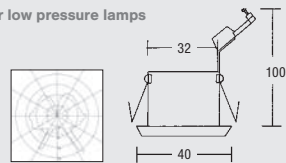

Material material	Bestückung lamp	Leistung power	Schutzart degree of protection	Schutzklasse protection class
Rein Edelstahl pure stainless steel	1x G4 QT9	max. 20W	IP20	III



1192...



Niedervolt-Strahler / low voltage spot

Artikel-Nr. article-no.	Preis € price €
1192.20	19,90
1192.22	18,60

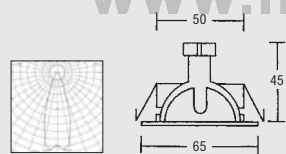

Material material	Bestückung lamp	Leistung power	Schutzart degree of protection	Schutzklasse protection class
Rein Edelstahl pure stainless steel	1x GZ4 QRCBC35	max. 35W	IP20	III

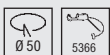

1193...



Niedervolt-Strahler / low voltage spot

Artikel-Nr. article-no.	Preis € price €
1193.07	23,80
1193.20	25,40
1193.22	23,30

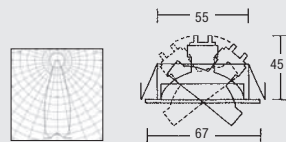

Material material	Bestückung lamp	Leistung power	Schutzart degree of protection	Schutzklasse protection class
Edelstahl-Messing stainless steel - brass	1x GZ4 QRCBC35	max. 35W	IP20	III



2190...



Niedervolt-Strahler / low voltage spot

Artikel-Nr. article-no.	Preis € price €
2190.07	18,40
2190.20	18,40
2190.22	16,80

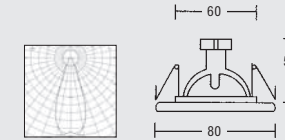

Material material	Bestückung lamp	Leistung power	Schutzart degree of protection	Schutzklasse protection class
Rein Edelstahl pure stainless steel	1x GX5,3 QRCBC51	max. 50W	IP20	III



1190...

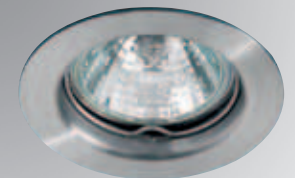

Niedervolt-Strahler / low voltage spot

Artikel-Nr. article-no.	Preis € price €
1190.07	22,70
1190.20	22,70
1190.22	21,50

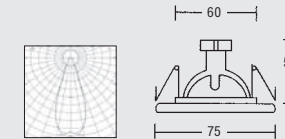

Material material	Bestückung lamp	Leistung power	Schutzart degree of protection	Schutzklasse protection class
Rein Edelstahl pure stainless steel	1x GX5,3 QRCBC51	max. 50W	IP20	III



1191...



Niedervolt-Strahler / low voltage spot

Artikel-Nr. article-no.	Preis € price €
1191.07	34,60
1191.20	34,60
1191.22	32,20

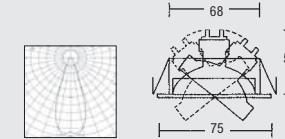

Material material	Bestückung lamp	Leistung power	Schutzart degree of protection	Schutzklasse protection class
Rein Edelstahl pure stainless steel	1x GX5,3 QRCBC51	max. 50W	IP20	III



2191...

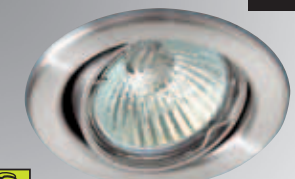

Niedervolt-Strahler / low voltage spot

Artikel-Nr. article-no.	Preis € price €
2191.07	21,90
2191.20	21,90
2191.22	20,10

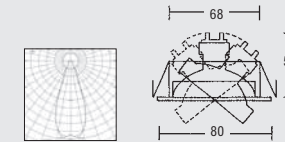

Material material	Bestückung lamp	Leistung power	Schutzart degree of protection	Schutzklasse protection class
Edelstahl-Messing stainless steel-brass	1x GX5,3 QRCBC51	max. 50W	IP20	III

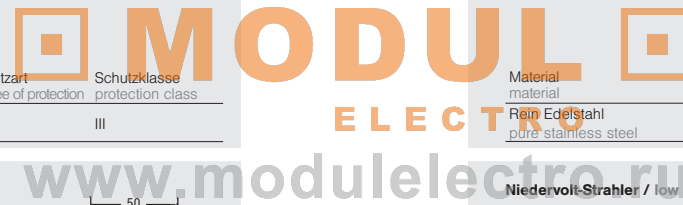

Reiner Edelstahl | pure stainless steel

Reiner Edelstahl | pure stainless steel

1996...



Niedervolt-Strahler / low voltage spot

Artikel-Nr. article-no.	Preis € price €
1996.20	35,40
1996.22	32,20

Ruck Zuck

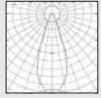
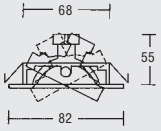
Material: Rein Edelstahl / pure stainless steel
 Bestückung: 1x GX5,3 QRCBC51
 Leistung: max. 50W
 Schutzart: IP20
 Schutzklasse: III

Icons: Ø 68, 25°, 5313, 5353, 5364, X

1180...



Niedervolt-Strahler / low voltage spot

Artikel-Nr. article-no.	Preis € price €
1180.22	60,80

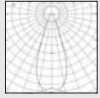
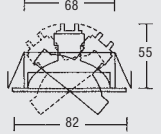



R3705...

Material: Edelstahl V4A / stainless steel V4A
 Bestückung: 1x GX5,3 QRCBC51
 Leistung: max. 50W
 Schutzart: IP20
 Schutzklasse: III

Icons: X, 25°, Ø 68

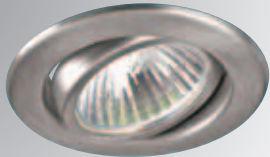
1925...



Niedervolt-Strahler / low voltage spot

Artikel-Nr. article-no.	Preis € price €
1925.20	36,30
1925.22	33,10
1925.27	36,30

Clip

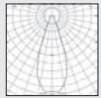
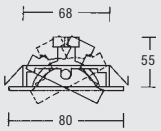
Material: Rein Edelstahl / pure stainless steel
 Bestückung: 1x GX5,3 QRCBC51
 Leistung: max. 50W
 Schutzart: IP20
 Schutzklasse: III

Icons: Ø 68, 25°, 5313, 5364, X

1181...



Niedervolt-Strahler / low voltage spot

Artikel-Nr. article-no.	Preis € price €
1181.22	64,90

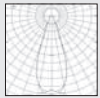
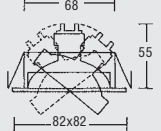
R3705...

Material: Edelstahl V4A / stainless steel V4A
 Bestückung: 1x GX5,3 QRCBC51
 Leistung: max. 50W
 Schutzart: IP20
 Schutzklasse: III

Icons: X, 25°, Ø 68





MODULO
ELECTRO
www.modulelectro.ru

2337.42

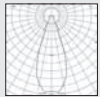

Niedervolt-Strahler / low voltage spot

Artikel-Nr. article-no.	Preis € price €	Blendungsbegrenzung durch tiefliegendes Leuchtmittel limitation of glare by inside-mounted bulb
2337.42	40,00	





NEU new!

Material: Edelstahl V4A / stainless steel V4A
 Bestückung: 1x GX5,3 QRCBC51
 Leistung: max. 50W
 Schutzart: IP20
 Schutzklasse: III



Icons: X, 25°, Ø 68

2338.42

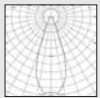

Niedervolt-Strahler / low voltage spot

Artikel-Nr. article-no.	Preis € price €	Blendungsbegrenzung durch tiefliegendes Leuchtmittel limitation of glare by inside-mounted bulb
2338.42	42,00	

NEU new!

Material: Edelstahl V4A / stainless steel V4A
 Bestückung: 1x GX5,3 QRCBC51
 Leistung: max. 50W
 Schutzart: IP20
 Schutzklasse: III

Icons: X, 25°, Ø 68

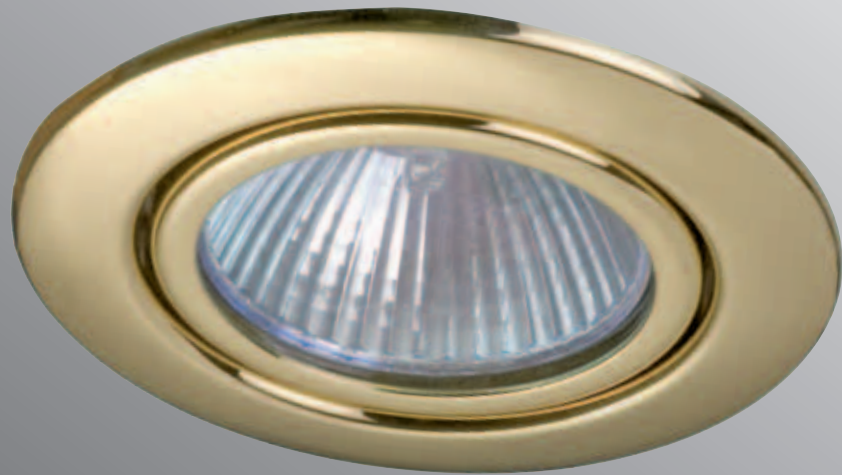

MODUL
ELECTRO
www.modulelectro.ru

Vorteil:

- Hochwertigkeit
- Haltbarkeit

Anwendung:

- Im Innenbereich, Wohn- und Esszimmer, Flure, Foyers usw.

Advantage:

- High quality
- Durability

Application:

- Indoor, living- and diningrooms, corridors, entrance halls, etc.

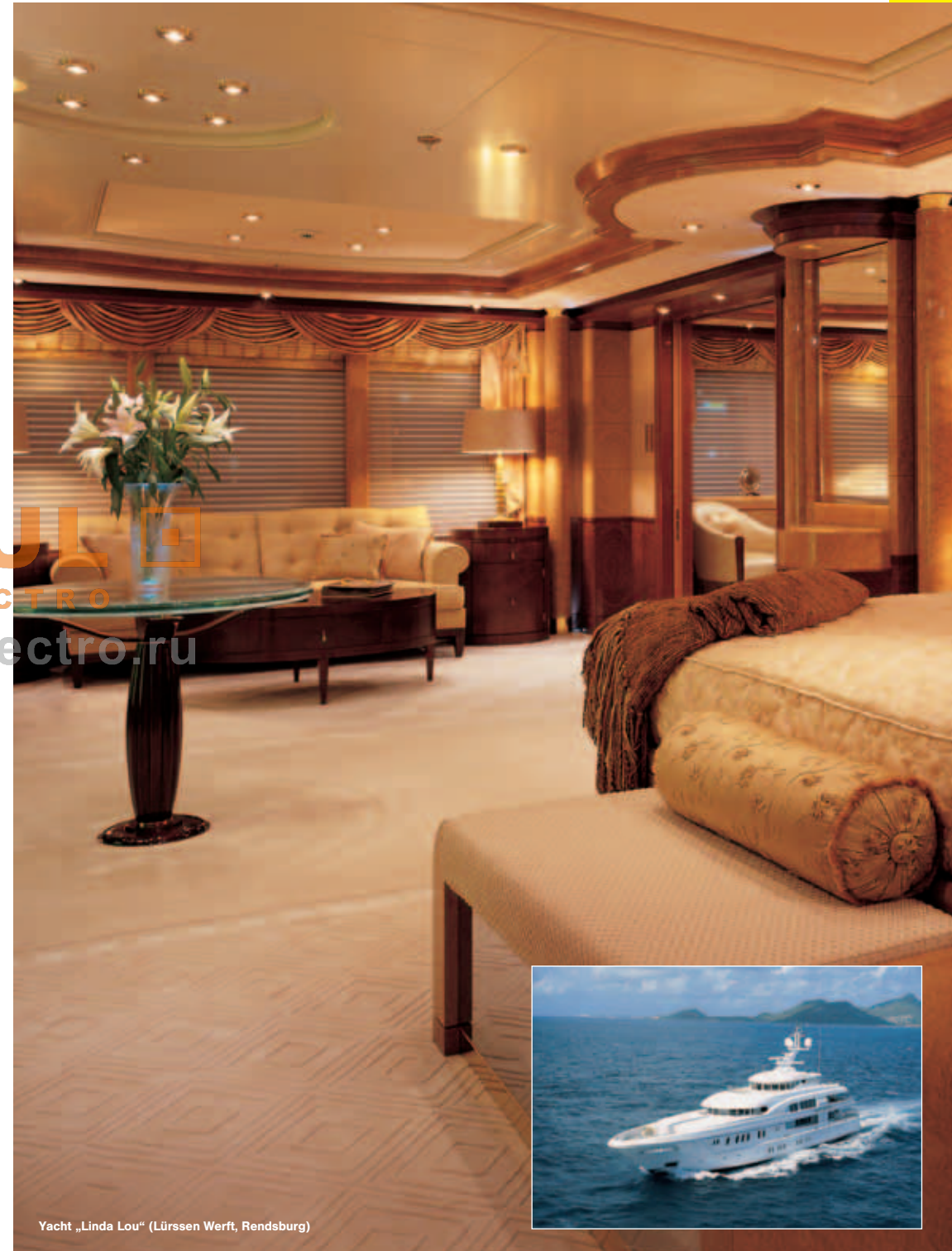

Yacht „Linda Lou“ (Lürssen Werft, Rendsburg)

Rein Messing | pure brass

Rein Messing | pure brass

2087...



Niedervolt-Strahler / low voltage spot

Artikel-Nr. article-no.	Preis € price €
2087.02	19,40
2087.03	24,30
2087.07	15,20

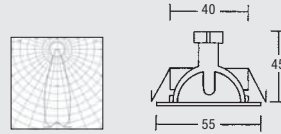

Material material	Bestückung lamp	Leistung power	Schutzart degree of protection	Schutzklasse protection class
Rein Messing pure brass	1x GZ4 QRCBC35	max. 35W	IP20	III



2082...

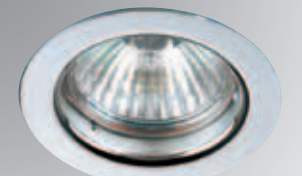

Niedervolt-Strahler / low voltage spot

Artikel-Nr. article-no.	Preis € price €
2082.00	25,00
2082.02	23,80
2082.03	27,70
2082.07	20,00

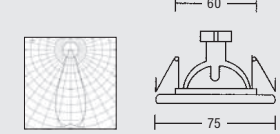

Material material	Bestückung lamp	Leistung power	Schutzart degree of protection	Schutzklasse protection class
Rein Messing pure brass	1x GX5,3 QRCBC51	max. 50W	IP20	III



1023...



Niedervolt-Strahler / low voltage spot

Artikel-Nr. article-no.	Preis € price €
1023.02	36,60
1023.03	42,20

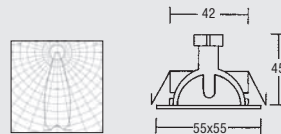

Material material	Bestückung lamp	Leistung power	Schutzart degree of protection	Schutzklasse protection class
Rein Messing pure brass	1x GZ4 QRCBC35	max. 35W	IP20	III



1052...



Niedervolt-Strahler / low voltage spot

Artikel-Nr. article-no.	Preis € price €
1052.03	50,10
1052.07	42,60

Blendungsbegrenzung durch tiefliegendes Leuchtmittel
limitation of glare by inside-mounted bulb

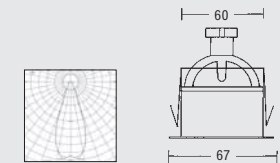

Material material	Bestückung lamp	Leistung power	Schutzart degree of protection	Schutzklasse protection class
Rein Messing pure brass	1x GX5,3 QRCBC51	max. 50W	IP20	III



2089...

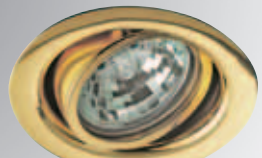

Niedervolt-Strahler / low voltage spot

Artikel-Nr. article-no.	Preis € price €
2089.00	27,40
2089.03	33,40

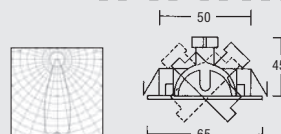

Material material	Bestückung lamp	Leistung power	Schutzart degree of protection	Schutzklasse protection class
Rein Messing pure brass	1x GZ4 QRCBC35	max. 35W	IP20	III



1007...



Niedervolt-Strahler / low voltage spot

Artikel-Nr. article-no.	Preis € price €
1007.03	54,10
1007.07	46,40

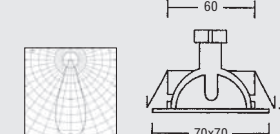

Material material	Bestückung lamp	Leistung power	Schutzart degree of protection	Schutzklasse protection class
Rein Messing pure brass	1x GX5,3 QRCBC51	max. 50W	IP20	III



1026...



Niedervolt-Strahler / low voltage spot

Artikel-Nr. article-no.	Preis € price €
1026.02	46,70
1026.03	53,60
1026.07	43,60

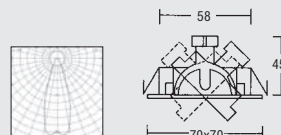

Material material	Bestückung lamp	Leistung power	Schutzart degree of protection	Schutzklasse protection class
Rein Messing pure brass	1x GZ4 QRCBC35	max. 35W	IP20	III



2067...



Niedervolt-Strahler / low voltage spot

Artikel-Nr. article-no.	Preis € price €
2067.00	31,20
2067.01	36,30
2067.02	30,10
2067.03	38,70
2067.04	35,00
2067.07	24,40

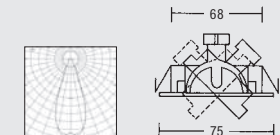

Material material	Bestückung lamp	Leistung power	Schutzart degree of protection	Schutzklasse protection class
Rein Messing pure brass	1x GX5,3 QRCBC51	max. 50W	IP20	III



MODULO
ELECTRO
www.modulelectro.ru

1937...



Niedervolt-Strahler / low voltage spot

Artikel-Nr. article-no.	Preis € price €
1937.00	27,30

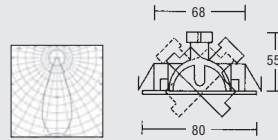

Material material	Bestückung lamp	Leistung power	Schutzart degree of protection	Schutzklasse protection class
Rein Messing pure brass	1x GX5,3 QRCBC51	max. 50W	IP20	III



1009...

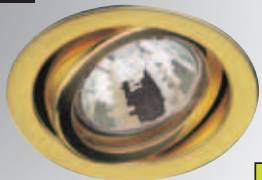

Niedervolt-Strahler / low voltage spot

Artikel-Nr. article-no.	Preis € price €
1009.00	53,80

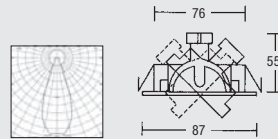

Material material	Bestückung lamp	Leistung power	Schutzart degree of protection	Schutzklasse protection class
Rein Messing pure brass	1x GX5,3 QRCBC51	max. 50W	IP20	III



1053...



Niedervolt-Strahler / low voltage spot

Artikel-Nr. article-no.	Preis € price €
1053.00	61,30
1053.02	59,90
1053.03	65,60
1053.04	62,60
1053.07	57,10

Blendungsbegrenzung durch tiefliegendes Leuchtmittel
limitation of glare by inside-mounted bulb

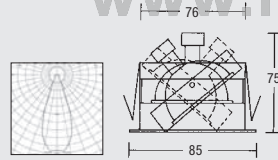

Material material	Bestückung lamp	Leistung power	Schutzart degree of protection	Schutzklasse protection class
Rein Messing pure brass	1x GX5,3 QRCBC51	max. 50W	IP20	III



1010...

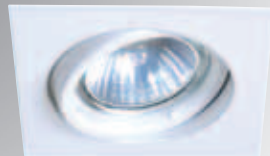

Niedervolt-Strahler / low voltage spot

Artikel-Nr. article-no.	Preis € price €
1010.02	67,50
1010.03	69,70
1010.07	57,70

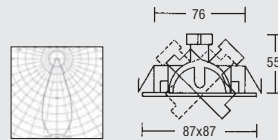

Material material	Bestückung lamp	Leistung power	Schutzart degree of protection	Schutzklasse protection class
Rein Messing pure brass	1x GX5,3 QRCBC51	max. 50W	IP20	III



MODULO
ELECTRO
www.modulelectro.ru



MODUL
ELECTRO
www.modulelectro.ru

Vorteil:

- Kein Transformator erforderlich (Hochvolt)
- Einsatz von Allgebrauchs- und PAR-Lampen (Hochvolt-Reflektorlampen)

Anwendung:

- Je nach Material im Innen- und Außenbereich (Hochvolt)
- Trockene Innenräume (Hochvolt-Reflektorlampen)

Advantage:

- No transformer required (high-voltage)
- Application of general service and PAR lamps (high-voltage - reflector lamps)

Application:

- Indoor and outdoor, depending on the material (high-voltage)
- Dry indoor room (high-voltage - reflector lamps)



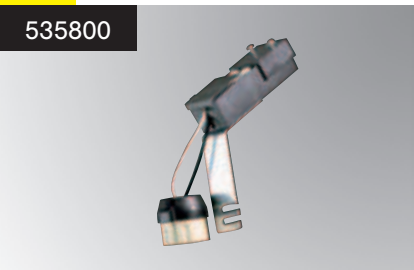

Federsystem Hochvolt-Bügel / clip system high-voltage clamp

Artikel-Nr. article-no.	Preis € price €
535800	9,50

Folgende Leuchten werden immer inkl. Hochvoltbügel und beidseitiger Zugentlastung geliefert. Weitere Modelle sind auf Anfrage ebenfalls in der Hochvoltversion lieferbar.

Bügel für Einbaustrahler zum Nachrüsten mit Hochvolt-Fassung GZ10 und beidseitiger Zugentlastung.

The following lighting fittings will invariably be delivered with clamp. Further models are also available in high-voltage on request

Clamp for downlights to upgrade with high-voltage socket GZ10 and two-sided strain relief.



Stecksystem Hochvolt-Bügel / plug system high-voltage clamp

Artikel-Nr. article-no.	Preis € price €
535900	9,50

Folgende Leuchten werden immer inkl. Hochvoltbügel und beidseitiger Zugentlastung geliefert. Weitere Modelle sind auf Anfrage ebenfalls in der Hochvoltversion lieferbar.

Bügel für Einbaustrahler zum Nachrüsten mit Hochvolt-Fassung GZ10 und beidseitiger Zugentlastung.

The following lighting fittings will invariably be delivered with clamp. Further models are also available in high-voltage on request

Clamp for downlights to upgrade with high-voltage socket GZ10 and two-sided strain relief.



Hochvolt-Strahler / high-voltage spot

Artikel-Nr. article-no.	Preis € price €
2350.02	22,60
2350.03	27,00
2350.05	24,70
2350.07	18,90

Rand gewölbt
edge vaulted

MEGAMAN®
EnergieSparLampen
geeignet für Megaman-Energiesparlampe 51mm (7, 9,11W)
adapted for Megaman energy-saving lamp 51mm (7, 9,11W)

Material material	Bestückung lamp	Leistung power	Schutzart degree of protection	Schutzklasse protection class
Guss / cast	1x GZ10 QPAR51	max. 50W	IP20	II

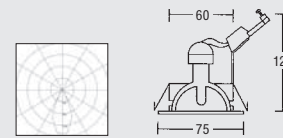

Hochvolt-Strahler / high-voltage spot

Artikel-Nr. article-no.	Preis € price €
H2191.07	31,40
H2191.20	31,40
H2191.22	29,60

MEGAMAN®
EnergieSparLampen
geeignet für Megaman-Energiesparlampe 51mm (7, 9,11W)
adapted for Megaman energy-saving lamp 51mm (7, 9,11W)

Material material	Bestückung lamp	Leistung power	Schutzart degree of protection	Schutzklasse protection class
Edelstahl-Messing stainless steel - brass	1x GZ10 QPAR51	max. 50W	IP20	II

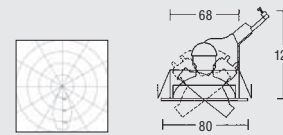

Hochvolt-Strahler / high-voltage spot

Artikel-Nr. article-no.	Preis € price €
H1191.07	44,40
H1191.20	44,40
H1191.22	42,00

MEGAMAN®
EnergieSparLampen
geeignet für Megaman-Energiesparlampe 51mm (7, 9,11W)
adapted for Megaman energy-saving lamp 51mm (7, 9,11W)

Material material	Bestückung lamp	Leistung power	Schutzart degree of protection	Schutzklasse protection class
Rein Edelstahl pure stainless steel	1x GZ10 QPAR51	max. 50W	IP20	II

Hochvolt-Strahler / high-voltage spot

Artikel-Nr. article-no.	Preis € price €
H2067.00	41,00
H2067.01	46,10
H2067.02	39,90
H2067.03	48,60
H2067.04	44,90
H2067.07	34,20

MEGAMAN®
EnergieSparLampen
geeignet für Megaman-Energiesparlampe 51mm (7, 9,11W)
adapted for Megaman energy-saving lamp 51mm (7, 9,11W)

Material material	Bestückung lamp	Leistung power	Schutzart degree of protection	Schutzklasse protection class
Rein Messing pure brass	1x GZ10 QPAR51	max. 50W	IP20	II

Hochvolt-Strahler / high-voltage spot

Artikel-Nr. article-no.	Preis € price €
M1925.02T	26,70
M1925.07T	25,70
M1925.15T	30,80
M1925.22T	41,10

MEGAMAN®
EnergieSparLampen
geeignet für Megaman-Energiesparlampe 51mm (7, 9,11W)
adapted for Megaman energy-saving lamp 51mm (7, 9,11W)

Material material	Bestückung lamp	Leistung power	Schutzart degree of protection	Schutzklasse protection class
Eisen-Edelstahl iron-stainless steel	1x GU10	max. 11W	IP20	III

Hochvolt-Strahler / high-voltage spot

Artikel-Nr. article-no.	Preis € price €
H2034.02	24,10
H2034.03	27,30
H2034.04	31,50
H2034.05	24,70
H2034.06	27,40
H2034.07	19,80
H2034.08	21,70

MEGAMAN®
EnergieSparLampen
geeignet für Megaman-Energiesparlampe 51mm (7, 9,11W)
adapted for Megaman energy-saving lamp 51mm (7, 9,11W)

Material material	Bestückung lamp	Leistung power	Schutzart degree of protection	Schutzklasse protection class
Eisen-Messing iron brass	1x GZ10 QPAR51	max. 50W	IP20	II

MODUL
ELECTRO
www.modulelectro.ru



Hochvolt-Strahler / high-voltage spot

Artikel-Nr. article-no.	Preis € price €
H1996.02	26,40
H1996.05	27,60
H1996.06	42,80
H1996.07	24,10
H1996.15	30,90

**Ruck
Zuck**

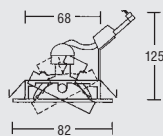

Material material	Bestückung lamp	Leistung power	Schutzart degree of protection	Schutzklasse protection class
Eisen / iron	1x GZ10 QPAR51	max. 50W	IP20	II



Hochvolt-Strahler / high-voltage spot

Artikel-Nr. article-no.	Preis € price €
2351.02	24,70
2351.03	29,70
2351.05	27,00
2351.07	20,80

Rand gewölbt
edge vaulted

MEGAMAN®
Energiesparlampen

geeignet für Megaman-Energiesparlampe 51mm (7,911W)
adapted for Megaman energy-saving lamp 51mm (7,911W)

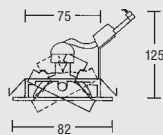

Material material	Bestückung lamp	Leistung power	Schutzart degree of protection	Schutzklasse protection class
Guss / cast	1x GZ10 QPAR51	max. 50W	IP20	II



Hochvolt-Strahler / high-voltage spot

Artikel-Nr. article-no.	Preis € price €
2164.02	32,80
2164.03	34,90
2164.07	25,60

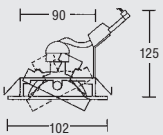

Material material	Bestückung lamp	Leistung power	Schutzart degree of protection	Schutzklasse protection class
Guss / cast	1x GU10 QPAR64	max. 75W	IP20	II



Hochvolt-Strahler / high-voltage spot

Artikel-Nr. article-no.	Preis € price €
2192.03	40,90

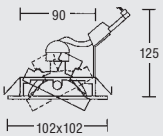

Material material	Bestückung lamp	Leistung power	Schutzart degree of protection	Schutzklasse protection class
Guss / cast	1x GU10 QPAR64	max. 75W	IP20	II



MODUL
ELECTRO
www.modulelectro.ru

2304...

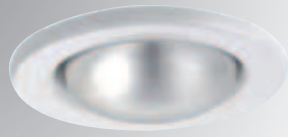

Hochvolt-Strahler / high-voltage spot

Artikel-Nr. article-no.	Preis € price €
2304.07	16,50

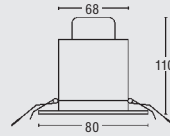

Material material	Bestückung lamp	Leistung power	Schutzart degree of protection	Schutzklasse protection class
Eisen / iron	1x R50 E14	max. 40W	IP20	II



Hochvolt-Strahler / high-voltage spot

Artikel-Nr. article-no.	Preis € price €
2302.02	20,40
2302.07	16,70

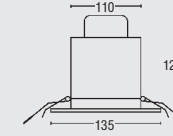

Material material	Bestückung lamp	Leistung power	Schutzart degree of protection	Schutzklasse protection class
Eisen / iron	1x QPAR30 E27	max. 75W	IP20	II

2302...



2305...



Hochvolt-Strahler / high-voltage spot

Artikel-Nr. article-no.	Preis € price €
2305.07	22,10

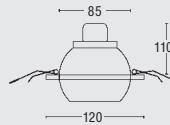

Material material	Bestückung lamp	Leistung power	Schutzart degree of protection	Schutzklasse protection class
Eisen / iron	1x R50 E14	max. 40W	IP20	II



Hochvolt-Strahler / high-voltage spot

Artikel-Nr. article-no.	Preis € price €
2307.07	23,20

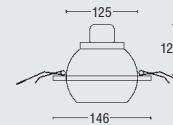

Material material	Bestückung lamp	Leistung power	Schutzart degree of protection	Schutzklasse protection class
Eisen / iron	1x R63 E27	max. 60W	IP20	II

2307...

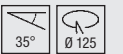

2306...



Hochvolt-Strahler / high-voltage spot

Artikel-Nr. article-no.	Preis € price €
2306.07	16,90

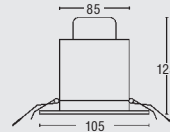

Material material	Bestückung lamp	Leistung power	Schutzart degree of protection	Schutzklasse protection class
Eisen / iron	1x R63 E27	max. 60W	IP20	II



Hochvolt-Strahler / high-voltage spot

Artikel-Nr. article-no.	Preis € price €
2303.07	27,20

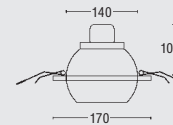

Material material	Bestückung lamp	Leistung power	Schutzart degree of protection	Schutzklasse protection class
Eisen / iron	1x QPAR30 E27	max. 75W	IP20	II

2303...

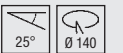

2308...

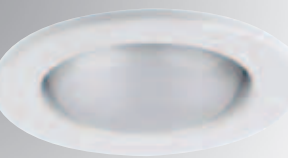

Hochvolt-Strahler / high-voltage spot

Artikel-Nr. article-no.	Preis € price €
2308.07	17,40

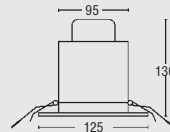

Material material	Bestückung lamp	Leistung power	Schutzart degree of protection	Schutzklasse protection class
Eisen / iron	1x R80 E27	max. 100W	IP20	II



Hochvolt-Strahler / high-voltage spot

Artikel-Nr. article-no.	Preis € price €
2309.07	30,40

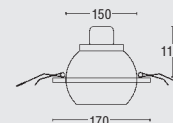

Material material	Bestückung lamp	Leistung power	Schutzart degree of protection	Schutzklasse protection class
Eisen / iron	1x R80 E27	max. 100W	IP20	II

2309...

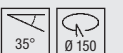

MODULO ELECTRO
www.modulelectro.ru



MODUL
ELECTRO
www.modulelectro.ru

Vorteil:

- Spritzwassergeschützt
- Design-Vielfalt

Anwendung:

- Feuchträume (Innenbereich)
Für den Außenbereich Leuchten
aus Material Edelstahl einsetzen!

Advantage:

- Splash-proof
- Design diversity

Application:

- Humid locations, porches, wellness-areas, showers
saunas, baths
For outdoor areas lights in stainless steel have to be employed!

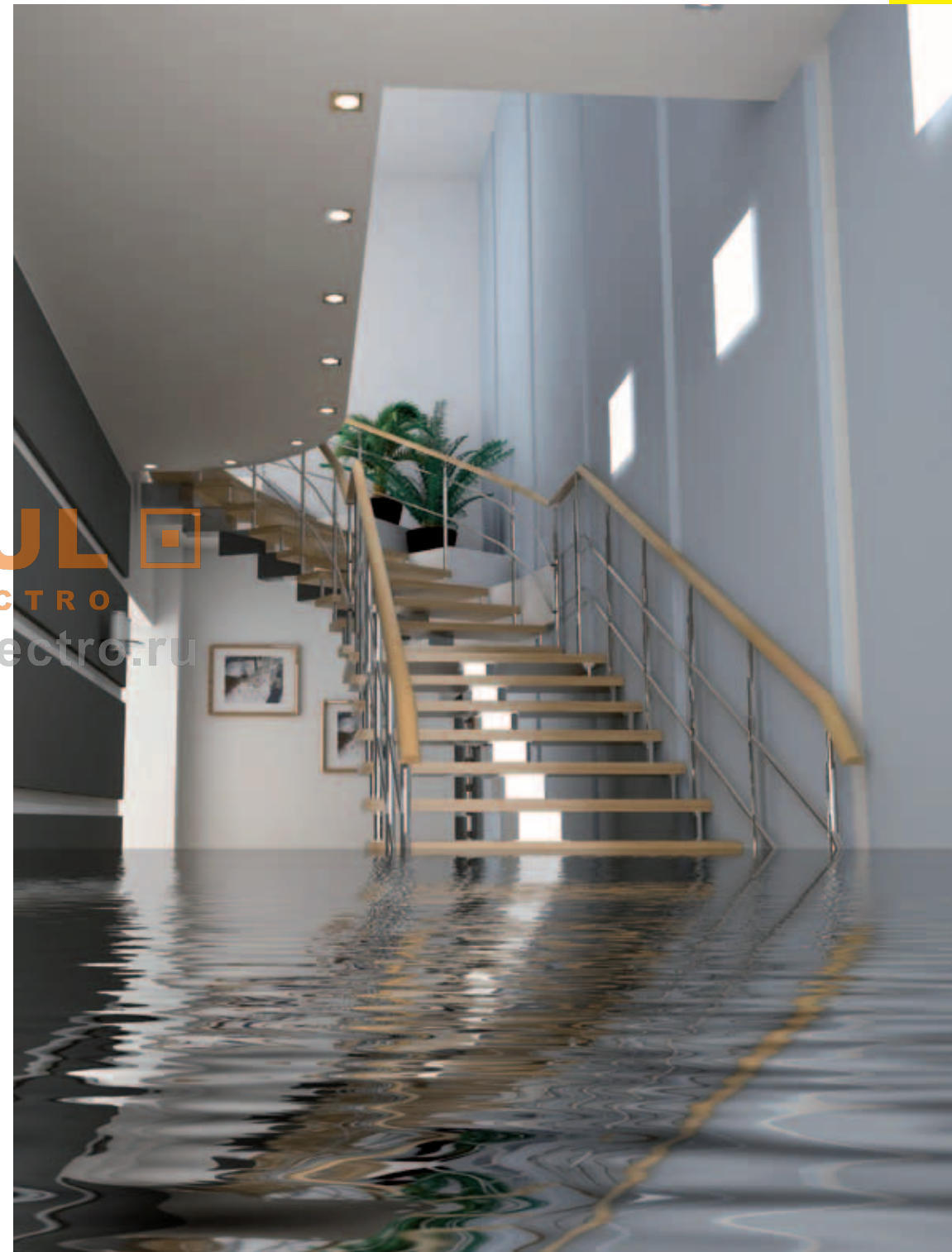

Spots mit erhöhter Schutzart | with high degree of protection

Spots mit erhöhter Schutzart | with high degree of protection

2274...



Spot mit erhöhter Schutzart / spot with high degree of protection

Artikel-Nr. article-no.	Preis € price €	Spritzwassergeschützt IP44 - bei Einbau in geschlossenen Decken splash proofed IP44 - for installation in closed ceilings		
2274.22	18,00			

NEU new

Nur für den Innenbereich / only for indoor

 

Material material	Bestückung lamp	Leistung power	Schutzart degree of protection	Schutzklasse protection class
Edelstahl-Glas sat. stainless steel-glass sat.	1x G4 QT9	max. 20W	IP44	III

1055/1355



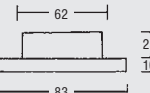

Spot mit erhöhter Schutzart / spot with high degree of protection

Artikel-Nr. article-no.	Preis € price €	Strahlwassergeschützt IP65 - bei Einbau in geschlossenen Decken hose proofed IP65 - for installation in closed ceilings		
1055.02	99,50			
1055.07	97,80			
1055.22	122,50			
1355.00	114,60			
1355.02	113,50			
1355.07	112,50			
1355.22	138,50			

1055_Schraubenmontage / screw mounting
1355_Federmontage DA 60mm / IP44
clip mounting ceiling cut-out 60mm / IP44

Material material	Bestückung lamp	Leistung power	Schutzart degree of protection	Schutzklasse protection class
Edelstahl-Glas sat. stainless steel-glass sat.	1x G4 QT9	max. 20W	IP65	III

2674...



Spot mit erhöhter Schutzart / spot with high degree of protection

Artikel-Nr. article-no.	Preis € price €	Spritzwassergeschützt IP44 - bei Einbau in geschlossenen Decken splash proofed IP44 - for installation in closed ceilings		
2674.22	18,00			

NEU new

Nur für den Innenbereich / only for indoor

 

Material material	Bestückung lamp	Leistung power	Schutzart degree of protection	Schutzklasse protection class
Edelstahl-Glas sat. stainless steel-glass sat.	1x G4 QT9	max. 20W	IP44	III

0126...



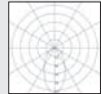
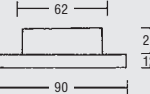

Spot mit erhöhter Schutzart / spot with high degree of protection

Artikel-Nr. article-no.	Preis € price €	Strahlwassergeschützt IP65 - bei Einbau in geschlossenen Decken hose proofed IP65 - for installation in closed ceilings		
0126.07	131,00			

Material material	Bestückung lamp	Leistung power	Schutzart degree of protection	Schutzklasse protection class
Aluminiumguss-Glas sat. aluminium cast-glass sat.	1x G4 QT9	max. 20W	IP65	III

Schraubenmontage
screw mounting

2193...



Spot mit erhöhter Schutzart / spot with high degree of protection

Artikel-Nr. article-no.	Preis € price €	Spritzwassergeschützt IP44 - bei Einbau in geschlossenen Decken splash proofed IP44 - for installation in closed ceilings		
2193.25	39,80			

Material material	Bestückung lamp	Leistung power	Schutzart degree of protection	Schutzklasse protection class
Aluminiumguss-Glas sat. aluminium cast-glass sat.	1x GZ4 QRCBC35	max. 35W	IP44	III



2264...

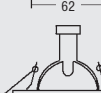
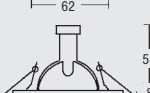

Spot mit erhöhter Schutzart / spot with high degree of protection

Artikel-Nr. article-no.	Preis € price €	Strahlwassergeschützt IP65 - bei Einbau in geschlossenen Decken hose proofed IP65 - for installation in closed ceilings		
2264.22	23,50			

Material material	Bestückung lamp	Leistung power	Schutzart degree of protection	Schutzklasse protection class
Edelstahl-Glas sat. stainless steel-glass sat.	1x GX5,3 QRCBC51	max. 50W	IP65	III

2194...



Spot mit erhöhter Schutzart / spot with high degree of protection

Artikel-Nr. article-no.	Preis € price €	Spritzwassergeschützt IP44 - bei Einbau in geschlossenen Decken splash proofed IP44 - for installation in closed ceilings		
2194.25	41,10			

Material material	Bestückung lamp	Leistung power	Schutzart degree of protection	Schutzklasse protection class
Aluminiumguss-Glas sat. aluminium cast-glass sat.	1x GZ4 QRCBC35	max. 35W	IP44	III



MODULO
ELECTRO

www.modulelectro.ru

Spots mit erhöhter Schutzart | with high degree of protection



Spots mit erhöhter Schutzart | with high degree of protection

Spot mit erhöhter Schutzart / spot with high degree of protection

Artikel-Nr. article-no.	Preis € price €
2162.25	38,40

Spritzwassergeschützt
IP44 - bei Einbau in
geschlossenen Decken
splash proofed
IP44 - for installation in
closed ceilings

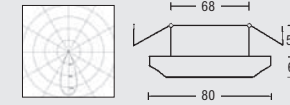

2162...

Material material	Bestückung lamp	Leistung power	Schutzart degree of protection	Schutzklasse protection class
Aluminiumguss-Glas klar alu cast-glass clear	1x GX5,3 QRCBC51	max. 35W	IP44	III



Spot mit erhöhter Schutzart / spot with high degree of protection

Artikel-Nr. article-no.	Preis € price €
2178.02	45,80
2178.05	45,80
2178.25	36,00

Spritzwassergeschützt
IP44 - bei Einbau in
geschlossenen Decken
splash proofed
IP44 - for installation in
closed ceilings

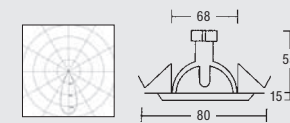

2178...

Material material	Bestückung lamp	Leistung power	Schutzart degree of protection	Schutzklasse protection class
Aluminiumguss-Glas klar aluminium cast-glass clear	1x GX5,3 QRCBC51	max. 35W	IP44	III



MODULO
ELECTRO
www.modulelectro.ru

Spot mit erhöhter Schutzart / spot with high degree of protection

Artikel-Nr. article-no.	Preis € price €
2339.42	46,00

Clip

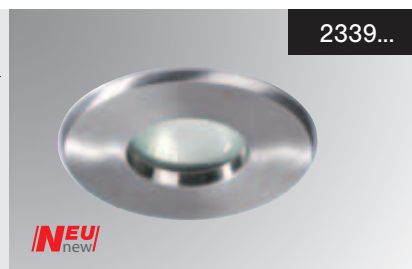
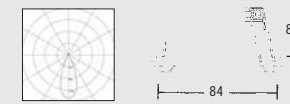

2339...

Material material	Bestückung lamp	Leistung power	Schutzart degree of protection	Schutzklasse protection class
V4A Edelstahl-Glas sat. V4A stainless steel-glass	1x GX5,3 QRCBC51	max. 50W	IP65	III



Spot mit erhöhter Schutzart / spot with high degree of protection

Artikel-Nr. article-no.	Preis € price €
2671.02	42,90

Spritzwassergeschützt
IP44 - bei Einbau in
geschlossenen Decken
splash proofed
IP44 - for installation in
closed ceilings

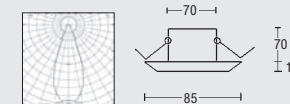

2671...

Material material	Bestückung lamp	Leistung power	Schutzart degree of protection	Schutzklasse protection class
Aluminiumguss-Glas sat. aluminium cast-glass sat.	1x GX5,3 QRCBC51	max. 50W	IP44	III



Spots mit erhöhter Schutzart | with high degree of protection

Spots mit erhöhter Schutzart | with high degree of protection

2673...



Spot mit erhöhter Schutzart / spot with high degree of protection

Artikel-Nr. article-no.	Preis € price €
2673.02	66,70

Spritzwassergeschützt
IP44 - bei Einbau in
geschlossenen Decken
splash proofed
IP44 - for installation in
closed ceilings

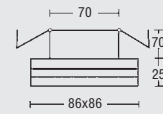
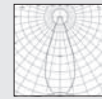

Material material	Bestückung lamp	Leistung power	Schutzart degree of protection	Schutzklasse protection class
Aluminiumguss-Glas sat. aluminium cast-glass sat.	1x GX5,3 QRCBC51	max. 50W	IP44	III



2281...



Spot mit erhöhter Schutzart / spot with high degree of protection

Artikel-Nr. article-no.	Preis € price €
2281.02	68,00

Strahlwassergeschützt
IP65 - bei Einbau in
geschlossenen Decken
hose proofed
IP65 - for installation in
closed ceilings

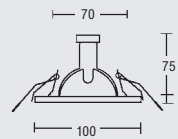
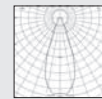

Material material	Bestückung lamp	Leistung power	Schutzart degree of protection	Schutzklasse protection class
Stahl-Grün Glas steel-green glass	1x GX5,3 QRCBC51	max. 50W	IP65	III



2282...



Spot mit erhöhter Schutzart / spot with high degree of protection

Artikel-Nr. article-no.	Preis € price €
2282.02	68,00

Strahlwassergeschützt
IP65 - bei Einbau in
geschlossenen Decken
hose proofed
IP65 - for installation in
closed ceilings

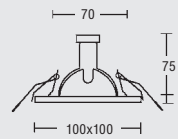
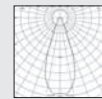

Material material	Bestückung lamp	Leistung power	Schutzart degree of protection	Schutzklasse protection class
Stahl-Grün Glas steel-green glass	1x GX5,3 QRCBC51	max. 50W	IP65	III



2293...



Spot mit erhöhter Schutzart / spot with high degree of protection

Artikel-Nr. article-no.	Preis € price €
2293.02	89,40

Strahlwassergeschützt
IP65 - bei Einbau in
geschlossenen Decken
hose proofed
IP65 - for installation in
closed ceilings

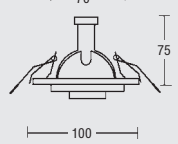
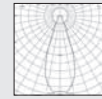

Material material	Bestückung lamp	Leistung power	Schutzart degree of protection	Schutzklasse protection class
Stahl-Glas klar steel-glass clear	1x GX5,3 QRCBC51	max. 50W	IP65	III



2294...

Spot mit erhöhter Schutzart / spot with high degree of protection

Artikel-Nr. article-no.	Preis € price €
2294.02	89,40

Strahlwassergeschützt
IP65 - bei Einbau in
geschlossenen Decken
hose proofed
IP65 - for installation in
closed ceilings

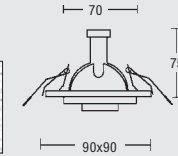
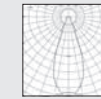

Material material	Bestückung lamp	Leistung power	Schutzart degree of protection	Schutzklasse protection class
Stahl-Glas klar steel-glass clear	1x GX5,3 QRCBC51	max. 50W	IP65	III



Spot mit erhöhter Schutzart / spot with high degree of protection

Artikel-Nr. article-no.	Preis € price €
2062.02	23,50
2062.07	21,10
2062.25	22,50

Strahlwassergeschützt
IP65 - bei Einbau in
geschlossenen Decken
hose proofed
IP65 - for installation in
closed ceilings

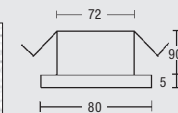
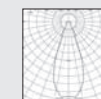

Material material	Bestückung lamp	Leistung power	Schutzart degree of protection	Schutzklasse protection class
Guss-Glas satiniert cast-glass satined	1x GX5,3 QRCBC51	max. 50W	IP65	III



MODULO
ELECTRO
www.modulelectro.ru

2286...

Spot mit erhöhter Schutzart / spot with high degree of protection

Artikel-Nr. article-no.	Preis € price €
2286.25	70,70

Spritzwassergeschützt
IP44 - bei Einbau in
geschlossenen Decken
splash proofed
IP44 - for installation in
closed ceilings

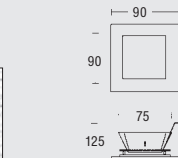
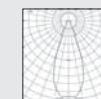

Material material	Bestückung lamp	Leistung power	Schutzart degree of protection	Schutzklasse protection class
Aluminium-Glas satiniert aluminium-glass satined	1x GU10 QPAR16	max. 50W	IP44	II

inkl. Bügel
incl. shackle



2262...

Spot mit erhöhter Schutzart / spot with high degree of protection

Artikel-Nr. article-no.	Preis € price €
2262.02	35,00
2262.07	32,00
2262.15	37,00

Nur Aluminium Reflektor-
lampen einsetzen!
Only use aluminium
reflector lamps!

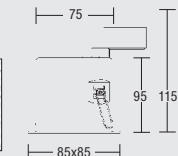
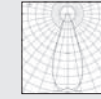

Material material	Bestückung lamp	Leistung power	Schutzart degree of protection	Schutzklasse protection class
Aluminiumguss / Stahl aluminium cast / steel	1x GX5,3 QRCBC51	max. 35W	IP65	III

inkl. Bügel
incl. shackle



UK Patent GB2426321. Integriertes intumeszentes (dämmschichtbildendes) Material dichtet das Downlight und den Deckenausschnitt im Fall eines Feuers ab. Getestet für BS EN ISO 140-3: 1995 & BS EN ISO 140-6: 1998 (Akustik). Diese bestätigen, dass der Schallschutz für ein internes oder separates Stockwerk gewährleistet wird.
UK Patent GB2426321. Integrated intumescent material completely seals the downlight and cut-out in case of fire. Tested to BS EN ISO 140-3: 1995 & BS EN ISO 140-6: 1998 (Acoustics). They are confirming that they maintain the ability for an internal or separating floor to provide sound insulation.

NEU
NEW



Spots mit erhöhter Schutzart | with high degree of protection

Spots mit erhöhter Schutzart | with high degree of protection

2160...



Spot mit erhöhter Schutzart / spot with high degree of protection

Artikel-Nr. article-no.	Preis € price €	Spritzwassergeschützt IP44 - bei Einbau in geschlossenen Decken splash proofed IP44 - for installation in closed ceilings
2160.02	50,80	
2160.25	40,90	



Material material Bestückung lamp Leistung power Schutzart degree of protection Schutzklasse protection class

Aluminiumguss-Glas sat. aluminium cast-glass sat.	1x GX5,3 QRCBC51	max. 35W	IP44	III
--	------------------	----------	------	-----



2289...



Spot mit erhöhter Schutzart / spot with high degree of protection

Artikel-Nr. article-no.	Preis € price €	Strahlwassergeschützt IP65 - bei Einbau in geschlossenen Decken hose proofed IP65 - for installation in closed ceilings
2289.02	27,90	
2289.15	27,90	

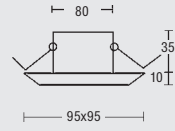

Material material Bestückung lamp Leistung power Schutzart degree of protection Schutzklasse protection class

Guss-Glas satiniert cast-glass satin	1x GY6,35 QT12	max. 35W	IP65	III
---	----------------	----------	------	-----



2180...



Spot mit erhöhter Schutzart / spot with high degree of protection

Artikel-Nr. article-no.	Preis € price €	Spritzwassergeschützt IP44 - bei Einbau in geschlossenen Decken splash proofed IP44 - for installation in closed ceilings
2180.25	47,70	



Material material Bestückung lamp Leistung power Schutzart degree of protection Schutzklasse protection class

Aluminium-Glas satiniert aluminium-glass satined	1x GX5,3 QRCBC51	max. 35W	IP44	III
---	------------------	----------	------	-----



2298...



Spot mit erhöhter Schutzart / spot with high degree of protection

Artikel-Nr. article-no.	Preis € price €	Spritzwassergeschützt IP44 - bei Einbau in geschlossenen Decken splash proofed IP44 - for installation in closed ceilings
2298.25	98,30	



Material material Bestückung lamp Leistung power Schutzart degree of protection Schutzklasse protection class

Aluminium-Glas klar aluminium-glass clear	1x GU10 QPAR51	max. 50W	IP44	II
--	----------------	----------	------	----

inkl. Bügel
incl. shackle



2188...



Spot mit erhöhter Schutzart / spot with high degree of protection

Artikel-Nr. article-no.	Preis € price €	Spritzwassergeschützt IP44 - bei Einbau in geschlossenen Decken splash proofed IP44 - for installation in closed ceilings
2188.25	47,70	



Material material Bestückung lamp Leistung power Schutzart degree of protection Schutzklasse protection class

Aluminium-Glas klar aluminium-glass clear	1x GX5,3 QRCBC51	max. 35W	IP44	III
--	------------------	----------	------	-----



2299...



Spot mit erhöhter Schutzart / spot with high degree of protection

Artikel-Nr. article-no.	Preis € price €	Spritzwassergeschützt IP44 - bei Einbau in geschlossenen Decken splash proofed IP44 - for installation in closed ceilings
2299.25	96,10	

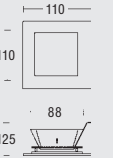

Material material Bestückung lamp Leistung power Schutzart degree of protection Schutzklasse protection class

Aluminium-Glas klar aluminium-glass clear	1x GU10 QPAR51	max. 50W	IP44	II
--	----------------	----------	------	----

inkl. Bügel
incl. shackle



1038...

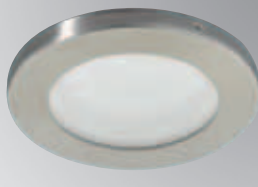

Spot mit erhöhter Schutzart / spot with high degree of protection

Artikel-Nr. article-no.	Preis € price €	Strahlwassergeschützt IP65 - bei Einbau in geschlossenen Decken hose proofed IP65 - for installation in closed ceilings
1038.22	148,50	



Material material Bestückung lamp Leistung power Schutzart degree of protection Schutzklasse protection class

Edelstahl-Glas satiniert stainless steel-glass sat.	1x G4 QT9	max. 20W	IP65	III
--	-----------	----------	------	-----

Schraubenmontage
screw mounting



1065...

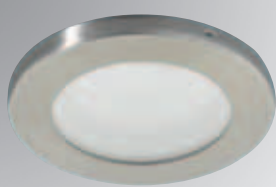

Spot mit erhöhter Schutzart / spot with high degree of protection

Artikel-Nr. article-no.	Preis € price €	Spritzwassergeschützt IP44 - bei Einbau in geschlossenen Decken splash proofed IP44 - for installation in closed ceilings
1065.22	154,00	



Material material Bestückung lamp Leistung power Schutzart degree of protection Schutzklasse protection class

Edelstahl-Glas satiniert stainless steel-glass sat.	2x G4 QT9	max. 20W	IP44	III
--	-----------	----------	------	-----

Schraubenmontage
screw mounting



MODULO
ELECTRO

www.modulelectro.ru



MODUL
ELECTRO
www.modulelectro.ru

Vorteil:

- Geringe Einbautiefe
- Kleine Bauform

Anwendung:

- Küchen, Schränke, Vitrinen, Regalböden, usw.

Advantage:

- Low installation depth
- Small type of construction

Application:

- Kitchens, cupboards, showcases, shelves, etc.



Schlosshotel Elmau, Elmau

Spots mit geringer Einbautiefe / Möbeleinbauspots

spots with low installation depth / recessed spots for furnitures

2269...



Vitrinenleuchte für Niederdrucklampen / light for showcase for low-pressure lamps

Artikel-Nr. article-no.	Preis € price €
2269.15	14,10

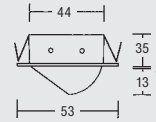

Material material	Bestückung lamp	Leistung power	Schutzart degree of protection	Schutzklasse protection class
Guss / cast	1x G4 QT9	max. 20W	IP20	III



2007...



Möbeleinbauleuchte für Niederdrucklampen / recessed furniture light for low-pressure lamps

Artikel-Nr. article-no.	Preis € price €
2007.02	10,70
2007.03	11,50
2007.05	10,70
2007.07	9,60

Bei Dauerbetrieb
max. 10W
permanent operation
max. 10W

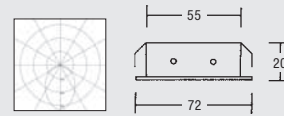

Material material	Bestückung lamp	Leistung power	Schutzart degree of protection	Schutzklasse protection class
Eisen-Glas satiniert iron-glass satined	1x G4 QT9	max. 20W	IP20	III



2358...



Möbeleinbauleuchte für Niederdrucklampen / recessed furniture light for low-pressure lamps

Artikel-Nr. article-no.	Preis € price €
2358.00	8,40
2358.02	8,10
2358.07	6,40
2358.15	8,40

Lieferung inkl.
AMP-Stecker
AMP-Zubehör siehe
Seite 470
delivery incl. AMP-plug
AMP-accessories see
page 470

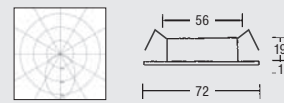

Material material	Bestückung lamp	Leistung power	Schutzart degree of protection	Schutzklasse protection class
Eisen-Glas satiniert iron-glass satined	1x G4 QT9	max. 20W	IP20	III



2461...



Möbeleinbauleuchte für Niederdrucklampen / recessed furniture light for low-pressure lamps

Artikel-Nr. article-no.	Preis € price €
2461.02	13,90
2461.05	14,00
2461.07	13,50
2461.26	13,60

Lieferung inkl.
AMP-Stecker
AMP-Zubehör siehe
Seite 470
delivery incl. AMP-plug
AMP-accessories see
page 470

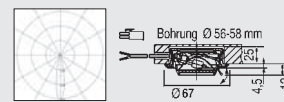

Feuchtraumgeeignet
for humid areas

Material material	Bestückung lamp	Leistung power	Schutzart degree of protection	Schutzklasse protection class
Thermoplast-Glas klar thermoplastic-glass clear	1x G4 QT9	max. 20W	IP20	III



Möbeleinbauleuchte für Niederdrucklampen / recessed furniture light for low-pressure lamps

Artikel-Nr. article-no.	Preis € price €
2462.02	18,30
2462.26	17,80

Lieferung inkl.
AMP-Stecker
AMP-Zubehör siehe
Seite 470
delivery incl. AMP-plug
AMP-accessories see
page 470

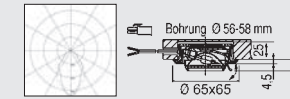

Feuchtraumgeeignet
for humid areas

Material material	Bestückung lamp	Leistung power	Schutzart degree of protection	Schutzklasse protection class
Thermoplast-Glas klar thermoplastic-glass clear	1x G4 QT9	max. 20W	IP20	III

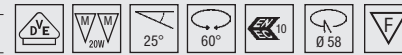

2462...



Möbeleinbauleuchte für Niederdrucklampen / recessed furniture light for low-pressure lamps

Artikel-Nr. article-no.	Preis € price €
2455.02	11,30
2455.05	11,60
2455.26	11,10

Lieferung inkl.
AMP-Stecker
AMP-Zubehör siehe
Seite 470
delivery incl. AMP-plug
AMP-accessories see
page 470

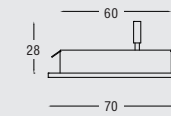

Feuchtraumgeeignet / for humid areas
Zuleitung 2.000mm / supply line 2.000mm

Material material	Bestückung lamp	Leistung power	Schutzart degree of protection	Schutzklasse protection class
Thermoplast-Glas klar thermoplastic-glass clear	1x G4 QT9	max. 20W	IP20	III



2455...



MODUL
ELECTRO
www.modulelectro.ru



Privathaus, Sylt

Spots mit geringer Einbautiefe / Möbeleinbauspots

spots with low installation depth / recessed spots for furnitures

2073...



Möbeleinbauleuchte für Niederdrucklampen / recessed furniture light for low-pressure lamps

Artikel-Nr. article-no.	Preis € price €
2073.02	23,60
2073.03	26,80
2073.05	24,80
2073.07	22,30

Lieferung inkl.
AMP-Stecker
AMP-Zubehör siehe
Seite 470
delivery incl. AMP-plug
AMP-accessories see
page 470

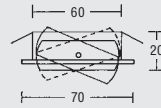

Bei Dauerbetrieb max. 10W / permanent operation max. 10W

Material material	Bestückung lamp	Leistung power	Schutzart degree of protection	Schutzklasse protection class
Thermoplast-Eisen-Glas thermoplastic-iron-glass	1x G4 QT9	max. 20W	IP20	III



2070...



Möbeleinbauleuchte für Niederdrucklampen / recessed furniture light for low-pressure lamps

Artikel-Nr. article-no.	Preis € price €
2070.02	15,80
2070.03	18,00
2070.05	16,50
2070.07	14,60

Lieferung inkl.
AMP-Stecker
AMP-Zubehör siehe
Seite 470
delivery incl. AMP-plug
AMP-accessories see
page 470

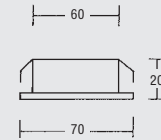

Bei Dauerbetrieb max. 10W / permanent operation max. 10W

Material material	Bestückung lamp	Leistung power	Schutzart degree of protection	Schutzklasse protection class
Thermoplast-Eisen-Glas thermoplastic-iron-glass	1x G4 QT9	max. 20W	IP20	III



5370...



Aufputzring für Möbeleinbaustrahler Art.-Nr. 2070 / 2073 ring for surface mounting for furniture lights art.-no. 2070 / 2073

Artikel-Nr. article-no.	Preis € price €
5370.02	14,10
5370.03	15,90
5370.05	14,60
5370.07	10,90

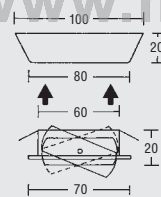

Material material	Bestückung lamp	Leistung power	Schutzart degree of protection	Schutzklasse protection class
Eisen / iron	-	-	-	-

2359...



Möbeleinbauleuchte für Niederdrucklampen / recessed furniture light for low-pressure lamps

Artikel-Nr. article-no.	Preis € price €
2359.00	10,30
2359.02	9,90
2359.07	8,40
2359.15	10,30

Lieferung inkl.
AMP-Stecker
AMP-Zubehör siehe
Seite 470
delivery incl. AMP-plug
AMP-accessories see
page 470

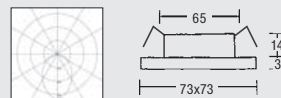

Abdeckung über Magnetverschluss
cover by magnetic lock

Material material	Bestückung lamp	Leistung power	Schutzart degree of protection	Schutzklasse protection class
Eisen-Glas satiniert iron-glass satined	1x G4 QT9	max. 20W	IP20	III



Möbeleinbauleuchte für Niederdrucklampen / recessed furniture light for low-pressure lamps

Artikel-Nr. article-no.	Preis € price €
2037.00	31,20
2037.02	29,90
2037.03	31,90
2037.07	27,40
2037.22	43,10

Lieferung inkl.
AMP-Stecker
AMP-Zubehör siehe
Seite 470
delivery incl. AMP-plug
AMP-accessories
see page 470

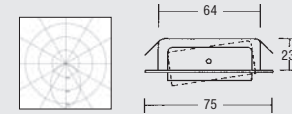

22 = Material Rein Edelstahl
22 = material pure stainless steel

Material material	Bestückung lamp	Leistung power	Schutzart degree of protection	Schutzklasse protection class
Eisen-Glas klar iron-glass clear	1x G4 QT9	max. 20W	IP20	III



2037...



Aufputzring für Möbeleinbaustrahler Art.-Nr. 2037.22 ring for surface mounting for furniture lights art.-no. 2037.22

Artikel-Nr. article-no.	Preis € price €
5372.22	41,20

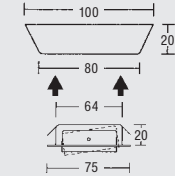

Material material	Bestückung lamp	Leistung power	Schutzart degree of protection	Schutzklasse protection class
Edelstahl / stainless steel	-	-	-	-

5372...



MODULO ELECTRO
www.modulelectro.ru

2450...

Möbeleinbauleuchte für Niederdrucklampen / recessed furniture light for low-pressure lamps

Artikel-Nr. article-no.	Preis € price €
2450.02	34,20
2450.07	33,60
2450.26	33,90

Lieferung inkl.
AMP-Stecker
AMP-Zubehör siehe Seite
470
delivery incl. AMP-plug
AMP-accessories
see page 470

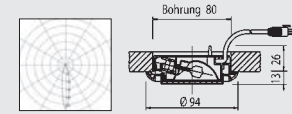

Niedervolt / low voltage

Material material	Bestückung lamp	Leistung power	Schutzart degree of protection	Schutzklasse protection class
Thermoplast thermoplastic	1x GY6,35 QT12	max. 50W	IP20	III



2452...

Möbeleinbauleuchte für Niederdrucklampen / recessed furniture light for low-pressure lamps

Artikel-Nr. article-no.	Preis € price €
2452.02	45,60
2452.05	46,00
2452.07	44,90
2452.26	45,40

Lieferung inkl. Hochvolt-
Durchgangsverdrahtung
weiteres Zubehör siehe
Seite 471
delivery incl. high voltage
through-wiring
more accessories
see page 471

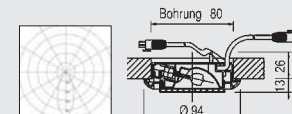

Hochvolt / high voltage

Material material	Bestückung lamp	Leistung power	Schutzart degree of protection	Schutzklasse protection class
Thermoplast thermoplastic	1x G9 QT14	max. 40W	IP20	II



Spots mit geringer Einbautiefe / Möbeleinbauspots

spots with low installation depth / recessed spots for furnitures

2453...



Möbeleinbauleuchte für Niederdrucklampen / recessed furniture light for low-pressure lamps

Artikel-Nr. article-no.	Preis € price €
2453.02	48,70
2453.07	47,80
2453.26	48,30

Lieferung inkl. Hochvolt-Durchgangsverdrahtung
weiteres Zubehör siehe Seite 471
delivery incl. high voltage through-wiring
more accessories see page 471

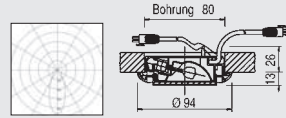

Feuchtraumgeeignet / for humid areas
Hochvolt / high voltage

Material material	Bestückung lamp	Leistung power	Schutzart degree of protection	Schutzklasse protection class
Thermoplast-Glas klar thermoplastic-glass clear	1x G9 QT14	max. 25W	IP20	II



2456...



Möbeleinbauleuchte für Niederdrucklampen / recessed furniture light for low-pressure lamps

Artikel-Nr. article-no.	Preis € price €
2456.02	39,30
2456.07	38,80
2456.26	38,80

Lieferung inkl. AMP-Stecker
AMP-Zubehör siehe Seite 470
delivery incl. AMP-plug
AMP-accessories see page 470

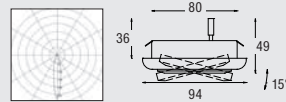

Feuchtraumgeeignet / for humid areas
Niedervolt / low voltage

Material material	Bestückung lamp	Leistung power	Schutzart degree of protection	Schutzklasse protection class
Thermoplast-Glas klar thermoplastic-glass clear	1x GY6,35 QT12	max. 35W	IP20	III



2457...



Möbeleinbauleuchte für Niederdrucklampen / recessed furniture light for low-pressure lamps

Artikel-Nr. article-no.	Preis € price €
2457.02	47,10
2457.05	47,60
2457.07	46,40
2457.26	46,40

Lieferung inkl. Hochvolt-Durchgangsverdrahtung
weiteres Zubehör siehe Seite 471
delivery incl. high voltage through-wiring
more accessories see page 471

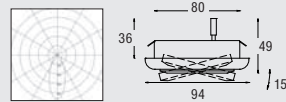

Hochvolt / high voltage

Material material	Bestückung lamp	Leistung power	Schutzart degree of protection	Schutzklasse protection class
Thermoplast thermoplastic	1x G9 QT14	max. 40W	IP20	II



2440...



Möbeleinbauleuchte für Niederdrucklampen / recessed furniture light for low-pressure lamps

Artikel-Nr. article-no.	Preis € price €
2440.07	41,50
2440.26	41,80

Lieferung inkl. AMP-Stecker
AMP-Zubehör siehe Seite 470
delivery incl. AMP-plug
AMP-accessories see page 470

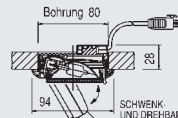

Niedervolt / low voltage

Material material	Bestückung lamp	Leistung power	Schutzart degree of protection	Schutzklasse protection class
Thermoplast thermoplastic	1x GY6,35 QT12	max. 50W	IP20	III



2442...

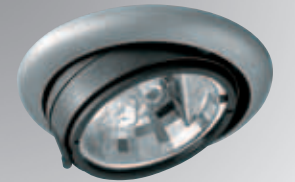

Möbeleinbauleuchte für Niederdrucklampen / recessed furniture light for low-pressure lamps

Artikel-Nr. article-no.	Preis € price €
2442.02	53,00
2442.07	52,50
2442.26	52,70

Lieferung inkl. Hochvolt-Durchgangsverdrahtung
weiteres Zubehör siehe Seite 471
delivery incl. high voltage through-wiring
more accessories see page 471

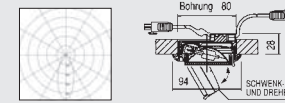

Hochvolt / high voltage



Material material	Bestückung lamp	Leistung power	Schutzart degree of protection	Schutzklasse protection class
Thermoplast thermoplastic	1x G4 QT9	max. 40W	IP20	II



2430...



Möbeleinbauleuchte für Niederdrucklampen / recessed furniture light for low-pressure lamps

Artikel-Nr. article-no.	Preis € price €
2430.26	37,60

Lieferung inkl. AMP-Stecker
AMP-Zubehör siehe Seite 470
delivery incl. AMP-plug
AMP-accessories see page 470

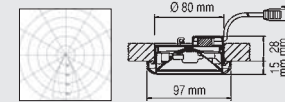

Niedervolt / low voltage

Material material	Bestückung lamp	Leistung power	Schutzart degree of protection	Schutzklasse protection class
Thermoplast thermoplastic	1x GY6,35 QT12	max. 50W	IP20	II



2432...



Möbeleinbauleuchte für Niederdrucklampen / recessed furniture light for low-pressure lamps

Artikel-Nr. article-no.	Preis € price €
2432.02	53,40
2432.26	53,10

Lieferung inkl. Hochvolt-Durchgangsverdrahtung
weiteres Zubehör siehe Seite 471
delivery incl. high voltage through-wiring
more accessories see page 471

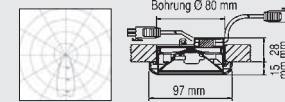

Hochvolt / high voltage

Material material	Bestückung lamp	Leistung power	Schutzart degree of protection	Schutzklasse protection class
Thermoplast thermoplastic	1x G9 QT14	max. 40W	IP20	II





MODUL
ELECTRO
www.modulelectro.ru

Vorteil:

- Kein Deckenhohlraum notwendig

Anwendung:

- Innenräume ohne Zwischendecke

Advantage:

- No cavity required

Application:

- Interiors without intermediate ceiling



Deckenaufbau | surface mounted lights

Deckenaufbau | surface mounted lights

500162



HV-Deckenaufbauleuchte / high-voltage surface mounted light

Artikel-Nr. article-no.	Preis € price €
500162	113,10

**Hochvolt
high-voltage**

Farbe: alu matt
colour: alu satin

Material material	Bestückung lamp	Leistung power	Schutzart degree of protection	Schutzklasse protection class
Massiv Aluminium massive aluminium	1x GU10 QPAR51	max. 50W	IP20	I



2356...



HV-Deckenaufbauleuchte / high-voltage surface mounted light

Artikel-Nr. article-no.	Preis € price €
2356.07	34,70
2356.15	40,40

Bestückung nur mit aluminiumbeschichteten Reflektorlampen.
Lamp only with aluminium coated reflector illuminant.

**Hochvolt
high-voltage**

Material material	Bestückung lamp	Leistung power	Schutzart degree of protection	Schutzklasse protection class
Eisen / iron	1x GU10 QPAR51	max. 50W	IP20	II



2370...



HV-Deckenaufbauleuchte / high-voltage surface mounted light

Artikel-Nr. article-no.	Preis € price €
2370.25	77,70

**Hochvolt
high-voltage**

Material material	Bestückung lamp	Leistung power	Schutzart degree of protection	Schutzklasse protection class
Aluminium / aluminium	1x GU10 QPAR51	max. 50W	IP20	I



2075...



HV-Deckenaufbauleuchte / high-voltage surface mounted light

Artikel-Nr. article-no.	Preis € price €
2075.02	125,10
2075.03	134,60

Aufbauleuchte ohne Trafo. Bestückung nur mit aluminiumbeschichteten Reflektorlampen.
Surface mounted light. Without transformer. Lamp only with aluminium coated reflector illuminant.

Hochvolt / high-voltage

Material material	Bestückung lamp	Leistung power	Schutzart degree of protection	Schutzklasse protection class
Messing / brass	1x GX5,3 QRCBC51	max. 50W	IP20	III



2371...



HV-Deckenaufbauleuchte / high-voltage surface mounted light

Artikel-Nr. article-no.	Preis € price €
2371.25	87,90

**Hochvolt
high-voltage**

Material material	Bestückung lamp	Leistung power	Schutzart degree of protection	Schutzklasse protection class
Aluminium-Grünglas aluminium-green glass	1x GU10 QPAR51	max. 50W	IP20	I



2355...



HV-Deckenaufbauleuchte / high-voltage surface mounted light

Artikel-Nr. article-no.	Preis € price €
2355.02	25,60
2355.05	26,80
2355.07	22,90
2355.15	26,90

Bestückung nur mit aluminiumbeschichteten Reflektorlampen.
Lamp only with aluminium coated reflector illuminant.

**Hochvolt
high-voltage**

Material material	Bestückung lamp	Leistung power	Schutzart degree of protection	Schutzklasse protection class
Eisen / iron	1x GU10 QPAR51	max. 50W	IP20	II



MODULO
ELECTRO
www.modulelectro.ru



1941...



HV-Deckenaufbauleuchte / high-voltage surface mounted light

Artikel-Nr. article-no.	Preis € price €
1941.15	42,80

Hochvolt
high-voltage

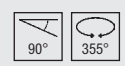
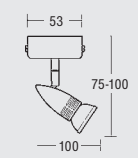

Material material	Bestückung lamp	Leistung power	Schutzart degree of protection	Schutzklasse protection class
Guss-Eisen / cast-iron	1x GU10 QPAR51	max. 50W	IP20	I

1943...



HV-Deckenaufbauleuchte / high-voltage surface mounted light

Artikel-Nr. article-no.	Preis € price €
1943.15	47,80

Hochvolt
high-voltage

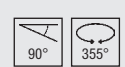
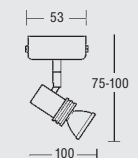

Material material	Bestückung lamp	Leistung power	Schutzart degree of protection	Schutzklasse protection class
Guss-Eisen / cast-iron	1x GU10 QPAR51	max. 50W	IP20	I

2375...



Deckenaufbauleuchte / surface mounted light

Artikel-Nr. article-no.	Preis € price €
2375.25	91,70

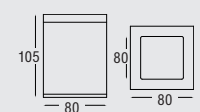

MEGAMAN[®]
Energiesparlampen
geeignet für Megaman-Energiesparlampe 7, 9, 11W
adapted for Megaman-energy-saving lamp 7, 9, 11W

Material material	Bestückung lamp	Leistung power	Schutzart degree of protection	Schutzklasse protection class
Aluminium-Glas aluminium-glass	1x GU10	max. 11W	IP44	I

2376...



Deckenaufbauleuchte / surface mounted light

Artikel-Nr. article-no.	Preis € price €
2376.25	91,70



MEGAMAN[®]
Energiesparlampen
geeignet für Megaman-Energiesparlampe 7, 9, 11W
adapted for Megaman-energy-saving lamp 7, 9, 11W

Material material	Bestückung lamp	Leistung power	Schutzart degree of protection	Schutzklasse protection class
Aluminium-Glas aluminium-glass	1x GU10	max. 11W	IP44	I

MODUL
ELECTRO
www.modulelectro.ru





Vorteil:

- ausgefallenes Design
- Material - Vielfalt

Anwendung:

- dekorative Akzentbeleuchtung

Advantage:

- Unusual design
- Material diversity

Application:

- Decorative accent light



MODUL
ELECTRO
www.modulelectro.ru

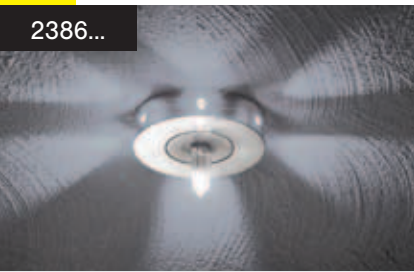

2386...

NV-Einbauleuchte mit Radial-LED-Kranz / recessed low-voltage spot with radial-LED-circuit

Artikel-Nr. Preis €
 article-no. price €
 2386.15B ● 39,00
 2386.15W ● 39,00

Lieferung inkl. LED-Konverter
 Mit zwei 230V-Anschlüssen
 ist eine getrennte Schaltung
 (NV/LED) möglich.
 delivery incl. LED-converter
 separate circuit possible by
 two 230V (low-voltage-LED)
 connection.

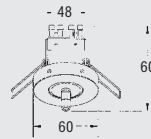

Material material	Bestückung lamp	Leistung power	Schutzart degree of protection	Schutzklasse protection class
Guss / cast	1x G4 QT9	max. 5W	IP20	III



0290...

NV-Einbauleuchte / recessed low-voltage spot

Artikel-Nr. Preis €
 article-no. price €
 0290.00 36,00

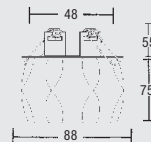

Material material	Bestückung lamp	Leistung power	Schutzart degree of protection	Schutzklasse protection class
Eisen-Kristallglas iron-crystal glass	1x G4 QT9	max. 20W	IP20	III



0289...

NV-Einbauleuchte / recessed low-voltage spot

Artikel-Nr. Preis €
 article-no. price €
 0289.00 24,00

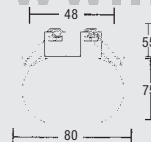

Material material	Bestückung lamp	Leistung power	Schutzart degree of protection	Schutzklasse protection class
Eisen-Glas iron-glass	1x G4 QT9	max. 20W	IP20	III

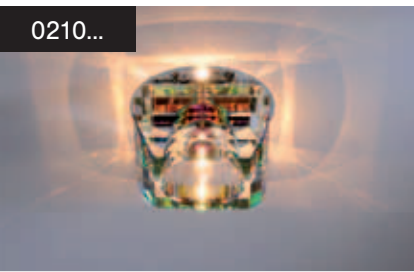

0210...

NV-Einbauleuchte / recessed low-voltage spot

Artikel-Nr. Preis €
 article-no. price €
 0210.02 29,00

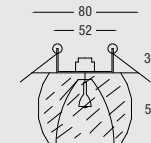

Material material	Bestückung lamp	Leistung power	Schutzart degree of protection	Schutzklasse protection class
Eisen-Kristallglas iron-crystal glass	1x G4 QT9	max. 20W	IP20	III



NV-Einbauleuchte / recessed low-voltage spot

Artikel-Nr. Preis €
 article-no. price €
 0284.00 36,00

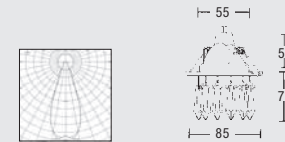

Material material	Bestückung lamp	Leistung power	Schutzart degree of protection	Schutzklasse protection class
Eisen-Kristallglas iron-crystal glass	1x GX5,3 QRCBC51	max. 35W	IP20	III

0284...

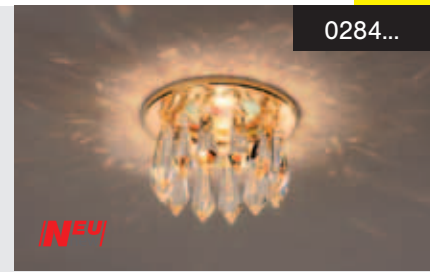

NV-Einbauleuchte / recessed low-voltage spot

Artikel-Nr. Preis €
 article-no. price €
 0285.00 48,00

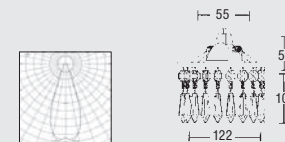

Material material	Bestückung lamp	Leistung power	Schutzart degree of protection	Schutzklasse protection class
Eisen-Kristallglas iron-crystal glass	1x GX5,3 QRCBC51	max. 35W	IP20	III

0285...

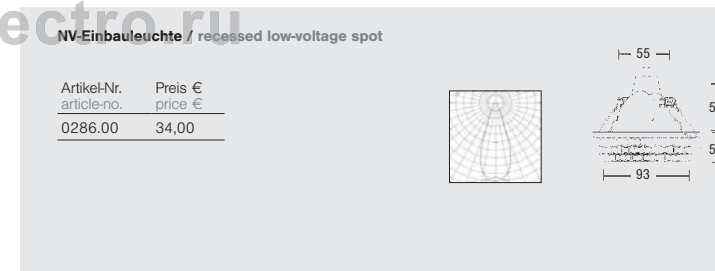

NV-Einbauleuchte / recessed low-voltage spot

Artikel-Nr. Preis €
 article-no. price €
 0286.00 34,00

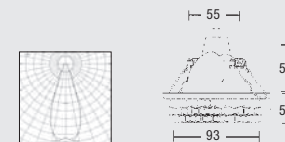

Material material	Bestückung lamp	Leistung power	Schutzart degree of protection	Schutzklasse protection class
Eisen-Kristallglas iron-crystal glass	1x GX5,3 QRCBC51	max. 35W	IP20	III

0286...



EAST Hotel, Hamburg

MODULO ELECTRO
 www.modulelectro.ru

2028...



NV-Deckeneinbauleuchte / recessed low-voltage ceiling spot

Artikel-Nr. article-no.	Preis € price €
2028.02	115,40
551700	19,80

Ersatzglas
replacement glass
Art.-Nr.: 551700

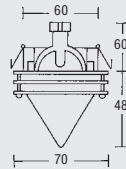

Material material	Bestückung lamp	Leistung power	Schutzart degree of protection	Schutzklasse protection class
Messing-Kristall brass-crystal	1x GX5,3 QRCBC51	max. 50W	IP20	III



2156...



NV-Deckeneinbauleuchte / recessed low-voltage ceiling spot

Artikel-Nr. article-no.	Preis € price €
2156.02	52,00
2156.15	60,80

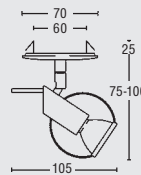
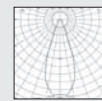

Material material	Bestückung lamp	Leistung power	Schutzart degree of protection	Schutzklasse protection class
Guss-Eisen / cast-iron	1x GX5,3 QRCBC51	max. 50W	IP20	III



1940...



HV-Deckeneinbauleuchte / recessed high-voltage ceiling spot

Artikel-Nr. article-no.	Preis € price €
1940.15	45,60

Hochvolt
high-voltage

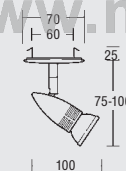

Material material	Bestückung lamp	Leistung power	Schutzart degree of protection	Schutzklasse protection class
Guss / cast	1x GU10 QPAR51	max. 50W	IP20	I



1942...



HV-Deckeneinbauleuchte / recessed high-voltage ceiling spot

Artikel-Nr. article-no.	Preis € price €
1942.15	51,00

Hochvolt
high-voltage

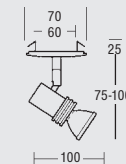

Material material	Bestückung lamp	Leistung power	Schutzart degree of protection	Schutzklasse protection class
Guss / cast	1x GU10 QPAR51	max. 50W	IP20	I



1989...

HV-Einbauleuchte mit Radial-LED-Kranz
recessed high-voltage spot with radial-led-circuit

Artikel-Nr. article-no.	Preis € price €
1989.25W	104,00
1989.25B	104,00

Lieferung inkl. LED-Konverter
Mit zwei 230V-Anschlüssen
ist eine getrennte Schaltung
(NV/LED) möglich.
delivery incl. LED-converter
separate circuit possible by
two 230V (low volt-LED)
connection.

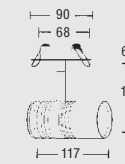

Material material	Bestückung lamp	Leistung power	Schutzart degree of protection	Schutzklasse protection class
Aluminium / aluminium	1x GU10 QPAR51	max. 35W	IP20	I



MODUL
ELECTRO

www.modulelectro.ru



NEU

1960...



NV-Deckeneinbauleuchte / recessed low-voltage ceiling spot

Artikel-Nr. article-no.	Preis € price €
1960.02	25,20
1960.15	25,60
574000	7,50

Ersatzglas
replacement glass
Art.-Nr.: 574000

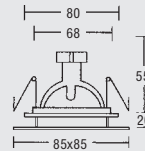

Material material	Bestückung lamp	Leistung power	Schutzart degree of protection	Schutzklasse protection class
Aluminiumguss-Glas aluminium cast-glass	1x GX5,3 QRCBC51	max. 50W	IP20	III



1920...



NV-Deckeneinbauleuchte / recessed low-voltage ceiling spot

Artikel-Nr. article-no.	Preis € price €
1920.02	45,70
1920.03	51,20
1920.07	44,10
576000	12,00

Ersatzglas
replacement glass
Art.-Nr.: 576000

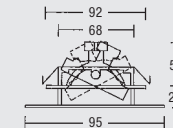

Material material	Bestückung lamp	Leistung power	Schutzart degree of protection	Schutzklasse protection class
Eisen-Glas / iron-glass	1x GX5,3 QRCBC51	max. 35W	IP20	III



1961...



NV-Deckeneinbauleuchte / recessed low-voltage ceiling spot

Artikel-Nr. article-no.	Preis € price €
1961.02	25,20
1961.15	25,60
574100	7,50

Ersatzglas
replacement glass
Art.-Nr.: 574100

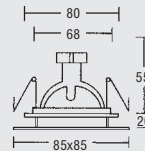

Material material	Bestückung lamp	Leistung power	Schutzart degree of protection	Schutzklasse protection class
Aluminiumguss-Glas aluminium cast-glass	1x GX5,3 QRCBC51	max. 50W	IP20	III



1921...



NV-Deckeneinbauleuchte / recessed low-voltage ceiling spot

Artikel-Nr. article-no.	Preis € price €
1921.02	46,90
1921.03	52,70
1921.07	45,70
576100	13,40

Ersatzglas
replacement glass
Art.-Nr.: 576100

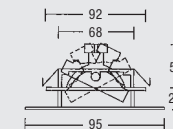

Material material	Bestückung lamp	Leistung power	Schutzart degree of protection	Schutzklasse protection class
Eisen-Glas / iron-glass	1x GX5,3 QRCBC51	max. 50W	IP20	III

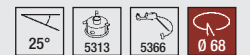

1965...



NV-Deckeneinbauleuchte / recessed low-voltage ceiling spot

Artikel-Nr. article-no.	Preis € price €
1965.02	25,20
1965.15	25,60
574500	7,50

Ersatzglas
replacement glass
Art.-Nr.: 574500

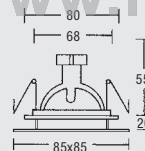

Material material	Bestückung lamp	Leistung power	Schutzart degree of protection	Schutzklasse protection class
Aluminiumguss-Glas aluminium cast-glass	1x GX5,3 QRCBC51	max. 50W	IP20	III



213100

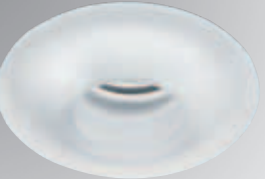

NV-Deckeneinbauleuchte / recessed low-voltage ceiling spot

Artikel-Nr. article-no.	Preis € price €
213100	29,00

Farbe: Glas satiniert
colour: glass frosted

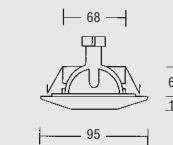

Material material	Bestückung lamp	Leistung power	Schutzart degree of protection	Schutzklasse protection class
Eisen-Glas / iron-glass	1x GX5,3 QRCBC51	max. 35W	IP20	III



1966...



NV-Deckeneinbauleuchte / recessed low-voltage ceiling spot

Artikel-Nr. article-no.	Preis € price €
1966.02	25,20
1966.15	25,60
574600	7,50

Ersatzglas
replacement glass
Art.-Nr.: 574600

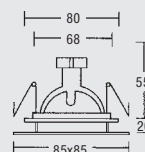

Material material	Bestückung lamp	Leistung power	Schutzart degree of protection	Schutzklasse protection class
Aluminiumguss-Glas aluminium cast-glass	1x GX5,3 QRCBC51	max. 50W	IP20	III



MODULO
ELECTRO
www.modulelectro.ru

1985...



NV-Deckeneinbauleuchte / recessed low-voltage ceiling spot

Artikel-Nr. article-no.	Preis € price €
1985.02	64,40
578500	20,40

Ersatzglas
replacement glass
Art.-Nr.: 578500

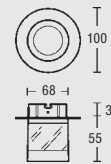

Material material	Bestückung lamp	Leistung power	Schutzart degree of protection	Schutzklasse protection class
Eisen-Glas / iron-glass	1x G4 QT9	max. 20W	IP20	III



1987...

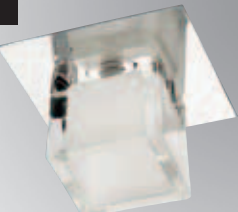

NV-Deckeneinbauleuchte / recessed low-voltage ceiling spot

Artikel-Nr. article-no.	Preis € price €
1987.02	66,60
578700	20,40

Ersatzglas
replacement glass
Art.-Nr.: 578700

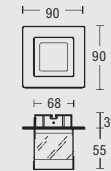

Material material	Bestückung lamp	Leistung power	Schutzart degree of protection	Schutzklasse protection class
Eisen-Glas / iron-glass	1x G4 QT9	max. 20W	IP20	III



0282...

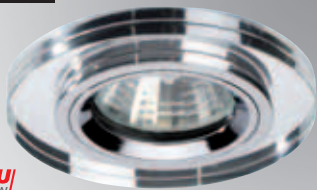

NV-Deckeneinbauleuchte / recessed low-voltage ceiling spot

Artikel-Nr. article-no.	Preis € price €
0282.00	14,00



Material material	Bestückung lamp	Leistung power	Schutzart degree of protection	Schutzklasse protection class
Guss-Glas / cast-glass	1x GX5,3 QRCBC51	max. 50W	IP20	III



0283...



NV-Deckeneinbauleuchte / recessed low-voltage ceiling spot

Artikel-Nr. article-no.	Preis € price €
0283.00	18,00

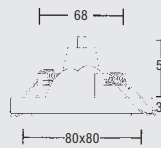

Material material	Bestückung lamp	Leistung power	Schutzart degree of protection	Schutzklasse protection class
Guss-Glas / cast-glass	1x GX5,3 QRCBC51	max. 50W	IP20	III



NV-Deckeneinbauleuchte / recessed low-voltage ceiling spot

Artikel-Nr. article-no.	Preis € price €
3040.02	33,20
3040.05	33,20

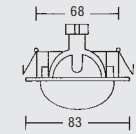

3040...

Material material	Bestückung lamp	Leistung power	Schutzart degree of protection	Schutzklasse protection class
Guss-Glas / cast-glass	1x GX5,3 QRCBC51	max. 35W	IP20	III



NV-Deckeneinbauleuchte / recessed low-voltage ceiling spot

Artikel-Nr. article-no.	Preis € price €
3041.02	36,30
3041.05	36,30

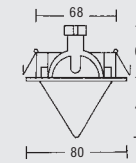

3041...

Material material	Bestückung lamp	Leistung power	Schutzart degree of protection	Schutzklasse protection class
Guss-Glas / cast-glass	1x GX5,3 QRCBC51	max. 35W	IP20	III



MODULO ELECTRO

www.modulelectro.ru



2332...



System-Element für die Artikel 2521.15 - 2532.15
system-ring for article 2521.15 - 2532.15

Artikel-Nr. article-no.	Preis € price €
2332.15	19,00

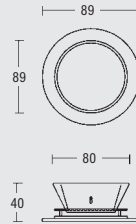

Material material	Bestückung lamp	Leistung power	Schutzart degree of protection	Schutzklasse protection class
Aluminium / aluminium	-	-	-	-



2333...

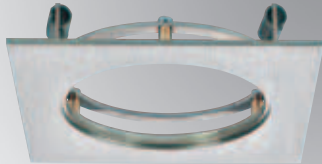

System-Element für die Artikel 2521.15 - 2532.15
system-ring for article 2521.15 - 2532.15

Artikel-Nr. article-no.	Preis € price €
2333.15	21,00

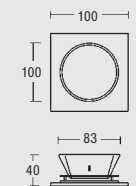

Material material	Bestückung lamp	Leistung power	Schutzart degree of protection	Schutzklasse protection class
Aluminium / aluminium	-	-	-	-



2523...



Einsatz für das System-Element Artikel 2521.15 + 2532.15
insert for the articles 2332.15 + 2333.15

Artikel-Nr. article-no.	Preis € price €
2523.15	20,00

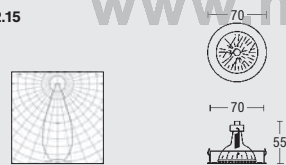

Material material	Bestückung lamp	Leistung power	Schutzart degree of protection	Schutzklasse protection class
Aluminium / aluminium	1x GX5,3 QRCBC51	max. 50W	IP20	III



2521...



Einsatz für das System-Element Artikel 2521.15 + 2532.15
insert for the articles 2332.15 + 2333.15

Artikel-Nr. article-no.	Preis € price €
2521.15	27,00

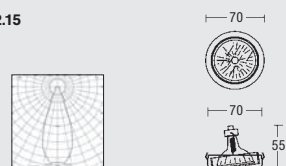

Material material	Bestückung lamp	Leistung power	Schutzart degree of protection	Schutzklasse protection class
Aluminium / aluminium	1x GX5,3 QRCBC51	max. 50W	IP20	III



2526...



Einsatz für das System-Element Artikel 2521.15 + 2532.15
insert for the articles 2332.15 + 2333.15

Artikel-Nr. article-no.	Preis € price €
2526.15	31,00

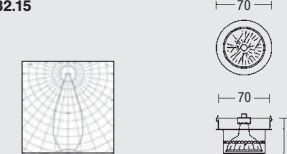

Material material	Bestückung lamp	Leistung power	Schutzart degree of protection	Schutzklasse protection class
Aluminium / aluminium	1x GX5,3 QRCBC51	max. 50W	IP20	III

2532...



Einsatz für das System-Element Artikel 2521.15 + 2532.15
insert for the articles 2332.15 + 2333.15

Artikel-Nr. article-no.	Preis € price €
2532.15	38,00

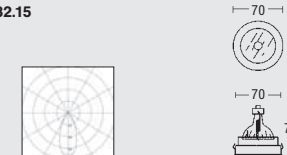

Material material	Bestückung lamp	Leistung power	Schutzart degree of protection	Schutzklasse protection class
Aluminium-Glas aluminium-glass	1x GX5,3 QRCBC51	max. 50W	IP20	III



2531...



Einsatz für das System-Element Artikel 2521.15 + 2532.15
insert for the articles 2332.15 + 2333.15

Artikel-Nr. article-no.	Preis € price €
2531.15	29,00



Material material	Bestückung lamp	Leistung power	Schutzart degree of protection	Schutzklasse protection class
Aluminium-Glas aluminium-glass	1x GX5,3 QRCBC51	max. 50W	IP20	III



2527...



Einsatz für das System-Element Artikel 2521.15 + 2532.15
insert for the articles 2332.15 + 2333.15

Artikel-Nr. article-no.	Preis € price €
2527.15	46,00

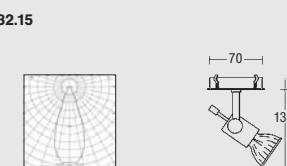

Material material	Bestückung lamp	Leistung power	Schutzart degree of protection	Schutzklasse protection class
Aluminium aluminium	1x GX5,3 QRCBC51	max. 50W	IP20	III



MODULO ELECTRO
www.modulelectro.ru



1930...

NV-Deckeneinbauleuchte / recessed low-voltage ceiling spot

Artikel-Nr. article-no.	Preis € price €
1930.02	40,40
1930.05	42,90
1930.15	43,50

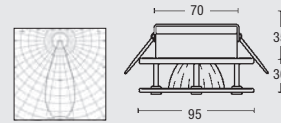

Material material	Bestückung lamp	Leistung power	Schutzart degree of protection	Schutzklasse protection class
Eisen-Glas / iron-glass	1x GX5,3 QRCBC51	max. 50W	IP20	III



2284...

**NV-Einbauleuchte mit Radial-LED-Kranz
recessed low-voltage spot with radial-LED-circuit**

Artikel-Nr. article-no.	Preis € price €	Artikel-Nr. article-no.	Preis € price €
2284.02W	76,00	2284.15W	76,00
2284.02B	76,00	2284.15B	76,00
2284.02R	76,00	2284.15R	76,00
2284.02Y	76,00	2284.15Y	76,00
2284.02G	76,00	2284.15G	76,00

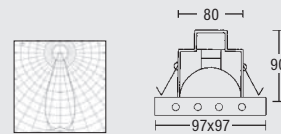

Lieferung inkl. LED-Konverter. Mit zwei 230V-Anschlüssen ist eine getrennte Schaltung (NV/LED) möglich.
delivery incl. LED-converter. Separate circuit possible by two 230V (low volt-LED) connection.

Material material	Bestückung lamp	Leistung power	Schutzart degree of protection	Schutzklasse protection class
Guss / cast	1x GX5,3 QRCBC51	max. 35W	IP20	III

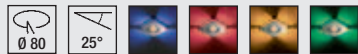

2288...

**NV-Einbauleuchte mit Radial-LED-Kranz
recessed low-voltage spot with radial-LED-circuit**

Artikel-Nr. article-no.	Preis € price €	Artikel-Nr. article-no.	Preis € price €
2288.02W	69,90	2288.15W	69,90
2288.02B	69,90	2288.15B	69,90
2288.02R	69,90	2288.15R	69,90
2288.02Y	69,90	2288.15Y	69,90
2288.02G	69,90	2288.15G	69,90

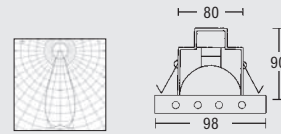

Lieferung inkl. LED-Konverter. Mit zwei 230V-Anschlüssen ist eine getrennte Schaltung (NV/LED) möglich.
delivery incl. LED-converter. Separate circuit possible by two 230V (low volt-LED) connection.

Material material	Bestückung lamp	Leistung power	Schutzart degree of protection	Schutzklasse protection class
Guss / cast	1x GX5,3 QRCBC51	max. 35W	IP20	III

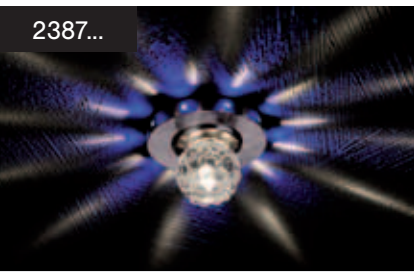
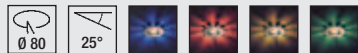

2387...

**NV-Einbauleuchte mit Radial-LED-Kranz
recessed low-voltage spot with radial-LED-circuit**

Artikel-Nr. article-no.	Preis € price €
2387.15	73,90

Lieferung inkl. LED-Konverter. Mit zwei 230V-Anschlüssen ist eine getrennte Schaltung (NV/LED) möglich.
delivery incl. LED-converter. Separate circuit possible by two 230V (low volt-LED) connection.

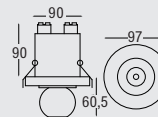

Lichtfarbe: blau / light colour: blue

Material material	Bestückung lamp	Leistung power	Schutzart degree of protection	Schutzklasse protection class
Guss-Eisen-Glas cast-iron-glass	1x G4 QT9	max. 10W	IP20	III

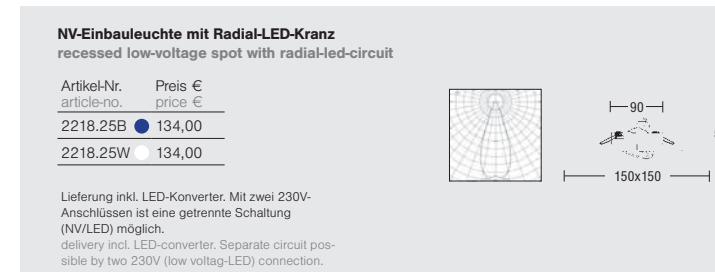

2218...

**NV-Einbauleuchte mit Radial-LED-Kranz
recessed low-voltage spot with radial-LED-circuit**

Artikel-Nr. article-no.	Preis € price €
2218.25B	134,00
2218.25W	134,00

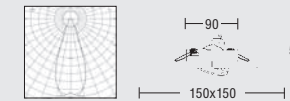

Lieferung inkl. LED-Konverter. Mit zwei 230V-Anschlüssen ist eine getrennte Schaltung (NV/LED) möglich.
delivery incl. LED-converter. Separate circuit possible by two 230V (low volt-LED) connection.

Material material	Bestückung lamp	Leistung power	Schutzart degree of protection	Schutzklasse protection class
Aluminium-Glas aluminium-glass	1x GX5,3 QRCBC51 & LED-Platine	max. 35W	IP20	III

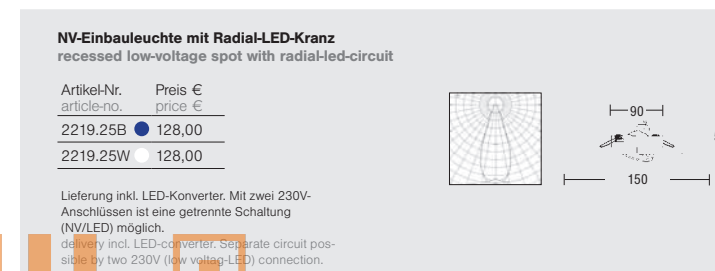

2219...

**NV-Einbauleuchte mit Radial-LED-Kranz
recessed low-voltage spot with radial-LED-circuit**

Artikel-Nr. article-no.	Preis € price €
2219.25B	128,00
2219.25W	128,00

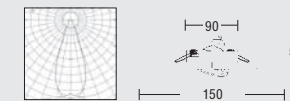

Lieferung inkl. LED-Konverter. Mit zwei 230V-Anschlüssen ist eine getrennte Schaltung (NV/LED) möglich.
delivery incl. LED-converter. Separate circuit possible by two 230V (low volt-LED) connection.

Material material	Bestückung lamp	Leistung power	Schutzart degree of protection	Schutzklasse protection class
Aluminium-Glas aluminium-glass	1x GX5,3 QRCBC51 & LED-Platine	max. 35W	IP20	III



www.modulelectro.ru

MODULO ELECTRO

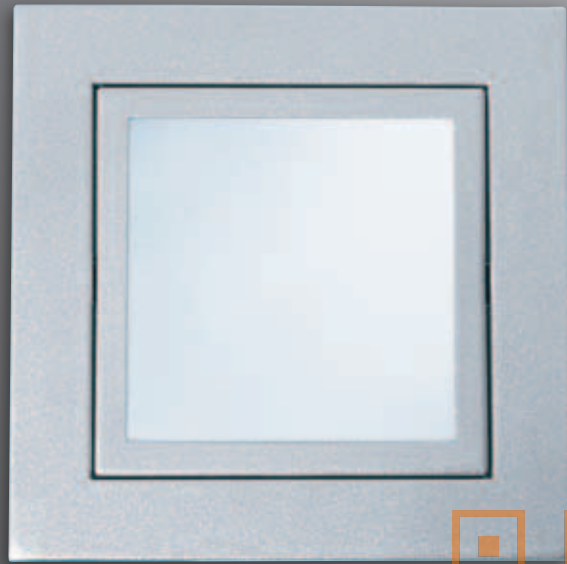

MODUL
ELECTRO
www.modulelectro.ru

Vorteil:

- Design- und Materialvielfalt

Anwendung:

- Flure, Treppen, Akzentbeleuchtung, Orientierungsbeleuchtung, Leitlinien

Advantage:

- Manifold designs and materials

Application:

- Halls, stairs accent lighting, night illumination, guidelines



Wand- & Orientierungsleuchten | wall & orientation lights

Wand- & Orientierungsleuchten | wall & orientation lights

522941





Wandeinbauleuchte / recessed wall light

Artikel-Nr. article-no.	Preis € price €	Lieferung inkl. Einputzgehäuse Artikel 370200. Maße: □ 72x70 x ET 54 delivery incl. in-wall box, article 370200. dimensions: □ 72x70 x depth 54
522941	40,50	

Farbe: alu matt
colour: alu satin

Material material	Bestückung lamp	Leistung power	Schutzart degree of protection	Schutzklasse protection class
Eisen / iron	1x G4 QT9	max. 20W	IP20	III

522970





Wandeinbauleuchte / recessed wall light

Artikel-Nr. article-no.	Preis € price €	Zubehör: Einputzdose 555700 Maße: 92 x 82 x 62 Einputzdose 554700 für Leuchte und Trafo, Maße: 205 x 92 x 60 accessories: in-wall box 555700 dimensions: 92 x 82 x 62mm in-wall box 554700 for lamp and transformer, dimensions: 205 x 92 x 60mm
522970	155,50	
554700	25,90	
555700	17,00	

Farbe: edelstahl
colour: stainless steel

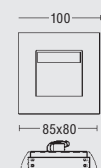
Material material	Bestückung lamp	Leistung power	Schutzart degree of protection	Schutzklasse protection class
Edelstahl-Aluminium stainless steel-aluminium	1x G4 QT9	max. 20W	IP20	III

522942



Wandeinbauleuchte / recessed wall light

Artikel-Nr. article-no.	Preis € price €	Lieferung inkl. Einputzgehäuse Artikel 370100. Maße: □ 76 x ET 75 delivery incl. in-wall box, article 370100. dimensions: □ 76 x depth 75
522942	45,00	

Farbe: alu matt
colour: alu satin

Material material	Bestückung lamp	Leistung power	Schutzart degree of protection	Schutzklasse protection class
Guss-Glas cast-glass	1x G4 QT9	max. 20W	IP20	III





522971

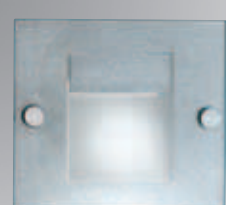



Wandeinbauleuchte / recessed wall light

Artikel-Nr. article-no.	Preis € price €	Zubehör: Einputzdose 555700 Maße: 92 x 82 x 62 Einputzdose 554700 für Leuchte und Trafo, Maße: 205 x 92 x 60 accessories: in-wall box 555700 dimensions: 92 x 82 x 62mm in-wall box 554700 for lamp and transformer, dimensions: 205 x 92 x 60mm
522971	254,70	
554700	25,90	
555700	17,00	
570600	35,40	

Farbe: edelstahl
colour: stainless steel

Material material	Bestückung lamp	Leistung power	Schutzart degree of protection	Schutzklasse protection class
Edelstahl-Aluminium-Glas stainless steel-alu-glass	1x G4 QT9	max. 20W	IP20	III

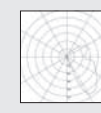
Ersatzglas: 570600
Replacement glass: 570600

522950





Wandeinbauleuchte / recessed wall light

Artikel-Nr. article-no.	Preis € price €	Zubehör: Einputzdose 555500 Maße: Ø 80 x ET 68 Einputzdose 554500 für Leuchte und Trafo, Maße: 165x92x60 accessories: in-wall box 555500 dimensions: Ø 80mm x depth 68mm in-wall box 554500 for lamp and transformer, dimensions: 165x92x60mm
522950	112,30	
554500	26,70	
555500	21,40	

Farbe: edelstahl
colour: stainless steel

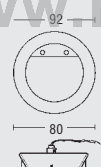
Material material	Bestückung lamp	Leistung power	Schutzart degree of protection	Schutzklasse protection class
Edelstahl-Aluminium stainless steel-aluminium	1x G4 QT9	max. 20W	IP20	III

522980





Wandeinbauleuchte / recessed wall light

Artikel-Nr. article-no.	Preis € price €	Zubehör: Einputzdose 555800 Maße: 165 x 80 x 62 Einputzdose 554800 für Leuchte und Trafo, Maße: 165 x 150 x 62 accessories: in-wall box 555800 dimensions: 165 x 80 x 62mm in-wall box 554800 for lamp and transformer, dimensions: 165 x 150 x 62mm
522980	219,00	
554800	32,60	
555800	34,60	

Farbe: edelstahl
colour: stainless steel

Material material	Bestückung lamp	Leistung power	Schutzart degree of protection	Schutzklasse protection class
Edelstahl-Aluminium stainless steel-aluminium	3x G4 QT9	max. 10W	IP20	III

522951



Wandeinbauleuchte / recessed wall light

Artikel-Nr. article-no.	Preis € price €	Zubehör: Einputzdose 555500 Maße: Ø 80 x ET 68 Einputzdose 554500 für Leuchte und Trafo, Maße: 165x92x60 accessories: in-wall box 555500 dimensions: Ø 80mm x depth 68mm in-wall box 554500 for lamp and transformer, dimensions: 165x92x60mm
522951	172,20	
554500	26,70	
555500	21,40	
570500	26,80	

Farbe: edelstahl
colour: stainless steel

Material material	Bestückung lamp	Leistung power	Schutzart degree of protection	Schutzklasse protection class
Edelstahl-Aluminium-Glas stainless steel-alu-glass	1x G4 QT9	max. 20W	IP20	III

Ersatzglas: 570500
Replacement glass: 570500





0054...

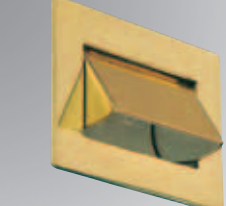



Wandeinbauleuchte / recessed wall light

Hohlwandmontage
cavity wall mounting

Artikel-Nr. article-no.	Preis € price €
0054.00	185,00
0054.02	183,00

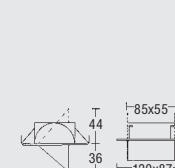
Material material	Bestückung lamp	Leistung power	Schutzart degree of protection	Schutzklasse protection class
Messing / brass	1x GY6,35 QT12	max. 50W	IP20	III

MODU
ELECTRO
www.modulelectro.ru



MODUL
ELECTRO
www.modulelectro.ru

Vorteil:

- Decken- und Wandeinbau
- Ideale Designkombinationen mit Spots

Anwendung:

- Foyers, Büros, WC's, Bäder, Küchen, Wohn- und Esszimmer, usw.

Advantage:

- Ceiling- and wallmounting
- Perfect design in combination with spots

Application:

- Lounges, offices, toilets, bathroom, kitchens, living- and dining rooms, etc.

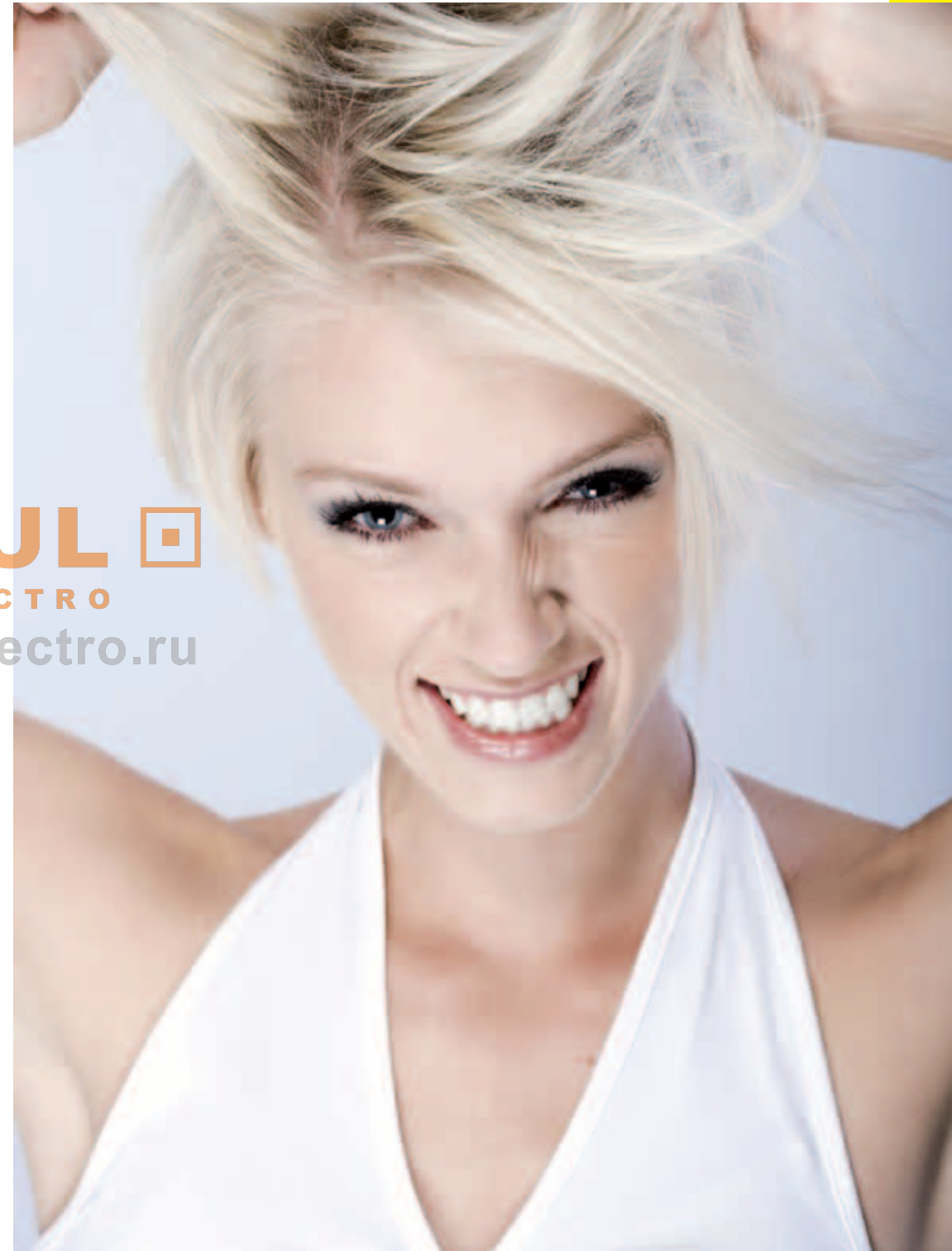

3096...

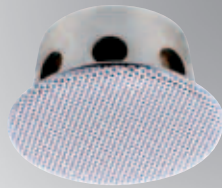

Lautsprecher-Einsatz ohne Übertrager
loudspeaker-inlay without transformer

Artikel-Nr. article-no.	Preis € price €
3096.02	52,40
3096.07	49,90

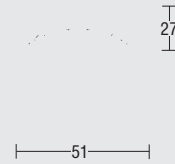

Ø 51mm

Technische Daten / technical data

Nenn-/Musikbelastbarkeit:	3 Watt
power rating:	3 Watt
Impedanz:	20 Ohm (Es können bis zu 5 Lautsprecher an einen Kanal eines HiFi-Verstärkers parallel angeschlossen werden)
impedance:	20 Ohm (it is possible to connect up to 5 loudspeaker in parallel of one channel of a HiFi-unit)
Schalldruckpegel:	1W/1m: 82 dB (bei Nennleistung 87 dB)
sound pressure level:	1W/1m: 82 dB (by rated burden 87 dB)
Übertragungsbereich:	200 - 16.000 Hz
frequency response:	200 - 16.000 Hz
Ausführung:	Frontring aus Eisen und Lochblechabdeckung weiß oder chrom-metallisiert.
specification:	front ring consisting of iron and perforated metal sheet cover white or chrome-metalized.
Nettogewicht:	0,4 kg
net weight:	0,4 kg
Technische Besonderheiten:	Montage mit Schnappfedern. Anschluß durch 2-adrige Leitung mit Anschlussklemme.
technical features:	mounting by catch spring connection with 2-pole cord and terminal clamp.

3090...

Einbaulautsprecher mit Übertrager 100V für ELA-Anlage
recessed loudspeaker with transformer 100V for ELA-installation

Artikel-Nr. article-no.	Preis € price €
3090.02	109,40
3090.07	96,10

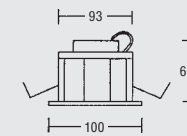

Membrane feuchtigkeits-imprägniert / membrane moisture repellent

Technische Daten / technical data

Nenn-/Musikbelastbarkeit:	6/8 Watt
power rating:	6/8 Watt
Impedanz:	4 Ohm
impedance:	4 Ohm
Schalldruckpegel:	1W/1m: 85 dB (bei Nennleistung 93 dB)
sound pressure level:	1W/1m: 85 dB (by rated burden 93 dB)
Übertragungsbereich:	150 - 18.000 Hz
frequency response:	150 - 18.000 Hz
Ausführung:	Frontring aus Kunststoff und Lochblechabdeckung weiß oder chrom-metallisiert. Membrane feuchtigkeits-imprägniert
specification:	front ring consisting of plastic and perforated metal sheet cover white or chrome-metalized. Membrane moisture repellent
Bestückung:	B 66 BB
assembly:	B 66 BB
Nettogewicht:	0,6 kg
net weight:	0,6 kg
Technische Besonderheiten:	Montage mit Schnappfedern. Anschluß durch 2-adrige Leitung mit Anschlussklemme.
technical features:	mounting by catch spring connection with 2-pole cord and terminal clamp.



www.modulelectro.ru

3093...

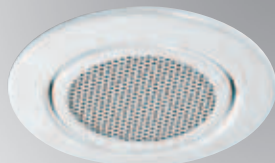

Einbau-Lautsprecher ohne Übertrager
recessed loudspeaker without transformer

Artikel-Nr. article-no.	Preis € price €
3093.02	62,10
3093.07	58,40
3093.15	67,30

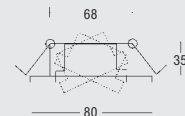

Ø 51mm

Technische Daten / technical data

Nenn-/Musikbelastbarkeit:	3 Watt
power rating:	3 Watt
Impedanz:	20 Ohm (Es können bis zu 5 Lautsprecher an einen Kanal eines HiFi-Verstärkers parallel angeschlossen werden)
impedance:	20 Ohm (it is possible to connect up to 5 loudspeaker in parallel of one channel of a HiFi-unit)
Schalldruckpegel:	1W/1m: 82 dB (bei Nennleistung 87 dB)
sound pressure level:	1W/1m: 82 dB (by rated burden 87 dB)
Übertragungsbereich:	200 - 16.000 Hz
frequency response:	200 - 16.000 Hz
Ausführung:	Frontring aus Eisen und Lochblechabdeckung weiß, nickelmatt oder chrom-metallisiert.
specification:	front ring consisting of iron and perforated metal sheet cover white, nickelsatin or chrome-metalized.
Nettogewicht:	0,4 kg
net weight:	0,4 kg
Technische Besonderheiten:	Montage mit Schnappfedern. Anschluß durch 2-adrige Leitung mit Anschlussklemme.
technical features:	mounting by catch spring connection with 2-pole cord and terminal clamp.

3092...

Einbau-Lautsprecher ohne Übertrager
recessed loudspeaker without transformer

Artikel-Nr. article-no.	Preis € price €
3092.02	88,20
3092.05	91,00
3092.07	67,50
3092.26	97,00

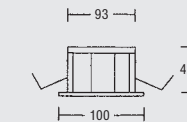

Membrane feuchtigkeits-imprägniert / membrane moisture repellent

Technische Daten / technical data

Nenn-/Musikbelastbarkeit:	6/8 Watt
power rating:	6/8 Watt
Impedanz:	4 Ohm
impedance:	4 Ohm
Schalldruckpegel:	1W/1m: 85 dB (bei Nennleistung 93 dB)
sound pressure level:	1W/1m: 85 dB (by rated burden 93 dB)
Übertragungsbereich:	150 - 18.000 Hz
frequency response:	150 - 18.000 Hz
Ausführung:	Frontring aus Kunststoff und Lochblechabdeckung stahl-matt (RAL 9006), weiß, chrom-metallisiert oder gold-metallisiert. Membrane feuchtigkeits-imprägniert
specification:	front ring consisting of plastic and perforated metal sheet cover stahl-satin (RAL 9006), white, chrome-metalized or gold-metalized. Membrane moisture repellent
Bestückung:	B 66 BB
assembly:	B 66 BB
Nettogewicht:	0,4 kg
net weight:	0,4 kg
Technische Besonderheiten:	Montage mit Schnappfedern. Anschluß durch 2-adrige Leitung mit Anschlussklemme.
technical features:	mounting by catch spring connection with 2-pole cord and terminal clamp.

3083...

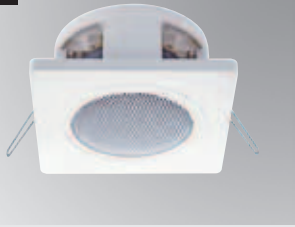

Lautsprecher-Einsatz ohne Übertrager
loudspeaker-inlay without transformer

Artikel-Nr. article-no.	Preis € price €
3083.07	84,60

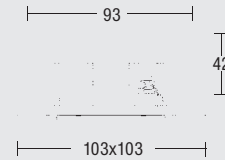

Membrane feuchtigkeits-imprägniert / membrane moisture repellent

Technische Daten / technical data

Nenn-/Musikbelastbarkeit: power rating:	6/8 Watt 6/8 Watt
Impedanz: impedance:	20 Ohm (Es können bis zu 5 Lautsprecher an einen Kanal eines HiFi-Verstärkers parallel angeschlossen werden) 20 Ohm (it is possible to connect up to 5 loudspeaker in parallel of one channel of a HiFi-unit)
Schalldruckpegel: sound pressure level:	1W/1m: 85 dB (bei Nennleistung 93 dB) 1W/1m: 85 dB (by rated burden 93 dB)
Übertragungsbereich: frequency response:	170 - 21.000 Hz 170 - 21.000 Hz
Ausführung: specification:	Abdeckung aus Kunststoff und Lochblechabdeckung weiß, Membrane feuchtigkeits-imprägniert cover consisting of plastic and white, membrane moisture repellent
Bestückung: assembly:	B 66 BB B 66 BB
Nettogewicht: net weight:	0,4 kg 0,4 kg
Technische Besonderheiten: technical features:	Montage mit Schnappfedern. Anschluß durch 2-adrige Leitung mit Anschlussklemme. mounting by catch spring connection with 2-pole cord and terminal clamp.

3094...

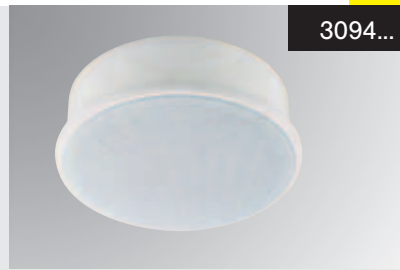

Einbau-Lautsprecher ohne Übertrager
recessed loudspeaker without transformer

Artikel-Nr. article-no.	Preis € price €
3094.07	144,50

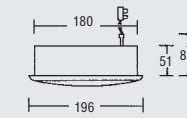

Gegen Aufpreis mit Übertrager / surcharge for transformer
Membrane feuchtigkeits-imprägniert / membrane moisture repellent

Technische Daten / technical data

Nenn-/Musikbelastbarkeit: power rating:	40/50 Watt 40/50 Watt
Impedanz: impedance:	8 Ohm 8 Ohm
Schalldruckpegel: sound pressure level:	1W/1m: 89 dB (bei Nennleistung 98 dB) 1W/1m: 89 dB (by rated burden 98 dB)
Übertragungsbereich: frequency response:	60 - 20.000 Hz 60 - 20.000 Hz
Ausführung: specification:	Front- und Montagering aus Kunststoff mit Lochblechabdeckung. Membrane feuchtigkeits-imprägniert. Front ring and mounting ring consisting of plastic with perforated metal sheet covers. Membrane moisture repellent.
Bestückung: assembly:	1 PM 135 1 PM 135
Nettogewicht: net weight:	1,0 kg ohne Übertrager-1,2 kg mit Übertrager 1,0 kg without transformer-1,2 kg with transformer
Zubehör: accessories:	Inkl. Befestigungsmaterial für Wandstärken von 1-20mm. Eingießtopf 531500 für Betondecken gegen Aufpreis incl. fastening for wall thickness from 1-20mm. in-wall box art-no. 531500 for concrete ceilings for additional charge
Anschluss: connection:	2-adrige Leitung mit Anschlussklemme. connection with 2-pole cord and terminal clamp



3091...

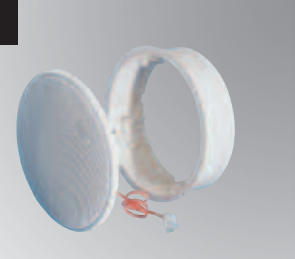

Einbau-Lautsprecher ohne Übertrager
recessed loudspeaker without transformer

Artikel-Nr. article-no.	Preis € price €
3091.07	111,90
3091.2 6	115,10
531500	35,80

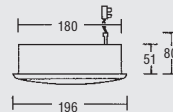

Gegen Aufpreis mit Übertrager / surcharge for transformer
Membrane feuchtigkeits-imprägniert / membrane moisture repellent

Technische Daten / technical data

Nenn-/Musikbelastbarkeit: power rating:	6/8 Watt 6/8 Watt
Impedanz: impedance:	4 Ohm, auf Anfrage auch in 20 Ohm lieferbar 4 Ohm, also available with 20 Ohm on demand
Schalldruckpegel: sound pressure level:	1W/1m: 90 dB (bei Nennleistung 98 dB) 1W/1m: 90 dB (by rated burden 98 dB)
Übertragungsbereich: frequency response:	150 - 18.000 Hz 150 - 18.000 Hz
Ausführung: specification:	Front- und Montagering aus Kunststoff mit Lochblechabdeckung. Membrane feuchtigkeits-imprägniert. Front ring and mounting ring consisting of plastic with perforated metal sheet covers. Membrane moisture repellent.
Bestückung: assembly:	1 PM 135 1 PM 135
Nettogewicht: net weight:	1,0 kg ohne Übertrager-1,2 kg mit Übertrager 1,0 kg without transformer-1,2 kg with transformer
Zubehör: accessories:	Inkl. Befestigungsmaterial für Wandstärken von 1-20mm. Eingießtopf 531500 für Betondecken gegen Aufpreis incl. fastening for wall thickness from 1-20mm. in-wall box art-no. 531500 for concrete ceilings for additional charge
Anschluss: connection:	2-adrige Leitung mit Anschlussklemme. connection with 2-pole cord and terminal clamp



Art. 531500
Eingießtopf für Betondecke
art. 531500
for mounting in wall

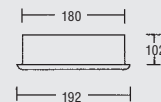

3084...



Einbau-Lautsprecher ohne Übertrager
recessed loudspeaker without transformer

Artikel-Nr. article-no.	Preis € price €
3084.07	171,40

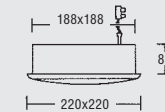

Gegen Aufpreis mit Übertrager / surcharge for transformer
Membrane feuchtigkeits-imprägniert / membrane moisture repellent

Technische Daten / technical data

Nenn-/Musikbelastbarkeit: power rating:	40/50 Watt 40/50 Watt
Impedanz: impedance:	8 Ohm 8 Ohm
Schalldruckpegel: sound pressure level:	1W/1m: 89 dB (bei Nennleistung 98 dB) 1W/1m: 89 dB (by rated burden 98 dB)
Übertragungsbereich: frequency response:	60 - 20.000 Hz 60 - 20.000 Hz
Ausführung: specification:	Front- und Montagering aus Kunststoff mit Lochblechabdeckung. Membrane feuchtigkeits-imprägniert. Front ring and mounting ring consisting of plastic with perforated metal sheet covers. Membrane moisture repellent.
Bestückung: assembly:	1 PM 135 1 PM 135
Nettogewicht: net weight:	1,0 kg ohne Übertrager-1,2 kg mit Übertrager 1,0 kg without transformer-1,2 kg with transformer
Zubehör: accessories:	Inkl. Befestigungsmaterial für Wandstärken von 1-20mm. Eingießtopf Kaiser Art.-Nr. 1293-00 incl. fastening for wall thickness from 1-20mm. moulded in-wall box, Kaiser art-no. 1293-00
Anschluss: connection:	2-adrige Leitung mit Anschlussklemme. connection with 2-pole cord and terminal clamp

3098...



Kardan-Lautsprecher-Einsatz ohne Übertrager
gimballed loudspeaker-inlay without transformer

Artikel-Nr. article-no.	Preis € price €
3098.22	89,10

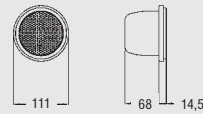

Technische Daten / technical data

Nenn-/Musikbelastbarkeit:	4 Watt
power rating:	4 Watt
Impedanz:	20 Ohm
impedance:	20 Ohm
Schalldruckpegel:	1W/1m: 86 dB
sound pressure level:	1W/1m: 86 dB
Übertragungsbereich:	80 - 21.000 Hz
frequency response:	80 - 21.000 Hz
Nettogewicht:	1,0 kg
net weight:	1,0 kg
Durchmesser:	111mm QR111
diameter:	111mm QR111

MODUL
ELECTRO
www.modulelectro.ru



Leuchten für intensive Objektbeleuchtung.
Mit unseren vielen dekorativen Vorsatzelementen erscheinen
Ihre Geschäfts- und Verwaltungsbauten in einem ganz individuellen Licht.

Lassen Sie sich von der hohen Lichtausbeute
und der geprüften Qualität überzeugen!

Lights for intensive object lighting.
With the help of our many decorative elements your business premises will
appear in a new individual light.

Satisfy yourself from the high light emitting efficiency and the proved quality.



Decken- ausschnitt (mm)	Bestückung (W) lamp (W)										Seite page
	1x 13	1x 18	1x 26	1x 32	1x 42	2x 13	2x 18	2x 26	2x 32	2x 42	
140						•					259
145	•	•				•	•				231, 233
165	•	•	•			•	•				235, 245, 251
185							•	•	•		248, 249, 259
200			•	•		•	•	•			237, 245, 247, 251
235								•	•	•	239, 245, 251
130x130						•					257
160x160	•	•	•	•							255
190x190								•	•		257
195x195						•	•				255
235x235				•				•	•	•	255



MODUL
ELECTRO
www.modulelectro.ru

Mini-Downlights



Mini Downlights / mini downlights

Einbaudownlight für Kompaktleuchtstofflampen (TC-D/TC-DEL, bzw. TC-T/TC-TEL). Stabiles Gehäuse mit separatem Geräteträger aus verzinktem Stahlblech, grau pulverbeschichtet. Deckeneinbau werkzeuglos mittels Federmechanismus. Deckenring weiß pulverbeschichtet (alternative Farben auf Anfrage). Aluminiumreflektor hochglanz silber, Leuchtmittellage horizontal. Netzanschluss: Anschlussklemme bis 5x2,5mm² inkl. Zugentlastung. Durchgangsverdrahtung möglich. Schutzart IP20, Schutzklasse I, F-Zeichen

Recessed lighting fitting for compact fluorescent lamps (TC-D/TC-DEL, or rather TC-T/TC-TEL). Stable housing with separate gear box made of zinc-plated steel panel, grey powder coated. Installation without tools by mounting springs. Ceiling ring white powder coated (alternative colours on request). Aluminium reflector highgloss silver, lamps in horizontal position. Power supply: Terminal clamp up to 5x2,5mm² incl. strain relief. Through wiring possible. degree of protection IP20, protection class I, F-sign

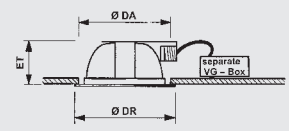

Leuchtenbetriebswirkungsgrad = nLB 71%
light output ratio working = nLB 71%

Art.-Nr. art-no.	Bestückung/Betriebssystem lamp	Ø DR, Ø DA, Ø ET in mm	nLB	kg	Preis € price €
415801V	TC-T 1x 13W/VVG	Ø 165, Ø 145, 95	71%	1,3	52,90
415801E	TC-TEL 1x 13W/EVG	Ø 165, Ø 145, 95	71%	0,9	84,80
415802V	TC-T 1x 18W/VVG	Ø 165, Ø 145, 95	71%	1,3	52,90
415802E	TC-TEL 1x 18W/EVG	Ø 165, Ø 145, 95	71%	0,9	84,80
415807V	TC-T 1x 26W/VVG	Ø 165, Ø 145, 95	71%	1,4	53,90
415807E	TC-TEL 1x 26W/EVG	Ø 165, Ø 145, 95	71%	0,9	85,80
415803V	TC-D 2x 13W/VVG	Ø 165, Ø 145, 95	71%	1,6	65,50
415803E	TC-DEL 2x 13W/EVG	Ø 165, Ø 145, 95	71%	1,1	115,10
415804V	TC-D 2x 18W/VVG	Ø 165, Ø 145, 95	71%	1,6	65,50
415804E	TC-DEL 2x 18W/EVG	Ø 165, Ø 145, 95	71%	1,1	115,10

Technische Erläuterungen
technical explanations

- nLB = Leuchtenbetriebswirkungsgrad
light output-ratio working
- Ø DR = Außendurchmesser - Deckenring
outer diameter - ceiling ring
- Ø DA = Deckenausschnitt
ceiling cut-out
- ET = Einbautiefe
installation depth
- kg = Gewicht in Kilogramm
weight in kg

Mini-Downlights



Glasabdeckungen zu den genannten Leuchten finden Sie auf der folgenden Seite.
Please find glass covers for the mentioned luminaires on the following page.

Weiteres lieferbares Zubehör (auf Anfrage) / further accessories (on request)

- Dimmbares EVG (Schnittstelle 1-10V)
- dimmable electronic ballast (for 1-10V interface)
- Notlichtbausatz B (Einzelbatterie 1 oder 3 h)
- emergency kit B (single battery 1 or 3h)
- Werkseitige Kompensation
- factory-made compensation
- Dimmbares EVG DALI (digital) (ab Bestückung 18W)
- dimmable electronic ballast DALI (digital) (for 18W lamp)
- Einbauring in RAL (Farbton nach Wahl) pulverbeschichtet
- installation ring in RAL (colour on request) powder-coated
- Reflektor in Ausführung mattglanz silber
- reflector in satin silver
- Einputzring für Nassdecken (Rabitzdecken)
- mounting ring for wet ceilings (Rabitz ceilings)
- Entlastungselement für Mineralfaserdecken Modul 600 oder Modul 625
- release element for mineral fibre ceilings module 600 or module 625
- Modulplatte M100 weiß oder in RAL-Farbtönen nach Wahl
- module slab M100 white or in RAL-colour on request
- Betonarmatur
- mounting part for concrete ceilings

Ausstattungs-elemente / attachments

für die Produkte auf der Seite 320 / for products on the page 320



Art.-Nr. / art-no. B165SW2 € 37,90

Floatglassscheibe teilmattiert/float glass partially frosted



Art.-Nr. / art-no. B165RW1 € 37,90

Floatglasring vollmattiert/float glassring completely frosted



Art.-Nr. / art-no. B165EWK € 35,80

Schutzglas klar
float glass clear



Art.-Nr. / art-no. B165EWT € 35,80

Schutzglas teilmattiert
float glass partially frosted



Art.-Nr. / art-no. B165EWM € 35,80

Schutzglas vollmattiert
float glass completely frosted

Ein Austausch der Abdeckungen ist werkzeuglos möglich.
Weitere Abdeckungen auf Anfrage.
Change of the luminaire covers without any tool.
Other luminaire covers on request.

Ø 185 mm

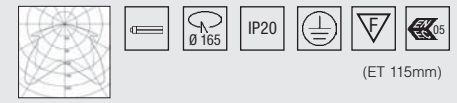
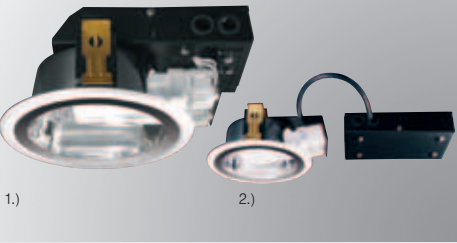

(ET 115mm)

Leuchtenbetriebswirkungsgrad = nLB 71/72%
light output ratio working = nLB 71/72%

Art.-Nr. art.-no.	Bestückung/Betriebssystem lamp	Ø DR, Ø DA, Ø ET in mm	nLB	kg	Preis € price €
425001V	TC-D 1x 13W/VVG	Ø 185, Ø 165, 70	71%	1,6	61,30
425001E	TC-DEL 1x 13W/EVG	Ø 185, Ø 165, 70	71%	1,2	93,00
420001V	TC-D 1x 13W/VVG	Ø 185, Ø 165, 115	71%	1,5	50,30
420001E	TC-DEL 1x 13W/EVG	Ø 185, Ø 165, 115	71%	1,2	83,00
425002V	TC-D 1x 18W/VVG	Ø 185, Ø 165, 70	71%	1,6	61,30
425002E	TC-DEL 1x 18W/EVG	Ø 185, Ø 165, 70	71%	1,2	93,00
420002V	TC-D 1x 18W/VVG	Ø 185, Ø 165, 115	71%	1,5	50,30
420002E	TC-DEL 1x 18W/EVG	Ø 185, Ø 165, 115	71%	1,2	83,00
425707V	TC-T 1x 26W/VVG	Ø 185, Ø 165, 70	71%	1,5	64,70
425707E	TC-TEL 1x 26W/EVG	Ø 185, Ø 165, 70	71%	1,2	96,40
420707V	TC-T 1x 26W/VVG	Ø 185, Ø 165, 115	71%	1,5	59,50
420707E	TC-TEL 1x 26W/EVG	Ø 185, Ø 165, 115	71%	1,2	105,90
425003V	TC-D 2x 13W/VVG	Ø 185, Ø 165, 70	71%	1,3	62,70
425003E	TC-DEL 2x 13W/EVG	Ø 185, Ø 165, 70	71%	1,3	112,00
420003V	TC-D 2x 13W/VVG	Ø 185, Ø 165, 115	71%	1,6	52,80
420003E	TC-DEL 2x 13W/EVG	Ø 185, Ø 165, 115	71%	1,3	102,60
425008V	TC-D 2x 13W/VVG	Ø 185, Ø 165, 120	72%	1,8	73,70
425008E	TC-DEL 2x 13W/EVG	Ø 185, Ø 165, 120	72%	1,4	120,20
425004V	TC-D 2x 18W/VVG	Ø 185, Ø 165, 70	72%	1,3	62,70
425004E	TC-DEL 2x 18W/EVG	Ø 185, Ø 165, 70	72%	1,3	112,00
420004V	TC-D 2x 18W/VVG	Ø 185, Ø 165, 115	72%	1,6	52,80
420004E	TC-DEL 2x 18W/EVG	Ø 185, Ø 165, 115	72%	1,3	102,60
425009V	TC-D 2x 18W/VVG	Ø 185, Ø 165, 120	72%	1,9	73,70
425009E	TC-DEL 2x 18W/EVG	Ø 185, Ø 165, 120	72%	1,6	120,20

Downlights mit Ø 185mm (Deckenausschnitt 165mm) downlights with Ø 185mm (ceiling cut-out 165mm)

Einbaudownlight für Kompaktleuchtstofflampen (TC-D/TC-DEL, bzw. TC-T/TC-TEL). Stabiles Gehäuse mit angebaudem oder separatem Geräteträger aus verzinktem Stahlblech, grau pulverbeschichtet. Deckeneinbau werkzeuglos mittels Federmechanismus. Deckenring weiß pulverbeschichtet (alternative Farben auf Anfrage). Aluminiumreflektor hochglanz silber, Leuchtmittellage horizontal. Netzanschluss: Anschlussklemme bis 5x2,5mm² inkl. Zugentlastung. Durchgangsverdrahtung möglich. Schutzart IP20, Schutzklasse I, F-Zeichen

Recessed lighting fitting for compact fluorescent lamps (TC-D/TC-DEL, or rather TC-T/TC-TEL). Stable housing with attached or separate gear box made of zinc-plated steel panel, grey powder coated. Installation without tools by mounting springs. Ceiling ring white powder coated (alternative colours on request). Aluminium reflector highgloss silver, lamps in horizontal position. Power supply: Terminal clamp up to 5x2,5mm² incl. strain relief. Through wiring possible. degree of protection IP20, protection class I, F-sign

- 1.) Downlight mit angebauter VG-Box (Einbautiefe 115mm).
downlight incl. attached gear box (installation depth 115mm).
- 2.) Downlight mit separater VG-Box (Einbautiefe 70mm, bzw. 120mm).
downlight with separate gear box (installation depth 70mm, or rather 120mm).

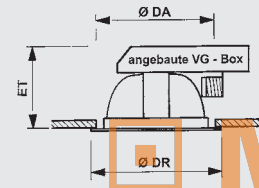

Hinweis / advice
Maximale Deckenstärke 12,5mm.
(ET 70 und 115mm)
Maximum slab thickness 12,5mm
(ET 70 und 115mm)

Technische Erläuterungen technical explanations

- nLB = Leuchtenbetriebswirkungsgrad
light output-ratio working
- Ø DR = Außendurchmesser - Deckenring
outer diameter - ceiling ring
- Ø DA = Deckenausschnitt
ceiling cut-out
- ET = Einbautiefe
installation depth
- kg = Gewicht in Kilogramm
weight in kg

Weiteres lieferbares Zubehör (auf Anfrage) / further accessories (on request)

- Dimmbares EVG (Schnittstelle 1-10V)
- dimmable electronic ballast (for 1-10V interface)
- Notlichtbausatz B (Einzelbatterie 1 oder 3 h)
- emergency kit B (single battery 1 or 3h)
- Notlichtbausatz E (Notlichtfassung E14, 1x 25W max.) (ab ET120mm)
- emergency kit E (emergency socket E14, 1x 25W max.)
- Werkseitige Kompensation
- factory-made compensation
- Dimmbares EVG DALI (digital) (ab Bestückung 18W)
- dimmable electronic ballast DALI (digital) (for 18W lamp)
- Einbauring in RAL (Farbton nach Wahl) pulverbeschichtet
- installation ring in RAL (colour on request) powder-coated
- Edelstahl-Dekoring
- stainless steel - deco ring
- Reflektor in Facetten Ausführung oder mattglanz silber
- reflector in facet or in satin silver
- Einputzring für Nassdecken (Rabitzdecken)
- mounting ring for wet ceilings (Rabitz ceilings)
- Entlastungselement für Mineralfaserdecken Modul 600 oder Modul 625
- release element for mineral fibre ceilings module 600 or module 625
- Modulplatte M100 weiß oder in RAL-Farbtönen nach Wahl
- module slab M100 white or in RAL-colour on request
- Betonarmatur
- mounting part for concrete ceilings

Ø 220 mm

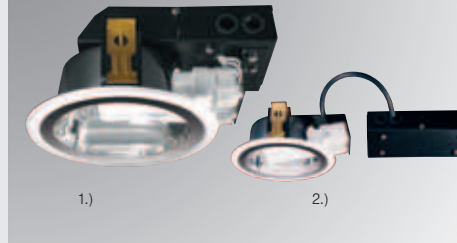

(ET 115mm)

Leuchtenbetriebswirkungsgrad = nLB 71/72%
light output ratio working = nLB 71/72%

Art.-Nr. art.-no.	Bestückung/Betriebssystem lamp	Ø DR, Ø DA, Ø ET in mm	nLB	kg	Preis € price €
430002V	TC-D 1x 26W/VVG	Ø 220, Ø 200, 115	71%	1,7	67,50
430002E	TC-DEL 1x 26W/EVG	Ø 220, Ø 200, 115	71%	1,4	105,60
430708E	TC-TEL 1x 32W/EVG	Ø 220, Ø 200, 185	72%	1,4	129,30
435003V	TC-D 2x 13W/VVG	Ø 220, Ø 200, 70	71%	1,8	73,70
435003E	TC-DEL 2x 13W/EVG	Ø 220, Ø 200, 70	71%	1,5	115,70
435009V	TC-D 2x 13W/VVG	Ø 220, Ø 200, 140	72%	2,1	80,30
435009E	TC-DEL 2x 13W/EVG	Ø 220, Ø 200, 140	72%	1,6	129,30
435004V	TC-D 2x 18W/VVG	Ø 220, Ø 200, 70	71%	1,9	73,70
435004E	TC-DEL 2x 18W/EVG	Ø 220, Ø 200, 70	71%	1,5	115,70
430004V	TC-D 2x 18W/VVG	Ø 220, Ø 200, 115	71%	1,7	62,70
430004E	TC-DEL 2x 18W/EVG	Ø 220, Ø 200, 115	71%	1,4	104,80
435010V	TC-D 2x 18W/VVG	Ø 220, Ø 200, 140	72%	2,1	80,30
435010E	TC-DEL 2x 18W/EVG	Ø 220, Ø 200, 140	72%	1,7	129,30
435005V	TC-D 2x 26W/VVG	Ø 220, Ø 200, 70	71%	2,1	76,10
435005E	TC-DEL 2x 26W/EVG	Ø 220, Ø 200, 70	71%	1,5	126,90
430005V	TC-D 2x 26W/VVG	Ø 220, Ø 200, 115	71%	2,0	66,30
430005E	TC-DEL 2x 26W/EVG	Ø 220, Ø 200, 115	71%	1,4	116,90
435011V	TC-D 2x 26W/VVG	Ø 220, Ø 200, 140	72%	2,2	81,70
435011E	TC-DEL 2x 26W/EVG	Ø 220, Ø 200, 140	72%	1,8	133,70

Downlights mit Ø 220mm (Deckenausschnitt 200mm) downlights with Ø 220mm (ceiling cut-out 200mm)

Einbaudownlight für Kompaktleuchtstofflampen (TC-D/TC-DEL, bzw. TC-TEL). Stabiles Gehäuse mit angebaudem oder separatem Geräteträger aus verzinktem Stahlblech, grau pulverbeschichtet. Deckeneinbau werkzeuglos mittels Federmechanismus. Deckenring weiß pulverbeschichtet (alternative Farben auf Anfrage). Aluminiumreflektor hochglanz silber, Leuchtmittellage horizontal. Netzanschluss: Anschlussklemme bis 5x2,5mm² inkl. Zugentlastung. Durchgangsverdrahtung möglich. Schutzart IP20, Schutzklasse I, F-Zeichen

Recessed lighting fitting for compact fluorescent lamps (TC-D/TC-DEL, or rather TC-TEL). Stable housing with attached or separate gear box made of zinc-plated steel panel, grey powder coated. Installation without tools by mounting springs. Ceiling ring white powder coated (alternative colours on request). Aluminium reflector highgloss silver, lamps in horizontal position. Power supply: Terminal clamp up to 5x2,5mm² incl. strain relief. Through wiring possible. degree of protection IP20, protection class I, F-sign

- 1.) Downlight mit angebauter VG-Box (Einbautiefe 115mm, bzw. 185).
downlight incl. attached gear box (installation depth 115mm, or rather 185).
- 2.) Downlight mit separater VG-Box (Einbautiefe 70mm, bzw. 140mm).
downlight with separate gear box (installation depth 70mm, or rather 120mm).

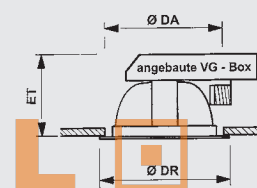

Hinweis / advice
Maximale Deckenstärke 12,5mm.
(Einbautiefe 70mm und 115mm).
max. slab thickness 12,5mm
(ET 70 und 115mm)

Technische Erläuterungen technical explanations

- nLB = Leuchtenbetriebswirkungsgrad
light output-ratio working
- Ø DR = Außendurchmesser - Deckenring
outer diameter - ceiling ring
- Ø DA = Deckenausschnitt
ceiling cut-out
- ET = Einbautiefe
installation depth
- kg = Gewicht in Kilogramm
weight in kg

Weiteres lieferbares Zubehör (auf Anfrage) / further accessories (on request)

- Dimmbares EVG (Schnittstelle 1-10V)
- dimmable electronic ballast (for 1-10V interface)
- Notlichtbausatz B (Einzelbatterie 1 oder 3 h)
- emergency kit B (single battery 1 or 3h)
- Notlichtbausatz E (Notlichtfassung E14, 1x 25W max.) (ab ET120mm)
- emergency kit E (emergency socket E14, 1x 25W max.)
- Werkseitige Kompensation
- factory-made compensation
- Dimmbares EVG DALI (digital) (ab Bestückung 18W)
- dimmable electronic ballast DALI (digital) (for 18W lamp)
- Einbauring in RAL (Farbton nach Wahl) pulverbeschichtet
- installation ring in RAL (colour on request) powder-coated
- Edelstahl-Dekoring
- stainless steel - deco ring
- Reflektor in Facetten Ausführung oder mattglanz silber
- reflector in facet or in satin silver
- Einputzring für Nassdecken (Rabitzdecken)
- mounting ring for wet ceilings (Rabitz ceilings)
- Entlastungselement für Mineralfaserdecken Modul 600 oder Modul 625
- release element for mineral fibre ceilings module 600 or module 625
- Modulplatte M100 weiß oder in RAL-Farbtönen nach Wahl
- module slab M100 white or in RAL-colour on request
- Betonarmatur
- mounting part for concrete ceilings

Ø 255 mm



Downlights mit Ø 255mm (Deckenausschnitt 235mm)
downlights with Ø 255mm (ceiling cut-out 235mm)

Einbaudownlight für Kompaktleuchtstofflampen (TC-D/TC-DEL, bzw. TC-T/TC-TEL). Stabiles Gehäuse mit angebaurem oder separatem Geräteträger aus verzinktem Stahlblech, grau pulverbeschichtet. Deckeneinbau werkzeuglos mittels Federmechanismus. Deckenring weiß pulverbeschichtet (alternative Farben auf Anfrage). Aluminiumreflektor hochglanz silber, Leuchtmittellage horizontal. Netzanschluss: Anschlussklemme bis 5x2,5mm² inkl. Zugentlastung. Durchgangsverdrahtung möglich. Schutzart IP20, Schutzklasse I, F-Zeichen

Recessed lighting fitting for compact fluorescent lamps (TC-D/TC-DEL, or rather TC-T/TC-TEL). Stable housing with attached or separate gear box made of zinc-plated steel panel, grey powder coated. Installation without tools by mounting springs. Ceiling ring white powder coated (alternative colours on request). Aluminium reflector highgloss silver, lamps in horizontal position. Power supply: Terminal clamp up to 5x2,5mm² incl. strain relief. Through wiring possible. Degree of protection IP20, protection class I, F-sign

- 1.) Downlight mit angebauter VG-Box (Einbautiefe 195mm).
downlight incl. attached gear box (installation depth 195mm).
- 2.) Downlight mit separater VG-Box (Einbautiefe 125mm, bzw. 160mm).
downlight with separate gear box (installation depth 125mm, or rather 160mm).

Acrylring farbig, orange (siehe Seite 321)
coloured acryl ring, orange (pls. comp. page 321)

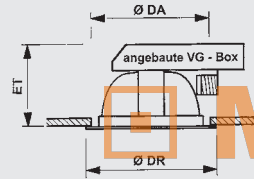

Leuchtenbetriebswirkungsgrad = nLB 72%
light output ratio working = nLB 72%

Technische Erläuterungen
technical explanations

- nLB = Leuchtenbetriebswirkungsgrad
light output-ratio working
- Ø DR = Außendurchmesser - Deckenring
outer diameter - ceiling ring
- Ø DA = Deckenausschnitt
ceiling cut-out
- ET = Einbautiefe
installation depth
- kg = Gewicht in Kilogramm
weight in kg

Art.-Nr. art.-no.	Bestückung/Betriebssystem lamp	Ø DR, Ø DA, Ø ET in mm	nLB	kg	Preis € price €
445705V	TC-D/TC-T 2x 26W/VVG	Ø 255, Ø 235, 160	72%	2,2	88,70
445705E	TC-T/TC-TEL 2x 26W/EVG	Ø 255, Ø 235, 160	72%	2,0	150,60
440705V	TC-D/ TC-T 2x 26W/VVG	Ø 255, Ø 235, 195	72%	2,0	82,50
440705E	TC-DEL/TC-TEL 2x 26W/EVG	Ø 255, Ø 235, 195	72%	1,8	140,50
445725E	TC-TEL 2x 26-42W/EVG	Ø 255, Ø 235, 125	72%	1,8	146,90

Weiteres lieferbares Zubehör (auf Anfrage) / further accessories (on request)

- Dimmbares EVG (Schnittstelle 1-10V)
- dimmable electronic ballast (for 1-10V interface)
- Notlichtbausatz B (Einzelbatterie 1 oder 3 h)
- emergency kit B (single battery 1 or 3h)
- Notlichtbausatz E (Notlichtfassung E14, 1x 25W max.)
- emergency kit E (emergency socket E14, 1x 25W max.)
- Werkseitige Kompensation
- factory-made compensation
- Dimmbares EVG DALI (digital)
- dimmable electronic ballast DALI (digital)
- Einbauring in RAL (Farbton nach Wahl) pulverbeschichtet
- installation ring in RAL (colour on request) powder-coated
- Edelstahl-Dekoring
- stainless steel - deco ring
- Reflektor in Facetten Ausführung oder mattglanz silber
- reflector in facet or in satin silver
- Einputzring für Nassdecken (Rabitzdecken)
- mounting ring for wet ceilings (Rabitz ceilings)
- Entlastungselement für Mineralfaserdecken Modul 600 oder Modul 625
- release element for mineral fibre ceilings module 600 or module 625
- Modulplatte M100 weiß oder in RAL-Farbtönen nach Wahl
- module slab M100 white or in RAL-colour on request
- Betonarmatur
- mounting part for concrete ceilings



Kindertagesstätte, Hamburg

MODUL
ELECTRO
www.modulelectro.ru

Ausstattungs-elemente / attachments

für die Produkte auf den Seiten 322-324
for products on the pages 322-324



Artikel-Nr. / article-no.	Preis € / price €
N185SZ2	€ 37,90
N220SZ2	€ 42,50
N255SZ2	€ 47,10

Floatglassscheibe teilmattiert / float glass partially frosted



Artikel-Nr. / article-no.	Preis € / price €
N185RS1	€ 37,90
N220RS1	€ 42,50
N255RS1	€ 47,10

Floatglasring vollmattiert / floatglassring completely frosted

Die Gläser N_SZ2 und N_RS1 sind auch in vollmattiert oder klar, bzw. teilmattiert oder klar lieferbar.
The glasses N_SZ2 and N_RS1 are also available in completely frosted or clear respectively partly frosted or clear.

Für die Größenfestlegung ist immer der Außendurchmesser der Leuchte maßgeblich
(also z.B. N185... für Leuchten mit Durchmesser 185mm).
To determine the size, the outer diameter of the luminaire is decisive (e.g. N185... for luminaires with a diameter of 185mm).

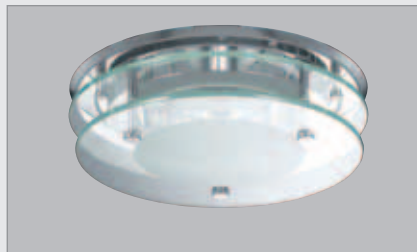

Artikel-Nr. / article-no.	Preis € / price €
N185SER	€ 56,80
N220SER	€ 66,50
N255SER	€ 69,90

Floatglas doppelt, teilmattiert, Dekoring Edelstahl
floatglass double, partially frosted,
deco ring stainless steel



Artikel-Nr. / article-no.	Preis € / price €
N185TUR	€ 57,90
N220TUR	€ 64,90
N255TUR	€ 67,60

Turboraster, hochglanz silber / turbo louvre, highgloss silver



Artikel-Nr. / article-no.	Preis € / price €
N185KRR	€ 42,50
N220KRR	€ 47,10
N255KRR	€ 49,70

Einsetzbar ab Einbautiefe 120mm
applicable for installation depth 120mm

Ausstattungs-elemente / attachments

für die Produkte auf den Seiten 322-324
for products on the pages 322-324



Artikel-Nr. / article-no.	Preis € / price €
N185ARO	€ 27,80
N220ARO	€ 34,50
N255ARO	€ 38,50

Acrylring farbig, opal / coloured acryl ring, opal



Artikel-Nr. / article-no.	Preis € / price €
N185ARB	€ 27,80
N220ARB	€ 34,50
N255ARB	€ 38,50

Acrylring farbig, blau / coloured acryl ring, blue



Artikel-Nr. / article-no.	Preis € / price €
N185ARY	€ 27,80
N220ARY	€ 34,50
N255ARY	€ 38,50

Acrylring farbig, orange / coloured acryl ring, orange

Die Acrylringe farbig sind auf Anfrage auch in den Farben rot, gelb und grün lieferbar.

The coloured acryl rings are also available in the colours red, yellow and green.

MODUL
ELECTRO
www.modulelectro.ru





N220LNT / N220LWT

N220LNB / N220LNW

Artikel-Nr. article-no.	Farbe colour	Preis € price €
N220LNT	nickel matt nickel satin	€ 119,00
N220LWT	weiß white	€ 99,00

Artikel-Nr. article-no.	Lichtfarbe lightcolour	Preis € price €
N220LNB	blau blue	€ 84,00
N220LNW	weiß white	€ 84,00

Nachrüstbare Lichtoptik mit 18 Radial-LEDs
retrofitable light optic with 18 Radial-LEDs

Nachrüstbare Lichtoptik mit 18 Radial-LEDs
retrofitable light optic with 18 Radial-LEDs

Material: Aluminium
material: aluminium
Schutzklasse: II
protection class: II
Schutzart: IP20
degree of protection: IP20
Maße: D240xAL15mm
dimensions: D240xH15mm

Material: Aluminium
material: aluminium
Schutzklasse: II
protection class: II
Schutzart: IP20
degree of protection: IP20
Maße: D240xAL15mm
dimensions: D240xH15mm

Automatischer RGB-Farbdurchlauf (Rot-Grün-Blau).

Lieferung inkl. sep. Konverter für LEDs.
Nachrüstbar an BRUMBERG-Downlights 430002E, 430002V, 435003E, 435003V, 435004E, 435004V, 430004V; 430004E, 435005E; 435005V, 430005E und 430005V.
Mit zwei 230V-Anschlüssen ist ein separater Betrieb (Kompaktleuchtstofflampe/LED) möglich.

Lieferung inkl. sep. Konverter für LEDs.
Nachrüstbar an BRUMBERG-Downlights 430002E, 430002V, 435003E, 435003V, 435004E, 435004V, 430004V; 430004E, 435005E; 435005V, 430005E und 430005V.
Mit zwei 230V-Anschlüssen ist ein separater Betrieb (Kompaktleuchtstofflampe/LED) möglich.

automatic RGB-colourchange (red-green-blue).

delivery incl. sep. converter for LED.
retrofitable on BRUMBERG-downlights 430002E, 430002V, 435003E, 435003V, 435004E, 435004V, 430004V; 430004E, 435005E; 435005V, 430005E und 430005V.
separate circuit possible by two 230V-connection (compact fluorescent lamp/LED).

delivery incl. sep. converter for LED.
retrofitable on BRUMBERG-downlights 430002E, 430002V, 435003E, 435003V, 435004E, 435004V, 430004V; 430004E, 435005E; 435005V, 430005E und 430005V.
separate circuit possible by two 230V-connection (compact fluorescent lamp/LED).



N220LWW / N220LWB

Artikel-Nr. article-no.	Lichtfarbe lightcolour	Preis € price €
N220LWW	weiß white	€ 69,00
N220LWB	blau blue	€ 69,00

Nachrüstbare Lichtoptik mit 18 Radial-LEDs
retrofitable light optic with 18 Radial-LEDs

Material: Aluminium
material: aluminium
Schutzklasse: II
protection class: II
Schutzart: IP20
degree of protection: IP20
Maße: D240xAL15mm
dimensions: D240xH15mm

Lieferung inkl. sep. Konverter für LEDs.
Nachrüstbar an BRUMBERG-Downlights 430002E, 430002V, 435003E, 435003V, 435004E, 435004V, 430004V; 430004E, 435005E; 435005V, 430005E und 430005V.
Mit zwei 230V-Anschlüssen ist ein separater Betrieb (Kompaktleuchtstofflampe/LED) möglich.

delivery incl. sep. converter for LED.
retrofitable on BRUMBERG-downlights 430002E, 430002V, 435003E, 435003V, 435004E, 435004V, 430004V; 430004E, 435005E; 435005V, 430005E und 430005V.
separate circuit possible by two 230V-connection (compact fluorescent lamp/LED).

Zusätzliche Glasabdeckungen für Downlights mit LED-Ring (nur für 2-lampige Leuchten, Mittelbefestigung)
additional glass-covers for downlights with LED-Ring (only for illuminants with 2 lamps, centered fixture)



N220LGK € 35,80

Schutzglas klar als weiteres Ausstattungsteil
protection glass clear as further equipment

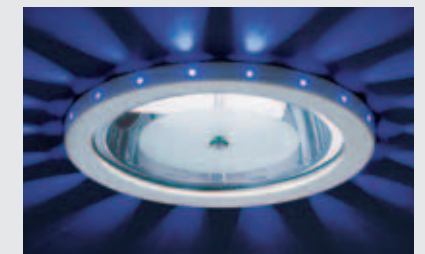

N220LGT € 35,80

Schutzglas teilmattiert als weiteres Ausstattungsteil
protection glass partially frosted as further equipment



N220LGM € 35,80

Schutzglas vollmattiert als weiteres Ausstattungsteil
protection glass completely frosted as further equipment

Schutzart IP44

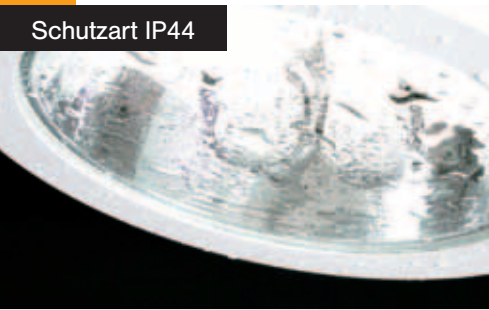

Spritzwassergeschützt / splash-proof

Einbaudownlight für Kompaktleuchtstofflampen (TC-D / TC-DEL, bzw. TC-T / TC-TEL) mit Schutzglas klar, Dekoring weiß, Schutzart IP44 (bei Einbau in geschlossene Decken). Die Befestigung des Glases erfolgt über Bajonettverschluss. Dekoring weiß pulverbeschichtet (alternative Farben auf Anfrage). Aluminiumreflektor hochglanz silber, Leuchtmittellage horizontal. Netzanschluss: Anschlussklemme bis 5x2,5mm² inkl. Zugentlastung. Durchgangsverdrahtung möglich. Schutzklasse I, F-Zeichen

Recessed lighting fitting for compact fluorescent lamps (TC-D / TC-DEL, or rather TC-T / TC-TEL) with protection glass clear, deco ring white, degree of protection IP44 (installation in closed ceilings). Fastening of the glass by bayonet fixing. Deco ring white powdercoated (alternative colours on request). aluminium reflector highgloss silver, lamps in horizontal position. Power supply: Terminal clamp up to 5x2,5mm² incl. strain relief. Through wiring possible. Protection class I, F-sign



Hinweis / advice

Maximale Deckenstärke 12,5mm (Einbautiefe 115mm).
max.slab thickness 12,5mm (installation depth 115mm).

Leuchtenbetriebswirkungsgrad = nLB 71%.
light output ratio working = nLB 71%.

Downlight auf Anfrage auch mit separater VG-Box, bzw. mit anderen Einbautiefen und Bestückungen lieferbar.
downlight also available incl. separate gear box, or rather with other installations depth or other lamps.

Artikel 445425E serienmäßig mit separater EVG-Box.
article 445425E serially with separate gear box.

Das Schutzglas ist auf Anfrage auch in vollmattierter oder teilmatterter Ausführung lieferbar.
The protection glass is also available in completely or partially frosted version.

Art.-Nr. art.-no.	Bestückung/Betriebssystem lamp	Ø DR, Ø DA, Ø ET in mm	nLB	kg	Preis € price €
420413V	TC-D 2x 13W/VVG	Ø 185, Ø 165, 115	71%	1,8	94,30
420413E	TC-DEL 2x 13W/EVG	Ø 185, Ø 165, 115	71%	1,5	144,90
420414V	TC-D 2x 18W/VVG	Ø 185, Ø 165, 115	71%	1,8	94,30
420414E	TC-DEL 2x 18W/EVG	Ø 185, Ø 165, 115	71%	1,5	144,90
430415V	TC-D 2x 26W/VVG	Ø 220, Ø 200, 115	71%	2,2	110,00
430415E	TC-DEL 2x 26W/EVG	Ø 220, Ø 200, 115	71%	1,6	160,60
445425E	TC-TEL 2x 26-42W/EVG	Ø 255, Ø 235, 125	71%	1,9	197,20

Weiteres lieferbares Zubehör (auf Anfrage) / further accessories (on request)

- Dimmbares EVG (Schnittstelle 1-10V)
- dimmable electronic ballast (for 1-10V interface)
- Notlichtbausatz B (Einzelbatterie 1 oder 3 h)
- emergency kit B (single battery 1 or 3h)
- Werkseitige Kompensation
- factory-made compensation
- Dimmbares EVG DALI (digital) (ab Bestückung 18W)
- dimmable electronic ballast DALI (digital) (for 18W lamp)
- Dekobauring in RAL (Farbton nach Wahl) pulverbeschichtet
- Deco ring in RAL (colour on request) powder-coated

- Reflektor in Facettenoptik oder in Ausführung mattglanz silber
- reflector in facet optic or in satin silver
- Einputzring für Nassdecken (Rabitzdecken)
- mounting ring for wet ceilings (Rabitz ceilings)

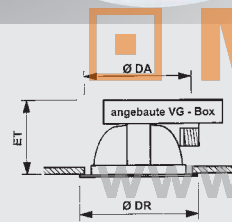

Technische Erläuterungen
technical explanations

- nLB = Leuchtenbetriebswirkungsgrad
light output-ratio working
- Ø DR = Außendurchmesser - Deckenring
outer diameter - ceiling ring
- Ø DA = Deckenausschnitt
ceiling cut-out
- ET = Einbautiefe
installation depth
- kg = Gewicht in Kilogramm
weight in kg

Downlights mit Reflektorsystem & Farbring
downlights with reflectorsystem & coloured ring

Einbaudownlight für Kompaktleuchtstofflampen (TC-T/TC-TEL). Stabiles Gehäuse mit separatem Geräteträger aus verzinktem Stahlblech, grau pulverbeschichtet. Deckeneinbau werkzeuglos mittels Federmechanismus. Dekoring alu matt pulverbeschichtet (alternative Farben auf Anfrage). Befestigung des Dekorings über Bajonettverschluss. Reflektor-System aus Aluminium (hochglanz silber). Leuchtmittellage horizontal. Anschlussklemme bis 5x 2,5mm² inkl. Zugentlastung. Durchgangsverdrahtung möglich. Schutzart IP20, Schutzklasse I, F-Zeichen

Recessed lighting fitting for compact fluorescent lamps (TC-T/TC-TEL). Stable housing separate gear box made of zinc-plated steel panel, grey powder coated. Installation without tools by mounting springs. deco ring alu matt powder coated (alternative colours on request). Fastening of the deco ring by bayonet fixing. Reflector-system in aluminium (highgloss silver). Lamps in horizontal position. Terminal clamp up to 5x 2,5mm² incl. strain relief. Through wiring possible. degree of protection IP20, protection class I, F-sign

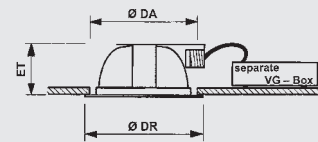

Technische Erläuterungen
technical explanations

- Ø DR = Außendurchmesser - Deckenring
outer diameter - ceiling ring
- Ø DA = Deckenausschnitt
ceiling cut-out
- ET = Einbautiefe
installation depth
- kg = Gewicht in Kilogramm
weight in kg

Weiteres lieferbares Zubehör (auf Anfrage) / further accessories (on request)

- Dimmbares EVG (Schnittstelle 1-10V)
- dimmable electronic ballast (for 1-10V interface)
- Notlichtbausatz B (Einzelbatterie 1 oder 3 h)
- emergency kit B (single battery 1 or 3h)
- Notlichtbausatz E (Notlichtfassung E14, 1x 25W max.)
- emergency kit E (emergency socket E14, 1x 25W max.)
- Werkseitige Kompensation
- factory-made compensation
- Dimmbares EVG DALI (digital)
- dimmable electronic ballast DALI (digital)
- Einbauring in RAL (Farbton nach Wahl) pulverbeschichtet
- installation ring in RAL (colour on request) powder-coated
- Reflektoren in Ausführung mattglanz silber
- reflector in satin silver
- Einputzring für Nassdecken (Rabitzdecken)
- mounting ring for wet ceilings (Rabitz ceilings)
- Entlastungselement für Mineralfaserdecken Modul 600 oder Modul 625
- release element for mineral fibre ceilings module 600 or module 625
- Modulplatte M100 weiß oder in RAL-Farbton nach Wahl
- module slab M100 white or in RAL-colour on request
- auch mit angebaurem VVG oder EVG lieferbar
- also available with attached low loss ballast or electronic ballast
- als Projektausführung auch mit Prismenring (statt Farbring) lieferbar
- as project version also available with prism ring (instead of coloured ring)
- Farbring auch in den Farben rot, gelb und grün lieferbar
- coloured ring also available in red, yellow and green

Reflektorsystem / reflectorsystem

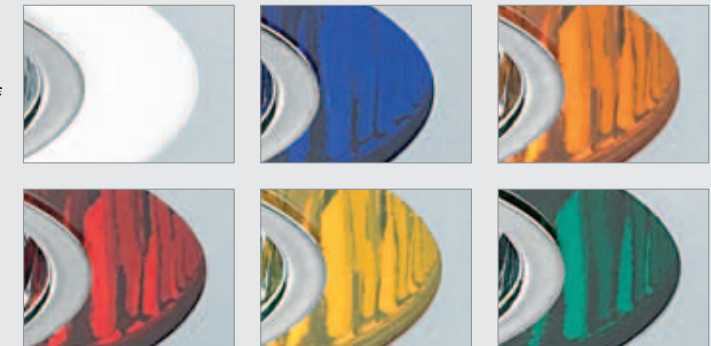

Art.-Nr. art.-no.	Bestückung/Betriebssystem lamp	Ø DR, Ø DA, Ø ET in mm	Farbring	kg	Preis € price €
435022V	TC-T 2x 18W/VVG	Ø 220, Ø 200, 140	opal	2,8	131,50
435022E	TC-TEL 2x 18W/EVG	Ø 220, Ø 200, 140	opal	1,9	184,30
435032V	TC-T 2x 18W/VVG	Ø 220, Ø 200, 140	blau	2,8	131,50
435032E	TC-TEL 2x 18W/EVG	Ø 220, Ø 200, 140	blau	1,9	184,30
435062V	TC-T 2x 18W/VVG	Ø 220, Ø 200, 140	orange	2,8	131,50
435062E	TC-TEL 2x 18W/EVG	Ø 220, Ø 200, 140	orange	1,9	184,30
435021V	TC-T 2x 26W/EVG	Ø 220, Ø 200, 140	opal	2,8	133,70
435021E	TC-TEL 2x 26W/EVG	Ø 220, Ø 200, 140	opal	1,9	188,80
435031E	TC-T 2x 26W/EVG	Ø 220, Ø 200, 140	blau	2,8	133,70
435031V	TC-TEL 2x 26W/EVG	Ø 220, Ø 200, 140	blau	1,9	188,80
435061V	TC-T 2x 26W/VVG	Ø 220, Ø 200, 140	orange	2,8	133,70
435061E	TC-TEL 2x 26W/EVG	Ø 220, Ø 200, 140	orange	1,9	188,80

485904E + F195ABC



Artikel-Nr. / article-no.	Preis € / price €	
485904E	€ 103,00	Gesamtpreis: € 131,70 Amount: € 131,70
F195ABC	€ 28,70	

Einbauleuchte weiß mit Abdeckung opal, Zierring chrom, Acrylflanke blau
recessed luminaire, white with opal cover, ornamental ring in chrome acrylic shoulder blue

Für Bestückung: 2x TC-DEL 18W G24q-2
for lamp: 2x TC-DEL 18W G24q-2

Material: Eisen / Acryl
material: iron / acryl

Farbe: weiß / opal / chrom
colour: white / opal / chrome

Schutzklasse: I
protection class: I

Schutzart: IP20
degree of protection: IP20

Maße: D195xDA185xET90xAL30mm
mit EVG in separater EVG-Box
dimensions: D195xDA185x depth 90x projection 30mm
with electronic ballast in separate gear box

485904E + F195ROC



Artikel-Nr. / article-no.	Preis € / price €	
485904E	€ 103,00	Gesamtpreis: € 144,40 Amount: € 144,40
F195ROC	€ 41,40	

Einbauleuchte weiß mit Abdeckung opal, Zierring chrom, Mittelreflektor hochglanz silber, Acrylflanke opal
recessed luminaire, white with opal cover, ornamental ring in chrome middle reflector highgloss silver, acrylic shoulder opal

Für Bestückung: 2x TC-DEL 18W G24q-2
for lamp: 2x TC-DEL 18W G24q-2

Material: Eisen / Acryl / Aluminium
material: iron / acryl / aluminium

Farbe: weiß / opal / chrom
colour: white / opal / chrome

Schutzklasse: I
protection class: I

Schutzart: IP20
degree of protection: IP20

Maße: D195xDA185xET90xAL30mm
mit EVG in separater EVG-Box
dimensions: D195xDA185x depth 90x projection 30mm
with electronic ballast in separate gear box

485904E + F195AOC



Artikel-Nr. / article-no.	Preis € / price €	
485904E	€ 103,00	Gesamtpreis: € 131,70 Amount: € 131,70
F195AOC	€ 28,70	

Einbauleuchte weiß mit Abdeckung opal, Zierring chrom, Acrylflanke opal
recessed luminaire, white with opal cover, ornamental ring in chrome acrylic shoulder opal

Für Bestückung: 2x TC-DEL 18W G24q-2
for lamp: 2x TC-DEL 18W G24q-2

Material: Eisen / Acryl
material: iron / acryl

Farbe: weiß / opal / chrom
colour: white / opal / chrome

Schutzklasse: I
protection class: I

Schutzart: IP20
degree of protection: IP20

Maße: D195xDA185xET90xAL30mm
mit EVG in separater EVG-Box
dimensions: D195xDA185x depth 90x projection 30mm
with electronic ballast in separate gear box

485904E + F195AYC



Artikel-Nr. / article-no.	Preis € / price €	
485904E	€ 103,00	Gesamtpreis: € 131,70 Amount: € 131,70
F195AYC	€ 28,70	

Einbauleuchte weiß mit Abdeckung opal, Zierring chrom, Acrylflanke orange
recessed luminaire, white with opal cover, ornamental ring in chrome acrylic shoulder orange

Für Bestückung: 2x TC-DEL 18W G24q-2
for lamp: 2x TC-DEL 18W G24q-2

Material: Eisen / Acryl
material: iron / acryl

Farbe: weiß / opal / chrom
colour: white / opal / chrome

Schutzklasse: I
protection class: I

Schutzart: IP20
degree of protection: IP20

Maße: D195xDA185xET90xAL30mm
mit EVG in separater EVG-Box
dimensions: D195xDA185x depth 90x projection 30mm
with electronic ballast in separate gear box

Downlights mit Bajonettwechseltechnik
downlights with bayonet-change-technic

Einbaudownlight für Kompaktleuchtstofflampen (TC-D / TC-DEL, bzw. TC-T/TC-TEL). Stabiles Gehäuse mit angebaute Geräterträger aus verzinktem Stahlblech, grau pulverbeschichtet. Deckeneinbau werkzeuglos mittels Federmechanismus. Befestigung des Standardrings oder von lichtoptischen Ausstattungsteilen (siehe Folgeseiten) nach Wahl über Bajonettbefestigung. Standardring weiß pulverbeschichtet (alternative Farben auf Anfrage). Aluminiumreflektor hochglanz silber, Leuchtmittellage horizontal. Netzanschluss: Anschlussklemme bis 5x2,5mm² inkl. Zugentlastung. Durchgangsverdrahtung möglich. Schutzart IP20, Schutzklasse I, F-Zeichen, bei Verwendung von geschlossenen lichtoptischen Ausstattungsteilen Schutzart IP44 (bei Einbau in geschlossene Decken).

Recessed lighting fitting for compact fluorescent lamps (TC-D / TC-DEL, or rather TC-T/TC-TEL). Stable housing with attached gear box made of zinc-plated steel panel, grey powder coated. Installation without tools by mounting springs. Mounting of standard ring or other optical attachments (see next pages) by bayonet fixing. Standard ring white powder coated (alternative colours on request), aluminium reflector highgloss silver, lamps in horizontal position. Power supply: Terminal clamp up to 5x2,5mm² incl. strain relief. Through wiring possible. degree of protection IP20, protection class I, F-sign, when using closed optical attachments degree of protection IP44 (installation in closed ceilings).

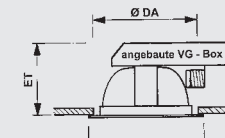

Artikel-Nr. / article-no.	Preis € / price €
B185SRW	€ 16,20
B220SRW	€ 20,30
B255SRW	€ 24,40

Standardring, weiß, Bajonettbefestigung (bitte zusätzlich bestellen)
standard ring, white, bayonet-system (please order additionally)

Technische Erläuterungen
technical explanations

- nLB = Leuchtenbetriebswirkungsgrad
light output-ratio working
- Ø DR = Außendurchmesser - Deckenring
outer diameter - ceiling ring
- Ø DA = Deckenausschnitt
ceiling cut-out
- ET = Einbautiefe
installation depth
- kg = Gewicht in Kilogramm
weight in kg

Weiteres lieferbares Zubehör (auf Anfrage) / further accessories (on request)

- Dimmbares EVG (Schnittstelle 1-10V) (ab Bestückung 18W)
- dimmable electronic ballast (for 1-10V interface)
- Notlichtbausatz B (Einzelbatterie 1 oder 3 h)
- emergency kit B (single battery 1 or 3h)
- Werkseitige Kompensation
- factory-made compensation
- Dimmbares EVG DALI (digital) (ab Bestückung 18W)
- dimmable electronic ballast DALI (digital) (for 18W lamp)
- Dekoring in RAL (Farbton nach Wahl) pulverbeschichtet
- Deco ring in RAL (colour on request) powder-coated
- Reflektor in Facettenoptik oder in Ausführung mattglanz silber
- reflector in facet optic or in satin silver
- Einputzring für Nassdecken (Rabitzdecken)
- mounting ring for wet ceilings (Rabitz ceilings)
- Entlastungselement für Mineralfaserdecken Modul 600 oder Modul 625
- release element for mineral fibre ceilings module 600 or module 625
- Modulplatte M100 weiß oder in RAL-Farbton nach Wahl
- module slab M100 white or in RAL-colour on request
- Betonarmatur (ET 115)
- mounting part for concrete ceilings (ET 115)

Bajonettssystem / bayonet-system



(ET 115mm)

Hinweis / advice

Maximale Deckenstärke 12,5mm (Einbautiefe 115mm).
max. slab thickness 12,5mm (installation depth 115mm).

Leuchtenbetriebswirkungsgrad = nLB 71% / nLB 72%.
light output ratio working = nLB 71% / nLB 72%.

Die Leuchten mit ET 115mm sind auch mit ET 70mm und 120mm (separater Geräterträger) und 160mm (angebaute Geräterträger) lieferbar. 445625E serienmäßig mit separatem Geräterträger.
Advice: Lightings with an installation depth of 115mm are also available with an installation depth of 70mm and 120mm (separate carrier) and 160mm (attached carrier). 445625E is serially with separate carrier.

Art.-Nr. art.-no.	Bestückung / Betriebssystem lamp	Ø DR, Ø DA, Ø ET in mm	nLB	kg	Preis € price €
420601V	TC-D 1x 13W/VVG	Ø 185, Ø 165, 115	71%	1,5	52,60
420601E	TC-DEL 1x 13W/EVG	Ø 185, Ø 165, 115	71%	1,2	85,20
420602V	TC-D 1x 18W/VVG	Ø 185, Ø 165, 115	71%	1,5	52,60
420602E	TC-DEL 2x 18W/EVG	Ø 185, Ø 165, 115	71%	1,2	85,2
420607V	TC-T 1x 26W/VVG	Ø 185, Ø 165, 115	71%	1,5	61,80
420607E	TC-TEL 1x 26W/EVG	Ø 185, Ø 165, 115	71%	1,2	108,20
420603V	TC-D 2x 13W/VVG	Ø 185, Ø 165, 115	71%	1,4	55,00
420603E	TC-DEL 2x 13W/EVG	Ø 185, Ø 165, 115	71%	1,2	104,80
420604V	TC-D 2x 18W/VVG	Ø 185, Ø 165, 115	71%	1,5	55,00
420604E	TC-DEL 2x 18W/EVG	Ø 185, Ø 165, 115	71%	1,2	104,80
430603V	TC-DEL 2x 13W/EVG	Ø 220, Ø 200, 115	71%	1,6	66,00
430603E	TC-D 2x 13W/VVG	Ø 220, Ø 200, 115	71%	1,4	108,20
430604V	TC-DEL 2x 18W/EVG	Ø 220, Ø 200, 115	71%	1,7	66,00
430604E	TC-D 2x 18W/VVG	Ø 220, Ø 200, 115	71%	1,4	108,20
430605V	TC-DEL 2x 26W/EVG	Ø 220, Ø 200, 115	71%	2,0	69,60
430605E	TC-D 2x 26W/VVG	Ø 220, Ø 200, 115	71%	1,4	120,20
445625E	TC-TEL 2x 26-42W/EVG	Ø 255, Ø 235, 125	71%	1,8	149,10

Ausstattungs-elemente / attachments

für die Produkte auf der Seite 333 / for products on the page 333

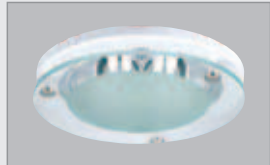

Art-Nr. / art.-no. B185SZ2* € 39,90
 Art-Nr. / art.-no. B220SZ2* € 44,50
 Art-Nr. / art.-no. B255SZ2* € 48,30

Floatglasscheibe teilmattiert (innen),
 Bajonettring weiß
 float glass partially frosted (inside),
 bayonet ring white

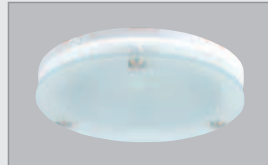

Art-Nr. / art.-no. B185SZ1* € 39,90
 Art-Nr. / art.-no. B220SZ1* € 44,50
 Art-Nr. / art.-no. B255SZ1* € 48,30

Floatglasscheibe vollmattiert,
 Bajonettring weiß
 float glass completely frosted,
 bayonet ring white

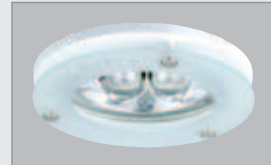

Art-Nr. / art.-no. B185RS1* € 39,90
 Art-Nr. / art.-no. B220RS1* € 44,50
 Art-Nr. / art.-no. B255RS1* € 48,30

Floatglasring vollmattiert,
 Bajonettring weiß
 float glassring completely frosted,
 bayonet ring white



Art-Nr. / art.-no. B185ARB* € 29,80
 Art-Nr. / art.-no. B220ARB* € 33,10
 Art-Nr. / art.-no. B255ARB* € 35,80

Acrylring blau, Bajonettring weiß
 acryl ring blue, bayonet ring white



Art-Nr. / art.-no. B185ARO* € 29,80
 Art-Nr. / art.-no. B220ARO* € 33,10
 Art-Nr. / art.-no. B255ARO* € 35,80

Acrylring opal, Bajonettring weiß
 acryl ring opal, bayonet ring white



Art-Nr. / art.-no. B185ARY* € 29,80
 Art-Nr. / art.-no. B220ARY* € 33,10
 Art-Nr. / art.-no. B255ARY* € 35,80

Acrylring orange, Bajonettring weiß
 acryl ring orange, bayonet ring white



IP44
 Art-Nr. / art.-no. B185ESM € 41,60
 Art-Nr. / art.-no. B220ESM € 44,60
 Art-Nr. / art.-no. B255ESM € 48,10

Schutzglas vollmattiert,
 Bajonettring weiß
 protection glass completely frosted,
 bayonet ring white



IP44
 Art-Nr. / art.-no. B185ESK € 41,60
 Art-Nr. / art.-no. B220ESK € 44,60
 Art-Nr. / art.-no. B255ESK € 48,10

Schutzglas klar, Bajonettring weiß
 protection glass clear, bayonet ring white

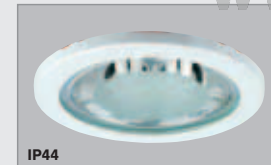

IP44
 Art-Nr. / art.-no. B185EST € 41,60
 Art-Nr. / art.-no. B220EST € 44,60
 Art-Nr. / art.-no. B255EST € 48,10

Schutzglas teilmattiert (innen),
 Bajonettring weiß
 protection glass partially frosted
 (inside), bayonet ring white

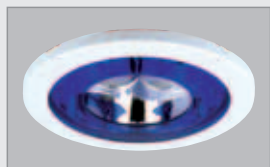

Art-Nr. / art.-no. B185PRB € 33,20
 Art-Nr. / art.-no. B220PRB € 37,50
 Art-Nr. v art.-no. B255PRB € 42,10

Prunellering blau, Bajonettring weiß
 prunelle ring blue, bayonet ring white

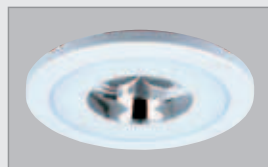

Art-Nr. / art.-no. B185PRO € 33,20
 Art-Nr. / art.-no. B220PRO € 37,50
 Art-Nr. / art.-no. B255PRO € 42,10

Prunellering opal, Bajonettring weiß
 prunelle ring opal, bayonet ring white

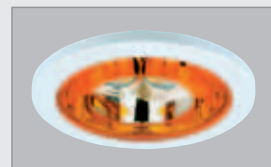

Art-Nr. / art.-no. B185PRY € 33,20
 Art-Nr. / art.-no. B220PRY € 37,50
 Art-Nr. / art.-no. B255PRY € 42,10

Prunellering orange, Bajonettring weiß
 prunelle ring orange, bayonet ring white

MODUL
ELECTRO
www.modulelectro.ru

Ausstattungs-elemente / attachments

für die Produkte auf der Seite 333 / for products on the page 333



Kindertagesstätte, Hamburg



IP44
 Art-Nr. / art.-no. B185AKO € 49,00

Acrylkalotte opal, Bajonettring weiß
 acryl calotte opal, bayonet ring white



IP44
 Art-Nr. / art.-no. B185AOP € 29,80
 Art-Nr. / art.-no. B220AOP € 33,10
 Art-Nr. / art.-no. B255AOP € 35,80

Acrylscheibe opal, Bajonettring weiß
 acryl plate opal, bayonet ring white

Hinweis / advice

Ab einer Einbautiefe von 120mm ist es möglich, zusätzlich ein Kreuz- oder Turboraster hochglanz silber in die Leuchte zu integrieren.
 As from installation depth of 120mm it is possible to integrate an additional cross or turbo louvre highgloss silver into the fixture.

Für die Größenfestlegung ist immer der Außendurchmesser der Leuchte maßgeblich
 (also z.B. B185... für Leuchten mit Durchmesser 185mm).
 To appoint the size the outer diameter of the lighting is significant.
 (e.g. B185... for lightings with a diameter of 185mm)

* Auch lieferbar mit zusätzlichem Schutzglas klar (IP44 - bei Einbau in geschlossene Decken)
 * also available with additional protection glass clear (IP44 - installation in closed ceilings)

Quadratisch / square

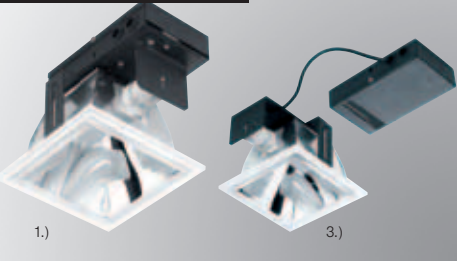

1.) 3.)



Quadratische Downlights / square downlights

Einbaudownlight für Kompaktleuchtstofflampen (TC-D/TC-DEL, bzw. TC-T/TC-TEL). Stabiles Gehäuse mit angebaute Geräteräger aus verzinktem Stahlblech, grau pulverbeschichtet. Deckeneinbau werkzeuglos mittels Federmechanismus. Deckenrahmen weiß pulverbeschichtet (alternative Farben auf Anfrage). Aluminiumreflektor hochglanz silber, Leuchtmittellage horizontal. Netzanschluss: Anschlussklemme bis 5x2,5mm² inkl. Zugentlastung. Durchgangsverdrahtung möglich. Schutzart IP20, Schutzklasse I, F-Zeichen

Recessed lighting fitting for compact fluorescent lamps (TC-D/TC-DEL, or rather TC-T/TC-TEL). Stable housing with attached gear box made of zinc-plated steel panel, grey powder coated. Installation without tools by mounting springs. Ceiling frame white powder coated (alternative colours on request). Aluminium reflector highgloss silver, lamps in horizontal position. Power supply: Terminal clamp up to 5x2,5mm² incl. strain relief. Through wiring possible. Degree of protection IP20, protection class I, F-sign

1.) Downlight serienmäßig mit angebaute VG-Box.
Downlight serially incl. attached gear box.

2.) Downlight auf Anfrage auch mit separater VG-Box lieferbar.
Downlight incl. separate gear box available on request.

Leuchtenbetriebswirkungsgrad = nLB 71%
light output ratio working = nLB 71%

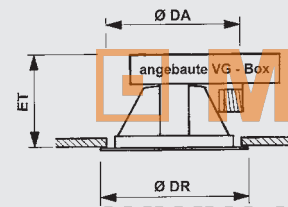

Art.-Nr. art.-no.	Bestückung/Betriebssystem lamp	DR, DA, ET in mm	nLB	kg	Preis € price €
470701V	TC-T 1x 13W/VVG	185x185, 160x160, 160	71%	1,5	86,40
470701E	TC-TEL 1x 13W/EVG	185x185, 160x160, 160	71%	1,2	125,50
470702V	TC-T 1x 18W/VVG	185x185, 160x160, 160	71%	1,5	86,40
470702E	TC-TEL 1x 18W/EVG	185x185, 160x160, 160	71%	1,2	125,50
470707V	TC-T 1x 26W/VVG	185x185, 160x160, 160	71%	1,6	86,40
470707E	TC-TEL 1x 26W/EVG	185x185, 160x160, 160	71%	1,3	125,50
470708E	TC-TEL 1x 32W/EVG	185x185, 160x160, 160	71%	1,3	142,50
470003V	TC-D 2x 13W/VVG	215x215, 195x195, 185	71%	1,7	97,40
470003E	TC-DEL 2x 13W/EVG	215x215, 195x195, 185	71%	1,4	140,70
470004V	TC-D 2x 18W/VVG	215x215, 195x195, 185	71%	1,7	97,40
470004E	TC-DEL 2x 18W/EVG	215x215, 195x195, 185	71%	1,4	141,00
470719E	TC-TEL 1x 42W/EVG	255x255, 235x235, 195	71%	1,4	151,50
470005V	TC-D 2x 26W/VVG	255x255, 235x235, 195	71%	2,0	101,60
470005E	TC-DEL 2x 26W/EVG	255x255, 235x235, 195	71%	1,5	144,80
470726E	TC-TEL 2x 32W/EVG	255x255, 235x235, 195	71%	1,5	157,90
470727E	TC-TEL 2x 42W/EVG	255x255, 235x235, 195	71%	1,5	157,90

Technische Erläuterungen
technical explanations

- nLB = Leuchtenbetriebswirkungsgrad
light output-ratio working
- Ø DR = Außendurchmesser - Deckenring
outer diameter - ceiling ring
- Ø DA = Deckenausschnitt
ceiling cut-out
- ET = Einbautiefe
installation depth
- kg = Gewicht in Kilogramm
weight in kg

Weiteres lieferbares Zubehör (auf Anfrage) / further accessories (on request)

- Dimmbares EVG (Schnittstelle 1-10V)
- dimmable electronic ballast (for 1-10V interface)
- Notlichtbausatz B (Einzelbatterie 1 oder 3 h)
- emergency kit B (single battery 1 or 3 h)
- Werkseitige Kompensation
- factory-made compensation
- Dimmbares EVG DALI (digital) (ab Bestückung 18W)
- dimmable electronic ballast DALI (digital) (for 18W lamp)
- Einbaurahmen in RAL (Farbton nach Wahl) pulverbeschichtet
- installation frame in RAL (colour on request) powder-coated
- Einputzrahmen für Nassdecken (Rabitzdecken)
- mounting frame for wet ceilings (Rabitz ceilings)
- Entlastungselement für Mineralfaserdecken Modul 600 oder Modul 625
- release element for mineral fibre ceilings module 600 or module 625
- Modulplatte M100 weiß oder in RAL-Farbtönen nach Wahl
- module slab M100 white or in RAL-colour on request

Passende lichtoptische Ausstattungselemente / fitting optical attachments

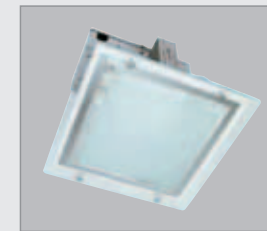

Art-Nr. / art.-no. W185SK2 € 37,90
Art-Nr. / art.-no. W215SK2 € 42,50
Art-Nr. / art.-no. W255SK2 € 47,10

Floatglasscheibe teilmattiert
WERKSEITIGE MONTAGE
float glass partially frosted
FACTORY-MADE INSTALLATION

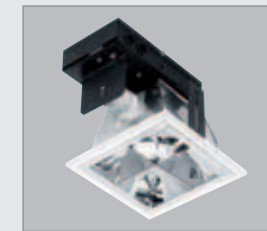

Art-Nr. / art.-no. N185KRS € 42,50
Art-Nr. / art.-no. N215KRS € 47,10
Art-Nr. / art.-no. N255KRS € 49,70

Kreuzraster hochglanz silber
cross louvre highgloss silver



Art-Nr. / art.-no. W185RK1 € 41,90
Art-Nr. / art.-no. W215RK1 € 44,10
Art-Nr. / art.-no. W255RK1 € 49,90

Floatglasrahmen vollmattiert
WERKSEITIGE MONTAGE
float glass frame completely frosted
FACTORY-MADE INSTALLATION



Cafeteria Marienhospital, Marl

MODUL
ELECTRO
www.modulelectro.ru

Quadratisch / square



Quadratisches Downlight / square downlight

Einbaudownlight für Kompaktleuchtstofflampen (TC-DEL, bzw. TC-TEL). Stabiles Gehäuse mit separatem Geräteträger. Deckeneinbau werkzeuglos mittels Federmechanismus. Deckenrahmen alu matt. Aluminiumreflektor hochglanz silber, Leuchtmittellage horizontal. Netzanschluss: Anschlussklemme bis 3x2,5mm² inkl. Zugentlastung. Schutzart IP20, Schutzklasse I, F-Zeichen

Recessed lighting fitting for compact fluorescent lamps (TC-DEL, or rather TC-TEL). Stable housing with separate gear box. Installation without tools by mounting springs. Ceiling frame alu matt, aluminium reflector highgloss silver, lamps in horizontal position. Power supply: Terminal clamp up to 3x2,5mm² incl. strain relief. Degree of protection IP20, protection class I, F-sign



Quadratisches Downlight mit Acryldeckung opal und Innenreflektor hochglanz silber mit ESG-Glas matt
square downlight with acrylic opal cover and inner reflector highgloss silver with toughened glass matt finished

Die Leuchten sind ausschließlich in der abgebildeten Ausführung lieferbar.
The light fittings are only available in the mentioned shape.

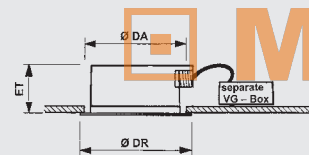

Technische Erläuterungen
technical explanations

- Ø DR = Außendurchmesser - Deckenring
outer diameter - ceiling ring
- Ø DA = Deckenausschnitt
ceiling cut-out
- ET = Einbautiefe
installation depth
- kg = Gewicht in Kilogramm
weight in kg

Art-Nr. art-no.	Bestückung/Betriebssystem lamp	DR, DA, ET in mm	kg	Preis € price €
475063E	TC-DEL 2x 13W/EVG	145x145, 130x130, 85	1,0	178,60
475079E	TC-TEL 2x 26/32W/EVG	215x215, 190x190, 95	1,5	198,90

Weiteres lieferbares Zubehör (auf Anfrage) / further accessories (on request)

- Einputzrahmen für Nassdecken (Rabitzdecken)
- mounting frame for wet ceilings (Rabitz ceilings)
- Entlastungselement für Mineralfaserdecken Modul 600 oder Modul 625
- release element for mineral fibre ceilings module 600 or module 625
- Modulplatte M100 weiß oder in RAL-Farbtönen nach Wahl
- module slab M100 white or in RAL-colour on request

Quadratisch / square



Quadratisches Downlight / square downlight

Einbaudownlight für Kompaktleuchtstofflampen (TC-DEL, bzw. TC-TEL). Stabiles Gehäuse mit separatem Geräteträger. Deckeneinbau werkzeuglos mittels Federmechanismus. Deckenring / Deckenrahmen nickel matt. Aluminiumreflektor mattglanz silber, Leuchtmittellage horizontal. Netzanschluss: Anschlussklemme bis 3x2,5mm² inkl. Zugentlastung. Schutzart IP33, Schutzklasse I, F-Zeichen

Recessed lighting fitting for compact fluorescent lamps (TC-DEL, or rather TC-TEL). Stable housing with separate gear box. Installation without tools by mounting springs. Ceiling ring / ceiling frame nickel satin. Aluminium reflector satin silver, lamps in horizontal position. Power supply: Terminal clamp up to 3x2,5mm² incl. strain relief. Degree of protection IP33, protection class I, F-sign



Quadratisches Downlight mit Sicherheitsglas teilmattiert
square downlight with safety glass partially frosted

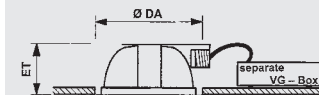

Die Leuchten sind ausschließlich in der abgebildeten Ausführung lieferbar.
The light fittings are only available in the mentioned shape.



Technische Erläuterungen
technical explanations

- Ø DR = Außendurchmesser - Deckenring
outer diameter - ceiling ring
- Ø DA = Deckenausschnitt
ceiling cut-out
- ET = Einbautiefe
installation depth
- kg = Gewicht in Kilogramm
weight in kg

Art-Nr. art-no.	Bestückung/Betriebssystem lamp	Ø DR, Ø DA, Ø ET in mm	kg	Preis € price €
475073E	TC-DEL 2x 13W/EVG	160x160, 140, 85	0,8	156,10
475089E	TC-TEL 2x 26W/32W/EVG	210x210, 185, 85	1,1	166,30

Weiteres lieferbares Zubehör (auf Anfrage) / further accessories (on request)

- Einputzring für Nassdecken (Rabitzdecken)
- mounting ring for wet ceilings (Rabitz ceilings)
- Entlastungselement für Mineralfaserdecken Modul 600 oder Modul 625
- release element for mineral fibre ceilings module 600 or module 625
- Modulplatte M100 weiß oder in RAL-Farbtönen nach Wahl
- module slab M100 white or in RAL-colour on request

Aufbaudownlight / surface mounted downlight



Aufbaudownlight / surface mounted downlight

Aufbaudownlight für Kompaktleuchtstofflampen (TC-D/TC-DEL). Gehäuse aus Aluminium, weiß pulverbeschichtet (alternative Farben auf Anfrage). Aluminiumreflektor hochglanz silber.

Netzanschluss: Anschlussklemme bis 5x2,5mm² (bis 3x2,5mm² bei Art. 462...) inkl. Zugentlastung. Durchgangsverdrahtung möglich (nur bei 460.../461...).

Schutzart IP20, Schutzklasse I, F-Zeichen

Surface mounted downlight for compact fluorescent lamps (TC-D/TC-DEL). Aluminium housing, white powder coated (alternative colours on request). aluminium reflector highgloss silver.
Power supply: Terminal clamp up to 5x2,5mm² (bis 3x2,5mm² for article 462...) incl. strain relief. Through wiring possible (only for articles 460.../461...).

Leuchtenbetriebswirkungsgrad = nLB 71%
light output ratio working = nLB 71%

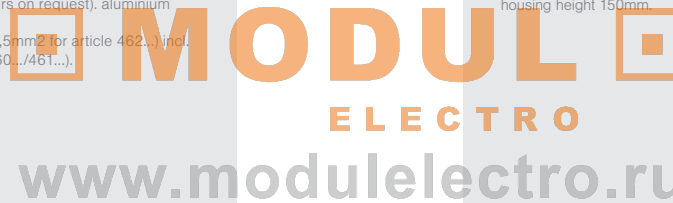

Hinweis / advice

Auf Anfrage sind die Art.-Nummern 460... auch mit Gehäusehöhe 150mm verfügbar
advice: art.-no. 460... also available with housing height 150mm

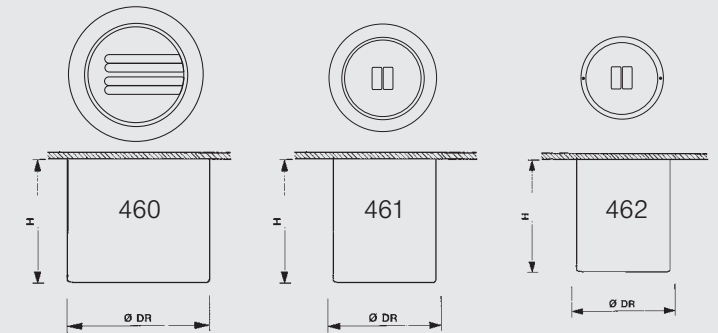

Art.-Nr. art.-no.	Bestückung / Betriebssystem lamp	Ø DR, H in mm	nLB	kg	Preis € price €
460001V	TC-D 1x 13W/VVG	Ø 220, 200	71%	1,3	102,60
460001E	TC-DEL 1x 13W/EVG	Ø 220, 200	71%	1,1	129,90
460002V	TC-D 1x 18W/VVG	Ø 220, 200	71%	1,4	102,60
460002E	TC-DEL 1x 18W/EVG	Ø 220, 200	71%	1,1	129,90
460007V	TC-D 1x 26W/VVG	Ø 255, 210	71%	1,4	123,10
460007E	TC-DEL 1x 26W/EVG	Ø 255, 210	71%	1,2	163,90
460003V	TC-D 2x 13W/VVG	Ø 220, 200	71%	1,4	111,70
460003E	TC-DEL 2x 13W/EVG	Ø 220, 200	71%	1,2	152,70
460004V	TC-D 2x 18W/VVG	Ø 220, 200	71%	1,5	111,70
460004E	TC-DEL 2x 18W/EVG	Ø 220, 200	71%	1,2	152,70
460005V	TC-D 2x 26W/VVG	Ø 255, 210	71%	1,8	129,90
460005E	TC-DEL 2x 26W/EVG	Ø 255, 210	71%	1,3	171,00
461001V	TC-D 1x 13W/VVG	Ø 185, 225	71%	1,3	95,90
461001E	TC-DEL 1x 13W/EVG	Ø 185, 225	71%	1,1	123,20
461002V	TC-D 1x 18W/VVG	Ø 185, 225	71%	1,4	95,90
461002E	TC-DEL 1x 18W/EVG	Ø 185, 225	71%	1,1	123,20
461007V	TC-D 1x 26W/VVG	Ø 185, 225	71%	1,4	95,90
461007E	TC-D 1x 26W/EVG	Ø 185, 225	71%	1,2	123,20
462001V	TC-D 1x 13W/VVG	Ø 140, 185	71%	1,0	81,90
462001E	TC-DEL 1x 13W/EVG	Ø 140, 185	71%	0,8	109,40
462002V	TC-D 1x 18W/VVG	Ø 140, 185	71%	1,0	81,90
462002E	TC-DEL 1x 18W/EVG	Ø 140, 185	71%	0,8	109,40
462007V	TC-D 1x 26W/VVG	Ø 140, 185	71%	1,1	81,90
462007E	TC-DEL 1x 26W/EVG	Ø 140, 185	71%	0,9	109,40

**Technische Erläuterungen
technical explanations**

- nLB = Leuchtenbetriebswirkungsgrad
light output-ratio working
- Ø DR = Außendurchmesser
outer diameter
- H = Höhe
height
- kg = Gewicht in Kilogramm
weight in kg

Weiteres lieferbares Zubehör (auf Anfrage) / further accessories (on request)

- Dimmbares EVG (Schnittstelle 1-10V) (nur Art. 460..., 461...)
- dimmable electronic ballast (for 1-10V interface) (only Art. 460..., 461...)
- Werkseitige Kompensation
- factory-made compensation
- Dimmbares EVG DALI (digital) (ab Bestückung 18W) (nur Art. 460..., 461...)
- dimmable electronic ballast DALI (digital) (for assembly 18W) (only Art. 460..., 461...)
- Gehäuse in RAL (Farbton nach Wahl) pulverbeschichtet
- housing in RAL (colour on request) powder-coated
- Reflektor in Facettenoptik oder in Ausführung mattglanz silber (nur Art. 460..., 461...)
- reflector in facet optic or in satin silver (only Art. 460..., 461...)

Ausstattungs-elemente / attachments

für die Produkte auf den Seiten 340-341
for products on the pages 340-341



Art-Nr. / art.-no. W185SZ2 € 37,90
Art-Nr. / art.-no. W220SZ2 € 42,50
Art-Nr. / art.-no. W255SZ2 € 47,10

Floatglasscheibe teilmattiert

(passend zu Art. 460..., 461...)
WERKSEITIGE MONTAGE
float glass partially frosted

(suitable for art.. 460..., 461...)
FACTORY-MADE INSTALLATION



Art-Nr. / art.-no. W185RS1 € 37,90
Art-Nr. / art.-no. W220RS1 € 42,50
Art-Nr. / art.-no. W255RS1 € 47,10

Floatglasring vollmattiert

(passend zu Art. 460..., 461...)
WERKSEITIGE MONTAGE
floatglasring completely frosted

(suitable for art.. 460..., 461...)
FACTORY-MADE INSTALLATION



Art-Nr. / art.-no. N220TUR € 64,90
Art-Nr. / art.-no. N255TUR € 67,60

Turboraster, hochglanz silber

(nur zu Art. 460...)
turbo louvre, highgloss silver

(only for art. 460...)

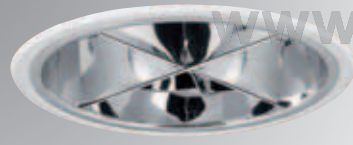

Art-Nr. / art.-no. N220KRR € 47,10
Art-Nr. / art.-no. N255KRR € 49,70

Kreuzraster, hochglanz silber

(nur zu Art. 460...)
cross louvre, highgloss silver

(only for art. 460...)



MODUL
ELECTRO
www.modulelectro.ru



Haarstudio „Hairlike“, Regensburg



Die wohl faszinierendste Art der Beleuchtung.

Mit unserer dekorativen fasertechnischen Beleuchtung sorgen Sie für Licht, Farbe und Bewegung. Die PMMA-Kunststoff-Faser ist unempfindlicher und hat einen kleineren Biegeradius als Glasfasern, so dass Ihrer Kreativität (fast) keine Grenzen gesetzt sind.

Maybe the most fascinating kind of lighting...

With our decorative, fiber-optics installations you can create light, colour and motion. The PMMA plastic fibre is much more insensible and offers a smaller bending radius than glass fibres. That means: (almost) no limits for your creativity!



MODULE
ELECTRO
www.moduleelectro.com

Die Hauptvorteile der Faseroptik gegenüber herkömmlicher Beleuchtung

The main advantage of the fibre optics in comparison to conventional lighting

- Keine ultraviolette (UV) oder infrarote (IR) Strahlung
- no UV and IR radiation
- Elektrische Trennung von Lichtquelle und Lichtaustritt
- electrical disconnection of light source and light exit
- Kein elektrisches Potential am Lichtaustritt
- no current at the end of the fibre
- Keine Schutzmaßnahmen am Lichtaustritt nötig
- no electronic protection measures needed at the light exit
- Keine Hitzeentwicklung am Lichtaustritt
- no rise in temperature at the light exit
- Geringer Stromverbrauch
- low current consumption

Wir produzieren für Sie

Die Firma Brumberg hat wegen der großen Nachfrage und aus Qualitätsgründen seit Januar 2001 einen eigenen Produktionsbereich für den Bereich Lichtwellenleiter auf höchstem technischen Niveau aufgebaut.

We produce for you

Brumberg-Leuchten has established a particular branch of production for the fibre optics range on the highest technical stage, because of quality reasons and the high demands.

Dadurch ergeben sich große Vorteile für unsere Kunden:

- Hochwertige Projektoren durch den Einsatz hochwertiger Einzelkomponenten. Die Geräte sind alle geprüft nach ENEC 05
- Steigerung der Lichtintensität um ca. 20% durch neuartigen Produktionsprozeß für die Faserbündelung

Due to this our costumers benefit from ist:

- high quality projectors because of high quality components. The devices are controlled in reference to ENEC 05
- light intensity is increased about 20%, because of the fibre bundles new kind of production.



Die Hauptvorteile unserer Fasertechnik gegenüber der Glasfasertechnik

- geringeres Gewicht
- einfachere Verarbeitung
- beliebig kürzbar
- deutlich kleinerer Biegeradius

- less weight
- easier handling
- user-defined cuttable
- much smaller bend-radius

The main advantage of our fibre optics in comparison to glass fibre optics

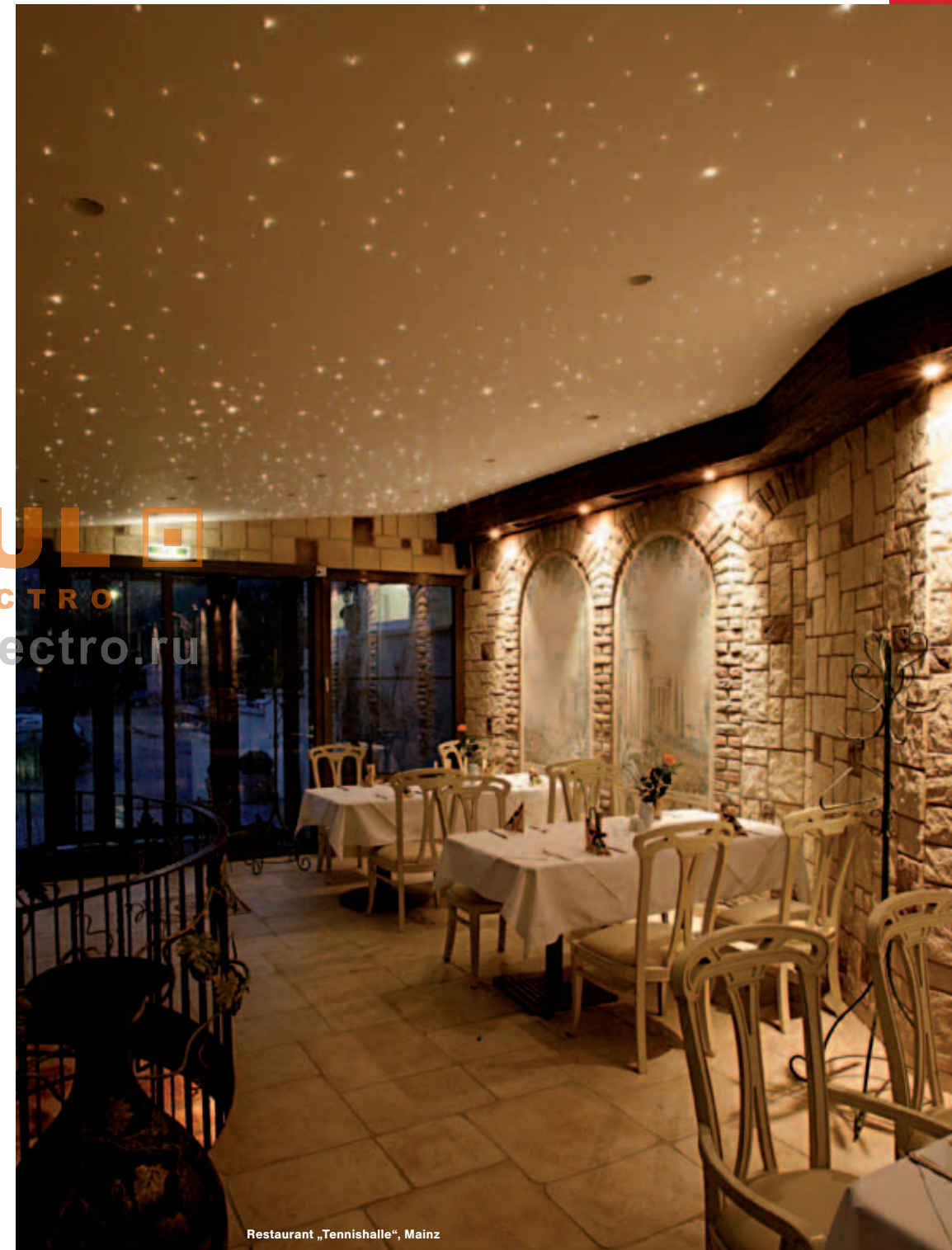
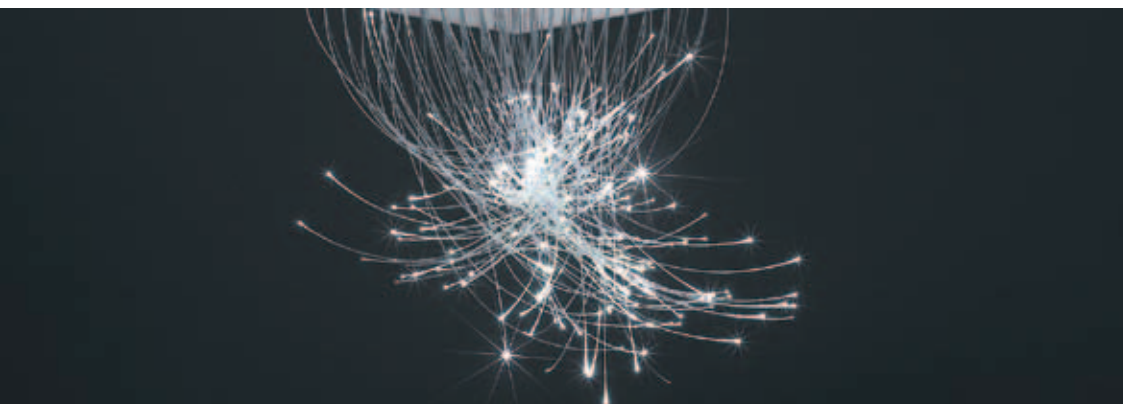

Restaurant „Tennishalle“, Mainz

Installation faseroptischer Anlagen

Installation of the fibre optical arrangements

- Der Projektor sollte so positioniert werden, dass ein Leuchtmitteltausch jederzeit möglich ist
- we advice to install the projector to a place, where you are able to change the bulb at any time
- Bei der Projektierung der Anlage den Projektor möglichst zentral anordnen, um die Faserlänge gering zu halten
- by placing the projector in the central position of the object, you get the smallest fibre length
- Zur problemlosen Installation des Bündels sollte an der Konnektor-Eingangsseite 30cm Freiraum vorhanden sein
- for easy installation of the bundle, we advise to have a free space of 30cm from the connectors feed in
- Der Anschluss kann über einen Deckenanschluss oder über eine Steckdose erfolgen
- the source can be connected by a conventional socket or a ceiling socket
- Beachten Sie, dass der Faserendpunkt keinen Temperaturen über 80°C ausgesetzt wird
- Please note that the fibres are resistable until a temperature of 80°C, only
- Die Faser darf ausschließlich mit lösungsmittel-freien Zwei-Komponentenkleber fixiert werden (siehe Installations-Kit Seite 317)
- Please fix the fibres on the back with a solvent-free glue (see installation kit page 317)

Anwendungsgebiete Lichtleitertechnik

Uses for photoconductive fibres

- Innenbereich:
 - Büros, Aufzüge, Lobbies, Handläufe, Sternenhimmel, Richtungszeichen, Allroundbeleuchtung
- Indoor:
 - offices, lifts, lobbies, handrails, starry skies, signs, allround-lighting
- Außenbereich:
 - Fassaden, Treppen, Säulen, Vordächer, Brunnen, Werbeschilder, Wegweiser
- Outdoor:
 - facades, stairs, columns, canopies, fountains, billboards, direction signs
- Öffentliche Zonen:
 - Kunsthallen, Museen, Parks, Stadien, Brücken, Flughäfen, Kirchen, Krankenhäuser
- Public areas:
 - art galleries, museums, parcs, stadiums, bridges, airports, churches, hospitals

Moderne Lichttechnik mit PMMA Kunststoff-Faser

Diese neue Beleuchtungstechnik besteht aus drei verschiedenen Hauptkomponenten

Modern light technology with PMMA plastic-fibre

This new lighting technology is composed of three different main components

1. Die Lichtquelle / the light source (230V/60Hz)
 - Gehäuse „steckerfertig“ zum Anschluss an eine konventionelle 230V-Steckdose
 - Plug-in box for connection to a conventional 230V socket
 - inkl. Lüfter, für hohe Leuchtmittel-Lebensdauer (nicht bei LED-Projektoren)
 - incl. exhauster for a high lifespan of the bulbs (excluding LED projectors)
 - kompakte Bauweise / a compact construction
 - elektronischer Transformator / electronic transformer
 - Dimmung möglich / dimming is possible
2. Die Faser / the fibre
 - natürlicher Lichttransport / natural light transfer
 - hohe Flexibilität durch kleinen Biegeradius
 - high flexibility because of the small bending radius
 - maximale Anzahl der Fasern pro Projektor / maximum quantity per projector
 - 500x S0 (1,0mm); 150x S2 (2,0mm); 50x S3 (3,0mm); 25x S19 (5,0mm); 15x S33 (7,0mm)
 - Kombination verschiedener Fasern ist möglich
 - the combination of different fibres is possible
3. Die Endstücke / the different sleeves
 - potentialfrei / without current
 - temperaturfreies Licht / light without temperature
 - keine UV- / IR-Strahlung / without UV / IR radiation
 - einfache Montage / simple assembling
 - große Auswahl an dekorativen und technischen Endstücken
 - a big choice of decoration elements

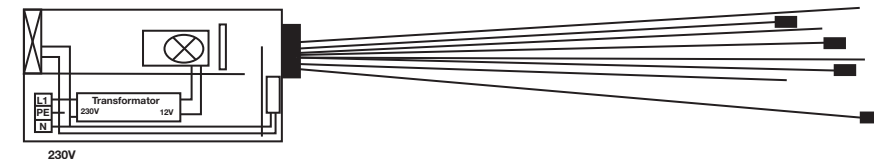
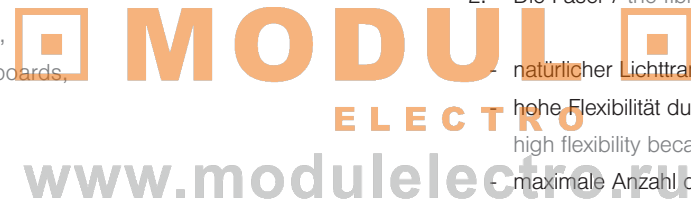

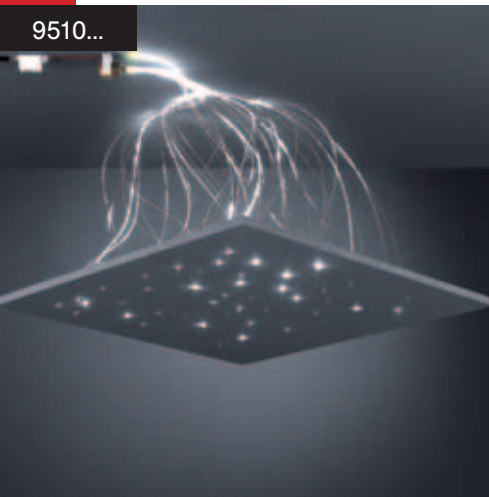

9510...

Einsteiger-Sets / starter kits

bestehend aus / consisting of:
 1x Mini-Projektor - 1W Power-LED (D26 x L35mm)
 1x mini-projector - 1W Power-LED (diametre 26 x length 35mm)
 1x Netzgerät für Power-LED (L52 x B26 x H22mm)
 1x power-supply for Power-LED (length 52 x width 26 x height 22mm)
 1x Faserbündel / 1x fibre bundle:
 50-teilige Mischfaser / 50-pieces of mixed fibres
 15x 0,5mm, 20x 0,75mm, 10x 1,0mm,
 5x 1,5mm, Länge / length: 1,0m

Deckenplatte nicht im Lieferumfang enthalten / ceiling plate not included in delivery

Art.-Nr. art.-no.	Lichtfarbe light colour	Preis € price €
9510W	weiß / white	139,50
9510B	blau / blue	139,50
9510R	rot / red	139,50
9510Y	orange / orange	139,50
9510G	grün / green	139,50



9512...

Einsteiger-Sets / starter kits

bestehend aus / consisting of:
 1x Projektor - 1x Power-LED (1,0W) (180x65x35mm)
 1x projector - 1x Power-LED (1,0W) (180x65x35mm)
 1x Anschlussleitung 1,5m für 230V-Direktanschluss
 1x connexion 1,5m for 230V-direct connexion
 1x Faserbündel: 75 Fasern: SO (1,0mm), Länge: 1,5m
 1x fibre bundle: 75 fibres: SO (1,0mm), length: 1,5m

Schutzart / art of protection: IP20

ohne Lüfter / without ventilator

Art.-Nr. art.-no.	Lichtfarbe light colour	Preis € price €
9512W	weiß / white	184,50
9512B	blau / blue	184,50
9512R	rot / red	184,50
9512Y	orange / orange	184,50
9512G	grün / green	184,50

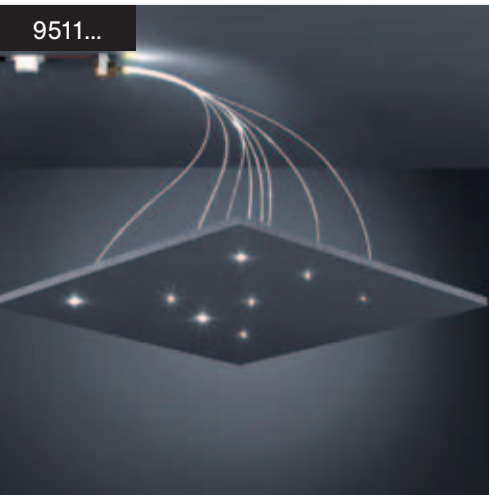

9511...

Einsteiger-Sets / starter kits

bestehend aus / consisting of:
 1x Mini-Projektor - 1W Power-LED (D26 x L35mm)
 1x mini-projector - 1W Power-LED (diametre 26 x length 35mm)
 1x Netzgerät für Power-LED (L52 x B26 x H22mm)
 1x power-supply for Power-LED (length 52 x width 26 x height 22mm)
 1x Faserbündel / fibre bundle: 8x 2,0mm, Länge / length: 1,0m

Deckenplatte nicht im Lieferumfang enthalten / ceiling plate not included in delivery

Art.-Nr. art.-no.	Lichtfarbe light colour	Preis € price €
9511W	weiß / white	139,50
9511B	blau / blue	139,50
9511R	rot / red	139,50
9511Y	orange / orange	139,50
9511G	grün / green	139,50

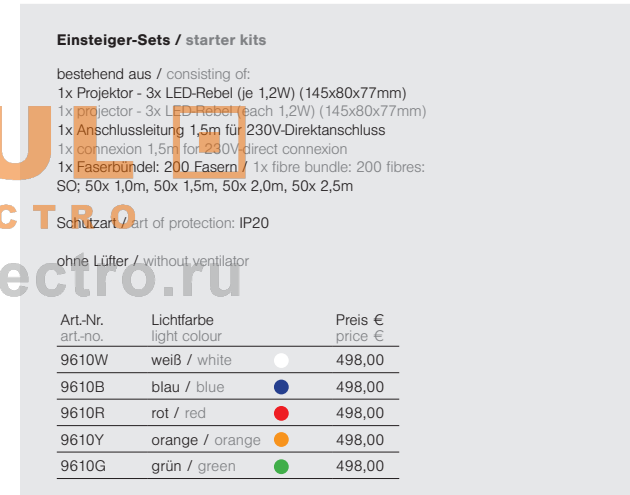

9610...

Einsteiger-Sets / starter kits

bestehend aus / consisting of:
 1x Projektor - 3x LED-Rebel (je 1,2W) (145x80x77mm)
 1x projector - 3x LED-Rebel (each 1,2W) (145x80x77mm)
 1x Anschlussleitung 1,5m für 230V-Direktanschluss
 1x connexion 1,5m for 230V-direct connexion
 1x Faserbündel: 200 Fasern / 1x fibre bundle: 200 fibres:
 SO; 50x 1,0m, 50x 1,5m, 50x 2,0m, 50x 2,5m

Schutzart / art of protection: IP20

ohne Lüfter / without ventilator

Art.-Nr. art.-no.	Lichtfarbe light colour	Preis € price €
9610W	weiß / white	498,00
9610B	blau / blue	498,00
9610R	rot / red	498,00
9610Y	orange / orange	498,00
9610G	grün / green	498,00

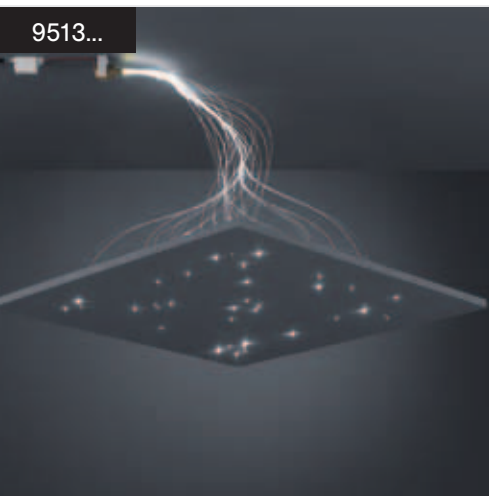

9513...

Einsteiger-Sets / starter kits

bestehend aus / consisting of:
 1x Mini-Projektor - 1W Power-LED (D26 x L35mm)
 1x mini-projector - 1W Power-LED (diametre 26 x length 35mm)
 1x Netzgerät für Power-LED (L52 x B26 x H22mm)
 1x power-supply for Power-LED (length 52 x width 26 x height 22mm)
 1x Faserbündel / fibre bundle: 33x 1,0mm, Länge / length: 1,0m

Deckenplatte nicht im Lieferumfang enthalten / ceiling plate not included in delivery

Art.-Nr. art.-no.	Lichtfarbe light colour	Preis € price €
9513W	weiß / white	113,50
9513B	blau / blue	113,50
9513R	rot / red	113,50
9513Y	orange / orange	113,50
9513G	grün / green	113,50



MODU
ELECTRO
www.modulelectro.ru



951500

Einsteiger-Sets / starter kits

bestehend aus / consisting of:
 1x Projektor - 10W Halogen (L115 x B125 x H100mm)
 1x projector - 10W Halogen (L115 x B125 x H100mm)
 1x Farbrad farbig / 1x colour wheel coloured
 1x Faserbündel: 62x 1mm, Länge: 2,5m / 1x fibre bundle: 62x 1mm, length: 2,5m

ohne Lüfter / without ventilator

Deckenplatte nicht im Lieferumfang enthalten / ceiling plate not included in delivery

Art.-Nr. art.-no.	Preis € price €
951500	269,30



9512RGB

Fasertechnik-Sets / fibre optics sets

bestehend aus / consisting of:
 1x Projektor - 1x LED-RGB-Multi Color (3,0W) (180x65x35mm)
 1x projector - 1x LED-RGB-Multi Color (3,0W) (180x65x35mm)
 1x Anschlussleitung 1,5m für 230V-Direktanschluss
 1x connexion 1,5m for 230V-direct connexion
 1x Faserbündel / 1x fibre bundle:
 75 Fasern / fibres: SO (1,0mm), Länge / length: 1,5m

Schutzart / art of protection: IP20

ohne Lüfter / without ventilator

Farbstopp über separaten Taster möglich
 A colour stop is possible with a separate push button

Art.-Nr. art.-no.	Lichtfarbe light colour	Preis € price €
9512RGB	RGB	269,00

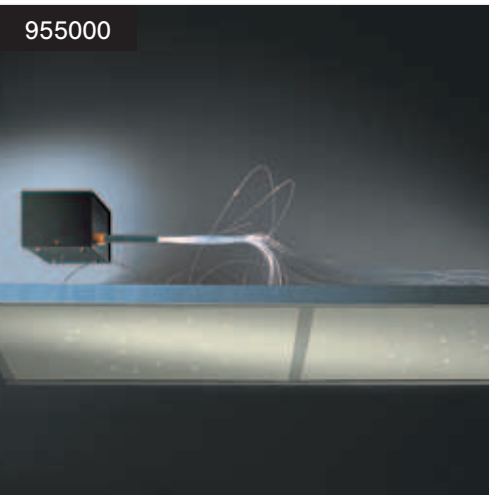

955000

Einsteiger-Sets / starter kits

bestehend aus / consisting of:
 1x Projektor - 10W Halogen (L115 x B125 x H100mm)
 1x projector - 10W Halogen (L115 x B125 x H100mm)
 1x Farbrad farbig / 1x colour wheel coloured
 1x Faserbündel / 1x fibre bundle:
 50x 1mm, Länge / length: 2,0m
 10 x 2mm, Länge / length: 2,0m

ohne Lüfter / without ventilator

Deckenplatte nicht im Lieferumfang enthalten / ceiling plate not included in delivery

Art.-Nr. art.-no.	Preis € price €
955000	301,80



9611RGB

Fasertechnik-Sets / fibre optics sets

bestehend aus / consisting of:
 1x Projektor - 3x RGB-LED-Fullcolour (13,8W) (100x155x270mm)
 1x projector - 3x RGB-LED-Fullcolour (13,8W) (100x155x270mm)
 1x Anschlussleitung 1,5m für 230V-Direktanschluss
 1x connexion 1,5m for 230V-direct connexion
 1x Faserbündel / 1x fibre bundle:
 200 Fasern / fibre: SO; 50x 1,0m,
 50x 1,5m, 50x 2,0m, 50x 2,5m

Schutzart / art of protection: IP20

inkl. Infrarot-Fernbedienung / incl. infrared-remote control
 ohne Lüfter / without ventilator

Art.-Nr. art.-no.	Lichtfarbe light colour	Preis € price €
9611RGB	RGB	998,00



951400

Einsteiger-Sets / starter kits

bestehend aus / consisting of:
 1x Projektor - 50W Halogen (L270 x B155 x H100mm)
 1x projector - 50W Halogen (L270 x B155 x H100mm)
 1x Farbrad farbig / 1x colour wheel coloured
 1x Faserbündel / 1x fibre bundle:
 25x 1mm, Länge / length: 1,5m
 50 x 1mm, Länge / length: 3,0m

Art.-Nr. art.-no.	Preis € price €
951400	600,30

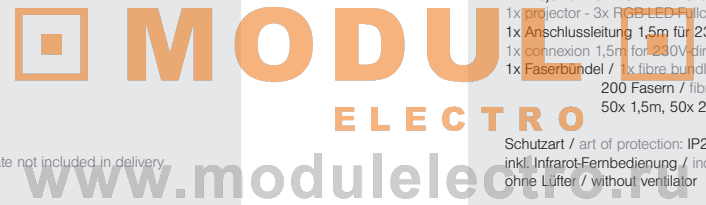
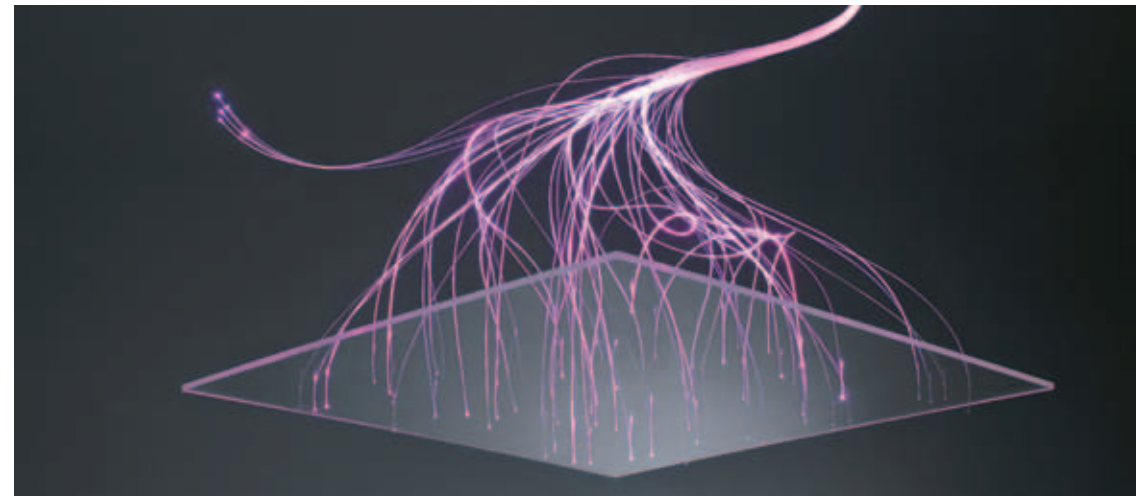

950100

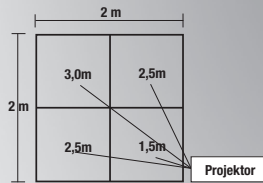

Sternenhimmel-Set / starry sky kit

bestehend aus / consisting of:
 1x Projektor 50W Halogen (L 270 x B 155 x H 100mm)
 1x projector 50W Halogen (L 270 x B 155 x H 100mm)
 1x Farbrad nach Wahl / 1x colour wheel at your option
 1x Faserbündel konfektioniert: 200 x 1,0mm, Längen: 50x 1,5m + 100x 2,5m + 50x 3,0m
 1x fibre bundle assembled: 200 x 1,0mm, lengths: 50x 1,5m + 100x 2,5m + 50x 3,0m

Bei Bestellungen bitte die gewünschte Art.-Nr. des Farbrades mit angeben:
 for orders please add the article-no. of the requested colour wheel:

Art.-Nr. art.-no.	Preis € price €	932000 Klar clear	932100 Farbig coloured	932200 Farbig Funken coloured sparks
950100	918,20			
		932300 Blau/Klar/Funken blue/clear/sparks	932400 Schwarz/Klar/ Funken black/clear/sparks	

950400

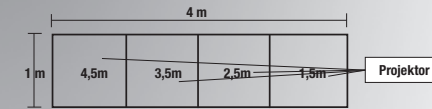

Sternenhimmel-Set / starry sky kit

bestehend aus / consisting of:
 1x Projektor 50W Halogen (L 270 x B 155 x H 100mm)
 1x projector 50W Halogen (L 270 x B 155 x H 100mm)
 1x Farbrad nach Wahl / 1x colour wheel at your option
 1x Faserbündel konfektioniert: 200 x 1,0mm, Längen: 50x 1,5m + 50x 2,5m + 50x 4,5m
 1x fibre bundle assembled: 200 x 1,0mm, lengths: 50x 1,5m + 50x 2,5m + 50x 4,5m

Bei Bestellungen bitte die gewünschte Art.-Nr. des Farbrades mit angeben:
 for orders please add the article-no. of the requested colour wheel:

Art.-Nr. art.-no.	Preis € price €	932000 Klar clear	932100 Farbig coloured	932200 Farbig Funken coloured sparks
950400	989,70			
		932300 Blau/Klar/Funken blue/clear/sparks	932400 Schwarz/Klar/ Funken black/clear/sparks	

950200

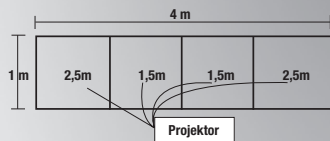

Sternenhimmel-Set / starry sky kit

bestehend aus / consisting of:
 1x Projektor 50W Halogen (L 270 x B 155 x H 100mm)
 1x projector 50W Halogen (L 270 x B 155 x H 100mm)
 1x Farbrad nach Wahl / 1x colour wheel at your option
 1x Faserbündel konfektioniert: 200 x 1,0mm, Längen: 100x 1,5m + 100x 2,5m
 1x fibre bundle assembled: 200 x 1,0mm, lengths: 100x 1,5m + 100x 2,5m

Bei Bestellungen bitte die gewünschte Art.-Nr. des Farbrades mit angeben:
 for orders please add the article-no. of the requested colour wheel:

Art.-Nr. art.-no.	Preis € price €	932000 Klar clear	932100 Farbig coloured	932200 Farbig Funken coloured sparks
950200	874,90			
		932300 Blau/Klar/Funken blue/clear/sparks	932400 Schwarz/Klar/ Funken black/clear/sparks	

951600

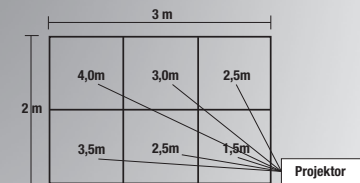

Sternenhimmel-Set / starry sky kit

bestehend aus / consisting of:
 1x Projektor 50W Halogen (L 270 x B 155 x H 100mm)
 1x projector 50W Halogen (L 270 x B 155 x H 100mm)
 1x Farbrad nach Wahl / 1x colour wheel at your option
 1x Faserbündel konfektioniert: 300 x 1,0mm, Längen: 50x 1,5m + 100x 2,5m + 50x 3,0m + 50x 4,0m
 1x fibre bundle assembled: 200 x 1,0mm, lengths: 50x 1,5m + 100x 2,5m + 50x 3,0m + 50x 4,0m

Bei Bestellungen bitte die gewünschte Art.-Nr. des Farbrades mit angeben:
 for orders please add the article-no. of the requested colour wheel:

Art.-Nr. art.-no.	Preis € price €	932000 Klar clear	932100 Farbig coloured	932200 Farbig Funken coloured sparks
951600	1.112,90			
		932300 Blau/Klar/Funken blue/clear/sparks	932400 Schwarz/Klar/ Funken black/clear/sparks	

950300

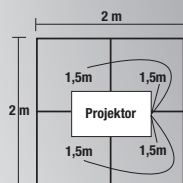

Sternenhimmel-Set / starry sky kit

bestehend aus / consisting of:
 1x Projektor 50W Halogen (L 270 x B 155 x H 100mm)
 1x projector 50W Halogen (L 270 x B 155 x H 100mm)
 1x Farbrad nach Wahl / 1x colour wheel at your option
 1x Faserbündel konfektioniert: 200 x 1,0mm, Längen: 200x 1,5m
 1x fibre bundle assembled: 200 x 1,0mm, lengths: 200x 1,5m

Bei Bestellungen bitte die gewünschte Art.-Nr. des Farbrades mit angeben:
 for orders please add the article-no. of the requested colour wheel:

Art.-Nr. art.-no.	Preis € price €	932000 Klar clear	932100 Farbig coloured	932200 Farbig Funken coloured sparks
950300	853,30			
		932300 Blau/Klar/Funken blue/clear/sparks	932400 Schwarz/Klar/ Funken black/clear/sparks	

951700

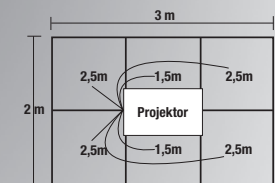

Sternenhimmel-Set / starry sky kit

bestehend aus / consisting of:
 1x Projektor 50W Halogen (L 270 x B 155 x H 100mm)
 1x projector 50W Halogen (L 270 x B 155 x H 100mm)
 1x Farbrad nach Wahl / 1x colour wheel at your option
 1x Faserbündel konfektioniert: 300 x 1,0mm, Längen: 100x 1,5m + 200x 2,5m
 1x fibre bundle assembled: 300 x 1,0mm, lengths: 100x 1,5m + 200x 2,5m

Bei Bestellungen bitte die gewünschte Art.-Nr. des Farbrades mit angeben:
 for orders please add the article-no. of the requested colour wheel:

Art.-Nr. art.-no.	Preis € price €	932000 Klar clear	932100 Farbig coloured	932200 Farbig Funken coloured sparks
951700	1.037,30			
		932300 Blau/Klar/Funken blue/clear/sparks	932400 Schwarz/Klar/ Funken black/clear/sparks	

9570



LED-Effekt Projektor / LED-effect projector

Sternenflimmern 1-2fach / stary twinkle 1-2times

2 Faserports mit je 80 Lichtpunkten 1,0mm; Länge 2,0m
 Gesamt: 160 Lichtpunkte, Bestückung: 28x LED (ca. 5W)
 2 fibreports per 80 light points 1,0mm; length 2,0m
 total: 160 light points, assembly: 28x LED (approx. 5W)

Material: Metall / material: metal
 Schutzklasse / protection class: III, Schutzart / art of protection: IP20
 mit separatem Netzgerät für 230V-Direktanschluss
 with separate power-supply for 230V-direct connexion
 ohne Lüfter / without ventilator

Art.-Nr. art.-no.	Lichtfarbe light colour	Preis € price €
9570	weiß / white	1.234,00

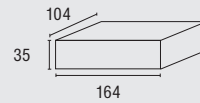

9572



LED-Effekt Projektor / LED-effect projector

Sternschnuppe 1-2fach / shooting star 1-2times

2 Faserports mit je 40 Lichtpunkten 1,0mm; Länge 2,0m
 Gesamt: 80 Lichtpunkte, Bestückung: 28x LED (ca. 4,0W)
 2 fibreports per 40 light points 1,0mm; length 2,0m
 total: 80 light points, assembly: 28x LED (approx. 4,0W)

Material: Metall / material: metal
 Schutzklasse / protection class: III, Schutzart / art of protection: IP20
 mit separatem Netzgerät für 230V-Direktanschluss
 with separate power-supply for 230V-direct connexion
 ohne Lüfter / without ventilator

Art.-Nr. art.-no.	Lichtfarbe light colour	Preis € price €
9572	weiß / white	1.028,00

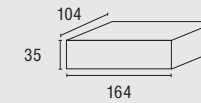

9571



LED-Effekt Projektor / LED-effect projector

Sternenflimmern 1-4fach / stary twinkle 1-4times

4 Faserports mit je 80 Lichtpunkten 1,0mm; Länge 4,0m
 Gesamt: 320 Lichtpunkte, Bestückung: 56x LED (ca. 10W)
 4 fibreports per 80 light points 1,0mm; length 4,0m
 total: 320 light points, assembly: 56x LED (approx. 10W)

Material: Metall / material: metal
 Schutzklasse / protection class: III, Schutzart / art of protection: IP20
 mit separatem Netzgerät für 230V-Direktanschluss
 with separate power-supply for 230V-direct connexion
 ohne Lüfter / without ventilator

Art.-Nr. art.-no.	Lichtfarbe light colour	Preis € price €
9571	weiß / white	2.048,00

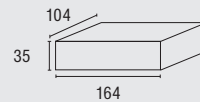

LED-Effekt Projektor / LED-effect projector

Sternschnuppe 1-4fach / shooting star 1-4times

4 Faserports mit je 40 Lichtpunkten 1,0mm; Länge 3,0m
 Gesamt: 160 Lichtpunkte, Bestückung: 56x LED (ca. 8W)
 4 fibreports per 40 light points 1,0mm; length 3,0m
 total: 160 light points, assembly: 56x LED (approx. 8W)

Material: Metall / material: metal
 Schutzklasse / protection class: III, Schutzart / art of protection: IP20
 mit separatem Netzgerät für 230V-Direktanschluss
 with separate power-supply for 230V-direct connexion
 ohne Lüfter / without ventilator

Art.-Nr. art.-no.	Lichtfarbe light colour	Preis € price €
9573	weiß / white	1.646,00

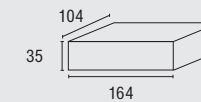

9573





Lichtleiter-Exklusiv-Sets / fibre optics-exklusive-sets

„Aqua-Dream-Set“ bestehend aus / consisting of:
 1x Projektor 100W Halogen inkl. Hitzefilter und Motor (L 270 x B 155 x H 100mm)
 1x Farbrad farbig (funken) / 1x colour wheel coloured (sparks)
 1x Faserbündel: 30x 2mm; Länge 2,0m / 1x fibre bundle: 30x 2mm; length 2,0m
 30x Austrittselemente Art. 973000 / 30x light exit elements art.-no. 973000

Zur Bestückung von ca. 1-2m² / for the assembly of approx. 1-2m²

Art.-Nr. art.-no.	Lichtaustritt light exit	Preis € price €
9601.05	gold / gold	1.492,50
9601.15	nickel matt / nickel satin	1.492,50



9601...

Lichtleiter-Exklusiv-Sets / fibre optics-exklusive-sets

„Ambiente-Set“ bestehend aus / consisting of:
 1x Projektor 100W Halogen inkl. Hitzefilter und Motor (L 270 x B 155 x H 100mm)
 1x Farbrad farbig / 1x colour wheel coloured
 1x Faserbündel: 25x 2mm; Länge 2,0m, 25x 2mm; Länge: 3,0m
 1x fibre bundle: 25x 2mm; length 2,0m, 25x 2mm; length: 3,0m
 25x Austrittselemente Art. 973000, 25x Austrittselemente Art. 973100
 25x light exit elements art.-no. 973000, 25x light exit elements art.-no. 973100

Zur Bestückung von ca. 2-3m² / for the assembly of approx. 2-3m²

Art.-Nr. art.-no.	Lichtaustritt light exit	Preis € price €
9602.05	gold / gold	1.957,60
9602.15	nickel matt / nickel satin	1.957,60

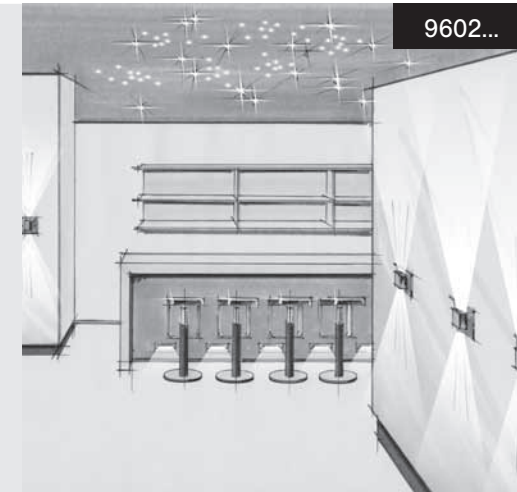

9602...

Lichtleiter-Exklusiv-Sets / fibre optics-exklusive-sets

„Wellness-Set“ bestehend aus / consisting of:
 1x Projektor 100W Halogen inkl. Hitzefilter und Motor (L 270 x B 155 x H 100mm)
 1x Farbrad farbig / 1x colour wheel coloured
 1x Faserbündel: 100x 1mm; Länge: 3,0m, 50x 2mm; Länge: 3,0m
 1x fibre bundle: 100x 1mm; length: 3,0m, 50x 2mm; length: 3,0m
 10x Austrittselemente Art. 973000, 30x Austrittselemente Art. 973100,
 10x Austrittselemente Art. 973300
 10x light exit elements art.-no. 973000, 10x light exit elements art.-no. 973100,
 10x light exit elements art.-no. 973300

Zur Bestückung von ca. 3-4m² / for the assembly of approx. 3-4m²

Art.-Nr. art.-no.	Lichtaustritt light exit	Preis € price €
9603.05	gold / gold	2.309,10
9603.15	nickel matt / nickel satin	2.309,10

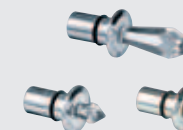

9603...

MODU
ELECTRO
www.modulelectro.ru

9802...

Direkte Wand-/ Deckenmontage / direct wall-/ ceiling mounting

Netzspannung: 230V / mains voltage: 230V
 Größe: Ø 100cm, Ausladung 12cm / dimensions: Ø 100cm, projection 12cm
 bestückt mit / equipped with:
 1x Projektor 100W Halogen inkl. Hitzefilter / 1x projector 100W Halogen incl. thermal filter
 1x Faserbündel / fibre bundle: 100x 1mm, 20x 2mm, 10x 3mm
 10x Kristall / crystal 11mm
 Farbe: nickel matt / colour: nickel satin

weitere RAL-Farben auf Anfrage möglich / more RAL-colours available on request

montagefertig (inkl. Gehäuse) / ready for assembly (incl. housing)

Art.-Nr. art.-no.	Lichtfarbe light colour	Preis € price €
9802B	blau / blue	2.392,00
9802O	orange / orange	2.392,00

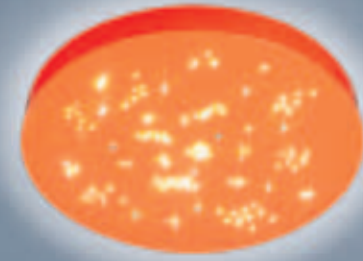

980800

Sternenhimmel / starry sky

Material: Kunststoff / material: plastic
 Farbe der Einlage: weiß / colour of insert: white
 Netzspannung: 230V / mains voltage: 230V
 Größe / dimensions: 62,5 x 62,5cm

bestückt mit / equipped with:
 1x 9513W / 1,0W LED; 33 Lichtpunkte = Weiß, insgesamt 33 Lichtpunkte à 1,0mm
 1x 9513W / 1,0W LED; 33 light points = white, a total of 33 light points à 1,0mm

montagefertig (inkl. Gehäuse) / ready for assembly (incl. housing)

Art.-Nr. art.-no.	Lichtfarbe light colour	Preis € price €
980800	weiß / white	268,00

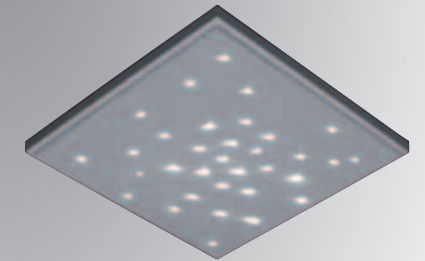

9803...

Direkte Wand-/ Deckenmontage / direct wall-/ ceiling mounting

Netzspannung: 230V / mains voltage: 230V
 Größe: 100x100cm, Ausladung 12cm / dimensions: 100x100cm, projection 12cm
 bestückt mit / equipped with:
 3 LED-Projektoren / 3 LED-projectors
 2x 9513W, 1x 9513B (3x 1Watt); 66 Lichtpunkte weiß, 33 Lichtpunkte blau
 insgesamt 99 Lichtpunkte à 1,0mm
 2x 9513W, 1x 9513B (3x 1Watt); 66 light points white, 33 light points blue
 a total of 99 light points à 1,0mm

weitere RAL-Farben auf Anfrage möglich / more RAL-colours available on request

montagefertig (inkl. Gehäuse) / ready for assembly (incl. housing)

Art.-Nr. art.-no.	Lichtfarbe light colour	Preis € price €
9803B	blau / blue	1.078,00
9803S	silber / silver	1.078,00

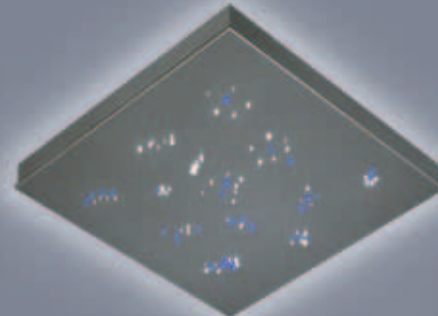

980900

Sternenhimmel / starry sky

Material: Kunststoff / material: plastic
 Farbe der Einlage: weiß / colour of insert: white
 Netzspannung: 230V / mains voltage: 230V
 Größe / dimensions: 62,5 x 62,5cm

bestückt mit / equipped with:
 1x 9510W / 1,0W LED; 15 Fasern = 0,5mm, 20 Fasern = 0,75mm, 10 Fasern = 1,0mm
 5 Fasern = 1,5mm, insgesamt 50 Lichtpunkte in Weiß
 1x 9510W / 1,0W LED; 15 fibres = 0,5mm, 20 fibres = 0,75mm, 10 fibres = 1,0mm
 5 fibres = 1,5mm, a total of 50 light points white

montagefertig (inkl. Gehäuse) / ready for assembly (incl. housing)

Art.-Nr. art.-no.	Lichtfarbe light colour	Preis € price €
980900	weiß / white	317,00

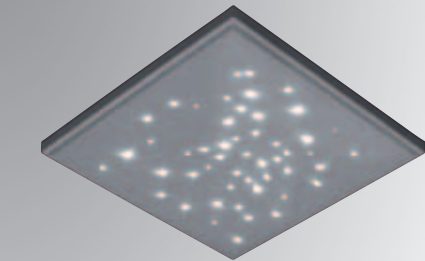

9804...

Direkte Wand-/ Deckenmontage / direct wall-/ ceiling mounting

Netzspannung: 230V / mains voltage: 230V
 Größe: 100x75cm, Ausladung 14cm / dimensions: 100x75cm, projection 14cm
 bestückt mit / equipped with:
 2 LED-Projektoren / 2 LED-projectors
 1x 9513W, 1x 9513B (2x 1Watt); 33 Lichtpunkte weiß, 33 Lichtpunkte blau
 insgesamt 33 Lichtpunkte à 1,0mm
 1x 9513W, 1x 9513B (2x 1Watt); 33 light points white, 33 light points blue
 a total of 66 light points à 1,0mm

weitere RAL-Farben auf Anfrage möglich / more RAL-colours available on request

montagefertig (inkl. Gehäuse) / ready for assembly (incl. housing)

Art.-Nr. art.-no.	Lichtfarbe light colour	Preis € price €
9804B	blau / blue	538,00
9804S	silber / silver	538,00

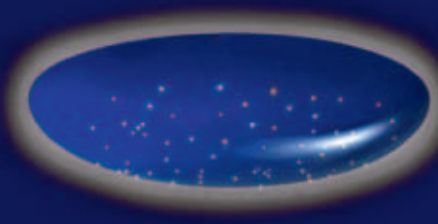

981000

Sternenhimmel / starry sky

Material: Kunststoff / material: plastic
 Farbe der Einlage: weiß / colour of insert: white
 Netzspannung: 230V / mains voltage: 230V
 Größe / dimensions: 62,5 x 62,5cm

bestückt mit / equipped with:
 1x 9511W / 1,0W LED; 8 Lichtpunkte = Weiß, Faserdurchmesser = 2,0mm
 1x 9511W / 1,0W LED; 8 light points = white, diameter of fibre = 2,0mm

montagefertig (inkl. Gehäuse) / ready for assembly (incl. housing)

Art.-Nr. art.-no.	Lichtfarbe light colour	Preis € price €
981000	weiß / white	317,00

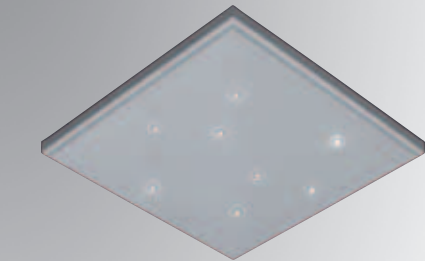

941000 / 941100

Projektor 50W Halogen / projector 50W Halogen

941000 50W Halogen

941100 50W Halogen inkl. Motor für Farbrad / incl. motor for colour wheel

Leuchtmittel / bulb: QR-CB 51 / 50W, Fassung / socket: GX 5,3
 Netzspannung / mains voltage: 230V
 Lampenspannung / voltage of lamp: 12V
 Aluminiumgehäuse, Farbe RAL 9006 / aluminium housing, colour RAL 9006
 inkl. 1,5m Anschlussleitung mit Schuko-Stecker / incl. 1,5m connexion with earthing type plug
 Schutzart / art of protection: IP20
 elektronischer Transformator (dimmbar) / electronic transformer (dimmbable)

Art.-Nr. art.-no.	Preis € price €
941000	415,30
941100	459,60

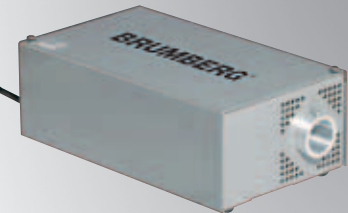
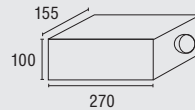

941400 / 941500

Projektor 100W Halogen / projector 100W Halogen

941400 100W Halogen

941500 100W Halogen inkl. Motor für Farbrad / incl. motor for colour wheel

Leuchtmittel / bulb: Reflektor MR16/100W, Fassung / socket: GZ 6,35
 Netzspannung / mains voltage: 230V
 Lampenspannung / voltage of lamp: 12V
 Aluminiumgehäuse, Farbe RAL 9006 / aluminium housing, colour RAL 9006
 inkl. 1,5m Anschlussleitung mit Schuko-Stecker / incl. 1,5m connexion with earthing type plug
 Schutzart / art of protection: IP20
 elektronischer Transformator (dimmbar) / electronic transformer (dimmbable)

Art.-Nr. art.-no.	Preis € price €
941400	528,90
941500	572,10

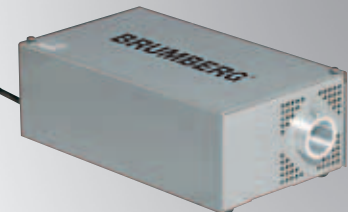
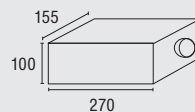

940600 / 940800

Projektor 150W HQI / projector 150W HQI

940600 150W HQI

940800 150W HQI inkl. Motor für Farbrad / incl. motor for colour wheel

Leuchtmittel / bulb: HQI-R / 150W
 Netzspannung / mains voltage: 230V
 Stahlblechgehäuse, Farbe grau/schwarz / sheet steel housing, colour grey/black
 inkl. 1,5m Anschlussleitung mit Schuko-Stecker / incl. 1,5m connexion with earthing type plug
 Schutzart / art of protection: IP20

Art.-Nr. art.-no.	Preis € price €
940600	1.674,00
940800	1.908,00

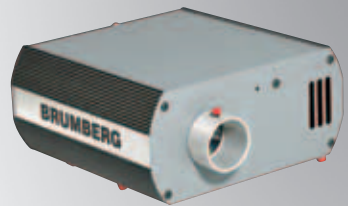
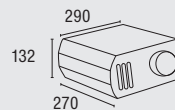

Farbräder für Projektoren



932000 € 31,40

Klar / clear

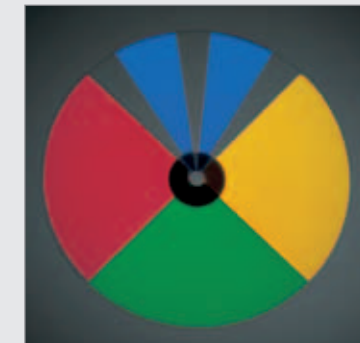

932100 € 43,40

Farbig / coloured



932200 € 43,40

Farbig Funken / coloured sparks

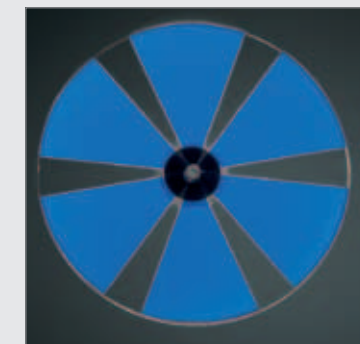

932300 € 42,30

Blau/Klar/Funken / blue/clear/sparks



932400 € 42,30

Schwarz/Klar/ Funken / black/clear/sparks

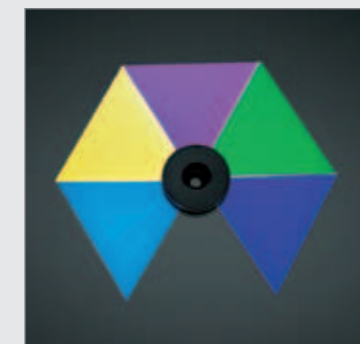

932600 € 85,50

nur für Projektor 940800 / only for projector 940800

MODUL ELECTRO
 www.modulelectro.ru

9419W



LED-Projektor / LED-projector

Material: Metall / material: metal, Farbe: schwarz / colour: black
 Bestückung / assembly: 3x LED Rebel (je / each 1,2W)
 Schutzart / art of protection: IP20

inkl. ca. 1,5m Anschlussleitung / incl. 1,5m connexion
 für 230V Direktanschluss / for 230V direct connexion
 ohne Lüfter / without ventilator
 Auch in anderen Lichtfarben lieferbar / also available in other light colours

Art.-Nr. art.-no.	Lichtfarbe light colour	Preis € price €
9419W	weiß / white	212,00

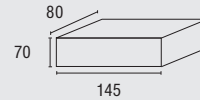

9419RGB



LED-Projektor / LED-projector

Material: Metall / material: metal, Farbe: silber / colour: silver
 Bestückung / assembly: 3x RGB LED, Fullcolour (13,8W)
 Lichtfarbe / light colour: Rot-Grün-Blau (in RGB-Schaltung) / red-green-blue (in RGB switching)
 Schutzart / art of protection: IP20

inkl. ca. 1,5m Anschlussleitung / incl. 1,5m connexion
 für 230V Direktanschluss / for 230V direct connexion
 inkl. IR-Fernbedienung zur Steuerung der Lichtfarben, bzw. Laufgeschwindigkeit
 (zwischen IR-Empfänger und IR-Fernbedienung muss Sichtverbindung bestehen / 10,0 mtr.)
 incl. IR-remote control to control the light colours, respectively progressing speed
 (Intervisibility between IR-receiver and IR-remote is needed / 10,0 mtr.)
 ohne Lüfter / without ventilator

Art.-Nr. art.-no.	Lichtfarbe light colour	Preis € price €
9419RGB	RGB	598,00

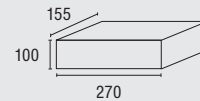

9419RGB-Slave

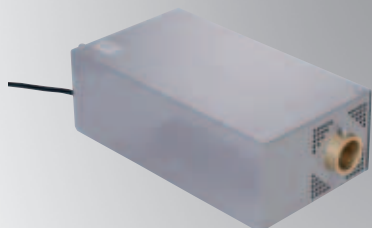

LED-Projektor / LED-projector

Funktion nur in Verbindung mit Art. 9419RGB möglich!
 Operation only possible in connection with art.-no. 9419RGB!

Material: Metall / material: metal, Farbe: silber / colour: silver
 Bestückung / assembly: 3x RGB LED, Fullcolour (13,8W)
 Lichtfarbe / light colour: Rot-Grün-Blau (in RGB-Schaltung) / red-green-blue (in RGB switching)
 Schutzart / art of protection: IP20

inkl. ca. 1,5m Anschlussleitung / incl. 1,5m connexion
 für 230V Direktanschluss / for 230V direct connexion
 Steuerung der Lichtfarben erfolgt über den Projektor 9419RGB
 (Synchronlauf von mehreren LED-RGB- Projektoren beim Farbwechsel)
 The control of the light colours is effected by the projector 9419RGB
 (Synchronization of several LED-RGB projectors by colour changing)
 ohne Lüfter / without ventilator

Art.-Nr. art.-no.	Lichtfarbe light colour	Preis € price €
9419RGB-Slave	RGB	598,00

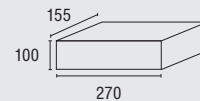

Verbindungsleitung für 9419RGB und 9419RGB-Slave
 connexion cable for 9419RGB and 9419RGB-Slave

Verbindungsleitung zwischen LED/RGB Master und LED/RGB Slave Projektor,
 bzw. LED/RGB Slave Projektor und LED/RGB Slave Projektor

Länge: 1,0m

connexion cable between LED/RGB Master and LED/RGB Slave projector,
 respectively LED/RGB Slave projector and LED/RGB Slave projector

length: 1,0m

Art.-Nr. art.-no.	Preis € price €
3831	8,90

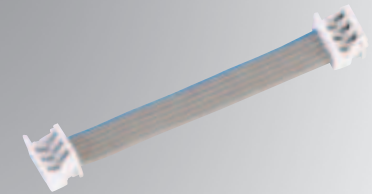

3831

LED/RGB Projektor „Komfort“ / LED/RGB projector „comfort“

Leuchtmittellebensdauer: 25.000 Std. bei T_A=25°
 lifespan of bulb: 25.000 hours when T_A=25°

Leuchtmittel: 3x 4W, RGB 3 in 1 Chip / bulb: 3x 4W, RGB 3 in 1 Chip

Netzspannung: 230V, Lampenspannung: 12V / DC

mains voltage: 230V, voltage of lamp: 12V / DC

Aluminiumgehäuse, Farbe schwarz / aluminium housing, colour black

inkl. 1,5m Anschlussleitung mit Schukostecker

incl. 1,5m connexion with earthing type plug

Schutzart / art of protection: IP20

Steuerung der Lichtfarben über separatem Drehschalter
 inkl. Edelstahlabdeckung für 68mm Schalterklemmdose
 Control of light colours by separate redary switch
 incl. cover in stainless steel for 68mm-box cavity wall socket

Funktionen des Drehschalters:
 Stellung 1: Aus, Stellung 2: Komfort - Programm: 12 Minuten
 fester Farbdurchlauf jeweils 3min rot/gelb/grün/blau, Stellung 3: Rot,
 Stellung 4: Gelb, Stellung 5: Grün, Stellung 6: Blau
 Funtion of redary switch:
 position 1: off, position 2: comfort - program: 12 minutes steady flow
 of colours each 3min red/gelb/green/blue, position 3: red, position 4: yellow,
 position 5: green, position 6: blue

ohne Lüfter / without ventilator

Art.-Nr. art.-no.	Preis € price €
9425	1.646,00

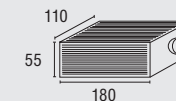

9425

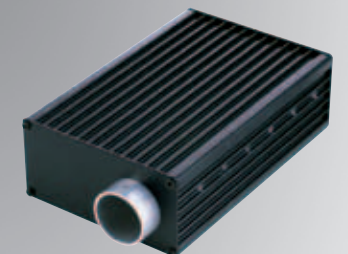



1. Lichtpunkte verteilen und Löcher bohren
1. Arrange the light points and drill the holes



2. Fasern in Löcher stecken
2. Put the fibers into the holes



3. Fasern von oben verkleben
3. Stick the fibres from the upside



4. Fasern auf unterer Seite kürzen
(3-5mm heraus stehen lassen)
4. Cut the fibres from the downside
(they have to be stuck out 3-5 mm)

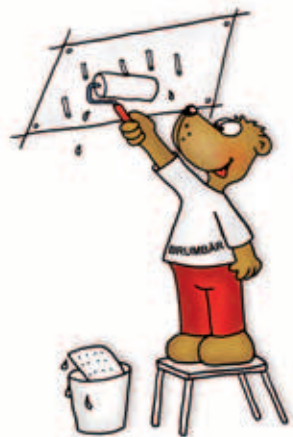

5. Nach evtl. Deckenanstrich Fasern ca. 1mm kürzen
5. If you do a ceiling coating, please cut the fibres afterwards to app. 1 mm



6. Sternenhimmel einschalten und staunen!
6. Switch-on the starry sky and be amazed!

Und hier noch ein paar heiße Tipps zum Thema „Fasertechnik“:

- einfache Installation der Faser; z.B. bei 1,0mm Faserstärke Bohrung von 1,2 oder 1,3mm vornehmen
- Faserstärke von 0,5 bis 3,0mm lieferbar
- bei Deckengrößen bis 10m² empfehlen wir 50 Fasern/m², darüber hinaus reichen 30 bis 40 Fasern/m²
- verkleben Sie die einzelnen Fasern von hinten, so können sie nicht herausgezogen werden
- benutzen Sie hochwertigen Kleber, z.B. UHU Holzleim oder UHU plus sofortfest, (2-Komponenten Kleber (Lösungsmittel frei)
- bis zu 500 Fasern mit der Stärke 1,0mm und einer Länge von 20m finden in einem Projektor Platz
- wählen Sie einen zentralen Platz für den Projektor, so dass die Faserlänge so kurz wie möglich gewählt werden kann
- bei Außenanwendungen immer ummantelte Faser verwenden

Some hot tips to the 'fibre optics' subject:

- easy fibre installation, e.g. for 1.0 mm fibre strength drill a hole of 1.2 or 1.3 mm!
- fibre strengths from 0.5 up to 3.0 mm available
- we recommend 50 fibres / m² for a ceiling area up to 10 m², above all, 30 up to 40 fibres / m² are adequate
- glue the single fibres from behind, hence, they cannot be unplugged
- use high-quality adhesive, e.g. UHU wood glue or UHU plus sofort fest, 2-component adhesive (solvent-free)
- up to 500 fibres with a diameter of 1.0 mm and a length of 20 m can be placed into one projector
- please choose a central place for your projector's location, to be able to take the fibre lengths as short as possible
- for outdoor applications, the protective tube has to be used every time

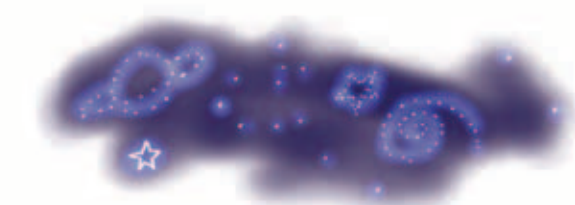

**Wir holen Ihnen
die Sterne vom Himmel!**

Reach for the stars!

Die Faser hat verblüffende Eigenschaften

- Sie leitet das Licht über viele Meter (max. 20,0m) bei fast gleichbleibender Lichtqualität.
- Sie führt weder elektrische Spannung, noch überträgt sie UV- und IR-Strahlung.
- Aus dem weiten Spektrum der elektromagnetischen Strahlung nimmt das menschliche Auge nur den schmalen Bereich von 380 bis 780nm auf. Genau diesen Bereich transportiert die PMMA-Faser.

Der Transport des Lichtes beruht auf Totalreflexion.

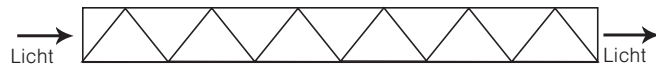

- Die Faser transportiert ausschließlich Licht, dass heißt, keine Spannung und keine Temperatur.

Daraus ergibt sich:

- elektrische Trennung von Lichtquelle und Lichtaustritt
- kein elektrisches Potential am Lichtaustritt, keine aufwendigen Schutzmaßnahmen am Lichtaustritt notwendig
- keine Temperatur am Lichtaustritt (keine Deckenfärbung)
- Beachten Sie, dass der Faserendpunkt nicht höheren Temperaturen als 80°C ausgesetzt wird
- Die Faser darf ausschließlich mit lösungsmittelfreiem 2-Komponentenkleber fixiert werden
- Beim Einsatz der Faser im Außenbereich muss die Faser mit Ummantelung eingesetzt werden [als mechanischer Schutz und als Schutz vor Sonneneinstrahlung (UV)].
- Durch die Einspeisung von bis zu 500 Fasern (1,0mm) in einen Projektor ergibt sich eine sehr hohe Wirtschaftlichkeit durch geringen Stromverbrauch

Die Bündelung verschiedener Fasergrößen und Längen (S0 - S33M) in einer Konnektoraufnahme (Art-Nr. 900000) ist möglich. Stellen Sie sich Ihr persönliches Faserbündel zusammen.

Unsere Planungsabteilung steht Ihnen jederzeit zur Verfügung!

The fibre combines amazing features

- it transmits the light over many metres (max. 20m) in a constant light quality.
- it carries no electricity, nor does it transmit ultraviolet or infrared radiation.
- in the wide spectrum of electromagnetic radiation, the human eye is able to make visible only a small part of 380 up to 780 nm. Exactly this part is carried by the PMMA- fibre.

The light transfer is based on total reflection:



- The fibre solely transfers light, which means no: no voltage and no temperature.

This results from:

- the electrical separation of light source and light exit
- no electrical potential at the light exit
- laborious safety measures at the light exit not necessary
- no temperature at the light exit (no discolouration of ceiling)
- Please note that the fibre ends should not be exposed to a temperature higher than 80°C.
- The fibre should solely be fixed by solvent-free 2-component glue.
- If the fibre is to be installed outdoors, the sheathed fibre must be used (as mechanical predection as well as predection against solar radiation (ultraviolet radiation)
- Feeding a projector with up to of 500 fibres, it causes a high efficiency with low power consumption.

It is possible to combine different sizes and length:s of fibre (S0 – S3M) in one connector (item no. 9000). Compose your own personal fibre bundle.

Our planning department will be at your disposal at any time!

Maximale Bündelung pro Konnektor / maximum bunching per connector

S0	S2	S3	S1	S2M	S3M	S19M	S33M	S50M
500	150	50	300	130	45	25	15	8

Bündelung der Faser im Konnektorkopf (Art.-Nr. 900000)

Dient zur Aufnahme der Faser am Projektor inkl. ablängen der Fasern, verschweißen, vergießen und polieren

bunching of fibre in connector (art.-no. 900000)

It is for connecting the fibre to the projector. Incl. cutting, fixing and polishing.

Art.-Nr. art.-no.	Preis € price €
900000	195,00

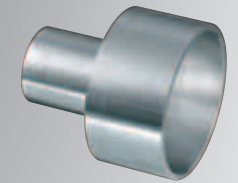

900000

Art.-Nr. / art.-no.: 910000 (S0)

Faser / fibre: 1,0mm
Aktiver Kern / active core: 1,0mm
Biegeradius / bending radius: 5,0mm
Bohrdurchmesser / drilling diameter: 1,1mm

Art.-Nr. art.-no.	Preis € price €
910000	0,90



910000

Art.-Nr. / art.-no.: 910200 (S2)

Faser / fibre: 2,0mm
Aktiver Kern / active core: 2,0mm
Biegeradius / bending radius: 10,0mm
Bohrdurchmesser / drilling diameter: 2,2mm

Art.-Nr. art.-no.	Preis € price €
910200	4,90



910200

Art.-Nr. / art.-no.: 910400 (S3)

Faser / fibre: 3,0mm
Aktiver Kern / active core: 3,0mm
Biegeradius / bending radius: 15,0mm
Bohrdurchmesser / drilling diameter: 3,2mm

Art.-Nr. art.-no.	Preis € price €
910400	10,80



910400

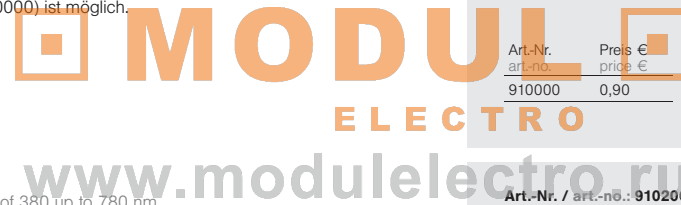



910100

Art.-Nr. / art.-no.: 910100 (S1)
 Faser / fibre: 1,0mm
 mit Schutzschlauch / with protective tube
 Aktiver Kern / active core: 1,0mm
 Gesamtdurchmesser / total diameter: 3,0mm
 Biegeradius / bending radius: 10,0mm
 Bohrdurchmesser / drilling diameter: 1,9mm

Art.-Nr. art.-no.	Preis € price €
910100	4,30



910600

Art.-Nr. / art.-no.: 910600 (S19M)
 Faser / fibre: 5,0mm
 mit Schutzschlauch / with protective tube
 bestehend aus / consisting of: 19x 1,0mm
 Aktiver Kern / active core: 5,0mm
 Gesamtdurchmesser / total diameter: 8,0mm
 Biegeradius / bending radius: 25,0mm
 Bohrdurchmesser / drilling diameter: 7,7mm

Art.-Nr. art.-no.	Preis € price €
910600	21,60

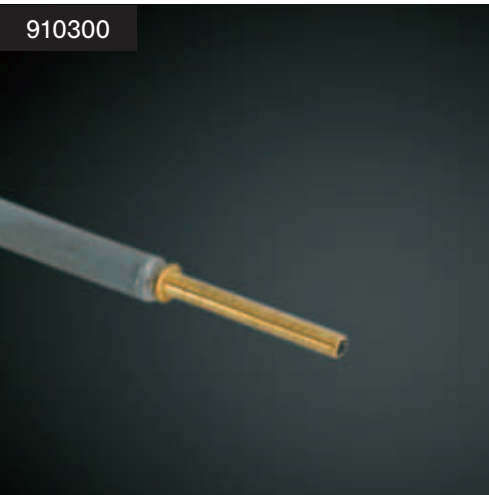

910300

Art.-Nr. / art.-no.: 910300 (S2M)
 Faser / fibre: 2,0mm
 mit Schutzschlauch / with protective tube
 Aktiver Kern / active core: 2,0mm
 Gesamtdurchmesser / total diameter: 4,0mm
 Biegeradius / bending radius: 15,0mm
 Bohrdurchmesser / drilling diameter: 2,9mm

Art.-Nr. art.-no.	Preis € price €
910300	8,30

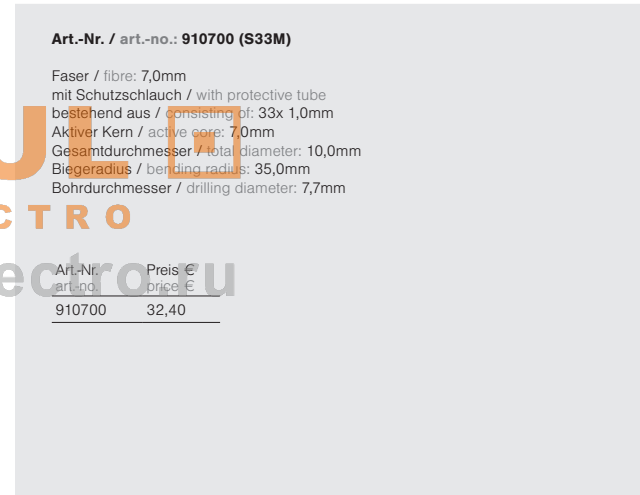

910700

Art.-Nr. / art.-no.: 910700 (S33M)
 Faser / fibre: 7,0mm
 mit Schutzschlauch / with protective tube
 bestehend aus / consisting of: 33x 1,0mm
 Aktiver Kern / active core: 7,0mm
 Gesamtdurchmesser / total diameter: 10,0mm
 Biegeradius / bending radius: 35,0mm
 Bohrdurchmesser / drilling diameter: 7,7mm

Art.-Nr. art.-no.	Preis € price €
910700	32,40

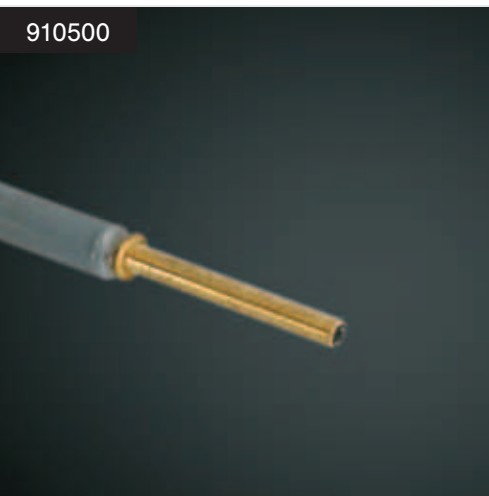

910500

Art.-Nr. / art.-no.: 910500 (S3M)
 Faser / fibre: 3,0mm
 mit Schutzschlauch / with protective tube
 Aktiver Kern / active core: 3,0mm
 Gesamtdurchmesser / total diameter: 5,0mm
 Biegeradius / bending radius: 20,0mm
 Bohrdurchmesser / drilling diameter: 3,9mm

Art.-Nr. art.-no.	Preis € price €
910500	16,10



910800

Art.-Nr. / art.-no.: 910800 (S50M)
 bestehend aus / consisting of: 15x 0,5mm, 20x 0,75mm, 10x 1,0mm, 5x 1,5mm
 Gesamtdurchmesser / total diameter: 10,0mm
 Biegeradius / bending radius: 25,0mm

Mischfaser / mixed fibre

Art.-Nr. art.-no.	Preis € price €
910800	32,40

MODU
ELECTRO
www.modulelectro.eu

9760...

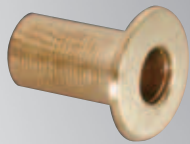

Messing Hülse zu 975100 / brass sleeve for 975100

Aussendurchmesser / outer diameter: 9mm
 Höhe / height: 1mm
 Einbautiefe ohne 975100 / installation depth without 975100: 8mm
 Einbautiefe mit 975100 / installation depth with 975100: 20mm
 Bohrdurchmesser / drilling diameter: 5mm bis 5,5mm
 je nach Material! depending on material!
 Befestigung: Kleben / mounting: glue

Art.-Nr. art-no.	Farbe colour	Preis € price €
9760.02	chrom / chrome	7,90
9760.05	gold / gold	8,70



Montage Hülse zu 975200 / mounting sleeve for 975200

Material: Kunststoff / material: plastic
 Länge / length: ca. 150mm
 Aussendurchmesser / outer diameter: 5mm

Art.-Nr. art-no.	Preis € price €
973700	5,70

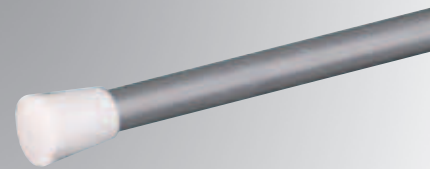

910600

975100

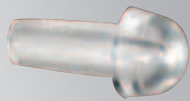

Acryl Dome für Faser S0 / acryl dome for fibre S0

Aussendurchmesser / outer diameter: 5mm
 Höhe / height: 4mm
 Einbautiefe ohne Faser / installation depth without fibre: 20mm
 Bohrdurchmesser / drilling diameter: 3mm bis 4mm
 je nach Material! depending on material!
 Befestigung: Kleben / mounting: glue

Art.-Nr. art-no.	Preis € price €
975100	1,30



Montage Hülse zu 975400 / mounting sleeve for 975400

Aussendurchmesser / outer diameter: 14mm, Höhe / height: 1mm
 Einbautiefe ohne 975400: 9mm, Einbautiefe mit 975400: 30mm
 installation depth without 975400: 9mm, installation depth with 975400: 30mm
 Bohrdurchmesser / drilling diameter: 9mm bis 10mm
 je nach Material! depending on material!
 Befestigung: Kleben / mounting: glue

Art.-Nr. art-no.	Farbe colour	Preis € price €
9761.02	chrom / chrome	8,40
9761.05	gold / gold	9,10



9761...



975200

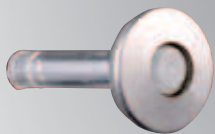

Austrittselement für Faser S0 / light exit element for fibre S0

Einsatzbereich: Sauna / application area: sauna
 Material: Kunststoff/Metall / material: plastic / metal
 Aussendurchmesser / outer diameter: 16mm
 Höhe / height: 3mm
 Einbautiefe ohne Faser / installation depth without fibre: 28mm
 Einbautiefe mit Faser / installation depth with fibre: 40mm
 Bohrdurchmesser / drilling diameter: 4,5mm bis 5,5mm
 je nach Material! depending on material!
 Befestigung: Kleben / mounting: glue

Art.-Nr. art-no.	Preis € price €
975200	3,60

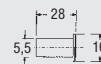

Acryl Dome für Faser S2 / mounting sleeve for 975400

Aussendurchmesser / outer diameter: 10mm, Höhe / height: 4mm
 Einbautiefe ohne Faser: 8mm, Einbautiefe mit Faser: 30mm
 installation depth without fibre: 8mm, installation depth with fibre: 30mm
 Bohrdurchmesser / drilling diameter: 7mm bis 8mm
 je nach Material! depending on material!
 Befestigung: Kleben / mounting: glue

Art.-Nr. art-no.	Preis € price €
975400	1,50



975400

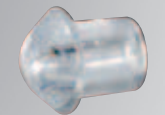

MODUL
ELECTRO
www.modulelectro.ru

9794...

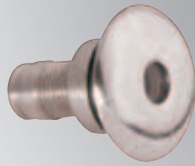

Sauna Lichtpunkt / sauna light point

Material: Edelstahl/Glas / material: stainless steel/glass
 Aussendurchmesser / outer diameter: 27mm
 Höhe / height: 3mm
 Bohrdurchmesser / drilling diameter: 18mm
 Einbautiefe inkl. Faser / installation depth incl. fibre: 120mm
 Für Faser / for fibre: S3M / S19M / S33M
 Befestigung: Kleben / mounting: glue

Art.-Nr. art-no.	Farbe colour	Preis € price €
9794.22	edelstahl / stainless steel	68,30



Austrittselement für Faser S2 und S2M / light exit element for fibre S2 und S2M

Aussendurchmesser / outer diameter: 17,5mm
 Bohrdurchmesser / drilling diameter: 10mm
 Höhe / height: 1,5mm
 Einbautiefe ohne Faser / installation depth without fibre: 19mm
 Einbautiefe mit Faser / installation depth with fibre: 50mm
 Befestigung: Kleben / mounting: glue

Art.-Nr. art-no.	Farbe colour	Preis € price €
9728.05	gold / gold	11,90
9728.15	nickel matt / nickel satin	11,10

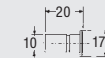

9728...



9779...



Mini-Bodeneinbauleuchte / mini-ground light

Material: Edelstahl/Glas / material: stainless steel/glass
 Aussendurchmesser / outer diameter: 27mm
 Bohrdurchmesser / drilling diameter: 14mm
 Einbautiefe inkl. Faser / installation depth incl. fibre: 120mm
 Für Faser / for fibre: S3M / S19M / S33M
 Befestigung: Kleben / mounting: glue

Art.-Nr. art-no.	Farbe colour	Preis € price €
9779.22	edelstahl / stainless steel	56,70



Austrittselement für Faser S19M und S33M / light exit element for fibre S19M und S33M

Material: Messing / material: brass
 Aussendurchmesser / outer diameter: 17,5mm
 Bohrdurchmesser / drilling diameter: 10mm
 Höhe / height: 1,5mm
 Einbautiefe ohne Faser / installation depth without fibre: 19mm
 Einbautiefe mit Faser / installation depth with fibre: 120mm
 Befestigung: Kleben / mounting: glue

Art.-Nr. art-no.	Farbe colour	Preis € price €
9729.05	gold / gold	11,90
9729.15	nickel matt / nickel satin	11,10

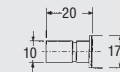

9729...



974800



Unterwasser Strahler / underwater spot

Material: Edelstahl/Messing/Glas / material: stainless steel/brass/glass
 Farbe: edelstahl / colour: stainless steel
 Aussendurchmesser / outer diameter: 45mm
 Höhe / height: 1mm
 Bohrdurchmesser / drilling diameter: 32mm
 Einbautiefe inkl. Faser / installation depth incl. fibre: 150mm
 Für Faser / for fibre: S19M
 Befestigung: Schrauben / mounting: screws

Art.-Nr. art-no.	Farbe colour	Preis € price €
974800	edelstahl / stainless steel	103,00

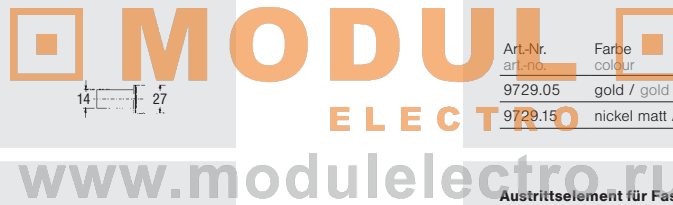

Austrittselement für Faser S19M und S33M / light exit element for fibre S19M und S33M

Material: Messing / material: brass
 Aussendurchmesser / outer diameter: 17,5mm
 Bohrdurchmesser / drilling diameter: 10mm
 Höhe ohne Glaskugel / height without glass bole: 1,5mm
 Einbautiefe ohne Faser / installation depth without fibre: 19mm
 Einbautiefe mit Faser / installation depth with fibre: 50-120mm
 Befestigung: Kleben / mounting: glue

Art.-Nr. art-no.	Farbe colour	Preis € price €
9730.05	gold / gold	13,40
9730.15	nickel matt / nickel satin	13,40



9730...



978800



Spot schwenkbar / spot pivotable

Inkl. optischer Linse / incl. optical lens
 Material: Aluminiumguss / material: aluminium cast
 Farbe: alu-matt / colour: alu-satin
 Aussendurchmesser / outer diameter: 50mm
 Bohrdurchmesser / drilling diameter: 45mm
 Einbautiefe inkl. Faser / installation depth incl. fibre: 120mm
 Für Faser / for fibre: S3M / S19M / S33M
 Befestigung: Federmontage / mounting: clip mounting

Art.-Nr. art-no.	Farbe colour	Preis € price €
978800	alu matt / alu-satin	103,00



Austrittselement mit Kristall für Faser S2 bis S33M / light exit element with crystal for fibre S2 - S33M

Material: Messing / material: brass
 Aussendurchmesser / outer diameter: 17,5mm
 Bohrdurchmesser / drilling diameter: 10mm
 Höhe ohne Kristall / height without crystal: 1,5mm
 Länge des Kristalls / length of the crystal: 11mm
 Einbautiefe ohne Faser / installation depth without fibre: 19mm
 Einbautiefe mit Faser / installation depth with fibre: 50-120mm
 Befestigung: Kleben / mounting: glue

Art.-Nr. art-no.	Farbe colour	Preis € price €
9731.05	gold / gold	15,10
9731.15	nickel matt / nickel satin	15,10

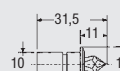

9731...

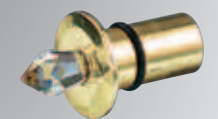

9733...

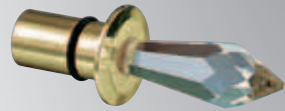

Austrittselement mit Kristall für Faser S2 bis S33M
light exit element with crystal for fibre S2 bis S33M

Material: Messing / material: brass
 Aussendurchmesser / outer diameter: 17,5mm
 Bohrdurchmesser / drilling diameter: 10mm
 Höhe ohne Kristall / height without crystal: 1,5mm
 Länge des Kristalls / length of crystal: 29mm
 Einbautiefe ohne Faser / installation depth without fibre: 19mm
 Einbautiefe mit Faser / installation depth with fibre: 50 bis 120mm
 Befestigung: Kleben / mounting: glue

Art.-Nr. art-no.	Farbe colour	Preis € price €
9733.05	gold / gold	20,30
9733.15	nickel matt / nickel satin	20,30

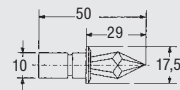

90199



Installations Kit / installation kit

Bestehend aus / consisting of:

- 1x Schneidwerkzeug zur Kürzung der Faser S0, S2 und S3
- 1x cutting tool for fibre S0, S2 und S3
- 10x Bohrsatz für Faser S0
- 10x set with bits for fibre S0
- 1x UHU Holzleim
- 1x UHU wood glue
- 1x UHU plus sofortfest, 2-komponenten Kleber
- 1x UHU plus sofortfest, 2 component glue

Art.-Nr. art-no.	Preis € price €
90199	106,00

973500



Montage Hülse zu 9728 bis 9733
mounting sleeve for 9728 - 9733

Material: Messing / material: brass
 Bohrdurchmesser / drilling diameter: 11,5 - 12mm
 je nach Material!! depending on material!!
 Länge: ca. 29mm / length: approx. 29mm

Art.-Nr. art-no.	Preis € price €
973500	5,50

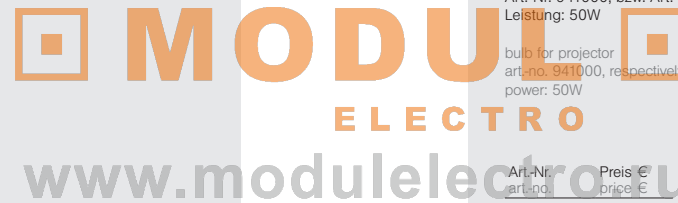

931000

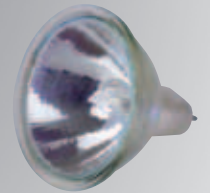

Leuchtmittel 50 Watt / bulb 50 Watt

Leuchtmittel zum Projektor
 Art.-Nr. 941000, bzw. Art.-Nr. 941100
 Leistung: 50W
 bulb for projector
 art-no. 941000, respectively art-no. 941100
 power: 50W

Art.-Nr. art-no.	Preis € price €
931000	9,60

973600



Montage Hülse zu 9728 bis 9733
mounting sleeve for 9728 - 9733

Einsatzbereich: Sauna / application areas: sauna
 Material: Messing / material: brass
 Bohrdurchmesser / drilling diameter: 12,5 - 13mm
 je nach Material!! depending on material!!
 Länge: ca. 100mm / length: approx. 100mm

Art.-Nr. art-no.	Preis € price €
973600	16,10

931200

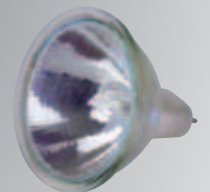

Leuchtmittel 50 Watt / bulb 100 Watt

Leuchtmittel zum Projektor
 Art.-Nr. 941000, bzw. Art.-Nr. 941500
 Leistung: 100W
 bulb for projector
 art-no. 941000, respectively art-no. 941500
 power: 100W

Art.-Nr. art-no.	Preis € price €
931200	38,00

design by **Francesco Domanico**

Seine Ambitionen zur Malerei und sein sagenhaftes Faible für Form und Farbe machen ihn einzigartig. Wir konnten ihn dazu animieren, seine Kreativität in einer völlig neuen Richtung zum Einsatz zu bringen - in der Entwicklung von neuen designorientierten Beleuchtungslösungen. Hochmoderne Lichttechnik und ein Materialmix aus Edelstahl und Acryl waren die Grundidee. Das Ergebnis sind diese faszinierenden Lichtobjekte.

His ambitions concerning painting and his fabulous tendency towards form and colour make him unique. We succeeded in encouraging him to insert his creativity to a completely new direction, namely the development of new design-orientated lighting solutions. Ultra-modern lighting techniques and the composition of stainless steel with acrylic material were the basic idea. The results are these fascinating light objects.



MODU
ELECTRO
www.modulelectro.ru

Faser-Lichtobjekte / fibre-light objects

Material: **Edelstahl / Metall** / material: stainless steel / metal
Farbe: **chrom** / colour: chrome

Montageart: **Wand-/Deckeneinbau, DA 68mm**
type of mounting: wall-/ ceiling mounting, cutout 68mm

inkl. **Hohlwanddose ET-65mm**
incl. in-wall box, installation depth 65mm

Bestückung: **1x Power-LED 1W inkl. Konverter**
assembly: 1x Power-LED 1W incl. converter

Faser **33x 1mm; Länge 200mm**
fibre 33x 1mm; length 200mm

Leuchtgehäuse: **85x85x ET65mm x AL ca. 60mm**
housing: 85x85x installation depth 65mm x projection approx. 60mm

Faserobjekt Durchmesser: **ca. 350mm**
fibre object diameter: approx. 350mm

Art.-Nr. art.-no.	Lichtfarbe light colour	Preis € price €
9885W	weiß / white	179,00
9885B	blau / blue	179,00
9885R	rot / red	179,00
9885G	grün / green	179,00
9885Y	orange / orange	179,00



9885...

Faser-Lichtobjekte / fibre-light objects

Material: **Edelstahl / Metall** / material: stainless steel / metal
Farbe: **chrom** / colour: chrome

Montageart: **Wand-/Deckenaufbau**
type of mounting: wall-/ ceiling surface mounting

Bestückung: **1x Power-LED 1W inkl. Konverter**
assembly: 1x Power-LED 1W incl. converter

Faser **33x 1mm; Länge 200mm**
fibre 33x 1mm; length 200mm

Leuchtgehäuse: **85x85x ET65mm x AL ca. 60mm**
housing: 85x85x installation depth 65mm x projection approx. 60mm

Faserobjekt Durchmesser: **ca. 350mm**
fibre object diameter: approx. 350mm

Art.-Nr. art.-no.	Lichtfarbe light colour	Preis € price €
9886W	weiß / white	199,50
9886B	blau / blue	199,50
9886R	rot / red	199,50
9886G	grün / green	199,50
9886Y	orange / orange	199,50

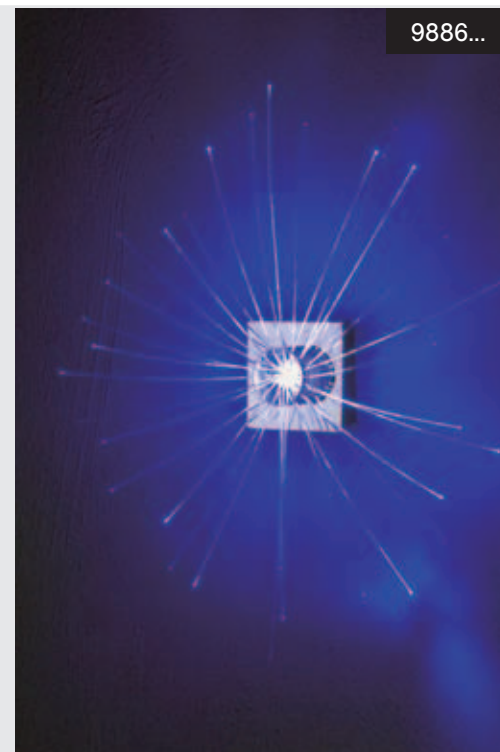

9886...

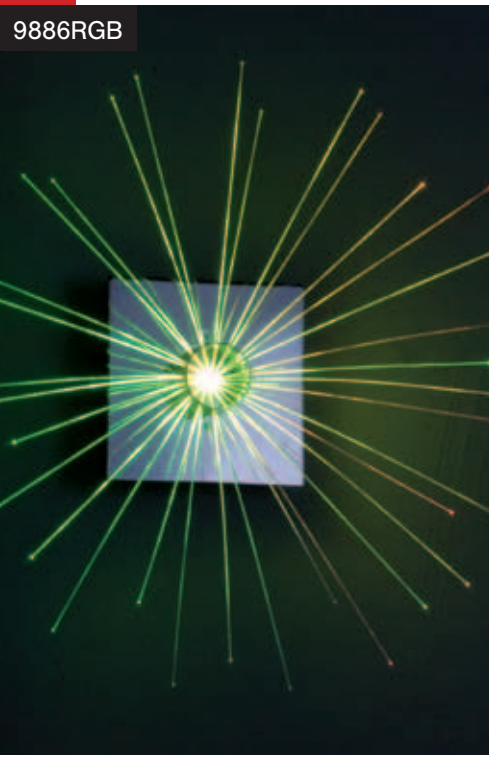

9886RGB

Faser-Lichtobjekt / fibre-light object

Material: Eisen / material: iron
Farbe: chrom / colour: chrome

Montageart: Wand-/Deckenaufbau
type of mounting: wall-/ ceiling surface mounting

Bestückung: 1x RGB-LED Multi Color (3,6W)
inkl. Konverter
assembly: 1x RGB-LED Multi Color (3,6W)
incl. converter

Faser 33x 1mm; Länge 200mm
fibre 33x 1mm; length 200mm

Leuchtgehäuse: 137x137xAL ca. 60mm
housing: 137x137x projection approx. 60mm

Faserobjekt Durchmesser: ca. 450mm
fibre object diameter: approx. 450mm

automatischer Farbdurchlauf, inkl. Start-/Stop-Schalter
automatic colour rotation, incl. start-/stop-switch

Art.-Nr. art.-no.	Lichtfarbe light colour	Preis € price €
9886RGB	RGB	266,50



98710...

Faser-Lichtobjekt / fibre-light object

Material: Edelstahl / Metall / Effektspiegel
material: stainless steel / metal / effect mirror
Farbe: edelstahl gebürstet / colour: stainless steel brushed

Montageart: Aufbau, Wand- und Deckenmontage
type of mounting: wall-/ ceiling surface mounting

Bestückung: 4 x Power-LED 1W inkl. Konverter
assembly: 4 x Power-LED 1W incl. converter

Faser 132x 1mm; Länge 500mm
fibre 132x 1mm; length 500mm

Leuchtgehäuse: 200x200x50mm
housing: 200x200x50mm

Deckenleuchte: 300x300x125mm
ceiling lamp: 300x300x125mm

Tischleuchte auf Anfrage erhältlich!
table lamp available on request!

Art.-Nr. art.-no.	Lichtfarbe light colour	Preis € price €
98710WW	weiß weiß / white white	575,50
98710WB	weiß blau / white blue	575,50
98710WR	weiß rot / white red	575,50
98710WG	weiß grün / white green	575,50

MODULELECTRO

www.modulelectro.ru

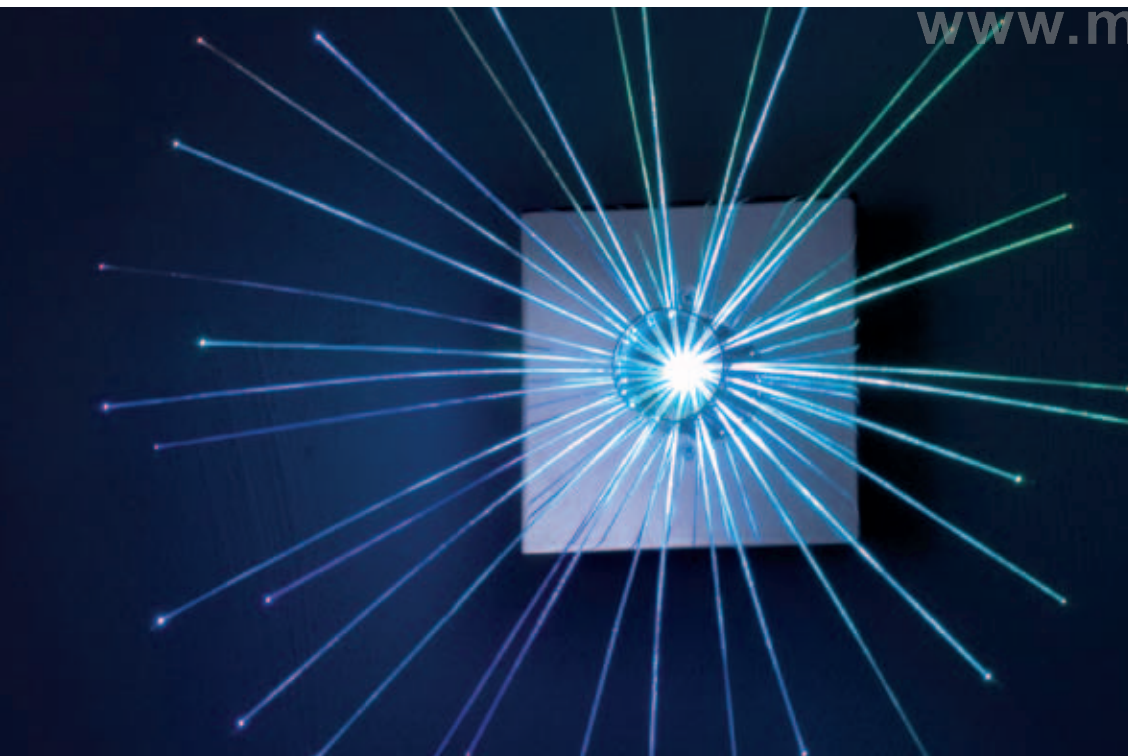

98850...

Faser-Lichtobjekt / fibre-light object

Material: Edelstahl / Metall / Effektspiegel
material: stainless steel / metal / effect mirror
Farbe: edelstahl gebürstet / colour: stainless steel brushed

Montageart: Pendel- / Seillänge 1500mm
type of mounting: pendular- / wire length 1500mm

Bestückung: 4 x Power-LED 1W inkl. Konverter
assembly: 4 x Power-LED 1W incl. converter

Faser 132x 1mm; Länge 500mm
fibre 132x 1mm; length 500mm

Leuchtgehäuse: 200x200x50mm
housing: 200x200x50mm

Deckenleuchte: 300x300x1.625mm (inkl. Pendel)
ceiling lamp: 300x300x1.625mm (incl. pendular)

Art.-Nr. art.-no.	Lichtfarbe light colour	Preis € price €
98850WW	weiß weiß / white white	691,10
98850WB	weiß blau / white blue	691,10
98850WR	weiß rot / white red	691,10
98850WG	weiß grün / white green	691,10

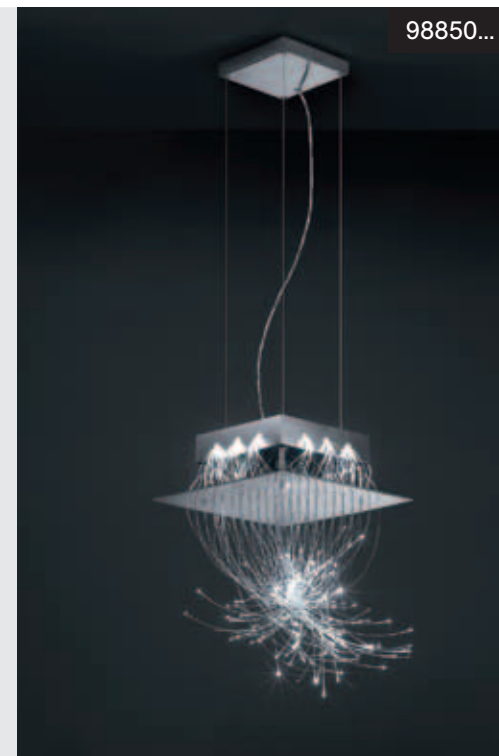



Designvielfalt für den Außenbereich.
Gestalten Sie Wege, Terrassen, Parkplätze
und setzen Sie Akzente mit unseren Outdoor-Leuchten.

Variety in design for outdoor areas. Create lanes,
terraces, parking sites and set a course
with our outdoor – lights.

MODUL
ELECTRO
www.modulelectro.ru



Privathaus, Münster

Außenleuchten V4A | outdoor lighting V4A

Außenleuchten V4A | outdoor lighting V4A

1190.42



Spot - Edelstahl für den Außenbereich
spot - stainless steel for outdoor

Artikel-Nr. article-no.	Preis € price €
1190.42	25,80

Farbe: edelstahl
colour: stainless steel

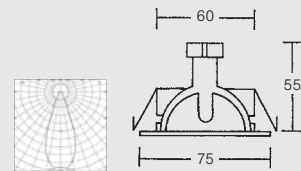

Material material	Bestückung lamp	Leistung power	Schutzart degree of protection	Schutzklasse protection class
V4A Edelstahl V4A stainless steel	1x GX5,3 QRCB51	max. 50W	IP20	III



1180.22



Spot - Edelstahl für den Außenbereich
spot - stainless steel for outdoor

Artikel-Nr. article-no.	Preis € price €
1180.22	60,80

Farbe: edelstahl
colour: stainless steel

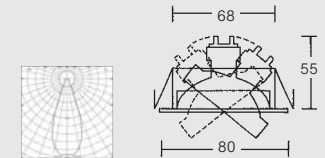

Material material	Bestückung lamp	Leistung power	Schutzart degree of protection	Schutzklasse protection class
V4A Edelstahl V4A stainless steel	1x GX5,3 QRCB51	max. 50W	IP20	III

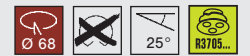

1191.42



Spot - Edelstahl für den Außenbereich
spot - stainless steel for outdoor

Artikel-Nr. article-no.	Preis € price €
1191.42	37,10

Farbe: edelstahl
colour: stainless steel

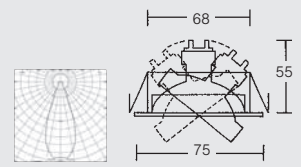

Material material	Bestückung lamp	Leistung power	Schutzart degree of protection	Schutzklasse protection class
V4A Edelstahl V4A stainless steel	1x GX5,3 QRCB51	max. 50W	IP20	III



1181.22



Spot - Edelstahl für den Außenbereich
spot - stainless steel for outdoor

Artikel-Nr. article-no.	Preis € price €
1181.22	64,90

Farbe: edelstahl
colour: stainless steel

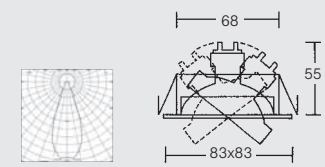

Material material	Bestückung lamp	Leistung power	Schutzart degree of protection	Schutzklasse protection class
V4A Edelstahl V4A stainless steel	1x GX5,3 QRCB51	max. 50W	IP20	III

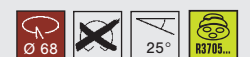

1924.42



Spot - Edelstahl für den Außenbereich
spot - stainless steel for outdoor

Artikel-Nr. article-no.	Preis € price €
1924.42	37,10

Farbe: edelstahl
colour: stainless steel

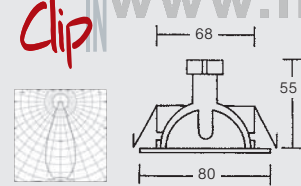

Material material	Bestückung lamp	Leistung power	Schutzart degree of protection	Schutzklasse protection class
V4A Edelstahl V4A stainless steel	1x GX5,3 QRCB51	max. 50W	IP20	III



2337.42



Spot - Edelstahl für den Außenbereich
spot - stainless steel for outdoor

Artikel-Nr. article-no.	Preis € price €	Blendbegrenzung limitation of glare
2337.42	40,00	

Farbe: edelstahl
colour: stainless steel

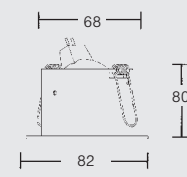

Material material	Bestückung lamp	Leistung power	Schutzart degree of protection	Schutzklasse protection class
V4A Edelstahl V4A stainless steel	1x GX5,3 QRCB51	max. 50W	IP20	III



1925.42



Spot - Edelstahl für den Außenbereich
spot - stainless steel for outdoor

Artikel-Nr. article-no.	Preis € price €
1925.42	39,20

Farbe: edelstahl
colour: stainless steel

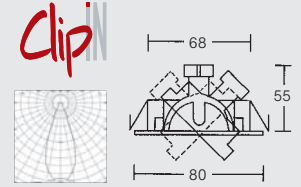

Material material	Bestückung lamp	Leistung power	Schutzart degree of protection	Schutzklasse protection class
V4A Edelstahl V4A stainless steel	1x GX5,3 QRCB51	max. 50W	IP20	III



2338.42



Spot - Edelstahl für den Außenbereich
spot - stainless steel for outdoor

Artikel-Nr. article-no.	Preis € price €	Blendbegrenzung limitation of glare
2338.42	42,00	

Farbe: edelstahl
colour: stainless steel

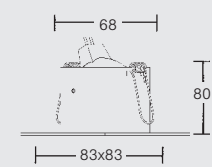

Material material	Bestückung lamp	Leistung power	Schutzart degree of protection	Schutzklasse protection class
V4A Edelstahl V4A stainless steel	1x GX5,3 QRCB51	max. 50W	IP20	III



Außenleuchten | outdoor lighting

Außenleuchten V4A | outdoor lighting V4A

2225.42



Spot - Edelstahl für den Außenbereich
spot - stainless steel for outdoor

Artikel-Nr. Preis €
article-no. price €
2225.42 51,50

Farbe: edelstahl
colour: stainless steel

Klares Abschlussglas
IP44 - bei Einbau in
geschlossene Decken
Clear glass cover IP44 -
if installation into closed
ceilings effects

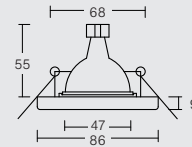

Material material	Bestückung lamp	Leistung power	Schutzart degree of protection	Schutzklasse protection class
V4A Edelstahl V4A stainless steel	1x GX5,3 QRCB51	max. 50W	IP44	III



2339.42



Spot - Edelstahl für den Außenbereich
spot - stainless steel for outdoor

Artikel-Nr. Preis €
article-no. price €
2339.42 46,00

Farbe: edelstahl
colour: stainless steel

Klares Abschlussglas
IP65 - bei Einbau in
geschlossene Decken
Clear glass cover IP65 -
if installation into closed
ceilings effects

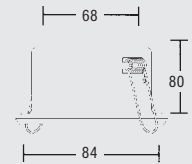

Material material	Bestückung lamp	Leistung power	Schutzart degree of protection	Schutzklasse protection class
V4A Edelstahl V4A stainless steel	1x GX5,3 QRCB51	max. 50W	IP65	III



2310.22



Spot - Edelstahl für den Außenbereich
spot - stainless steel for outdoor

Artikel-Nr. Preis €
article-no. price €
2310.22 44,10

Farbe: edelstahl
colour: stainless steel

Klares Abschlussglas
IP54 - bei Einbau in
geschlossene Decken
Clear glass cover IP54 -
if installation into closed
ceilings effects

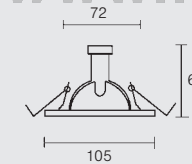

Material material	Bestückung lamp	Leistung power	Schutzart degree of protection	Schutzklasse protection class
rein Edelstahl stainless steel	1x GX5,3 QRCB51	max. 50W	IP54	III



2311.22



Spot - Edelstahl für den Außenbereich
spot - stainless steel for outdoor

Artikel-Nr. Preis €
article-no. price €
2311.22 46,40

Farbe: edelstahl
colour: stainless steel

Klares Abschlussglas
IP54 - bei Einbau in
geschlossene Decken
Clear glass cover IP54 -
if installation into closed
ceilings effects

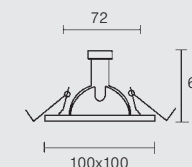

Material material	Bestückung lamp	Leistung power	Schutzart degree of protection	Schutzklasse protection class
rein Edelstahl stainless steel	1x GX5,3 QRCB51	max. 50W	IP54	III



2316.22



Deckenaufbauleuchte - Edelstahl für den Außenbereich
surface mounted light - stainless steel for outdoor

Artikel-Nr. Preis €
article-no. price €
2316.22 89,00

Farbe: edelstahl
colour: stainless steel

Klares Abschlussglas
clear glass cover

HOCHVOLT / HIGH VOLTAGE

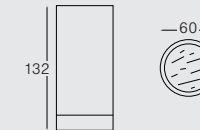

Material material	Bestückung lamp	Leistung power	Schutzart degree of protection	Schutzklasse protection class
V4A Edelstahl / V4A stainless steel	1x GU10 QPAR51	max. 35W	IP44	III



2315.22



Deckenaufbauleuchte - Edelstahl für den Außenbereich
surface mounted light - stainless steel for outdoor

Artikel-Nr. Preis €
article-no. price €
2315.22 139,30

Farbe: edelstahl
colour: stainless steel

Klares Abschlussglas
clear glass cover

HOCHVOLT / HIGH VOLTAGE

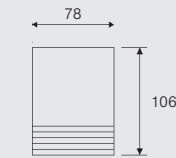

Material material	Bestückung lamp	Leistung power	Schutzart degree of protection	Schutzklasse protection class
V4A Edelstahl / V4A stainless steel	1x GU10 QPAR51	max. 35W	IP44	III



MODULO ELECTRO
www.modulelectro.ru

3177



Wandleuchte - Edelstahl für den Außenbereich
wall light - stainless steel for outdoor

Artikel-Nr. Preis €
article-no. price €
3177 188,00

Farbe: edelstahl
colour: stainless steel

Klares Abschlussglas
clear glass cover

HOCHVOLT / HIGH VOLTAGE

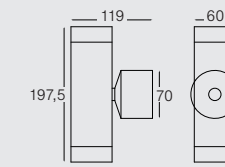

Material material	Bestückung lamp	Leistung power	Schutzart degree of protection	Schutzklasse protection class
V4A Edelstahl / V4A stainless steel	2x GU10 QPAR51	max. 35W	IP44	III

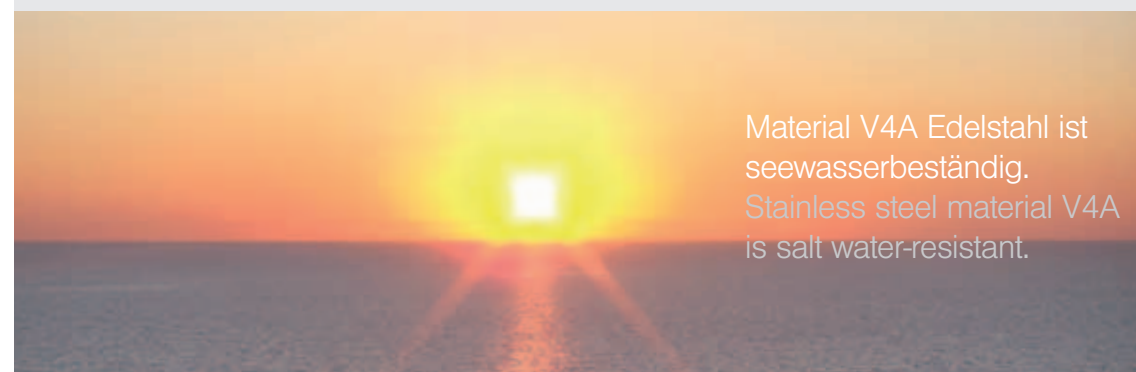

Material V4A Edelstahl ist seewasserbeständig.
Stainless steel material V4A is salt water-resistant.

3061.25



Wandeinbauleuchte für den Außenbereich
recessed wall light for outdoor

Artikel-Nr. Preis €
article-no. price €
3061.25 93,00

Wandleuchte ohne Trafo
Inkl. Einputzgehäuse,
Maße: D 90 x H 62mm
Abschlussglas aus Kunststoff
wall lights without transformer
incl. in-wall box
dimensions: D 90 x H 62mm
plastic cover

Farbe: alu matt
colour: alu matt

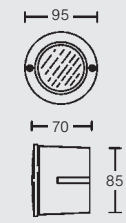

Material material	Bestückung lamp	Leistung power	Schutzart degree of protection	Schutzklasse protection class
Aluminium/Kunststoff aluminium/plastic	1x GX5,3 QRCB51	max. 50W	IP20	III

3062.25



Wandeinbauleuchte für den Außenbereich
recessed wall light for outdoor

Artikel-Nr. Preis €
article-no. price €
3062.25 93,00

Wandleuchte ohne Trafo
Inkl. Einputzgehäuse,
Maße: D 90 x H 62mm
Abschlussglas aus Kunststoff
wall lights without transformer
incl. in-wall box
dimensions: D 90 x H 62mm
plastic cover

Farbe: alu matt
colour: alu matt

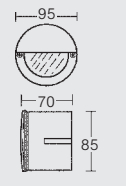

Material material	Bestückung lamp	Leistung power	Schutzart degree of protection	Schutzklasse protection class
Aluminium/Kunststoff aluminium/plastic	1x G4 QT9	max. 10W	IP65	III

3063.25

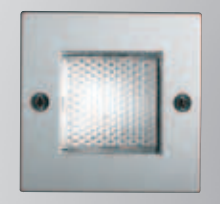

Wandeinbauleuchte für den Außenbereich
recessed wall light for outdoor

Artikel-Nr. Preis €
article-no. price €
3063.25 93,00

Wandleuchte ohne Trafo
Inkl. Einputzgehäuse,
Maße: D 74 x H 68mm
Abschlussglas aus Kunststoff
wall lights without transformer
incl. mounting box
dimensions: D 74 x H 68mm
plastic glass

Farbe: alu matt
colour: alu matt

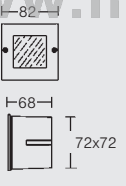

Material material	Bestückung lamp	Leistung power	Schutzart degree of protection	Schutzklasse protection class
Aluminium/Kunststoff aluminium/plastic	1x G4 QT9	max. 10W	IP65	III

P3622...



Wandeinbauleuchte für den Außenbereich
recessed wall light for outdoor

inkl. Einputzdose / incl. in-wall box

Artikel-Nr. Lichtfarbe Preis €
article-no. light colour price €

P3622W	weiß / white	126,10
P3622B	blau / blue	126,10
P3622R	rot / red	126,10
P3622Y	orange / orange	126,10
P3622G	grün / green	126,10

mögliche Betriebsgeräte
(Artikel 3505, 3513, 3514, 3515, 3516)
possible converters (article 3505,
3513, 3514, 3515, 3516)

Farbe: alu matt
colour: alu matt

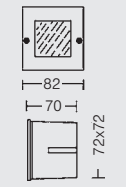

Material material	Bestückung lamp	Leistung power	Schutzart degree of protection	Schutzklasse protection class
Aluminium/Kunststoff aluminium/plastic	1x Power-LED	ca.1,0W	IP65	III

Montage

Für die Installation und den Betrieb von Bodeneinbauleuchten sind die nationalen Sicherheitsvorschriften zu beachten. Die Montage, Installation und Reparatur der Leuchten ist nur durch autorisierte Fachkräfte zugelassen. Es sind die Bestimmungen der VDE 0100 und VDE 0108 sowie die Richtlinien für Brandschutz, elektrische Leuchten Form 2005 des Verbandes der Sachversicherer e.V. Köln zu beachten.

Installation

Folgende Punkte sind beim Einbau zu beachten:

Installation nur bei trockenem Wetter und trockenen Bodenverhältnissen vornehmen.

- Vor der Installation der Leuchte ist für eine ausreichende Drainage zu sorgen. Der Bodenaushub ist so vorzunehmen, dass um die Leuchte herum und unter der Leuchte eine entsprechende Drainage vorhanden ist.
- Die Leuchte ist bodengleich zu montieren, damit Wasser abfließen oder von der Leuchte ablaufen kann. Der Abschlussring muss oberhalb der Bodenoberfläche oder genau bündig liegen. In keinem Fall darf die Leuchte in einer Senke eingesetzt werden, um das Eindringen von Wasser in die Leuchte, durch z.B. Wasseransammlung auf der Leuchtenoberfläche oder Überflutung, zu vermeiden.
- Abdeckring mit Glas und Dichtung abnehmen.
- Gegebenenfalls Reflektor herausnehmen. Gegebenenfalls Lampengehäuse vom Einbaugeschäule schrauben.
- Zuleitung vorbereiten.
- Kabel durch die Leitungseinführung einführen.
- Leitungseinführung / Kabelverschraubung fest anziehen.
- Der Einsatz eines Schrumpfschlauches ist unbedingt zu empfehlen (für Eindringen von Wasser über die Kabelverschraubung übernehmen wir keine Gewähr).
- Schrumpfschlauch auf die Kabelverschraubung schieben und mit einem Heißluftgerät schrumpfen (Schrumpfschlauch vom Leuchtenkörper aus gleichmäßig erwärmen). (Empfehlung: Verschraubung von Innen mit Kabelkitt oder Dichtungsmasse abdichten).
- Stromversorgung herstellen.
- Gegebenenfalls Lampengehäuse auf das Einbaugeschäule montieren.
- Dichtflächen, Dichtungen und Abdeckring sehr gut reinigen. Gegebenenfalls Reflektor einsetzen.
- Leuchtmittel einsetzen.
- Abdeckring mit Glas und Dichtung auf das Einbaugeschäule montieren. Dabei auf den richtigen Sitz der Dichtung achten.
- Schrauben des Abdeckringes sind in entgegengesetzter Rotation anzuziehen, um einen ausgeglichenen Druck zu ermöglichen und damit eine Verschiebung der Dichtung zu vermeiden. Zum Schutz der Leuchte ist eine Verschraubung von 5 Nm (von Hand angezogen) erforderlich. Bei Verwendung von Elektrowerkzeugen bitte nur Werkzeuge mit angegebenem Drehmoment verwenden.

Assembly:

The national safety regulations must be observed for the installation and operation of in-ground luminaires. Only an authorised specialist is permitted to assemble, install, and repair the lights. The provisions of VDE 0100 and VDE 0108 as well as guidelines for fire predection, and Electric Lights Form 2005 of the Association of Property Insurers, Cologne must be observed.

Installation:

The following points must be observed:

Only perform the installation in dry weather and with dry ground conditions

- Make sure there is adequate drainage before installation. The excavation must be such that there is an adequate filling of gravel around and under the light.
- The light must be installed ground-levelled so that water drains off or can drain away from the light. The sealing lid must be above ground-level. Under no circumstances may the light be used in a depression to prevent water penetrating into the light by, for example, water collecting on the surface of the light or by flooding.
- Remove stainless steel cover ring incl. glass and seal.
- Remove reflector
- Remove housing from lighting fitting
- Prepare the connecting leads.
- Push the cable through the lead opening.
- Tighten lead opening / threaded cable connection.
- The use of a heat-shrinking sleeve has to be unconditionally recommended. (We assume no responsibility for the intrusion of water through the cable connection.)
- Slide the heat-shrinking sleeve on the threaded cable connection and shrink it with a hot air device (the heat-shrinking sleeve must be heated uniformly starting with the light housing).
- (Recommendation: seal the screw connection from the inside with cable putty or a sealing compound).
- Make the electrical connection with an external transformer.
- Insert the lamp
- Mount the housing on the lighting fitting.
- Clean the sealing surfaces, seals, stainless steel cover ring, and safety glass well. Insert reflector.
- Mount the stainless steel ring on the recessed luminaire. Make sure that the seal is seated correctly.
- Tighten the screws of the cover ring on opposite sides in order to facilitate balanced pressure on the sealing system and to prevent the housing seal from shifting or deforming. 5 Nm of screwing (tightened by hand) is required to protect the light. When using electric tools, please only use tools with a specified torque.



Um die Lebensdauer der Leuchte sowie des Leuchtmittels nicht zu beeinträchtigen und um eine ständig gleichbleibend hohe und gleichmäßige Lichtverteilung zu gewährleisten, raten wir, das Sicherheitsglas in regelmäßigen Abständen zu reinigen; von Erde, Insekten oder Laub zu befreien.

We advice to clean the safety glass regularly up from soil, insects and leaves so the lifespan of the luminaire and bulb will not be affected and a uniformly luminous intensity distribution can be guaranteed.

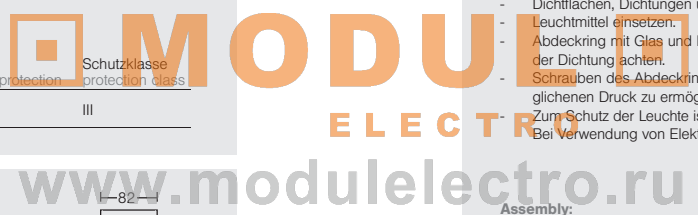

P3804



Bodeneinbauleuchte für den Außenbereich
groundlight for outdoor

Artikel-Nr. article-no.	Farbe colour	Preis € price €
P3804W	weiß / white	188,00
P3804B	blau / blue	188,00
P3804R	rot / red	188,00
P3804Y	orange / orange	188,00
P3804G	grün / green	188,00

inkl. Konverter für 230V Direktanschluss, Belastbar bis 1.000kg inkl. Montagehülse
incl. converter for 230V connexion maximum pressure 1.000kg incl. mounting sleeve
Farbe: edelstahl
colour: stainless steel



Material material	Bestückung lamp	Leistung power	Schutzart degree of protection	Schutzklasse protection class
Edelstahl-Kunststoff-Acryl stainless steel-plastic-acryl	1x Power-LED	ca. 1,0W	IP65	II

P3802



Bodeneinbauleuchte für den Außenbereich
groundlight for outdoor

Artikel-Nr. article-no.	Farbe colour	Preis € price €
P3802W	weiß / white	188,00
P3802B	blau / blue	188,00
P3802R	rot / red	188,00
P3802Y	orange / orange	188,00
P3802G	grün / green	188,00

inkl. Konverter für 230V Direktanschluss, Belastbar bis 1.000kg, inkl. Montagehülse
incl. converter for 230V connexion maximum pressure 1.000kg incl. mounting sleeve
Farbe: edelstahl
colour: stainless steel

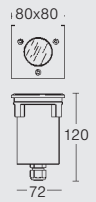

Material material	Bestückung lamp	Leistung power	Schutzart degree of protection	Schutzklasse protection class
Edelstahl-Kunststoff-Acryl stainless steel-plastic-acryl	1x Power-LED	ca. 1,0W	IP65	II

3101



Bodeneinbauleuchte für den Außenbereich
groundlight for outdoor

Artikel-Nr. article-no.	Preis € price €
3101	66,80

Verschraubung: 2x M20 (PG 13,5)
Anschlussleitung: H07 RN-F3G 1,5
Inkl. Montagehülse
screwing: 2x M20 (PG 13,5)
connection: H07 RN-F3G 1,5
incl. mounting sleeve

Farbe: edelstahl
colour: stainless steel

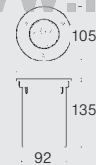

Material material	Bestückung lamp	Leistung power	Schutzart degree of protection	Schutzklasse protection class
Edelstahl/Glas klar stainless steel/glass clear	1x GX5,3 QRCSB1	max. 35W	IP65	III

3102



Bodeneinbauleuchte für den Außenbereich
groundlight for outdoor

Artikel-Nr. article-no.	Preis € price €
3102	71,00

Verschraubung: 2x M20 (PG 13,5)
Anschlussleitung: H07 RN-F3G 1,5
Inkl. Montagehülse
screwing: 2x M20 (PG 13,5)
connection: H07 RN-F3G 1,5
incl. mounting sleeve

Farbe: edelstahl
colour: stainless steel

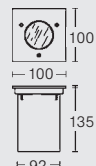

Material material	Bestückung lamp	Leistung power	Schutzart degree of protection	Schutzklasse protection class
Edelstahl/Glas klar stainless steel/glass clear	1x GX5,3 QRCSB1	max. 35W	IP65	III

3104

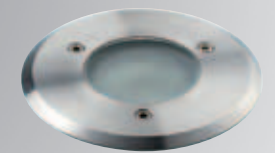

Bodeneinbauleuchte für den Außenbereich
groundlight for outdoor

Artikel-Nr. article-no.	Preis € price €
3104	68,30

Verschraubung: 2x M20 (PG 13,5)
Anschlussleitung: H07 RN-F3G 1,5
Inkl. Montagehülse
screwing: 2x M20 (PG 13,5)
connection: H07 RN-F3G 1,5
incl. mounting sleeve

Farbe: edelstahl
colour: stainless steel

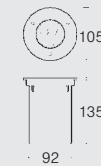

Material material	Bestückung lamp	Leistung power	Schutzart degree of protection	Schutzklasse protection class
Edelstahl/Glas satiniert stainless steel/satin glass	GX5,3 QRCSB1	max. 35W	IP65	III

R3825



Bodeneinbauleuchte für den Außenbereich
groundlight for outdoor

Artikel-Nr. article-no.	Preis € price €
R3825NW	188,00

Inkl. Konverter für 230V
Lichtfarbe: neutral-weiß, Linse: 45°
Verschraubung: 2x M20 (PG 13,5)
Inkl. Montagehülse
light colour: neutral-white lens: 45°
screwing: 2x M20 (PG 13,5)
incl. mounting sleeve

Farbe: edelstahl
colour: stainless steel

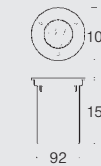

Material material	Bestückung lamp	Leistung power	Schutzart degree of protection	Schutzklasse protection class
Edelstahl/Glas klar stainless steel/glass clear	3x LED Rebel	je ca. 1,2W each approx. 1,2W	IP65	I

auch in anderen Lichtfarben und Abstrahlwinkeln lieferbar
also available in other light colours and other angles of reflected beam



R3826



Bodeneinbauleuchte für den Außenbereich
groundlight for outdoor

Artikel-Nr. article-no.	Preis € price €
R3826NW	188,00

Inkl. Konverter für 230V
Lichtfarbe: neutral-weiß, Linse: 45°
Verschraubung: 2x M20 (PG 13,5)
Inkl. Montagehülse
light colour: neutral-white lens: 45°
screwing: 2x M20 (PG 13,5)
incl. mounting sleeve

Farbe: edelstahl
colour: stainless steel

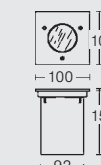

Material material	Bestückung lamp	Leistung power	Schutzart degree of protection	Schutzklasse protection class
Edelstahl/Glas klar stainless steel/glass clear	3x LED Rebel	je ca. 1,2W each approx. 1,2W	IP65	I

auch in anderen Lichtfarben und Abstrahlwinkeln lieferbar
also available in other light colours and other angles of reflected beam



3105

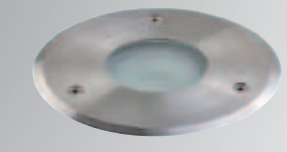

Bodeneinbauleuchte für den Außenbereich
groundlight for outdoor

Artikel-Nr. article-no.	Preis € price €
3105	63,00

Farbe: edelstahl
colour: stainless steel



MEGAMAN®
EnergieSparLampen
geeignet für Megaman-Energiesparlampe 7/9/11W
adapted for Megaman-energy saving lamp 7/9/11W

Material material	Bestückung lamp	Leistung power	Schutzart degree of protection	Schutzklasse protection class
Edelstahl/Glas satiniert stainless steel/satin glass	1x GU10	7/9/11W	IP65	I

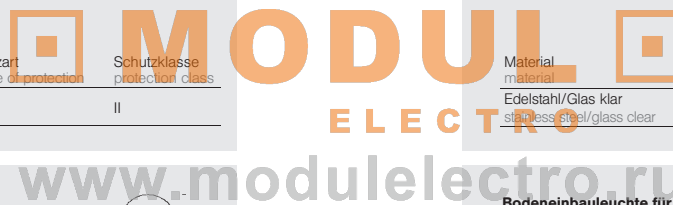

3146



Bodeneinbauleuchte für den Außenbereich
groundlight for outdoor

Artikel-Nr. article-no.	Preis € price €	
3146	214,30	inkl. Montagehülse incl. mounting sleeve

Farbe: edelstahl
colour: stainless steel

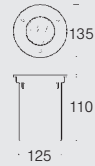

Material material	Bestückung lamp	Leistung power	Schutzart degree of protection	Schutzklasse protection class
Edelstahl-Aluminium-Glas klar stainless steel-aluminium-glass clear	1x GX5,3 QRCB51	max. 20W	IP65	III



3147



Bodeneinbauleuchte für den Außenbereich
groundlight for outdoor

Artikel-Nr. article-no.	Preis € price €	
3147	220,30	inkl. Montagehülse incl. mounting sleeve

Farbe: edelstahl
colour: stainless steel

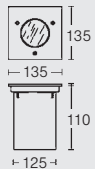

Material material	Bestückung lamp	Leistung power	Schutzart degree of protection	Schutzklasse protection class
Edelstahl-Aluminium-Glas klar stainless steel-aluminium-glass clear	1x GX5,3 QRCB51	max. 20W	IP65	III



3128



Bodeneinbauleuchte für den Außenbereich
groundlight for outdoor

Artikel-Nr. article-no.	Preis € price €	
3128	72,50	Verschraubung: 2x M20 (PG 13,5) Anschlussleitung: H07 RN-F3G 1,5 Inkl. Montagehülse screwing: 2x M20 (PG 13,5) connection: H07 RN-F3G 1,5 incl. mounting sleeve

Farbe: edelstahl
colour: stainless steel

MEGAMAN®
Energiesparlampen

geeignet für Megaman-Energiesparlampe 7/9/13W
adapted for Megaman-energy saving lamp 7/9/13W

Material material	Bestückung lamp	Leistung power	Schutzart degree of protection	Schutzklasse protection class
Edelstahl/Glas satiniert stainless steel/satin glass	1x GX53	7/9/13W	IP65	I

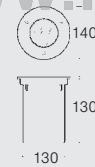

MODUL
ELECTRO
www.modulelectro.ru



Hotel Tannenhof, Grossmaiseid

3150

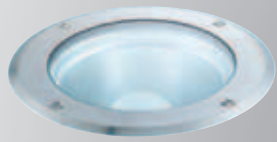

Bodeneinbauleuchte für den Außenbereich
groundlight for outdoor

Artikel-Nr. article-no.	Preis € price €	inkl. Montagehülse incl. mounting sleeve
3150	393,30	

Farbe: edelstahl
colour: stainless steel

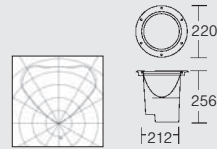

Material material	Bestückung lamp	Leistung power	Schutzart degree of protection	Schutzklasse protection class
Edelstahl-Aluminium-Glas klar stainless steel-aluminium-glass clear	1x E27	max. 60W	IP65	I

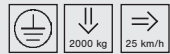

3155



Bodeneinbauleuchte für den Außenbereich
groundlight for outdoor

Artikel-Nr. article-no.	Preis € price €	inkl. Montagehülse incl. mounting sleeve
3155	418,00	

Farbe: edelstahl
colour: stainless steel

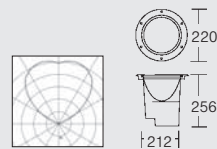

Material material	Bestückung lamp	Leistung power	Schutzart degree of protection	Schutzklasse protection class
Edelstahl-Aluminium-Glas klar stainless steel-aluminium-glass clear	1x TC-T GX24d-2	18W	IP65	I

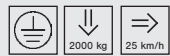

Golf-Club Schloss Miel, Miel

3160/3161

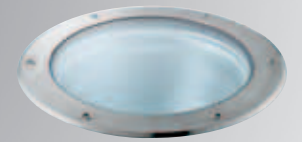

Bodeneinbauleuchte für den Außenbereich
groundlight for outdoor

Artikel-Nr. article-no.	Preis € price €	inkl. Montagehülse und Betriebsgerät incl. mounting sleeve and power-supply
3160	720,90	
3161	834,60	

Farbe: edelstahl
colour: stainless steel

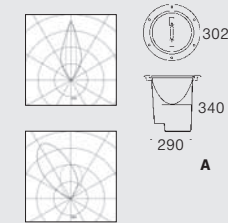

Material material	Bestückung lamp	Leistung power	Schutzart degree of protection	Schutzklasse protection class
Edelstahl-Aluminium-Glas klar stainless steel-aluminium-glass clear	1x Rx7s-24 HIT-DE	70W	IP65	I

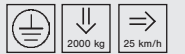

Auch erhältlich mit asymmetrischer Lichtstärkeverteilung Art.-Nr. 316100
also available with asymmetrical light distribution art.-no. 316100



Symmetrisches Licht /symetric light
31600 A

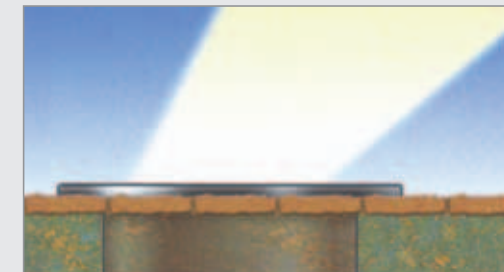

Asymmetrisches Licht /asymetric light
316100 B

MODULO ELECTRO

www.modulelectro.ru

3162/3163



Bodeneinbauleuchte für den Außenbereich
groundlight for outdoor

Artikel-Nr. article-no.	Preis € price €	inkl. Montagehülse und Betriebsgerät incl. mounting sleeve and power- supply
3162	749,40	
3163	853,90	

Farbe: edelstahl
colour: stainless steel

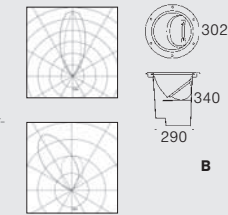

Material material	Bestückung lamp	Leistung power	Schutzart degree of protection	Schutzklasse protection class
Edelstahl-Aluminium-Glas klar stainless steel-aluminium-glass clear	1x Rx7s-24 HIT-DE	150W	IP65	I



Auch erhältlich mit asymmetrischer Lichtstärkeverteilung Art.-Nr. 316300
also available with asymmetrical light distribution art.-no. 316300



Symmetrisches Licht /symetric light
316200 A

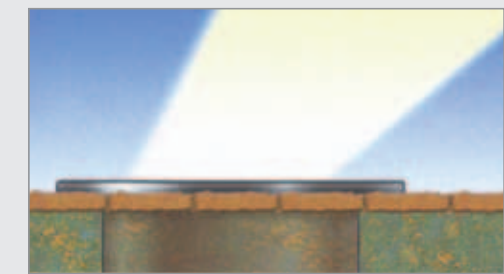

Asymmetrisches Licht /asymetric light
316300 B

540030



Radar Superglow

Artikel-Nr. article-no.	Preis € (ab Werk) price € (ex works)
540030	595,00

Farbe: grau (pulverbeschichtet)
colour: grey (powder coated)

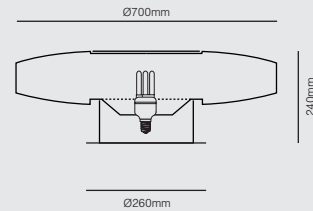

Material material	Bestückung lamp	Leistung power	Schutzart degree of protection	Schutzklasse protection class
Edelstahl - Polyethylen stainless steel - polyethylen	1x E27	max. 60W	IP54	I

540029



Diva Stand

Artikel-Nr. article-no.	Preis € (ab Werk) price € (ex works)
540029	1050,00

Farbe: grau (pulverbeschichtet)
colour: grey (powder coated)

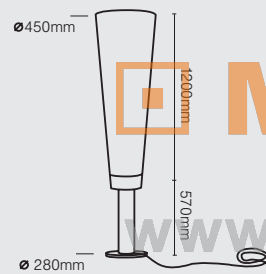

Material material	Bestückung lamp	Leistung power	Schutzart degree of protection	Schutzklasse protection class
Edelstahl - Polyethylen stainless steel - polyethylen	PAR30 E27 CDM-R	max. 35W	IP54	I

Sonderausführungen auf Anfrage erhältlich
special illuminants on request



MODUL
ELECTRO
www.modulelectro.ru

Nature

lighting for outdoor



NEU
new

MODUL
ELECTRO
www.modulelectro.ru

- SQUAREwood
- SQUAREstone
- ROUNDwood
- ROUNDstone



Leuchtturm am Biggedamm, Attendorf

NATURE - SQUAREwood

Außenleuchten-Serie aus einem Materialmix aus Teakholz und Edelstahl, mit einem quadratischen Korpus. Der Leuchtenfuß und die Lamellen sind aus hochwertigem Edelstahl gefertigt.

Outdoor lighting range consisting of a material mix of teakwood and stainless steel with a square corpus. The lighting bottom and the fins are made of high-quality stainless steel.

NATURE - SQUAREstone

Außenleuchten-Serie aus einem Materialmix aus Granit und Edelstahl mit einem quadratischen Korpus. Der Leuchtenfuß und die Lamellen sind aus hochwertigem Edelstahl gefertigt.

Outdoor lighting range consisting of a material mix of granite and stainless steel with a square corpus. The lighting bottom and the fins are made of high-quality stainless steel.

313110



NATURE - SQUAREwood

Artikel-Nr. article-no.	Preis € price €
313110	262,00

Holzpflege siehe S. 404
wood care see on page 404

Leuchtmittel siehe Seite 474
bulbs see on page 474

Maße (LxBxH) /dimensions
100 x 100 x 200mm

Material material	Bestückung lamp	Leistung power	Schutzart degree of protection	Schutzklasse protection class
Teakholz/Edelstahl teakwood/stainless steel	1x E27	max. 12W	IP44	I

NATURE - SQUAREstone

Artikel-Nr. article-no.	Preis € price €
314110	274,00

Leuchtmittel siehe Seite 474
bulbs see on page 474

Maße (LxBxH) /dimensions
100 x 100 x 200mm

Material material	Bestückung lamp	Leistung power	Schutzart degree of protection	Schutzklasse protection class
Granit/Edelstahl granite/stainless steel	1x E27	max. 12W	IP44	I

314110

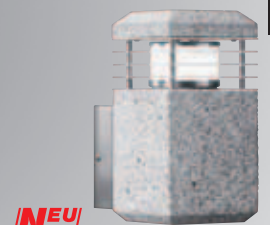

313112



NATURE - SQUAREwood

Artikel-Nr. article-no.	Preis € price €
313112	378,00

Installationszubehör- und Holzpflege siehe S. 404
installation accessories and wood care see on page 404

Leuchtmittel siehe Seite 474
bulbs see on page 474

Maße (LxBxH) /dimensions
100 x 100 x 605mm

Fuß / base 136x136 mm

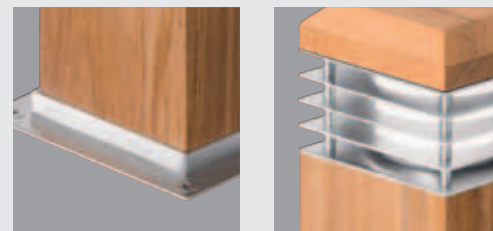

Material material	Bestückung lamp	Leistung power	Schutzart degree of protection	Schutzklasse protection class
Teakholz/Edelstahl teakwood/stainless steel	1x E27	max. 12W	IP44	I

NATURE - SQUAREstone

Artikel-Nr. article-no.	Preis € price €
314112	390,00

Installationszubehör siehe S. 404
installation accessories see on page 404

Leuchtmittel siehe Seite 474
bulbs see on page 474

Maße (LxBxH) /dimensions
100 x 100 x 605mm

Fuß / base 136x136 mm

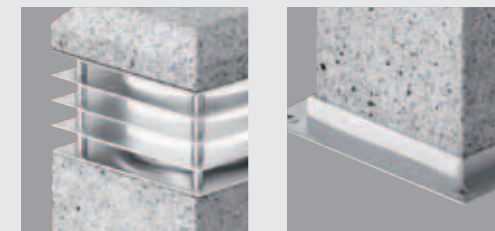

Material material	Bestückung lamp	Leistung power	Schutzart degree of protection	Schutzklasse protection class
Granit/Edelstahl granite/stainless steel	1x E27	max. 12W	IP44	I

314112



MODUL
ELECTRO
www.modulelectro.eu

NATURE - ROUNDwood 3.2

Außenleuchten-Serie aus einem Materialmix von Teakholz und Edelstahl mit einem rundem Korpus. Der Leuchtenfuß und die Lamellen sind aus hochwertigem Edelstahl gefertigt.

Outdoor lighting range consisting of a material mix of teakwood and stainless steel with a round corpus. The lighting bottom and the fins are made of high-quality stainless steel.

NATURE - ROUNDstone

Außenleuchten-Serie aus einem Materialmix von Granit und Edelstahl mit einem quadratischen Korpus. Der Leuchtenfuß und die Lamellen sind aus hochwertigem Edelstahl gefertigt.

Outdoor lighting range consisting of a material mix of granite and stainless steel with a square corpus. The lighting bottom and the fins are made of high-quality stainless steel.

313210



NATURE - ROUNDwood

Artikel-Nr. article-no.	Preis € price €
313210	252,00

Holzpflege siehe S. 404
wood care see on page 404

Leuchtmittel siehe Seite 474
bulbs see on page 474

Maße (LxBxH) / dimensions
113 x 160 x 205mm

Material material	Bestückung lamp	Leistung power	Schutzart degree of protection	Schutzklasse protection class
Teakholz/Edelstahl teakwood/stainless steel	1x E27	max. 12W	IP44	I

NATURE - ROUNDstone

Artikel-Nr. article-no.	Preis € price €
314010	264,00

Leuchtmittel siehe Seite 474
bulbs see on page 474

Maße (LxBxH) / dimensions
113 x 160 x 205mm

Material material	Bestückung lamp	Leistung power	Schutzart degree of protection	Schutzklasse protection class
Granit/Edelstahl granite/stainless steel	1x E27	max. 12W	IP44	I

314010



313212



NATURE - ROUNDwood

Artikel-Nr. article-no.	Preis € price €
313212	368,00

Installationszubehör- und Holzpflege siehe S. 404
installation accessories and wood care see on page 404

Leuchtmittel siehe Seite 474
bulbs see on page 474

Maße (LxBxH) / dimensions
100 x 100 x 605mm

Fuß / base 136x136 mm

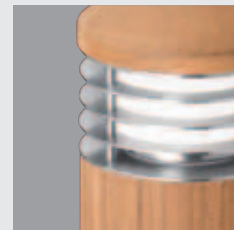
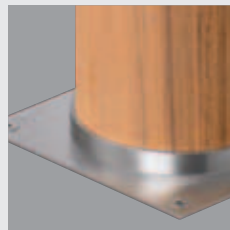

Material material	Bestückung lamp	Leistung power	Schutzart degree of protection	Schutzklasse protection class
Teakholz/Edelstahl teakwood/stainless steel	1x E27	max. 12W	IP44	I

NATURE - ROUNDstone

Artikel-Nr. article-no.	Preis € price €
314012	380,00

Installationszubehör siehe S. 404
installation accessories see on page 404

Leuchtmittel siehe Seite 474
bulbs see on page 474

Maße (LxBxH) / dimensions
100 x 100 x 605mm

Fuß / base 136x136 mm

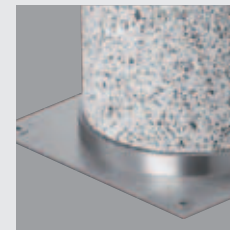
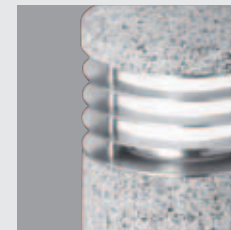

Material material	Bestückung lamp	Leistung power	Schutzart degree of protection	Schutzklasse protection class
Granit/Edelstahl granite/stainless steel	1x E27	max. 12W	IP44	I

314012



MODUL ELECTRO
www.modulelectro.eu

90195



Holzpflege für NATURE / wood care for NATURE

Artikel-Nr. article-no.	Preis € price €	OSMO UV-Schutz-Öl + Pinsel
90195	20,00	Naturöl für offenporige Holzanstriche.

125ml, farblos

Osmo oil for the protection against radiation + brush

Natural oil for open-pored coating on wood.

125ml, transparent

NEU
new

3704



Bodenanker für NATURE / ground plate for NATURE

Artikel-Nr. article-no.	Preis € price €	Bodenplatte / ground plate	136 x 136 x 3 mm
3704	16,00	Einbautiefe / installation depth	150 mm

Material / material
Stahl (verzinkt), Edelstahl
steel (zinc plated), stainless steel

NEU
new

3703



Erdspieß für NATURE / peg for NATURE

Artikel-Nr. article-no.	Preis € price €	Bodenplatte / ground plate	136 x 136 x 3 mm
3703	19,00	Spieß / peg	63 x 163 x 550 mm

Material / material
Stahl (verzinkt) / steel (zinc plated)

NEU
new

MODUL
ELECTRO
www.modulelectro.ru



Leuchtturm am Biggedamm, Attendorf



MODUL
ELECTRO
www.modulelectro.ru

Die Leuchten aus der GIPS-Kollektion zeichnen sich aus durch unverwechselbares Design sowie durch hervorragende, spezielle Materialeigenschaften: Hohe Widerstandsfähigkeit bei Temperaturschwankungen, Kratzern und Stößen; dekorierbar mit jeder Art von Farbe oder Lack; weiße, natürlich strukturierte Oberfläche; abwaschbar.

The lights of the PLASTER collection distinguish from a distinctive design as well as an outstanding quality in material: High resistance in variations in temperature, scratches and impacts; to be decorated with each kind of colour or varnish; white naturally structured surface; washable.

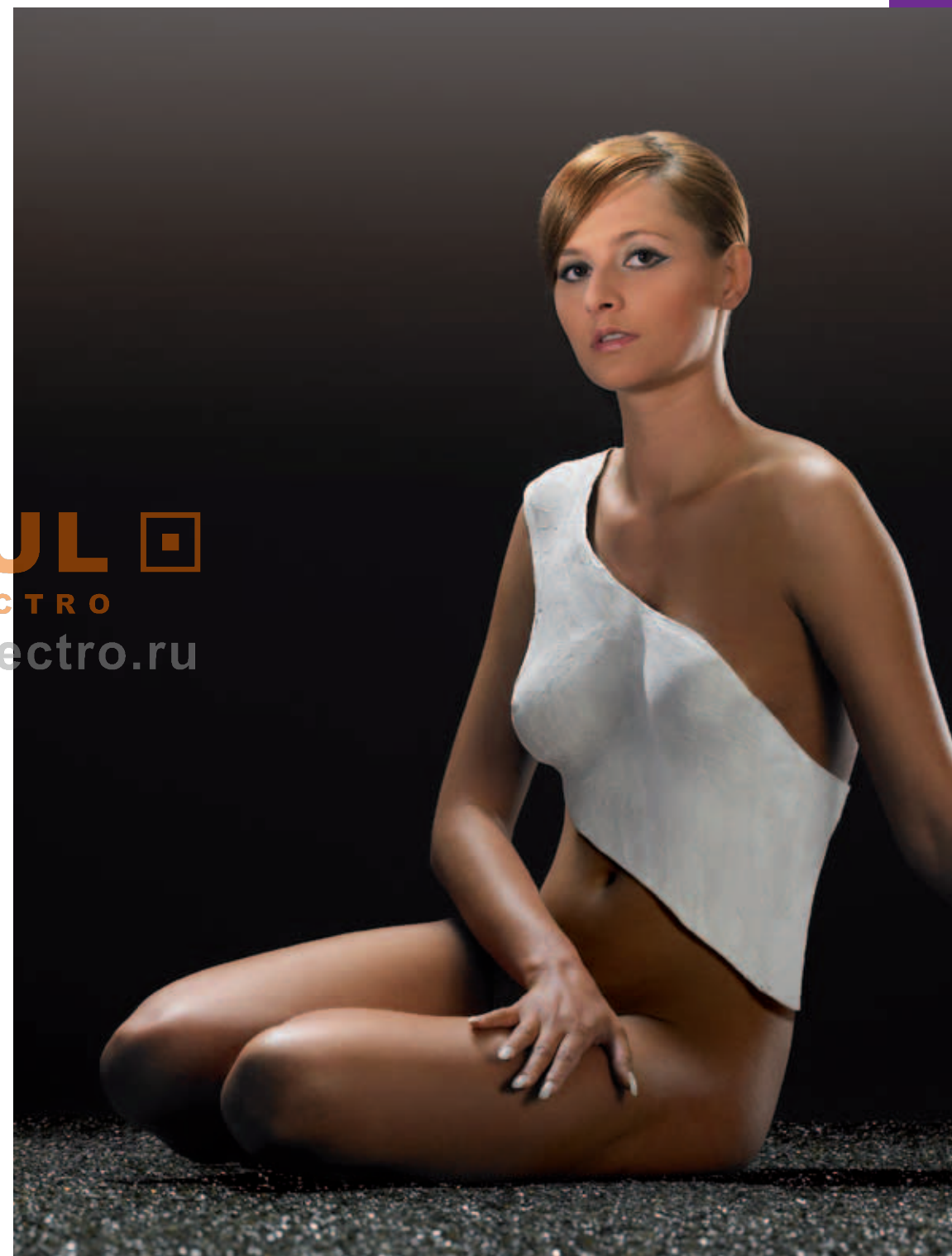

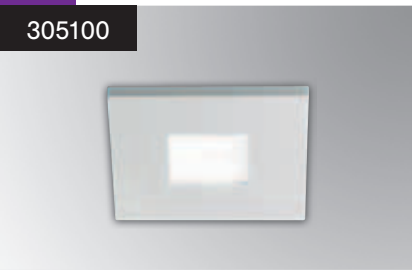

Gips natur, strukturiert / plaster natural structured

Artikel-Nr. article-no.	Preis € price €	Farbe: weiß
305100	69,00	

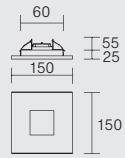

Artikel-Nr. article-no.	Bestückung lamp	Leistung power	Schutzart degree of protection	Schutzklasse protection class
305100	1x GX5,3/QRCBC51	max. 50W	IP20	III

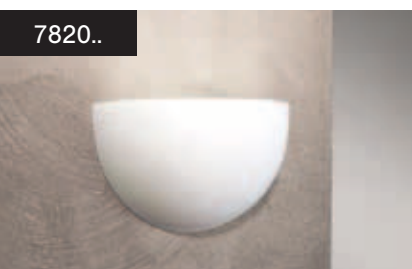

Gips natur, strukturiert / plaster natural structured

Artikel-Nr. article-no.	Preis € price €	Farbe: weiß Art. Nr. 782151 inkl. Glasabdeckung colour: white art. nr. 782051 incl. covering-glass
782050	122,60	
782051	177,00	

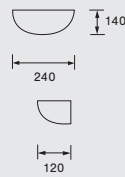

Artikel-Nr. article-no.	Bestückung lamp	Leistung power	Schutzart degree of protection	Schutzklasse protection class
782050	1x A45 E27	max. 60W	IP20	I
782151	1x G24d-1 TC-D	10/13W VVG	IP20	I

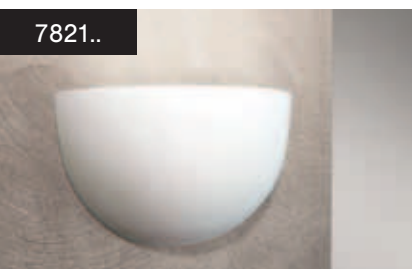

Gips natur, strukturiert / plaster natural structured

Artikel-Nr. article-no.	Preis € price €	Farbe: weiß Art. Nr. 782151 inkl. Glasabdeckung colour: white art. nr. 782151 incl. covering-glass
782150	129,60	
782151	185,00	

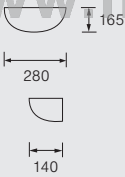

Artikel-Nr. article-no.	Bestückung lamp	Leistung power	Schutzart degree of protection	Schutzklasse protection class
782150	1x A45 E27	max. 60W	IP20	I
782051	1x G24d-3 TC-D	26W VVG	IP20	I



Gips natur, strukturiert / plaster natural structured

Artikel-Nr. article-no.	Preis € price €	Farbe: weiß Art. Nr. 783151 und 783154 inkl. Glasabdeckung colour: white art. nr. 783151 and 783154 incl. covering-glass
783150	137,00	
783151	190,50	
783152	210,60	
783154	260,00	

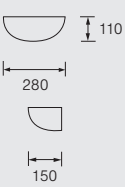

Artikel-Nr. article-no.	Bestückung lamp	Leistung power	Schutzart degree of protection	Schutzklasse protection class
783150	1x A45 E27	max. 60W	IP20	I
783051	1x G24d-3 TC-D	26W VVG	IP20	I
788152	R7s QT-DE	max. 1x 100W	IP20	I
783154	1x G24q-3 TC-DEL	26W EVG	IP20	I

NEU
new!

Gips natur, strukturiert / plaster natural structured

Artikel-Nr. article-no.	Preis € price €	Farbe: weiß colour: white
783250	153,60	
783252	209,00	

Artikel-Nr. article-no.	Bestückung lamp	Leistung power	Schutzart degree of protection	Schutzklasse protection class
783250	1x A40 E27	max. 60W	IP20	I
783252	1x R7xQT-DE	150W (114,2mm)	IP20	I



Gips natur, strukturiert / plaster natural structured

Artikel-Nr. article-no.	Preis € price €	Farbe: weiß Art. Nr. 782551 inkl. Glasabdeckung colour: white art. nr. 782551 incl. covering-glass
782550	160,00	
782551	227,90	

Artikel-Nr. article-no.	Bestückung lamp	Leistung power	Schutzart degree of protection	Schutzklasse protection class
782550	1x A60 E27	max. 100W	IP20	I
782551	1x G24d-3 TC-D	26W VVG	IP20	I

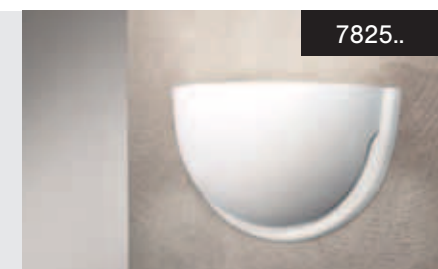

Indirekter und direkter Lichtaustritt
indirect and direct light exit

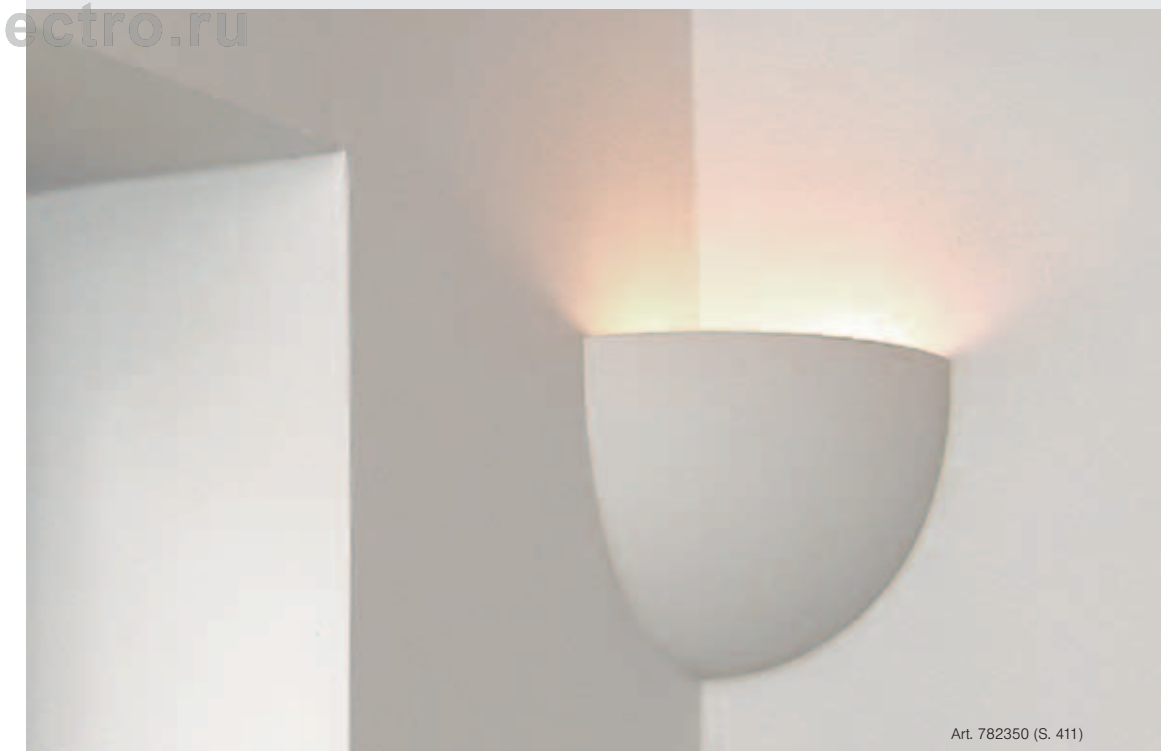

Art. 782350 (S. 411)

MODULO
ELECTRO
www.modulelectro.ru



MODUL
ELECTRO
www.modulelectro.ru

Gips natur, strukturiert / plaster natural structured

Artikel-Nr. article-no.	Preis € price €	Farbe: weiß colour: white
782350	173,40	

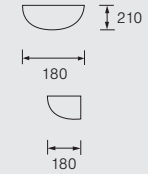

Artikel-Nr. article-no.	Bestückung lamp	Leistung power	Schutzart degree of protection	Schutzklasse protection class
782350	1x A45 E27	max. 60W	IP20	I

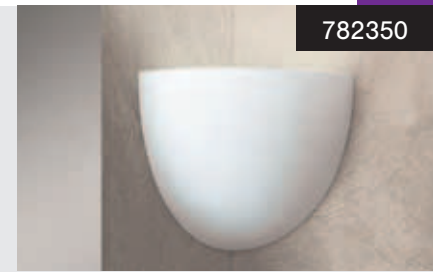

782350

rechter Winkel 90°
right angle 90°

Gips natur, strukturiert / plaster natural structured

Artikel-Nr. article-no.	Preis € price €	Farbe: weiß Art. Nr. 782451 inkl. Glasabdeckung colour: white art. nr. 782451 incl. covering-glass
782450	181,90	
782451	231,20	

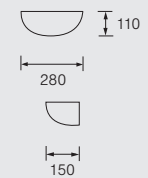

Artikel-Nr. article-no.	Bestückung lamp	Leistung power	Schutzart degree of protection	Schutzklasse protection class
782450	1x A45 E27	max. 60W	IP20	I
782451	1x GX24d-3 TC-T	26W VVG	IP20	I

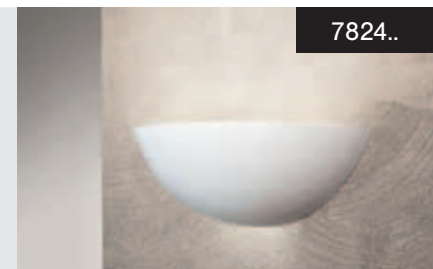

7824..

Indirekter und direkter Lichtaustritt
indirect and direct light exit

Gips natur, strukturiert / plaster natural structured

Artikel-Nr. article-no.	Preis € price €	Farbe: weiß Art. Nr. 784051 inkl. Glasabdeckung colour: white art. nr. 784051 incl. covering-glass
784050	179,80	
784051	232,00	

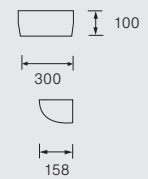

Artikel-Nr. article-no.	Bestückung lamp	Leistung power	Schutzart degree of protection	Schutzklasse protection class
784050	1x A45 E27	max. 60W	IP20	I
784051	1x G24d-3 TC-D	26W VVG	IP20	I



7840..

Indirekter und direkter Lichtaustritt
indirect and direct light exit

Gips natur, strukturiert / plaster natural structured

Artikel-Nr. article-no.	Preis € price €	Farbe: weiß Art. Nr. 785551 inkl. Glasabdeckung colour: white art. nr. 785551 incl. covering-glass
785550	173,40	
785551	229,00	

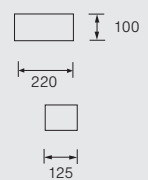

Artikel-Nr. article-no.	Bestückung lamp	Leistung power	Schutzart degree of protection	Schutzklasse protection class
785550	1x A45 E27	max. 60W	IP20	I
785551	1x G24d-3 TC-D	26W VVG	IP20	I



7855..

Indirekter und direkter Lichtaustritt
indirect and direct light exit



Gips natur, strukturiert / plaster natural structured

Artikel-Nr. article-no.	Preis € price €
782650	265,40

Farbe: weiß
colour: white

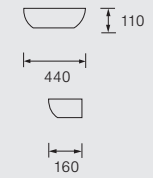

Artikel-Nr. article-no.	Bestückung lamp	Leistung power	Schutzart degree of protection	Schutzklasse protection class
782650	1x A45 E27	max. 60W	IP20	I

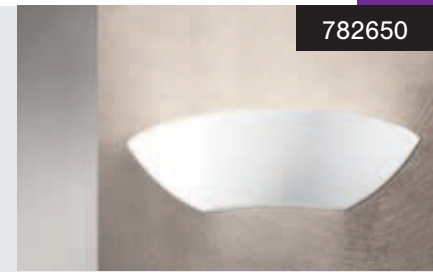

782650

Indirekter und direkter Lichtaustritt
indirect and direct light exit

Gips natur, strukturiert / plaster natural structured

Artikel-Nr. article-no.	Preis € price €
784550	194,80

Farbe: weiß
colour: white

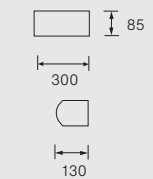

Artikel-Nr. article-no.	Bestückung lamp	Leistung power	Schutzart degree of protection	Schutzklasse protection class
784550	1x A60 E27	max. 100W	IP20	I



784550

Indirekter und direkter Lichtaustritt
indirect and direct light exit

Gips natur, strukturiert / plaster natural structured

Artikel-Nr. article-no.	Preis € price €
782950	244,00

Farbe: weiß
colour: white

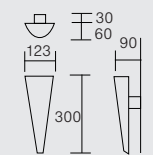

Artikel-Nr. article-no.	Bestückung lamp	Leistung power	Schutzart degree of protection	Schutzklasse protection class
782950	1x QT14 G9	max. 40W	IP20	I

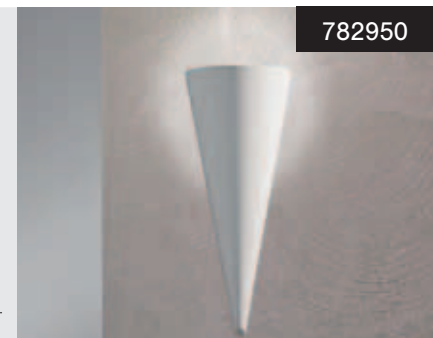

782950

Indirekter Lichtaustritt / indirect light exit

Gips natur, strukturiert / plaster natural structured

Artikel-Nr. article-no.	Preis € price €
782850	301,80

Farbe: weiß
Mindestabstand von
der Decke: 0,5m
colour: white
minimal ceiling distance: 0,5m

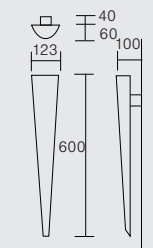

Artikel-Nr. article-no.	Bestückung lamp	Leistung power	Schutzart degree of protection	Schutzklasse protection class
782850	2x QT14 G9	max. 40W	IP20	I

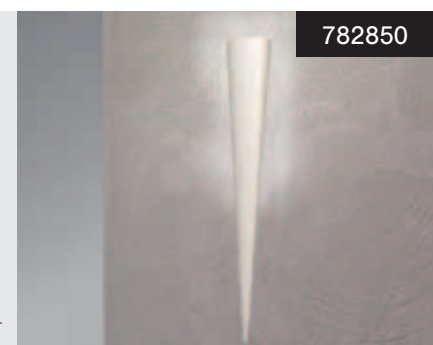

782850

Indirekter Lichtaustritt / indirect light exit

MODULO
ELECTRO
www.modulelectro.ru

Die Leuchten aus der Objekt-Kollektion faszinieren durch ihre Ästhetik und Formenvielfalt. Verschiedenste Materialien und Oberflächen runden das Portfolio dieser Kollektion ab.

The luminaries of the object – collection wins over aesthetics and in great variety of shapes. Miscellaneous materials and surfaces round up the portfolio of this collection.



MODUL
ELECTRO
www.modulelectro.ru



Business-Club, Fulda

540027

RGB-Objektleuchte / RGB-object lamp

Farbe: transparent / weiß / colour: transparent / white
 Lichtfarbe: RGB / light colour: RGB
 Steuerung: Infrarot / Master / control: infrared / master

Pendellänge / pendant length: 2250mm
 Dali VG für RGB-Steuerung inkl. / Dali VG for RGB control incl.

1 Master kann bis zu 9 Slaves steuern / 1 master can control up to 9 slaves

Wir empfehlen die Leuchtmittel Osram FQ24W / 67 (blau), 66 (grün), 60 (rot)
 We recommend the bulbs Osram FQ24W / 67 (blue), 66 (green), 60 (red)

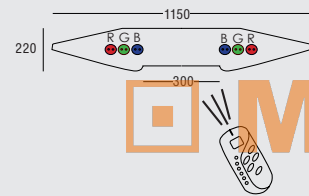
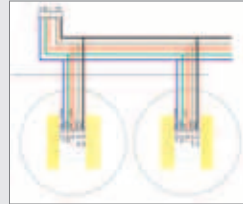

NEU
new

Art.-Nr. art-no.	Preis € price €	
540027	2295,00	ab Werk / ex factory

Material material	Bestückung lamp	Leistung power	Schutzart degree of protection	Schutzklasse protection class
Polyethylen-Stahl polyethylene-steel	6x T5 3x GX5,3	24W 35W	IP20	I

MODUL
ELECTRO

www.modulelectro.ru

540028

RGB-Objektleuchte / RGB-object lamp

Farbe: transparent / weiß / colour: transparent / white
 Lichtfarbe: RGB / light colour: RGB
 Steuerung: Slave (nicht ohne Master zu betreiben) / control: slave (not to actuate without master)

Pendellänge / pendant length: 2250mm

Wir empfehlen die Leuchtmittel Osram FQ24W / 67 (blau), 66 (grün), 60 (rot)
 We recommend the bulbs Osram FQ24W / 67 (blue), 66 (green), 60 (red)

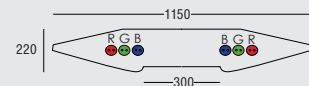
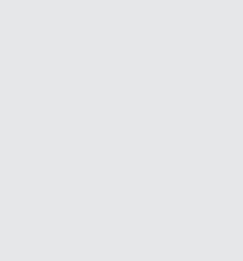

NEU
new

Art.-Nr. art-no.	Preis € price €	
540028	1595,00	ab Werk / ex factory

Material material	Bestückung lamp	Leistung power	Schutzart degree of protection	Schutzklasse protection class
Polyethylen-Stahl polyethylene-steel	6x T5 3x GX5,3	24W 35W	IP20	I

Palladium

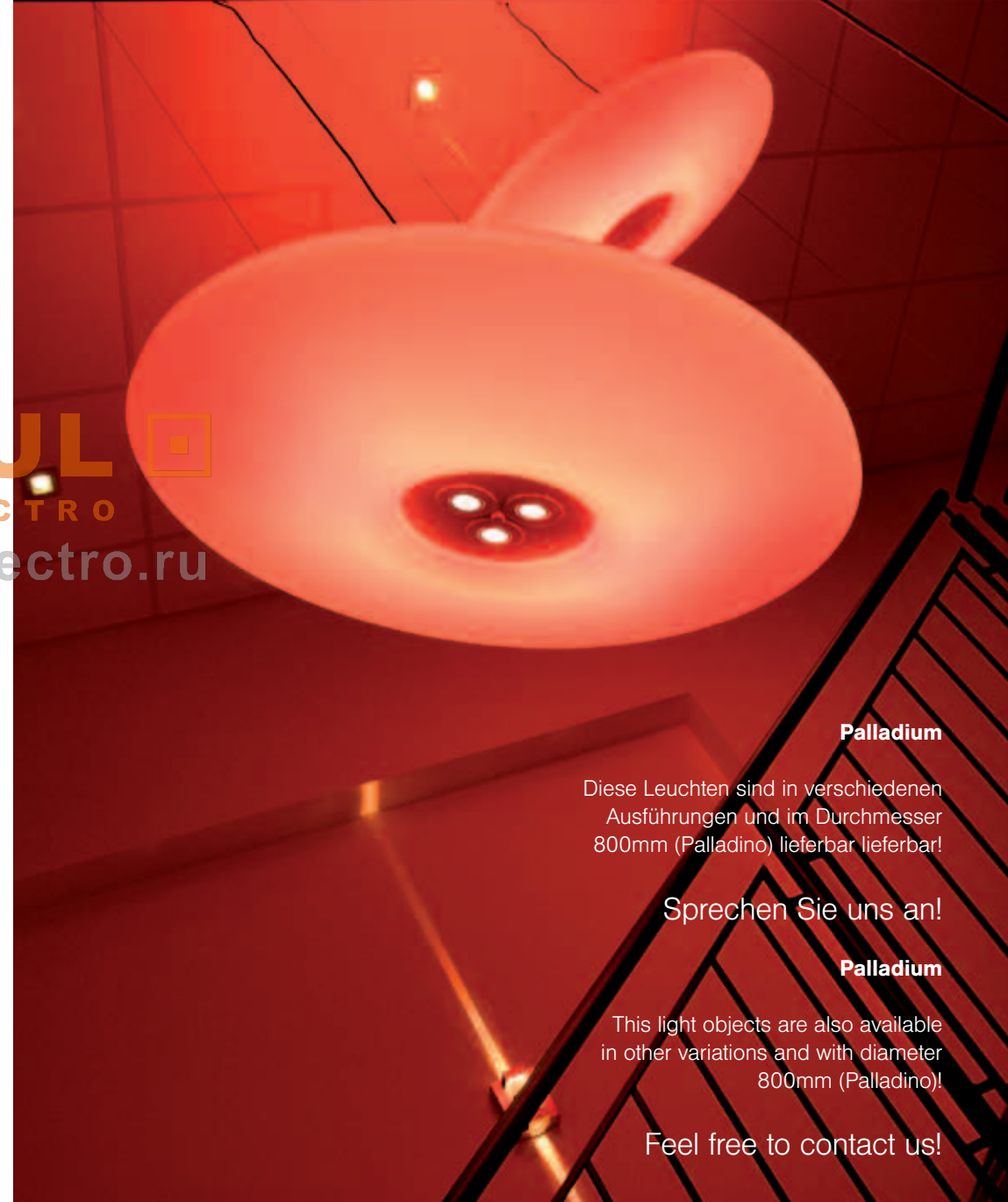

Palladium

Diese Leuchten sind in verschiedenen Ausführungen und im Durchmesser 800mm (Palladino) lieferbar lieferbar!

Sprechen Sie uns an!

Palladium

This light objects are also available in other variations and with diameter 800mm (Palladino)!

Feel free to contact us!

540025

RGB-Objektleuchte / RGB-object lamp

Farbe: transparent / weiß / colour: transparent / white
 Lichtfarbe: RGB / light colour: RGB
 Steuerung: Infrarot / Master / control: infrared / master

Pendellänge / pendant length: 2250mm
 Dali VG s. 540027 inkl. / Dali VG see product 540027 incl.

1 Master kann bis zu 9 Slaves steuern / 1 master can control up to 9 slaves

Wir empfehlen die Leuchtmittel Osram FQ24W / 67 (blau), 66 (grün), 60 (rot)
 We recommend the bulbs Osram FQ24W / 67 (blue), 66 (green), 60 (red)

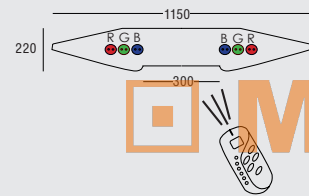
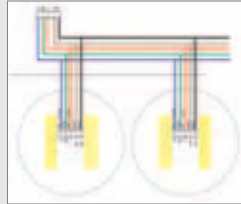

NEU
new

Art.-Nr. art.-no.	Preis € price €	
540025	2095,00	ab Werk / ex factory

Material material	Bestückung lamp	Leistung power	Schutzart degree of protection	Schutzklasse protection class
Polyethylen-Stahl polyethylene-steel	6x T5	24W	IP20	I

540026

RGB-Objektleuchte / RGB-object lamp

Farbe: transparent / weiß / colour: transparent / white
 Lichtfarbe: RGB / light colour: RGB
 Steuerung: Slave (nicht ohne Master zu betreiben) / control: slave (not to actuate without master)

Pendellänge / pendant length: 2250mm

Wir empfehlen die Leuchtmittel Osram FQ24W / 67 (blau), 66 (grün), 60 (rot)
 We recommend the bulbs Osram FQ24W / 67 (blue), 66 (green), 60 (red)

NEU
new

Art.-Nr. art.-no.	Preis € price €	
540026	1395,00	ab Werk / ex factory

Material material	Bestückung lamp	Leistung power	Schutzart degree of protection	Schutzklasse protection class
Polyethylen-Stahl polyethylene-steel	6x T5	24W	IP20	I

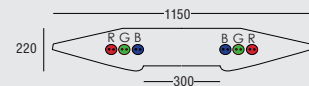

MODUL
ELECTRO
www.modulelectro.ru

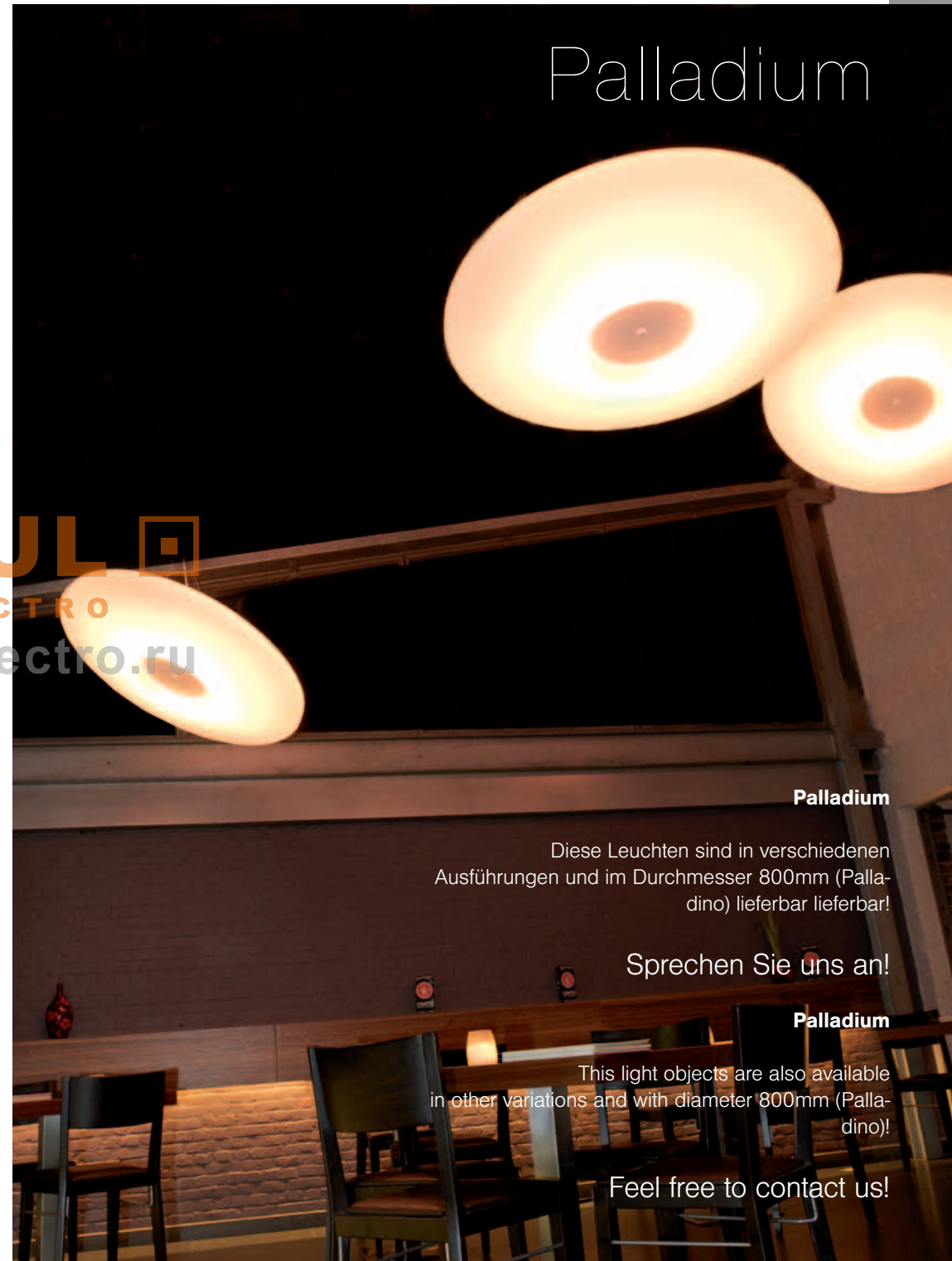

Palladium

Palladium

Diese Leuchten sind in verschiedenen Ausführungen und im Durchmesser 800mm (Palladino) lieferbar lieferbar!

Sprechen Sie uns an!

Palladium

This light objects are also available in other variations and with diameter 800mm (Palladino)!

Feel free to contact us!

512811



Deckeneinbauleuchte
recessed luminaire

Farbe: alu matt / colour: alu satin

NEU
new

Art.-Nr. art.-no.	Preis € price €
512811	29,00

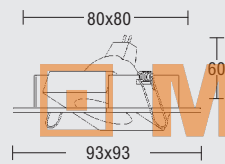

Material	Bestückung lamp	Leistung power	Schutzart degree of protection	Schutzklasse protection class
Aluminium / aluminium	1x GX5,3 QRBC51	max. 50W	IP20	III

MODUL
ELECTRO

www.modulelectro.ru

512812



Deckeneinbauleuchte
recessed luminaire

Farbe: alu matt / colour: alu satin

NEU
new

Art.-Nr. art.-no.	Preis € price €
512812	49,00

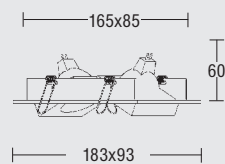

Material	Bestückung lamp	Leistung power	Schutzart degree of protection	Schutzklasse protection class
Aluminium / aluminium	2x GX5,3 QRBC51	max. 50W	IP20	III



512411



Deckeneinbauleuchte kardanische Aufhängung
recessed luminaire gimball mounted

Farbe: alu matt / colour: alu satin

Art-Nr. art-no.	Preis € price €
512411	49,00

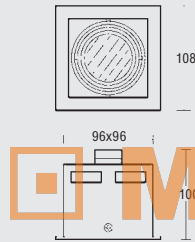
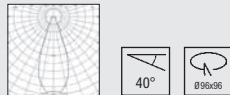

Material	Bestückung lamp	Leistung power	Schutzart degree of protection	Schutzklasse protection class
Guss / cast	1x GX5,3 QRCBC51	max. 50W	IP20	III

512413



Deckeneinbauleuchte kardanische Aufhängung
recessed luminaire gimball mounted

Farbe: alu matt / colour: alu satin

Art-Nr. art-no.	Preis € price €
512413	137,00

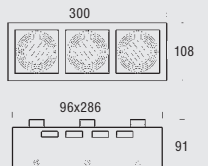
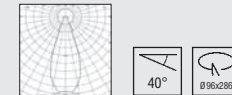

Material	Bestückung lamp	Leistung power	Schutzart degree of protection	Schutzklasse protection class
Guss / cast	3x GX5,3 QRCBC51	max. 50W	IP20	III

512412



Deckeneinbauleuchte kardanische Aufhängung
recessed luminaire gimball mounted

Farbe: alu matt / colour: alu satin

Art-Nr. art-no.	Preis € price €
512412	98,00

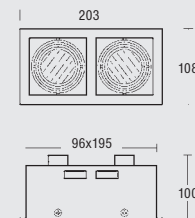
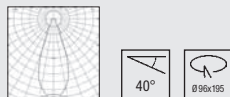

Material	Bestückung lamp	Leistung power	Schutzart degree of protection	Schutzklasse protection class
Guss / cast	2x GX5,3 QRCBC51	max. 50W	IP20	III

www.modulelectro.ru



512541



Deckeneinbauleuchte kardanische Aufhängung
recessed luminaire gimball mounted

Farbe: alu gebürstet / colour: alu brushed

Art-Nr. art-no.	Preis € price €
512541	104,80

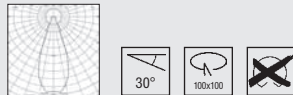

Material	Bestückung lamp	Leistung power	Schutzart degree of protection	Schutzklasse protection class
Aluminium / aluminium	1x GX5,3 QRCBC51	max. 50W	IP20	III

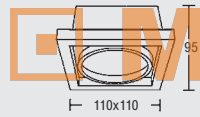

512543



Deckeneinbauleuchte kardanische Aufhängung
recessed luminaire gimball mounted

Farbe: alu gebürstet / colour: alu brushed

Art-Nr. art-no.	Preis € price €
512543	254,80

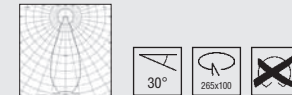

Material	Bestückung lamp	Leistung power	Schutzart degree of protection	Schutzklasse protection class
Aluminium / aluminium	3x GX5,3 QRCBC51	max. 50W	IP20	III

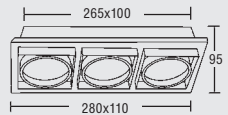

MODULO
ELECTRO

www.modulelectro.ru

512542



Deckeneinbauleuchte kardanische Aufhängung
recessed luminaire gimball mounted

Farbe: alu gebürstet / colour: alu brushed

Art-Nr. art-no.	Preis € price €
512542	177,40

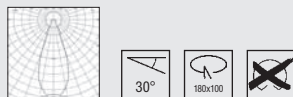

Material	Bestückung lamp	Leistung power	Schutzart degree of protection	Schutzklasse protection class
Aluminium / aluminium	2x GX5,3 QRCBC51	max. 50W	IP20	III

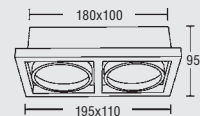

512431



Deckeneinbauleuchte kardanische Aufhängung
recessed luminaire gimball mounted

Farbe: weiß / schwarz / colour: white / black

Art-Nr. art-no.	Preis € price €
512431	60,80

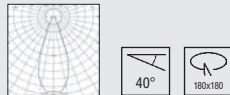

Material material	Bestückung lamp	Leistung power	Schutzart degree of protection	Schutzklasse protection class
Guss-Metall / cast-metal	1x G53 QR-LP111	max. 50W	IP20	III

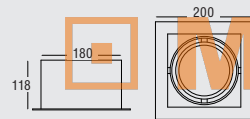

522226



Deckeneinbauleuchte
recessed luminaire

Farbe: schwarz-aluminium / colour: black-aluminium
EVG siehe Seite 465
electronic ballast see page 465

Art-Nr. art-no.	Preis € price €
522226	177,50

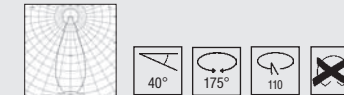

Material material	Bestückung lamp	Leistung power	Schutzart degree of protection	Schutzklasse protection class
Aluminium-Glas aluminium-glas	1x CDM-Tm	20/35W	IP20	II

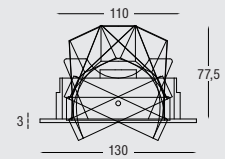

512432



Deckeneinbauleuchte kardanische Aufhängung
recessed luminaire gimball mounted

Farbe: weiß / schwarz / colour: white / black

Art-Nr. art-no.	Preis € price €
512432	94,80

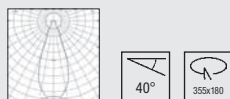

Material material	Bestückung lamp	Leistung power	Schutzart degree of protection	Schutzklasse protection class
Guss-Metall / cast-metal	2x G53 QR-LP111	max. 50W	IP20	III

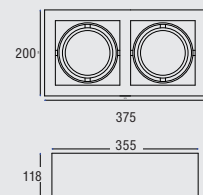

512701



Deckeneinbauleuchte
recessed luminaire

Farbe: schwarz-aluminium / colour: black-aluminium
EVG siehe Seite 465
electronic ballast see page 465

Art-Nr. art-no.	Preis € price €
512701	185,50



Material material	Bestückung lamp	Leistung power	Schutzart degree of protection	Schutzklasse protection class
Aluminium-Glas aluminium-glas	1x CDM-Tm	20/35W	IP20	II

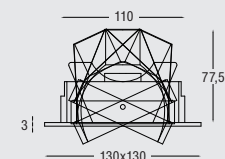

www.modulelectro.ru

MODULELECTRO

512474



Deckeneinbauleuchte
recessed luminaire

Farbe: alu matt / colour: au satin

NEU
new

Art-Nr. art-no.	Preis € price €
512474	64,00

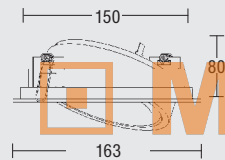
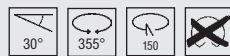

Material material	Bestückung lamp	Leistung power	Schutzart degree of protection	Schutzklasse protection class
Aluminium / aluminium	1x G53 QR-LP111	max. 50W	IP20	III

512761



Deckeneinbauleuchte
recessed luminaire

Farbe: weiß / colour: white

Art-Nr. art-no.	Preis € price €
512761	43,40

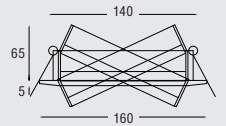

Material material	Bestückung lamp	Leistung power	Schutzart degree of protection	Schutzklasse protection class
Aluminiumguss aluminium cast	1x G53 QR-LP111	max. 50W	IP20	III

512475



Deckeneinbauleuchte
recessed luminaire

Farbe: alu matt / colour: au satin

NEU
new

Art-Nr. art-no.	Preis € price €
512475	68,00

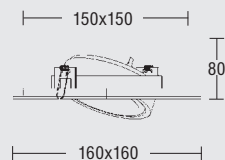

Material material	Bestückung lamp	Leistung power	Schutzart degree of protection	Schutzklasse protection class
Aluminium / aluminium	1x G53 QR-LP111	max. 50W	IP20	III

www.modulelectro.ru



540420



Pendelleuchte kardanisch
gimballed pendant lamp

Farbe: edelstahl / colour: stainless steel
inkl. elektronischem Transformator / incl. electronic transformer
Aufhängung über Deckenplatte
Seilabhängung: max. 1,5m
attachment with ceiling-plate
wire length: max. 1,5m

Art.-Nr. art.-no.	Preis € price €
540420	862,90

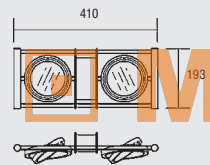

Material material	Bestückung lamp	Leistung power	Schutzart degree of protection	Schutzklasse protection class
Edelstahl-Aluminium stainless steel-aluminium	2x G53 QR-LP111	max. 50W	IP20	I

540440



Pendelleuchte kardanisch
gimballed pendant lamp

Farbe: edelstahl / colour: stainless steel
inkl. elektronischem Transformator / incl. electronic transformer
Aufhängung über Deckenplatte
Seilabhängung: max. 1,5m
attachment with ceiling-plate
wire length: max. 1,5m

Art.-Nr. art.-no.	Preis € price €
540440	1.382,40

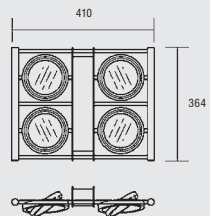

Material material	Bestückung lamp	Leistung power	Schutzart degree of protection	Schutzklasse protection class
Edelstahl-Aluminium stainless steel-aluminium	4x G53 QR-LP111	max. 50W	IP20	I

MODULO
ELECTRO
www.modulelectro.ru



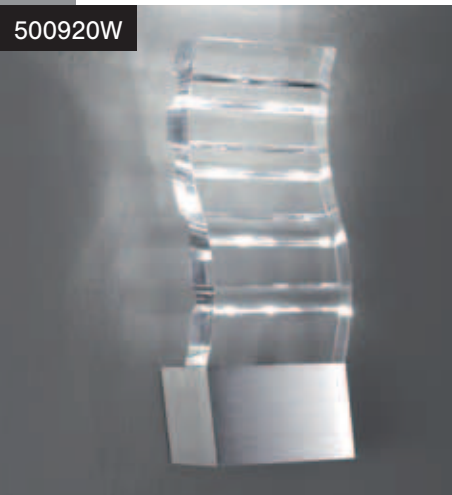

LED-Wandleuchte / LED wall lamp

Farbe: aluminium / colour: aluminium
 Lichtfarbe: kaltweiß / light colour: cold white
 inkl. Konverter / incl. converter

Art-Nr. art-no.	Preis € price €
500920W	249,00

Material material	Bestückung lamp	Leistung power	Schutzart degree of protection	Schutzklasse protection class
Aluminium-Acryl aluminium-acryl	3x Power-LED	je 1,0W	IP20	I

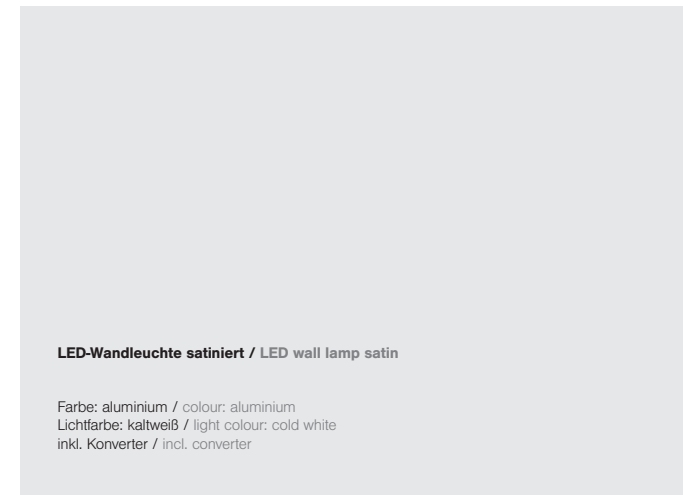
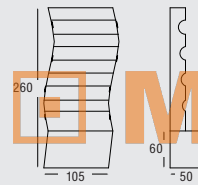

LED-Wandleuchte satiniert / LED wall lamp satin

Farbe: aluminium / colour: aluminium
 Lichtfarbe: kaltweiß / light colour: cold white
 inkl. Konverter / incl. converter

Art-Nr. art-no.	Preis € price €
500916W	239,00

Material material	Bestückung lamp	Leistung power	Schutzart degree of protection	Schutzklasse protection class
Aluminium-Acryl aluminium-acryl	3x Power-LED	je 1,0W	IP20	I

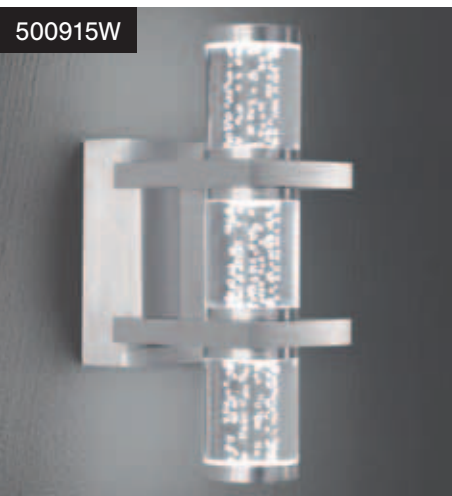
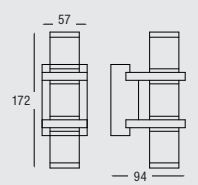

LED-Wandleuchte Perlenoptik / LED wall lamp pearl optic

Farbe: aluminium / colour: aluminium
 Lichtfarbe: kaltweiß / light colour: cold white
 inkl. Konverter / incl. converter

Art-Nr. art-no.	Preis € price €
500915W	239,00

Material material	Bestückung lamp	Leistung power	Schutzart degree of protection	Schutzklasse protection class
Aluminium-Acryl aluminium-acryl	3x Power-LED	je 1,0W	IP20	I

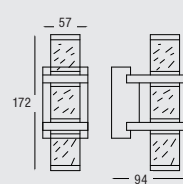

LED-Wandleuchte / LED wall lamp

Farbe: aluminium / colour: aluminium
 Lichtfarbe: kaltweiß / light colour: cold white
 inkl. Konverter / incl. converter

Art-Nr. art-no.	Preis € price €
500925W	269,00

Material material	Bestückung lamp	Leistung power	Schutzart degree of protection	Schutzklasse protection class
Aluminium-Acryl aluminium-acryl	3x Power-LED	je 1,0W	IP20	I

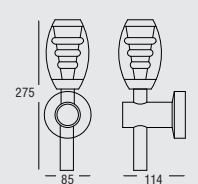

www.modulelectro.ru

MODULELECTRO



LED-Wandleuchte / LED wall lamp

Farbe: aluminium / colour: aluminium
 Lichtfarbe: kaltweiß / light colour: cold white
 inkl. Konverter / incl. converter

Verschiedene LED-Farbkombinationen auf Anfrage möglich!
 different LED-colour combinations available on request!

Art-Nr. art-no.	Preis € price €
500910W	269,00

Material material	Bestückung lamp	Leistung power	Schutzart degree of protection	Schutzklasse protection class
Aluminium aluminium	3x Power-LED	je 1,0W	IP20	I

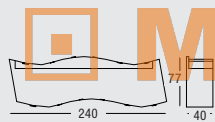

LED-Wandleuchte / LED wall lamp

Farbe: aluminium / colour: aluminium
 Lichtfarbe: kaltweiß / light colour: cold white
 inkl. Konverter / incl. converter

Art-Nr. art-no.	Preis € price €
500236W	189,00

Material material	Bestückung lamp	Leistung power	Schutzart degree of protection	Schutzklasse protection class
Aluminium aluminium	2x Power-LED	je 1,0W	IP44	I

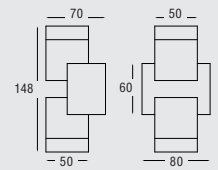

LED-Wandleuchte / LED wall lamp

Farbe: aluminium / colour: aluminium
 Lichtfarbe: kaltweiß / light colour: cold white
 inkl. Konverter / incl. converter

Art-Nr. art-no.	Preis € price €
500235W	129,00

Material material	Bestückung lamp	Leistung power	Schutzart degree of protection	Schutzklasse protection class
Aluminium aluminium	1x Power-LED	1,0W	IP44	I

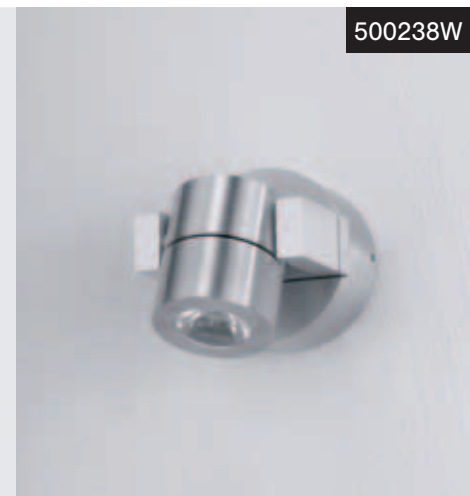
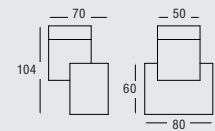

LED-Wandleuchte / LED wall lamp

Farbe: aluminium / colour: aluminium
 Lichtfarbe: kaltweiß / light colour: cold white
 inkl. Konverter / incl. converter

verstellbar / adjustable

Art-Nr. art-no.	Preis € price €
500238W	139,00

Material material	Bestückung lamp	Leistung power	Schutzart degree of protection	Schutzklasse protection class
Aluminium aluminium	1x Power-LED	1,0W	IP44	I

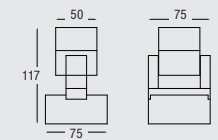

www.modulelectro.ru





Hotel Tannenhof, Grossmaiseid

500172

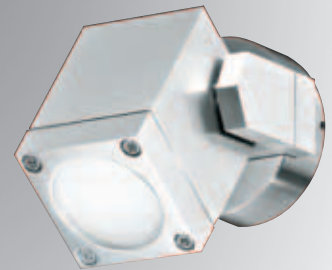

Wandleuchte / wall lamp

Farbe: alu glänzend - alu matt / colour: alu shine - alu satin
 Glas satiniert / glass satin

verstellbar / adjustable

Hochvolt / high voltage

Art.-Nr. art.-no.	Preis € price €
500172	123,90



Material material	Bestückung lamp	Leistung power	Schutzart degree of protection	Schutzklasse protection class
Massiv Aluminium massive aluminium	1x GU10 QPAR51	max. 35W	IP20	I

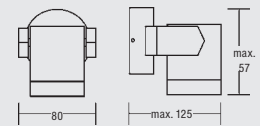

MODULO
ELECTRO
www.modulelectro.ru

500171

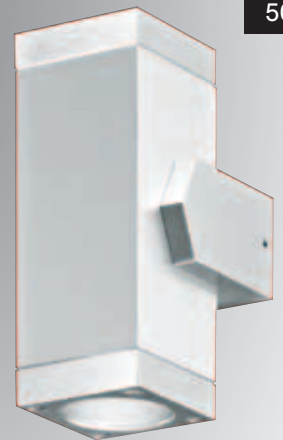

Wandleuchte / wall lamp

Farbe: alu glänzend - alu matt / colour: alu shine - alu satin
 Glas satiniert / glass satin

Hochvolt / high voltage

Art.-Nr. art.-no.	Preis € price €
500171	210,80



Material material	Bestückung lamp	Leistung power	Schutzart degree of protection	Schutzklasse protection class
Massiv Aluminium massive aluminium	2x GU10 QPAR51	max. 35W	IP20	I

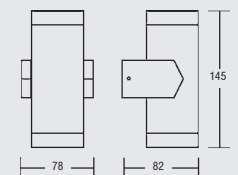

500165

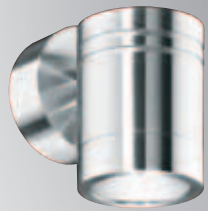

Wandleuchte / wall lamp

Farbe: alu glänzend - alu matt / colour: alu shine - alu satin
 Glas satiniert / glass satin

Hochvolt / high voltage

Art.-Nr. art-no.	Preis € price €
500165	75,00



Material material	Bestückung lamp	Leistung power	Schutzart degree of protection	Schutzklasse protection class
Massiv Aluminium massive aluminium	1x GU10 QPAR51	max. 35W	IP20	I

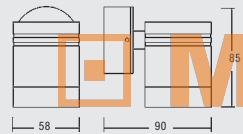

500176

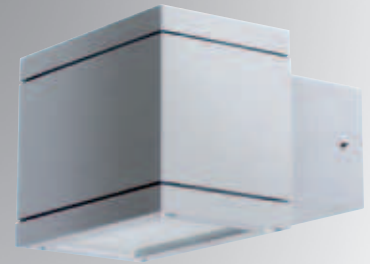

Wandleuchte / wall lamp

Farbe: alu matt / colour: alu satin
 Glas satiniert / glass satin

Direkter und indirekter Lichtaustritt / direct and indirect light exit

Hochvolt / high voltage

Art.-Nr. art-no.	Preis € price €
500176	88,20

Material material	Bestückung lamp	Leistung power	Schutzart degree of protection	Schutzklasse protection class
Massiv Aluminium massive aluminium	1x G9 QT14	max. 25W	IP44	I

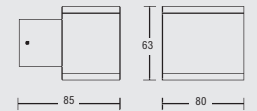

500147



Wandleuchte / wall lamp

Farbe: alu glänzend - alu matt / colour: alu shine - alu satin
 Glas satiniert / glass satin

Hochvolt / high voltage

Art.-Nr. art-no.	Preis € price €
500147	148,90



Material material	Bestückung lamp	Leistung power	Schutzart degree of protection	Schutzklasse protection class
Massiv Aluminium massive aluminium	2x GU10 QPAR51	max. 35W	IP20	I

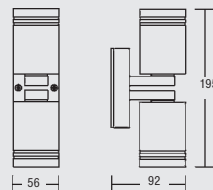

500177

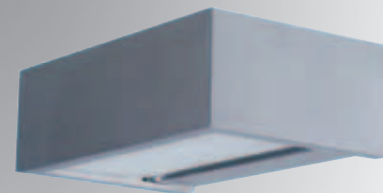

Wandleuchte / wall lamp

Farbe: alu matt / colour: alu satin
 Glas satiniert / glass satin

Direkter und indirekter Lichtaustritt / direct and indirect light exit

Hochvolt / high voltage

Art.-Nr. art-no.	Preis € price €
500177	99,80

Material material	Bestückung lamp	Leistung power	Schutzart degree of protection	Schutzklasse protection class
Massiv Aluminium massive aluminium	1x R7s 74,9mm	max. 60W	IP20	I



www.modulelectro.ru

MODULELECTRO



Konverter / Transformatoren / Leuchtmittel sowie Zubehör für NV-Einbaustrahler. Damit Sie schnell und unkompliziert mit der Umsetzung Ihres Lichtkonzeptes beginnen können.

Converter / transformers / bulbs and accessories for low voltage-spots. Prepared to start up fast and uncomplicated with the realization of your light concept.

MODUL
ELECTRO
www.modulelectro.ru



3513

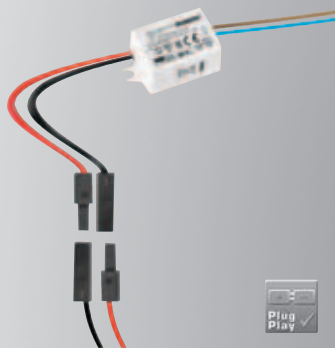

LED-Konverter 350mA / LED converter 350mA

Artikel-Nr. article-no.	Preis € price €
3513	24,90

Für den Einsatz von 1-3 Power-LED
 prim. 95-260V
 Frequenz: 50-60Hz
 sec. 350mA Konstantstrom (Reihenschaltung)

Maße: 52 x 26 x 22mm

Leistung: ca. 3,6W / 350mA

for the use of 1-3 Power-LED

prim. 95-260V
 frequency: 50-60Hz
 sec. 350mA constant current (series connexion)

dimensions: 52 x 26 x 22mm

power: approx. 3,6W / 350mA



3505

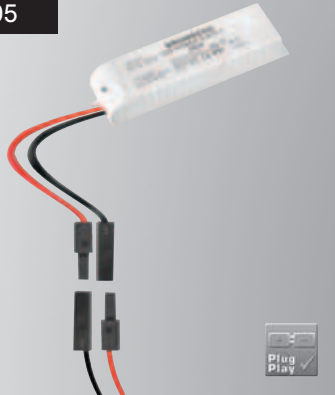

LED-Konverter 350mA / LED converter 350mA

Artikel-Nr. article-no.	Preis € price €
3505	29,90

Für den Einsatz von 1-9 Power-LED
 prim. 95-260V AC
 Frequenz: 50-60Hz
 130V-375V DC
 sec. 350mA Konstantstrom (Reihenschaltung)

Maße: 120 x 32 x 22mm
 Leistung: ca. 11W / 350mA

for the use of 1-9 Power-LED

prim. 95-260V AC
 frequency: 50-60Hz
 130V-375V DC
 sec. 350mA constant current (series connexion)

dimensions: 120 x 32 x 22mm
 power: approx. 11W / 350mA



3514



LED-Konverter 350mA / LED converter 350mA

Artikel-Nr. article-no.	Preis € price €
3514	99,00

Für den Einsatz von 1-12 Power-LED
 Mit Dimmschnittstelle

prim. 220-240V
 Frequenz: 50-60Hz, sec. 350mA Konstantstrom (Reihenschaltung)

Dimmbereich: 0-100%, Schnittstelle: 0-10V
 Dimmbar über Steuersignal: 0-10V

Maße: 103 x 67 x 30mm
 Leistung: ca. 17W / 350mA

for the use of 1-12 Power-LED
 with interface for dimming

prim. 220-240V
 frequency: 50-60Hz, sec. 350mA constant current (series connexion)

dimming area: 0-100%, port: 0-10V
 dimmable by signal: 0-10V

dimensions: 103 x 67 x 30mm
 power: approx. 17W / 350mA



MODUL
ELECTRO
www.modulelectro.ru

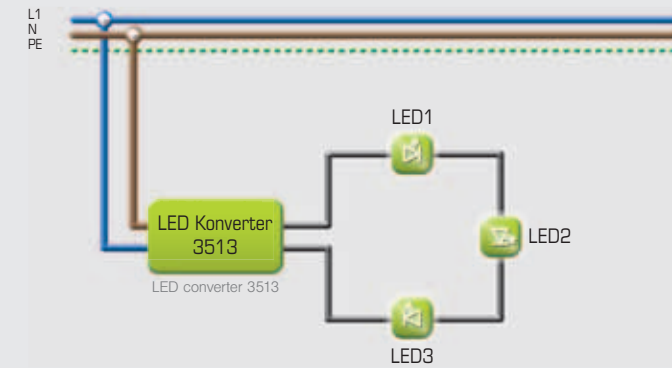

Reihenschaltung, max. Leitungslänge sekundärseitig 10m
 series connexion, max. length of connection cable secondary side 10m

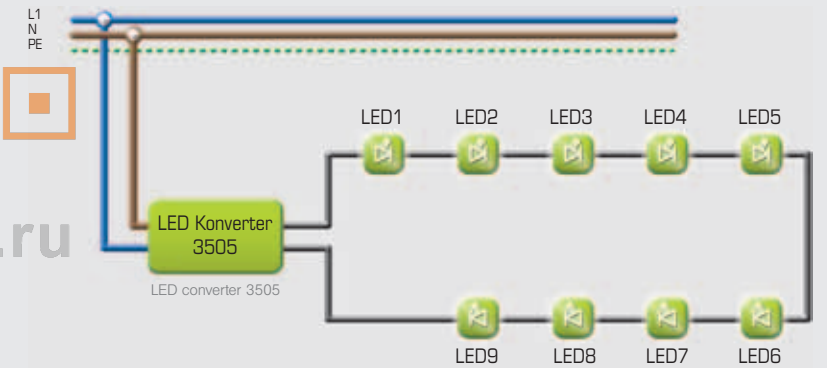

Reihenschaltung, max. Leitungslänge sekundärseitig 20m
 series connexion, max. length of connection cable secondary side 20m

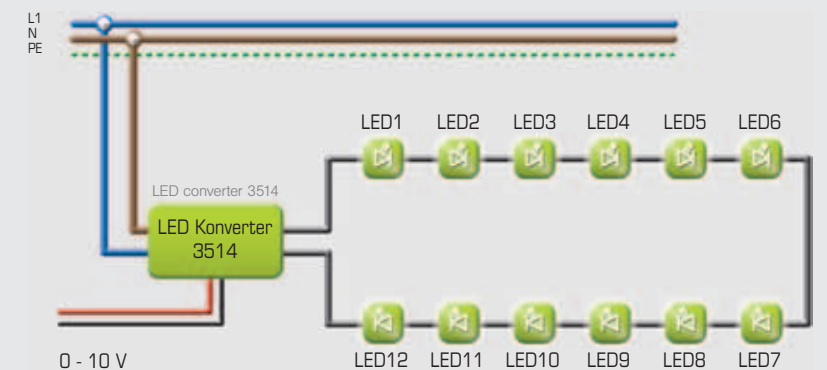

Reihenschaltung, max. Leitungslänge sekundärseitig 10m
 series connexion, max. length of connection cable secondary side 10m

3515

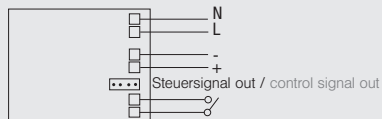

LED-Konverter 350mA / LED converter 350mA

Artikel-Nr. article-no.	Preis € price €
3515	89,00

LED-Konverter „Master“

Netzgerät für Power-LED
Leistung 17W (für max. 12x Power-LED)

DC 350mA, Konstantstrom (Reihenschaltung)
dimmbar über separaten Taster (Potentialfrei)

prim. 220-240V
Frequenz: 50-60Hz
Maße: 103 x 67 x 30mm

LED-converter „Master“

supply unit for Power-LED
power 17W (for max. 12x Power-LED)

d.c. 350mA, constant current (series connexion)
dimmbable by separate push button (potential-free)

prim. 220-240V
frequency: 50-60Hz
dimensions: 103 x 67 x 30mm

3516

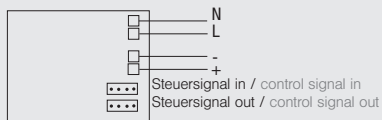

LED-Konverter 350mA / LED converter 350mA

Artikel-Nr. article-no.	Preis € price €
3516	89,00

LED-Konverter „Slave“

Netzgerät für Power-LED
Funktion nur in Verbindung mit „Master“ 3515
Leistung 17W
(für max. 12x Power-LED) DC 350mA
Konstantstrom (Reihenschaltung)

Es können bis zu 99 „Slave-Geräte“ an einen Master-Konverter angeschlossen werden. So besteht die Möglichkeit, die Helligkeit von bis zu 1200 Hochleistungsdioden über einen einzigen Taster zu regeln.

prim. 220-240V
Frequenz: 50-60Hz
Maße: 103 x 67 x 30mm

LED-converter „Slave“

supply unit for Power-LED
operation in connexion with „Master“ 3515 power 17W (for max. 12x Power-LED) d.c. 350mA constant current (series connexion)

Up to 99 "Slave" converter can be connected to one „Master“ converter. This gives the possibility to control the brightness from up to 1200 high-performance diodes by only one push-button.

prim. 220-240V
frequency: 50-60Hz
dimensions: 103 x 67 x 30mm

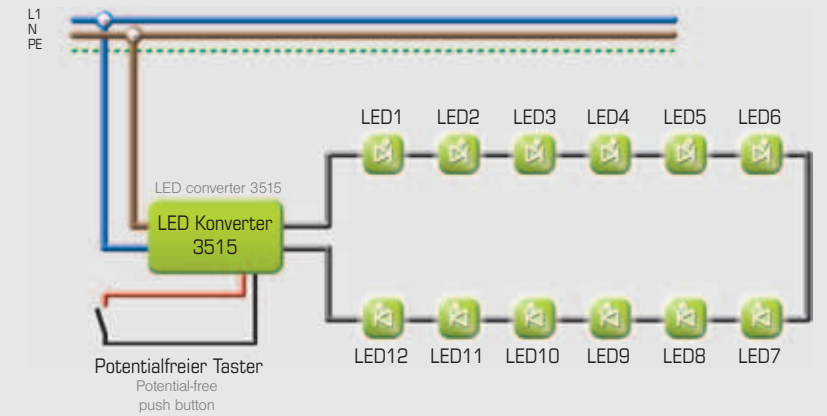
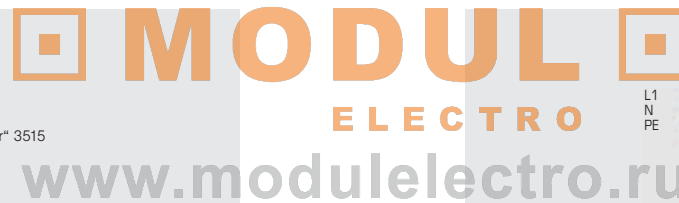

Reihenschaltung, max. Leitungslänge sekundärseitig 10m
series connexion, max. length of connection cable secondary side 10m

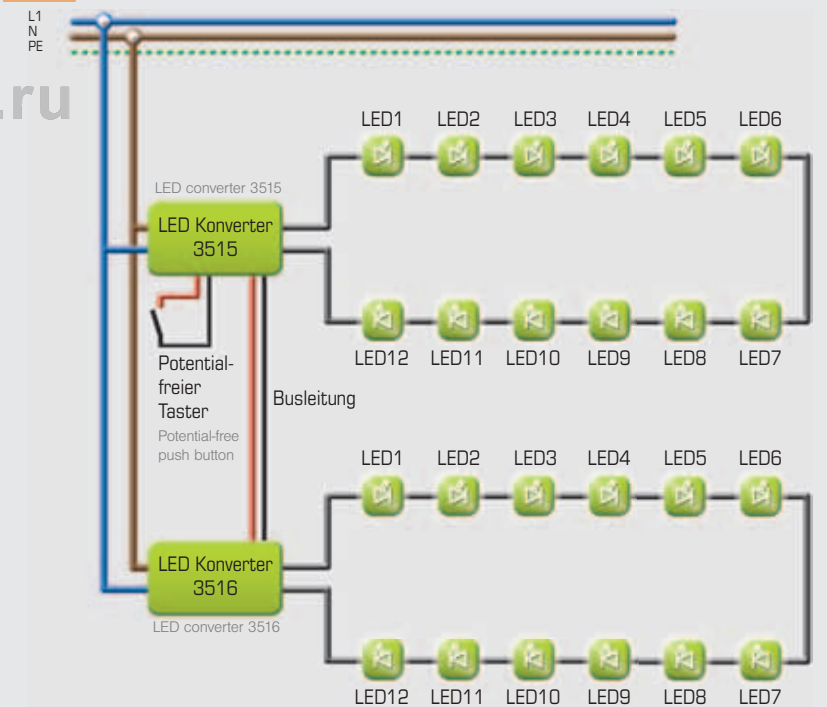

Reihenschaltung, max. Leitungslänge sekundärseitig 10m
series connexion, max. length of connection cable secondary side 10m

3517



LED-Konverter 700mA / LED converter 700mA

Artikel-Nr. article-no.	Preis € price €
3517	24,90

Für den Einsatz von 1-3 Power-LED
prim. 220-240V
Frequenz: 50-60Hz
sec. 700mA Konstantstrom (Reihenschaltung)

Maße: 80 x 38 x 23mm

Leistung: ca. 9,0W / 700mA

for the use of 1-3 Power-LED

prim. 220-240V
frequency: 50-60Hz
sec. 700mA constant current (series connexion)

dimensions: 80 x 38 x 23mm

power: approx. 9,0W / 700mA

3518



LED-Konverter 700mA / LED converter 700mA

Artikel-Nr. article-no.	Preis € price €
3518	32,50

Für den Einsatz von 1-6 Power-LED
prim. 220-240V
Frequenz: 50-60Hz
sec. 700mA Konstantstrom (Reihenschaltung)

Maße: 126 x 42 x 20mm
Leistung: ca. 18W / 700mA

for the use of 1-6 Power-LED

prim. 220-240V
frequency: 50-60Hz
sec. 700mA constant current (series connexion)

dimensions: 126 x 42 x 20mm
power: approx. 18W / 700mA

3519



LED-Konverter 700mA / LED converter 700mA

Artikel-Nr. article-no.	Preis € price €
3519	49,90

Für den Einsatz von 1-12 Power-LED
prim. 220-240V
Frequenz: 50-60Hz
sec. 700mA Konstantstrom (Reihenschaltung)

Maße: 136 x 42,5 x 26,5mm
Leistung: ca. 36W / 700mA

for the use of 1-12 Power-LED

prim. 220-240V
frequency: 50-60Hz
sec. 700mA constant current (series connexion)

dimensions: 136 x 42,5 x 26,5mm
power: approx. 36W / 700mA

SL3517

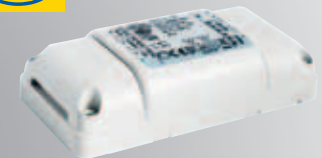

Hella LED-Konverter 700 mA / Hella LED converter 700mA

Artikel-Nr. article-no.	Preis € price €
SL3517	98,00

Für den Einsatz von 1-2 Spots SL50... oder SL60...
for the use of 1-2 Power-Spots SL50...SL60...

prim. 220-240V
Frequenz / frequency: 50-60Hz
sec. 700mA Konstantstrom (Reihenschaltung)
constant current (series connexion)
dimmbar über 1-10V

Maße / dimensions: 102 x 52 x 26mm
Leistung / power: ca. / approx. 50W/700mA

Ambienteinstellung: Hella Spots mit innen- und außenliegendem Ambientlicht können in Verbindung mit:
- einem 1-10V Dimmer gesteuert werden – wird das Hauptlicht auf <2V herunter gedimmt, aktiviert dies automatisch die Ambiente-Funktion.
- einem Serienschalter gesteuert werden – Ist das Ambientlicht eingeschaltet und wird das Hauptlicht aktiviert, geht die Ambiente-Funktion automatisch aus.

Hauptlichtansteuerung: Die Hauptlichtansteuerung ohne Ambientlicht (SL600NW4) kann über einen 1-10V Dimmer bzw. Schalter erfolgen.

Ambience control: Hella spots with an inner und outer ambient light can be regulated in connection with:
- a 1-10V dimmer - if the main light is regulated down to <2V, the ambience function is automatically activated
- switch series - if the ambient light is switched on and the main light activated, the ambience function is automatically stopped

Main light control: The control of the main light without ambient light (SL600NW4) can effect by a 1-10V dimmer or switch.

SL3518



Hella LED-Konverter 700 mA / Hella LED converter 700mA

Artikel-Nr. article-no.	Preis € price €
SL3518	138,00

Für den Einsatz von 1-4 Spots SL50... oder SL60...
for the use of 1-4 Power-Spots SL50... or SL60...

prim. 220-240V
Frequenz / frequency: 50-60Hz
sec. 700mA Konstantstrom (Reihenschaltung)
constant current (series connexion)
dimmbar über 1-10V

Maße / dimensions: 71 x 69 x 38mm
Leistung / power: ca. / approx. 50W/700mA

Ambienteinstellung: Hella Spots mit innen- und außenliegendem Ambientlicht können in Verbindung mit:
- einem 1-10V Dimmer gesteuert werden – wird das Hauptlicht auf <2V herunter gedimmt, aktiviert dies automatisch die Ambiente-Funktion.
- einem Serienschalter gesteuert werden – Ist das Ambientlicht eingeschaltet und wird das Hauptlicht aktiviert, geht die Ambiente-Funktion automatisch aus.

Hauptlichtansteuerung: Die Hauptlichtansteuerung ohne Ambientlicht (SL600NW4) kann über einen 1-10V Dimmer bzw. Schalter erfolgen.

Ambience control: Hella spots with an inner und outer ambient light can be regulated in connection with:
- a 1-10V dimmer - if the main light is regulated down to <2V, the ambience function is automatically activated
- switch series - if the ambient light is switched on and the main light activated, the ambience function is automatically stopped

Main light control: The control of the main light without ambient light (SL600NW4) can effect by a 1-10V dimmer or switch.

3511



LED-Konverter 1400mA / LED converter 1400mA

Artikel-Nr. article-no.	Preis € price €
3511	49,90

Für den Einsatz von 1-5 Power-LED 6,0W

prim. 220-240V AC
Frequenz: 50-60Hz
sec. 1400mA Konstantstrom (Reihenschaltung)

Maße: 136 x 42,5 x 26,5mm

Leistung: ca. 30W / 1400mA

for the use of 1-5 Power-Spots 6,0W

prim. 220-240V
frequency: 50-60Hz
sec. 1400mA constant current (series connexion)

dimensions: 136 x 42,5 x 26,5mm

power: approx. 30W / 1400mA

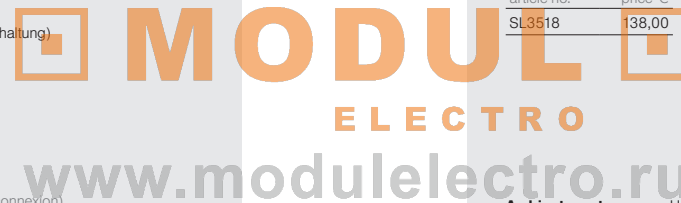

3835

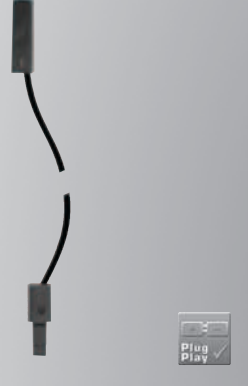

500 mm



Plug & Play Verlängerungskabel 350mA / Plug & Play extension cord 350mA

Artikel-Nr. article-no.	Preis € price €
3835	2,60

Für 350mA (Reihenschaltung)
Länge: 500m

for 350mA (series connexion)
length: 500m

3836



1000 mm



Plug & Play Verlängerungskabel 350mA / Plug & Play extension cord 350mA

Artikel-Nr. article-no.	Preis € price €
3836	3,20

Für 350mA (Reihenschaltung)
Länge: 1000m

for 350mA (series connexion)
length: 1000m

3837



2000 mm



Plug & Play Verlängerungskabel 350mA / Plug & Play extension cord 350mA

Artikel-Nr. article-no.	Preis € price €
3837	3,80

Für 350mA (Reihenschaltung)
Länge: 2000m

for 350mA (series connexion)
length: 2000m

3838

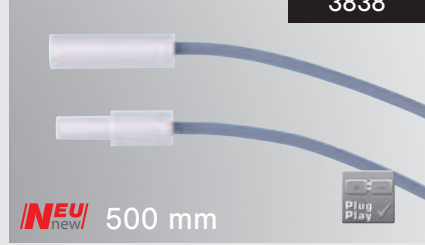

NEU new 500 mm



Plug & Play Verlängerungskabel 700mA / Plug & Play extension cord 700 mA

Artikel-Nr. article-no.	Preis € price €
3838	2,70

Für 700mA (Reihenschaltung)
Länge: 500m

for 700mA (series connexion)
length: 500m

3839

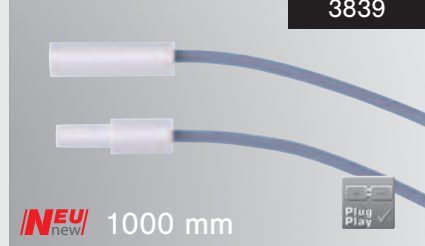

NEU new 1000 mm



Plug & Play Verlängerungskabel 700mA / Plug & Play extension cord 700 mA

Artikel-Nr. article-no.	Preis € price €
3839	3,30

Für 700mA (Reihenschaltung)
Länge: 1000m

for 700mA (series connexion)
length: 1000m

3840

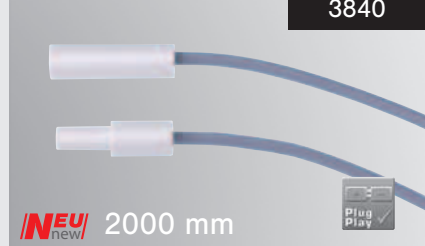

NEU new 2000 mm



Plug & Play Verlängerungskabel 700mA / Plug & Play extension cord 700 mA

Artikel-Nr. article-no.	Preis € price €
3840	4,00

Für 700mA (Reihenschaltung)
Länge: 2000m

for 700mA (series connexion)
length: 2000m

MODULO
ELECTRO
www.modulelectro.ru

3506

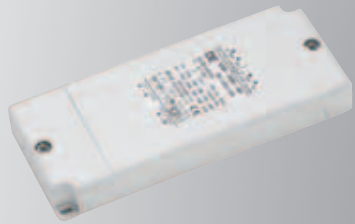

LED-Netzgerät 12V DC/24V DC / LED power supply 12V d.c./24V d.c

Artikel-Nr. article-no.	Preis € price €
3506	41,00

LED – Netzgerät
Kunststoff Gehäuse
prim. 220 – 240 V AC / 50 – 60Hz
sec. Konstanzspannung 12V DC / 1,66A

Leistung: 20W
Schutzart: IP20
Umgebungstemperatur: max. 50°C
Maße: 145 x 55 x 19mm

LED – mains adapter
plastic housing

prim. 220 – 240 Vac / 50 – 60Hz
sec. constant voltage 12 V-d.c. / 1,66A

power: 20W
degree of protection: IP20
ambient temperature: max. 50°C
dimensions: 145x55x19mm

3558V..



LED-Netzgerät 12V DC/24V DC / LED power supply 12V d.c./24V d.c

Artikel-Nr. article-no.	Preis € price €
3558V12	109,00
3558V24	109,00

LED – Netzgerät
Aluminium Gehäuse
prim. 170 – 250 Vac / 50 – 60 Hz
sec. Konstanzspannung

Leistung: 100W
Schutzart: IP66
Umgebungstemperatur: max. 50°C
Leitung: prim.+ sec. 250mm
Maße: 240 x 70 x 44mm

LED – mains adapter
aluminium housing

prim. 170 – 250 Vac / 50 – 60 Hz
sec. constant voltage

power: 100W
degree of protection: IP66
ambient temperature: max. 50°C
connection: prim.+ sec. 250mm
dimensions: 240 x 70 x 44mm

3556V..

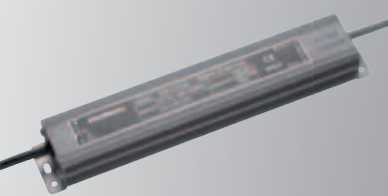

LED-Netzgerät 12V DC/24V DC / LED power supply 12V d.c./24V d.c

Artikel-Nr. article-no.	Preis € price €
3556V12	45,00
3556V24	45,00

3556V12: 12V-DC (2,5A)
3556V24: 24V-DC (1,25A)

LED – Netzgerät
Aluminium Gehäuse
prim. 170 – 250V AC / 50 – 60 Hz
sec. Konstanzspannung

Leistung: 30W
Schutzart: IP66
Umgebungstemperatur: max. 50°C
Leitung: prim.+ sec. 150mm
Maße: 212 x 37 x 27mm

LED – mains adapter
aluminium housing

prim. 170 – 250 Vac / 50 – 60 Hz
sec. constant voltage

power: 30W
degree of protection: IP66
ambient temperature: max. 50°C
connection: prim.+ sec. 150mm
dimensions: 212 x 37 x 27mm

3560

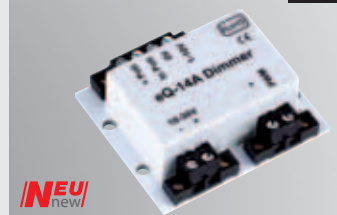

LED-PWM Regelung / LED PWM control

Artikel-Nr. article-no.	Preis € price €
3560	99,00

LED-PWM Schnittstelle
prim. 10-36V
sec. PWM Signal
Ausgangsstrom max. 14A
Steuersignal: 1-10V (aktiv)
Potentiometer Ansteuerung (10k Ohm) für PWM-Regelung

Maße: 55 x 47,5 x 19mm

LED pulse width modulation interface (PWM),
aluminium housing

prim. 10-36V
sec. PWM signal
output current max. 14A
control signal: 1-10V (active)
potentiometer control (10k Ohm) for PWM control

dimensions: 55 x 47,5 x 19mm

3557V..

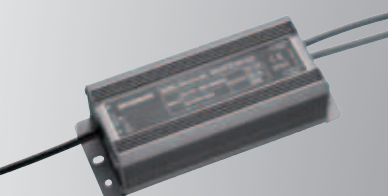

LED-Netzgerät 12V DC/24V DC / LED power supply 12V d.c./24V d.c

Artikel-Nr. article-no.	Preis € price €
3557V12	79,00
3557V24	79,00

3557V12: 12V-DC (5,0A)
3557V24: 24V-DC (2,5A)

LED – Netzgerät
Aluminium Gehäuse
prim. 170 – 250V AC / 50 – 60 Hz
sec. Konstanzspannung

Leistung: 60W
Schutzart: IP66
Umgebungstemperatur: max. 50°C
Leitung: prim.+ sec. 200mm
Maße: 178 x 69 x 44mm

LED – mains adapter
aluminium housing

prim. 170 – 250 Vac / 50 – 60 Hz
sec. constant voltage

power: 60W
degree of protection: IP66
ambient temperature: max. 50°C
connection: prim.+ sec. 200mm
dimensions: 178 x 69 x 44mm

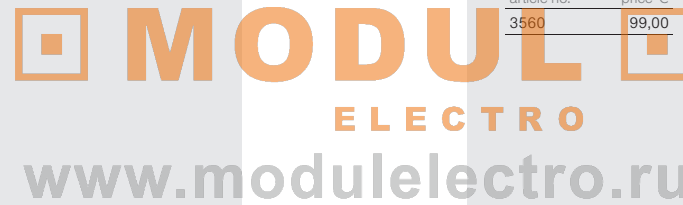
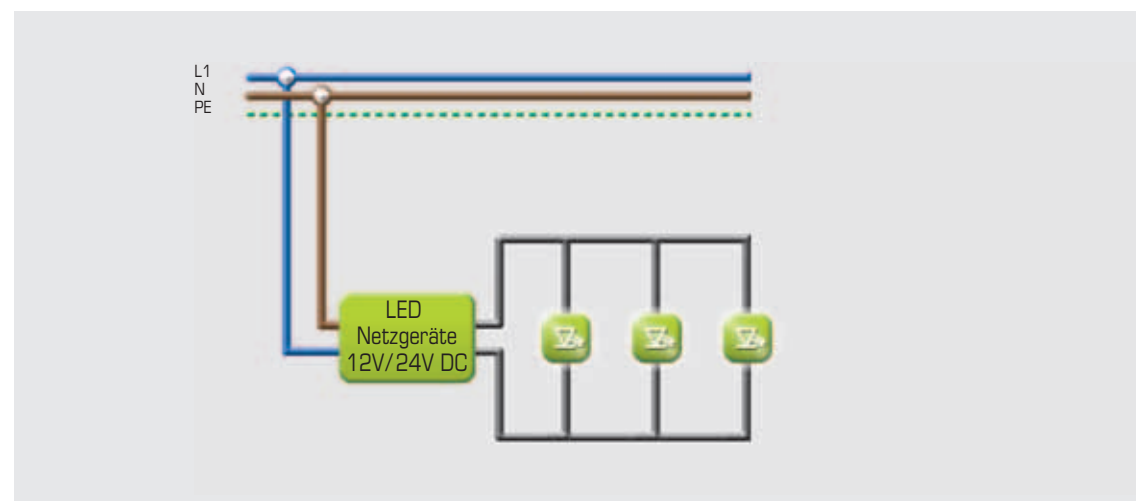

3540



LED-RGB Steuergerät IR 60W / LED-RGB control unit IR 60W

Artikel-Nr. article-no.	Preis € price €
3540	249,00

Eingangs-/Ausgangsspannung:
12V DC 30W / 24V DC 60W
Maße: 95 x 60 x 40mm

LED-Farbsteuergerät mit IR-Fernbedienung über 6 Tasten. Steuerung der Farbwerte von LED-RGB, Einzelfarbsteuerung von rot, grün und blau oder unabhängige Helligkeitssteuerung von drei einfarbigen LEDs. Ein Farbspeicher für eine individuelle Farbe (ab Werk ist die Lichtfarbe weiss gespeichert). Zwei feste Farbsequenzen (weicher / abrupter Übergang) mit Farbdurchlauf aller Lichtfarben. Die Geschwindigkeiten der beiden Farbsequenzen kann eingestellt werden. Versorgung 12V oder 24V DC, LED-Anschlussleistung bei 12V-DC max. 30W bei 24V-DC max. 60W. Die Reichweite der IR-Steuerung liegt bei max. 15m (freie Sicht).

input/output voltage:
12V d.c. 30W/ 24V d.c. 60W

dimensions: 95 x 60 x 40mm

LED-control unit with IR control over 6 switches. Control of colour value of RGB-LED-lights, single-colour control in red, green and blue or independant brightness control of three single-colour LED lights. One memory for individual colour(ex factory colour is white). Two fixed colour sequences (smooth and hard transition) for colour flow. The speed of colour sequences is adjustable. Supply 12V - 24V d.c., maximum LED-power-input 12V-d.c. max. 30W / 24V-d.c. max. 60W., max. 30W. The effective reach of infrared control gear is 15m max. (within eyeshot)



3542



LED-RGB Steuergerät DMX / LED-RGB control unit DMX

Artikel-Nr. article-no.	Preis € price €
3542	229,00

Eingangs-/Ausgangsspannung:
12V DC 30W / 24V DC 60W
Maße: 95 x 60 x 40mm

LED-Farbsteuergerät mit DMX512-Signaleingang. Die Farbsteuerung erfolgt über ein externes DMX512 Steuerpult mit 3-poligem DMX-Ausgang. Versorgung 12V oder 24V DC, LED-Anschlussleistung bei 12V-DC max. 30W bei 24V-DC max. 60W.

input / output voltage:
12V d.c. 30W/ 24V d.c. 60W

dimensions: 95 x 60 x 40mm

LED-control with DMX512-signal input. Colour control carried out by external DMX512 Panel (available on request) with 3-pole DMX output. Supply 12V - 24V d.c., maximum LED-power-input 12V-d.c. max. 30W / 24V-d.c. max. 60W.



www.modulelectro.ru

3541



LED-RGB Steuergerät manuell / LED-RGB manual control unit

Artikel-Nr. article-no.	Preis € price €
3541	198,00

Eingangs-/Ausgangsspannung:
12V DC 30W / 24V DC 60W
Maße: 95 x 60 x 40mm

LED-Farbsteuergerät manuell über 6 Tastern. Steuerung der Farbwerte von LED-RGB, Einzelfarbsteuerung von rot, grün und blau oder unabhängige Helligkeitssteuerung von drei einfarbigen LED. Ein Farbspeicher für eine individuelle Farbe (ab Werk ist die Lichtfarbe weiss gespeichert). Zwei feste Farbsequenzen (weicher / abrupter Übergang) mit Farbdurchlauf aller Lichtfarben. Die Geschwindigkeiten der beiden Farbsequenzen kann eingestellt werden. Versorgung 12V oder 24V DC, maximale LED-Anschlussleistung bei 12V-DC max. 30W bei 24V-DC max. 60W.

input/output voltage:
12V d.c. 30W/ 24V d.c. 60W

dimensions: 95 x 60 x 40mm

LED-control unit with manual control over 6 switches. Control of colour value of RGB-LED-lights, single-colour control in red, green and blue or independant brightness control of three single-colour LED lights. One memory for individual colour(ex factory colour is white). Two fixed colour sequences (smooth and hard transition) for colour flow. The speed of colour sequences is adjustable. Supply 12V - 24V d.c., maximum LED-power-input 12V-d.c. max. 30W / 24V-d.c. max. 60W.

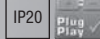

3543



LED-RGB Steuergerät 1-10V / LED-RGB control unit 1-10V

Artikel-Nr. article-no.	Preis € price €
3543	229,00

Eingangs-/Ausgangsspannung:
12V DC 30W / 24V DC 60W
Maße: 95 x 60 x 40mm

LED-Farbsteuergerät mit drei 1-10V Signaleingängen. (rot, grün, blau und Masse) Steuerung der Farbwerte von RGB-LED-Lampen, Einzelfarbsteuerung von rot, grün, blau oder unabhängige Helligkeitssteuerung von drei einfarbigen LED-Lampen. Versorgung 12V oder 24V DC, LED-Anschlussleistung bei 12V-DC max. 30W bei 24V-DC max. 60W.

input / output voltage:
12V d.c. 30W/ 24V d.c. 60W

dimensions: 95 x 60 x 40mm

LED-control unit with three 1-10V signal input (red, green, blue and earth) Control of colour value of RGB-LED-lights, single-colour control in red, green and blue or independant brightness control of three single-colour LED lights. Supply 12V - 24V d.c., maximum LED-power-input 12V-d.c. max. 30W / 24V-d.c. max. 60W.



3534

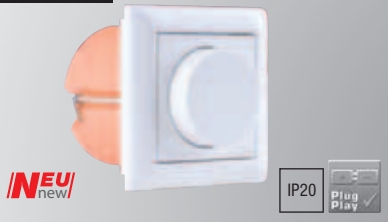

LED-RGB Steuergerät Slave / LED-RGB control unit Slave

Artikel-Nr. article-no.	Preis € price €
3534	259,00

RGB - easy switch multi
Betriebsspannung: 12V / DC (24V / DC)

Funktionsmerkmale:
Intuitiv bedienbare LED-RGB-Steuerung

Ein Tastendruck startet oder stoppt den Farbdurchlauf. Die Geschwindigkeit des Farbdurchlaufs kann über die Drehfunktion des Schalters bestimmt werden. Dieses RGB Steuerungssystem ist kompatibel zu vielen Schalterprogrammen von der Firma Gira.

Das RGB-Steuergerät ist keine Eigenleistungseinheit, es kann nur in Verbindung mit der Art. Nr. 3544 in Betrieb genommen werden. Das Ein- bzw. Ausschalten der RGB-Anlage muss über einen separaten Schalter vor dem Netzteil vorgenommen werden.

RGB – easy switch multi

Operating voltage: 12V / d.c. (24V / d.c.)
Operating features: Intuitive operable LED-RGB control

One push on the button starts or stops the colour sequence. The speed of the colour sequence can be regulated by switch turning. This RGB control system is compatible to a lot of switch ranges of the Gira company. The RGB control unit is no independent unit. It can be operated in connection with Art.-No. 3544, only. The on- and off switching of the RGB system must be done by a separate switch before the power supply unit.

3539



LED-RGB Steuergeräte / LED-RGB control unit

Artikel-Nr. article-no.	Preis € price €
3539	398,00

RGB – Funksteuerung RF
Betriebsspannung: 12V / DC (24V / DC)
Leistung: 30W (60W)

Funktionsmerkmale:
Das Digiled RF erzeugt 3 PWM – Steuersignale zur Farbsteuerung von LED-Modulen. Die drei PWM – Signale werden über ein externes Funk-Bedienfeld und drei vorprogrammierte Programmsequenzen angesteuert. Folgende Funktionen sind abrufbar:
- Unabhängige Steuerung der Helligkeit der Einzelkanäle (RGB)
- Abrufen und Speichern eines individuellen Farbwertes
- Drei verschiedene Farbdurchläufe
- RGB – Farbdurchlauf
- Farbdurchlauf mit warmen Weißtönen
- Farbdurchlauf mit kalten Weißtönen
Veränderung der Farbdurchlaufgeschwindigkeiten

RGB – radio control RF

input / output voltage: 12V / d.c. (24V / d.c.)
power: 30W (60W)

Operation characteristics:
The digiled RF generates 3 PWM-control signals for the colour control of LED-modules. The 3PWM-Signals are activated by an external radio control panel and three pre-programmed program sequences.

The following operations are recallable:
- Independent control of the brightness of the single channels (RGB)
- Recall and storage of an individual colour code
- Three different colour flows:
- RGB colour flow
- colour flow with warm white tones
- Colour flow with cold white tones
- Change of the colour flow velocity

3544



LED-RGB Steuergerät / LED-RGB control unit

Artikel-Nr. article-no.	Preis € price €
3544	149,00

LED-RGB-Steuergerät „Slave“

Eingang-/Ausgangsspannung:
12V DC 30W / 24V DC 60W

Maße: 95 x 60 x 40mm

LED-Farbsteuergerät zur Erhöhung der Systemleistung. Das Signal des „Master“-gerätes wird am RGB-Eingang angeschlossen. Der Ausgang kann dann mit einer zusätzlichen 12V DC oder 24V DC LED-Anschlussleistung belegt werden. Es erfolgt eine synchrone Farbsteuerung.

Kompatibel zu allen, oben aufgeführten LED-Steuergeräten; LED-RGB-infrarot oder manuell, DMX oder 1-10V.

LED-RGB-control unit „Slave“

input / output voltage:
12V d.c. 30W / 24V d.c. 60W

dimensions: 95 x 60 x 40mm

LED colour control unit to increase the system rating. LED-RGB-infrared, manuell, DMX and 1-10V. The signal of the master unit is applied to the RGB-input. The output can be applied by an additional 12V DC or 24V d.c. LED-connection cable. The result is a synchronal colour flow.

Compatible to all, above mentioned LED-control units. LED-RGB infrared or manual, DMX or 1-10V.

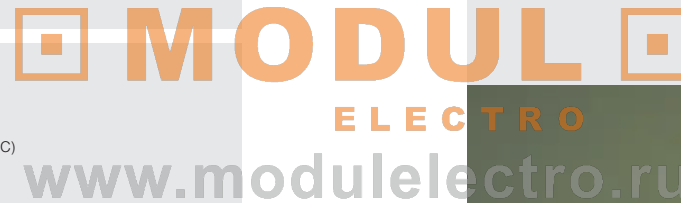

LED Competence Center, Brumberg

LED Competence Center, Brumberg



MODUL
ELECTRO
www.modulelectro.ru

LED-RGB Steuergerät / LED-RGB control unit

Artikel-Nr. article-no.	Preis € price €
3535	59,00

Eingangsspannung /
Leistung:
Input voltage/power:
12V/DC – 30W
24V/DC – 60W

Maße / dimensions:
90 x 30 x 19 mm

zur Farbverlaufs-Steuerung / **gemeinsame Katode**

Dieses Steuergerät dient zur vorprogrammierten Farbverlaufssteuerung von LED-Modulen. Master-Slave-Betrieb mit 3544 möglich.

Das Steuergerät erzeugt 3 PWM-Steuersignale zur Farbsteuerung von LED-Modulen. Die 3 PWM-Signale werden über einen extern anzuschließenden Taster und einer vorprogrammierten Programmsequenz angesteuert.

Folgende Funktionen sind einstellbar:

- Abrufen von einem Farbdurchlauf mit drei unterschiedlich einstellbaren Farbdurchlaufgeschwindigkeiten
- Abrufen und Speichern eines Farbwertes des Farbdurchlaufs

Bei Unterbrechung und Wiederkehr der Versorgungsspannung startet das Steuergerät mit der zuletzt eingestellten Funktion (Farbdurchlauf oder eingestelltem Farbwert).

For colour flow control / **common katode**

This control unit is to be used for pre-programmed colour flow control of LED modules. Master-slave operation with 3544 is possible.

The control unit produces 3 PWM control signals for colour control of LED modules. The 3 PWM signals are controlled by an externally connected push-button and a pre-programmed program sequence.

The following functions can be selected:

- recall of a colour flow with three, different and variable speeds in colour flow
- colour tone recall and storage of a colour flow

If an interruption and re-start of the supply voltage effects, the control unit starts with the lastly selected function (colour flow or selected colour tone).



3535

IP20

LED-RGB Steuergerät / LED-RGB control unit

Artikel-Nr. article-no.	Preis € price €
3535CA	59,00

Eingangsspannung /
Leistung:
Input voltage/power:
12V/DC – 30W
24V/DC – 60W

Maße / dimensions:
90 x 30 x 19 mm

zur Farbverlaufs-Steuerung / **gemeinsame Anode**

Dieses Steuergerät dient zur vorprogrammierten Farbverlaufssteuerung von LED-Modulen. Master-Slave-Betrieb mit 3544 möglich.

Das Steuergerät erzeugt 3 PWM-Steuersignale zur Farbsteuerung von LED-Modulen. Die 3 PWM-Signale werden über einen extern anzuschließenden Taster und einer vorprogrammierten Programmsequenz angesteuert.

Folgende Funktionen sind einstellbar:

- Abrufen von einem Farbdurchlauf mit drei unterschiedlich einstellbaren Farbdurchlaufgeschwindigkeiten
- Abrufen und Speichern eines Farbwertes des Farbdurchlaufs

Bei Unterbrechung und Wiederkehr der Versorgungsspannung startet das Steuergerät mit der zuletzt eingestellten Funktion (Farbdurchlauf oder eingestelltem Farbwert).

For colour flow control / **common anode**

This control unit is to be used for pre-programmed colour flow control of LED modules. Master-slave operation with 3544 is possible.

The control unit produces 3 PWM control signals for colour control of LED modules. The 3 PWM signals are controlled by an externally connected push-button and a pre-programmed program sequence.

The following functions can be selected:

- recall of a colour flow with three, different and variable speeds in colour flow
- colour tone recall and storage of a colour flow

If an interruption and re-start of the supply voltage effects, the control unit starts with the lastly selected function (colour flow or selected colour tone).



3535CA

IP20

Für Artikel 3381RGB und 3383RGB (Seite 194/195). Weitere Steuerungen für gemeinsame Anode auf Anfrage. For Art.-No. 3381RGB and 3383RGB (page 194/195) More control units for common anode on request.

3545

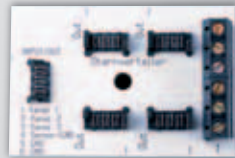

LED-RGB-Sternverteiler / LED-RGB splitter

Artikel-Nr. article-no.	Preis € price €
3545	24,00

Für Eingangs-/Ausgangsspannungen: von 12V - 24V DC
Maße: 60 x 40 x 15mm

LED-RGB-Verteiler zum Anschluss mehrerer LEDs und zur Signalweiterführung zum LED-RGB-"Slave"-Modul.

1x Eingang über Systemstecker, 4x Ausgang über Systemstecker, 1x Ausgang über Klemmleiste.

For input / output voltage of 12V - 24V d.c.
dimensions: 60 x 40x 15mm

LED-RGB-distributor to connect several RDG-LED-lights to carry the signal to the LED-RGB-slave-modul.

1x Input and 4x output via system plug, 1x output via terminal block.

3830

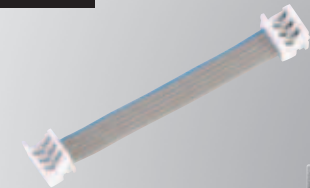

RGB-Verlängerung / RGB-extension

Artikel-Nr. article-no.	Preis € price €
3830	5,90

RGB-Verlängerung

Länge = 60 mm
inkl. beidseitigem Stecker

6-adrige RGB-Verlängerung zur Verbindung der Steuerung „Master / Slave“ mit dem Kreuzverteiler 3545

RGB-extension

length = 60 mm
incl. two-sided plug

6-wire RGB-extension to connect the controls „Master/Slave“ with the splitter 3545

3831/3832



RGB-Verlängerung / RGB-extension

Artikel-Nr. article-no.	Preis € price €
3831	8,90
3832	10,90

6-adrige RGB-Verlängerung zur Signalweiterführung zwischen Master- und Slave - Steuerungen.

3831
RGB-Verlängerung
Länge = 1.000 mm inkl. beidseitigem Stecker

3832
RGB-Verlängerung
Länge = 2.000 mm inkl. beidseitigem Stecker

6-wire RGB-extension to perpetuate the signal between the Master and Slave controls.

3831 RGB-extension
length = 1.000 mm incl. two-sided plug

3832 RGB-extension
length = 2.000 mm incl. two-sided plug

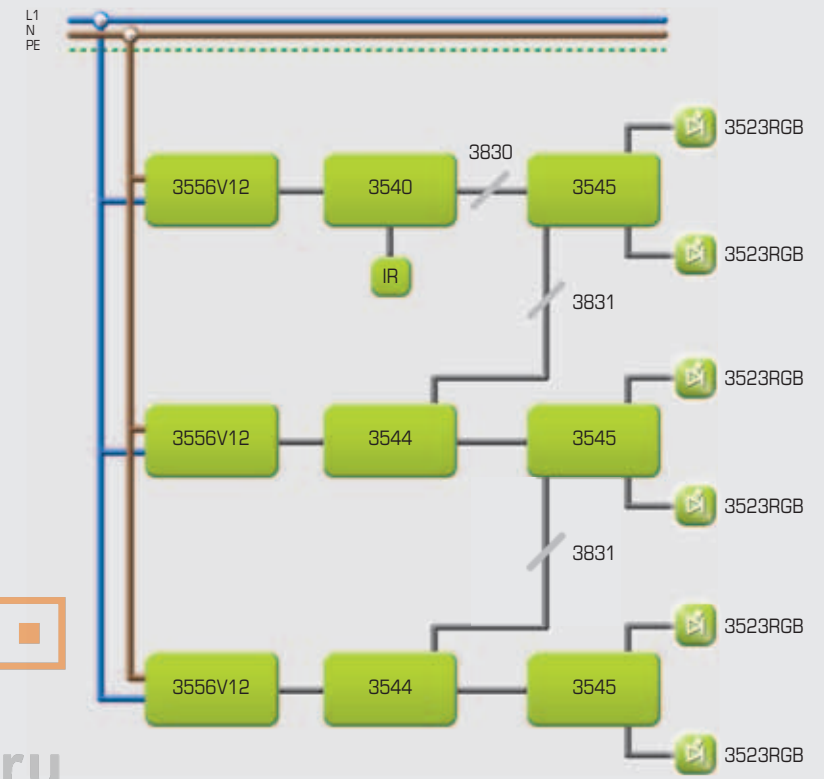

Wichtig!
Die maximale Leitungslänge zwischen Steuerung und Verbraucher darf 5 Meter nicht überschreiten.
Die maximale Leitungslänge zwischen Master-Steuerung und Slave-Erweiterung darf 10 Meter nicht überschreiten.



Attention!
The maximum cable length between control unit and consumer load has not to exceed 5 meters.
The maximum cable length Master control and Slave-extension has not to exceed 10 meters.

System mit 12 V
Die Steuerungen (Master/Slave) können maximal mit 30W belastet werden.

System mit 12 V
The controls (Master/Slave) can be loaded with max. 30W.

System mit 24 V
Die Steuerungen (Master/Slave) können maximal mit 60W belastet werden.

System mit 24 V
The controls (Master/Slave) can be loaded with max. 60W.

Bei Überschreitung dieser maximalen Last können die Systeme mit einem Slavemodul (Art. 3544) beliebig erweitert werden. (12V / 30W - 24V / 60W)

The systems can be extended optionally by a slave modul (3544) on request (12V/30W - 24V/60W).

Die Steuerung Art. 3540 kann auch ersetzt werden durch eine Manuelle, DMX, DALI, RF oder 1-10V Steuerung.

The controller 3540 can be replaced by a manual, DMX, DALI, RF or 1-10V control.

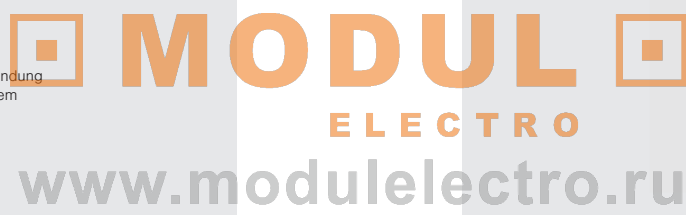

54211



Elektronischer Transformator 35-105VA / Electronic transformer 35-105VA

Artikel-Nr. article-no.	Preis € price €
54211	24,30

ELEKTRONISCHER RUNDTRANSFORMATOR

- Elektronischer Transformator IP20
- Dimmbar mit Phasenabschnittsdimmer
- unabhängiger Transformator
- zur Installation auf Holz zugelassen
- Transformator mit Leitung auf Primär und Sekundärseite
- Schutz gegen Kurzschluß / Überlastung / Überhitzung
- Funkentstörung nach EN 61000-3-3
- Oberwellenunterdrückung nach EN 61000-3-2
- Softstart

Gemäß den einschlägigen Sicherheitsbestimmungen müssen in abgehängten Decken, Rosetten, Abdeckungen usw. elektronische Transformatoren für unabhängigen Einsatz installiert werden.

Angesichts der durch diese Art der Installation vorgegebenen Bedingungen sollten diese elektronischen Transformatoren so klein wie möglich sein, so dass sie problemlos eingesetzt werden können. BRUMBERG bietet mit der Baureihe 54211 kompakte und für diese Art des Einsatzes bestens geeignete elektronische Transformatoren an.

ROUND ELECTRONIC TRANSFORMER

- electronic transformer IP20
- dimmable by trailing-edge phase dimmer
- independent transformer
- allowed for installation on wood
- transformer with cable on both primary and secondary side
- protection against short circuit / overstress / overheating
- radio shielding according to EN 61000-3-3
- suppression of harmonic content in accordance to EN 61000-3-2
- soft start

According to corresponding safety regulations, electronic transformers used in suspended ceilings, rosettes, covers, etc. must be installed in independent application.

In view of these requirements electronic transformers should be as small as possible to enable a trouble-free installation. With the lines 54211 BRUMBERG offers compact and for these purposes appropriate transformer.

Artikel-Nr. article-no.	VA	230V primär 230V primary	12V sekundär 12V secondary	Maße (mm) dimensions (mm)
54211	35-105	1x Eingang / input	1x Ausgang / output	D 70 x H 24

Schutzklasse II / protection class II

542..

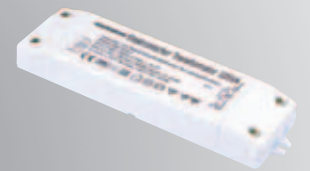

Elektronischer Transformator / Electronic transformer

Artikel-Nr. article-no.	Preis € price €
54261	19,70
54271	22,00
54281	30,20

ELEKTRONISCHER TRANSFORMATOR

- Elektronischer Transformator IP20
- Dimmbar mit Phasenabschnittsdimmer
- unabhängiger Transformator
- zur Installation auf Holz zugelassen
- Schutz gegen Kurzschluß / Überlastung / Überhitzung
- Funkentstörung nach EN 61000-3-3
- Oberwellenunterdrückung nach EN 61000-3-2
- Softstart

Gemäß den einschlägigen Sicherheitsbestimmungen müssen in abgehängten Decken, Rosetten, Abdeckungen usw. elektronische Transformatoren für unabhängigen Einsatz installiert werden.

Angesichts der durch diese Art der Installation vorgegebenen Bedingungen sollten diese elektronischen Transformatoren so klein wie möglich sein, so dass sie problemlos eingesetzt werden können. BRUMBERG bietet mit der Baureihe 54211 kompakte und für diese Art des Einsatzes bestens geeignete elektronische Transformatoren an.

ELECTRONIC TRANSFORMER

- electronic transformer IP20
- dimmable by trailing-edge phase dimmer
- independent transformer
- allowed for installation on wood
- protection against short circuit / overstress / overheating
- radio shielding according to EN 61000-3-3
- suppression of harmonic content in accordance to EN 61000-3-2
- soft start

According to corresponding safety regulations, electronic transformers used in suspended ceilings, rosettes, covers, etc. must be installed in independent application.

In view of these requirements electronic transformers should be as small as possible to enable a trouble-free installation. With the lines 54211 BRUMBERG offers compact and for these purposes appropriate transformer.

Artikel-Nr. article-no.	VA	230V primär 230V primary	12V sekundär 12V secondary	Maße (mm) dimensions (mm)
54261	20-80	1x Eingang / input	1x Ausgang /output	L 159 x B 41 x H 28,0
54271	35-105	1x Eingang / input	2x Ausgang /output	L 159 x B 41 x H 19,5
54281	50-150	1x Eingang / input	2x Ausgang /output	L 150 x B 40 x H 30,0

Schutzklasse II / protection class II

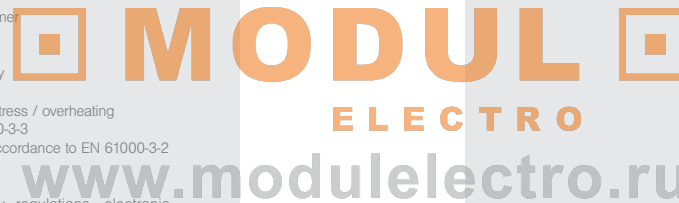
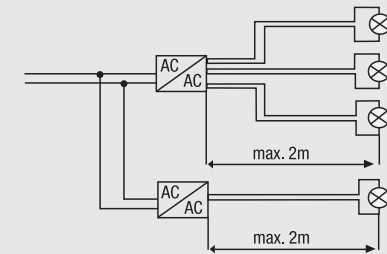

54291

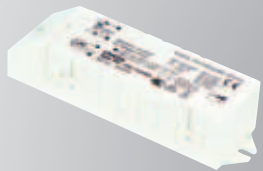

Anschlussleitung sekundärseitig bis 7m!
Connection secondary up to 7m!

Elektronischer Transformator 20-105VA / Electronic transformer 20-105VA

Artikel-Nr. article-no.	Preis € price €
54291	33,60

ELEKTRONISCHER TRANSFORMATOR

- Elektronischer Transformator IP20
- Dimmbar mit Phasen- Phasenabschnittsdimmer
- unabhängiger Transformator
- Schutz gegen Kurzschluß / Überlastung / Überhitzung
- Oberwellenunterdrückung nach EN 61000-3-2
- wärmebeständiges Polyamid
- Netzfrequenz 50-60Hz
- Anschluss Primär: Schraubklemmen 1 x 2-polig primärseitig 2,5mm²
- Anschluss Sekundär: Schraubklemmen 1 x 2-polig sekundärseitig 2,5mm²
- Anschlussleitung Sekundärseitig bis 7m

Gemäß den einschlägigen Sicherheitsbestimmungen müssen in abgehängten Decken, Rosetten, Abdeckungen usw. elektronische Transformatoren für unabhängigen Einsatz installiert werden.

Angesichts der durch diese Art der Installation vorgegebenen Bedingungen sollten diese elektronischen Transformatoren so klein wie möglich sein, so dass sie problemlos eingesetzt werden können. BRUMBERG bietet mit der Baureihe 54211 kompakte und für diese Art des Einsatzes bestens geeignete elektronische Transformatoren an.

ELECTRONIC TRANSFORMER

- electronic transformer IP20
- dimmable by trailing-edge phase dimmer
- independent transformer
- protection against short circuit / overstress / overheating
- suppression of harmonic content in accordance to EN 61000-3-2
- heat-resistant polyamide
- mains frequency 50 - 60 Hz
- connection primary side: Screw terminals 1 x 2-poles primary, 2,5mm²
- connection secondary side: Screw terminals 1 x 2-poles secondary, 2,5mm²
- connecting cable secondary up to 7m

According to corresponding safety regulations, electronic transformers used in suspended ceilings, rosettes, covers, etc. must be installed in independent application.

In view of these requirements electronic transformers should be as small as possible to enable a trouble-free installation. With the lines 54211 BRUMBERG offers compact and for these purposes appropriate transformer.

Artikel-Nr. article-no.	VA	Nennspannung nominal voltage	Nennstrom nominal current	Maße (mm) dimensions (mm)
54291	20-105	230V-240V	0,435A-0,445A	L 128 x B 37 x H 28

Schutzklasse II / protection class II

Produktionsgebäude Fa. Mennekes, Kirchlindern



MODUL
ELECTRO
www.modulelectro.ru



MODUL
ELECTRO
www.modulelectro.ru

Elektronisches Vorschaltgerät CDM-TM / Electronic ballast CDM-TM

Artikel-Nr. article-no.	Preis € price €
53035	102,50

Für die Artikel
512751 / 522226 / 512701

Maße: 190mm x 45mm x 35mm
Leistung Leuchtmitel max. 20W

for articles
512751 / 522226 / 512701

dimensions: 190mm x 45mm x 35mm
lamp power max. 20W



53035



Elektronisches Vorschaltgerät CDM-TM / Electronic ballast CDM-TM

Artikel-Nr. article-no.	Preis € price €
53040	102,50

Für die Artikel
512751 / 522226 / 512701

Maße: 230mm x 50mm x 35mm
Leistung Leuchtmitel max. 35W

Electronic ballast for CDM-Tm 35W

for articles
512751 / 522226 / 512701

dimensions: 230mm x 50mm x 35mm
lamp power max. 35W

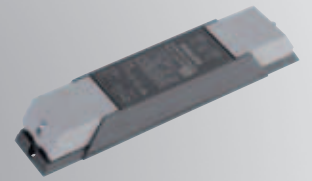

53040



536600
536400

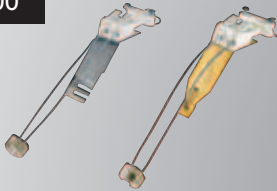

NV-Bügel für Einbaustrahler / clamp for low-voltage spots

Artikel-Nr. article-no.	Preis € price €
536600	3,25
536400	3,25

- Bügel für NV-Einbaustrahler zum Nachrüsten
- 536600 = mit 2-poliger Steckklemme 2 x 2,5 mm und Zugentlastung, Federbefestigung
- 536400 = mit 2-poliger Steckklemme 2 x 2,5 mm und Zugentlastung, Steckbefestigung

**NIEDERVOLT
LOW VOLTAGE**

- Clamp for low-voltage spots to refit.
- 536600 = 2-pole clamp 2 x 2,5 mm strain relief, clip fastening
- 536400 = 2-pole clamp 2 x 2,5 mm strain relief, plug- and socket device

534800
536800

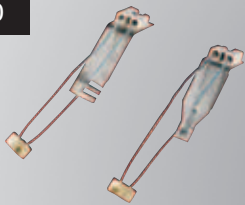

NV-Bügel für Einbaustrahler / clamp for low-voltage spots

Artikel-Nr. article-no.	Preis € price €
534800	4,50
536800	4,50

- Bügel für NV-Einbaustrahler zum Nachrüsten
- 534800 = mit Wieland Stecksystem ST 16, Federbefestigung
- 536800 = mit Wieland Stecksystem ST 16, Stecksystem

**NIEDERVOLT
LOW VOLTAGE**

- Clamp for low-voltage spots to refit.
- 534800 = with Wieland plug-and-socket device ST 16, clip fastening
- 536800 = with Wieland plug-and-socket device ST 16, plug- and socket device

535800

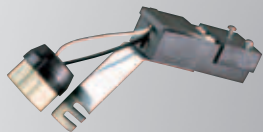

NV-Bügel für Einbaustrahler / clamp for high-voltage spots

Artikel-Nr. article-no.	Preis € price €
535800	9,50

- Bügel für Einbaustrahler zum Nachrüsten mit Hochvolt-Fassung GZ10 und beidseitiger Zugentlastung

**HOCHVOLT
HIGH VOLTAGE**

- Federbefestigung
- Clamp for low-voltage spots to refit with High-voltage sockets GZ10 and strain relief on both sides.
- clip fastening

535900



NV-Bügel für Einbaustrahler / clamp for high-voltage spots

Artikel-Nr. article-no.	Preis € price €
535900	9,50

- Bügel für Einbaustrahler zum Nachrüsten mit Hochvolt-Fassung GZ10 und beidseitiger Zugentlastung

**HOCHVOLT
HIGH VOLTAGE**

- Stecksystem
- Clamp for low-voltage spots to refit with High-voltage sockets GZ10 and strain relief on both sides
- plug- in system

Übertopf für Einbaustrahler / Box for recessed spots

Artikel-Nr. article-no.	Preis € price €
535200	16,30
535300	17,10
535400	17,60
536300	17,00

- Übertopf
- 535200 = H 100 - Ø 55 Innen - DA 58
535300 = H 100 - Ø 60 Innen - DA 63
535400 = H 100 - Ø 68 Innen - DA 71
536300 = H 100 - Ø 70 Innen - DA 73

Mechanischer Schutz der Leuchte
nicht wärmedämmend

box

- 535200 = H 100 - Ø 55 inside - cut-out 58 mm
535300 = H 100 - Ø 60 inside - cut-out 63 mm
535400 = H 100 - Ø 68 inside - cut-out 71 mm
536300 = H 100 - Ø 70 inside - cut-out 73 mm

Mechanical protection of the luminaire not

535...
536300



Einputztopf für Einbaustrahler / Pattress box for recessed spots

Artikel-Nr. article-no.	Preis € price €
531200	30,70
531300	29,40
531400	28,30

- 531200 - für Leuchten bis Deckenausschnitt 45 mm.
531300 - für Leuchten bis Deckenausschnitt 63 mm.
531400 - für Leuchten bis Deckenausschnitt 76 mm.

Wichtiger Hinweis

- 531200 - 531400 = nicht verwendbar in Verbindung mit Bügel Artikel 535800 und 536600
- nur für NV-Leuchten
- nicht für den gleichzeitigen Einbau von Transformatoren geeignet

- 531200 - for luminaires with cut-out up to 45 mm.
531300 - for luminaires with cut-out up to 63 mm.
531400 - for luminaires with cut-out up to 76 mm.

Important note:

- 531200 - 531400 = please do not use in connection with clamp, Art.-No. 5358 and 5366

- for low-voltage spots only
- not for common fit-in of spot and transformer

531...

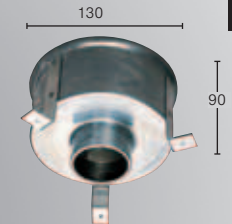

MODUL
ELECTRO
www.modulelectro.ru



534600
534700



Sprengringe für Einbaustrahler / circlips for recessed spots

Artikel-Nr. article-no.	Preis € price €
534600	0,80
534700	0,80

SPERRINGE
534600=GZ4 / 35mm
534700=GX5,3 / 51mm

Bitte bei Bestellungen die Artikel-Nr. der Leuchte angeben.

CIRCLIPS

534600 = GZ4 / 35mm
534700 = GX5,3 / 51mm

In orders please specify item number of luminaire.

532500
532600

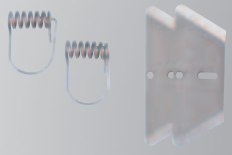

**Feder-Nachrüstätze für Einbaustrahler
springs for recessed spots to refit**

Artikel-Nr. article-no.	Preis € price €
532500	1,00
532600	3,90

Einbaufedern für Kaiser-Einputztöpfe
(auf Anfrage für verschiedene Strahler möglich)

532500 = kurze Feder
532600 = Blattfeder

springs for „Kaiser“ pattresses (for different spots on request)

532500 = short spring
532600 = flat spring

530...

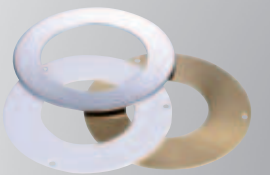

Reduzierringe für Einbaustrahler / reduction rings for recessed spots

REDUZIERRINGE für Einbaustrahler

5301_+ = Ø 65,0 Außen - Ø Innen bis max. 47mm
5302_+ = Ø 80,6 Außen - Ø Innen bis max. 63mm
5303_+ = Ø 98,2 Außen - Ø Innen bis max. 80mm
5304_+ = Ø 122,7 Außen - Ø Innen bis max. 106mm
5305_+ = Ø 150,0 Außen - Ø Innen bis max. 129mm
5306_+ = Ø 195,0 Außen - Ø Innen bis max. 170mm

reduction rings for recessed spots

5301_+ = Ø 65,0 outside - Ø inside up to max. 47mm
5302_+ = Ø 80,6 outside - Ø inside up to max. 63mm
5303_+ = Ø 98,2 outside - Ø inside up to max. 80mm
5304_+ = Ø 122,7 outside - Ø inside up to max. 106mm
5305_+ = Ø 150,0 outside - Ø inside up to max. 129mm
5306_+ = Ø 195,0 outside - Ø inside up to max. 170mm

Bei Bestellungen bitte immer mit angeben:

- ob die Reduzierringe „mit“ oder „ohne“ Bohrer für Senkkopf schrauben (nicht im Lieferumfang enthalten) benötigt werden
- den Durchmesser der Mittelbohrung

In orders please specify:

- whether or not drilling holes are needed.
- the diameter of the central core

Artikel-Nr. article-no.	Preis € price €	Artikel-Nr. article-no.	Preis € price €
530100	27,50	530400	46,70
530102	28,80	530402	47,20
530107	23,70	530407	41,10
530122	30,00	530422	52,50
530200	29,40	530500	52,40
530202	31,00	530502	58,00
530207	24,90	530507	45,80
530222	32,60	530522	57,20
530300	31,40	530600	58,40
530302	33,20	530602	66,60
530307	27,20	530607	49,60
530322	35,00	530622	62,50

Niederdruck Metallreflektor / low pressure metal reflector

Artikel-Nr. article-no.	Preis € price €
532000	5,70
532100	4,90

Mit dem als Zubehör lieferbaren Metallreflektor wird einerseits erreicht, dass Streuwärme gezielt und gerichtet raumseitig abgegeben wird. Empfindliche Deckenkomponenten werden damit geschont. Andererseits entfallen beim Lampenersatz die höheren Kosten für Leuchtmittel mit serienmäßig angebaute Lampenreflektor.

Innerhalb einer Beleuchtungsanlage wird eine homogene Optik erreicht - auch wenn QT9/QT12-Leuchtmittel und gleichzeitig Kaltlichtreflektorlampen zum Einsatz kommen

With the accessory metal reflector heat dissipation inside the room will be achieved on the one hand. For this reason sensitive ceiling components will be saved.

On the other hand the higher costs for replacement of lights with standard attached light reflector will be omitted.

Within a lighting system a homogenous optic will be achieved even if QT9/QT12 lamps and dichroic cool-ray lamps will be applied contemporaneous.

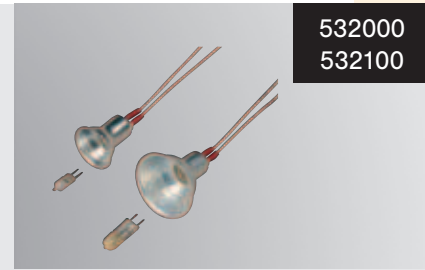

532000
532100

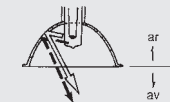

532000 = 51mm, Winkel 90°
532100 = 35mm, Winkel 130°
532000 = 51mm, angle 90°
532100 = 35mm, angle 130°

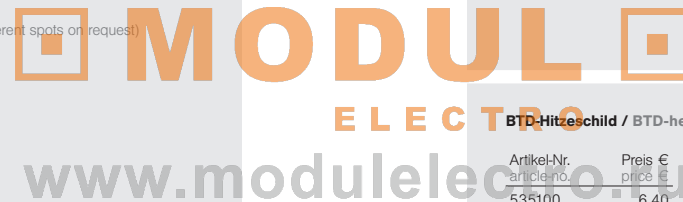

BTD-Hitzeschild / BTD-heat shield

Artikel-Nr. article-no.	Preis € price €
535100	6,40

Kaltlichtreflektor + BTD

Mit dem BTD-Hitzeschild wird die deckenseitige Wärmestrahlung um ca. 30-40% reduziert und raumseitig sanft in die Atmosphäre abgegeben - bei unveränderter Steigung der Temperatur der Lichtstrahlung.

Das BTD-System vereint die Vorteile der Kaltlichtreflektorlampe (weniger Hitze raumseitig) mit den Vorteilen eines Metallreflektors (weniger Hitze deckenseitig). Das Farbspektrum des Lichtes bleibt dabei unverändert.

Wichtig: Vor Montage muss der Innenschutzfilm vom BTD abgenommen werden.

BTD- thermal protection shield

With the BTD-thermal protection shield the heat radiation is reduced by 30 to 40% on the side of ceiling and softly released into the atmosphere inside the room - the increase of temperature of the light radiation remains unchanged.

The BTD - system combines the advantages of the dichroic cool-ray lamp (less heat inside the room) with those of the metal reflector (less heat on the side of ceiling). The light spectrum remains unchanged.



535100

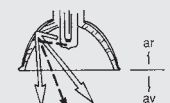

535100 - 51 mm

54510

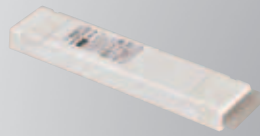

AMP Trafo / AMP transformer

Artikel-Nr. article-no.	Preis € price €
54510	78,50

Elektronischer Trafo mit integriertem
AMP-Verteiler 6-fach 20-120 VA

1x Eingang - 6x Ausgang
L 186mm x B 45mm x H19mm

Electronic transformer with AMP-distributor
art. 5451 = 20-120VA

1x input - 6x output
L 186mm x B 45mm x H19mm

NIEDERVOLT
LOW VOLTAGE

536000
536100

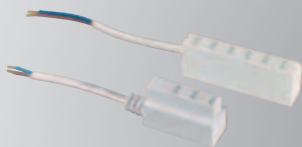

AMP Verteiler / AMP distributor

Artikel-Nr. article-no.	Preis € price €
536000	8,60
536100	10,00

AMP-Verteiler 3-fach = Art. 536000
AMP-Verteiler 6-fach = Art. 536100

AMP-distributor 3x = Art. 536000
AMP-distributor 6x = Art. 536100

NIEDERVOLT
LOW VOLTAGE

536200
536500

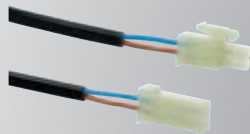

AMP Leitung / AMP connexion

Artikel-Nr. article-no.	Preis € price €
536200	4,00
536500	6,30

AMP-Leitung mit Stecker und Kupplung
Länge 1m = Art. 536200
Länge 2m = Art. 536500

AMP-connection with plug and coupling

length 1m = Art. 536200
length 2m = Art. 536500

NIEDERVOLT
LOW VOLTAGE

Anwendungsbeispiel einer komplett verdrahteten Einheit
example of completely wired unit

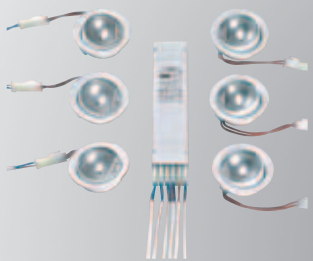

MODUL
ELECTRO

www.modulelectro.ru

AMP Einspeisungsleitung / AMP feeding cable

Artikel-Nr. article-no.	Preis € price €
537400	6,20

AMP-HV-Einspeisungsleitung inkl. Anschlussbox
Länge 0,3m

AMP-HV-feeding cable incl. junction box
length 0,3m

HOCHVOLT
HIGH VOLTAGE

537400



AMP Verlängerung / AMP extension cable

Artikel-Nr. article-no.	Preis € price €
537300	6,40

AMP-HV-Leitung mit Stecker und Kupplung
Länge 2,0m

AMP-HV-extension with plug and coupling
length 2m

HOCHVOLT
HIGH VOLTAGE

537300



Niedervolt-Halogen Stiftsockellampen QT9/QT12
Low-voltage halogen pin-type lamp QT9/QT12

Artikel-Nr. article-no.	Bezeichnung marking	Leistung W power W	Sockel socket	Preis € price €
50100	QT9	5W	G4	2,30
50101	QT9	10W	G4	1,60
50102	QT9	20W	G4	1,60
50103	QT12	20W	GY6,35	2,40
50104	QT12	35W	GY6,35	1,60
50105	QT12	50W	GY6,35	1,60



Niedervolt-Halogen Reflektorlampen QR-CBC35 Ø 35x37mm
Reflector-type lamp QR-CBC35 Ø 35x37mm

Artikel-Nr. article-no.	Bezeichnung marking	Leistung W power W	Sockel socket	Preis € price €
50000	QR-CBC35/38°	10W	GU4/GZ4	3,70
50001	QR-CBC35/10°	20W	GU4/GZ4	3,70
50002	QR-CBC35/38°	20W	GU4/GZ4	3,70
50003	QR-CBC35/10°	35W	GU4/GZ4	3,70
50004	QR-CBC35/38°	35W	GU4/GZ4	3,70



Niedervolt-Halogen Reflektorlampen QR-CBC51 Ø 51x45mm
Reflector-type lamp QR-CBC51 Ø 51x45mm

Artikel-Nr. article-no.	Bezeichnung marking	Leistung W power W	Sockel socket	Preis € price €
50038	QR-CBC51/10°	20W	GU5,3/GX5,3	2,90
50039	QR-CBC51/38°	20W	GU5,3/GX5,3	2,90
50040	QR-CBC51/10°	35W	GU5,3/GX5,3	2,90
50041	QR-CBC51/38°	35W	GU5,3/GX5,3	2,90
50042	QR-CBC51/10°	50W	GU5,3/GX5,3	3,50
50043	QR-CBC51/38°	50W	GU5,3/GX5,3	2,90



Niedervolt-Halogen Reflektorlampen Ø 111mm
Reflector-type lamp Ø 111mm

Artikel-Nr. article-no.	Bezeichnung marking	Leistung W power W	Sockel socket	Preis € price €
50051	QR-LP111/24°	35W	GU53	11,50
50054	QR-LP111/24°	50W	GU53	11,70
50056	QR-LP111/24°	75W	GU53	13,70
50057	QR-LP111/45°	75W	GU53	13,70
50059	QR-LP111/24°	100W	GU53	13,70
50060	QR-LP111/45°	100W	GU53	13,70



Hochvolt-Halogen Glühlampen 230V
High-voltage halogen incandescent lamps 230V

Artikel-Nr. article-no.	Bezeichnung marking	Leistung W power W	Sockel socket	Preis € price €
50151	QT-DE12	100W	R7s/74,9	7,50
50153	QT-DE12	150W	R7s/114,2	5,10
50180	QT14	25W	G9	5,80
50181	QT14	40W	G9	5,80



Hochvolt-Halogen Reflektorlampen
High-voltage halogen reflector-type lamps

Artikel-Nr. article-no.	Bezeichnung marking	Leistung W power W	Sockel socket	Preis € price €
50309	QPAR51-25°	35W	GU10	3,10
50311	QPAR51-25°	50W	GU10	3,10
50312	QPAR51-50°	50W	GU10	3,10
50313	QPAR51-25°	50W	GZ10	7,70
50332	QPAR64-50°	75W	GU10	10,20
50045	QR-LP111/24°	75W	GU10	40,20



MODUL
ELECTRO
www.modulelectro.ru

Hochvolt-Halogen Reflektorlampen QPAR
High-voltage halogen reflector-type lamps QPAR

Artikel-Nr. article-no.	Bezeichnung marking	Leistung W power W	Sockel socket	Preis € price €
50351	QPAR16-50°	40W	E14	10,20
50361	QPAR20-25°	50W	E27	10,20
50373	QPAR25-25°	50W	E27	11,90
50381	QPAR30-30°	75W	E27	13,40



MasterColour CDM-Tm
MasterColour CDM-Tm

Artikel-Nr. article-no.	Bezeichnung marking	Leistung W power W	Sockel socket	Preis € price €
50155	CDM-Tm	20W	PGj5	70,10
50156	CDM-Tm	35W	PGj5	70,10



Kompaktleuchtstofflampen TC-D und TC-DEL
Compact fluorescent lamps TC-D und TC-DEL

Artikel-Nr. article-no.	Bezeichnung marking	Leistung W power W	Socket socket	Preis € price €
50543	TC-D 21-840	13W	G24d-1	7,80
50545	TC-D 21-840	18W	G24d-2	7,80
50547	TC-D 21-840	26W	G24d-3	7,80
<hr/>				
50573	TC-DEL 21-840	13W	G24q-1	7,80
50575	TC-DEL 21-840	18W	G24q-2	7,80
50577	TC-DEL 21-840	26W	G24q-3	7,80



Kompaktleuchtstofflampen TC-T und TC-TEL
Compact fluorescent lamps TC-T und TC-TEL

Artikel-Nr. article-no.	Bezeichnung marking	Leistung W power W	Socket socket	Preis € price €
50553	TC-T 21-840	13W	GX24d-1	11,90
50555	TC-T 21-840	18W	GX24d-2	11,90
50557	TC-T 21-840	26W	GX24d-3	11,90
<hr/>				
50583	TC-TEL 21-840	13W	GX24q-1	10,50
50585	TC-TEL 21-840	18W	GX24q-2	10,50
50587	TC-TEL 21-840	26W	GX24q-3	10,50
50588	TC-TEL 21-840	32W	GX24q-3	10,50
50589	TC-TEL 21-840	42W	GX24q-4	10,50



Kompaktleuchtstofflampen Megaman
Compact fluorescent lamps Megaman

MEGAMAN®
EnergieSparLampen

Artikel-Nr. article-no.	Bezeichnung marking	Leistung W power W	Socket socket	Preis € price €
50335	Megaman 7W	7W	GZ10	24,70
50336	Megaman 9W	9W	GZ10	24,70
50337	Megaman 11W	11W	GZ10	24,70
<hr/>				
50565	Megaman 7W	7W	GX53	28,00
50566	Megaman 9W	9W	GX53	28,50
50567	Megaman 11W	11W	GX53	28,50
<hr/>				
50561	Megaman Liliput Plus 2700 K	11W	E27	17,00
50562	Megaman Liliput Plus 6500 K	11W	E27	19,00



NEU
new

MODUL
ELECTRO
www.modulelectro.ru

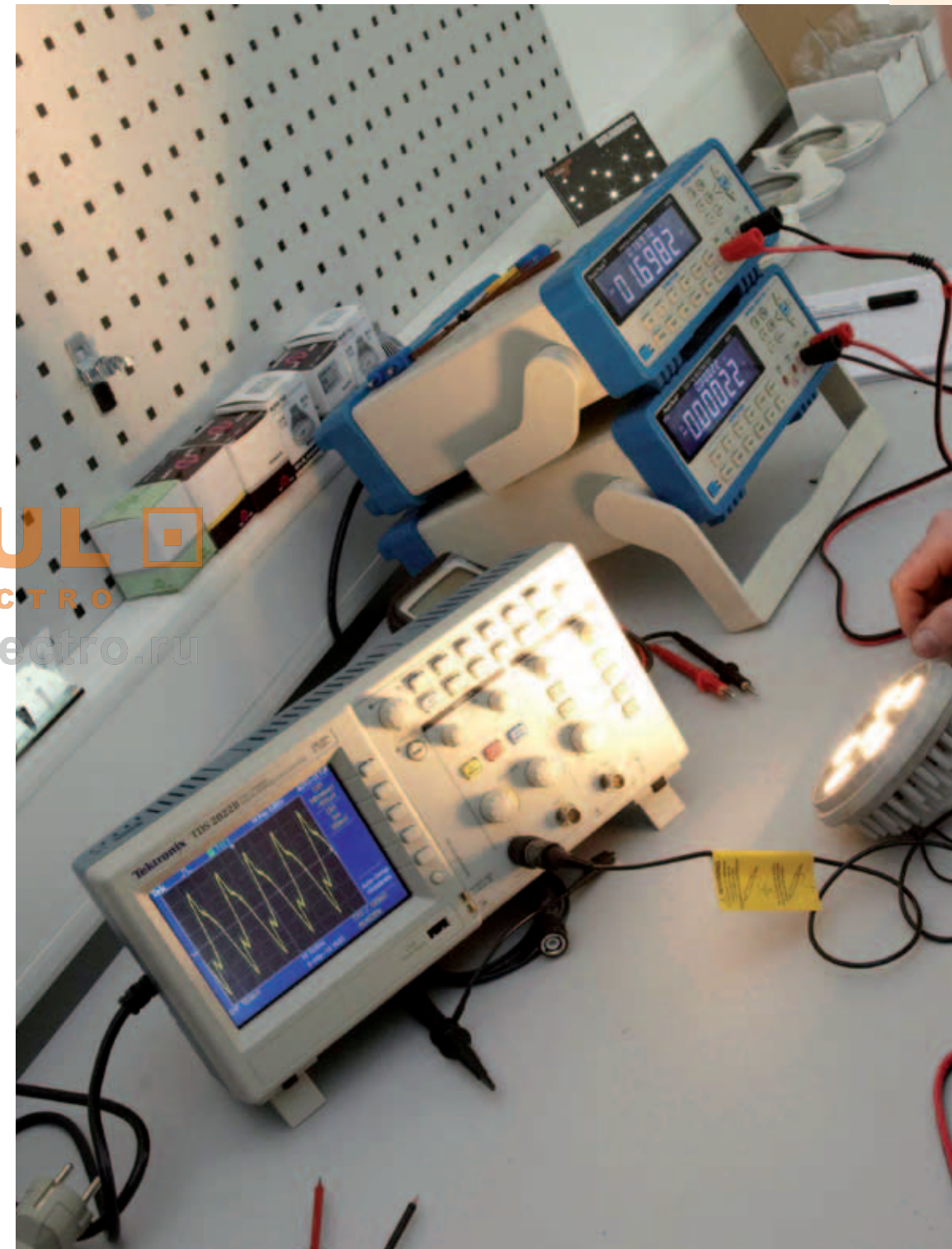

Inhaltsverzeichnis | index

Art.-Nr. art.-no.	Seite page	Preis price	Art.-Nr. art.-no.	Seite page	Preis price	Art.-Nr. art.-no.	Seite page	Preis price
0054.00	309	185,00	1053.04	258	62,60	1925.07	232	17,30
0054.02	309	183,00	1053.07	258	57,10	1925.15	232	23,80
0063.25	242	14,50	1055.02	271	99,50	1925.17	233	17,60
0064.00	242	15,50	1055.07	271	97,80	1925.20	252	36,30
0065.25	242	16,50	1055.22	271	122,50	1925.22	252	33,10
0066.00	242	19,60	1065.22	277	154,00	1925.27	252	36,30
0067.25	236	13,50	1180.22	253, 365	60,80	1925.42	384	39,20
0068.25	236	15,50	1181.22	253, 365	64,90	1926.02	228	20,90
0069.25	244	18,50	1190.07	251	22,70	1926.07	228	18,30
0070.25	244	20,50	1190.20	251	22,70	1927.05	228	26,10
0126.07	271	131,00	1190.22	251	21,50	1927.07	228	21,50
0210.02	288	29,00	1190.42	384	25,80	1927.15	228	29,10
0232.02	222	15,10	1191.07	251	34,60	1928.02	241	20,20
0232.03	222	17,10	1191.20	251	34,60	1928.05	241	21,10
0237.02	224	18,30	1191.22	251	32,20	1928.06	241	20,30
0238.02	224	18,30	1191.42	384	37,10	1928.07	241	17,20
0240.00	224	19,10	1192.20	250	19,90	1928.15	241	21,10
0241.00	224	17,90	1192.22	250	18,60	1929.02	247	39,00
0282.00	294	14,00	1193.07	250	23,80	1929.07	247	36,00
0283.00	294	18,00	1193.20	250	25,40	1929.15	247	42,00
0284.00	289	36,00	1193.22	250	23,30	1930.02	298	40,40
0285.00	289	48,00	1194.22	250	33,60	1930.05	298	42,90
0286.00	289	34,00	1196.07	250	28,40	1930.15	298	43,50
0289.00	288	24,00	1196.20	250	28,40	1935.02	229	23,50
0290.00	288	36,00	1196.22	250	26,70	1935.07	229	21,70
1007.03	257	54,10	1355.00	271	114,60	1935.26	229	26,70
1007.07	257	46,40	1355.02	271	113,50	1936.02	232	20,80
1009.00	258	53,80	1355.07	271	112,50	1936.05	232	23,80
1010.02	258	67,50	1355.22	271	138,50	1936.07	232	18,50
1010.03	258	69,70	1920.02	293	45,70	1936.26	232	24,20
1010.07	258	57,70	1920.03	293	51,20	1937.00	258	27,30
1023.02	256	36,60	1920.07	293	44,10	1938.02	229	19,40
1023.03	256	42,20	1921.02	293	46,90	1938.05	229	22,10
1026.02	256	46,70	1921.03	293	52,70	1938.07	229	18,30
1026.03	256	53,60	1921.07	293	45,70	1938.15	229	24,80
1026.07	256	43,60	1924.02	232	20,30	1940.15	290	45,60
1038.22	276	148,50	1924.07	232	17,60	1941.15	304	42,80
1052.03	257	50,10	1924.15	232	26,10	1942.15	290	51,00
1052.07	257	42,60	1924.42	384	37,10	1943.15	304	47,80
1053.00	258	61,30	1925.02	232	18,40	1960.02	292	25,20
1053.02	258	59,90	1925.05	232	21,10	1960.15	292	25,60
1053.03	258	65,60	1925.06	232	29,70	1961.02	292	25,20

Inhaltsverzeichnis | index

Art.-Nr. art.-no.	Seite page	Preis price	Art.-Nr. art.-no.	Seite page	Preis price	Art.-Nr. art.-no.	Seite page	Preis price
1961.15	292	25,60	2013.02	237	15,30	2037.07	283	27,40
1965.02	292	25,20	2013.03	237	19,90	2037.22	283	43,10
1965.15	292	25,60	2013.05	237	18,00	2039.05	222	19,90
1966.02	292	25,20	2013.07	237	12,10	2046.02	231	37,70
1966.15	292	25,60	2017.02	229	8,70	2046.03	231	39,80
1969.17	246	23,00	2017.03	229	12,40	2046.05	231	38,70
1985.02	294	64,40	2017.04	229	18,70	2046.07	231	35,40
1987.02	294	66,60	2017.05	229	9,20	2047.02	228	8,10
1989.25B	291	104,00	2017.06	229	10,95	2047.03	228	9,80
1989.25W	291	104,00	2017.07	229	7,60	2047.05	228	8,60
1996.02	231	16,90	2019.02	228	15,40	2047.07	228	6,80
1996.05	231	18,10	2019.03	228	16,60	2048.02	233	18,20
1996.06	231	32,70	2019.07	228	11,20	2048.03	233	20,80
1996.07	231	14,60	2020.00	223	22,70	2048.05	233	19,40
1996.15	231	21,40	2020.02	223	24,70	2048.07	233	13,10
1996.20	252	35,40	2020.03	223	27,50	2050.02	233	18,50
1996.22	252	32,20	2020.07	223	19,80	2050.03	233	22,40
1996.51	233	23,50	2020RGB	188	98,00	2050.04	233	21,20
1998.02	232	53,80	2028.02	290	115,40	2050.05	233	19,80
1998.07	232	48,30	2030.02	222	6,50	2050.07	233	14,80
1998.15	232	61,50	2030.03	222	8,20	2052.00	230	20,30
2000.00	230	15,00	2030.05	222	7,00	2052.02	230	18,30
2000.02	230	13,10	2030.07	222	6,00	2052.03	230	22,70
2000.03	230	16,20	2030.08	222	6,60	2052.07	230	14,30
2000.07	230	11,30	2031.02	222	7,40	2062.02	275	23,50
2003.02	236	10,10	2031.03	222	9,00	2062.07	275	21,10
2003.03	236	12,60	2031.05	222	7,90	2062.25	275	22,50
2003.05	236	11,40	2031.07	222	6,70	2067.00	257	31,20
2003.07	236	8,80	2033.02	237	10,80	2067.01	257	36,30
2007.02	280	10,70	2033.03	237	14,10	2067.02	257	30,10
2007.03	280	11,50	2033.05	237	12,10	2067.03	257	38,70
2007.05	280	10,70	2033.07	237	9,50	2067.04	257	35,00
2007.07	280	9,60	2034.02	214, 230	14,60	2067.07	257	24,40
2011.02	229	8,80	2034.03	214, 230	17,80	2070.02	282	15,80
2011.05	229	9,40	2034.04	214, 230	21,50	2070.03	282	18,00
2011.06	229	9,70	2034.05	214, 230	15,20	2070.05	282	16,50
2011.07	229	7,30	2034.06	214, 230	17,90	2070.07	282	14,60
2011.15	229	9,90	2034.07	214, 230	10,30	2073.02	282	23,60
2012.02	230	14,40	2034.08	214, 230	12,20	2073.03	282	26,80
2012.05	230	15,60	2037.00	283	31,20	2073.05	282	24,80
2012.07	230	10,20	2037.02	283	29,90	2073.07	282	22,30
2012.15	230	16,20	2037.03	283	31,90	2075.02	303	125,10

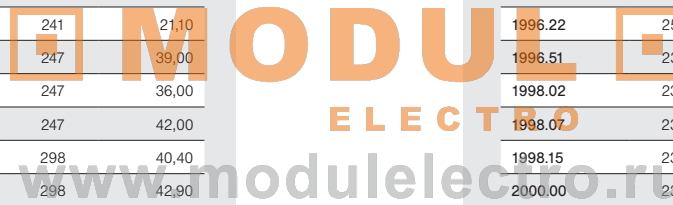

Inhaltsverzeichnis | index

Art.-Nr. art.-no.	Seite page	Preis price	Art.-Nr. art.-no.	Seite page	Preis price	Art.-Nr. art.-no.	Seite page	Preis price
2075.03	303	134,60	2118.01	243	17,30	2190.07	251	18,40
2082.00	257	25,00	2118.02	243	13,50	2190.20	251	18,40
2082.02	257	23,80	2118.03	243	15,10	2190.22	251	16,80
2082.03	257	27,70	2118.04	243	15,60	2191.07	251	21,90
2082.07	257	20,00	2118.05	243	14,60	2191.20	251	21,90
2087.02	256	19,40	2118.07	243	9,20	2191.22	251	20,10
2087.03	256	24,30	213100	293	29,00	2192.03	264	40,90
2087.07	256	15,20	2132.07	247	23,60	2193.25	270	39,80
2089.00	256	27,40	2132.15	247	30,80	2194.25	270	41,10
2089.03	256	33,40	2139.02	247	30,60	2203.02	237	12,60
2093.02	243	18,00	2139.03	247	34,20	2203.03	237	13,40
2093.03	243	19,90	2139.07	247	26,20	2203.05	237	12,90
2093.04	243	20,60	2147.15	246	25,10	2204.02	244	19,60
2093.05	243	19,30	2154.02	246	32,90	2204.03	244	20,10
2093.07	243	12,90	2154.03	246	39,90	2204.05	244	20,60
2094.25	243	32,10	2154.05	246	38,70	2204.07	244	16,70
2100.07	247	26,00	2154.07	246	25,00	2218.25B	299	134,00
2100.15	247	36,00	2156.02	290	52,00	2218.25W	299	134,00
2103.01	236	11,00	2156.15	290	60,80	2219.25B	299	128,00
2103.02	236	8,90	2159.25	245	53,40	2219.25W	299	128,00
2103.03	236	11,70	2160.02	276	50,80	2225.42	386	51,50
2103.04	236	11,80	2160.25	276	40,90	2262.02	275	35,00
2103.05	236	10,30	2162.25	273	38,40	2262.07	275	32,00
2103.07	236	7,90	2164.02	264	32,80	2262.15	275	37,00
2104.01	237	17,10	2164.03	264	34,90	2264.22	271	23,50
2104.02	237	13,40	2164.07	264	25,60	2269.15	280	14,10
2104.03	237	18,00	2169.02	241	16,70	2274.22	270	18,00
2104.05	237	15,90	2169.03	241	18,60	2281.02	274	68,00
2104.07	237	10,10	2169.05	241	18,00	2282.02	274	68,00
2110.02	238	19,40	2169.07	241	11,90	2284.02B	298	76,00
2110.05	238	22,10	2169.35	241	18,90	2284.02G	298	76,00
2110.07	238	18,30	2170.02	240	32,90	2284.02R	298	76,00
2110.15	238	24,80	2170.05	240	32,90	2284.02W	298	76,00
2111.02	238	20,40	2170.25	240	25,90	2284.02Y	298	76,00
2111.05	238	23,10	2174.25	245	33,20	2284.15B	298	76,00
2111.07	238	19,30	2178.02	273	45,80	2284.15G	298	76,00
2111.15	238	25,80	2178.05	273	45,80	2284.15R	298	76,00
2117.01	240	10,80	2178.25	273	36,00	2284.15W	298	76,00
2117.02	240	8,10	2180.25	276	47,70	2284.15Y	298	76,00
2117.03	240	9,80	2183.25	240	27,30	2286.25	275	70,70
2117.05	240	9,20	2186.25	244	33,80	2288.02B	298	69,90
2117.07	240	7,00	2188.25	276	47,70	2288.02G	298	69,90

Inhaltsverzeichnis | index

Art.-Nr. art.-no.	Seite page	Preis price	Art.-Nr. art.-no.	Seite page	Preis price	Art.-Nr. art.-no.	Seite page	Preis price
2288.02R	298	69,90	2350.02	262	22,60	2445.15WW	124	96,00
2288.02W	298	69,90	2350.03	262	27,00	2446.15W	125	78,00
2288.02Y	298	69,90	2350.05	262	24,70	2446.15WW	125	78,00
2288.15B	298	69,90	2350.07	262	18,90	2450.02	283	34,20
2288.15G	298	69,90	2351.02	264	24,70	2450.07	283	33,60
2288.15R	298	69,90	2351.03	264	29,70	2450.26	283	33,90
2288.15W	298	69,90	2351.05	264	27,00	2452.02	283	45,60
2288.15Y	298	69,90	2351.07	264	20,80	2452.05	283	46,00
2289.02	277	27,90	2355.02	302	25,60	2452.07	283	44,90
2289.15	277	27,90	2355.05	302	26,80	2452.26	283	45,40
2293.02	274	89,40	2355.07	302	22,90	2453.02	284	48,70
2294.02	275	89,40	2355.15	302	26,90	2453.07	284	47,80
2295.00	231	11,70	2356.07	303	34,70	2453.26	284	48,30
2295.02	231	11,10	2356.15	303	40,40	2455.02	281	11,30
2295.07	231	8,30	2358.00	280	8,40	2455.05	281	11,60
2295.15	231	11,70	2358.02	280	8,10	2455.26	281	11,10
2296.00	231	12,40	2358.07	280	6,40	2456.02	284	39,30
2296.02	231	11,50	2358.15	280	8,40	2456.07	284	38,80
2296.07	231	8,90	2359.00	282	10,30	2456.26	284	38,80
2296.15	231	12,40	2359.02	282	9,90	2457.02	284	47,10
2298.25	277	98,30	2359.07	282	8,40	2457.05	284	47,60
2299.25	277	96,10	2359.15	282	10,30	2457.07	284	46,40
2302.02	267	20,40	2370.25	302	77,70	2457.26	284	46,40
2302.07	267	16,70	2371.25	302	87,90	2461.02	280	13,90
2303.07	267	27,20	2375.25	304	91,70	2461.05	280	14,00
2304.07	266	16,50	2376.25	304	91,70	2461.07	280	13,50
2305.07	266	22,10	2386.15B	288	39,00	2461.26	280	13,60
2306.07	266	16,90	2386.15W	288	39,00	2462.02	281	18,30
2307.07	267	23,20	2387.15	298	73,90	2462.26	281	17,80
2308.07	266	17,40	2392.07	243	13,50	2521.15	296	27,00
2309.07	267	30,40	2392.15	243	14,50	2523.15	296	20,00
2310.22	386	44,10	2430.26	285	37,60	2526.15	297	31,00
2311.22	386	46,40	2432.02	285	53,40	2527.15	297	46,00
2315.22	387	139,30	2432.26	285	53,10	2531.15	297	29,00
2315LED	106	194,80	2440.07	284	41,50	2532.15	297	38,00
2316.22	387	89,00	2440.26	284	41,80	2535.25	240	44,00
2316LED	106	143,20	2442.02	285	53,00	2538.25	246	29,00
2332.15	296	19,00	2442.07	285	52,50	2540.25	241	26,70
2333.15	296	21,00	2442.26	285	52,70	2542.25	241	28,50
2337.42	253, 385	40,00	2444.15W	124	98,00	2547.22	245	57,80
2338.42	253, 385	42,00	2444.15WW	124	98,00	2671.02	273	42,90
2339.42	273, 386	46,00	2445.15W	124	96,00	2673.02	274	66,70

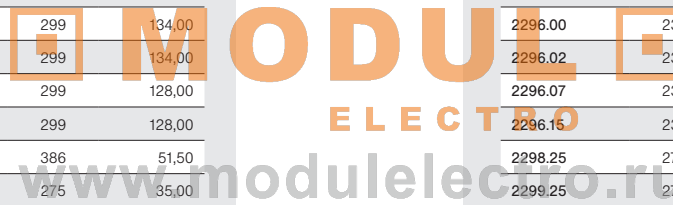

Inhaltsverzeichnis | index

Art.-Nr. art.-no.	Seite page	Preis price	Art.-Nr. art.-no.	Seite page	Preis price	Art.-Nr. art.-no.	Seite page	Preis price
2674.22	270	18,00	314110	401	274,00	3545	458	24,00
3006RGB	190	319,00	314112	401	390,00	3556V12	450	45,00
3010RGB	191	339,00	3146	392	214,30	3556V24	450	45,00
3012RGB	192	219,00	3147	392	220,30	3557V12	450	79,00
3013RGB	192	219,00	3150	394	393,30	3557V24	450	79,00
303500	223	32,00	3155	394	418,00	3558V12	451	109,00
3040.02	295	33,20	3160	395	720,90	3558V24	451	109,00
3040.05	295	33,20	3161	395	834,60	3559	161, 163	59,00
3041.02	295	36,30	3162	395	749,40	3560	451	99,00
3041.05	295	36,30	3163	395	853,90	3661RGB	196	198,50
305100	408	69,00	3177	387	188,00	3662RGB	196	198,50
3061.25	388	93,00	3177LED	158	282,50	3703	404	19,00
3062.25	388	93,00	3380NW	104	169,00	3704	404	16,00
3063.25	388	93,00	3380WW	104	169,00	3706RGB	190	279,00
3083.07	314	84,60	3381NW	104	169,00	3711	161	5,80
3084.07	315	171,40	3381RGB	194	189,00	3712	163	5,80
3090.02	313	109,40	3381WW	104	169,00	3713	161, 163	3,90
3090.07	313	96,10	3383NW	105	649,00	3714	161, 163	6,80
3091.07	314	111,90	3383RGB	195	698,00	3715	161, 163	6,80
3091.26	314	115,10	3383WW	105	649,00	3800RGB	200	256,50
3092.02	313	88,20	3505	43, 442	29,90	3802RGB	199	241,40
3092.05	313	91,00	3506	450	41,00	3804RGB	199	241,40
3092.07	313	67,50	3511	447	49,90	3807	167	17,30
3092.26	313	97,00	3513	43, 442	24,90	3818W	185	149,50
3093.02	312	62,10	3514	442	99,00	3819W	185	172,50
3093.07	312	58,40	3515	444	89,00	3820W	185	214,50
3093.15	312	67,30	3516	444	89,00	3821W	185	214,50
3094.07	315	144,50	3517	42, 446	24,90	3830	458	5,90
3096.02	312	52,40	3518	42, 446	32,50	3831	365, 458	8,90
3096.07	312	49,90	3519	42, 446	49,90	3832	458	10,90
3098.22	316	89,10	3522RGB	188	123,90	3833	113	24,00
3101	390	66,80	3523RGB	189	144,90	3835	448	2,60
3102	390	71,00	3524RGB	189	155,40	3836	448	3,20
3104	391	68,30	3534	454	259,00	3837	448	3,80
3105	391	63,00	3535	457	59,00	3838	449	2,70
3128	392	72,50	3535CA	457	59,00	3839	449	3,30
313110	400	262,00	3539	454	398,00	3840	449	4,00
313112	400	378,00	3540	452	249,00	3841B50	176	249,00
313210	402	252,00	3541	452	198,00	3841BIP	176	398,00
313212	402	368,00	3542	453	229,00	3841G50	176	249,00
314010	403	264,00	3543	453	229,00	3841GIP	176	398,00
314012	403	380,00	3544	455	149,00	3841R50	176	249,00

Inhaltsverzeichnis | index

Art.-Nr. art.-no.	Seite page	Preis price	Art.-Nr. art.-no.	Seite page	Preis price	Art.-Nr. art.-no.	Seite page	Preis price
3841RGB	206	538,00	3844WIP	181	698,00	3868RGB	198	169,00
3841RGBI	206	598,00	3844WW10	181	449,00	3875RGB	203	598,00
3841RIP	176	398,00	3844WWIP	181	698,00	3876RGB	203	898,00
3841W50	176	249,00	3844Y10	181	449,00	3900W	160	59,00
3841WIP	176	398,00	3844YIP	181	698,00	3901W	162	59,00
3841WW50	176	249,00	3847B	175	185,00	3908W	159	254,00
3841WWIP	176	398,00	3847G	175	185,00	3917W	159	312,00
3841Y50	176	249,00	3847R	175	185,00	415801E	320	84,80
3841YIP	176	398,00	3847RGB	204	298,00	415801V	320	52,90
3842B50	177	289,00	3847W	175	185,00	415802E	320	84,80
3842BIP	177	498,00	3847WW	175	185,00	415802V	320	52,90
3842G50	177	289,00	3847Y	175	185,00	415803E	320	115,10
3842GIP	177	498,00	3849B	175	195,00	415803V	320	65,50
3842R50	177	289,00	3849G	175	195,00	415804E	320	115,10
3842RGB	207	549,00	3849R	175	195,00	415804V	320	65,50
3842RGBI	207	698,00	3849RGB	204	298,00	415807E	320	85,80
3842RIP	177	498,00	3849W	175	195,00	415807V	320	53,90
3842W50	177	289,00	3849WW	175	195,00	420001E	322	83,00
3842WIP	177	498,00	3849Y	175	195,00	420001V	322	50,30
3842WW50	177	303,00	3850B	186	199,00	420002E	322	83,00
3842WWIP	177	532,00	3850G	186	199,00	420002V	322	50,30
3842Y50	177	289,00	3850R	186	199,00	420003E	322	102,60
3842YIP	177	498,00	3850W	186	199,00	420003V	322	52,80
3843B10	180	398,00	3850WW	186	199,00	420004E	322	102,60
3843BIP	180	598,00	3850Y	186	199,00	420004V	322	52,80
3843G10	180	398,00	3851B	186	249,00	420413E	330	144,90
3843GIP	180	598,00	3851G	186	249,00	420413V	330	94,30
3843R10	180	398,00	3851R	186	249,00	420414E	330	144,90
3843RIP	180	598,00	3851W	186	249,00	420414V	330	94,30
3843W10	180	398,00	3851WW	186	249,00	420601E	333	85,20
3843WIP	180	640,00	3851Y	186	249,00	420601V	333	52,60
3843WW10	180	398,00	3854B	187	339,00	420602E	333	85,20
3843WWIP	180	640,00	3854G	187	339,00	420602V	333	52,60
3843Y10	180	398,00	3854R	187	339,00	420603E	333	104,80
3843YIP	180	598,00	3854W	187	339,00	420603V	333	55,00
3844B10	181	449,00	3854WW	187	339,00	420604E	333	104,80
3844BIP	181	698,00	3854Y	187	339,00	420604V	333	55,00
3844G10	181	449,00	3855RGB	208	339,00	420607E	333	108,20
3844GIP	181	698,00	3856RGB	208	369,00	420607V	333	61,80
3844R10	181	449,00	3863RGB	201	219,00	420707E	322	105,90
3844RIP	181	698,00	3865RGB	201	398,00	420707V	322	59,50
3844W10	181	449,00	3867RGB	198	159,00	425001E	322	93,00

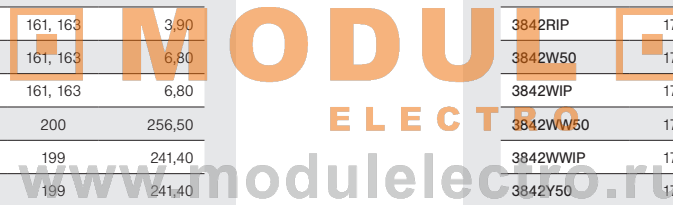

Inhaltsverzeichnis | index

Art.-Nr. art.-no.	Seite page	Preis price	Art.-Nr. art.-no.	Seite page	Preis price	Art.-Nr. art.-no.	Seite page	Preis price
425001V	322	61,30	435022E	331	184,30	470003V	336	97,40
425002E	322	93,00	435022V	331	131,50	470004E	336	141,00
425002V	322	61,30	435031E	331	188,80	470004V	336	97,40
425003E	322	112,00	435031V	331	133,70	470005E	336	144,80
425003V	322	62,70	435032E	331	184,30	470005V	336	101,60
425004E	322	112,00	435032V	331	131,50	470701E	336	125,50
425004V	322	62,70	435061E	331	188,80	470701V	336	86,40
425008E	322	120,20	435061V	331	133,70	470702E	336	125,50
425008V	322	73,70	435062E	331	184,30	470702V	336	86,40
425009E	322	120,20	435062V	331	131,50	470707E	336	125,50
425009V	322	73,70	440705E	324	140,50	470707V	336	86,40
425707E	322	96,40	440705V	324	82,50	470708E	336	142,50
425707V	322	64,70	445425E	330	197,20	470719E	336	151,50
430002E	323	105,60	445625E	333	149,10	470726E	336	157,90
430002V	323	67,50	445705E	324	150,60	470727E	336	157,90
430004E	323	104,80	445705V	324	88,70	475063E	338	178,60
430004V	323	62,70	445725E	324	146,90	475073E	339	156,10
430005E	323	116,90	460001E	341	129,90	475079E	338	198,90
430005V	323	66,30	460001V	341	102,60	475089E	339	166,30
430415E	330	160,60	460002E	341	129,90	485904E	332	103,00
430415V	330	110,00	460002V	341	102,60	50000	472	3,70
430603E	333	108,20	460003E	341	152,70	50001	472	3,70
430603V	333	66,00	460003V	341	111,70	50002	472	3,70
430604E	333	108,20	460004E	341	152,70	50003	472	3,70
430604V	333	66,00	460004V	341	111,70	50004	472	3,70
430605E	333	120,20	460005E	341	171,00	500147	438	148,90
430605V	333	69,60	460005V	341	129,90	500162	302	113,10
430708E	323	129,30	460007E	341	163,90	500165	438	75,00
435003E	323	115,70	460007V	341	123,10	500171	437	210,80
435003V	323	73,70	461001E	341	123,20	500172	437	123,90
435004E	323	115,70	461001V	341	95,90	500176	439	88,20
435004V	323	73,70	461002E	341	123,20	500177	439	99,80
435005E	323	126,90	461002V	341	95,90	500235W	434, 157	129,00
435005V	323	76,10	461007E	341	123,20	500236W	435, 157	189,00
435009E	323	129,30	461007V	341	95,90	500238W	435, 156	139,00
435009V	323	80,30	462001E	341	109,40	500245W	146	98,00
435010E	323	129,30	462001V	341	81,90	500246W	153	92,00
435010V	323	80,30	462002E	341	109,40	500350W	156	119,00
435011E	323	133,70	462002V	341	81,90	500352W	158	159,00
435011V	323	81,70	462007E	341	109,40	500354W	153	249,00
435021E	331	188,80	462007V	341	81,90	50038	472	2,90
435021V	331	133,70	470003E	336	140,70	50039	472	2,90

Inhaltsverzeichnis | index

Art.-Nr. art.-no.	Seite page	Preis price	Art.-Nr. art.-no.	Seite page	Preis price	Art.-Nr. art.-no.	Seite page	Preis price
50040	472	2,90	50373	473	11,90	522980	309	219,00
50041	472	2,90	50381	473	13,40	530100	468	27,50
50042	472	3,50	50543	474	7,80	530102	468	27,80
50043	472	2,90	50545	474	7,80	530107	468	23,70
50045	473	40,20	50547	474	7,80	530122	468	30,00
50051	472	11,50	50553	474	11,90	530200	468	29,40
50054	472	11,70	50555	474	11,90	530202	468	31,00
50056	472	13,70	50557	474	11,90	530207	468	24,90
50057	472	13,70	50561	400, 474	17,00	530222	468	32,60
50059	472	13,70	50562	400, 474	19,00	530300	468	31,40
50060	472	13,70	50565	474	28,00	530302	468	33,20
500910W	434, 153	269,00	50566	474	28,50	530307	468	27,20
500915W	432, 151	239,00	50567	474	28,50	530322	468	35,00
500916W	433, 151	239,00	50573	474	7,80	53035	465	102,50
500920W	432, 148	249,00	50575	474	7,80	53040	465	102,50
500925W	433, 152	269,00	50577	474	7,80	530400	468	46,70
500940W	152	249,00	50583	474	10,50	530402	468	47,20
500950W	148	247,00	50585	474	10,50	530407	468	41,10
500951W	154	167,00	50587	474	10,50	530422	468	52,50
500952W	154	186,00	50588	474	10,50	530500	468	52,40
50100	472	2,30	50589	474	10,50	530502	468	58,00
50101	472	1,60	512411	422	49,00	530507	468	45,80
50102	472	1,60	512412	422	98,00	530522	468	57,20
50103	472	2,40	512413	423	137,00	530600	468	58,40
50104	472	1,60	512431	426	60,80	530602	468	66,60
50105	472	1,60	512432	426	94,80	530607	468	49,60
50151	473	7,50	512474	428	64,00	530622	468	62,50
50153	473	5,10	512475	428	68,00	531200	467	30,70
50155	473	70,10	512541	424	104,80	531300	467	29,40
50156	473	70,10	512542	424	177,40	531400	467	28,30
50180	473	5,80	512543	425	254,80	531500	314	35,80
50181	473	5,80	512701	427	185,50	532000	469	5,70
50309	473	3,10	512761	429	43,40	532100	469	4,90
50311	473	3,10	512811	420	29,00	532500	468	1,00
50312	473	3,10	512812	420	49,00	532600	468	3,90
50313	473	7,70	522226	427	177,50	534600	468	0,80
50332	473	10,20	522941	308	40,50	534700	468	0,80
50335	474	24,70	522942	308	45,00	534800	466	4,50
50336	474	24,70	522950	308	112,30	535100	469	6,40
50337	474	24,70	522951	308	172,20	535200	467	16,30
50351	473	10,20	522970	309	155,50	535300	467	17,10
50361	473	10,20	522971	309	254,70	535400	467	17,60

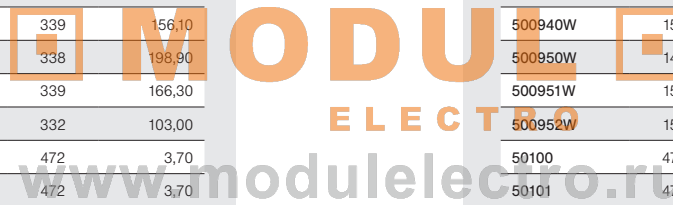

Inhaltsverzeichnis | index

Art.-Nr. art.-no.	Seite page	Preis price	Art.-Nr. art.-no.	Seite page	Preis price	Art.-Nr. art.-no.	Seite page	Preis price
535800	262, 466	9,50	570500	308	26,80	910600	371	21,60
535900	262, 466	9,50	570600	309	35,40	910700	371	32,40
536000	470	8,60	574000	292	7,50	910800	371	32,40
536100	470	10,00	574100	292	7,50	931000	377	9,60
536200	470	4,00	574500	292	7,50	931200	377	38,00
536300	467	17,00	574600	292	7,50	932000	363	31,40
536400	466	3,25	576000	293	12,00	932100	363	43,40
536500	470	6,30	576100	293	13,40	932200	363	43,40
536600	466	3,25	578500	294	20,40	932300	363	42,30
536800	466	4,50	578700	294	20,40	932400	363	42,30
5370.02	282	14,10	782050	408	122,60	932600	363	85,50
5370.03	282	15,90	782051	408	177,00	940600	362	1674,00
5370.05	282	14,60	782150	408	129,50	940800	362	1908,00
5370.07	283	10,90	782151	408	185,00	941000	362	415,30
5372.22	364	41,20	782350	411	173,40	941100	362	459,60
537300	471	6,40	782450	411	181,90	941400	362	528,90
537400	471	6,20	782451	411	231,20	941500	362	572,10
5387	239	4,30	782550	409	160,00	9419RGB	364	598,00
5388	239	6,90	782551	409	227,90	9419RGB-Slave	364	598,00
5397	239	6,30	782650	413	265,40	9419W	364	212,00
5398	239	6,90	782850	413	301,80	9425	365	1646,00
540025	418	2095,00	782950	413	244,00	950100	354	918,20
540026	418	1395,00	783150	408	137,00	950200	354	874,90
540027	416	2295,00	783151	408	190,50	950300	354	853,30
540028	416	1595,00	783152	408	210,60	950400	355	989,70
540029	396	1050,00	783154	408	260,00	9510B	350	139,50
540030	396	595,00	783250	409	153,60	9510G	350	139,50
540420	430	862,90	783252	409	209,00	9510R	350	139,50
540440	430	1382,40	784050	411	179,80	9510W	350	139,50
54211	460	24,30	784051	411	232,00	9510Y	350	139,50
54261	461	19,70	784550	413	194,80	9511B	350	139,50
54271	461	22,00	785550	411	173,40	9511G	350	139,50
54281	461	30,20	785551	411	229,00	9511R	350	139,50
54291	462	33,60	900000	369	195,00	9511W	350	139,50
54510	470	78,50	90195	404	20,00	9511Y	350	139,50
551700	290	19,80	90199	377	106,00	9512B	351	184,50
554500	308, 136	26,70	910000	369	0,90	9512G	351	184,50
554700	309, 137	25,90	910100	370	4,30	9512R	351	184,50
554800	309	32,60	910200	369	4,90	9512RGB	353	269,00
555500	308	21,40	910300	370	8,30	9512W	351	184,50
555700	309	17,00	910400	36	10,80	9512Y	351	184,50
555800	309	34,60	910500	370	16,10	9513B	350	113,50

Inhaltsverzeichnis | index

Art.-Nr. art.-no.	Seite page	Preis price	Art.-Nr. art.-no.	Seite page	Preis price	Art.-Nr. art.-no.	Seite page	Preis price
9513G	350	113,50	975400	373	1,50	B165EWK	321	35,80
9513R	350	113,50	9760.02	372	7,90	B165EWM	321	35,80
9513W	350	113,50	9760.05	372	8,70	B165EWT	321	35,80
9513Y	350	113,50	9761.02	373	8,40	B165RW1	321	37,90
9512RGB	353	269,00	9761.05	373	9,10	B165SW2	321	37,90
951400	352	600,30	9779.22	374	56,70	B185AKO	335	49,00
951500	352	269,30	978800	374	103,00	B185AOP	335	29,80
951600	355	1112,90	9794.22	374	68,30	B185ARB	334	29,80
951700	355	1037,30	9802B	360	2392,00	B185ARO	334	29,80
955000	352	301,80	9802O	360	2392,00	B185ARY	334	29,80
9570	356	1234,00	9803B	360	1078,00	B185ESK	334	41,60
9571	356	2048,00	9803S	360	1078,00	B185ESM	334	41,60
9572	357	1028,00	9804B	360	538,00	B185EST	334	41,60
9573	357	1646,00	9804S	360	538,00	B185PRB	334	33,20
9601.05	359	1492,50	980800	361	268,00	B185PRO	334	33,20
9601.15	359	1492,50	980900	361	317,00	B185PRY	334	33,20
9602.05	359	1957,60	981000	361	317,00	B185SRW	333	16,20
9602.15	359	1957,60	98710WB	381	575,50	B185SZ1	334	39,90
9603.05	359	2309,10	98710WG	381	575,50	B185SZ2	334	39,90
9603.15	359	2309,10	98710WR	381	575,50	B185RS1	334	39,90
9610B	351	498,00	98710WW	381	575,50	B220AOP	335	33,10
9610G	351	498,00	98850WB	381	691,10	B220ARB	334	33,10
9610R	351	498,00	98850WG	381	691,10	B220ARO	334	33,10
9610W	351	498,00	98850WR	381	691,10	B220ARY	334	33,10
9610Y	351	498,00	98850WW	381	691,10	B220ESK	334	44,60
9611RGB	353	998,00	9885B	379	179,00	B220ESM	334	44,60
9728.05	375	11,90	9885G	379	179,00	B220EST	334	44,60
9728.15	375	11,10	9885R	379	179,00	B220PRB	334	37,50
9729.05	375	11,90	9885W	379	179,00	B220PRO	334	37,50
9729.15	375	11,10	9885Y	379	179,00	B220PRY	334	37,50
9730.05	375	13,40	9886B	379	199,50	B220RS1	333	44,50
9730.15	375	13,40	9886G	379	199,50	B220SRW	334	20,30
9731.05	375	15,10	9886R	379	199,50	B220SZ1	334	44,50
9731.15	375	15,10	9886RGB	380	266,50	B220SZ2	334	44,50
9733.05	376	20,30	9886W	379	199,50	B255AOP	335	35,80
9733.15	376	20,30	9886Y	379	199,50	B255ARB	334	35,80
973500	376	5,50	B145EWK	99	40,60	B255ARO	334	35,80
973600	376	16,10	B145EWM	99	40,60	B255ARY	334	35,80
973700	373	5,70	B145EWT	98	40,60	B255ESK	334	48,10
974800	374	103,00	B145PWY	99	32,20	B255ESM	334	48,10
975100	372	1,30	B145SW2	99	38,90	B255EST	334	48,10
975200	372	3,60	B145ZWP	99	28,80	B255PRB	334	42,10

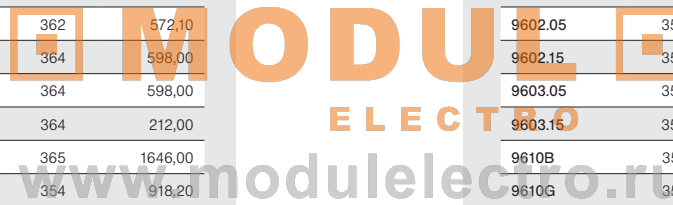

Inhaltsverzeichnis | index

Art.-Nr. art.-no.	Seite page	Preis price	Art.-Nr. art.-no.	Seite page	Preis price	Art.-Nr. art.-no.	Seite page	Preis price
B255PRO	334	42,10	BOMAC4.2	66	230,00	H2067.03	263	48,60
B255PRY	334	42,10	BOMAC4.4	66	230,00	H2067.04	263	44,90
B255RS1	334	48,30	F195ABC	332	28,70	H2067.07	263	34,20
B255SRW	333	24,40	F195AOC	332	28,70	H2191.07	262	31,40
B255SZ1	334	48,30	F195AYC	332	28,70	H2191.20	262	31,40
B255SZ2	334	48,30	F195ROC	332	41,40	H2191.22	262	29,60
B3001NW	100	289,00	H0063NW2	92	118,50	H2671NW2	93	133,00
B3001WW	100	289,00	H0063NW4	92	118,50	H2671NW4	93	133,00
B3002NW	100	294,00	H0063NW6	92	118,50	H2671NW6	93	133,00
B3002WW	100	294,00	H0063W2	92	118,50	H2671W2	93	133,00
B3010W	79	25,70	H0063W4	92	118,50	H2671W4	93	133,00
B3010WW	79	25,70	H0063W6	92	118,50	H2671W6	93	133,00
B3030W	79	49,00	H0063WW2	92	118,50	H2671WW2	93	133,00
B3030WW	79	49,00	H0063WW4	92	118,50	H2671WW4	93	133,00
B4B001KW	60	355,00	H0063WW6	92	118,50	H2671WW6	93	133,00
B4B003WW	56	213,00	H0065NW2	93	119,50	H3005NW2	92	133,00
B4B004WW	57	319,00	H0065NW4	93	119,50	H3005NW4	92	133,00
B4B005WW	58	449,00	H0065NW6	93	119,50	H3005NW6	92	133,00
B4B006WW	59	533,00	H0065W2	93	119,50	H3005W2	92	133,00
B4B00700	54	449,00	H0065W4	93	119,50	H3005W4	92	133,00
B4B00800	55	317,00	H0065W6	93	119,50	H3005W6	92	133,00
B4B009KW	50	359,00	H0065WW2	93	119,50	H3005WW2	92	133,00
B4B010KW	50	717,00	H0065WW4	93	119,50	H3005WW4	92	133,00
B4B01100	51	500,00	H0065WW6	93	119,50	H3005WW6	92	133,00
B4B01200	52	1798,00	H1191.07	263	44,40	H3011NW	98	298,00
B4B01400	48	747,00	H1191.20	263	44,40	H3011W	98	298,00
B4B900BL	56	30,00	H1191.22	263	42,00	H3011WW	98	298,00
B4B900BL	58	30,00	H1996.02	264	26,40	ICICLE1.2	68	276,00
B4B900KW	56	30,00	H1996.05	264	27,60	ICICLE2.1	68	342,00
B4B900KW	58	30,00	H1996.06	264	42,80	ICICLE2.2	69	342,00
B4B900RO	58	30,00	H1996.07	264	24,10	M1925.02T	263	26,70
B4B900RO	58	30,00	H1996.15	264	30,90	M1925.07T	263	25,70
B4B901BL	57	46,00	H2034.02	263	24,10	M1925.15T	263	30,80
B4B901BL	59	46,00	H2034.03	263	27,30	M1925.22T	263	41,10
B4B901KW	57	46,00	H2034.04	263	31,50	N185ARB	327	27,80
B4B901KW	59	46,00	H2034.05	263	24,70	N185ARO	327	27,80
B4B901RO	57	46,00	H2034.06	263	27,40	N185ARY	327	27,80
B4B901RO	59	46,00	H2034.07	263	19,80	N185KRR	326	42,50
BOMAC2.2	62	195,00	H2034.08	263	21,70	N185KRS	337	42,50
BOMAC2.4	62	195,00	H2067.00	263	41,00	N185RS1	326	37,90
BOMAC3.2	64	230,00	H2067.01	263	46,10	N185SER	326	56,80
BOMAC3.4	64	230,00	H2067.02	263	39,90	N185SZ2	326	37,90

Inhaltsverzeichnis | index

Art.-Nr. art.-no.	Seite page	Preis price	Art.-Nr. art.-no.	Seite page	Preis price	Art.-Nr. art.-no.	Seite page	Preis price
N185TUR	326	57,90	P3605B	108	24,20	P3621B	140	126,10
N215KRS	337	47,10	P3605G	108	24,20	P3621G	140	126,10
N220ARB	327	34,50	P3605R	108	24,20	P3621R	140	126,10
N220ARO	327	34,50	P3605W	108	24,20	P3621W	140	126,10
N220ARY	327	34,50	P3605WWW	108	24,20	P3621WWW	140	126,10
N220KRR	326, 342	47,10	P3605Y	108	24,20	P3621Y	140	126,10
N220LGK	329	35,80	P3611B	134	149,50	P3622B	141, 388	126,10
N220LGM	329	35,80	P3611G	134	149,50	P3622G	141, 388	126,10
N220LGT	329	35,80	P3611R	134	149,50	P3622R	141, 388	126,10
N220LNB	329	84,00	P3611W	134	149,50	P3622W	141, 388	126,10
N220LNT	328	119,00	P3611WWW	134	149,50	P3622WWW	141	126,10
N220LNW	329	84,00	P3611Y	134	149,50	P3622Y	141, 388	126,10
N220LWB	328	69,00	P3615B	136	149,50	P3626B	122	99,00
N220LWT	328	99,00	P3615G	136	149,50	P3626G	122	99,00
N220LWW	328	69,00	P3615R	136	149,50	P3626R	122	99,00
N220SER	326	66,50	P3615W	136	149,50	P3626W	122	99,00
N220SZ2	326	42,50	P3615WWW	136	149,50	P3626WWW	122	99,00
N220RS1	326	42,50	P3615Y	136	149,50	P3626Y	122	99,00
N220TUR	326, 342	64,90	P3616B	136	207,50	P3627W	90	169,00
N255ARB	327	38,50	P3616G	136	207,50	P3628W	90	169,00
N255ARO	327	38,50	P3616R	136	207,50	P3630B	147	89,00
N255ARY	327	38,50	P3616W	136	207,50	P3630G	147	89,00
N255KRR	326, 342	49,70	P3616WWW	136	207,50	P3630R	147	89,00
N255KRS	337	49,70	P3616Y	136	207,50	P3630W	147	89,00
N255RS1	326	47,10	P3617B	137	207,50	P3630WWW	147	89,00
N255SER	326	69,90	P3617G	137	207,50	P3630Y	147	89,00
N255SZ2	326	47,10	P3617R	137	207,50	P3631B	147	139,00
N255TUR	326, 342	67,60	P3617W	137	207,50	P3631G	147	139,00
P2037W	126	69,00	P3617WWW	137	207,50	P3631R	147	139,00
P2037WWW	126	69,00	P3617Y	137	207,50	P3631W	147	139,00
P2269W	126	45,60	P3618B	137	253,40	P3631WWW	147	139,00
P2269WWW	126	45,60	P3618G	137	253,40	P3631Y	147	139,00
P3301W3	116	117,90	P3618R	137	253,40	P3643B	144	172,50
P3301W6	116	200,10	P3618W	137	253,40	P3643G	144	172,50
P3302W3	117	170,90	P3618WWW	137	253,40	P3643R	144	172,50
P3302W6	117	301,80	P3618Y	137	253,40	P3643W	144	172,50
P3601B	134	114,60	P3620B	140	126,10	P3643WWW	144	172,50
P3601G	134	114,60	P3620G	140	126,10	P3643Y	144	172,50
P3601R	134	114,60	P3620R	140	126,10	P3645B	122	91,40
P3601W	134	114,60	P3620W	140	126,10	P3645G	122	91,40
P3601WWW	134	114,60	P3620WWW	140	126,10	P3645R	122	91,40
P3601Y	134	114,60	P3620Y	140	126,10	P3645W	122	91,40

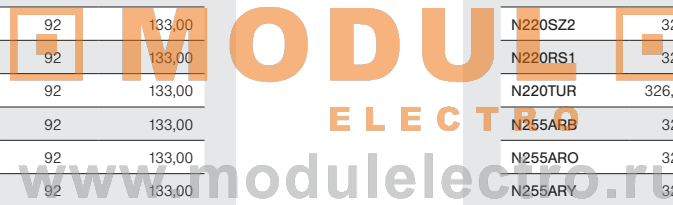

Inhaltsverzeichnis | index

Art.-Nr. art.-no.	Seite page	Preis price	Art.-Nr. art.-no.	Seite page	Preis price	Art.-Nr. art.-no.	Seite page	Preis price
P3645WW	122	91,40	P3674WW	138	84,00	P3732Y	135	62,00
P3645Y	122	91,40	P3677B	144	198,00	P3801B	165	139,50
P3647W	120	46,40	P3677W	144	198,00	P3801G	165	139,50
P3648W	121	46,40	P3680NW	114	36,80	P3801R	165	139,50
P3649W	120	67,00	P3681NW	114	38,90	P3801W	165	139,50
P3650B	110	67,10	P3682NW	115	41,00	P3801WW	165	139,50
P3650G	110	67,10	P3683NW	115	43,10	P3801Y	165	139,50
P3650R	110	67,10	P3718B	118	42,00	P3802B	171, 390	188,00
P3650W	110	67,10	P3718G	118	42,00	P3802G	171, 390	188,00
P3650WW	110	67,10	P3718R	118	42,00	P3802R	171, 390	188,00
P3650Y	110	67,10	P3718W	118	42,00	P3802W	171, 390	188,00
P3651B	110	67,10	P3718WW	118	42,00	P3802WW	171	188,00
P3651G	110	67,10	P3718Y	118	42,00	P3802Y	171, 390	188,00
P3651R	110	67,10	P3719B	118	46,00	P3803B	165	139,50
P3651W	110	67,10	P3719G	118	46,00	P3803G	165	139,50
P3651WW	110	67,10	P3719R	118	46,00	P3803R	165	139,50
P3651Y	110	67,10	P3719W	118	46,00	P3803W	165	139,50
P3653B	108	28,40	P3719WW	118	46,00	P3803WW	165	139,50
P3653G	108	28,40	P3719Y	118	46,00	P3803Y	165	139,50
P3653R	108	28,40	P3721B	119	46,00	P3804B	171, 390	188,00
P3653W	108	28,40	P3721G	119	46,00	P3804G	171, 390	188,00
P3653WW	108	28,40	P3721R	119	46,00	P3804R	171, 390	188,00
P3653Y	108	28,40	P3721W	119	46,00	P3804W	171, 390	188,00
P3654B	109	28,40	P3721WW	119	46,00	P3804WW	171	188,00
P3654G	109	28,40	P3721Y	119	46,00	P3804Y	171, 390	188,00
P3654R	109	28,40	P3729B	133	51,40	P3807B	167	96,30
P3654W	109	28,40	P3729G	133	51,40	P3807G	167	96,30
P3654WW	109	28,40	P3729R	133	51,40	P3807R	167	96,30
P3654Y	109	28,40	P3729W	133	51,40	P3807W	167	96,30
P3659B	109	68,30	P3729WW	133	51,40	P3807WW	167	96,30
P3659G	109	68,30	P3729Y	133	51,40	P3807Y	167	96,30
P3659R	109	68,30	P3730B	133	62,00	P3816B	164	99,80
P3659W	109	68,30	P3730G	133	62,00	P3816G	164	99,80
P3659WW	109	68,30	P3730R	133	62,00	P3816R	164	99,80
P3659Y	109	68,30	P3730W	133	62,00	P3816W	164	99,80
P3669B	119	47,70	P3730WW	133	62,00	P3816WW	164	99,80
P3669G	119	47,70	P3730Y	133	62,00	P3816Y	164	99,80
P3669R	119	47,70	P3732B	135	62,00	P3817B	164	99,80
P3669W	119	47,70	P3732G	135	62,00	P3817G	164	99,80
P3669WW	119	47,70	P3732R	135	62,00	P3817R	164	99,80
P3669Y	119	47,70	P3732W	135	62,00	P3817W	164	99,80
P3673WW	138	72,00	P3732WW	135	62,00	P3817WW	164	99,80

Inhaltsverzeichnis | index

Art.-Nr. art.-no.	Seite page	Preis price	Art.-Nr. art.-no.	Seite page	Preis price	Art.-Nr. art.-no.	Seite page	Preis price
P3817Y	164	99,80	P3930G	129	104,00	R0065W4	85	71,10
P3825B	170	176,00	P3930R	129	104,00	R0065W6	85	71,10
P3825G	170	176,00	P3930W	129	104,00	R0065WW2	85	71,10
P3825R	170	176,00	P3930WW	129	104,00	R0065WW4	85	71,10
P3825W	170	176,00	P3930Y	129	104,00	R0065WW6	85	71,10
P3825WW	170	176,00	P3937B	129	104,00	R2671NW2	85	95,30
P3825Y	170	176,00	P3937G	129	104,00	R2671NW4	85	95,30
P3826B	170	176,00	P3937R	129	104,00	R2671NW6	85	95,30
P3826G	170	176,00	P3937W	129	104,00	R2671W2	85	95,30
P3826R	170	176,00	P3937WW	129	104,00	R2671W4	85	95,30
P3826W	170	176,00	P3937Y	129	104,00	R2671W6	85	95,30
P3826WW	170	176,00	P3938B	130	114,60	R2671WW2	85	95,30
P3826Y	170	176,00	P3938G	130	114,60	R2671WW4	85	95,30
P3834NW	112	82,00	P3938R	130	114,60	R2671WW6	85	95,30
P3835NW	112	84,00	P3938W	130	114,60	R3000NW4	81	89,00
P3859B	173	486,00	P3938WW	130	114,60	R3000W4	81	89,00
P3859G	173	486,00	P3938Y	130	114,60	R3000WW4	81	89,00
P3859R	173	486,00	P3939B	130	114,60	R3001NW2	89	98,00
P3859RGB	200	468,00	P3939G	130	114,60	R3001NW4	89	98,00
P3859W	173	486,00	P3939R	130	114,60	R3001NW6	89	98,00
P3859WW	173	486,00	P3939W	130	114,60	R3001W2	89	98,00
P3859Y	173	486,00	P3939WW	130	114,60	R3001W4	89	98,00
P3860B	173	498,00	P3939Y	130	114,60	R3001W6	89	98,00
P3860G	173	498,00	P3962B	145	184,00	R3001WW2	89	98,00
P3860R	173	498,00	P3962G	145	184,00	R3001WW4	89	98,00
P3860RGB	202	498,00	P3962R	145	184,00	R3001WW6	89	98,00
P3860W	173	498,00	P3962W	145	184,00	R3004NW2	87	93,00
P3860WW	173	498,00	P3962WW	145	184,00	R3004NW4	87	93,00
P3860Y	173	498,00	P3962Y	145	184,00	R3004NW6	87	93,00
P3863NW	168	174,10	R0063NW2	85	70,10	R3004W2	87	93,00
P3863W	168	174,10	R0063NW4	85	70,10	R3004W4	87	93,00
P3863WW	168	174,10	R0063NW6	85	70,10	R3004W6	87	93,00
P3864NW	168	174,10	R0063W2	85	70,10	R3004WW2	87	93,00
P3864W	168	174,10	R0063W4	85	70,10	R3004WW4	87	93,00
P3864WW	168	174,10	R0063W6	85	70,10	R3004WW6	87	93,00
P3867NW	169	174,10	R0063WW2	85	70,10	R3005NW2	85	78,30
P3867W	169	174,10	R0063WW4	85	70,10	R3005NW4	85	78,30
P3867WW	169	174,10	R0063WW6	85	70,10	R3005NW6	85	78,30
P3868NW	169	184,40	R0065NW2	85	71,10	R3005W2	85	78,30
P3868W	169	184,40	R0065NW4	85	71,10	R3005W4	85	78,30
P3868WW	169	184,40	R0065NW6	85	71,10	R3005W6	85	78,30
P3930B	129	104,00	R0065W2	85	71,10	R3005WW2	85	78,30

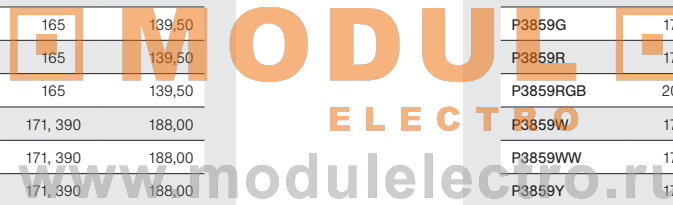

Inhaltsverzeichnis | index

Art.-Nr. art.-no.	Seite page	Preis price	Art.-Nr. art.-no.	Seite page	Preis price	Art.-Nr. art.-no.	Seite page	Preis price
R3005WW4	85	78,30	R3020WW4	94	122,60	R3704NW4	86	69,90
R3005WW6	85	78,30	R3020WW6	94	122,60	R3704NW6	86	69,90
R3006NW1	97	229,00	R3021NW2	94	128,80	R3704W2	86	69,90
R3006NW3	97	229,00	R3021NW4	94	128,80	R3704W4	86	69,90
R3006W1	97	229,00	R3021NW6	94	128,80	R3704W6	86	69,90
R3006W3	97	229,00	R3021W2	94	128,80	R3704WW2	86	69,90
R3006WW1	97	229,00	R3021W4	94	128,80	R3704WW4	86	69,90
R3006WW3	97	229,00	R3021W6	94	128,80	R3704WW6	86	69,90
R3008NW2	95	99,00	R3021WW2	94	128,80	R3705NW2	84	55,70
R3008NW4	95	99,00	R3021WW4	94	128,80	R3705NW4	84	55,70
R3008W2	95	99,00	R3021WW6	94	128,80	R3705NW6	84	55,70
R3008W4	95	99,00	R3025NW2	102	204,00	R3705W2	84	55,70
R3008WW2	95	99,00	R3025NW4	102	204,00	R3705W4	84	55,70
R3008WW4	95	99,00	R3025NW6	102	204,00	R3705W6	84	55,70
R3009NW2	95	229,00	R3025W2	102	204,00	R3705WW2	84	55,70
R3009NW4	95	229,00	R3025W4	102	204,00	R3705WW4	84	55,70
R3009W2	95	229,00	R3025W6	102	204,00	R3705WW6	84	55,70
R3009W4	95	229,00	R3025WW2	102	204,00	R3706NW1	96	199,00
R3009WW2	95	229,00	R3025WW4	102	204,00	R3706NW3	96	199,00
R3009WW4	95	229,00	R3025WW6	102	204,00	R3706W1	96	199,00
R3010NW1	97	249,00	R3026NW	102	184,40	R3706W3	96	199,00
R3010NW3	97	249,00	R3026W	102	184,40	R3706WW1	96	199,00
R3010W1	97	249,00	R3026WW	102	184,40	R3706WW3	96	199,00
R3010W3	97	249,00	R3027NW4	107	222,00	R3711NW4	82	75,00
R3010WW1	97	249,00	R3027W4	107	222,00	R3711W4	82	75,00
R3010WW3	97	249,00	R3027WW4	107	222,00	R3711WW4	82	75,00
R3011NW4	83	95,00	R3037NW4	107	249,00	R3713NW	142	194,70
R3011W4	83	95,00	R3037W4	107	249,00	R3713W	142	194,70
R3011WW4	83	95,00	R3037WW4	107	249,00	R3713WW	142	194,70
R3012NW	101	309,00	R3700NW4	80	69,00	R3714NW	142	204,00
R3012W	101	309,00	R3700W4	80	69,00	R3714W	142	204,00
R3012WW	101	309,00	R3700WW4	80	69,00	R3714WW	142	204,00
R3013NW	101	309,00	R3701NW2	88	75,00	R3715NW	143	174,10
R3013W	101	309,00	R3701NW4	88	75,00	R3715W	143	174,10
R3013WW	101	309,00	R3701NW6	88	75,00	R3715WW	143	174,10
R3020NW2	94	122,60	R3701W2	88	75,00	R3716NW	143	194,70
R3020NW4	94	122,60	R3701W4	88	75,00	R3716W	143	194,70
R3020NW6	94	122,60	R3701W6	88	75,00	R3716WW	143	194,70
R3020W2	94	122,60	R3701WW2	88	75,00	R3825NW	172, 391	188,00
R3020W4	94	122,60	R3701WW4	88	75,00	R3825W	172	188,00
R3020W6	94	122,60	R3701WW6	88	75,00	R3825WW	172	188,00
R3020WW2	94	122,60	R3704NW2	86	69,90	R3826NW	172, 391	188,00

Inhaltsverzeichnis | index

Art.-Nr. art.-no.	Seite page	Preis price	Art.-Nr. art.-no.	Seite page	Preis price	Art.-Nr. art.-no.	Seite page	Preis price
R3826W	172	188,00	R3929WW	132	109,00	R6304WW4	87	83,90
R3826WW	172	188,00	R3929Y	132	109,00	R6304WW6	87	83,90
R3833NW3	182	328,00	R3940B	128	95,00	R6501NW2	89	90,00
R3833NW6	183	298,00	R3940G	128	95,00	R6501NW4	89	90,00
R3833W3	182	328,00	R3940R	128	95,00	R6501NW6	89	90,00
R3833W6	183	298,00	R3940W	128	95,00	R6501W2	89	90,00
R3833WW3	182	328,00	R3940WW	128	95,00	R6501W4	89	90,00
R3833WW6	183	298,00	R3940Y	128	95,00	R6501W6	89	90,00
R3834NW3	182	558,00	R3941B	128	95,00	R6501WW2	89	90,00
R3834NW6	183	508,00	R3941G	128	95,00	R6501WW4	89	90,00
R3834W3	182	558,00	R3941R	128	95,00	R6501WW6	89	90,00
R3834W6	183	508,00	R3941W	128	95,00	R6504NW2	87	84,90
R3834WW3	182	558,00	R3941WW	128	95,00	R6504NW4	87	84,90
R3834WW6	183	508,00	R3941Y	128	95,00	R6504NW6	87	84,90
R3861B	166	112,30	R3950B	131	109,00	R6504W2	87	84,90
R3861G	166	112,30	R3950G	131	109,00	R6504W4	87	84,90
R3861R	166	112,30	R3950R	131	109,00	R6504W6	87	84,90
R3861W	166	112,30	R3950W	131	109,00	R6504WW2	87	84,90
R3861WW	166	112,30	R3950WW	131	109,00	R6504WW4	87	84,90
R3861Y	166	112,30	R3950Y	131	109,00	R6504WW6	87	84,90
R3862B	166	112,30	R3952B	131	149,00	R6700NW4	81	82,50
R3862G	166	112,30	R3952G	131	149,00	R6700W4	81	82,50
R3862R	166	112,30	R3952R	131	149,00	R6700WW4	81	82,50
R3862W	166	112,30	R3952W	131	149,00	R6711NW4	83	88,50
R3862WW	166	112,30	R3952WW	131	149,00	R6711W4	83	88,50
R3862Y	166	112,30	R3952Y	131	149,00	R6711WW4	83	88,50
R3870NW	184	498,00	R6301NW2	89	89,00	R6800NW4	81	84,50
R3870W	184	498,00	R6301NW4	89	89,00	R6800W4	81	84,50
R3870WW	184	498,00	R6301NW6	89	89,00	R6800WW4	81	84,50
R3871NW	184	798,00	R6301W2	89	89,00	R6811NW4	83	90,50
R3871W	184	798,00	R6301W4	89	89,00	R6811W4	83	90,50
R3871WW	184	798,00	R6301W6	89	89,00	R6811WW4	83	90,50
R3928B	132	89,00	R6301WW2	89	89,00	R7100NW4	81	95,00
R3928G	132	89,00	R6301WW4	89	89,00	R7100W4	81	95,00
R3928R	132	89,00	R6301WW6	89	89,00	R7100WW4	81	95,00
R3928W	132	89,00	R6304NW2	87	83,90	R7101NW2	89	99,00
R3928WW	132	89,00	R6304NW4	87	83,90	R7101NW4	89	99,00
R3928Y	132	89,00	R6304NW6	87	83,90	R7101NW6	89	99,00
R3929B	132	109,00	R6304W2	87	83,90	R7101W2	89	99,00
R3929G	132	109,00	R6304W4	87	83,90	R7101W4	89	99,00
R3929R	132	109,00	R6304W6	87	83,90	R7101W6	89	99,00
R3929W	132	109,00	R6304WW2	87	83,90	R7101WW2	89	99,00

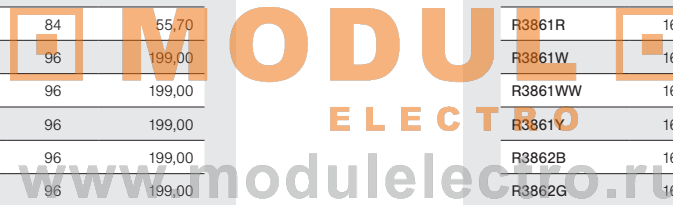

Inhaltsverzeichnis | index

Art.-Nr. art.-no.	Seite page	Preis price
R7101WW4	89	99,00
R7101WW6	89	99,00
R7104NW2	87	96,00
R7104NW4	87	96,00
R7104NW6	87	96,00
R7104W2	87	96,00
R7104W4	87	96,00
R7104W6	87	96,00
R7104WW2	87	96,00
R7104WW4	87	96,00
R7104WW6	87	96,00
R7111NW4	83	104,00
R7111W4	83	104,00
R7111WW4	83	104,00
SL100WW	43	39,00
SL300WW	42	96,00
SL3517	38, 39, 40, 447	98,00
SL3518	38, 39, 40, 447	138,00
SL501WW4	38	179,00
SL503WW4	39	189,00
SL505WW4	38	179,00
SL506WW4	39	189,00
SL507WW4	38	179,00
SL508WW4	39	189,00
SL600WW4	40	219,00
W185RK1	337	41,90
W185RS1	342	37,90
W185SK2	337	37,90
W185SZ2	342	37,90
W215RK1	337	44,10
W215SK2	337	42,50
W220RS1	342	42,50
W220SZ2	342	42,50
W255RK1	337	49,90
W255RS1	342	47,10
W255SK2	337	47,10
W255SZ2	342	47,10

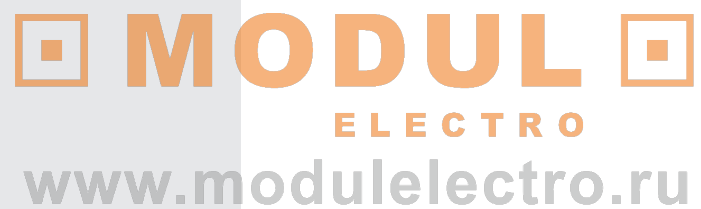

Allgemeine Verkaufsbedingungen
General Terms of Sale

Allgemeine Verkaufsbedingungen

Allgemeine Verkaufsbedingungen der Brumberg Leuchten GmbH & Co. KG

§ 1 Allgemeines, Geltungsbereich

1. Unsere Verkaufsbedingungen gelten ausschließlich; entgegenstehende oder von unseren Verkaufsbedingungen abweichende Bedingungen des Bestellers erkennen wir nicht an, es sei denn, wir hätten ausdrücklich schriftlich ihrer Geltung zugestimmt. Unsere Verkaufsbedingungen gelten auch dann, wenn wir in Kenntnis entgegenstehender oder von unseren Verkaufsbedingungen abweichender Bedingungen des Bestellers die Lieferung an den Besteller vorbehaltlos ausführen.

2. Maßgeblich für den Inhalt und den Umfang von Lieferungen und Leistungen ist unser schriftliches Angebot und wenn wir eine Auftragsbestätigung erteilen, unsere schriftliche Auftragsbestätigung.

3. Unsere Verkaufsbedingungen gelten nur gegenüber Kaufleuten im Rechtssinne sowie juristischen Personen des öffentlichen Rechts und öffentlich-rechtlichen Sondervermögen.

4. Unsere Verkaufsbedingungen gelten auch für alle künftigen Geschäfte mit dem Besteller. Nachstehende Geschäftsbedingungen haben Vorrang vor inhaltlich abweichenden Bedingungen des Bestellers. Der Verzicht des Bestellers auf die Geltung eventuell eigener Geschäftsbedingungen wird auch nicht durch unser Schweigen oder unsere Leistung bestätigt. Eine Abweichung von den nachstehenden Bedingungen bedarf im Einzelfall unserer schriftlichen Bestätigung.

5. Alle technischen Daten unserer Kataloge und sonstigen Verkaufsunterlagen, Listen und Zeichnungen sowie Gewichts-, Maß- und Mischungsangaben sind sorgfältig erstellt, bei Irrtümern bleiben nachträglich Korrekturen vorbehalten.

6. Es liegt im Verantwortungsbereich des Bestellers zu prüfen, ob unser Produkt für den von ihm vorgegebenen Zweck geeignet ist.

§ 2 Angebot, Angebotsunterlagen

1. Ist die Bestellung als Angebot gem. § 145 BGB zu qualifizieren, so können wir dieses innerhalb von 4 Wochen annehmen.

2. An Abbildungen, Zeichnungen, Kalkulationen und sonstigen Unterlagen behalten wir uns Eigentums- und Urheberrechte vor; sie dürfen Dritten nicht zugänglich gemacht werden. Dies gilt insbesondere für solche

schriftlichen Unterlagen, die als „vertraulich“ bezeichnet sind; vor ihrer Weitergabe an Dritte bedarf der Besteller unserer ausdrücklichen schriftlichen Zustimmung. Angebote haben Gültigkeit nur in schriftlicher Form. Die genannten Preise gelten unter dem Vorbehalt, dass die der Angebotsabgabe zugrunde gelegten Auftragsdaten unverändert bleiben.

3. Erstmuster und Erstmusterprüfberichte fertigen wir nur nach ausdrücklicher schriftlicher Vereinbarung gegen Berechnung nach Aufwand an.

4. Produkte, die uns nach Zeichnung oder Mustern vom Besteller in Auftrag gegeben werden, unterliegen der Verpflichtung des Bestellers eventuelle Schutzrechte Dritter zu prüfen und nicht zu verletzen. Wird uns bei Nichtbeachtung dieser Verpflichtung von einem Dritten unter Berufung auf ein ihm gehörendes Schutzrecht eine Fertigung untersagt oder kann das Produkt wegen Verletzung des Schutzrechtes nicht verwandt werden sind wir berechtigt - ohne die Rechtslage zu prüfen und unter Ausschluss aller Schadensersatzansprüche des Bestellers gleich aus welchem Rechtsgrund -, Herstellung und Lieferung bis zur Klärung des Sachverhaltes einzustellen und vom Besteller Schadensersatz zu verlangen, mindestens in Höhe von 15 % des Rechnungswertes für das bestellte Produkt. Der Besteller stellt uns bereits jetzt von Schadensersatz- und sonstigen Ersatzansprüchen Dritter, insbesondere von Rechtsinhabern, auf erstes Anfordern frei. Zum Umfang des Schadens gehören auch solche Kosten, die uns durch die Abwehr von Ansprüchen Dritter entstehen.

§ 3 Preise - Zahlungsbedingungen

1. Sofern sich aus der Auftragsbestätigung nichts anderes ergibt, gelten unsere Preise als Euro-Nettopreise „ab Werk“ einschließlich für unsere Produkte von uns üblicherweise verwandte Verpackung zuzüglich am Tag der Lieferung geltenden Mehrwertsteuer. Gewünschte Spezialverpackungen oder Umverpackungen oder spezielle Kleinverpackungen werden dem Besteller berechnet. Die Preise gelten jeweils nur für die vertraglich vereinbarte Menge und Ausführung. Werden vom Besteller Änderungen gewünscht, die eine höhere Bearbeitung erfordern als nach dem Vertrag oder dem üblichen Produktionsverfahren zugrunde gelegt, so bleibt eine angemessene Änderung der Preise vorbehalten. Wir behalten uns das Recht vor, unsere Preise zu erhöhen, wenn nach Abschluss des Vertrages, insbesondere aufgrund von Tarifabschlüssen, Materialpreissteigerungen, insbesondere Rohstoffpreissteigerungen, oder Energiekostensteigerungen eintreten.

2. Die gesetzliche Mehrwertsteuer ist in unseren Preisen nicht eingeschlossen; sie wird in gesetzlicher Höhe am Tage der Rechnungsstellung in der Rechnung gesondert ausgewiesen.

3. Der Abzug von Skonto bedarf eines besonderen schriftlichen Ausweises in der Auftragsbestätigung oder Rechnung.

4. Sofern sich aus der Auftragsbestätigung nichts anderes ergibt, ist der Kaufpreis (ohne Abzug) frei Zahlstelle zu leisten und innerhalb von 10 Tagen ohne Abzug fällig.

Kommt der Besteller in Zahlungsverzug, so sind wir berechtigt, Verzugszinsen in Höhe von 8 % über dem gesetzlichen Basiszinssatz p.a. zu fordern. Falls wir in der Lage sind, einen höheren Verzugschaden nachzuweisen, sind wir berechtigt, diesen geltend zu machen. Der Besteller ist jedoch berechtigt uns nachzuweisen, dass uns als Folge des Zahlungsverzuges kein oder ein wesentlich geringerer Schaden entstanden ist.

5. Aufrechnungsrechte stehen dem Besteller nur zu, wenn seine Gegenansprüche rechtskräftig festgestellt, unbestritten oder von uns anerkannt sind. Wegen bestrittener Gegenansprüche steht dem Besteller auch kein Zurückbehaltungsrecht zu. Die Geltendmachung des Zurückbehaltungsrechtes ist auch insoweit ausgeschlossen, als die Ansprüche nicht auf demselben Vertragsverhältnis beruhen. Gutschriften werden ausdrücklich zum Zwecke der Verrechnung erteilt. Ein Anspruch auf Auszahlung besteht nicht.

6. Bei Zweifeln an der Zahlungsfähigkeit des Bestellers behalten wir uns vor, Vorauszahlungen oder Sicherheitsleistungen zu verlangen. Wird uns bekannt, dass beim Besteller fruchtlos gepfändet worden ist oder erhalten wir Hinweise auf den Vermögensverfall des Bestellers, so sind wir berechtigt unter Anrechnung der gemachten Aufwendungen vom Vertrag zurückzutreten.

§ 4 Lieferzeit und Lieferbedingungen

1. Der Beginn der von uns angegebenen oder mit uns vereinbarten Lieferzeit setzt die Abklärung aller technischen Fragen, vom Besteller zu liefernden Unterlagen, erforderlichen Genehmigungen und Freigaben, insbesondere von Plänen, sowie die Einhaltung der vereinbarten Zahlungsbedingungen und die Erfüllung der sonstigen Mitwirkungshandlungen durch den Besteller voraus.

2. Die Einhaltung unserer Lieferverpflichtung setzt weiter die rechtzeitige und ordnungsgemäße Erfüllung der Verpflichtung des Bestellers voraus sowie unsere ordnungsgemäße

Allgemeine Verkaufsbedingungen

Belieferung mit den für die Herstellung des Lieferproduktes erforderlichen Rohstoffen. Die Einrede des nicht erfüllten Vertrages bleibt vorbehalten.

3. Beruht die Nichteinhaltung von Lieferfristen auf höherer Gewalt, z. B. Streik, Aussperrung, etc. so verlängern sich die Fristen angemessen. Eine solche angemessene Verlängerung der Lieferfristen tritt auch ein, wenn wir nicht rechtzeitig beliefert werden.

4. Kommt der Besteller in Annahmeverzug oder verletzt er schuldhaft sonstige Mitwirkungspflichten, so sind wir berechtigt, den uns insoweit entstandenen Schaden einschließlich etwaiger Mehraufwendungen ersetzt zu verlangen. Weitere Ansprüche bleiben vorbehalten. Wird die Anlieferung, der Versand oder die Zustellung auf Wunsch des Bestellers verschoben, so können wir 10 Tage nach Anzeige der Versandbereitschaft der Waren durch uns ein Lagergeld in Höhe von 0,5 % des Rechnungsbetrages für jeden angefangenen Monat, maximal jedoch 5 % des Rechnungsbetrages dem Besteller in Rechnung stellen. Der Nachweis über höhere oder niedrigere Aufwendungen bleibt beiden Vertragsparteien vorbehalten.

5. Sofern die Voraussetzungen in Absatz 3. vorliegen, geht die Gefahr eines zufälligen Untergangs oder einer zufälligen Verschlechterung der Kaufsache in dem Zeitpunkt auf den Besteller über, in dem dieser in Annahmeverzug geraten ist.

6. Wir haften nach den gesetzlichen Bestimmungen, soweit der zugrunde liegende Kaufvertrag ein Fixgeschäft im Sinne von § 286 Abs. 2 Nr. 4 BGB oder von § 376 HGB ist. Wir haften auch nach den gesetzlichen Bestimmungen, sofern als Folge eines von uns zu vertretenden Lieferverzuges der Besteller berechtigt ist, geltend zu machen, dass sein Interesse an der weiteren Vertragserfüllung in Fortfall geraten ist.

7. Wir haften ferner nach den gesetzlichen Bestimmungen, sofern der Lieferverzug auf einer von uns zu vertretenden vorsätzlichen oder grob fahrlässigen Vertragsverletzung beruht; ein Verschulden unserer Vertreter oder Erfüllungsgehilfen ist uns zuzurechnen. Sofern der Lieferverzug nicht auf einer von uns zu vertretenden vorsätzlichen Vertragsverletzung beruht, ist unsere Schadensersatzhaftung auf den vorhersehbaren, typischerweise eintretenden Schaden begrenzt.

8. Wir haften auch nach den gesetzlichen Bestimmungen, soweit der von uns zu vertretende Lieferverzug auf schuldhafter Verletzung einer wesentlichen Vertragspflicht beruht; in diesem Fall ist aber die Schadensersatzhaftung

auf den vorhersehbaren, typischerweise eingetretenen Schaden begrenzt.

9. Wir sind zu Teillieferungen in zumutbarem Umfang berechtigt. Abweichungen hinsichtlich der Abmessungen, des Gewichtes, der technischen Gestaltung, der Herstellung und des Umfanges der zu liefernden Ware sind innerhalb der handelsüblichen produktspezifischen Toleranzen zulässig. Als vom Hersteller genehmigt gelten darüber hinaus Änderungen, die der technischen Verbesserung unserer Produkte dienen.

§ 5 Gefahrübergang - Verpackungskosten

1. Sofern sich aus der Auftragsbestätigung nichts anderes ergibt, ist Lieferung „ab Werk“ vereinbart.

2. Für die Rücknahme von Verpackungen gelten besondere Vereinbarungen.

3. Soweit der Besteller es wünscht, werden wir die Lieferung durch eine Transportversicherung eindecken; die insoweit anfallenden Kosten trägt der Besteller.

4. Der Besteller ist verpflichtet in angemessener Frist vor Lieferung der Ware ein oder mehrere Personen namentlich zu benennen, die zur Entgegennahme der Ware und der Begleitpapiere und Unterzeichnung der Lieferpapiere und Begleitpapiere durch den Besteller bevollmächtigt sind. Dies gilt insbesondere, wenn die Ware an einen anderen Ort als den Sitz des Bestellers geliefert werden soll. Werden derartige Angaben nicht gemacht, gelten diejenigen Personen, die die Ware tatsächlich entgegengenommen haben, als zur Entgegennahme der Ware berechtigt und zur Zeichnung der Übergabepapiere (Lieferschein und sonstige Begleitpapiere) als bevollmächtigt.

5. Ist keine vom Besteller bezeichnete Person zum vereinbarten Termin an dem vorgegebenen Ort anwesend oder ist diese Person oder andere Personen zur Annahme der Ware nicht bereit, tritt der Besteller in Annahmeverzug mit der Folge, dass die Gefahr auf ihn übergeht. Ferner hat er die Mehrkosten zu tragen die dadurch entstehen, dass eine erneute Anlieferung erfolgt.

6. Der Besteller kann die Entgegennahme von Lieferungen wegen unerheblicher Mängel nicht verweigern.

§ 6 Mängelhaftung

1. Mängelrechte des Bestellers setzen voraus, dass dieser seinen nach § 377 HGB

geschuldeten Untersuchungs- und Rügeobliegenheiten ordnungsgemäß nachgekommen ist.

2. Soweit ein Mangel der Kaufsache vorliegt, sind wir nach unserer Wahl zur Nacherfüllung in Form einer Mängelbeseitigung oder zur Lieferung einer neuen mangelfreien Sache berechtigt. Im Fall der Mängelbeseitigung tragen wir die Aufwendungen nur bis zur Höhe des Kaufpreises.

3. Schlägt die Nacherfüllung fehl, so ist der Besteller nach seiner Wahl berechtigt, Rücktritt oder Minderung zu verlangen.

4. Wir haften nach den gesetzlichen Bestimmungen, sofern der Besteller Schadensersatzansprüche geltend macht, die auf Vorsatz oder grober Fahrlässigkeit unserer Vertreter oder Erfüllungsgehilfen beruhen. Soweit uns keine vorsätzliche Vertragsverletzung angelastet wird, ist die Schadensersatzhaftung auf den typischerweise eintretenden Schaden begrenzt.

5. Wir haften nach den gesetzlichen Bestimmungen, sofern wir schuldhaft eine wesentliche Vertragspflicht verletzen; in diesem Fall ist aber die Schadensersatzhaftung auf den vorhersehbaren, typischerweise eintretenden Schaden begrenzt.

6. Die Haftung wegen schuldhafter Verletzung des Lebens, des Körpers oder der Gesundheit bleibt unberührt; dies gilt auch für die zwingende Haftung nach dem Produkthaftungsgesetz.

7. Soweit nicht vorstehend etwas anderes geregelt ist, ist die Haftung ausgeschlossen.

8. Die Verjährungsfrist für Mängelansprüche beträgt 12 Monate, gerechnet ab Gefahrübergang.

§ 7 Gesamthaftung

1. Eine weitergehende Haftung auf Schadensersatz als in § 6 vorgesehen, ist - ohne Rücksicht auf die Rechtsnatur des geltend gemachten Anspruchs - ausgeschlossen. Dies gilt insbesondere für Schadensersatzansprüche auf Verschulden bei Vertragsabschluss, wegen sonstiger Pflichtverletzungen oder wegen deliktischer Ansprüche auf Ersatz von Sachschäden gemäß § 823 BGB.

2. Die Begrenzung nach Abs. 1. gilt auch, soweit der Besteller anstelle eines Anspruchs auf Ersatz des Schadens statt Leistung Ersatz nutzloser Aufwendungen verlangt.

3. Soweit die Schadenshaftung uns gegen-

BRUMBERG
LEUCHTEN
MODUL
ELECTRO
www.modulelectro.de

über ausgeschlossen oder eingeschränkt ist, gilt dies auch im Hinblick auf die persönliche Schadensersatzhaftung unserer Angestellten, Arbeitnehmer, Mitarbeiter, Vertreter und Erfüllungsgehilfen.

§ 8 Eigentumsvorbehaltssicherung

1. Wir behalten uns das Eigentum an der Kaufsache bis zum Eingang aller Zahlungen aus der Geschäftsverbindung mit dem Besteller vor. Soweit wir mit dem Besteller Bezahlung der Kaufschuld aufgrund des Scheck-Wechsel-Verfahrens vereinbaren, erstreckt sich der Vorbehalt auch auf die Einlösung des von uns akzeptierten Wechsels durch den Besteller und erlischt nicht durch Gutschrift des erhaltenen Schecks bei uns. Bei vertragswidrigem Verhalten des Bestellers, insbesondere bei Zahlungsverzug, sind wir berechtigt, die Kaufsache zurückzunehmen. In der Rücknahme der Kaufsache durch uns liegt ein Rücktritt vom Vertrag. Wir sind nach Rücknahme der Kaufsache zu deren Verwertung befugt, der Verwertungserlös ist auf die Verbindlichkeiten des Bestellers – abzüglich angemessener Verwertungskosten – anzurechnen.

2. Der Besteller ist verpflichtet, die Kaufsache pfleglich zu behandeln, insbesondere ist er verpflichtet, diese auf eigene Kosten gegen Feuer-, Wasser- und Diebstahlschäden ausreichend zum Neuwert zu versichern. Sofern Wartungs- und Inspektionsarbeiten erforderlich sind, muss der Besteller diese auf eigene Kosten rechtzeitig durchführen.

3. Bei Pfändungen oder sonstigen Eingriffen Dritter hat uns der Besteller unverzüglich schriftlich zu benachrichtigen, damit wir Klage gemäß § 771 ZPO erheben können. Soweit der Dritte nicht in der Lage ist, uns die gerichtlichen und außergerichtlichen Kosten einer Klage gemäß § 771 ZPO zu erstatten, haftet der Besteller für den uns entstandenen Ausfall.

4. Der Besteller ist berechtigt, die Kaufsache im ordentlichen Geschäftsgang weiter zu verkaufen; er tritt uns jedoch bereits jetzt alle Forderungen in Höhe des Faktura-Endbetrages (einschließlich Mehrwertsteuer) unserer Forderung ab, die ihm aus der Weiterveräußerung gegen seine Abnehmer oder Dritte erwachsen und zwar unabhängig davon, ob die Kaufsache ohne oder nach Verarbeitung weiter verkauft worden ist. Zur Einziehung dieser Forderung bleibt der Besteller auch nach Abtretung ermächtigt. Unsere Befugnis, die Forderung selbst einzuziehen, bleibt hiervon unberührt. Wir verpflichten uns jedoch, die Forderung nicht einzuziehen, solange der Besteller seinen Zahlungsverpflichtungen aus den vereinnahmten Erlösen nachkommt, nicht

in Zahlungsverzug gerät und insbesondere kein Antrag auf Eröffnung eines Vergleichs- oder Insolvenzverfahrens gestellt ist oder Zahlungseinstellung vorliegt. Ist aber dies der Fall, so können wir verlangen, dass der Besteller uns die abgetretenen Forderungen und deren Schuldner bekannt gibt, alle zum Einzug erforderlichen Angaben macht, die dazugehörigen Unterlagen aushändigt und den Schuldner (Dritten) die Abtretung mitteilt. Die von uns im Voraus abgetretene Forderung bezieht sich auch auf den anerkannten Saldo, sowie im Fall der Insolvenz des Abnehmers auf den dann vorhandenen kausalen Saldo.

5. Die Verarbeitung oder Umbildung der Kaufsache durch den Besteller wird stets für uns vorgenommen. Wird die Kaufsache mit anderen, uns nicht gehörenden Gegenständen verarbeitet, so erwerben wir das Eigentum an der neuen Sache im Verhältnis des Wertes der Kaufsache (Faktura-Endbetrag, einschließlich Mehrwertsteuer) zu den anderen verarbeiteten Gegenständen zur Zeit der Verarbeitung. Für die durch Verarbeitung entstehende Sache gilt im Übrigen das Gleiche wie für die unter Vorbehalt gelieferte Kaufsache.

6. Wird die Kaufsache mit anderen, uns nicht gehörenden Gegenständen untrennbar vermischt, so erwerben wir das Miteigentum an der neuen Sache im Verhältnis des Wertes der Kaufsache (Faktura-Endbetrag, einschließlich Mehrwertsteuer) zu den anderen vermischten Gegenständen zum Zeitpunkt der Vermischung. Erfolgt die Vermischung in der Weise, dass die Sache des Bestellers als Hauptsache anzusehen ist, so gilt als vereinbart, dass der Besteller uns anteilig Miteigentum überträgt. Der Besteller verwahrt das so entstandene Allein- oder Miteigentum für uns.

7. Der Besteller tritt uns auch die Forderungen zur Sicherung unserer Forderungen gegen ihn ab. Die durch die Verbindung der Kaufsache mit einem Grundstück gegen einen Dritten erwachsen.

8. Wir verpflichten uns, die uns zustehenden Sicherheiten auf Verlangen des Bestellers insoweit freizugeben, als der realisierbare Wert unserer Sicherheiten die zu sichernden Forderungen um mehr als 10 % übersteigt; die Auswahl der freizugebenden Sicherheiten obliegt uns.

§ 9 Schutzrechte

1. Texte, Bilder, Grafiken und Zeichnungen sowie deren Anordnung in unserem Verkaufsprospekt, bzw. in E-Mails, Multimediale Darstellungen etc. unterliegen dem Schutz des Urheberrechts und anderer Schutzgesetze, wie insbesondere auch dem Marken- und

Geschmacksmusterrecht. Die Inhalte dürfen nicht kopiert oder verändert werden. Eine Verbreitung oder Zugänglichmachung zu Dritten ist nur durch Übergabe unseres Prospektes erlaubt.

2. Ein eigener Abdruck oder eine Verwendung in elektronischen Medien etc. ist nur nach unserer vorherigen schriftlichen Zustimmung erlaubt. Eine weitergehende Nutzung als vorbenannt beschrieben ist unzulässig. Insbesondere ist es dem Kunden untersagt, Unterlizenzen zu erteilen und die benannten Leistungen und Werke zu vervielfältigen, zu vermieten oder sonst wie zu verwerten.

3. Der Kunde ist verpflichtet, uns unverzüglich davon in Kenntnis zu setzen, wenn Urheberrechte verletzt werden oder Ansprüche wegen Urheberrechtsverletzungen gegen ihn erhoben werden. In diesen Fällen sichern wir zu, bei der Rechtsverfolgung mitzuwirken und sämtliche Informationen zu geben, die für die Rechtsverfolgung notwendig sind.

§ 10 Gerichtsstand - Erfüllungsort

1. Sofern der Besteller Kaufmann ist, ist unser Geschäftssitz Gerichtsstand; wir sind jedoch berechtigt, den Besteller auch an seinem Wohnsitzgericht zu verklagen.

2. Es gilt ausschließlich das Recht der Bundesrepublik Deutschland; die Geltung des UN-Kaufrechts und zwischenstaatlicher Vereinbarungen ist ausgeschlossen.

3. Soweit in der Auftragsbestätigung nicht anders angegeben, ist das zuständige Gericht das Gericht am Hauptsitz der Brumberg Leuchten GmbH & Co. KG.

4. Die deutsche Version der Allgemeinen Geschäftsbedingungen ist die maßgebliche Fassung. Es hat bei Übersetzungen Vorrang vor der englischen Übersetzung und ist nach der deutschen Rechtsprechung gestaltet.

Sundern, im Juni 2010

Brumberg Leuchten GmbH & Co. KG General Terms of Sale

§ 1 General Terms, Scope

1. Our terms of sale apply exclusively, we do not accept a customer's terms of sale opposing or deviating from our terms, unless we have expressly and in writing accepted its applicability. Our terms of sale apply even if we unreservedly supply a customer in knowledge of his terms of sale opposing or deviating from ours.

2. Content and amount of deliveries and services are exclusively laid down in our written offer or, if we issue a confirmation of order, in our written confirmation of order.

3. Our terms of sale apply only to businessmen/businesswomen, artificial persons of public law and public special property.

4. Our terms of sale apply also for all future businesses with the customer. The following terms of sale have priority over the customer's terms when differing in content. The customer's renunciation of the applicability of his own terms of sale is not removed by our silence or our deliveries and services. Any exceptional deviations from the following terms require our confirmation in writing.

5. All technical data in our catalogues and in our other sales information, lists and drawings same as all weight-, measure- and compound-information have been carefully drawn up, they are subject to alterations in case of errors.

6. It lies within the customer's responsibility to test if our products are suitable for the purpose intended by him.

§ 2 Offer, Materials

1. If an order can be qualified as an offer according to § 145 BGB, we can accept it within 4 weeks.

2. The rights of ownership and copyright are reserved for any illustrations, drawings, calculations and other material; they must not be made available to third persons. This applies particularly to such written material labelled „confidential“; making these available to third persons requires our explicit written agree-

ment. Offers are valid only in writing. The prices named are valid with the reservation that the specifics of order, forming the basis of the offer, remain unchanged.

3. Samples and sample test reports are made only if agreed to in writing. The costs are charged.

4. For products ordered on the basis of the customer's drawings or samples, the customer is obliged to check possible third persons' copyrights and not to infringe these. If, in case of this obligation not being observed, our production is prohibited by a third person claiming his copyright or if the product cannot be used because of the infringement of copyrights, we are entitled - without having to verify the legal status and to the exclusion of any compensation for the customer, no matter what the legal status may be - to stop production and delivery until the facts have been clarified and to demand compensation from the customer, at least 15% of the total amount of the invoice of the product ordered. At this time already, the customer exempts us from any claims to compensation by third persons, particularly of owners of copyrights - at first demand. Any costs caused by the rejection of third persons' claims are also regarded as our damage.

§ 3 Prices, Terms of payment

1. As far as the confirmation of order does not say any other, our prices are net Euro prices ex works, including the usual packaging for our products, plus the VAT rate valid on the day of delivery. Special packaging or re-packaging or special small packages will be charged. Prices are valid only for the quantity, product design and material specifications agreed to by contract. Should the customer ask changes, which cause a higher effort than assumed on the basis of the order or on the basis of the usual process of production, appropriate changes of prices remain reserved.

We reserve the right to raise our prices after conclusion of the contract if material price cost increases occur, especially due to new wage rates, especially increased costs of raw material or energy.

2. The VAT is not included in our prices; the valid rate is added on the invoice.

3. Cash discount is possible only after agreed

to in writing in the the confirmation of order or the invoice.

4. As far as the confirmation of order does not say any other, the price is due in cash (without deduction) must be paid ex paying agent and due as follows within 10 days without deduction.

If the customer defaults in his payments, we are entitled to demand an interest of 8% above the legal basic interest rate p.a. If we are able to prove a bigger damage caused by the arrears, we are entitled to assert it. The customer on his side is entitled to prove that as a consequence of his arrears no or much lesser damage was caused.

5. The customer is entitled to offset his claims against our invoices only if his claims are legally valid, undisputed and acknowledged by us. While the customer's claims are disputed, he does not have a right of retention. A right of retention is also excluded when the claims do not base on the same contract.

Credit notes are issued only for the purpose of settlement. There is no claim for payment.

6. If we doubt the solvency of a customer we reserve the right to demand payment in advance or surety. If we come to know that the customer has been impounded unsuccessfully or if we receive hints about bankruptcy of the customer, we are entitled to rescind the contract and charge the efforts made so far.

§ 4 Delivery time and conditions of supply

1. Beginning of delivery as agreed requires the clarification of all technical questions, delivery of all necessary information from the customer, necessary licences and releases, especially drawings, as well as fulfilment of the agreed conditions of payment and any necessary cooperation from the customer.

2. The adherence to our delivery commitment furthermore requires the customer's timely and proper fulfilment of his obligations and our proper receipt of the raw materials which are required for the manufacturing of the product to be delivered. The plea of a non-fulfilment of contract remains reserved.

3. If the non-fulfilment of delivery times is due to force majeure, e.g. strike, lockout, etc., the delivery period will be extended appropriately. An appropriate extension of delivery times co-

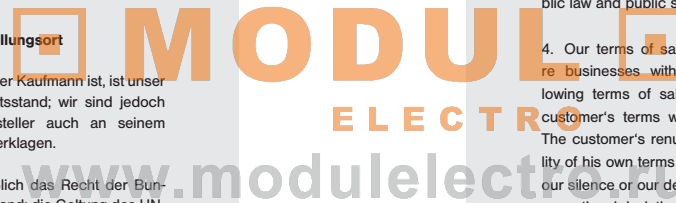

mes also in force when we are not supplied in time.

4. If the customer refuses deliveries or if he culpably violates other tasks of cooperation, we are entitled to demand compensation for damaged caused this way as well as any additional costs arising. Further claims remain reserved. If the delivery or shipment is postponed according to the customer's wish, we are entitled to invoice a fee for storing, beginning with the 10th day after the announcement of being ready for dispatch:

0,5% of the total sum invoiced for every beginning month

max 5% of the total sum invoiced.

Both contracting parties reserve the right to prove higher or lesser expenses.

5. If the conditions of section 3 are fulfilled, the danger of accidental decline or accidental deterioration passes on to the client in the moment when he defaults on acceptance of deliveries or on payment.

6. We accept liability according to legal regulations, as far as the relevant bill of sale constitutes a transaction of short selling in the sense of § 286 Abs. 2 Nr. 4 BGB or of § 376 HGB. We also accept liability according to legal regulations, if, as consequence of a delay in deliveries caused by us, the client becomes entitled to Claim that his interest in the contract ceases to exist.

7. We furthermore accept liability according to legal regulations, if the delay in delivery is caused by a deliberate or culpably negligent breach of contract by us; faults of our representatives are to be blamed on us. As far as a delay in delivery is not due to a deliberate breach of contract by us, our liability for compensation is limited to the foreseeable, typically occurring damage.

8. We also accept liability according to legal regulations, as far as the delay in delivery is caused by a culpable breach of an essential duty of the contract by us; in this case, however, the liability to compensation is limited to the foreseeable, typically occurring damage.

9. We are entitled to partial deliveries in reasonable quantities. Deviations in measurement, weight, technical construction, production and in quantity are allowed within the customary, product-related tolerances. Furthermore, all alterations, which serve the technical improvement of our products are regarded as approved by the customer.

§ 5

Transition of risks - costs of packaging

1. As far as the confirmation of order does not say any other, delivery is ex works.

2. Taking back of packaging is subject to special agreements.

3. Subject to the customer's wish, all deliveries will be covered by a transport insurance; the costs thus incurred are to be covered by the customer.

4. The customer is obliged, within an appropriate period prior to delivery, to name one or several persons, who are entitled by the customer to receive the goods and the accompanying documents and to sign the delivery note and the accompanying documents. This is particularly valid if the goods are to be delivered to another place than the customer's head Office. If such information is not given, those persons who have in fact received the goods are regarded to be entitled to the reception of the goods and to be authorized to sign the accompanying documents (delivery note and other accompanying documents).

5. If at the agreed delivery date and delivery place none of the authorized persons is available, or if this or another person refuses to accept the goods, the customer falls into arrears with receipt, with the consequence that the risk passes to the customer. Furthermore, the customer has to cover the costs incurred by a new delivery.

6. The customer cannot refuse the acceptance of deliveries because of minor faults.

§ 6

Liability for faulty goods

1. The customer's rights to complaint require that the customer has properly fulfilled his obligation to examination and reprimand according to § 377 HGB.

2. If the supplied goods are faulty, we are entitled to either after-fulfilment by eliminating the faults or to deliver new goods free of faults, according to our preference. In case of eliminations of faults, we cover the costs only up to the amount of the purchase price.

3. If the elimination of faults goes wrong, the customer is entitled to decide whether to claim a right of rescission or a reduced purchase

price.

4. We accept liability according to legal regulations, as far as the customer raises claims to compensation, which are founded on intent or culpable negligence, including intent or culpable negligence by our representatives. As far as we are not accused of culpable breach of contract, the liability for faulty goods is limited to the foreseeable, typically occurring damage.

5. We accept liability according to legal regulations, if we culpably break an essential duty of the contract; in this case however, the liability for faulty goods is limited to the foreseeable, typically occurring damage.

6. Liability for culpable injuring of life, body or health is unaffected; this applies also to the binding liability according to the law of product liability.

7. As far as nothing has been settled previously, liability is excluded.

8. The statutory limitation is 12 months, counted from the moment of transition of risks.

§ 7

Joint liability

1. Liability for compensation to a greater extent than provided for in § 6 is excluded -notwithstanding the legal basis of the claim raised. This is particularly valid for claims for compensation relating to faults at contracting, for other breaches of duty or for offence claims to compensation for damages to property according to § 823 BGB.

2. In case of claims for compensation the limitation according to section 1. is valid also for the demand of compensation for useless efforts.

3. As far as liability towards us is excluded or limited, this applies also to the personal liability for compensation of our employees and representatives

§ 8

Proprietary rights

1. We reserve the property of the goods until receipt of all payments owed by the customer. If it is agreed that payment shall be done by a bill of exchange, the reservation of proprietary

rights also covers the customer's cashing of the bill accepted by us and does not expire by crediting the received bill on our account. In case of the customer's activities contrary to the contract, especially in case of default, we are entitled to take the goods back. Taking back the goods constitutes our rescinding the contract. After taking back the goods we are entitled to their utilization, the proceeds thereof are to be allowed on the customer's liabilities, minus appropriate costs of utilization.

2. The customer is obliged to treat the goods carefully, he is particularly obliged to insure the goods as new sufficiently against damages caused by fire, water or theft at his own costs. If any works of maintenance or inspection are necessary, the customer is obliged to conduct these timely and at his own costs.

3. In case of seizure or other interventions by a third person, the customer is obliged to immediately inform us in writing so that we can institute proceedings according to § 771 ZPO. If the third person is not able to refund our judicial and non-judicial costs according to § 771 ZPO, the customer is liable for the loss caused to us.

4. The customer is entitled to resell the goods in the usual course of business; however in advance he assigns all claims up to the amount of the final invoice (including VAT) of our claims, which result from his reselling to his customers or third persons, independent of the goods being resold without or after processing. The customer remains entitled to collect the debt also after assignment. Our authorization to collect the debt ourselves remains thereby unaffected. However, we commit ourselves not to collect the debt as long as the customer fulfils his liability to pay from the proceeds realized, as long as he does not fall into arrears and particularly no application for the initiation of insolvency proceedings are made or inability to pay is given. If any of this is the case, we are entitled to demand, that the customer makes us known the assigned claims and their debtors, gives all information for collecting the debt, hands over all necessary documents and informs the debtors (third persons) about the assignment. The claims assigned by us in advance refer to the accepted balance, as well as in case of the customer's insolvency, to the then existing causal balance.

5. The processing or reconstruction of the goods by the customer is always done for us. If the goods are processed with other parts not belonging to us, we acquire property of the

new goods relative of the value of the goods (invoice sum, including VAT) to the other parts processed at the time of processing. Incidentally, the article produced by processing is to be regarded as the goods delivered under reservation of proprietary rights. All regulations made apply accordingly.

6. If the goods are inseparably mixed with other parts not belonging to us, we acquire joint property of the new goods relative of the value of the goods (invoice sum, including VAT) to the other mixed goods at the time of blending. If the blending is done in a way that the goods of the customers are to be regarded as the main item, it is regarded as agreed that the customer confers proportional joint property to us. The customer keeps the sole or joint property thus produced for us.

7. The customer also assigns to us the claims for safeguarding the claims against him, which grow towards a third party from the connection of the goods with real estate.

8. We commit ourselves to release the legitimate surety upon the customer's demand in so far as the realizable value of our surety exceeds the claims to be safe-guarded by more than 10%; the choice of the surety to be released lies with us.

§ 9

Industrial Rights

1. Text content, pictures, graphics and drawings as well as their arrangement in our sales brochure and/or in email communications, multimedia presentations etc., are subject to copyright law and other protective laws, including but not limited to registered design and industrial design laws. The content must not be copied or modified. Any communication or provision of access to third parties is only allowed by means of handing over our brochure.

2. Any reprint of your own as well as any use in electronic media etc. is permitted only once you have obtained our prior written approval. Any further utilization above and beyond the aforementioned is prohibited. In particular, customer shall be barred from granting sublicenses and from duplicating, renting or in any other form utilizing the aforementioned services and products.

3. Customer shall agree to inform us immediately of any copyright violations or if claims regarding copyright violations are made against

customer. In these cases, we assure you that we will assist in bringing action and will provide any and all information that is necessary for legal proceedings.

§ 10

Court of jurisdiction

1. As far as the customer is a businessmen, our place of business is also relevant court of justice; however, we are entitled to sue the customers at the court of his domicile as well.

2. The law of the Federal Republic of Germany applies exclusively; UN-sales laws or international agreements do not apply.

3. As far as the confirmation of order does not say any other, the court at the head office of Brumberg Leuchten GmbH & Co. KG shall have jurisdiction.

4. The German version of the General Terms of Sale is the original version. In terms of interpretation it has priority over the English translation with due regard of the German legal system.

Sudern, June 2010

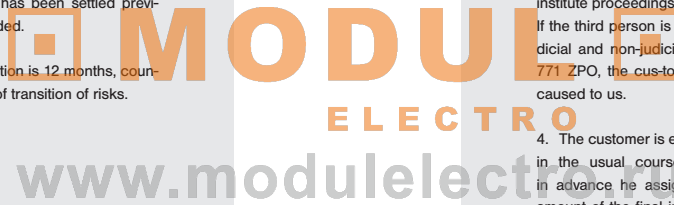



LUCENTE
by **BRUMBERG**

MODUL
ELECTRO
www.modulelectro.ru



Weitere Informationen und den aktuellen Katalog finden Sie auf www.brumberg.com
Further information and our current catalogue you can find on our website www.brumberg.com

www.brumberg.com

poomlighting



MODUL
ELECTRO
www.modulelectro.ru



Weitere Informationen und den aktuellen Katalog finden Sie auf www.brumberg.com
Further information and our current catalogue you can find on our homepage www.brumberg.com

www.brumberg.com