

 **MODUL** 
ELECTRO
www.modulelectro.ru

DON'T WE ALL LOVE THE

DAFRIK



 **MODUL** 
ELECTRO
www.modulelectro.ru

PRODUCTS



 **MODUL**
ELECTRO

www.modulelectro.ru

	12-25	2
A	APOLLO	14
B	B-ZZZ	16
	BRIDGE	20
C	CANNA-2	26
	CHESTER / CHESTER XL	30
	CHUBBY	36
	COPPERFIELD	44
	COUTURE	48
	CROSSLIGHT	52
	CYBE	56
D	d-BEEF	62
	d-CONCRETE	64
	d-COW	66
	d-RABBIT	68
	d-LEATHER	70
	d-SQUEEZE	72
	D2V2	74
F	FRANJE	78
G	GUM	82
H	HEAPS	84
	HERBERT	90
	HOEK	94
	HOPPY	96
	HYPE	100
I	ICE	104
J	JOHN PAWSON LAMP	106
	JUICE	108
K	KNARF	110
	KNIK	112
L	LA CAGE	114
	L-BOW	116
	LGTM-X01	118
	LOOP	122
M	METROPOLIS	124
N	NO COPY	126
	NO FRUIT	128
	NO FRUIT bling bling	132
O	OBLIVION	134
P	PANTY	138
	PAROQ	140
	PAWWW	144
	POC	146
R	ROSET	148
	R&S	150
S	SLITE	152
	SNOWDOME	156
	SON OF EDDY	158
	SPACEWALKER / SPACEWALKER JR.	160
	SPINE	166
	STAR'58	170
	SQUARE ANGEL	172
T	TRAPPED	174
	T&T	176
	TSJOEPEY	178
	TWOLVE	180
	YOKOZUNA	182
Z	ZUPER	186

12-25

design Co Twee for Dark

 **MODUL** 
ELECTRO
www.modulelectro.ru



reddot design award
winner 2003



Designpreis der
Bundesrepublik
Deutschland
Nominiert 2004





MODUL
ELECTRO
www.modulelectro.ru





12-25 BASIC with a few possibilities of RAL-colours



MODUL
ELECTRO
www.modulelectro.ru

12-25 BASIC black glossy



>>>MAGNET + BODY

12-25 BASIC

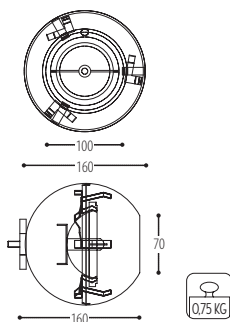

>>>BUILD-IN :

insertbox + magnet + body

12-25

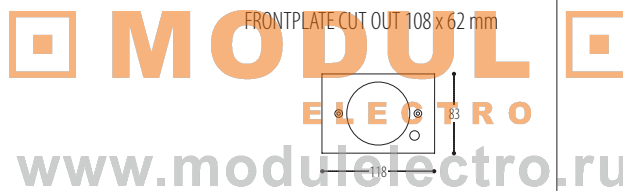

12-25 SET2

FRONTPLATE CUT OUT 180 x 68 mm

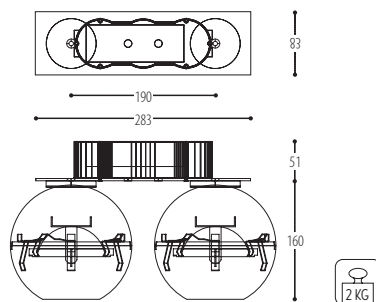

>>>BUILD-UP :

build up box + magnet + body

12-25 0

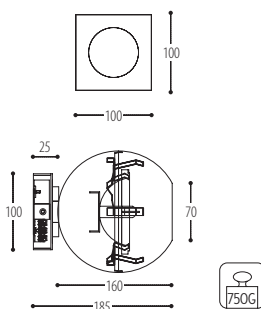

12-25 SET2 0

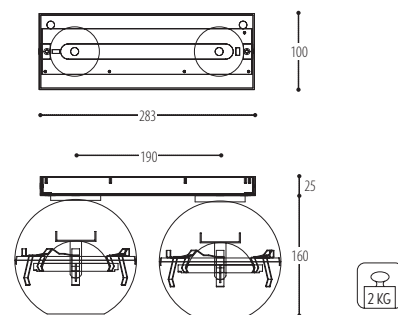

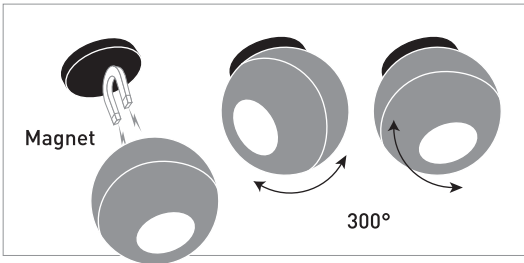

12-25 SET3

FRONTPLATE CUT OUT 180 x 68 mm

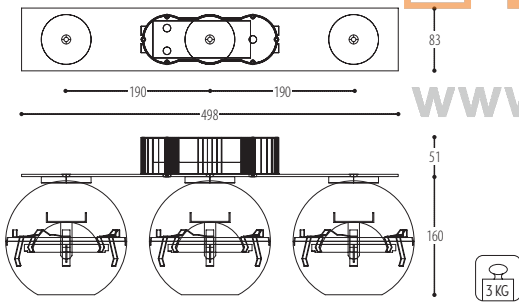

12-25 SET3 O

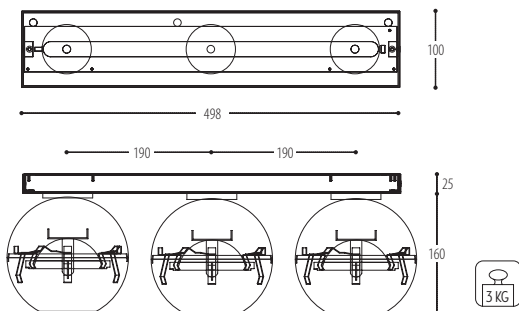

HIR-CE111 35W - 21°

Efficiency factor: 100%

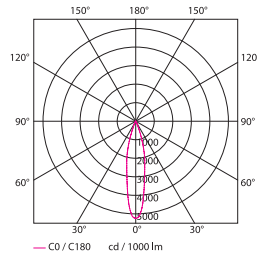

HIR-CE111 35W - 38°

Efficiency factor: 100%

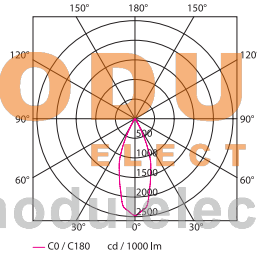

QR-LP111 45W - 22°

Efficiency factor: 100%

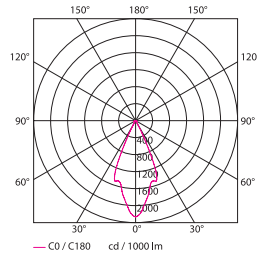

QR-LP111 45W - 45°

Efficiency factor: 100%

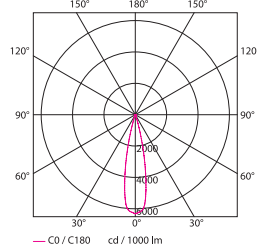

White glossy

Black glossy

Chrome



Metal

12-25 BASIC

12-25 / 12-25 O / 12-25 Set 2 / 12-25 Set 3

12 V	QR-LP111 (MAX 45 W) / G53	INCL/EXCL TRANSFO
230 V	QPAR20 (MAX 50 W) / E27	
	HIR-CE111 (35 W) / GX8,5	EVG INCL/EXCL GEAR

12-25 Set 2 O / 12-25 Set 3 O

12 V	QR-LP111 (MAX 45 W) / G53	INCL/EXCL TRANSFO
230 V	QPAR20 (MAX 50 W) / E27	



PROJECT PAGES:

005 - 006 - 028 - 030 - 033 - 040 -
045 - 057 - 078 - 082 - 092 - 093 -
103 - 108 - 148 - 155 - 158 - 159



MODUL
ELECTRO
www.modulelectro.ru

TOUCH
CONTACT



MODUL
ELECTRO

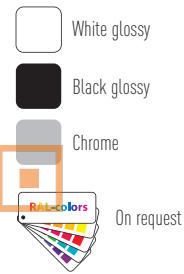

12-25 WALL/PLUG

12-25 FLOOR/PLUG

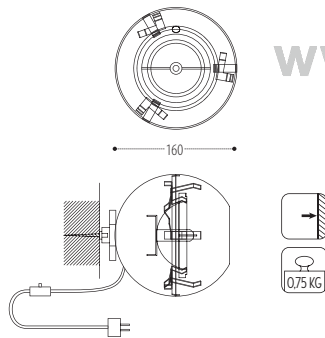

12-25 TABLE/PLUG

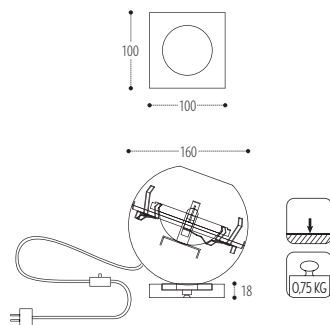

www.modulelectro.ru

TOUCH CONTACT

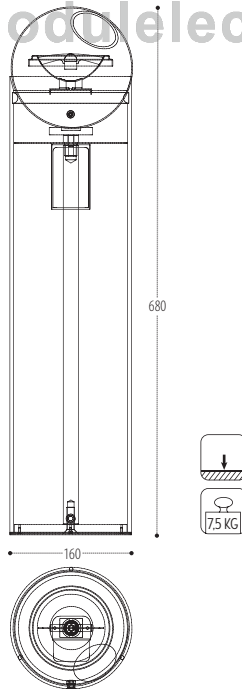

Metal

12-25 WALL/PLUG
12-25 TABLE/PLUG

		1x QR-LP111 (MAX 45 W) / G53	INCL TRANSFO
		1x QPAR20 (MAX 50 W) / E27	

12-25 FLOOR/PLUG

		1x QR-LP111 (MAX 45 W) / G53	INCL TRANSFO
--	--	------------------------------	---------------------





MODUL
ELECTRO
www.modulelectro.ru

12-25 S
FRONTPLATE CUT OUT 108 x 62 mm

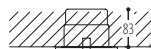
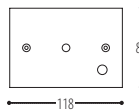

max. 1500

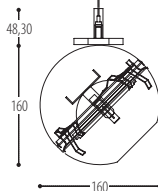

12-25 C

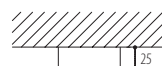
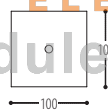

max. 1500

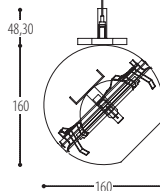

MODUL
ELECTRO

www.modulelectro.ru

White glossy

Black glossy

Chrome

On request

Metal



12-25 S / 12-25 C

		1x QR-LP111 (MAX 45 W) / G53	INCL/EXCL TRANSFO
		1x QPAR20 (MAX 50 W) / E27	



QR-LP111 45W - 45°

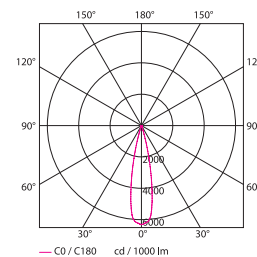

Efficiency factor: 100%

PROJECT PAGES:

006 - 008 - 050 - 124 - 143



APOLLO

design Romy Kühne for Dark



USA 2010



 **MODUL** 
ELECTRO
www.modulelectro.ru

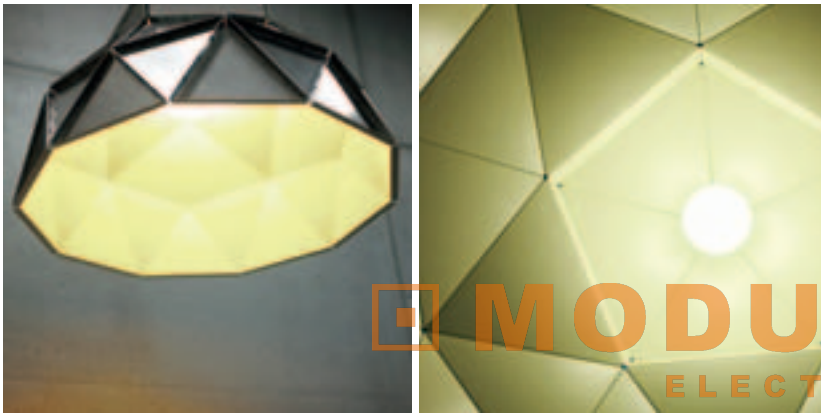

MODUL
ELECTRO

www.modulelectro.ru

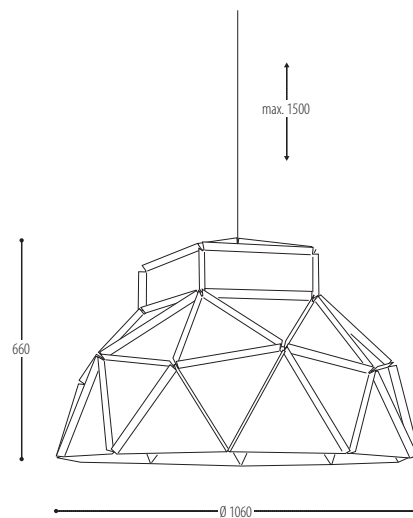

Body Stainless steel / Inside White

Stainless steel

1x G120 (MAX 150 W) / E27

1x TCG-SE (MAX 23 W) / E27

25 KG CE 230 V

0.7m 960° IP20





PROJECT PAGES:

018

B-ZZZ

design Frank Janssens for Dark

 **MODUL** 
ELECTRO
www.modulelectro.ru



MODUL

ELECTRO

www.modulelectro.ru



MODUL
ELECTRO
www.modulelectro.ru

B-ZZZ / 0

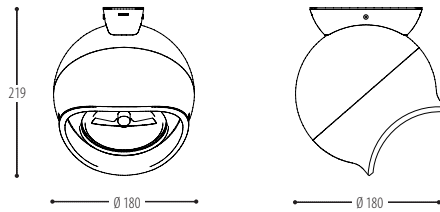

MODUL ELECTRO

B-ZZZ
CUT OUT Ø 210

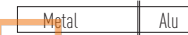
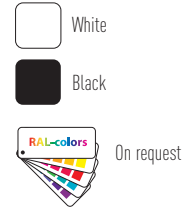
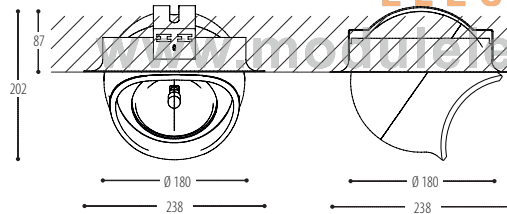

QR-LP111 45W-22°

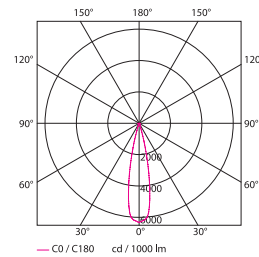

Efficiency factor: 100%

HIR-CE111 35W - 21°

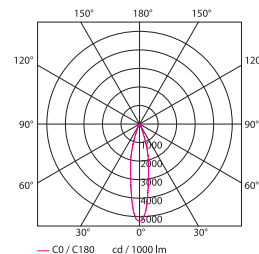



Efficiency factor: 100%

IP20	12 V	III	0.7m	EXCL TRANSFO	1x QR-LP111 (MAX 45 W) / G53
	230 V	III	0.9m	EXCL GEAR	1x HIR-CE111 (35 W) / GX8,5 1x HIR-CE111 (70 W) / GX8,5
IP66	0.7m	EXCL GEAR	1x HIT-TC-CE (35 W) / G8,5 1x HIT-TC-CE (70 W) / G8,5		must be used with
	LED		led reflector 		Colour temp 2700K / 3000K / 4000K --> 700 Lm >80 CRI 700 mA --> 16W Colour temp 2700K / 3000K / 4000K --> 1000 Lm >80 CRI 700 mA --> 23W Colour temp 2700K / 3000K / 4000K --> 700 Lm >95 CRI 700 mA --> 23W

BRIDGE



design Georges Seris for Dark

 **MODUL** 
ELECTRO
www.modulelectro.ru



MODUL
ELECTRO
www.modulelectro.ru





 **MODUL** 
ELECTRO
www.modulelectro.ru

BRIDGE WALL fluo blue

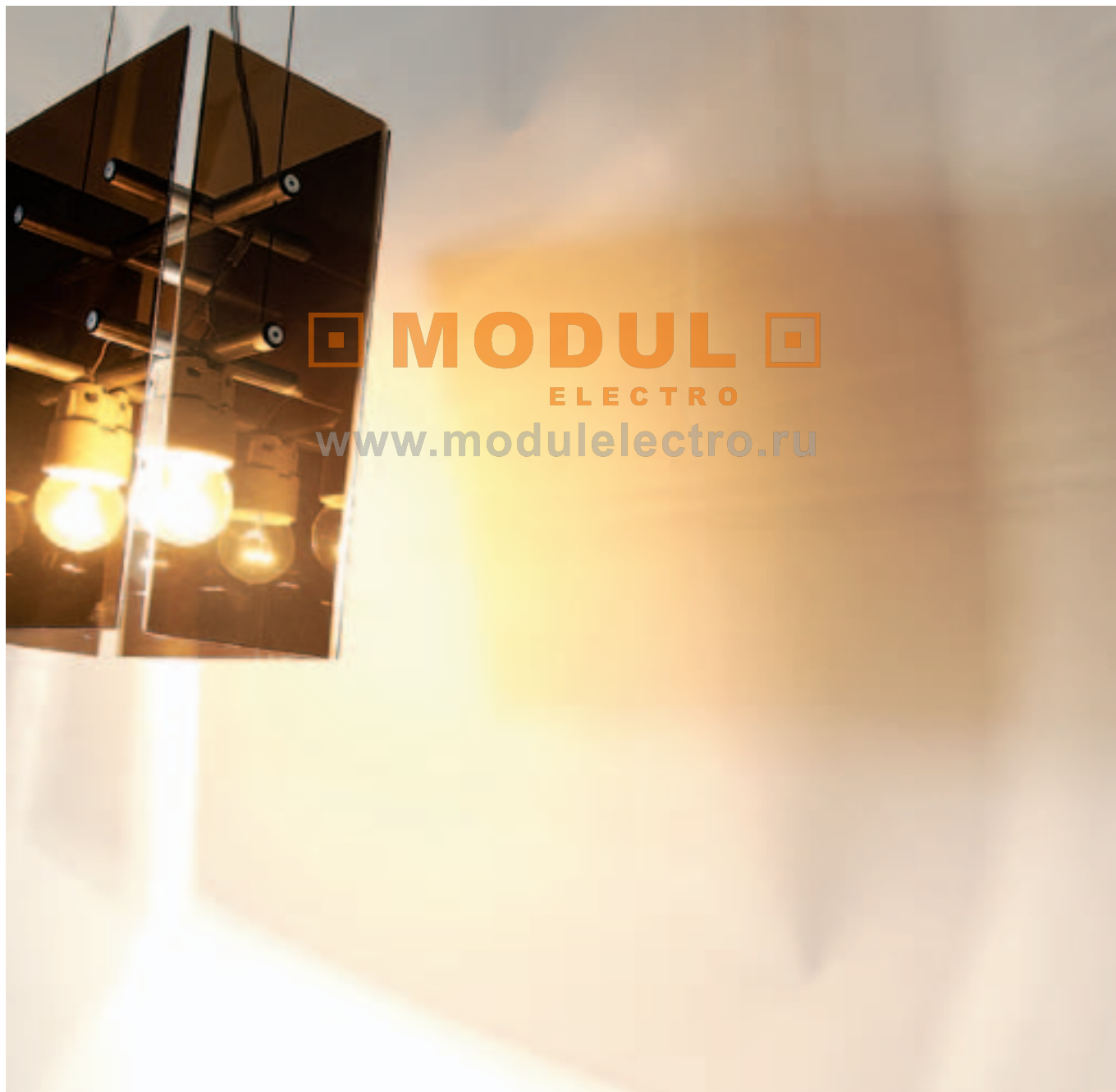
BRIDGE TWO mokka



 **MODUL** 
ELECTRO
www.modulelectro.ru

BRIDGE ONE

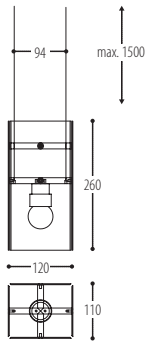

BRIDGE ONE WALL

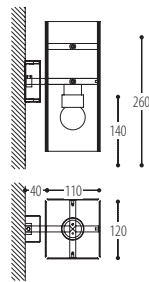

www.modulelectro.ru

BRIDGE ONE 3P

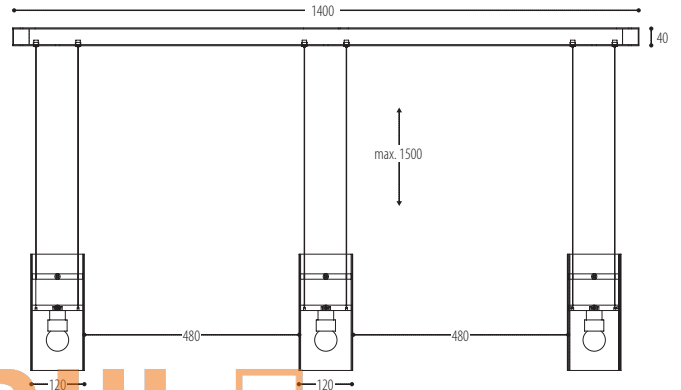

BRIDGE TWO

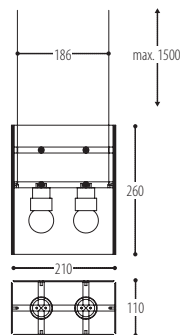

BRIDGE TWO 3P

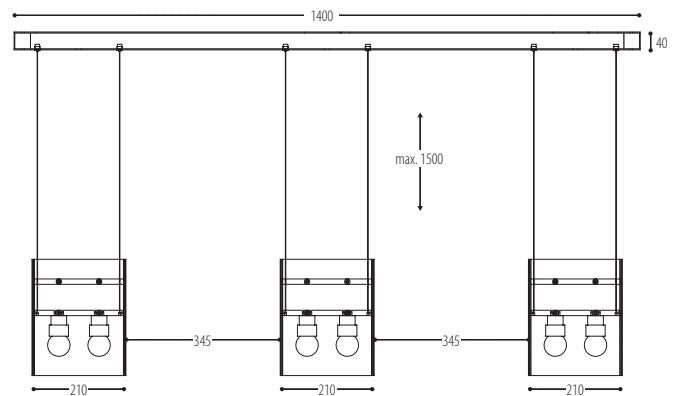

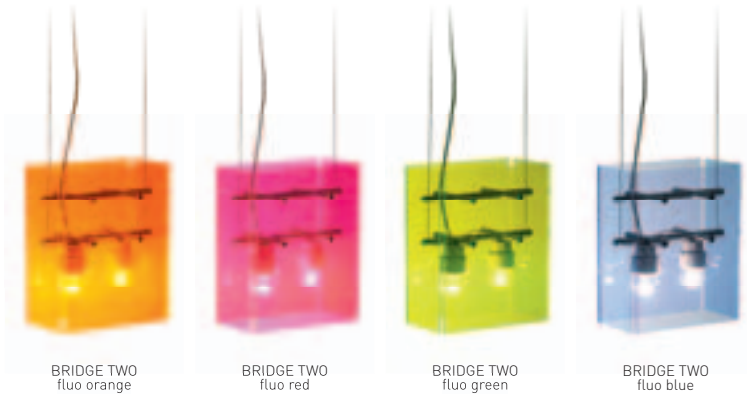

BRIDGE TWO
fluo orange

BRIDGE TWO
fluo red

BRIDGE TWO
fluo green

BRIDGE TWO
fluo blue



BRIDGE TWO
mokka

BRIDGE TWO
bm

BRIDGE TWO
clear

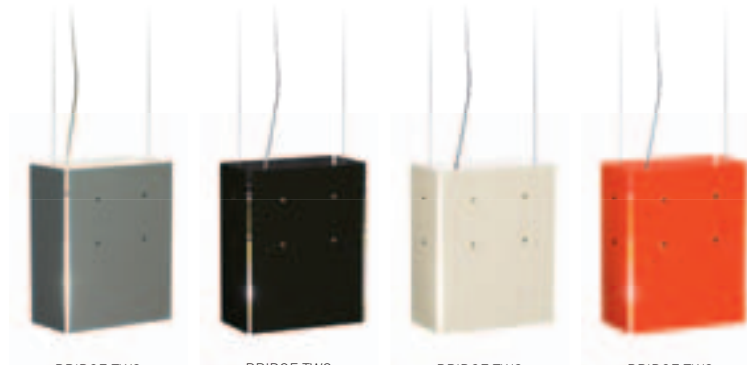

BRIDGE TWO
alu

BRIDGE TWO
black mat

BRIDGE TWO
white mat

BRIDGE TWO
red mat

MODUL
ELECTRO

www.modulelectro.ru

PMMA



METAL



BRIDGE TWO clear

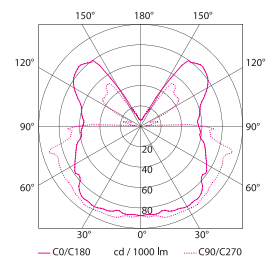

Efficiency factor: 92,32%

PROJECT PAGES:

011 - 020 - 023 - 034 - 036 - 052 - 053 -
056 - 082 - 095 - 118 - 128 - 129 - 135 -
136 - 144 - 145 - 152 - 162

CANNA-2

design Frank Janssens for Dark



reddot design award
honourable mention 2009



USA 2008

 **MODUL** 
ELECTRO

www.modulelectro.ru

CANNA-2 / 0
white glossy



CANNA-2 TRACK
black glossy



MODUL
ELECTRO
www.modulelectro.ru



MODUL
ELECTRO
www.modulelectro.ru

CANNA-2 black glossy

CANNA-2

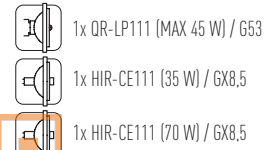
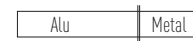
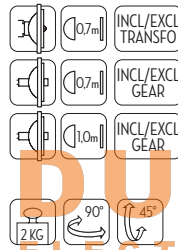
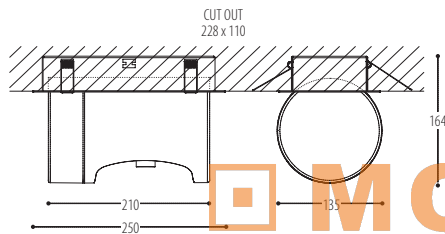

www.modulelectro.ru

CANNA-2 / O

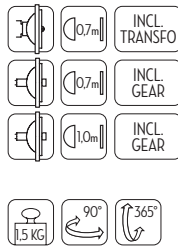
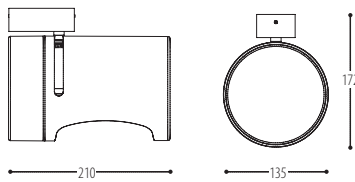

QR-LP111 45W-22°

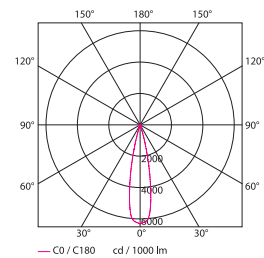

Efficiency factor: 100%

HIR-CE111 35W - 21°

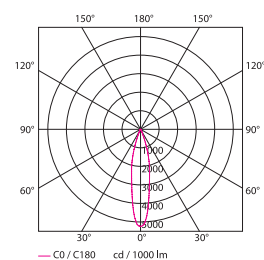

Efficiency factor: 100%

CANNA-2 TRACK

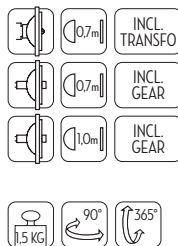
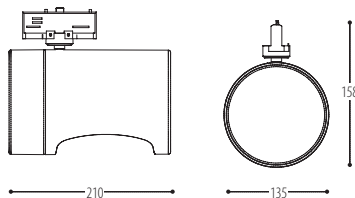



PROJECT PAGES:

044

CHESTER

design Bert & Dennis for Dark

 **MODUL** 
ELECTRO
www.modulelectro.ru



MODUL
ELECTRO
www.modulelectro.ru



CHESTER FLOOR white leather



CHESTER
white leather



CHESTER
black leather

MODUL
ELECTRO

www.modulelectro.ru



White leather



Black leather

Leather	Metal
---------	-------

CHESTER S

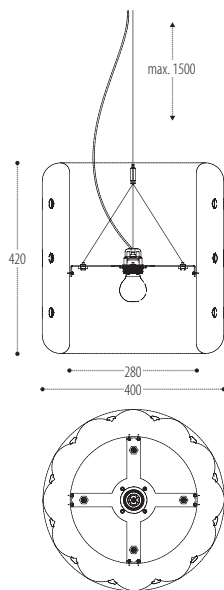

CHESTER FLOOR

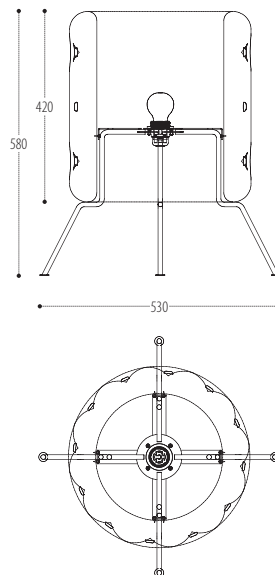

 1x A60 (MAX 60 W) / E27

 1x OA60 (MAX 42 W) / E27

 1x TCA-SE (MAX 11 W) / E27

 1x LED (MAX 7 W) / E27

CHESTER S





CHESTER FLOOR



PROJECT PAGES:

133



 **MODUL** 
ELECTRO
www.modulelectro.ru

CHESTER XL white leather

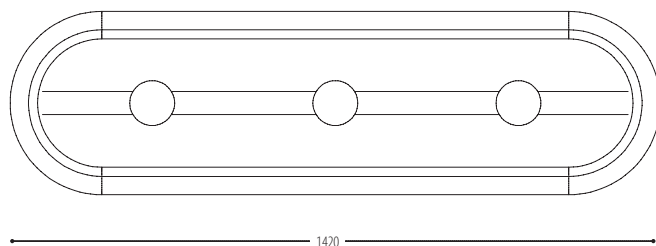
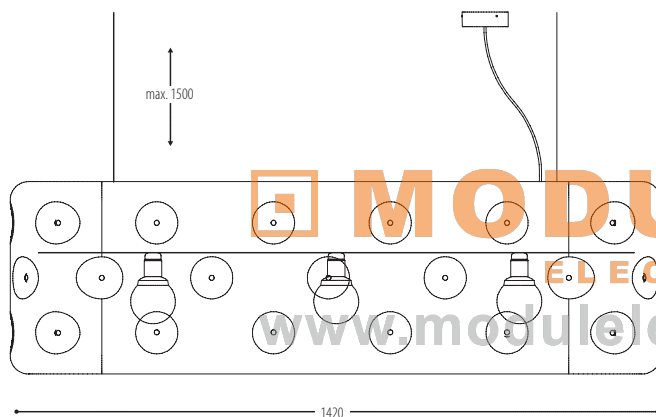

CHUBBY

design Davy Grosemans for Dark



DESIGNPREIS
2009
NOMINIERT



product
design
award
2008



USA 2008

 **MODUL** 
ELECTRO

www.modulelectro.ru



CHUBBY FLOOR - 2xTC-TEL 32W
fabric 12 - down white plexi - up clear

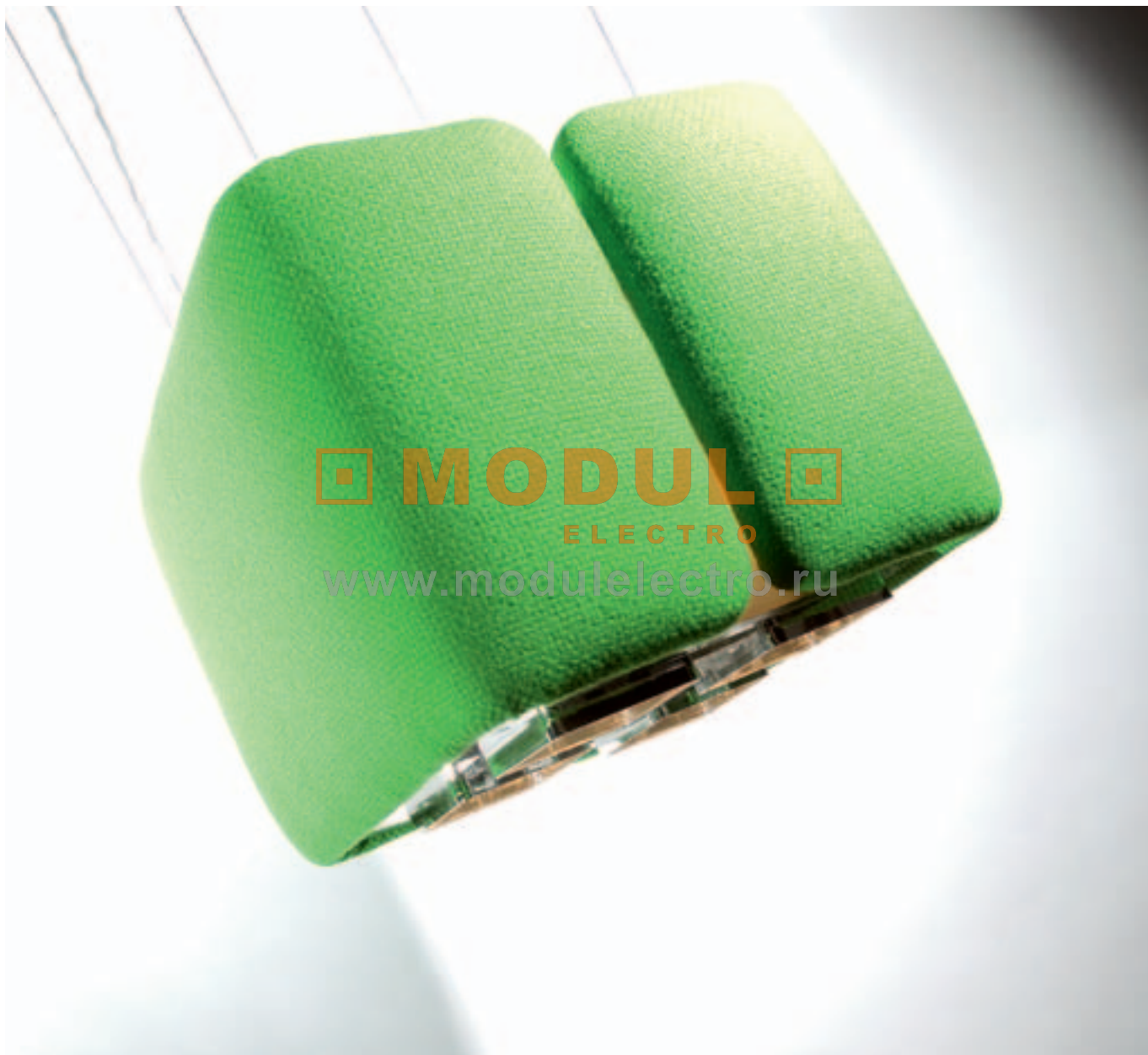



CHUBBY BOX - 2xTC-TEL 32W
fabric 12 - down silver - up clear

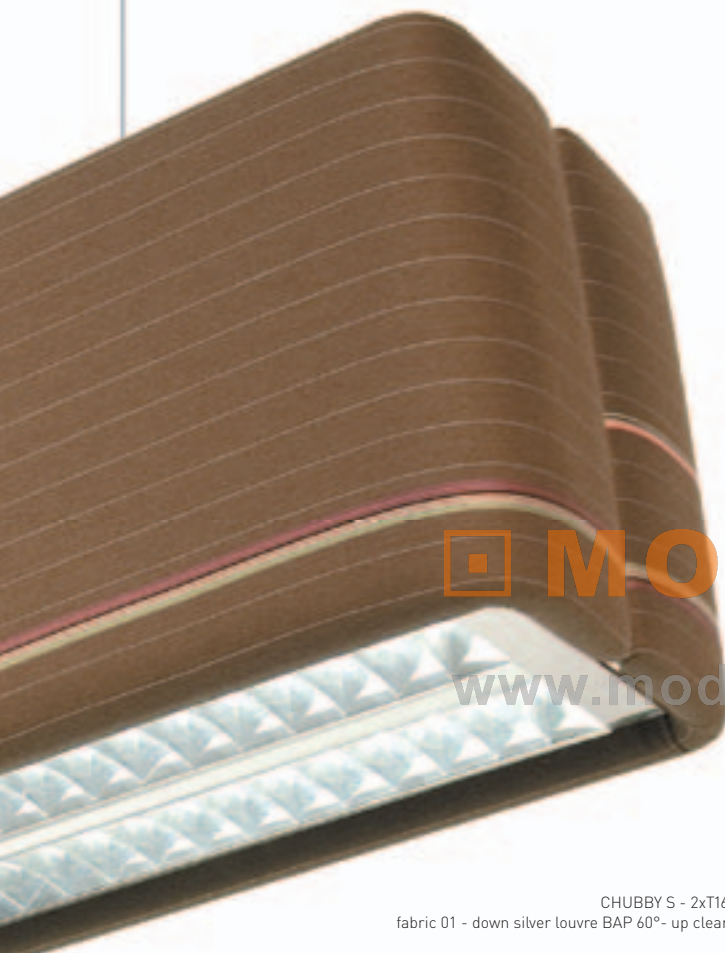

MODUL
ELECTRO

www.modulelectro.ru



 **MODUL** 
ELECTRO
www.modulelectro.ru

CHUBBY S - 2xT16
fabric 01 - down silver louvre BAP 60° - up clear



MODUL
ELECTRO
www.modulelectro.ru



CHUBBY S -2xT16 - fabric 07 - down silver - up clear
CHUBBY BOX - 2xTC-TEL 32W - fabric 07 - down silver - up clear

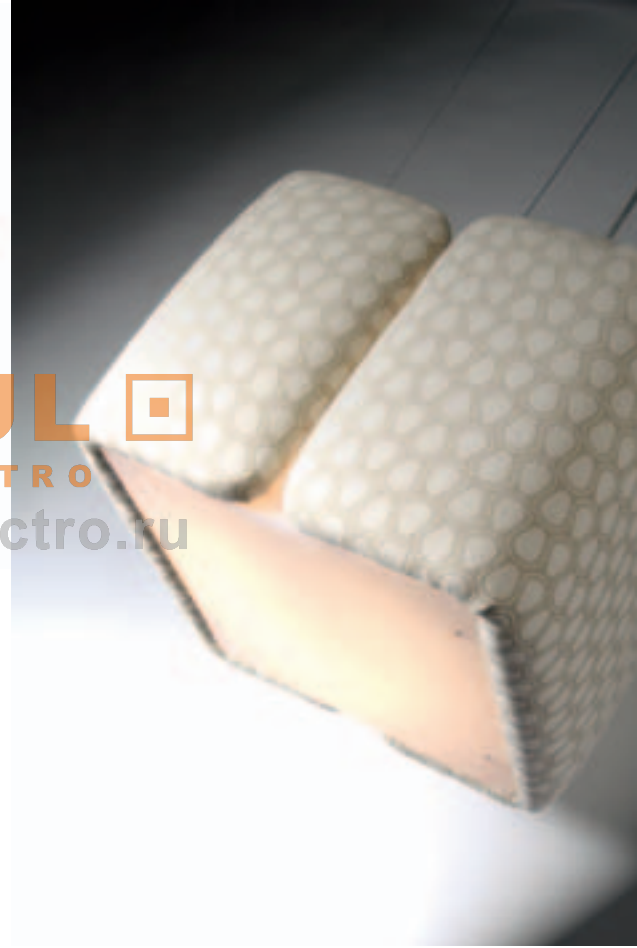

CHUBBY S - 5xQR-LP111 - fabric 03 - down black metal
CHUBBY S - 2xT16 - fabric 03 - up red



CHUBBY BOX - fabric 10 - down white plexi - up clear

 **MODULO** 
ELECTRO
www.modulelectro.ru

CHUBBY S

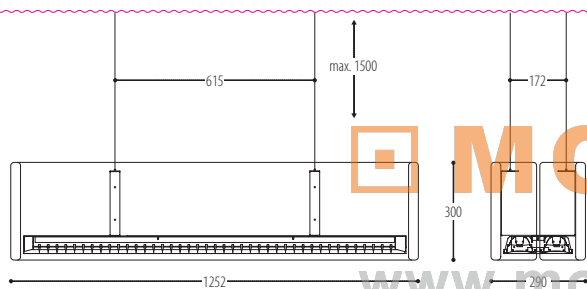

		DOWN	UP
	2x T16 (28 W) / G5	BAP 60°	<input type="checkbox"/> Clear
	2x T16 (54 W) / G5		<input type="checkbox"/> Red <input type="checkbox"/> Mokka

		DOWN
	5x QR-LP111 (MAX 45 W) / G53	black
	5x HIT-TC-CE (20 W) / PGJ5	white
	5x HIT-TC-CE (35 W) / PGJ5	

CHUBBY BOX

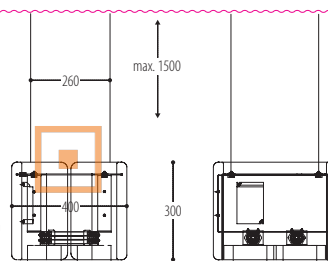

		DOWN	UP
	2x TC-TEL (32 W) / GX24q-3	silver	<input type="checkbox"/> Clear
		gold	<input type="checkbox"/> Mokka
		white plexi	

		DOWN
	4x QR-LP111 (MAX 45 W) / G53	black
	4x HIT-TC-CE (20 W) / PGJ5	white
	4x HIT-TC-CE (35 W) / PGJ5	

MODUL
ELECTRO
www.modulelectro.ru

CHUBBY FLOOR

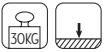
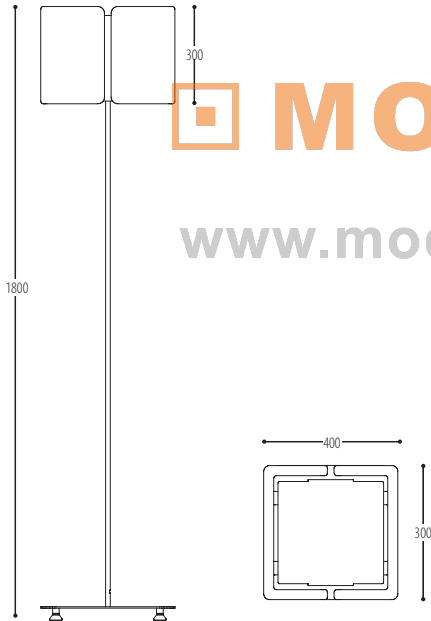

		DOWN	UP
2x TC-TEL (32 W) / GX24q-3 EVG		white plexi	Clear Mokka

FABRICS - flame retardant



fabric 03



fabric 01



fabric 06



fabric 07

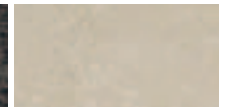

fabric 08



fabric 09

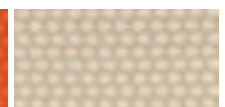

fabric 10



fabric 11



fabric 12

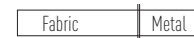

CHUBBY S T16 D/ID BAP 60°/CLEAR

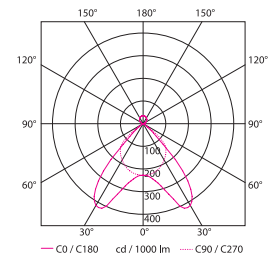



Efficiency factor: 70,29%

PROJECT PAGES:

019 - 110 - 141 - 168



COPPERFIELD

design Maximal Design for Dark

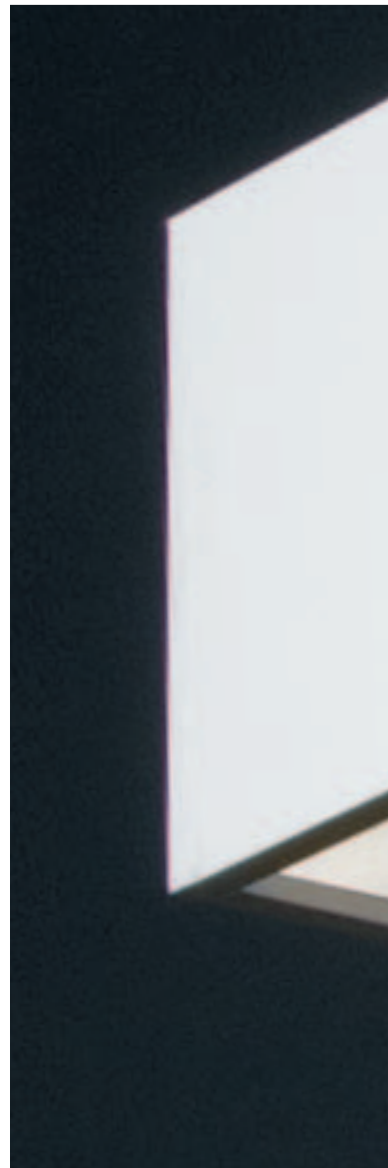
 **MODUL** 
ELECTRO
www.modulelectro.ru





 **MODUL** 
ELECTRO
www.modulelectro.ru

COPPERFIELD white



COPPERFIELD
black

 **MODUL** 
ELECTRO

www.modulelectro.ru



MODUL ELECTRO

www.modulelectro.ru

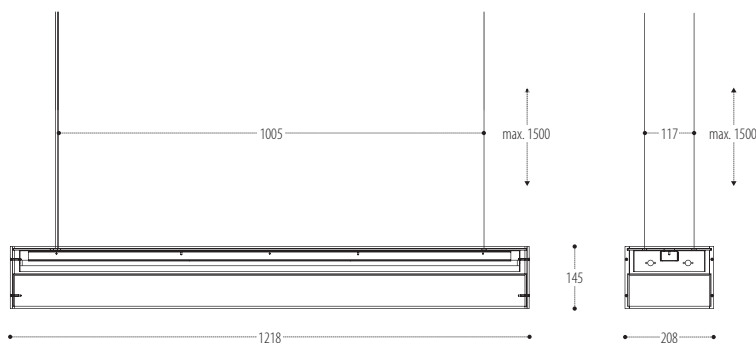

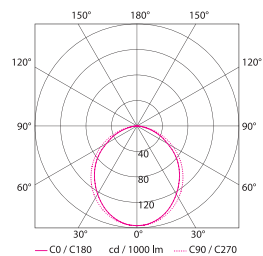

COPPERFIELD 2x28W



Efficiency factor: 40.8%

COUTURE

design Alain Berteau for Dark

 **MODUL** 
ELECTRO
www.modulelectro.ru





MODUL
ELECTRO
www.modulelectro.ru

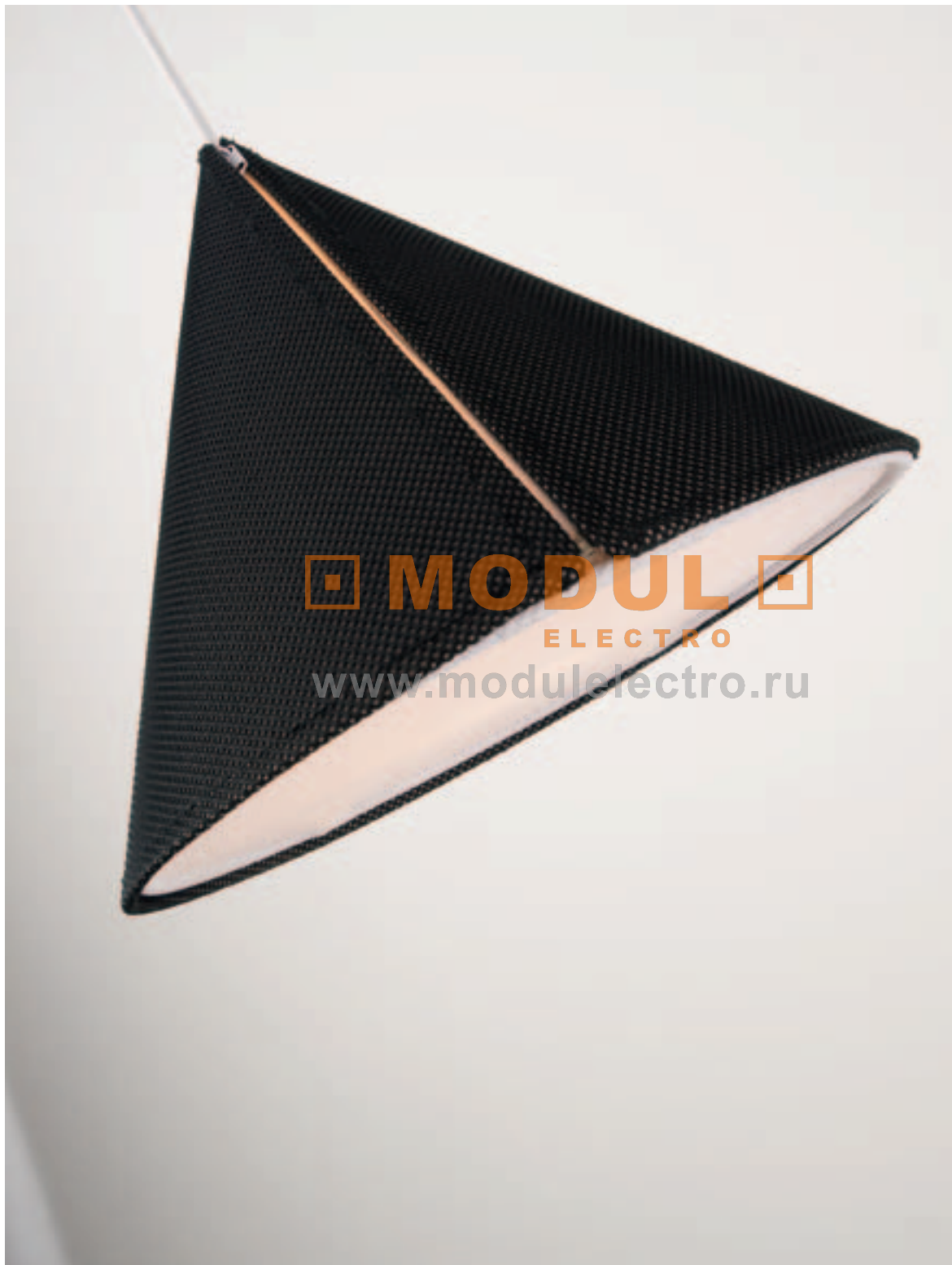

MODUL
ELECTRO
www.modulelectro.ru

MODUL
ELECTRO
www.modulelectro.ru

FABRICS



fabric 01



fabric 04



fabric 05



fabric 06



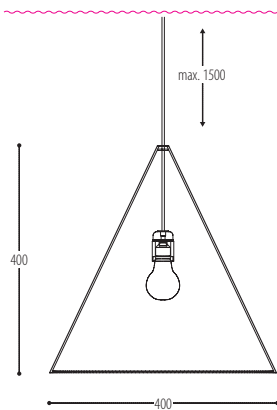

Fabric	Metal
--------	-------

COUTURE 01

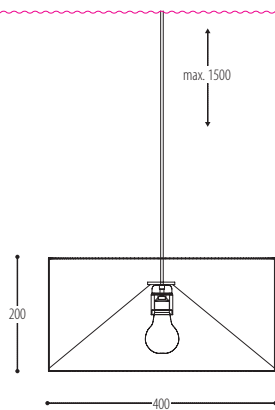

COUTURE 02



-  1x A60 (MAX 60 W) / E27
-  1x OA60 (MAX 42 W) / E27
-  1x TCA-SE (MAX 11 W) / E27
-  1x LED (MAX 7 W) / E27





CROSSLIGHT

design Jan Melis & Ben Oostrum for Dark



reddot design award
winner 2003



 **MODUL** 
ELECTRO
www.modulelectro.ru



MODUL
ELECTRO
www.modulelectro.ru



CROSSLIGHT S white



CROSSLIGHT S orange



CROSSLIGHT S red

MODUL

ELECTRO

www.modulelectro.ru

CROSSLIGHT S

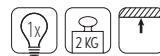
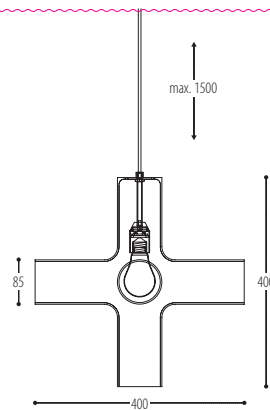

CROSSLIGHT WALL

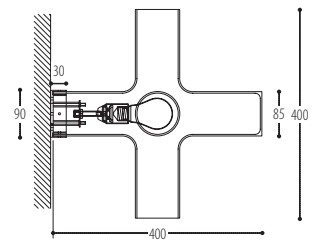

MODUL
ELECTRO

www.modulelectro.ro

CROSSLIGHT 3P

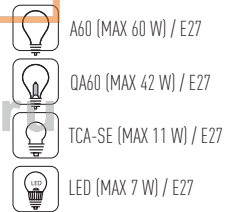
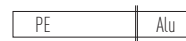
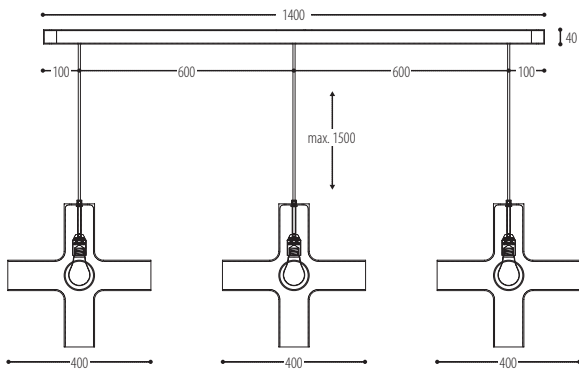

CROSSLIGHT white

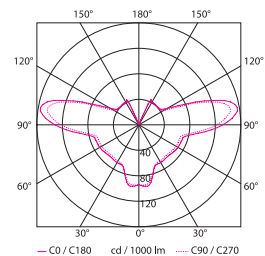



Efficiency factor: 80,3%

PROJECT PAGES:

031 - 037 - 090 - 091 - 097 - 101 - 109 -
116 - 149 - 156 - 159 - 179 - 188

CYBE

design Peter Vanooteghem for Dark

 **MODUL** 
ELECTRO
www.modulelectro.ru



CYBE FLOOR
fluo red

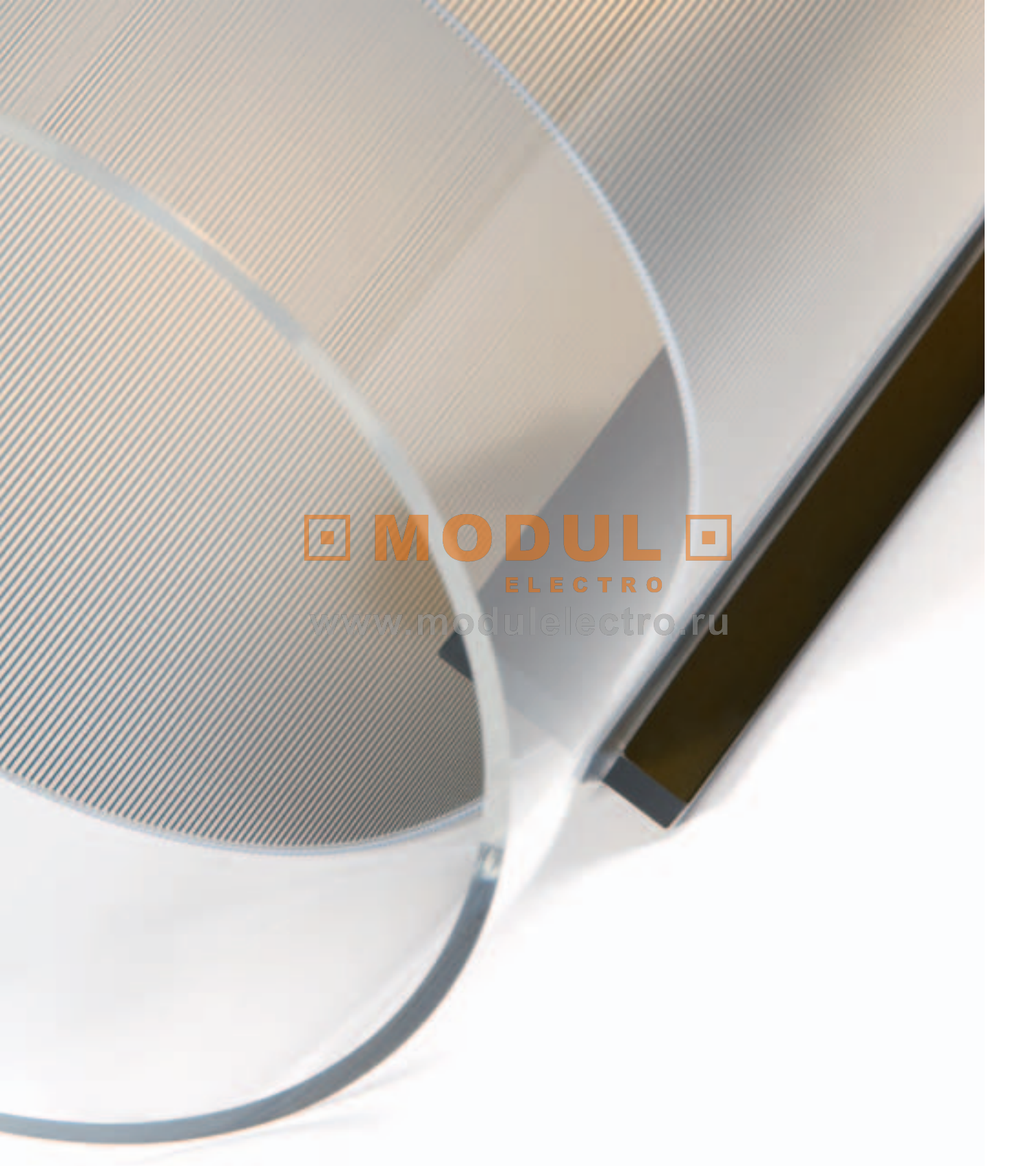

MODUL
ELECTRO
www.modulelectro.ru



CYBE PLUG-IN mokka



CYBE TABLE fluo green

MODUL
ELECTRO
www.modulelectro.ru

CYBE WALL fluo green



MODUL
ELECTRO
www.modulelectro.ru



CYBE fluo red



CYBE fluo orange



CYBE fluo green



CYBE fluo blue



CYBE mokka

MODUL

ELECTRO

CYBE

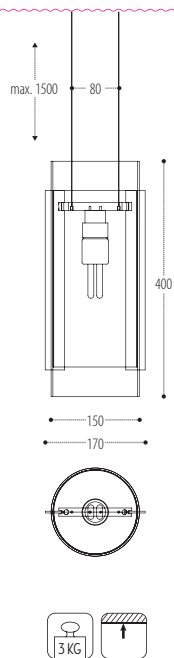

CYBE MAX

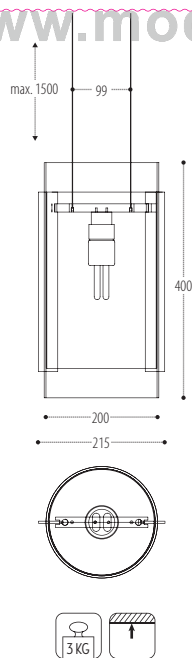

CYBE TABLE

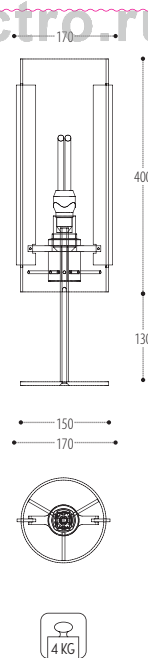

CYBE FLOOR

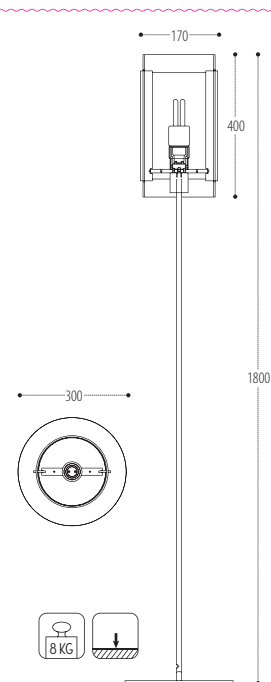

MODUL ELECTRO

CYBE PLUG-IN

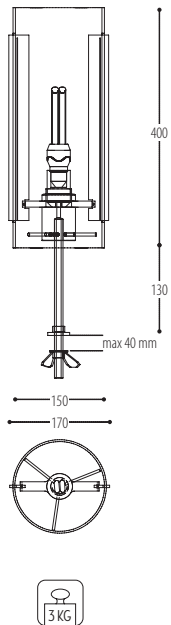

CYBE WALL

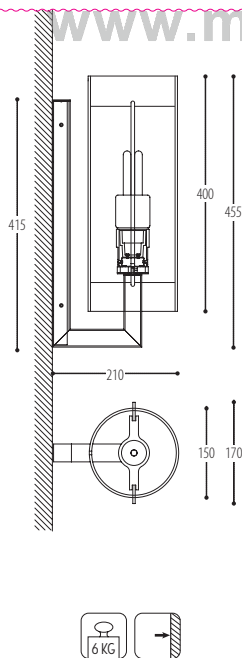

PROJECT PAGES:

082 - 091 - 137 - 163 - 185

d-BEEF

design Ivan Missinne for Dark

MODUL
ELECTRO
www.modulelectro.ru

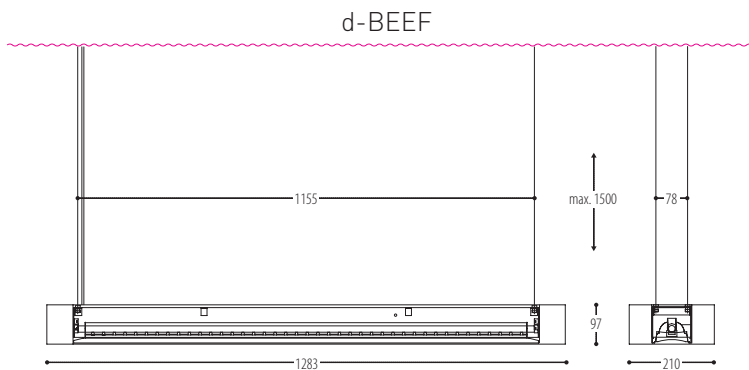

d-BEEF - 1xT16 (54W) - up.red

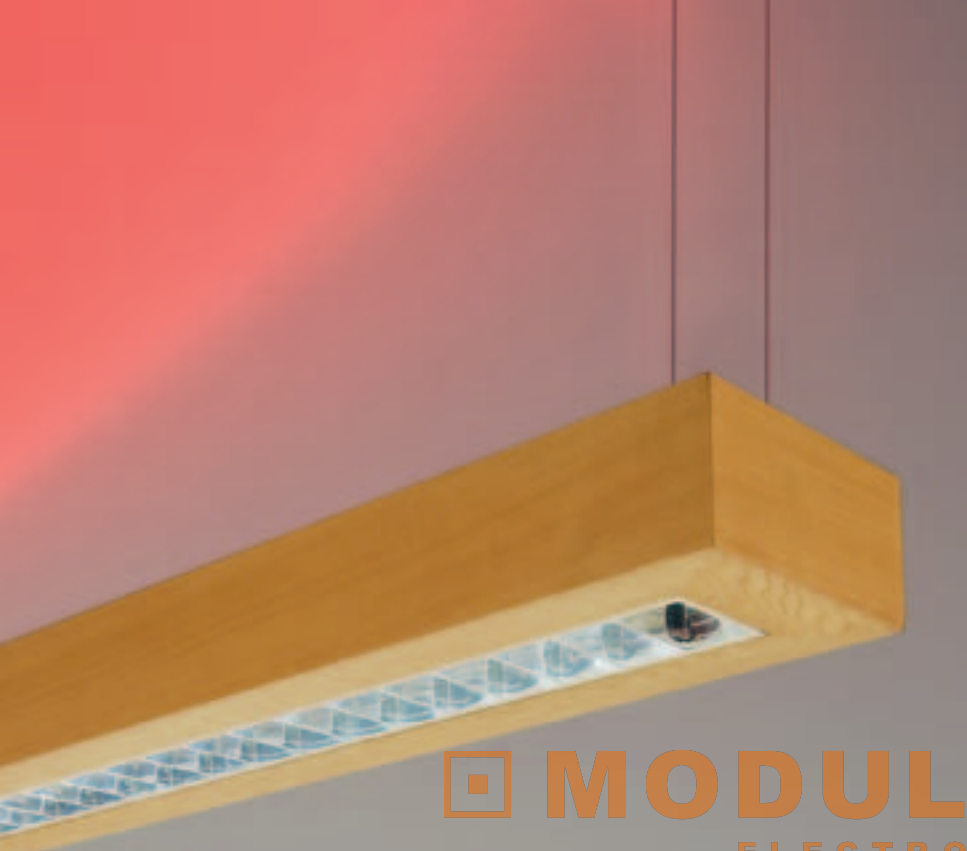

MODUL
ELECTRO

www.modulelectro.ru

BODY (Wood)

UPLIGHT PLEXI



d-BEEF 1xT16 54W

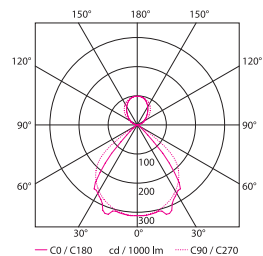

Efficiency factor: 81,2%

d-CONCRETE

design Ivan Missinne for Dark



MODUL
ELECTRO
www.modulelectro.ru

MODUL ELECTRO

www.modulelectro.ru

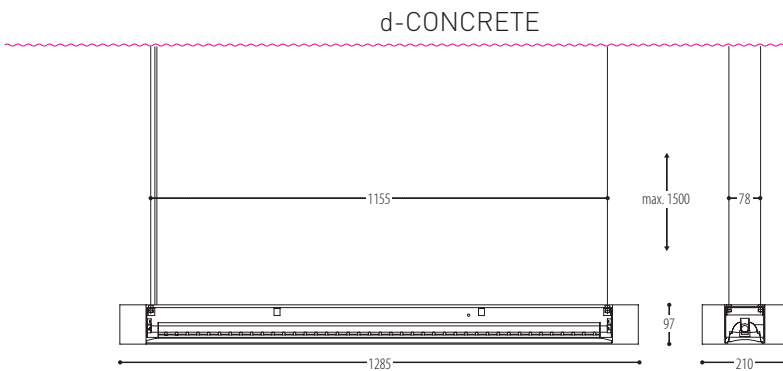

BODY (Concrete)

UPLIGHT PLEXI

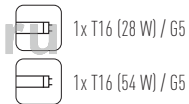

d-CONCRETE 1xT16 54W

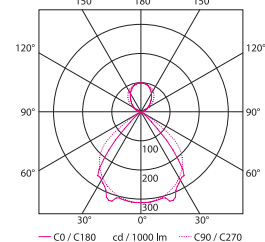

Efficiency factor: 81,2%

PROJECT PAGES:

008 - 112 - 190 - 191

d-COW

design Ivan Missinne for Dark



MODUL
ELECTRO
www.modulelectro.ru

d-COW
1xT16 (54W)
up blue

MODUL ELECTRO

www.modulelectro.ru

BODY (Cow Skin)

UPLIGHT PLEXI

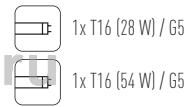

d-COW

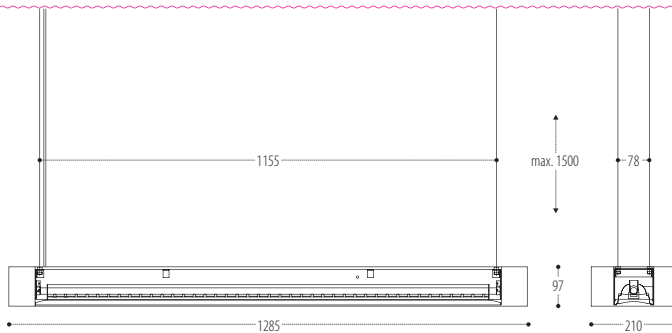

d-COW 1xT16 54W

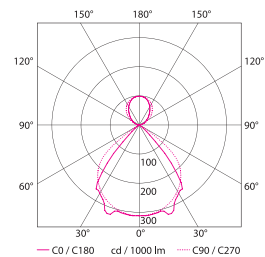

Efficiency factor: 81,2%

PROJECT PAGES:
048 - 054

d-RABBIT

design Ivan Missinne for Dark

d-RABBIT white - 1xT16 (54W) - up clear



MODUL
ELECTRO
www.modulelectro.ru



d-RABBIT black
1xT16 (54W)
up clear

MODUL
ELECTRO
www.modulelectro.ru

BODY (Rabbit Fur)

- White
- Brown
- Black

UPLIGHT PLEXI

- Clear
- Red
- Blue
- Green

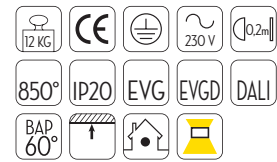
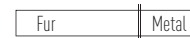

d-RABBIT

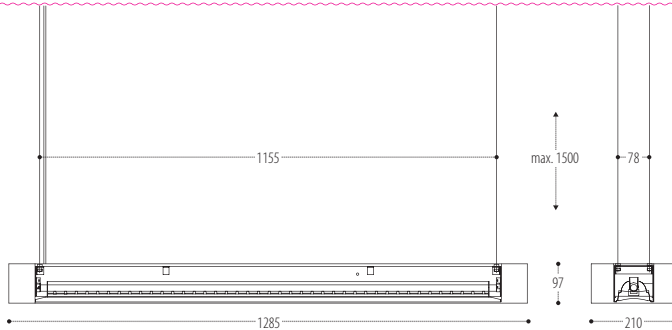

d-RABBIT 1xT16 54W

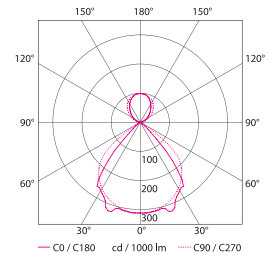



Efficiency factor: 81,2%

70

d-LEATHER

design Ivan Missinne for Dark

 **MODUL** 
ELECTRO
www.modulelectro.ru

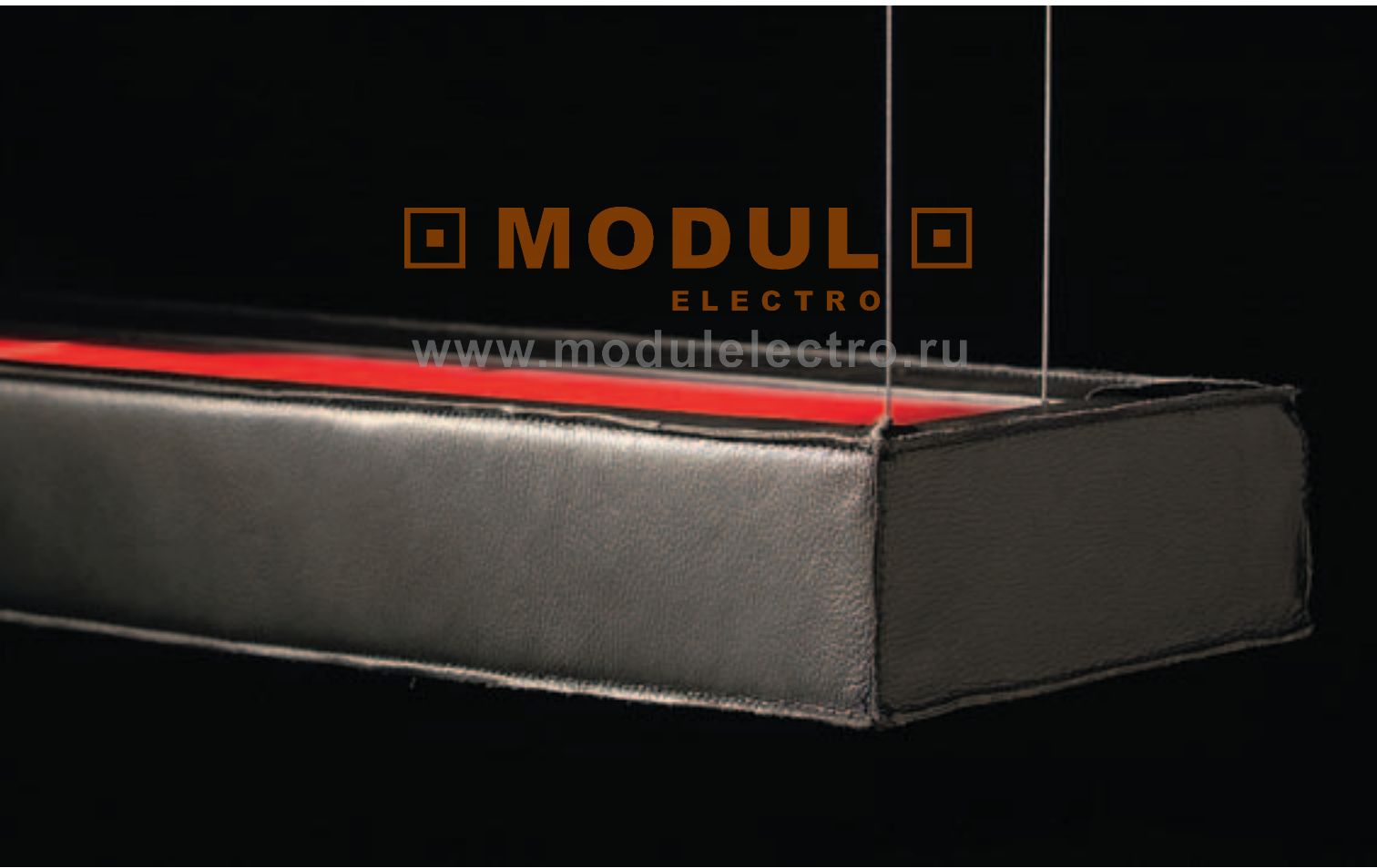

d-LEATHER black -1xT16 (54W) - up red

MODULO ELECTRO

www.modulelectro.ru

BODY (Leather)



UPLIGHT PLEXI



d-LEATHER

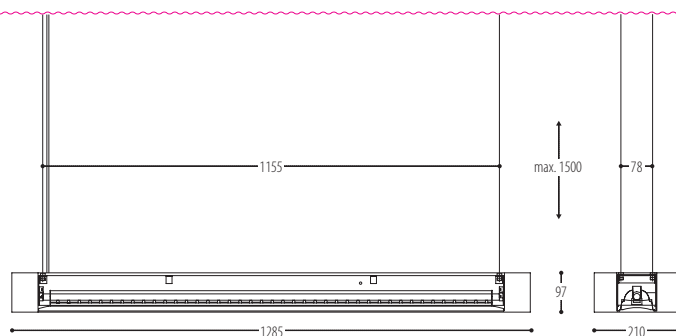

d-LEATHER 1xT16 54W

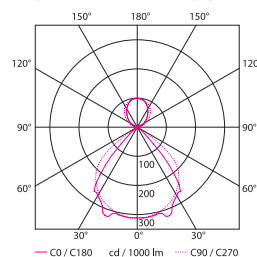

Efficiency factor: 81,2%

PROJECT PAGES:

081

d-SQUEEZE

design Ivan Missinne for Dark





d-SQUEEZE MODUL ELECTRO

www.modulelectro.ru

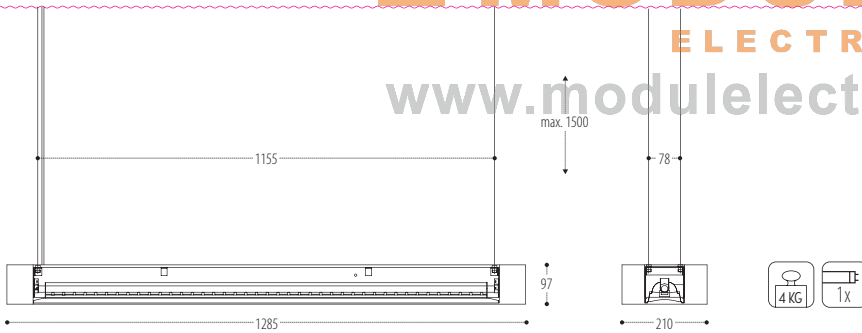

d-SQUEEZE double

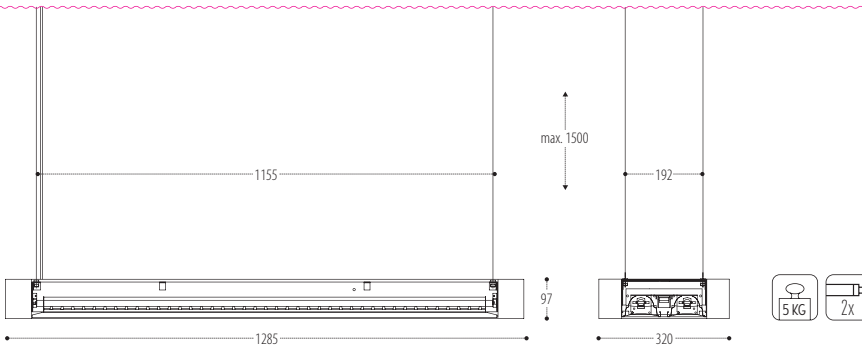

BODY (foam)

- White
- Choco
- Red
- Sky
- Olive
- Apple

UPLIGHT PLEXI

- Clear
- Red
- Blue
- Green

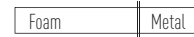

- T16 (28 W) / G5
- T16 (54 W) / G5

-
-
-
-
-
-
-
-
-
-
-
-

d-SQUEEZE double 2xT16 54W

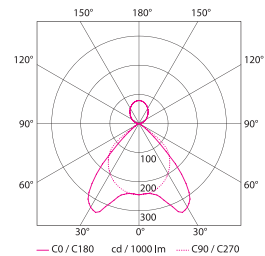

Efficiency factor: 75,83%

PROJECT PAGES:
114 - 144

D2V2

design Danny Venlet for Dark



reddot design award
winner 2003



Designpreis der
Bundesrepublik
Deutschland
Nominiert 2004



 **MODUL** 
ELECTRO

www.modulelectro.ru



MODUL
ELECTRO

www.modulelectro.ru

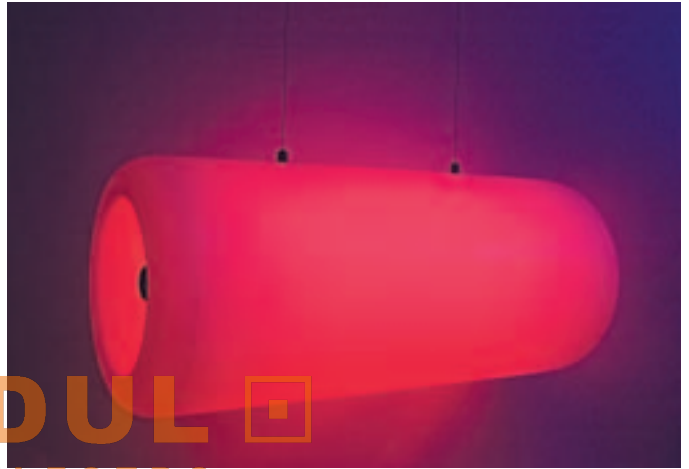

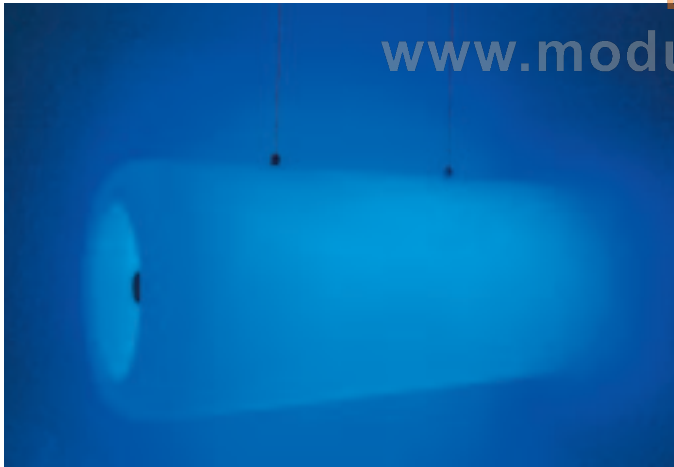

red coloured bulbs



blue coloured bulbs

green coloured bulbs

 **MODUL** 
ELECTRO
www.modulelectro.ru

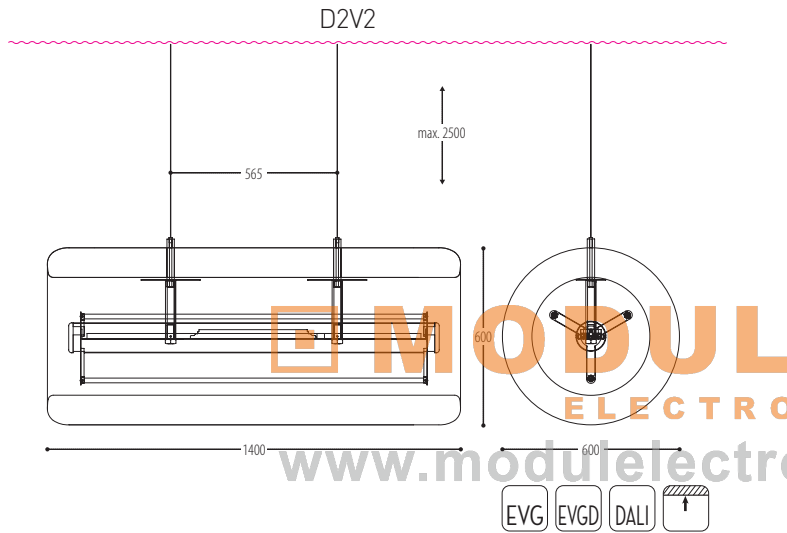

MODULE
ELECTRO

www.modulelectro.ru

D2V2 FLOOR

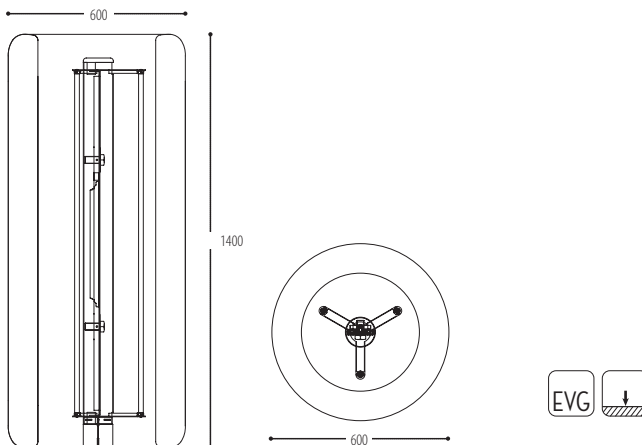

BODY



WITH COLOURED BULBS



D2V2 3x54W

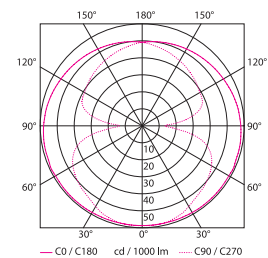

Efficiency factor: 64,4%

PROJECT PAGES:

012 - 026 - 028 - 063 - 117 - 138 - 143 -
155 - 180 - 185

FRANJE

design Marcel Reulen for Dark

MODUL
ELECTRO
www.modulelectro.ru



FRANJE FLOOR white



FRANJE TABLE white

FRANJE S black

 **MODUL** 
ELECTRO
www.modulelectro.ru



MODUL

ELECTRO FRANJE TABLE

www.modulelectro.ru

FRANJE WALL

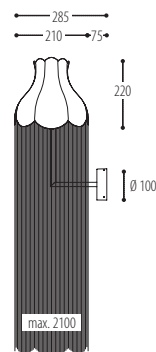
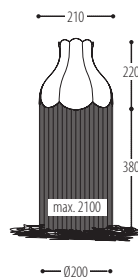

FRANJE FLOOR

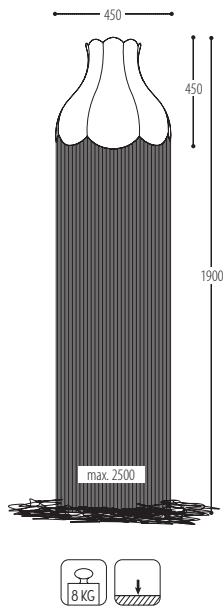

FRANJE S

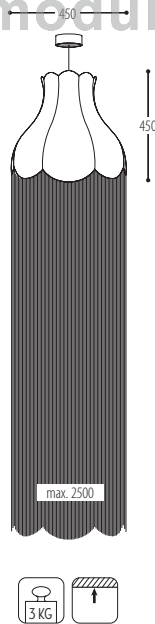

MODUL

ELECTRO

www.modulelectro.ro

FABRICS - flame retardant

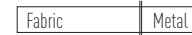

FRANJE TABLE / FRANJE WALL

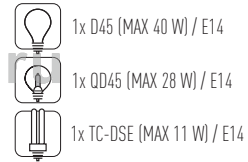

FRANJE FLOOR / FRANJE S





PROJECT PAGES:

060 - 064 - 073 - 096 - 162 - 169 - 170

GUM

design Claesson-Koivisto-Rune for Dark

 **MODUL** 
ELECTRO
www.modulelectro.ru

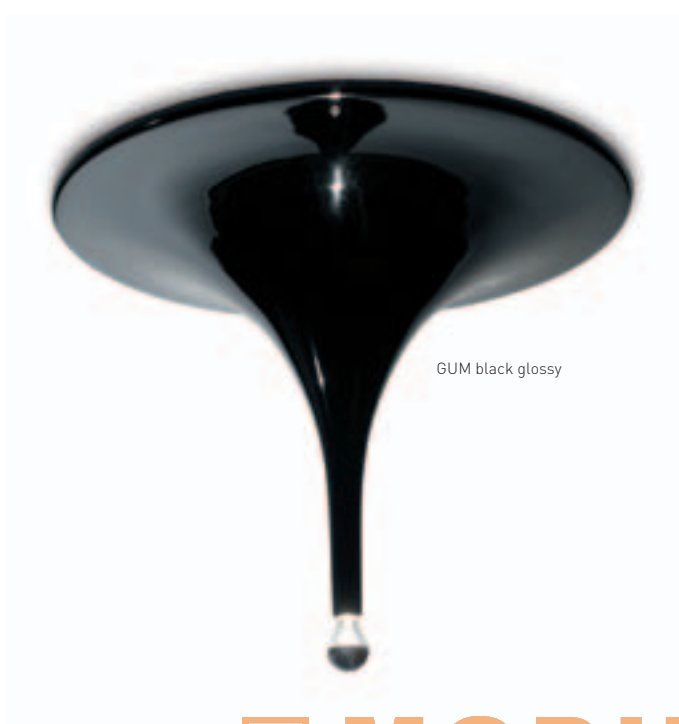

GUM black glossy

MODULO

ELECTRO

www.modulelectro.ru

 White glossy

 Black glossy

 On request

Polyester | Metal

 1x A60-CS-G (MAX 60 W) / E27



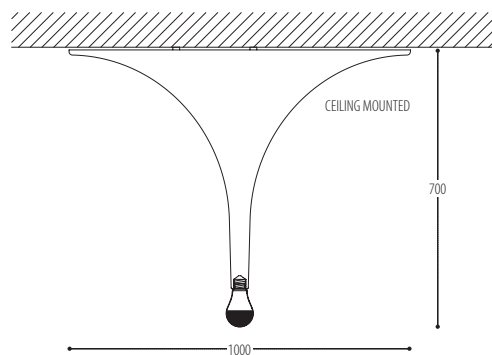

HEAPS

design Marnick Smessaert for Dark

HEAPS 2 print 03







 **MODUL** 
HEAPS BOX
print.05
ELECTRO
www.modulelectro.ru



HEAPS 2 red



HEAPS 2 wood

 **MODUL** 
ELECTRO
www.modulelectro.ru

YOU CAN CREATE YOUR OWN HEAPS PRINT

from digital photo

Specifications digital photo:
dimensions: 1085 x 150mm
resolution: 300 dpi
colour mode : CMYK
format : JPG, TIFF, PDF, EPS

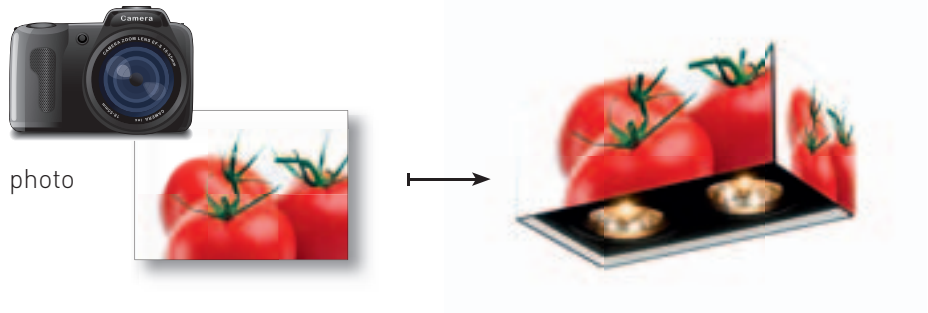

MODUL
ELECTRO

from graphics vector document

www.modulelectro.ru

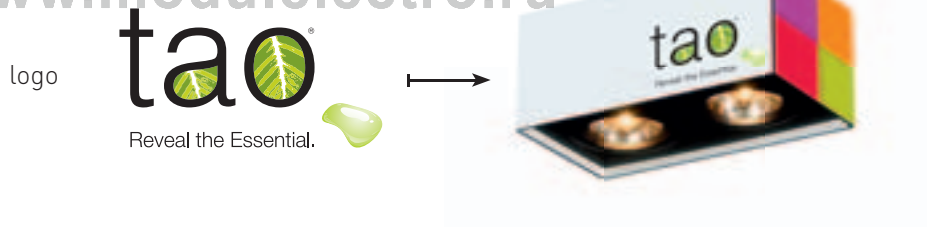

drawing

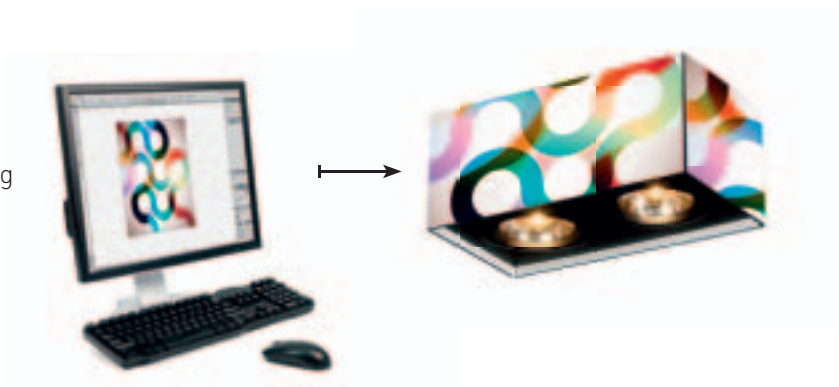

PRINTS

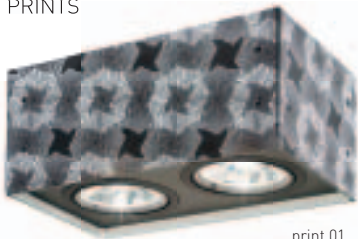

print 01

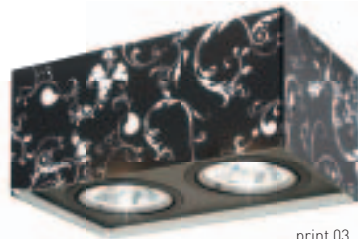

print 03

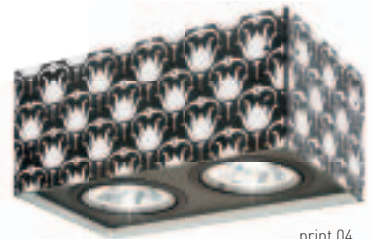

print 04



print 05



print 06

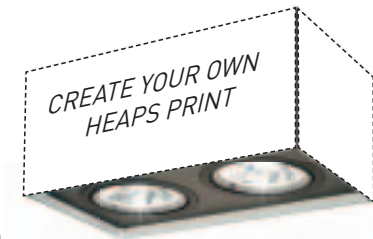

MODULO
ELECTRO

HEAPS 2

HEAPS 3

www.modulelectro.ru

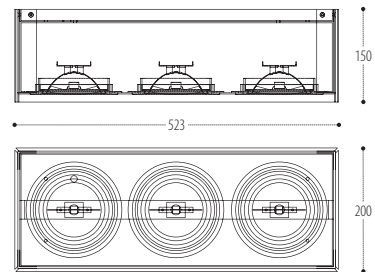
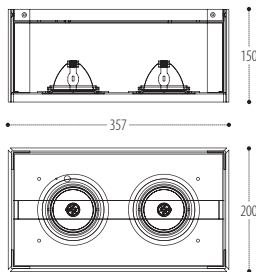

	2x QR-LP111 (MAX 45 W) / G53	DOWN black
	2x HIT-TC-CE (20 W or 35 W) / PGJ5	white

	3x QR-LP111 (MAX 45 W) / G53	DOWN black
	3x HIT-TC-CE (20 W or 35 W) / PGJ5	white



red



gold



white



wood

MODUL
ELECTRO

HEAPS 4

HEAPS 4 BOX

www.modulelectro.ru

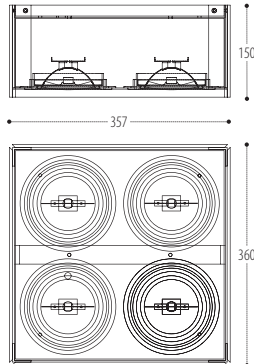
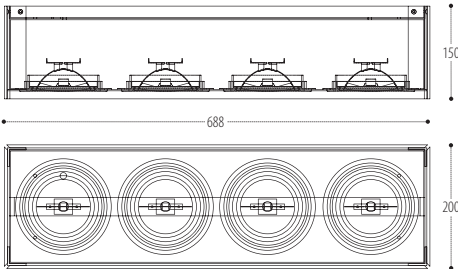

		DOWN HEAPS 4	DOWN HEAPS 4 BOX
	4x QR-LP111 (MAX 45 W) / G53	black	black
	4x HIT-TC-CE (20 W or 35 W) / PGJ5	white	white

AW | Metal

QR-LP111 (MAX 45 W) / G53

HIT-TC-CE (20 W or 35 W) / PGJ5



QR-LP111 45W-22°

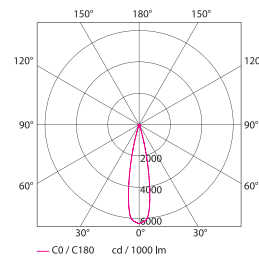

Efficiency factor: 100%

QR-LP111 45W-45°

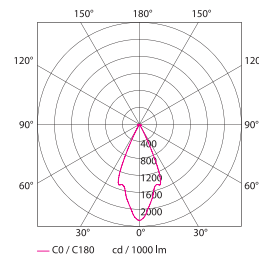

Efficiency factor: 100%



PROJECT PAGES:

138

HERBERT

design Fabien Dumas for Dark



 **MODUL** 
ELECTRO
www.modulelectro.ru

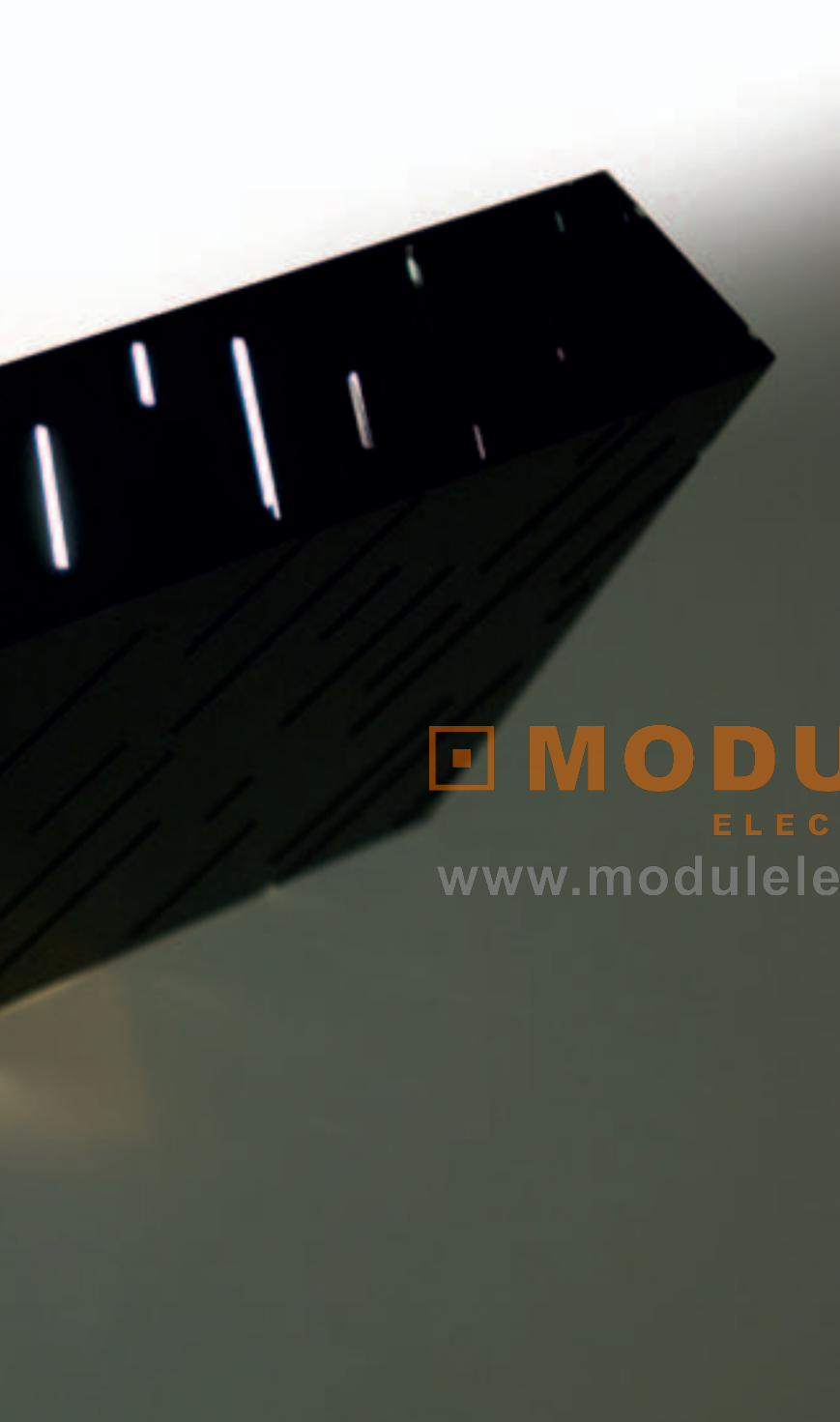

MODUL
ELECTRO
www.modulelectro.ru

HERBERT 02 black

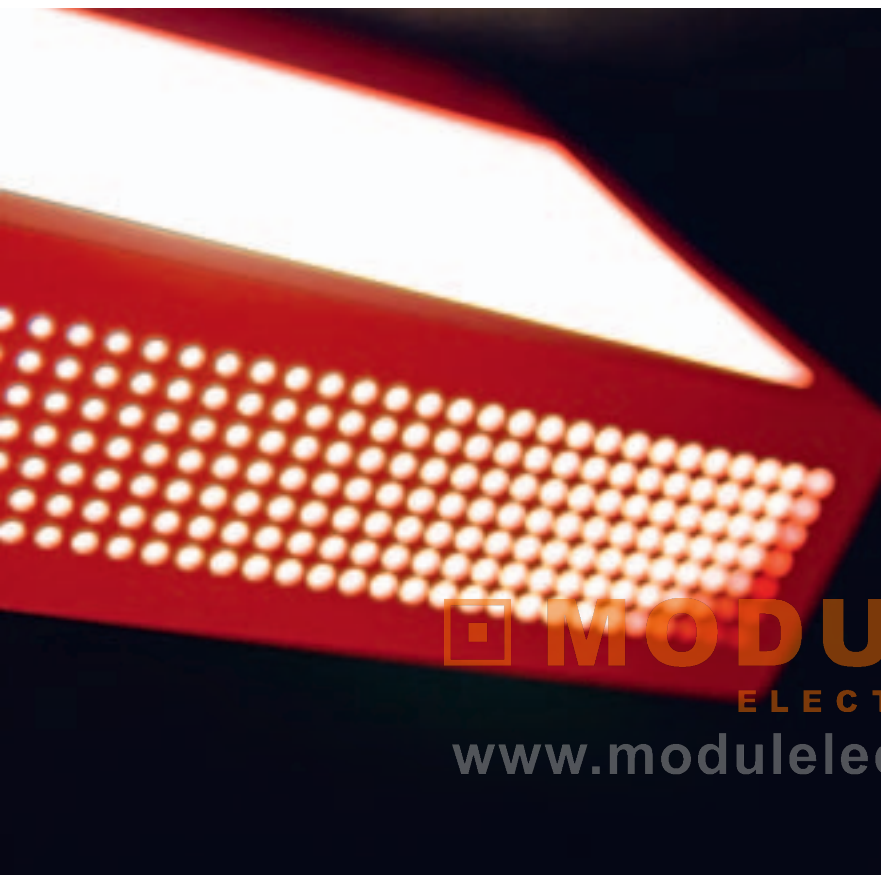

HERBERT 03 red



HERBERT 02 white

MODUL
ELECTRO
www.modulelectro.ru

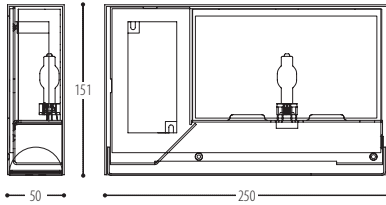

HERBERT can easily be switched from down to upright due to the magnet.

HERBERT 01

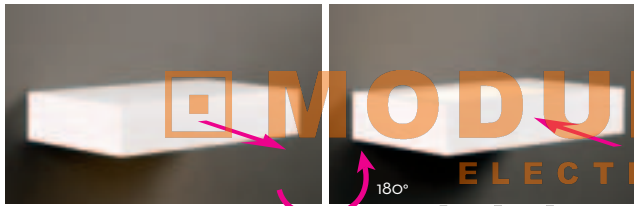

HERBERT 02

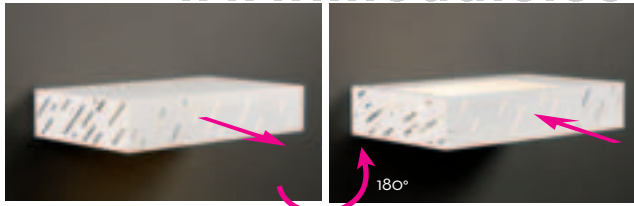

HERBERT 03

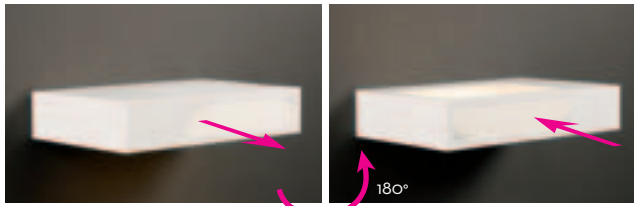

HERBERT 04

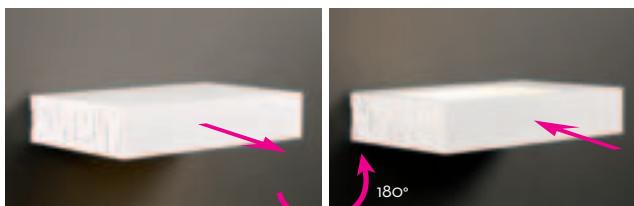

HERBERT 01 HIT-TC-CE

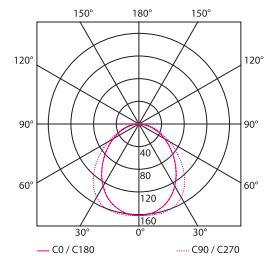



Efficiency factor: 42,8%

HOEK

design Jos Devriendt for Dark



 **MODUL** 
ELECTRO
www.modulelectro.ru

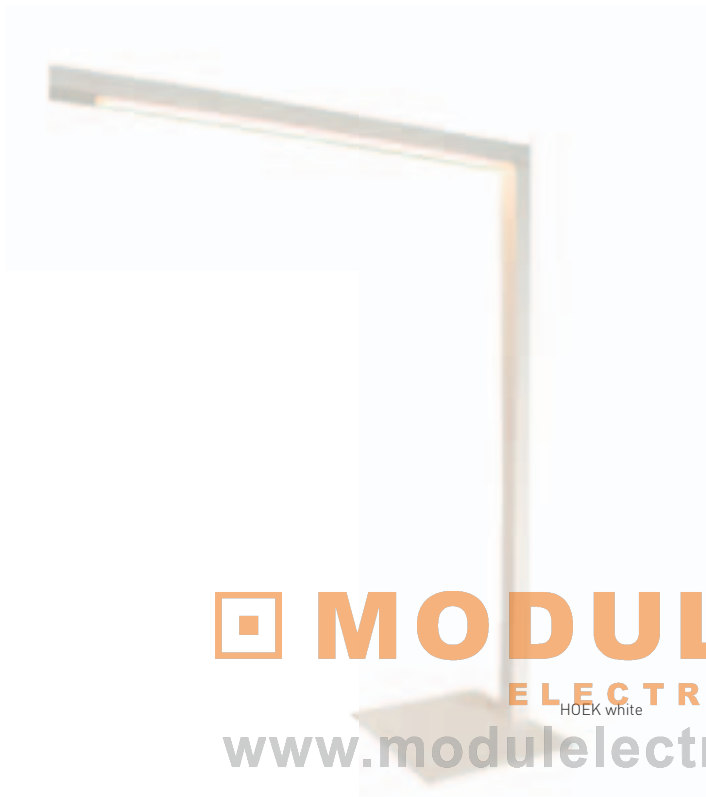

MODUL

ELECTRO

HOEK white

www.modulelectro.ru



White



Black

Metal

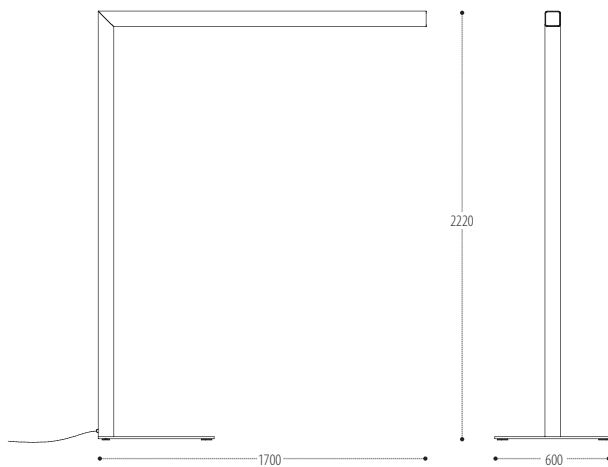

1x T16 (35 W) / G5

1x T16 (49 W) / G5

OPTIONAL

BAP 60°

OPAL



HOPPY

design Boo for Dark



DESIGNPREIS
2009
NOMINIERT



 **MODUL** 
ELECTRO

www.modulelectro.ru





MODUL
ELECTRO
www.modulelectro.ru



MODUL
ELECTRO
www.modulelectro.ru



HOPPY
white

HOPPY black



HOPPY
orange

HOPPY
red

HOPPY
black

MODUL
ELECTRO

www.modulelectro.ru

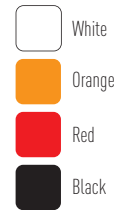

-  1x A60 (MAX 60 W) / E27
-  1x QA60 (MAX 42 W) / E27
-  1x TCA-SE (MAX 11 W) / E27

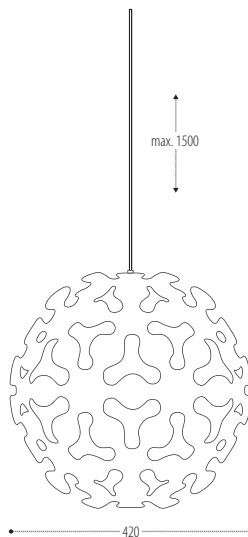



PROJECT PAGES:

025 - 059 - 061 - 068 - 069 - 100 - 101 -
142 - 148 - 188

100

HYPE

design Anthony Duffeleer for Dark



 **MODUL** 
ELECTRO
www.modulelectro.ru



MODUL
ELECTRO
www.modulelectro.ru



HYPE white

 **MODULO** 
ELECTRO
www.modulelectro.ru

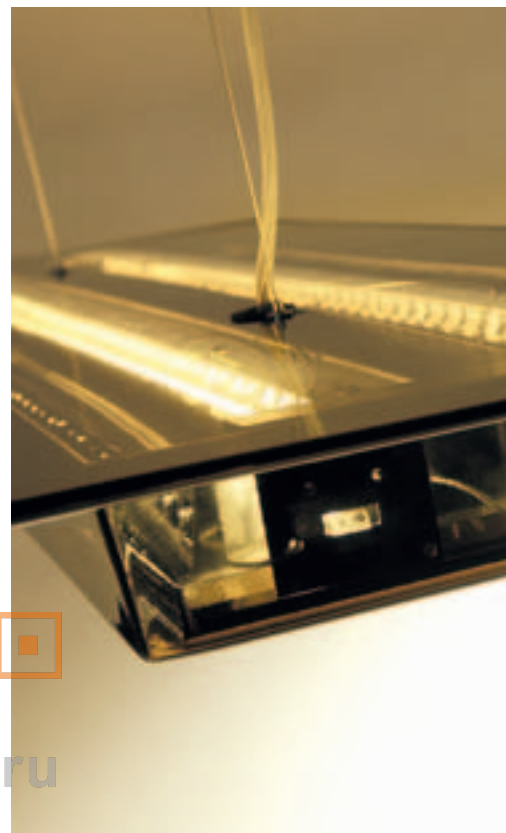

HYPE mokka



MODUL
ELECTRO
www.modulelectro.ru

- Orange
- White
- Mokka

PMMA | Metal

 2x T16 (28 W) / G5

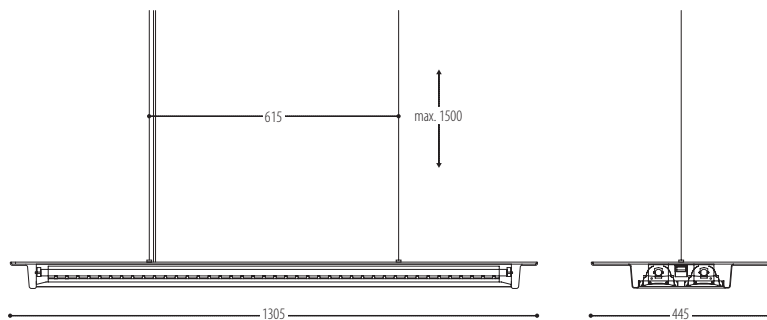

HYPE 2x28W

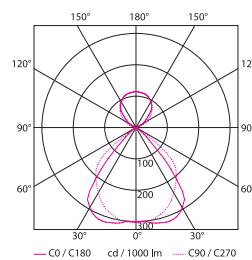

Efficiency factor: 82,6%

ICE

design Anthony Duffeleer for Dark

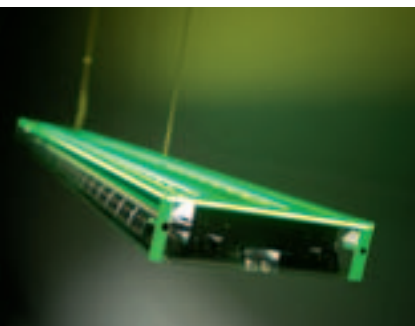

ICE - up blue - up red & up green ICE - up transparent

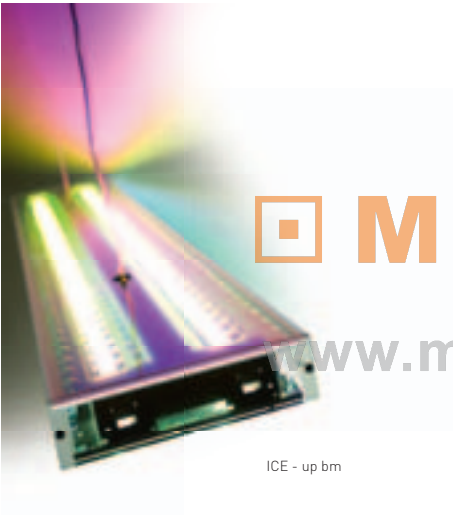

ICE - up bm

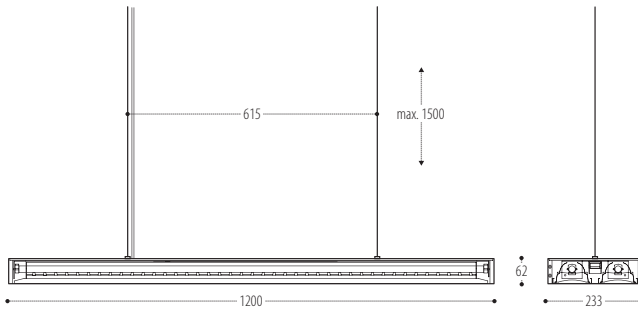

BODY



UPLIGHT PLEXI

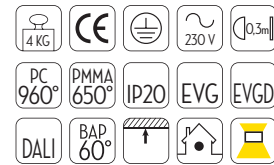
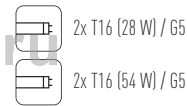
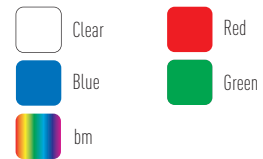

ICE 2x54W

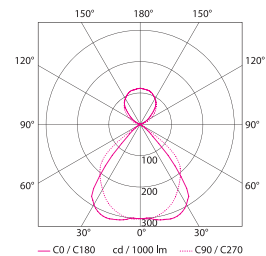

Efficiency factor: 82,6%

PROJECT PAGES:

013 - 040 - 047 - 069 - 089 - 094 - 099 -
131 - 147 - 176 - 183 - 186 - 191

JOHN PAWSON LAMP

design John Pawson for Dark



DESIGNPREIS
2009
NOMINIERT



USA 2007



MODUL
ELECTRO
www.modulelectro.ru

JOHN PAWSON
FLOOR LAMP

JOHN PAWSON
TABLE LAMP

MODUL
ELECTRO

www.modulelectro.ru

BODY

 Plexi

PMMA | PC

 D45 (MAX 40 W) / E14

 QD45 (MAX 28 W) / E14

 TCA-SE (MAX 7 W) / E14

 LED (MAX 7 W) / E14

   

   

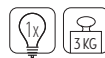
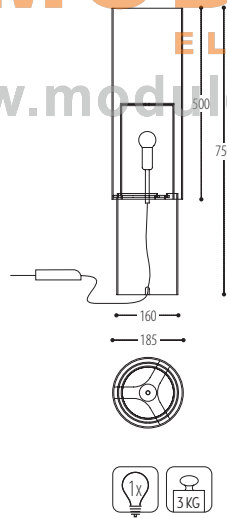
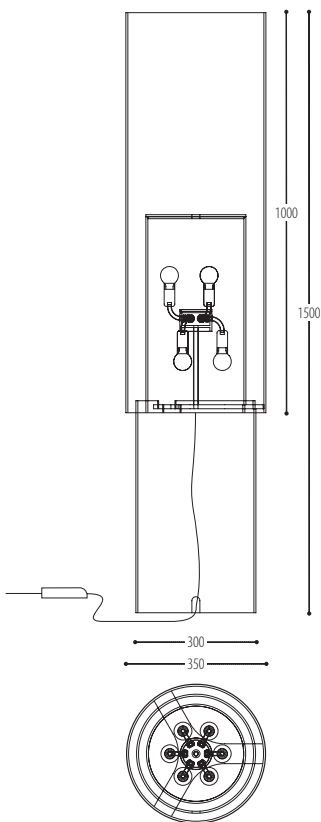

JUICE

design Ivan Missinne for Dark

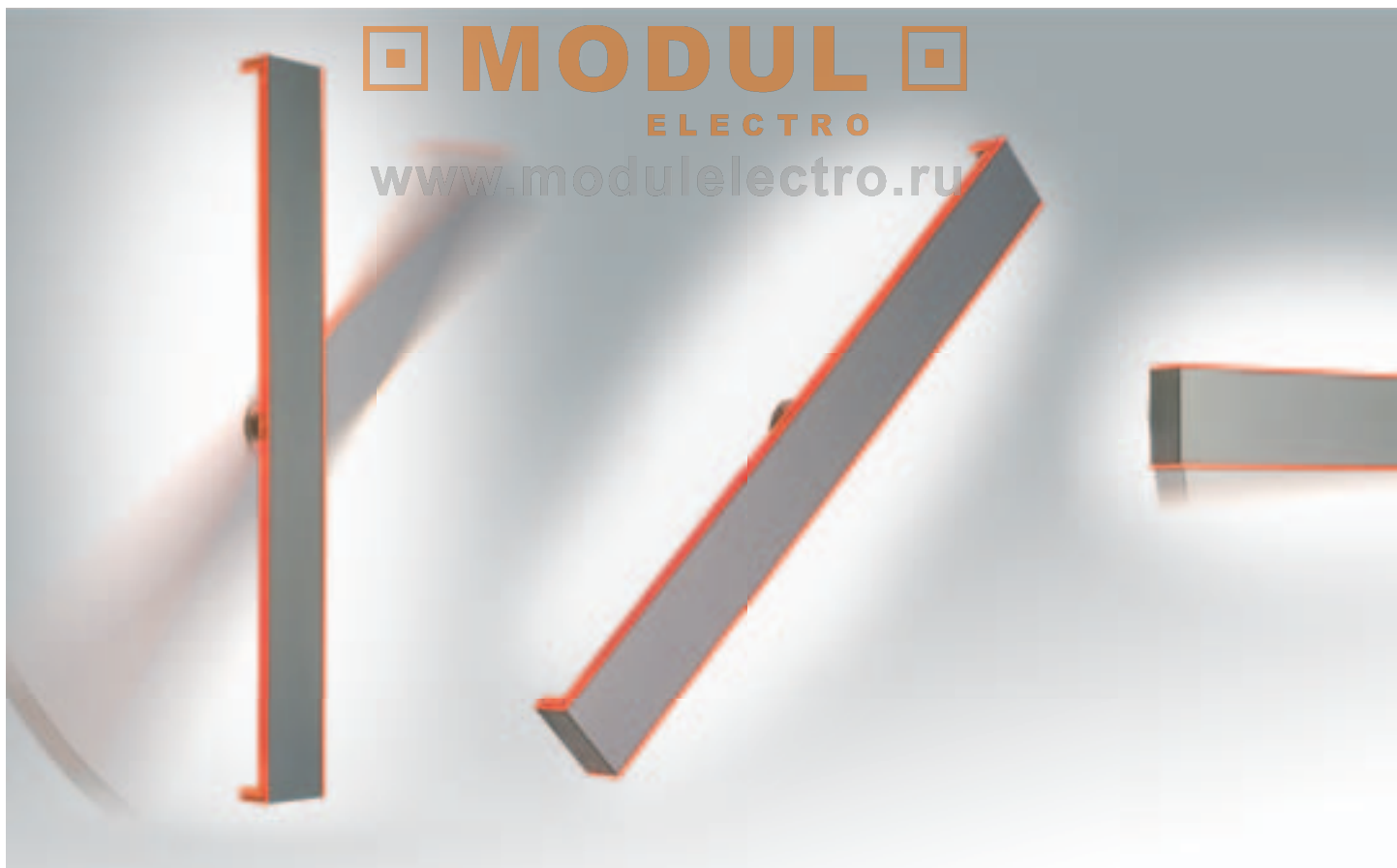

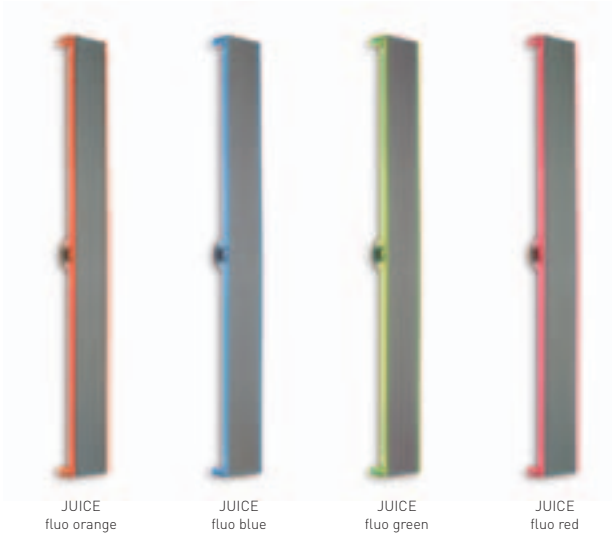

MODUL ELECTRO

www.modulelectro.ru

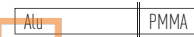

JUICE 2x28W

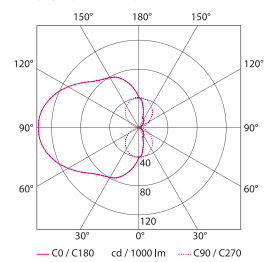

Efficiency factor: 49,74%

KNARF

design Frank Janssens for Dark



reddot design award
honourable mention 2009



MODUL
ELECTRO
www.modulelectro.ru

KNARF

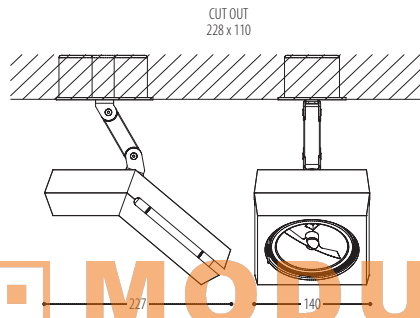

MODULO
ELECTRO
www.modulelectro.ro

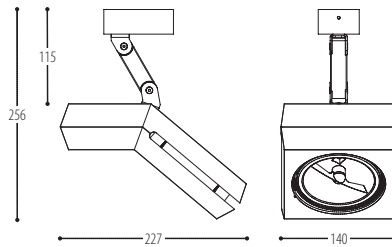

KNARF TRACK

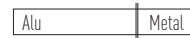
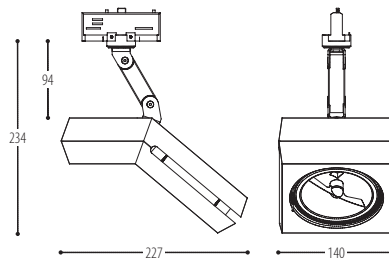

	1x QR-LP111 (MAX 45 W) / G53		
	1x HIR-CE111 (35 W) / GX8,5		
	1x HIR-CE111 (70 W) / GX8,5		

ACCESSORIES



QR-LP111 45W-22°

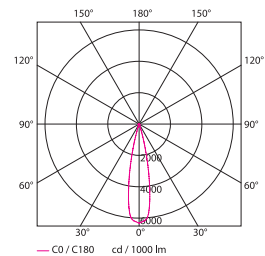



Efficiency factor: 100%

112

KNIK

design Jos Devriendt for Dark

 **MODUL** 
ELECTRO
www.modulelectro.ru



MODULO

ELECTRO

www.modulelectro.ru

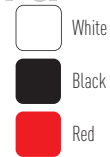
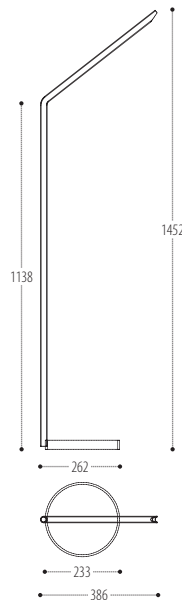

Metal



PROJECT PAGES:
183

LA CAGE

design Stefan Schöning for Dark

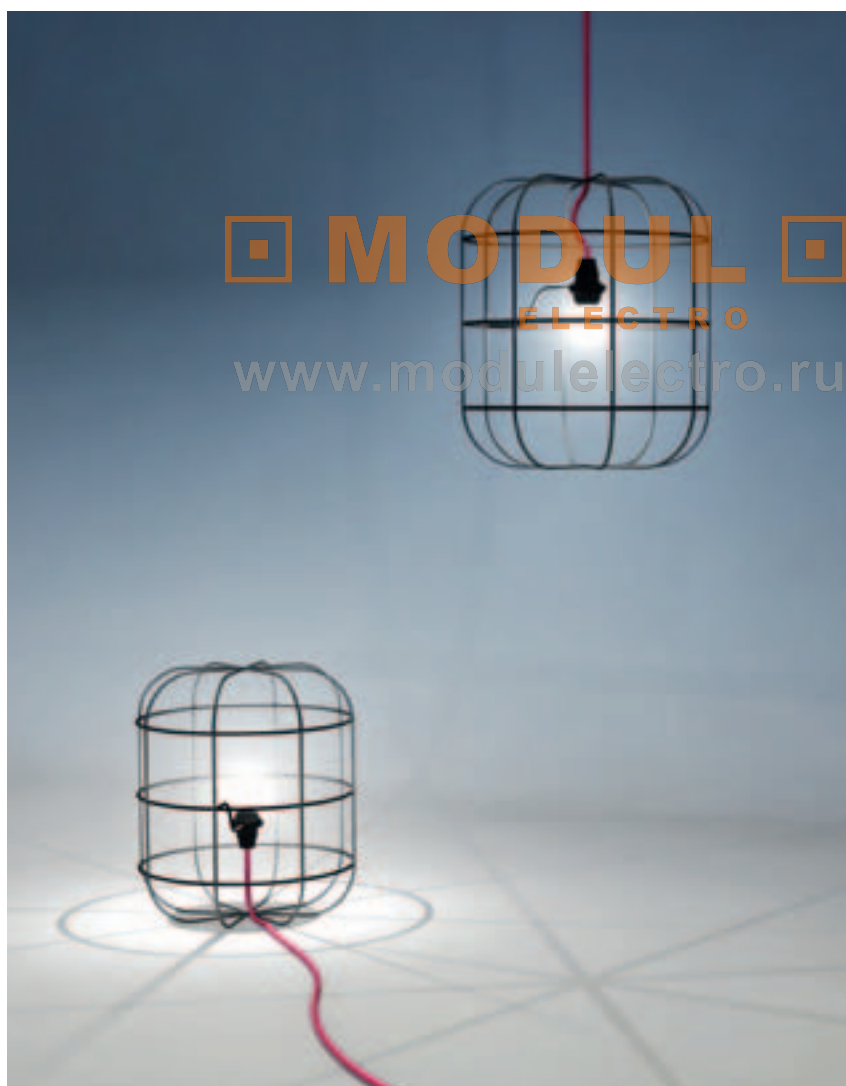

MODULO

ELECTRO

www.modulelectro.ru



Black



Metal

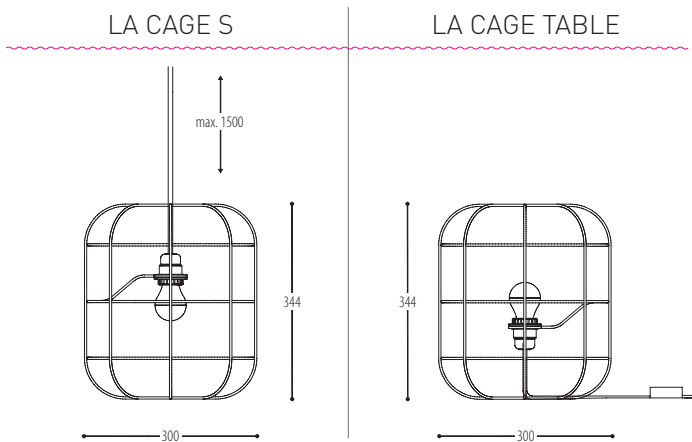

1x D45 (MAX 40 W) / E14



1x OD45 (MAX 28 W) / E14



1x TCA-SE (MAX 7 W) / E14



1x LED (MAX 7 W) / E14



LA CAGE S



LA CAGE TABLE



PROJECT PAGES:

119

L-BOW

design Lars Pettersson and Morgan Rudberg for Dark



MODUL
ELECTRO
www.modulelectro.ru

MODUL

ELECTRO

www.modulelectro.ru



White



Black

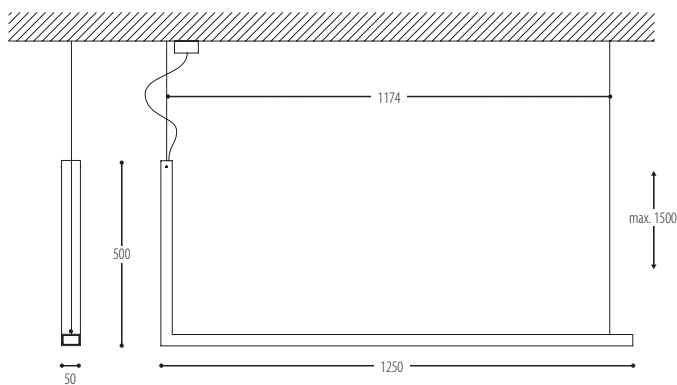

1x T16 (28 W) / G5



1x T16 (54 W) / G5





LGTM-X01



design Carl Hagerling for Dark



USA 2010

 **MODUL** 
ELECTRO
www.modulelectro.ru



 **MODUL** 
ELECTRO
www.modulelectro.ru



MODUL
ELECTRO
www.modulelectro.ru

MODUL

ELECTRO

www.modulelectro.ru

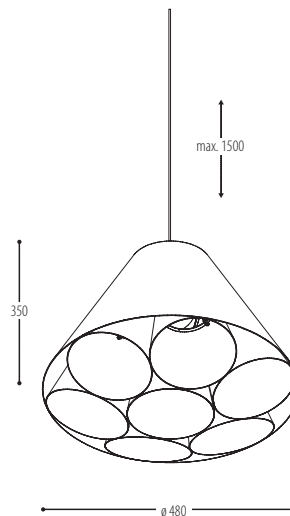

BODY



White

Black

INSIDE



Gold



Metal





PROJECT PAGES:

018 - 182

122

LOOP

design Petter Knudsen for Dark

 **MODUL** 
ELECTRO
www.modulelectro.ru



USA 2008

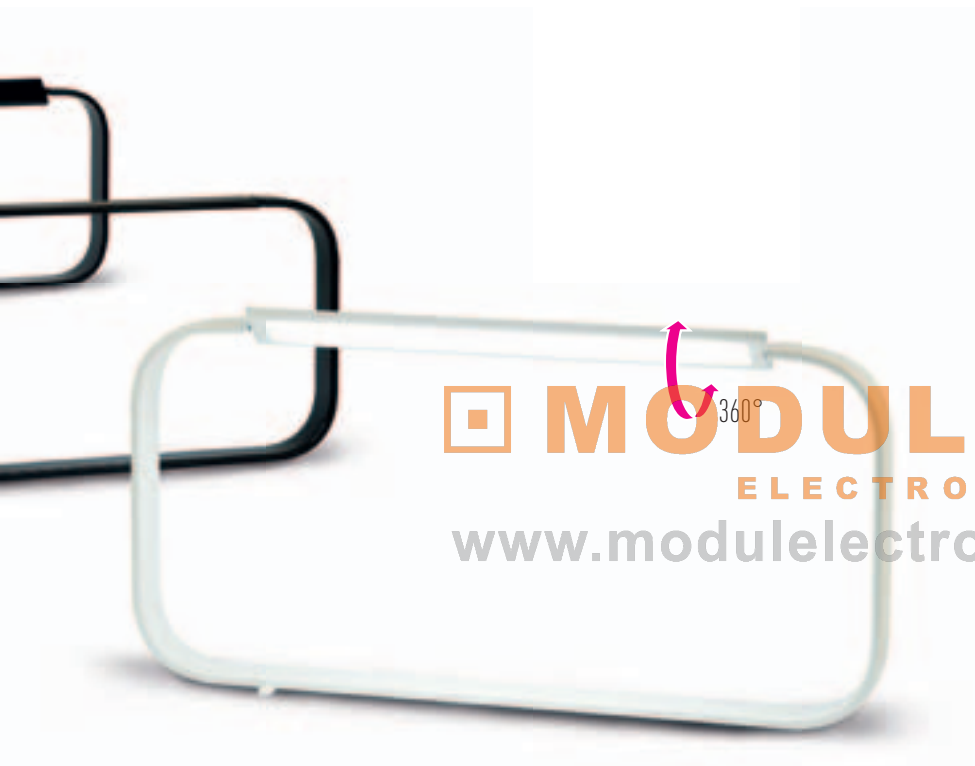

MODULO
ELECTRO
www.modulelectro.ru

- White
- Black
- Chrome

Alu

LED Colour temp 3500K / 15 W

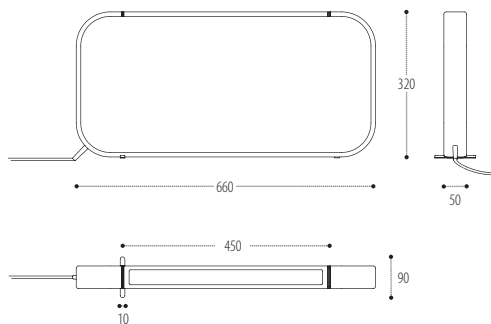



-
-

METROPOLIS

design Chris Jackson for Dark



 **MODUL** 
ELECTRO
www.modulelectro.ru

Metropolis



MODUL

ELECTRO

www.modulelectro.it

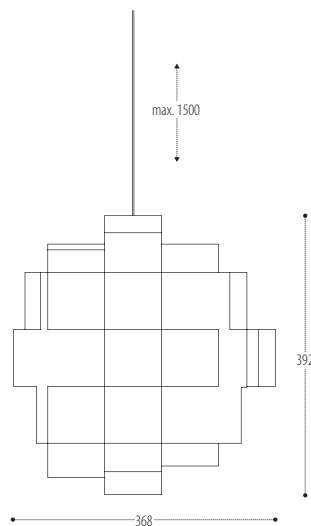

BODY

 Transarant white

 PE | Metal

 1x A60 (MAX 60 W) / E27

 1x QA60 (MAX 42 W) / E27

 1x TCA-SE (MAX 11 W) / E27



METROPOLIS

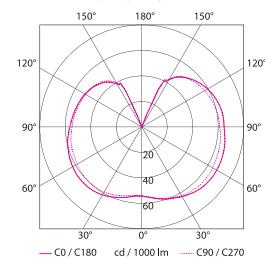

Efficiency factor: 71,5%

PROJECT PAGES:

002 - 074 - 157 - 178

NO COPY

design Anthony Duffeleer for Dark



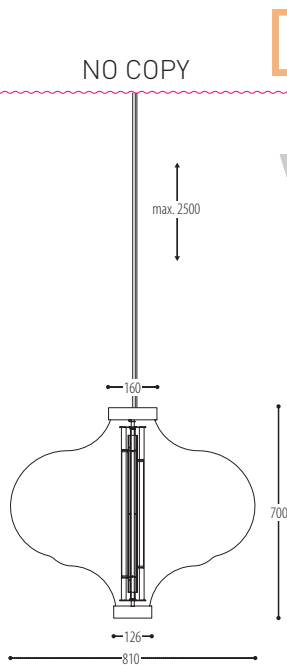

MODUL ELECTRO

www.modulelectro.ro

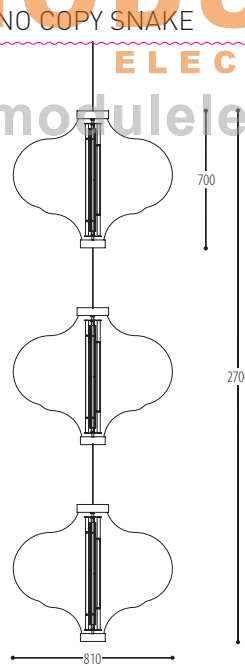

BODY



WITH COLOURED BULBS



On request other colours possible with colourfilters



NO COPY 3x24W

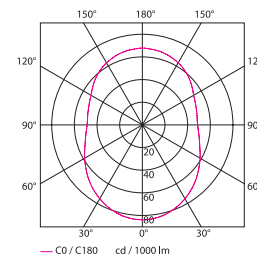

Efficiency factor: 72,8%

PROJECT PAGES:

015 - 017 - 052 - 139 - 149 - 156 - 184

NO FRUIT

design Anthony Duffeleer for Dark





www.modulelectro.ru



MODUL
ELECTRO

www.modulelectro.ru



 **MODUL** 
ELECTRO
www.modulelectro.ru

NO FRUIT - fix colour with colour bulbs or changing colours with LED-technology



MODUL
ELECTRO

www.modulelectro.fr

BODY

 Transparant white

WITH COLOURED BULBS

 Red  Blue  Green

On request other colours possible with colourfilters

 PE  Metal

 3x T16 (21 W) / G5

 3x T16 (39 W) / G5

 LED



NO FRUIT 3x39W

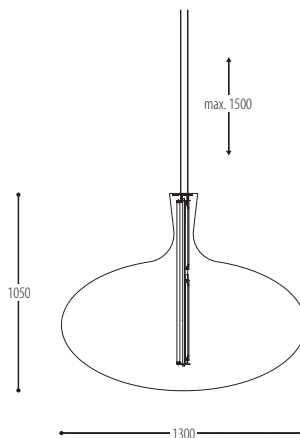

Efficiency factor: 57,5%

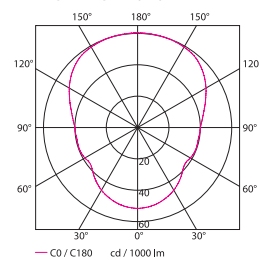
PROJECT PAGES:

002 - 012 - 015 - 017 - 023 - 084 - 096 -
099 - 115 - 116 - 125 - 145 - 172 - 181 -
187

NO FRUIT bling bling

designed for the celebration of 5 years Dark





MODUL
ELECTRO
www.modulelectro.ru

BODY

960 Swarovski stones

Swarovski | Metal

3x T16 (21 W) / G5

3x T16 (39 W) / G5



LED





OBLIVION

design Arne Quinze for Dark

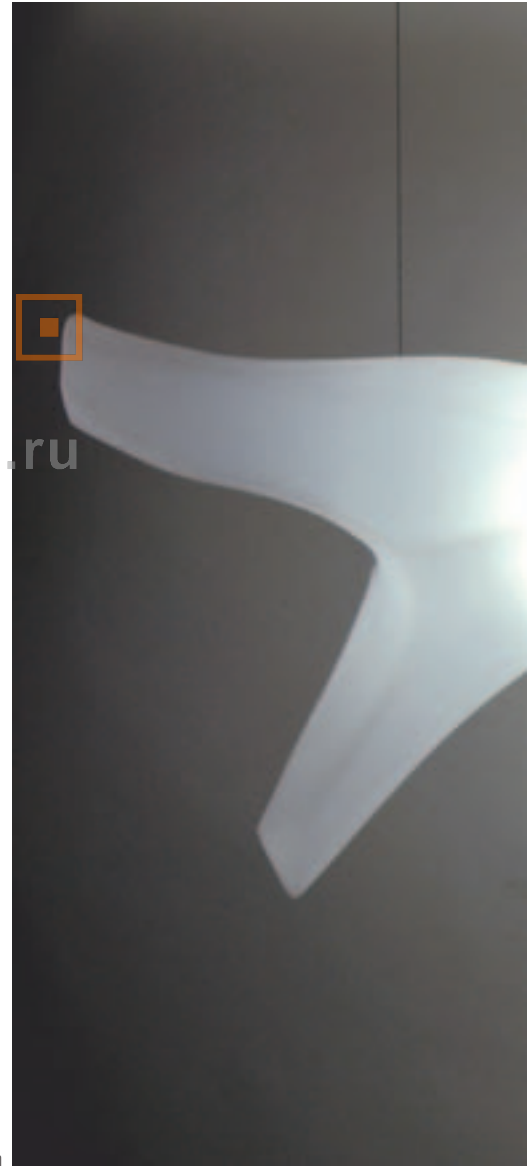

 **MODUL** 
ELECTRO
www.modulelectro.ru





MODUL
ELECTRO
www.modulelectro.ru



MODUL
ELECTRO
www.modulelectro.ru

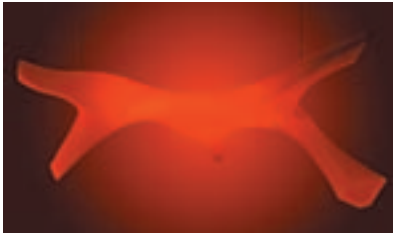

OBLIVION red bulbs



OBLIVION blue bulbs

MODUL
ELECTRO

www.modulelectro.ru

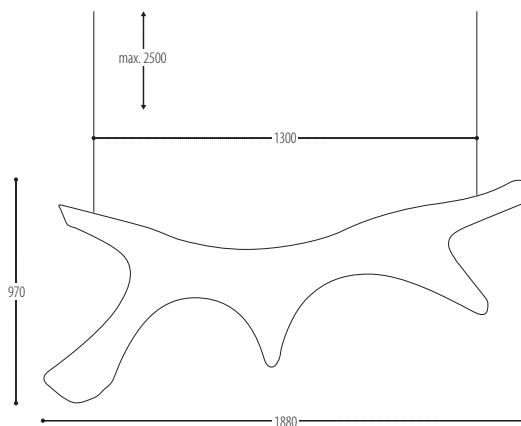

BODY

 Transparant white

WITH COLOURED BULBS

 Red  Blue  Green

On request other colours possible with colourfilters



 3x T16 (21 W) / G5

 3x T16 (39 W) / G5

 LED



OBLIVION 3x21W

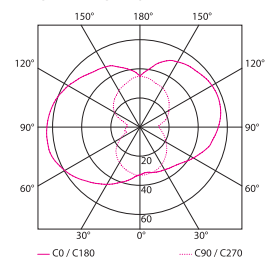

Efficiency factor: 48,8%

PROJECT PAGES:



009 - 041 - 052 - 103 - 105 - 122 - 136 - 166

138

PANTY

design Sem de l'Anverre &
Kris Henkens for Dark



 **MODUL** 
ELECTRO
www.modulelectro.ru

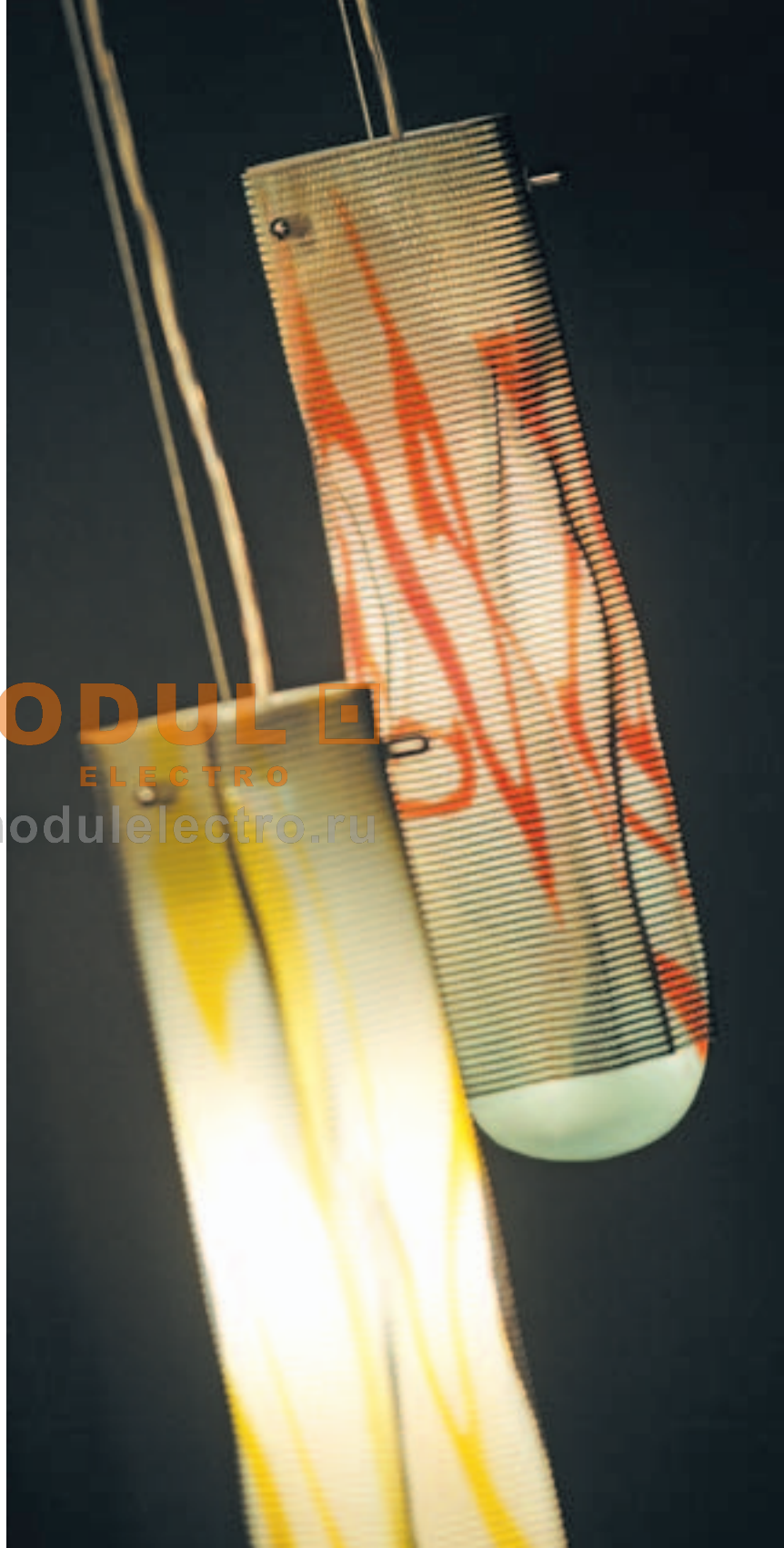



PANTY
white / yellow

PANTY
white / orange

PANTY
white / red

MODUL ELECTRO

www.modulelectro.ru



White / Yellow



White / Orange



White / Red

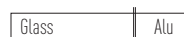

1x A60 (MAX 60 W) / E27



1x OA60 (MAX 42 W) / E27



1x TCA-SE (MAX 11 W) / E27



1x LED (MAX 7 W) / E27

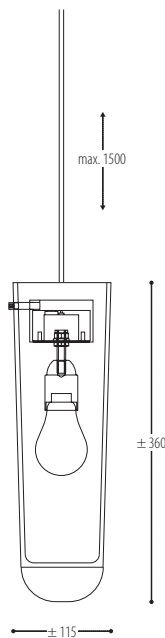



PROJECT PAGES:

134

PAROQ

design Oldsjö Hultgren for Dark



 **MODUL** 
ELECTRO
www.modulelectro.ru

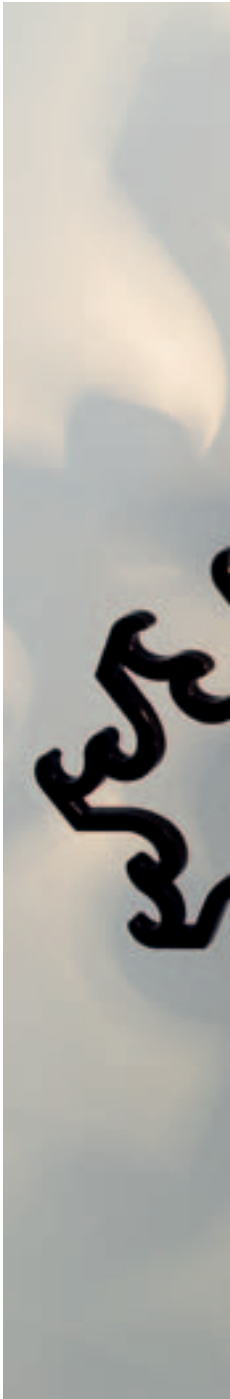



MODUL
ELECTRO
www.modulelectro.ru

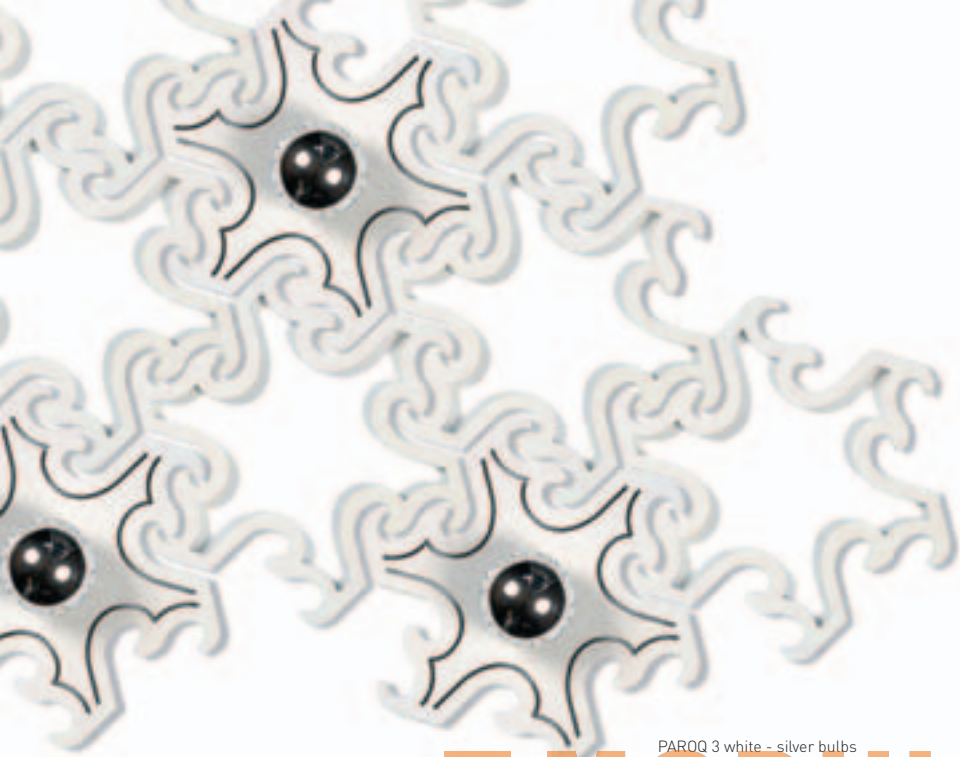

PAROQ 3 white - silver bulbs

MODULO

ELECTRO

www.modulelectro.ru

PAROQ 1

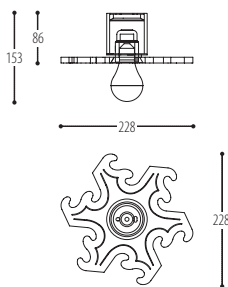

PAROQ 2

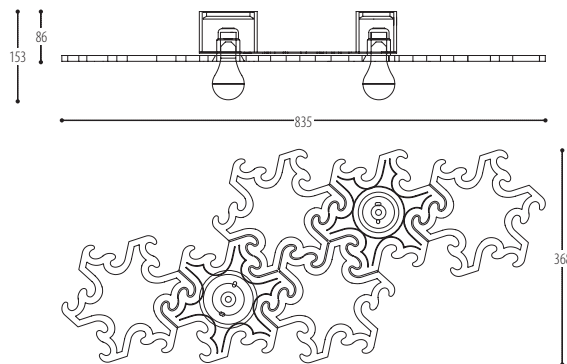

MODUL
ELECTRO

www.modulelectro.ru

PAROQ 3

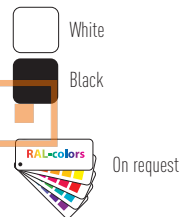
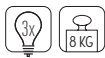
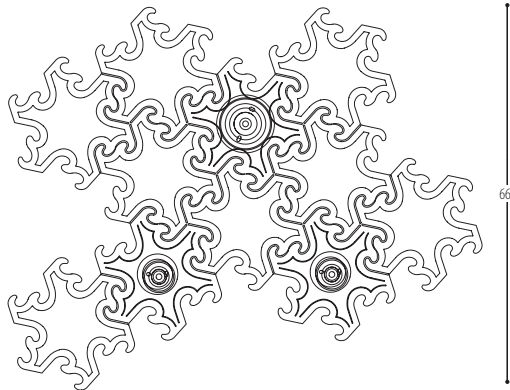
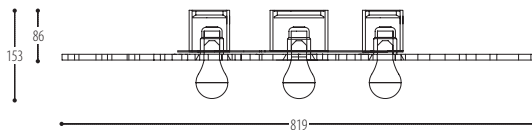

Alu

SILVER BULB

 A60-CS-G (MAX 60 W) / E27

 TCA 60-CS/G (MAX 7 W) / E27

GOLDEN BULB

 A60-CS-G (MAX 60 W) / E27

 TCA 60-CS/G (MAX 7 W) / E27





PROJECT PAGES:
133 - 164 - 165

PAWWW

design Christophe De Ryck for Dark



reddot design award
winner 2009

 **MODUL** 
ELECTRO
www.modulelectro.ru

PAWWW white

MODUL

ELECTRO

www.modulelectro.it

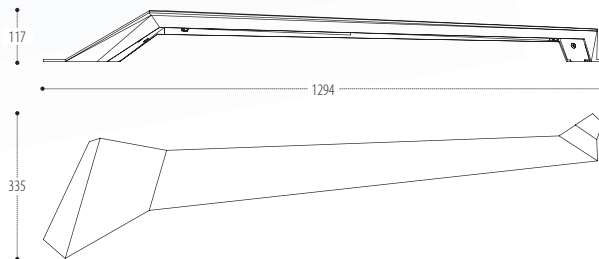

White



Black



On request



Alu



2x T16 (21 W) / G5



2x T16 (39 W) / G5



6 KG



PAWWW WHITE 2x39W

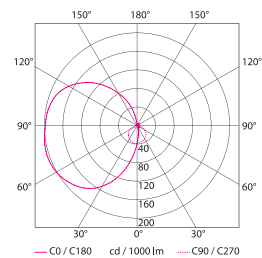

Efficiency factor: 67,6%

POC

design Johanna Lindgren & Helen Högberg for Dark



DESIGN PLUS
2006



MODUL ELECTRO

www.modulelectro.it

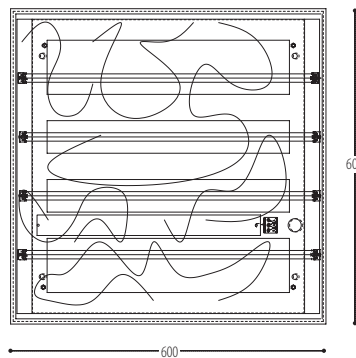
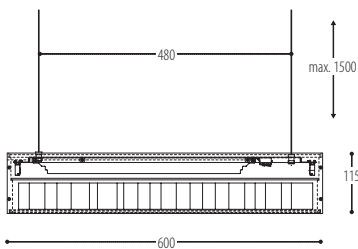

BODY



FILLING

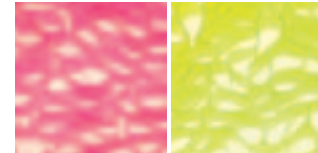

fluo red strings

fluo green strings

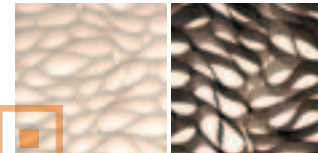

white fabrics

silver fabrics

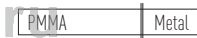

POC 4x14W

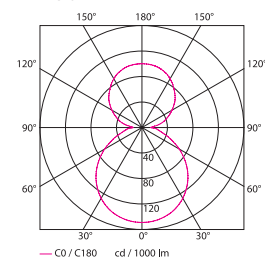

Efficiency factor: 80,5%

PROJECT PAGES:

069 - 093 - 095 - 113 - 146 - 150 - 151 - 190

ROSET

design Frederike Top for Dark



MODUL
ELECTRO
www.modulelectro.ru



ROSET white
silver bulb



ROSET alu
silver bulb



ROSET black
golden bulb

MODUL
ELECTRO

www.modulelectro.ro

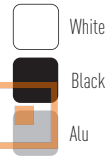

Metal

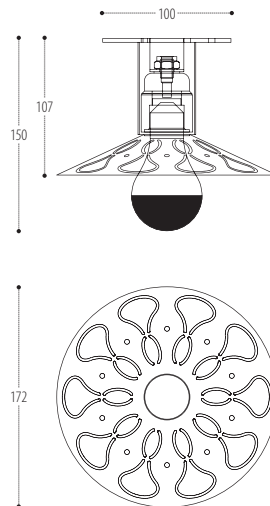

SILVER BULB

A60-CS-G (MAX 60 W) / E27

TCA 60-CS/G (MAX 7 W) / E27

GOLDEN BULB

A60-CS-G (MAX 60 W) / E27

TCA 60-CS/G (MAX 7 W) / E27



PROJECT PAGES:
061

150

R&S

design JP Meulendijks for Dark





R&S black

MODULO

ELECTRO

www.modulelectro.ru







White

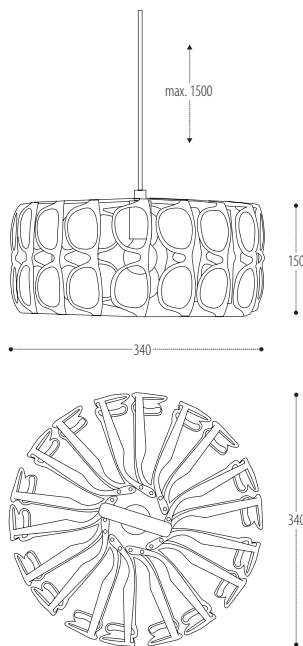

Black

Plastic	Alu
---------	-----





-  1x D45 (MAX 60 W) / E14
-  1x QD45 (MAX 42 W) / E14
-  1x TCA-SE (MAX 7 W) / E14

				
				

SLITE

design Karen & Vince for Dark

 **MODULO** 
ELECTRO
www.modulelectro.ru





MODUL
ELECTRO
www.modulelectro.ru



 **MODUL** 
ELECTRO

www.modul-electro.ru

SLITE alu



MODUL
ELECTRO

www.modulelectro.ru

SLITE

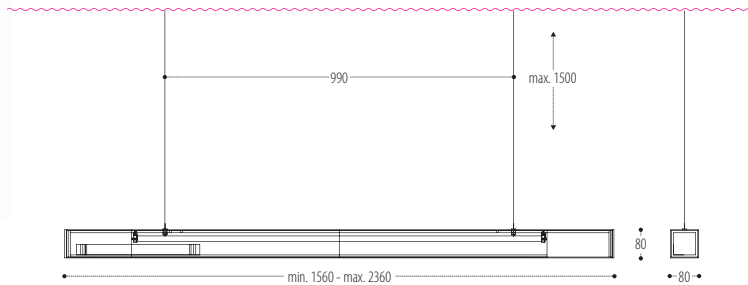

SLITE WALL

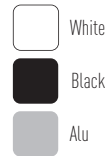
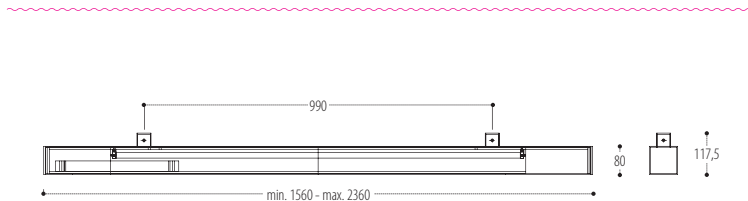

SLITE 1x54W

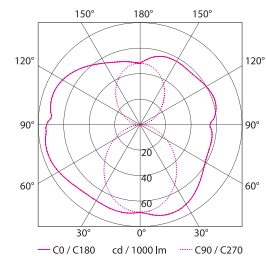

Efficiency factor: 57,1%

SNOWDOME



design Maximal Design for Dark



SNOWDOME glass white/blue



SNOWDOME
glass white

 **MODULO** 
ELECTRO
www.modulelectro.ru



SNOWDOME
glass white/blue

SNOWDOME
glass white/red



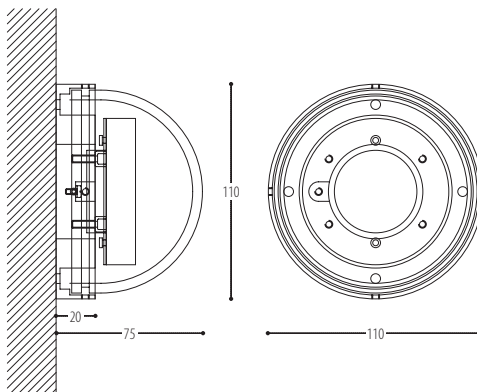

SNOWDOME
glass white/green

MODUL
ELECTRO

www.modulelectro.ro



GLASSES

-  White
-  White / Red
-  White / Blue
-  White / Green



1x MICRO-LYNX F (6 W) / GX53

1x MICRO-LYNX LED (1,5 W) / GX53

Colours : Cool white / Red / Green / Blue / Yellow

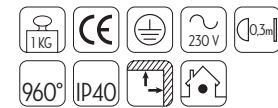

SNOWDOME WHITE

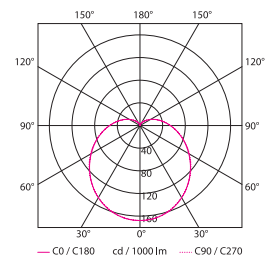

Efficiency factor: 79,8%

PROJECT PAGES:

184 - 185

SON OF EDDY

design Davy Grosemans for Dark

MODUL
ELECTRO

www.modulelectro.ru

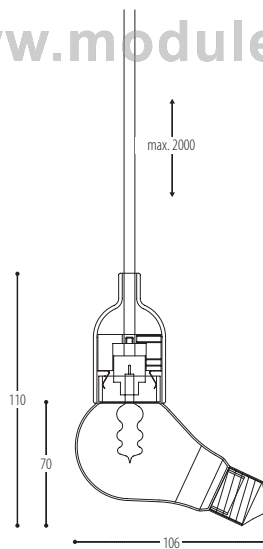



MODUL
ELECTRO
www.modulelectro.ru



Glass | Silicone

1x QT14 (MAX 40 W) / G9



SON OF EDDY

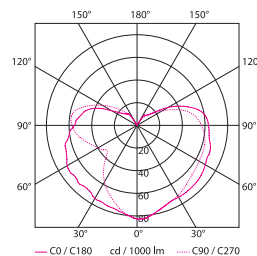

Efficiency factor: 57,8%

PROJECT PAGES:
108 - 149

160

SPACEWALKER

design Constantin Wortmann for Dark

 **MODULO**
ELECTRO
www.modulelectro.ru



SPACEWALKER S 3 x 39W



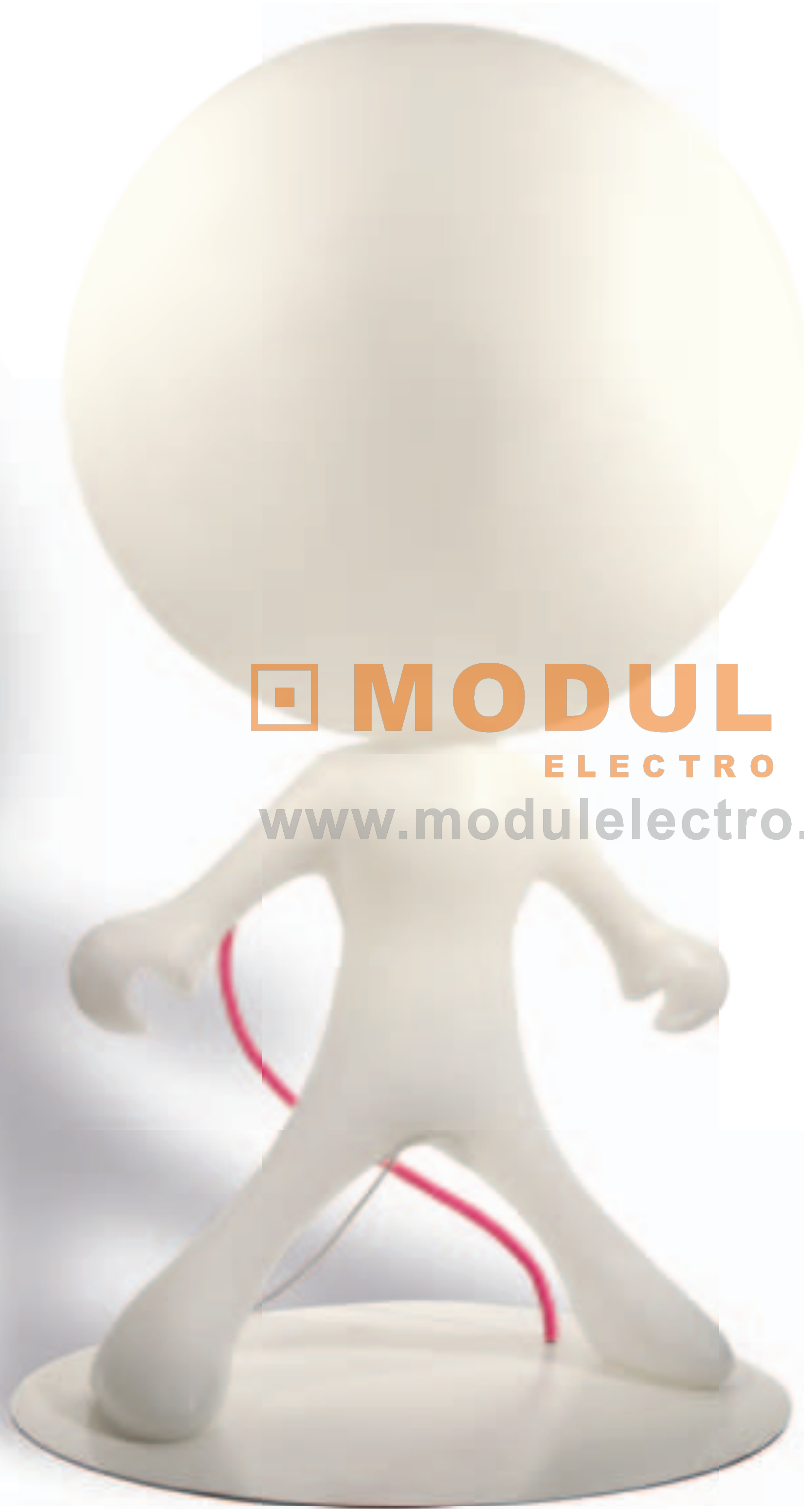

MODUL
ELECTRO
www.modulelectro.ru

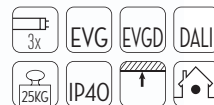
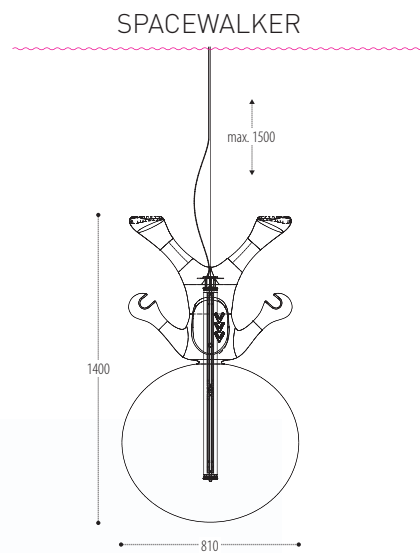

SPACEWALKER FLOOR

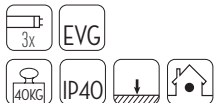
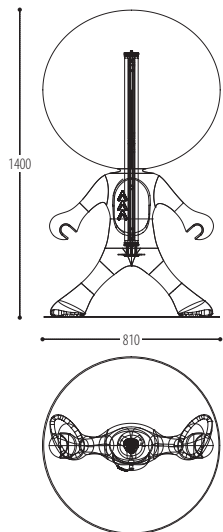

SPACEWALKER FLOOR EXTERIOR

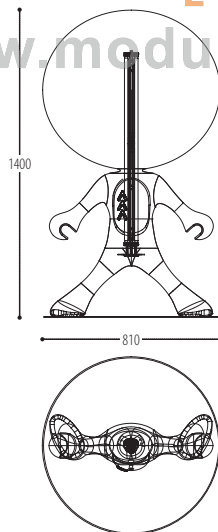

MODULO
ELECTRO
www.modulelectro.ru

BODY



WITH COLOURED BULBS



On request other colours possible with colourfilters



PROJECT PAGES:

039 - 117 - 174 - 175 - 181



SPACEWALKER JR. / S



SPACEWALKER JR.

MODUL
ELECTRO
www.modulelectro.ru

MODUL ELECTRO

www.modulelectro.ru

SPACEWALKER JR.

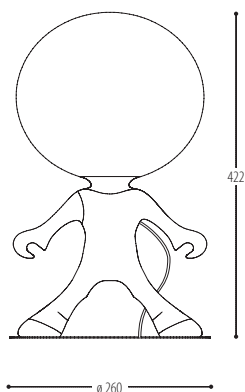

SPACEWALKER JR. / S

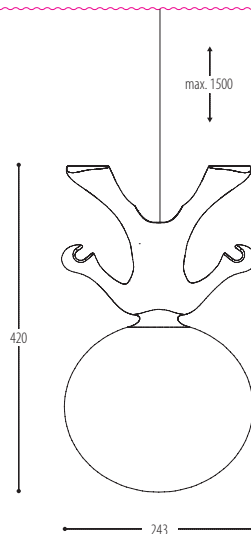

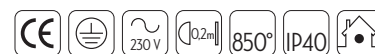

BODY



166



SPINE

design Pieterjan for Dark

 **MODUL** 
ELECTRO
www.modulelectro.ru





 **MODUL** 
ELECTRO
www.modulelectro.ru

SPINE white - up black



MODUL
ELECTRO
www.modulelectro.ru

SPINE white - up red

MODUL
ELECTRO

www.modulelectro.ru

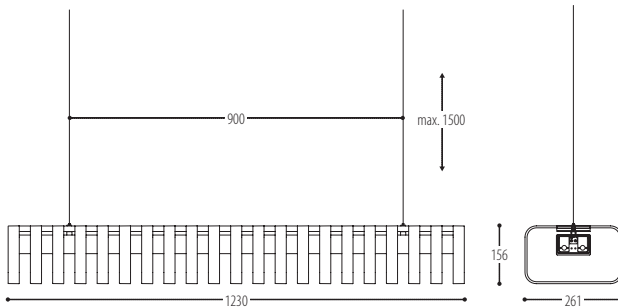

BODY



UP DETAIL

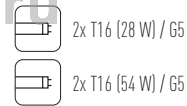

SPINE WHITE 2x28W

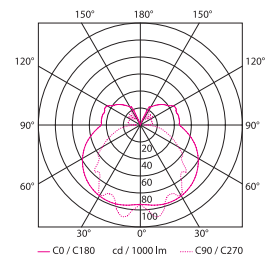

Efficiency factor: 66,1%

170

STAR '58

creatie Lucien de Roeck
design Luc Vincent for Dark

 **MODUL** 
ELECTRO
www.modulelectro.ru

Star '58

MODULO
ELECTRO
www.modulelectro.ru

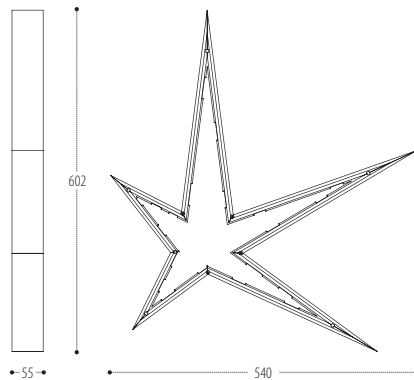

SQUARE ANGEL

design Luc Vincent for Dark

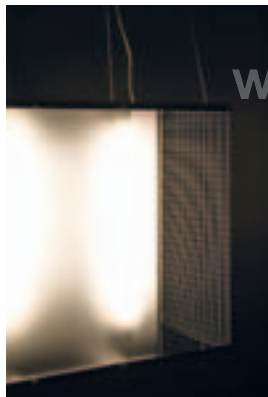
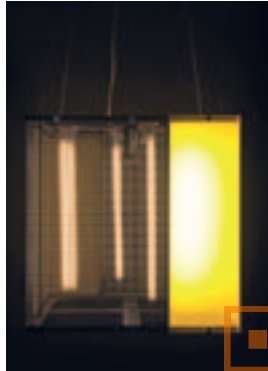

MODULO ELECTRO

www.modulelectro.ru

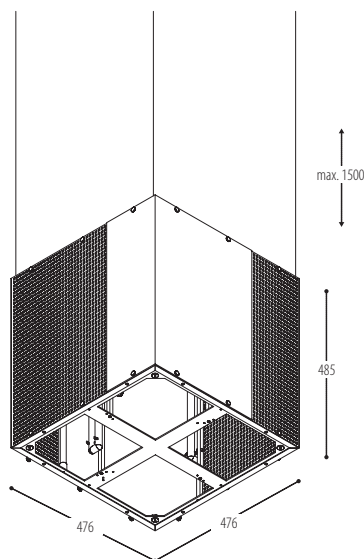

BODY



FROSTED PLEXI

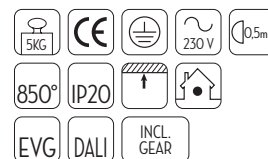
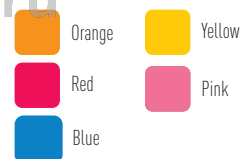

PROJECT PAGES:
161 - 162

TRAPPED



design Sem de l'Anverre & Kris Henkens for Dark



DESIGNPREIS
2009
NOMINIERT



USA 2007

 **MODUL** 
ELECTRO
www.modulelectro.ru

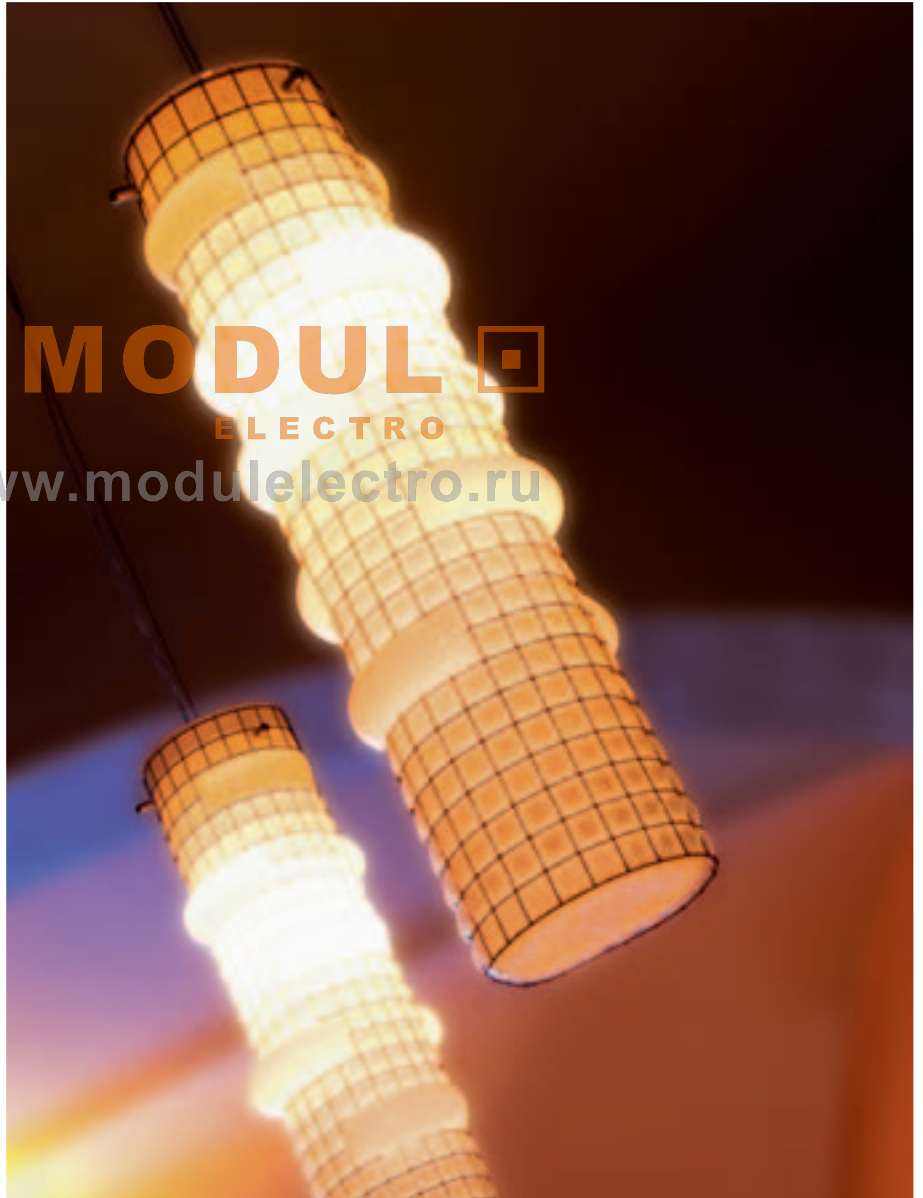

TRAPPED milky



TRAPPED
milky



TRAPPED
red



TRAPPED
clear



MODUL

ELECTRO

www.modulelectro.ru

- Milky
- Red
- Clear

Alu | PMMA

-  1x A60 (MAX 100 W) / E27
-  1x TCA-SE (MAX 15 W) / E27
-  1x LED (MAX 7 W) / E27

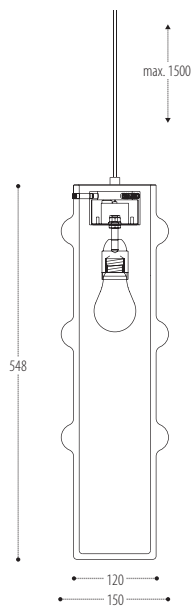

PROJECT PAGES:
058 - 172 - 173 - 187



176

T&T

design Christophe De Ryck for Dark



reddot design award
winner 2009

 **MODUL** 
ELECTRO
www.modulelectro.ru

T&T white

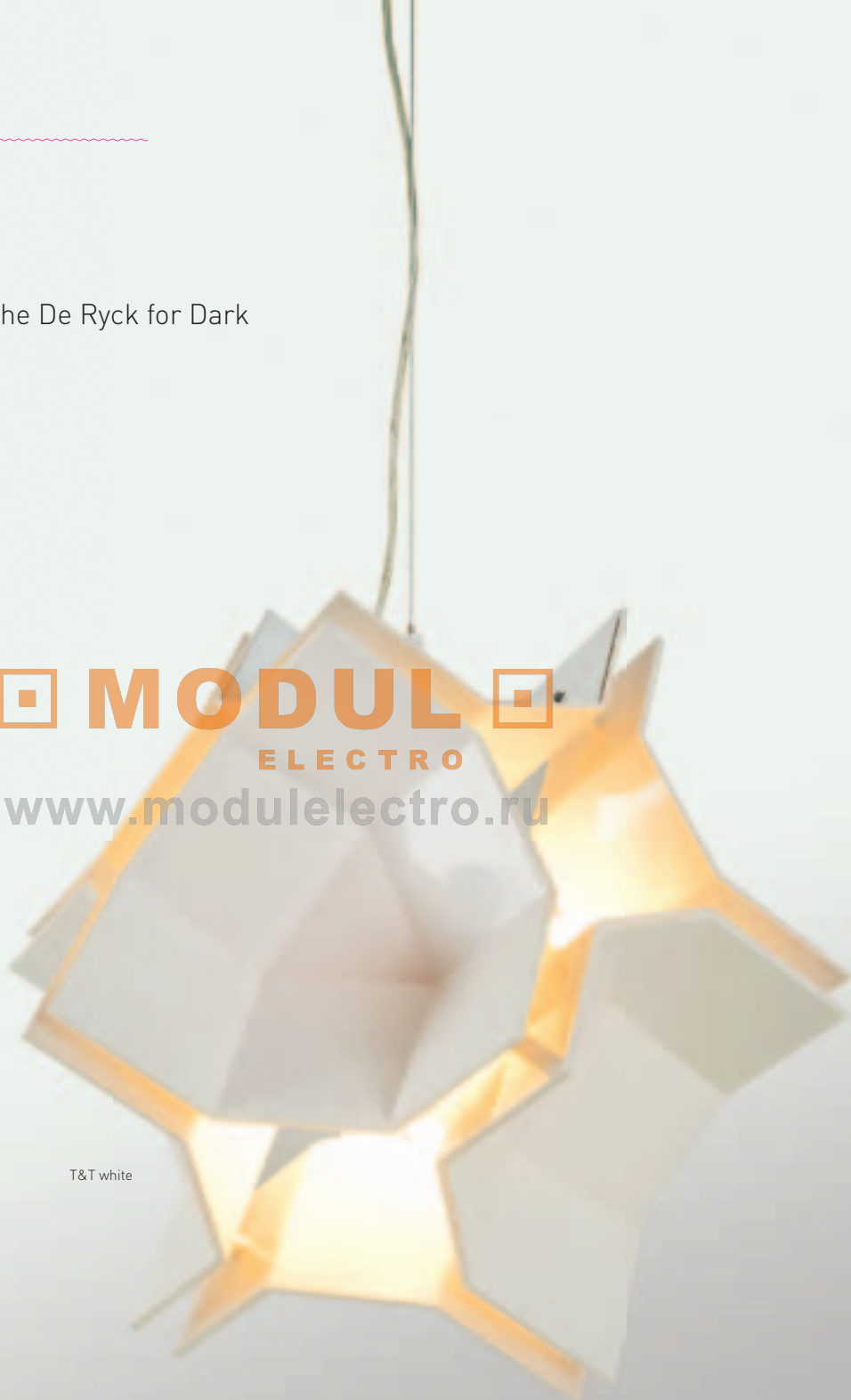

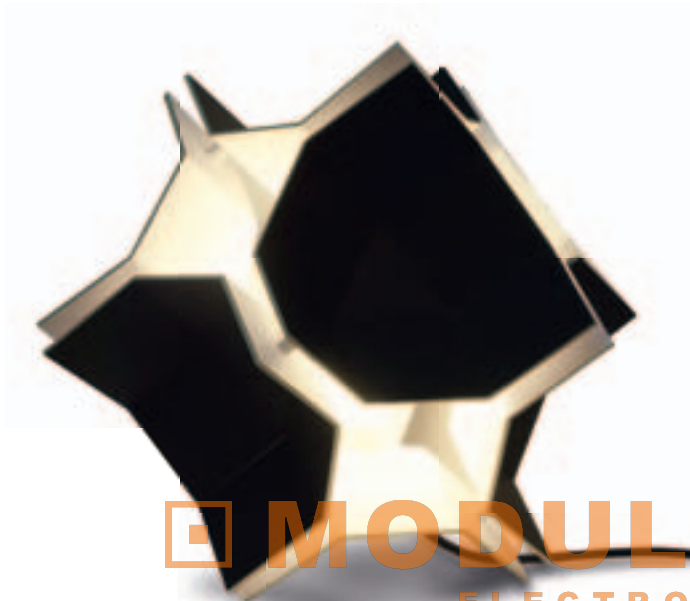

MODULO
ELECTRO
 T&T TABLE black
www.modulelectro.ru

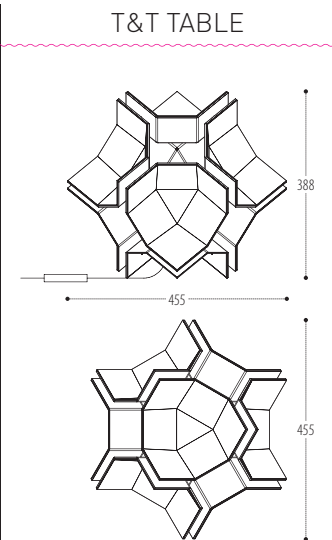
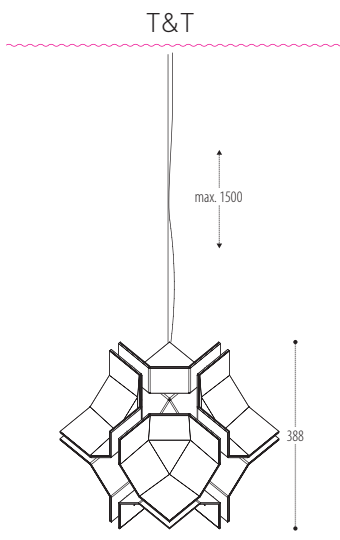
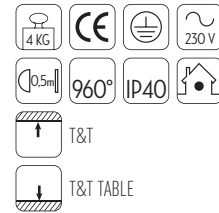

T&T 1xTCG-SE 15W

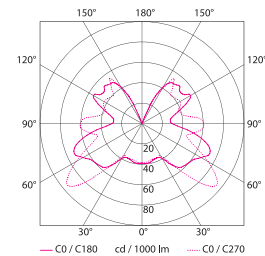



Efficiency factor: 61,1%

TSJOEPY

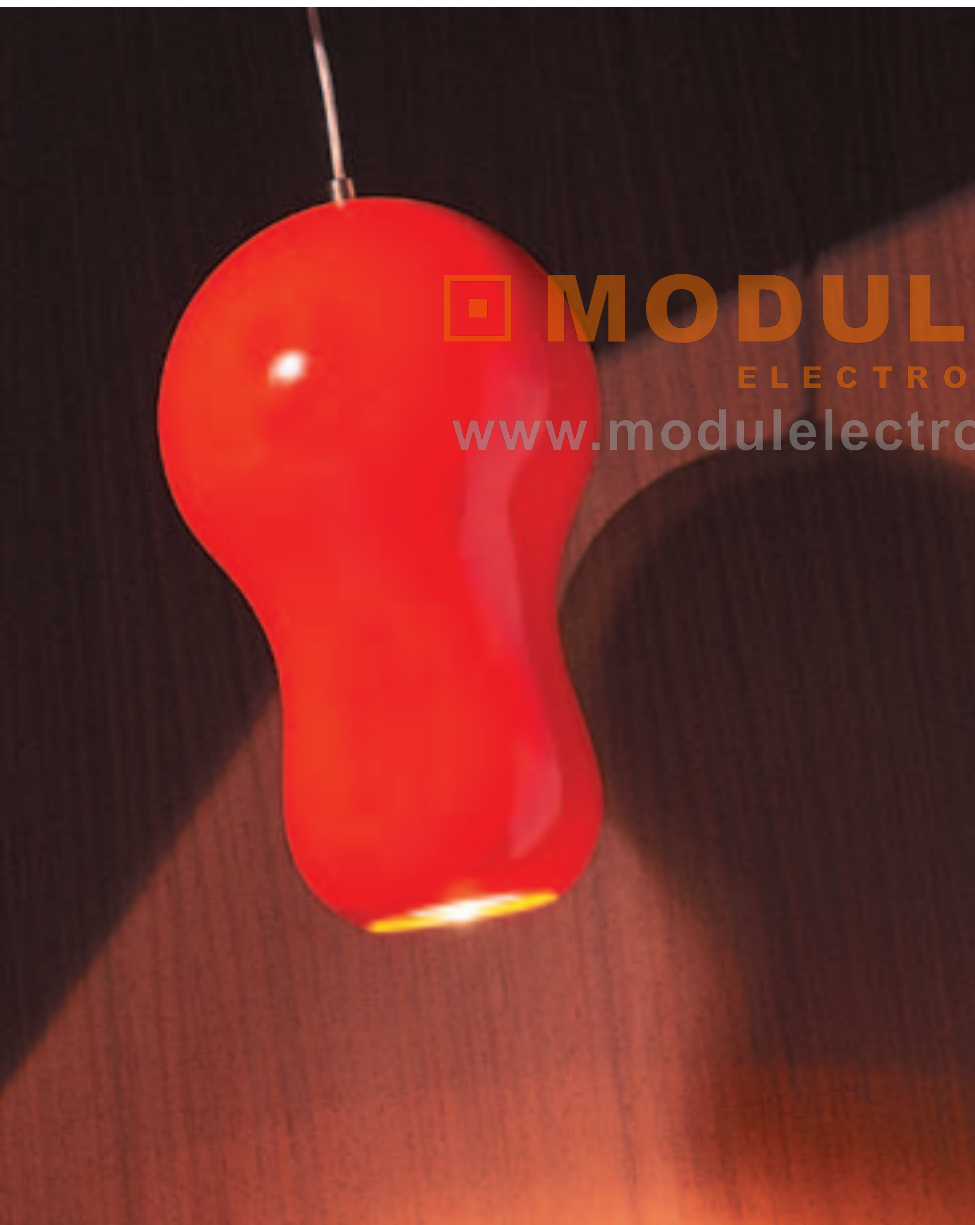
design Anthony Duffeleer for Dark



 **MODULO** 
ELECTRO
www.modulelectro.ru



TSJOEPY
white glossy



TSJOEPY
red glossy



TSJOEPY
black glossy

MODUL ELECTRO

www.modulelectro.ro

- White glossy
- Black glossy
- Red glossy



Polyester | Metal

- 1x QPAR20 (MAX 50 W) / E27
- 1x HIPAR20 (35 W) / E27
- 0.5m
- 0.9m
-
-

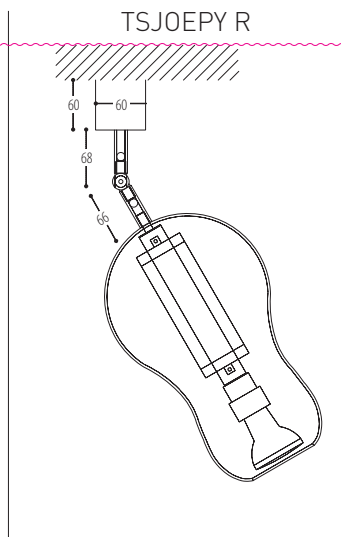
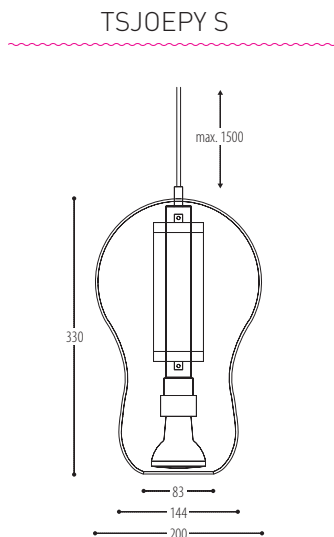

-
-
-
-
-
-
-
-
- TSJOEPY S
- TSJOEPY R

QPAR20 45W-22°

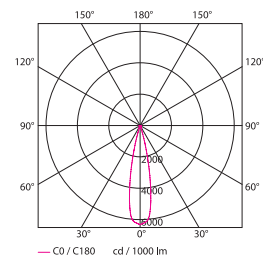

Efficiency factor: 100%

PROJECT PAGES:

024 - 042 - 051 - 087 - 106 - 124 - 185 - 186



180

TWOLVE

design Christophe De Ryck for Dark



reddot design award
winner 2009

 **MODUL** 
ELECTRO
www.modulelectro.ru



MODUL
ELECTRO
www.modulelectro.ru

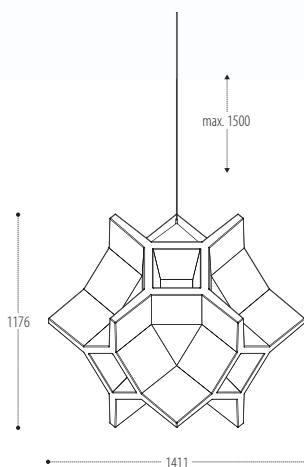

BODY

Transparant white

WITH COLOURED BULBS

Red Blue Green

On request other colours possible with colourfilters

PE | Metal



- 3x T16 (24 W) / G5
- EVG
- EVGD
- DALI
- INCL GEAR
- 6x T16 (24 W) / G5
- EVG
- EVGD
- DALI
- INCL GEAR
- LED

- 25 KG
- CE
- 230 V
- 0.2m
- 850°
- IP20
- PV
- TWOLVE
- TWOLVE FLOOR

182

YOKOZUNA

design Fabien Dumas for Dark

 **MODUL** 
ELECTRO
www.modulelectro.ru



MODUL
ELECTRO

www.modulelectro.ru

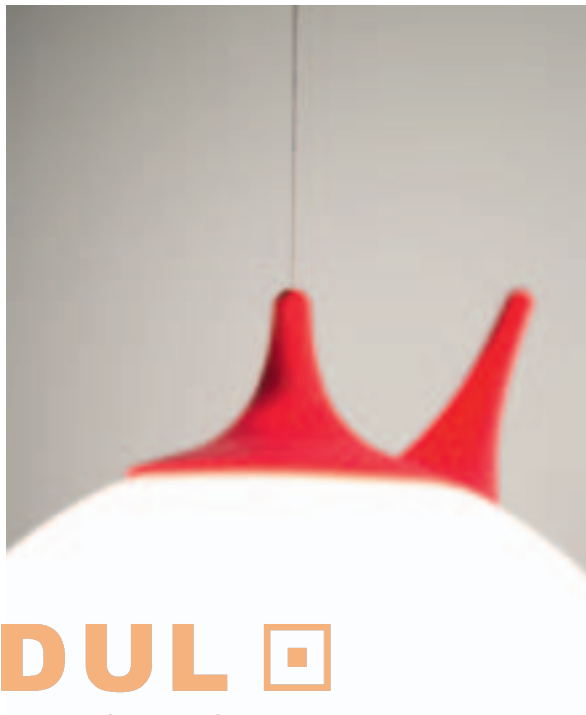
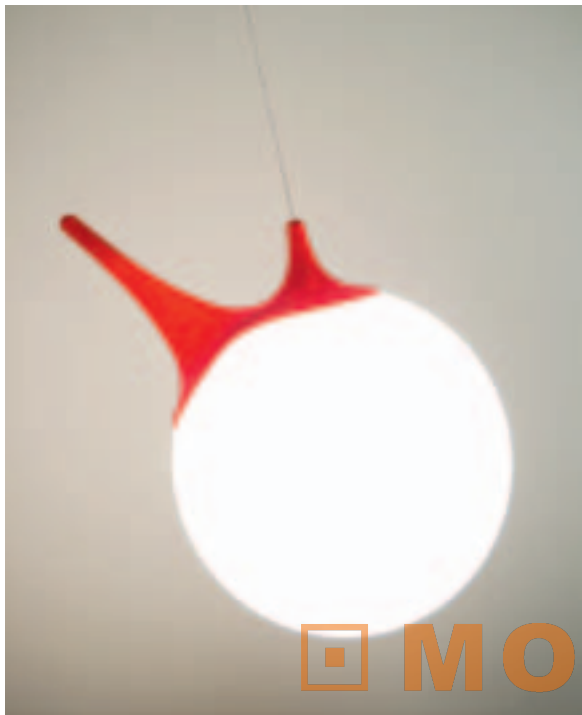

MODUL
ELECTRO

www.modulelectro.ru

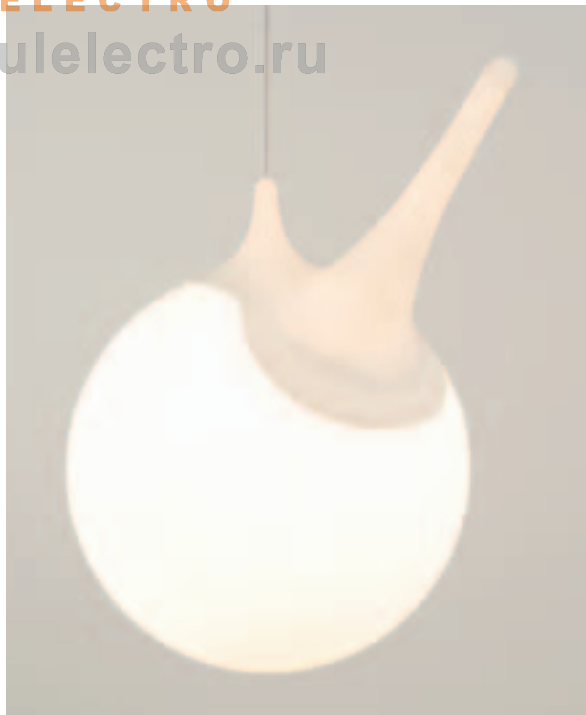
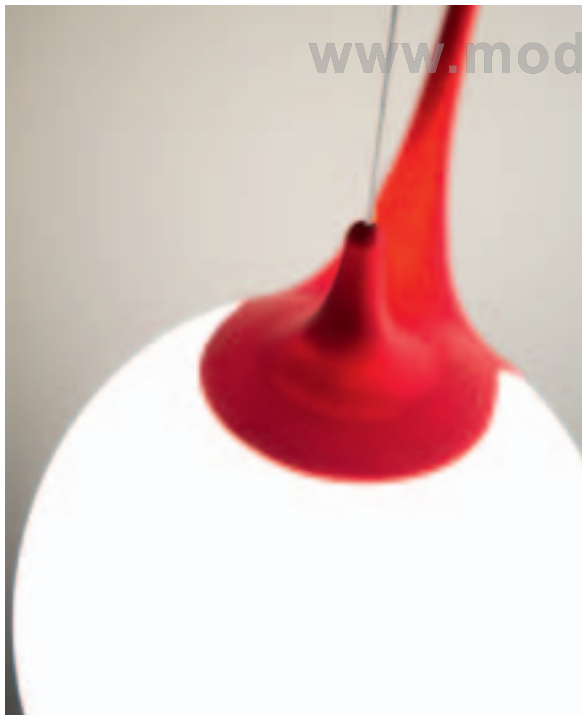

YOKOZUNA JR. white / red

YOKOZUNA JR. white / white

YOKOZUNA

MODUL
ELECTRO

YOKOZUNA JR.

www.modulelectro.ru

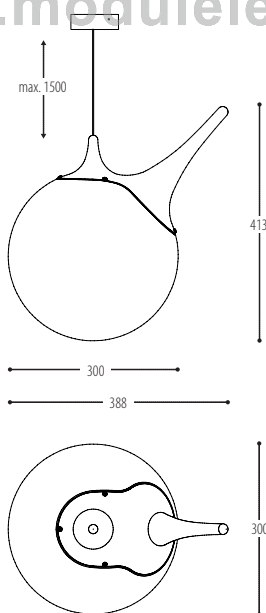
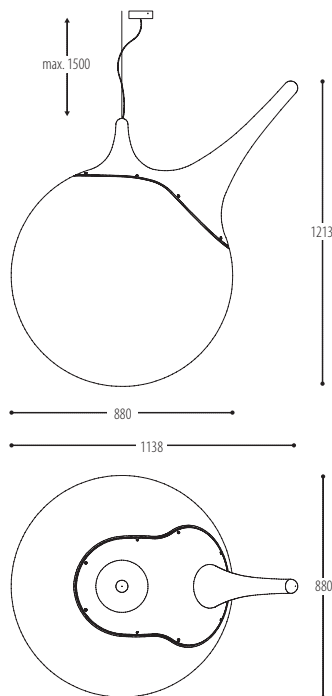

BODY

-  Transparent white / white
-  Transparent white / red

WITH COLOURED BULBS

-  Red
-  Blue
-  Green

On request other colours possible with colourfilters



YOKOZUNA

 3x T16 (24 W) / G5

 LED



YOKOZUNA JR.

 1x A60 (MAX 60 W) / E27

 1x QA60 (MAX 42 W) / E27

 1x TC-TSE (MAX 11 W) / E27

 1x LED (MAX 7 W) / E27

 5 KG  0,5m



PROJECT PAGES:

182

ZUPER

design Frank Janssens for Dark



ZUPER SQUARE black

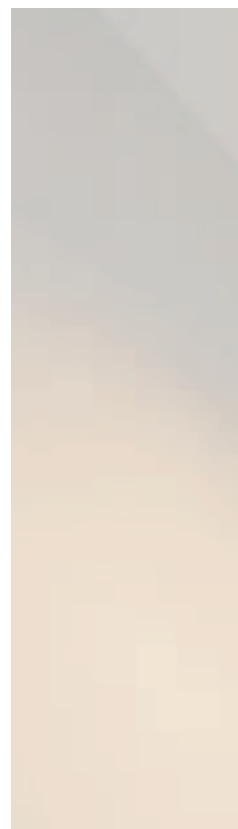

ZUPER ROUND white



MODUL
ELECTRO
www.modulelectro.ru



ZUPER ROUND black



ZUPER ROUND Ø190 white with opale glass



ZUPER ROUND Ø190 white

MODUL
ELECTRO
www.modulelectro.ru

ZUPER ROUND Ø170

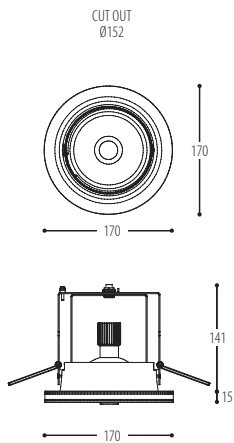

ZUPER ROUND Ø190

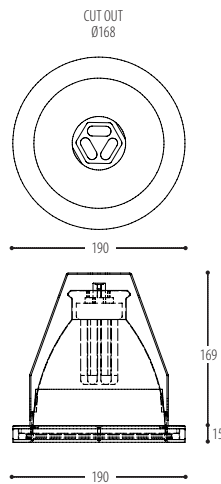

ZUPER ROUND Ø190

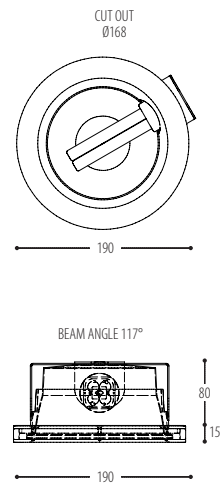

ZUPER ROUND

TECHNICAL SHEET

189



ZUPER ROUND Ø190 black

MODUL
ELECTRO

www.modulelectro.ru

ZUPER ROUND Ø170

IP20	12V	EXCL TRANSFO	1x QR-LP111 (MAX 45 W) / G53
	230V	EXCL GEAR	1x HIR-CE111 (35 W) / GX8.5 1x HIR-CE111 (70 W) / GX8.5
IP66	0.7m	EXCL GEAR	1x HIT-TC-CE (35 W) / G8.5 1x HIT-TC-CE (70 W) / G8.5
	LED	led reflector	must be used with 14° 24° 36° 54° 20° 40° 60°
Colour temp 2700K / 3000K / 4000K -->			700 Lm >80 CRI 700 mA --> 16W
Colour temp 2700K / 3000K / 4000K -->			1000 Lm >80 CRI 700 mA --> 23W
Colour temp 2700K / 3000K / 4000K -->			700 Lm >95 CRI 700 mA --> 23W

ZUPER ROUND Ø190

IP20	230V	INCL/EXCL GEAR	1x TC-DEL (13 W) / G24q-1	IP44 OPTION + glass CLEAR OPALE
			1x TC-TEL (18 W) / GX24q-2	

White

Black

Alu



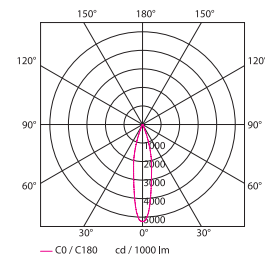

HIR-CE111 35W - 21°

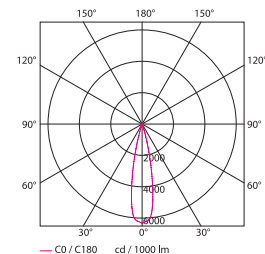

QR-LP111 45W-22°





 **MODUL** 
ELECTRO
www.modulelectro.ru

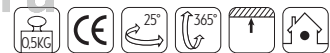
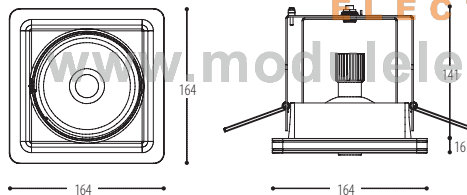

ZUPER SQUARE

IP20 	1x QR-LP111 (MAX 45 W) / G53
	1x HIR-CE111 (35 W) / GX8,5 1x HIR-CE111 (70 W) / GX8,5 1x HIT-TC-CE (35 W) / G8,5 1x HIT-TC-CE (70 W) / G8,5
IP66 	must be used with
	led reflector
LED	
Colour temp 2700K / 3000K / 4000K --> 700 Lm >80 CRI 700 mA --> 16W	
Colour temp 2700K / 3000K / 4000K --> 1000 Lm >80 CRI 700 mA --> 23W	
Colour temp 2700K / 3000K / 4000K --> 700 Lm >95 CRI 700 mA --> 23W	

HIR-CE111 35W - 21°

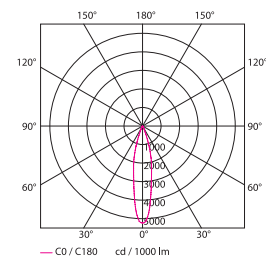

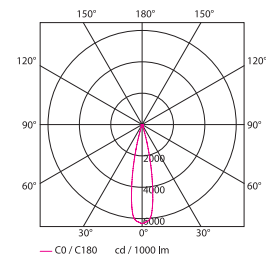

Efficiency factor: 100%

QR-LP111 45W-22°



Efficiency factor: 100%

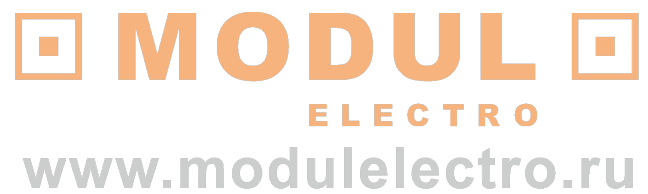

 **MODUL** 
ELECTRO
www.modulelectro.ru

PROJECTS



NO FRUIT _ METROPOLIS

Project: Gran Hotel Sol y Mar, Calpe - Spain
Interiorarchitect: Xavier Pastor

 **MODUL** 
ELECTRO
www.modulelectro.ru





MODUL
ELECTRO
www.modulelectro.ru



MODUL
ELECTRO
www.modulelectro.ru





MODUL
ELECTRO
www.modulelectro.ru

12-25

Project: Corbie Hotel, Geel
Concept: Nelva

12-25

Project: Corbie Hotel, Geel
Concept: Nelva

 **MODUL** 
ELECTRO
www.modulelectro.ru





 **MODUL** 
ELECTRO
www.modulelectro.ru







12-25

Project: Acta - Bommel

Architect: IngeClaudia

d-CONCRETE

Project: Kant, Brugge

Architect: Ivan Missinne for E&L projects

OBLIVION

Project: Novotel, Amsterdam, The Netherlands

Concept: Proof Consultancy

TWOLVE

Project: Habbekrats, Kortrijk



MODUL
ELECTRO
www.modulelectro.ru

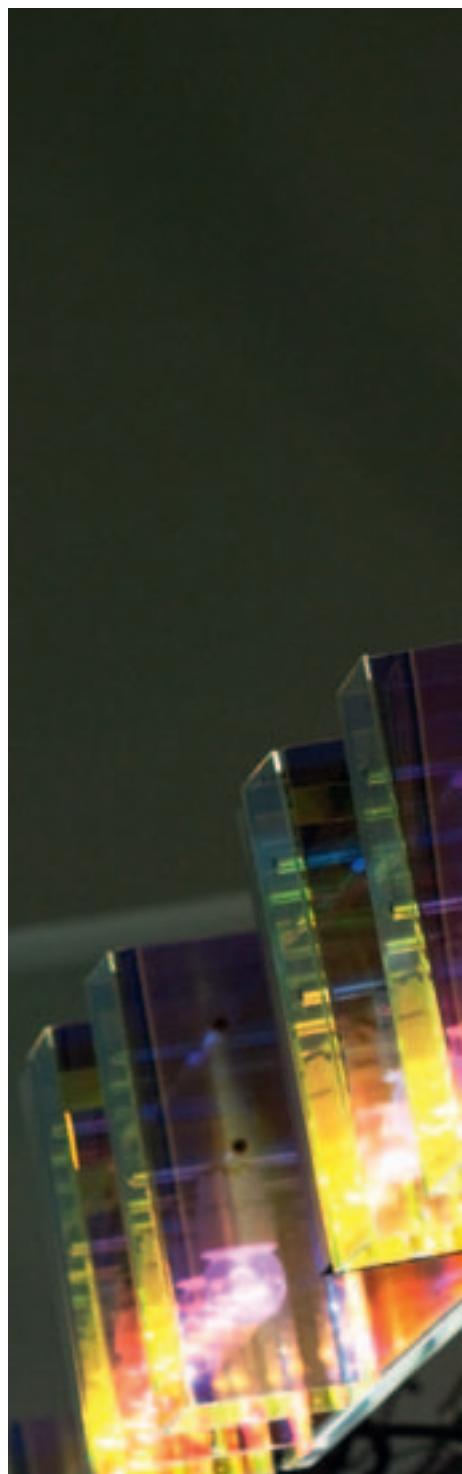

BRIDGE

Project: Restaurant Il Mercato, Lens
Concept: Michel Pirritano, Nuances, Lens
Assistance: Prolum, Reims



MODUL
ELECTRO
www.modulelectro.ru

NO FRUIT

Project: Exki, Brussel

D2V2 FLOOR

Project: Duravit Event

ICE

Project: Stadshaven, Rotterdam

Architect: Fabrique







MODULE
ELECTRO
www.modulelectro.ru

NO FRUIT _ NO COPY

Project: C/C Cité Europe - Coquelles
Concept: Bruno Gerome, Carré Noir, Paris
Realisation: AU4G Architecture, Paris pour Unibail



MODUL
ELECTRO
www.modulelectro.ru

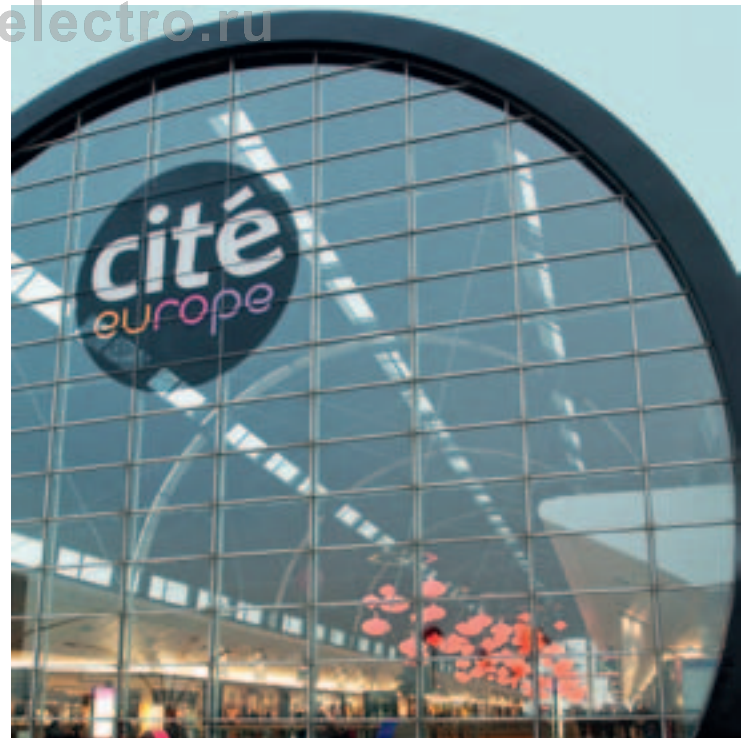



NO FRUIT _ NO COPY

Project: C/C Cité Europe - Coquelles
Concept: Bruno Gerome, Carré Noir, Paris
Realisation: AU4G Architecture, Paris pour Unibail



MODUL
ELECTRO
www.modulelectro.ru

APOLLO

Jazz festival, Montreux

LGTM-X01

Light and Building, Frankfurt

CHUBBY BOX

Interieur 2008

SPINE

Interieur 2008



MODUL
ELECTRO
www.modulelectro.ru



MODUL
ELECTRO
www.modulelectro.ru

BRIDGE TWO

Project: Restaurant Griotte, Paris

 **MODUL**
ELECTRO
www.modulelectro.ru





MODULO
ELECTRO
www.modulelectro.ru





HOPPY _ TSJOEPY

Project: Levro, Breskens
Architect: Lieven Musschoot





MODULO
ELECTRO
www.modulelectro.ru

D2V2

Project: l'Escale, Le Touquet

Concept et realisation: Dogsign Architecture, Lille

 **MODUL** 
ELECTRO
www.modulelectro.ru

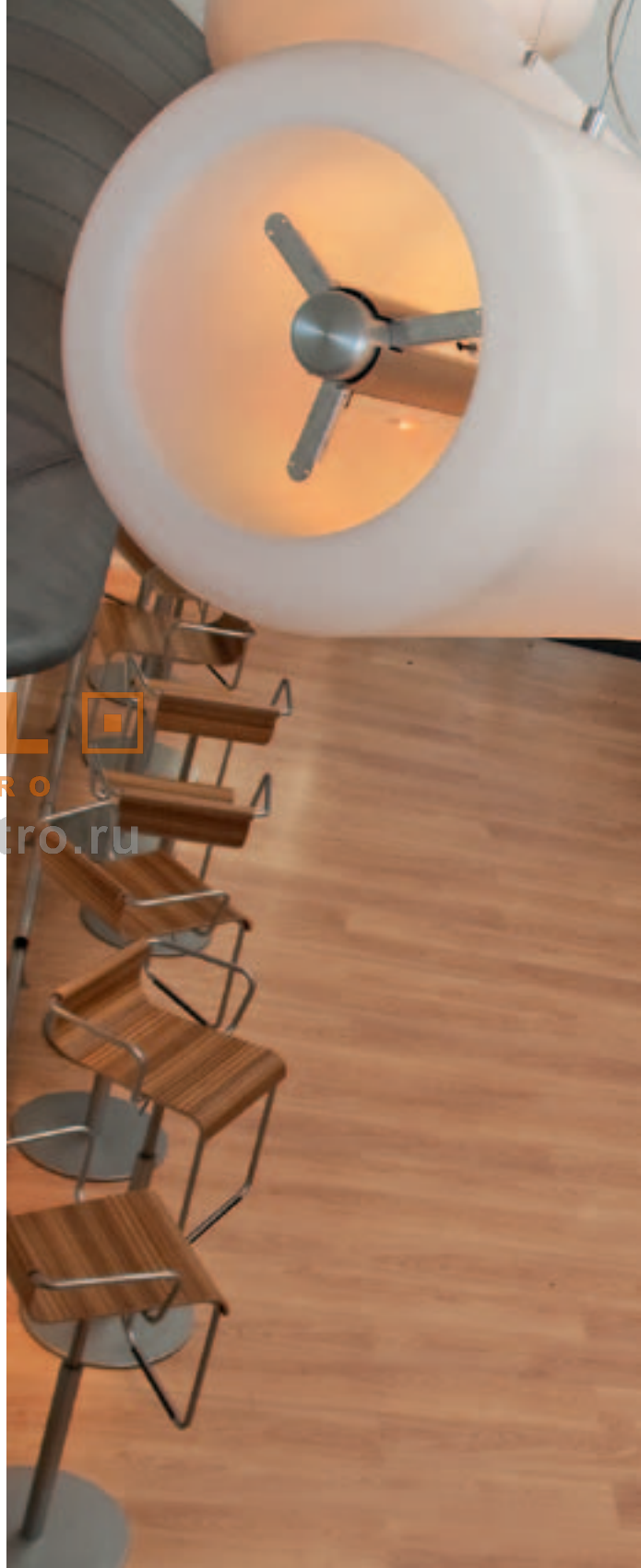



MODUL
ELECTRO
www.modul-electro.ru

D2V2 _ 12-25 _ PAWWW

Project: l'Escale, Le Touquet

Concept et realisation: Dogsign Architecture, Lille



MODUL
ELECTRO
www.modulelectro.ru



MODUL
ELECTRO
www.modulelectro.ru



12-25 SET 3 _ 12-25 SET 2 _ CROSSLIGHT WALL

Project: l'Escale, Le Touquet

Concept et réalisation: Dogsign Architecture, Lille



MODULO
ELECTRO
www.moduloelectro.ru



MODUL
ELECTRO
www.modulelectro.ru

12-25 set 2

Project: Private Home, Brugge
Architect: Lieven Musschoot



MODUL
ELECTRO
www.modulelectro.ru

BRIDGE _ BRIDGE WALL

Project: Sint Jan, Marke
Architect: Redline Projects





MODUL
ELECTRO
www.modulelectro.ru





MODULO
ELECTRO
www.modulelectro.ru



MODUL 
ELECTRO
www.modulelectro.ru

BRIDGE

Project: Restaurant l'Ostréade, Paris
Concept: Neyvoz Architecture, Montreuil
Réalisation: IPSO, La Garenne Colombes

CROSSLIGHT

Project: Tio
Concept: Workshopofwonders



MODUL
ELECTRO
www.modulelectro.ru

SPACEWALKER

Project: Digiking, Hasselt
Concept: Deusjevo





MODUL
ELECTRO
www.modulelectro.ru

12-25 SET 2 _ ICE

Project: Agence de Voyage Leclerc, Arras
Architect: Daniel Copin Design, Arras

OBLIVION

Project: Restaurant Oh Poivrier, Paris
Concept: Jérémie Moller Architecture, Paris
Assistance: Conran contracts, Paris



TSJOEPY

Project: Le paradis du fruit, Paris
Architect: Opus Certum Architecture, Paris
Assistance: DEC, Paris



MODUL
ELECTRO
www.modulelectro.ru



 **MODUL** 
ELECTRO
www.modulelectro.ru

CANNA-2 _ 12-25 SET 3

Project: Optiek Henckaerts, Kapellen
Architect: Lieven Musschoot



 **MODULO**
ELECTRO
www.modulelectro.ru





MODUL
ELECTRO
www.modulelectro.ru



 **MODUL** 
ELECTRO
www.modul-electro.ru

ICE BM



Project: Lion Nathan, Australia
Architect: Project Control Group



MODUL
ELECTRO
www.modulelectro.ru

d-COW

Project: Lion Nathan, Australia
Architect: Project Control Group

 **MODUL** 
ELECTRO
www.modulelectro.ru





MODULO
ELECTRO
www.modulelectro.ru

www.modulelectro.ru

12-12
Project: The Foodmaker, Gent
Concept: Puresang

TSJOEPY
Project: Mr. Grill, Brugge
Architect: Expanion Team





MODUL
ELECTRO
www.modulelectro.ru

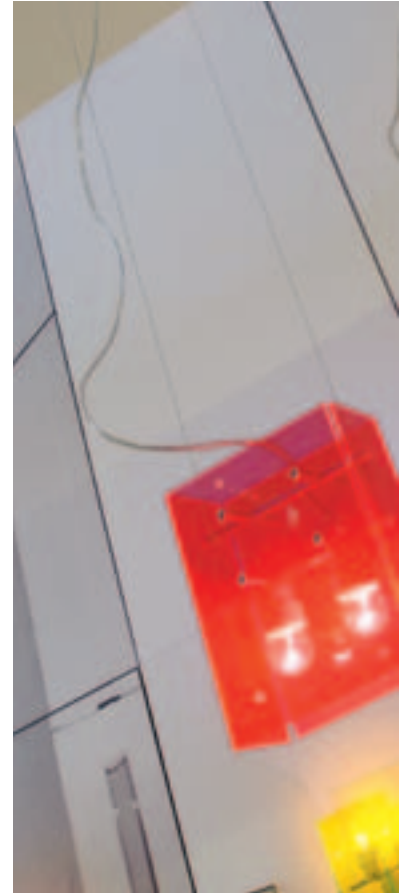

MODUL
ELECTRO
www.modulelectro.ru



OBLIVION _ NO COPY

Project: Duravit Event, Antwerpen
Concept: Dark studio

BRIDGE

Project: Mr. Grill, Brugge
Architect: Expanion Team

BRIDGE _ BRIDGE WALL



Project: VW Shop European Motor Show, Brussel
Arch. Expanion Team

BRIDGE

Project: VW Shop European Motor Show, Brussel
Arch. Expanion Team



d-COW

Project: Adrem keukens, Eeklo

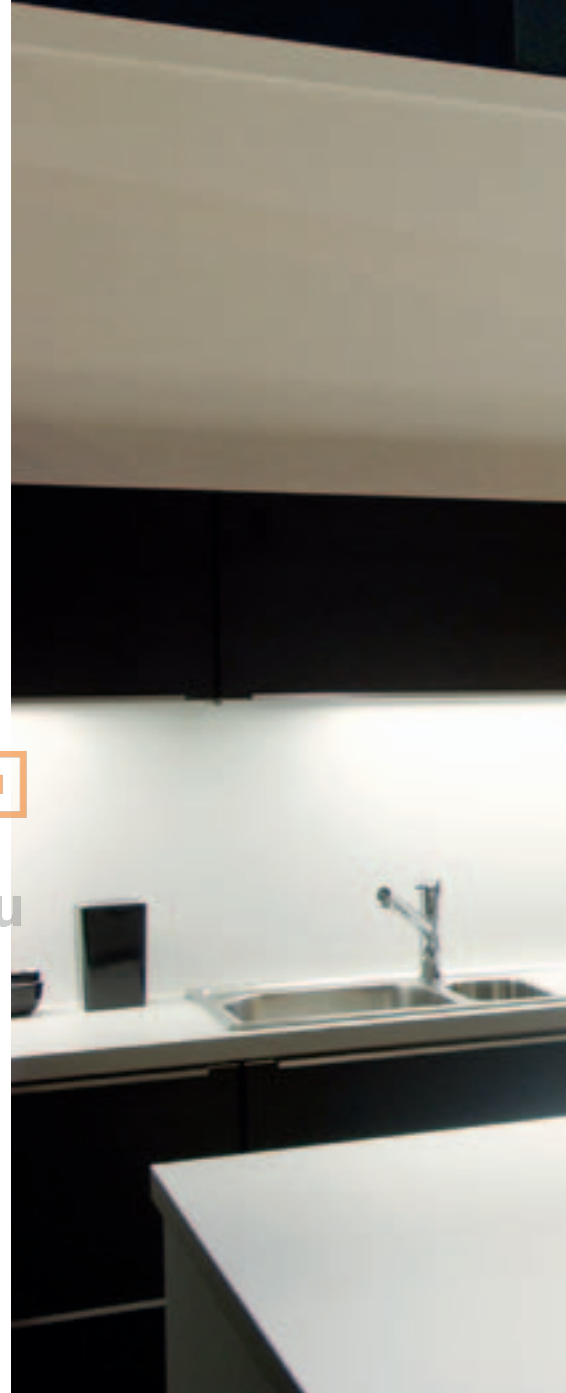
 **MODUL** 
ELECTRO
www.modulelectro.ru





 **MODUL** 
ELECTRO
www.modulelectro.ru



MODUL
ELECTRO
www.modulelectro.ru

12-25 _ BRIDGE

Project: Euphony Lounge
Concept: Deusjevo



MODUL
ELECTRO
www.modulelectro.ru

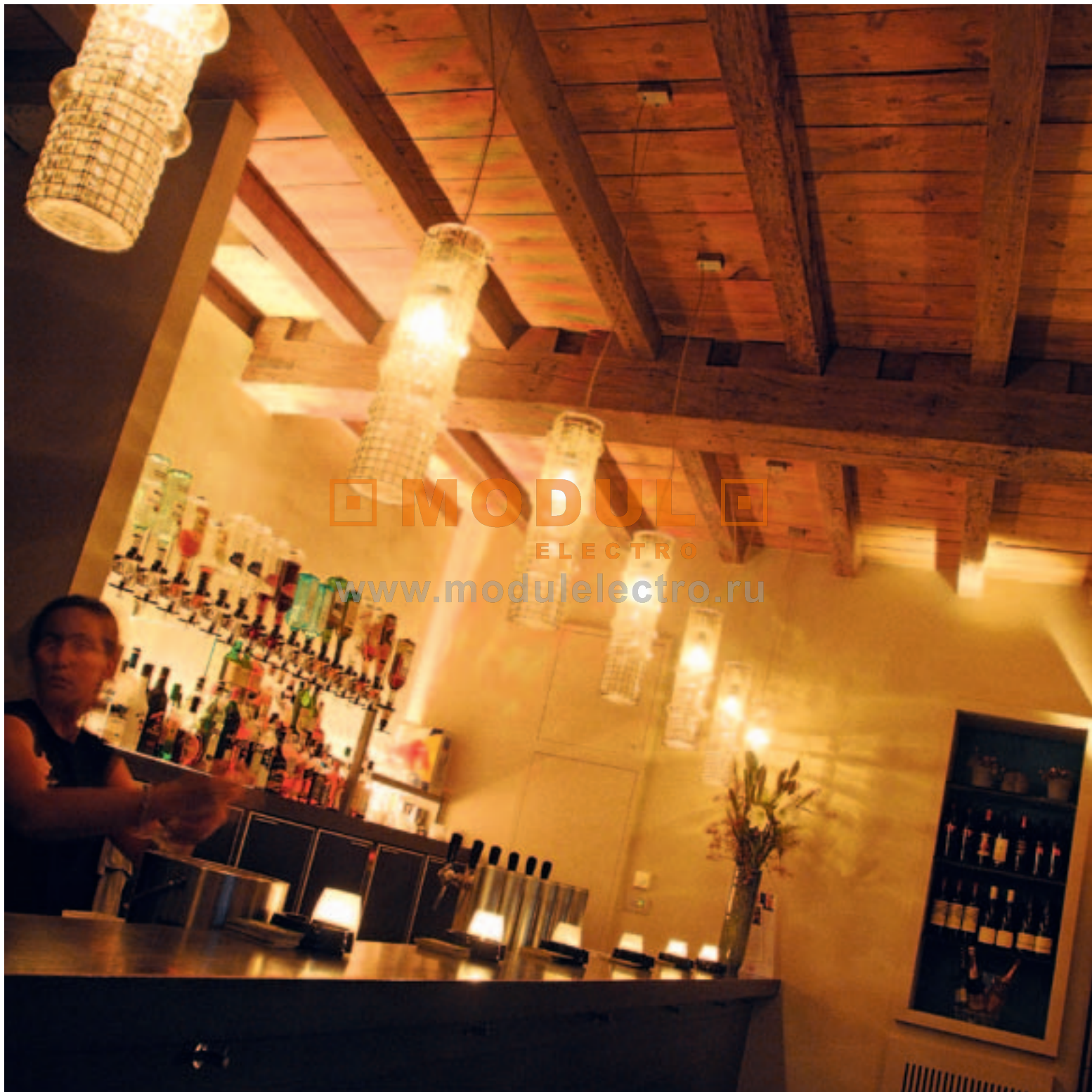

MODULO
ELECTRO
www.modulelectro.ru



MODUL 
ELECTRO
www.modulelectro.ru

TRAPPED

Project: Punta Est, Brugge
Concept: Dark studio

HOPPY

Exterieur 2008



FRANJE TABLE

HOPPY

Sfeer 2006, Gent

ROSET

Exterieur 2008







MODUL

ELECTRO

www.modulelectro.ru





D2V2

Project: Magasin RG-512, Ivry sur Seine
Architect: ARC & TYP Architecture, Paris
Concept: Gaël Drignon

FRANJE

Project: Showroom Oving Projectinrichting
Architect: Sanne Willemsen

MODULO
ELECTRO
www.modulelectro.ru





MODUL
ELECTRO
www.modulelectro.ru

HEAD & RELAX

WINE & D



MODULO
ELECTRO
www.modulelectro.ru

T&T

Project: Bamboeddha, Kortrijk
Concept: Frederic's





MODUL
ELECTRO
www.modulelectro.ru

HOPPY _ ICE _ POC

Project: BENT, Beveren-Lochristi-Oostende

Concept: Dark studio



MODULO
ELECTRO
www.modulelectro.ru

SPINE

Project: Finesse, Maldegem
Concept: Dark Studio





MODUL
ELECTRO
www.modulelectro.ru



MODUL
ELECTRO
www.modulelectro.ru

FRANJE

Project: Square, Brussel
Concept: A&B Project



MODUL
ELECTRO
www.modulelectro.ru

METROPOLIS

Project: Demonstrate Office spaces
Concept: Kate Stockman for Demonstrate

MODUL
ELECTRO
www.modulelectro.ru





THE BEST ACTIVITIES
FOR YOUR HEALTH ARE
**PUMPING AND
HUMPING.**

MODUL

ELECTRO

www.modulelectro.ru



d-RABBIT

Project: Demonstrate Office spaces
Concept: Kate Stockman for Demonstrate



12-25

Project: Willemen, Mechelen
Lighting design: Ivan Missinne

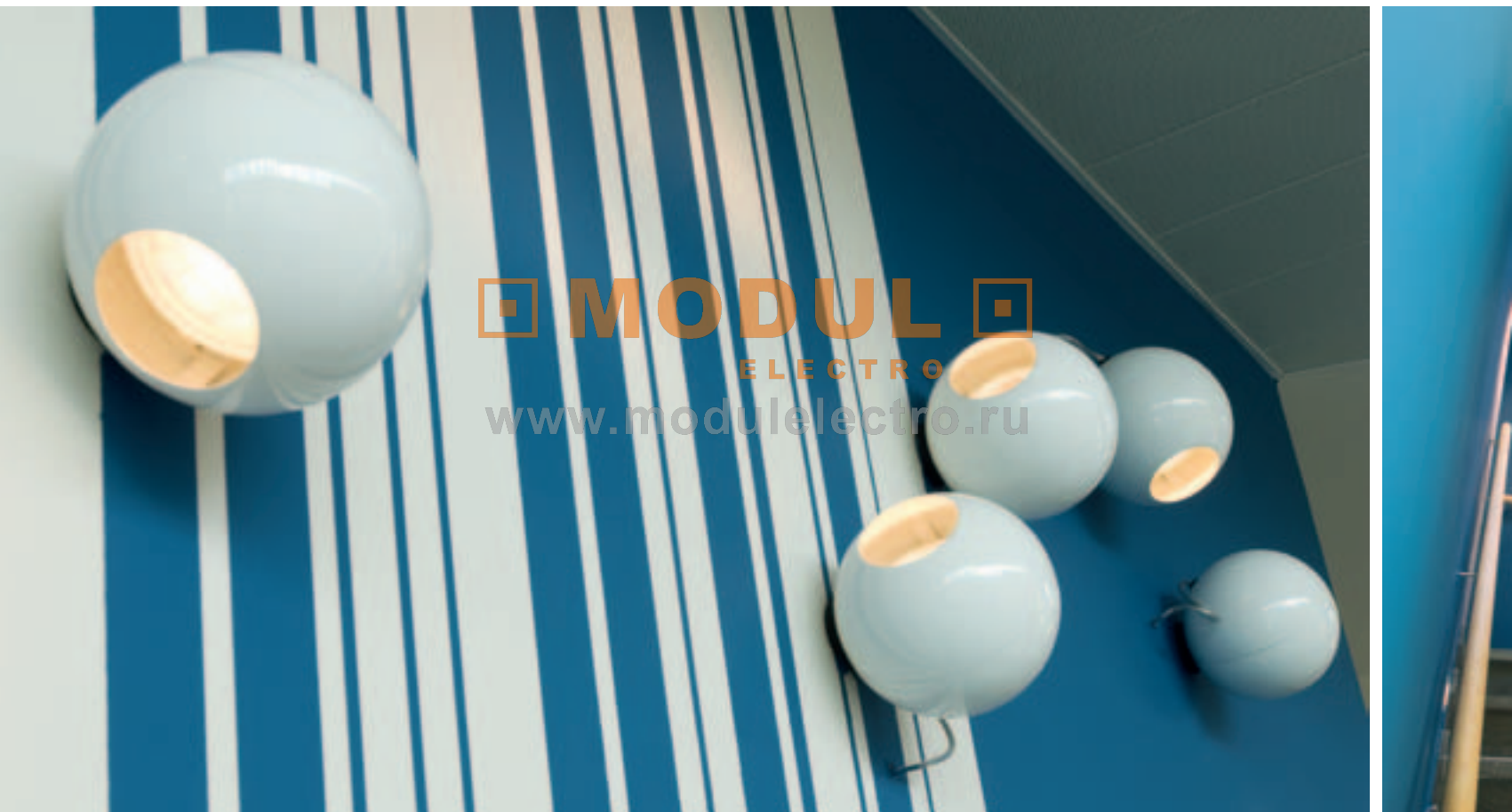

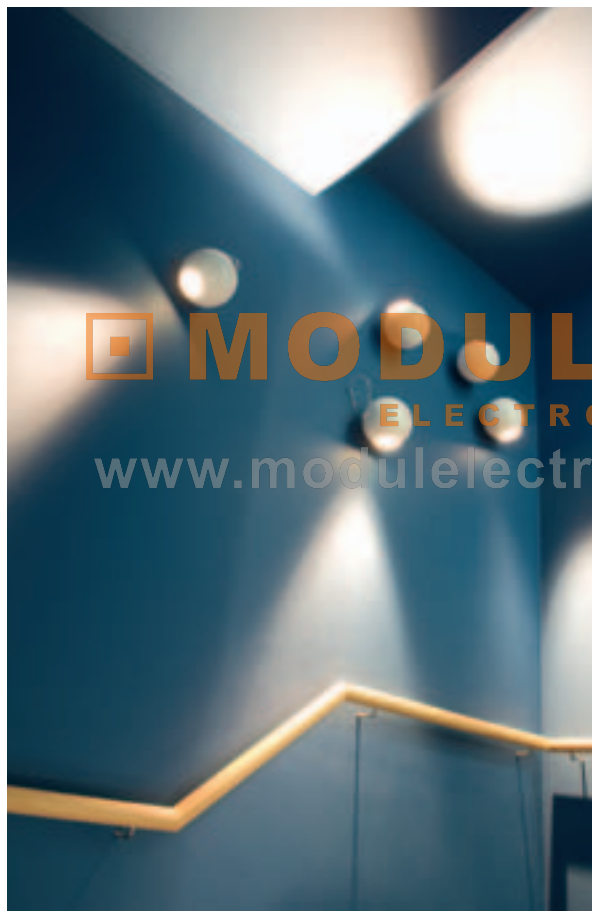



MODUL
ELECTRO

www.modulelectro.ru

d-LEATHER

Project: Headquarters Redline Projects, Roeselare
Architect: Natasia Fanariotis for Redline Projects



MODUL
ELECTRO
www.modulselectro.ru



MODUL
ELECTRO
www.modulelectro.ru







12-25 SET2 _ BRIDGE 3P
Project: Privat Home, Brugge

CYBE plug-in

HYPE
Project: Unic Design, Meulebeke
Architect: Beek Design

NO FRUIT

Project: Hotel Eden Roc, Cap d'Antibes, France
Lighting design: Didier Courbe

 **MODUL** 
ELECTRO
www.modulelectro.ru





MODUL
ELECTRO
www.modulelectro.ru



MODUL
ELECTRO
www.modulelectro.ru

TSJOEPY

Project: Grill-Restaurant Elckerlijc, Maldegem
Concept: Dark Studio



MODUL
ELECTRO
www.modulelectro.ru



MODULE
ELECTRO
www.modulelectro.ru

ICE

Project: Office of architects, Norway
Interior Architect: Anne Ma Torp



MODUL 
ELECTRO
www.modulelectro.ru

CROSSLIGHT

Project: Bottarga, Oostende

Architect: Crayon projects

CYBE

Project: Orango

CROSSLIGHT

Project: Arte, Kortrijk

Architect: Steve Dumortier

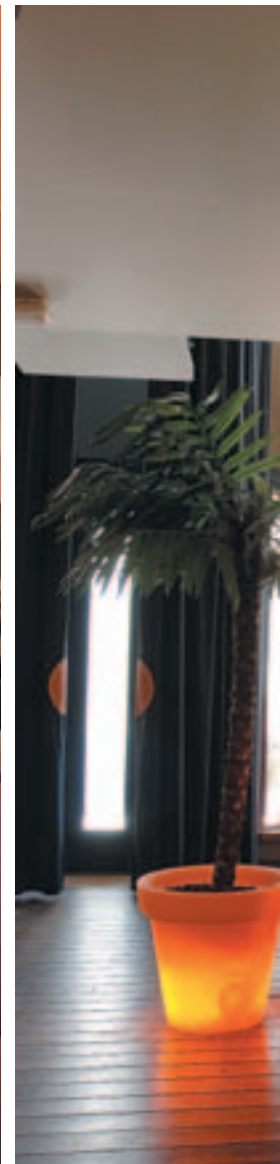



12-25

Project: Filou & co

POC_ 12-25

Project: Cassari, Mechelen

Architect: Studio Satrima

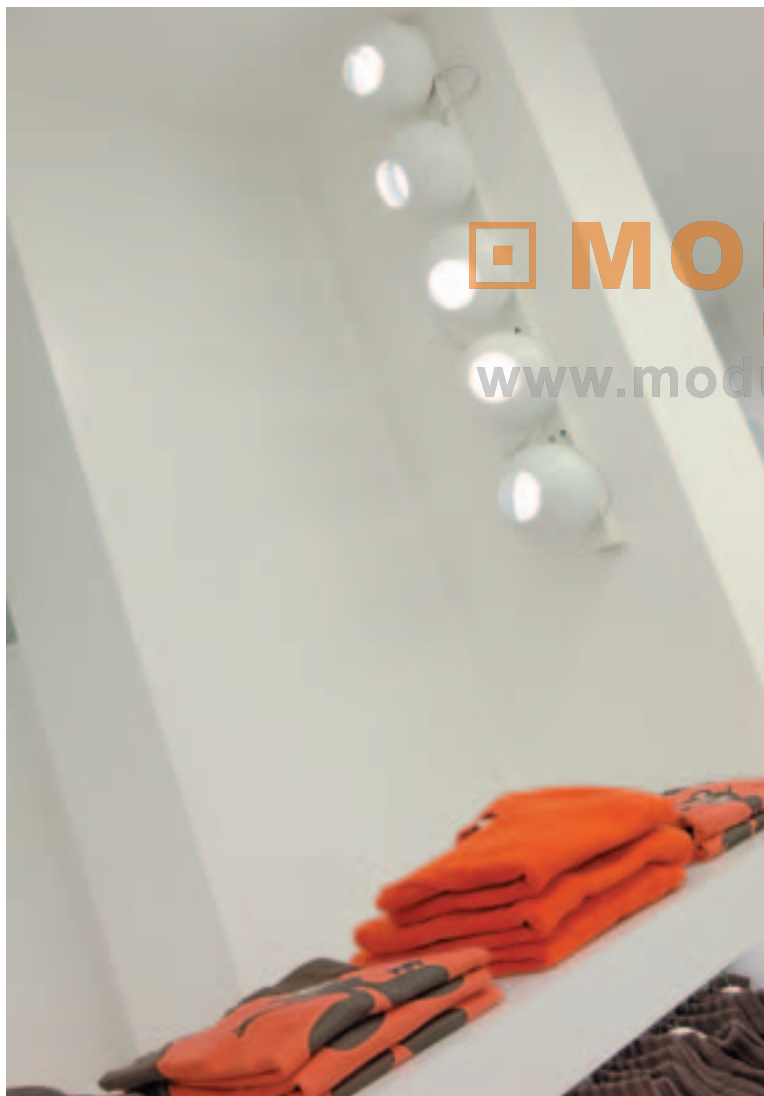

MODUL
ELECTRO
www.modulelectro.ru



MODULO
ELECTRO
www.modulelectro.ru

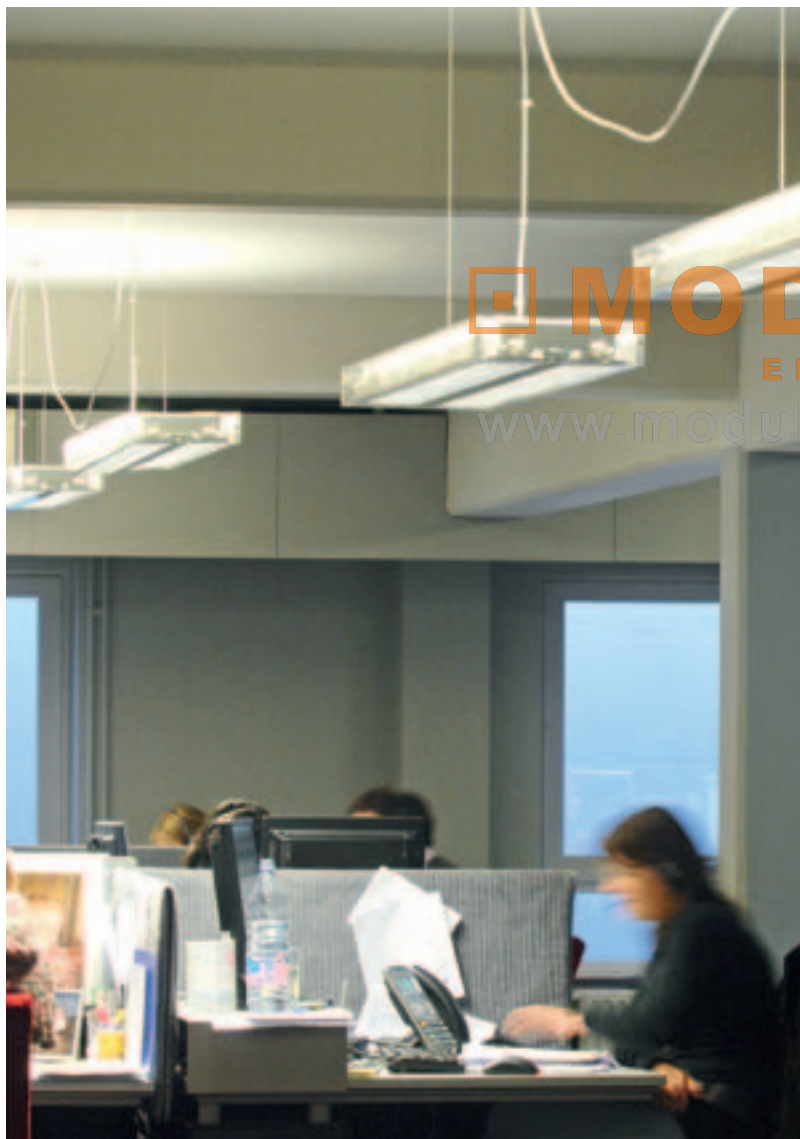

MODUL
ELECTRO
www.modulelectro.ru



POC _ ICE _ BRIDGE

Project: BFO, Gent

Architect: Natasia Fanariotis for Redline Projects

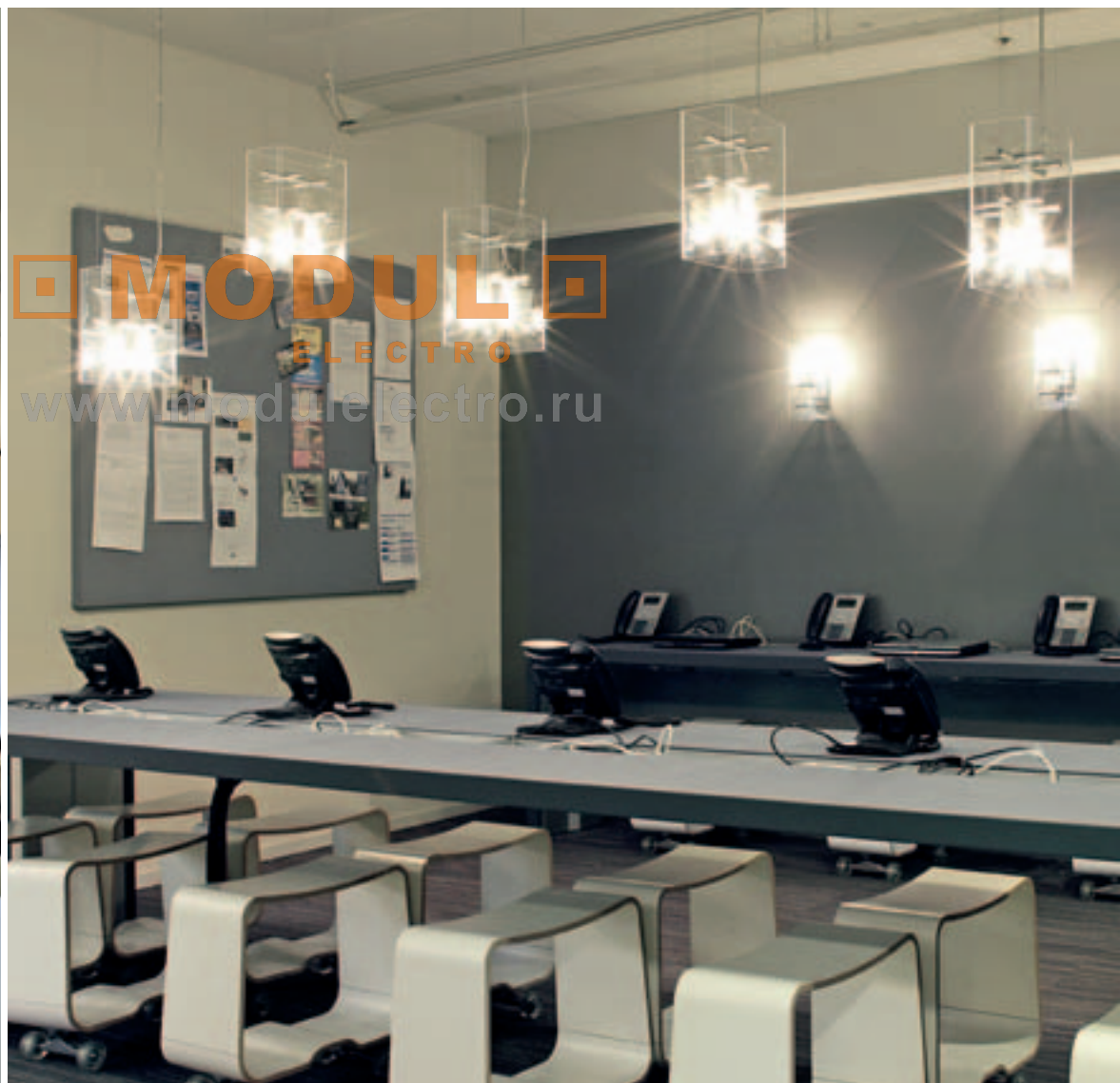





MODUL
ELECTRO
www.modulelectro.ru

NO FRUIT _ 12-25 _ FRANJE _ CROSSLIGHT

Project: Showroom Ahrend, Groningen
Architects: Joke Bult & Jeltje De Jong



**GUM**

Project: Private Home

NO FRUIT

Project: Jongform

ICE

Project: Bulthaup



HOPPY

Project: Le Soir, Brussel
Architect: Planisphère



CROSSLIGHT

Project: Unic Design, Meulebeke
Architect: Beek Design

HOPPY 3P

Project: Scheers



 **MODUL** 
ELECTRO
www.modulelectro.ru



MODUL
ELECTRO
www.modulelectro.ru

OBLIVION _ 12-25

Project: Hope hairdresser, Oslo, Norway
Architect: Element Arkitekter



MODUL
ELECTRO
www.modulelectro.ru



MODUL
ELECTRO
www.modulelectro.ru



MODUL
ELECTRO
www.modulelectro.ru

OBLIVION

Project: Showroom Ahrend, Groningen
Architects: Joke Bult & Jeltje De Jong

PAWWW

Project: Restaurant l'Escale, Le Touquet
Concept et réalisation: Dogsign Architecture, Lille

TSJOEPY S

Project: Hotel Mercure, Nieuwegein

Architect: Etienne Bouten for B+B interieurarchitectuur

TSJOEPY R_ TSJOEPY S

Project: CKS, Knokke

Architect: Co Twee

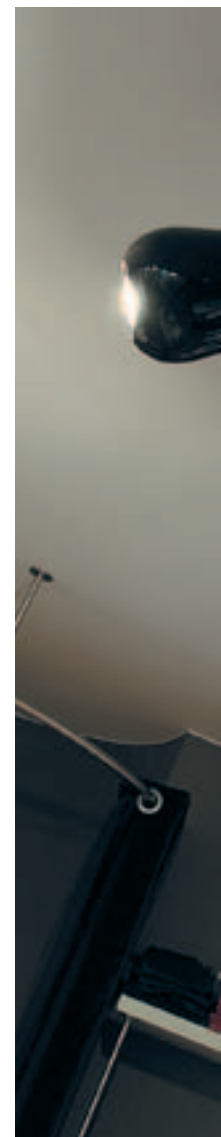



MODUL
ELECTRO
www.modulelectro.ru

MODULO
ELECTRO
www.modulelectro.ru

SON OF EDDY _ 12-25

Project: Horebeekse boekhandel

Architect: Patrick Matthys

CROSSLIGHT

Project en Concept:

Confetti reclamefabriek, Rotterdam





MODUL
ELECTRO
www.modulelectro.ru



MODUL
ELECTRO
www.modulelectro.ru



CHUBBY BOX _ R&S

Project: Q-Music Beach House

Concept: Dark studio



MODUL
ELECTRO
www.modulelectro.ru

d-CONCRETE

Project: Loft, Gent

Architect: Ivan Missinne

JUICE

Project: CKS, Knokke

Architect: Co Twee

POC

Project: Zole Male, Rotterdam

Architect: Caroline Langemeyer





d-SQUEEZE

Project: Habbekrats

NO FRUIT

Project: Townhall, Deerlijk

Architect: Nero



NO FRUIT**NO FRUIT bling bling**

Interieur 2006



MODUL
ELECTRO
www.modulelectro.ru



 **MODUL** 
ELECTRO
www.modulelectro.ru



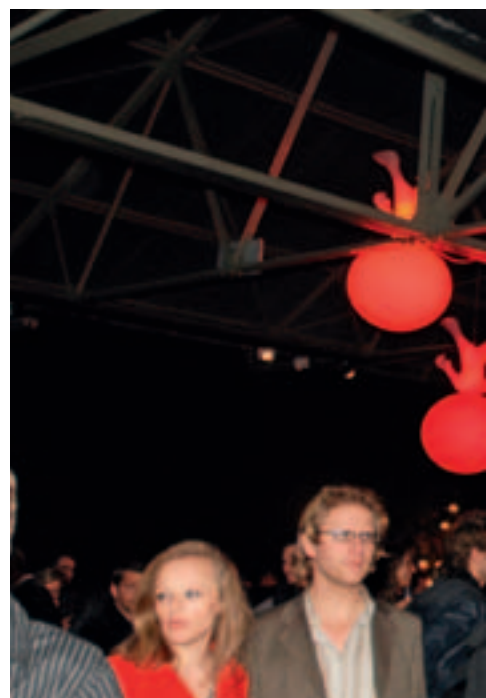



NO FRUIT

Project: Tao, Oostende
Architect: Crayon Projects

CROSSLIGHT WALL

D2V2

International Movie Festival Gent

SPACEWALKER

Exterieur 2008

BRIDGE

Project: Chilli Jam

HYPE

Project: Beauty Nail Center, Sint-Niklaas

Concept: Equipal

LA CAGE

Project: Demonstrate Office spaces

Concept: Kate Stockman for Demonstrate





NO FRUIT bling bling _ 12-25

Project: Loft, Oudenaarde
Architect: Patrick Matthys







MODULO
ELECTRO
www.modulelectro.ru

OBLIVION _ TWOLVE
Exterieur 2008

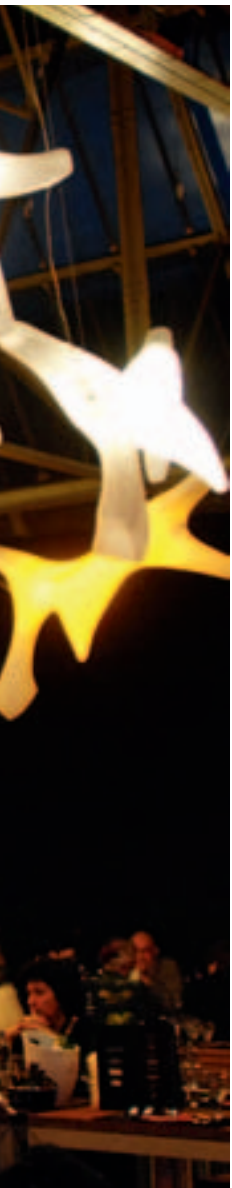

TSJOEPY _ 12-25 _ NO FRUIT

Project: Priva Campus, Rotterdam
Architect: Confetti reclamefabriek

 **MODULO**
ELECTRO
www.moduloelectro.ru







MODUL
ELECTRO
www.modulelectro.ru

TWOLVE

Project: Cnockaert, Oudenaarde
Architect: Patrick Matthys



MODUL
ELECTRO
www.modulelectro.ru



BRIDGE

Project: WTC, Amsterdam
Concept: Illum kunstlicht



BRIDGE
Project: Kitchen, Luik
Architect: Valentini

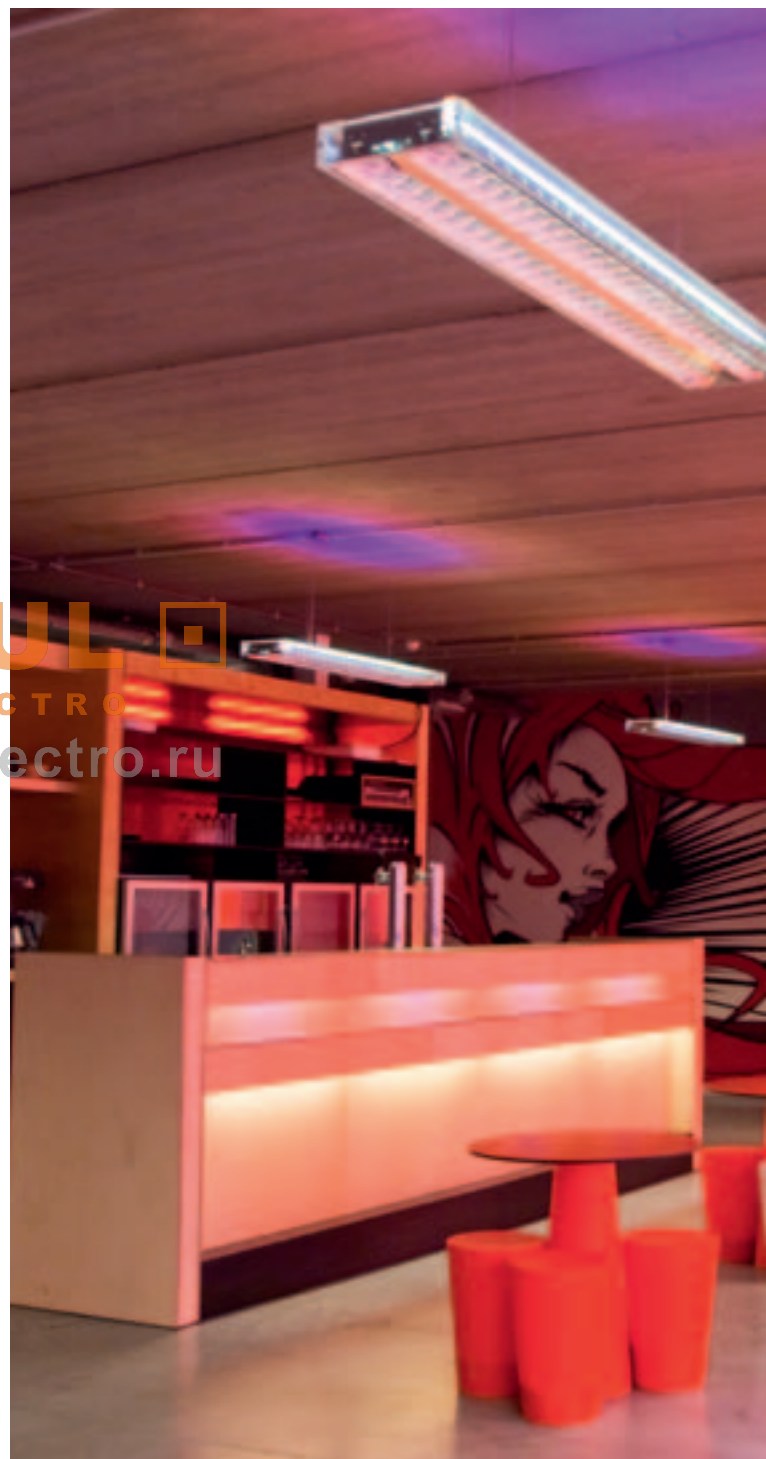

MODUL
ELECTRO
www.modulelectro.ru

ICE

Project: Videohouse, Vilvoorde
Concept: Dark studio





d-RABBIT _ FRANJE

Project: Showroom Torino

PAROQ 3 _ GUM 01 _ CHESTER S

Project: Restaurant De Croone, Ninove

Concept: Lichtadvies Ninove



MODUL
ELECTRO
www.modulelectro.ru



PANTY _ BRIDGE _ 12-25

Project: Hotel Orchidee, Aalter
Concept: Dark studio



MODUL
ELECTRO
www.modulelectro.ru



OBLIVION _ BRIDGE

Project: The Zone, Gent

Architect: Natasia Fanariotis for Redline Projects

CYBE

Project: Tantra, Gent



Red **MODULE**
ELECTRO
www.modulelectro.ru

D2V2

Project: Longin services

Architect: Studio Satrima

HEAPS



Showroom, Roeselare

NO COPY

Project: OCMW, Maldegem

Architect: Aiko



 **MODUL** 
ELECTRO
www.modulelectro.ru





 **MODULE** 

ELECTRO

www.modulelectro.ru

CHUBBY

pimped by CHRISTOPHE COPPENS



MODUL
ELECTRO
www.modulelectro.ru

HOPPY

Project: Fresh Food Distribution Braet
Concept: Integral Eeklo

12-25

Project: Restaurant Oud Sluis, Sluis
Architect: Lieven Musschoot

D2V2

Project: Golf Zone, Linz
Architect: Epps





MODUL
ELECTRO
www.modulelectro.ru

d-SQUEEZE _ BRIDGE

Meeting Point KP2, Kortrijk

NO FRUIT _ BRIDGE

Project: Macchiato, Hasselt

Concept: Puresang





MODUL
ELECTRO
www.modulelectro.ru



POC _ HYPE

Project: Office of architects, Moscow



HOPPY _ 12-25 _ CROSSLIGHT _ NO COPY _ SON OF EDDY

Project: Belgium-EU Pavilion, World Expo 2010, Shanghai
Architect: Conix | Architects







POC

Project: Van Rietschoten Design, Amersfoort
Concept: Martin Van Rietschoten

POC

Project: Showroom Ahrend, Groningen
Architect: Joke Bult en Jeltje De Jong





MODUL
ELECTRO
www.modulelectro.ru





BRIDGE

Project: Private Home, Barcelona
Architects: Soler-Morato



 **MODUL** 
ELECTRO
www.modulelectro.ru



 **MODULO** 
ELECTRO
www.modulelectro.ru

D2V2 _ 12-25
Project: Cocoon, Lambersart

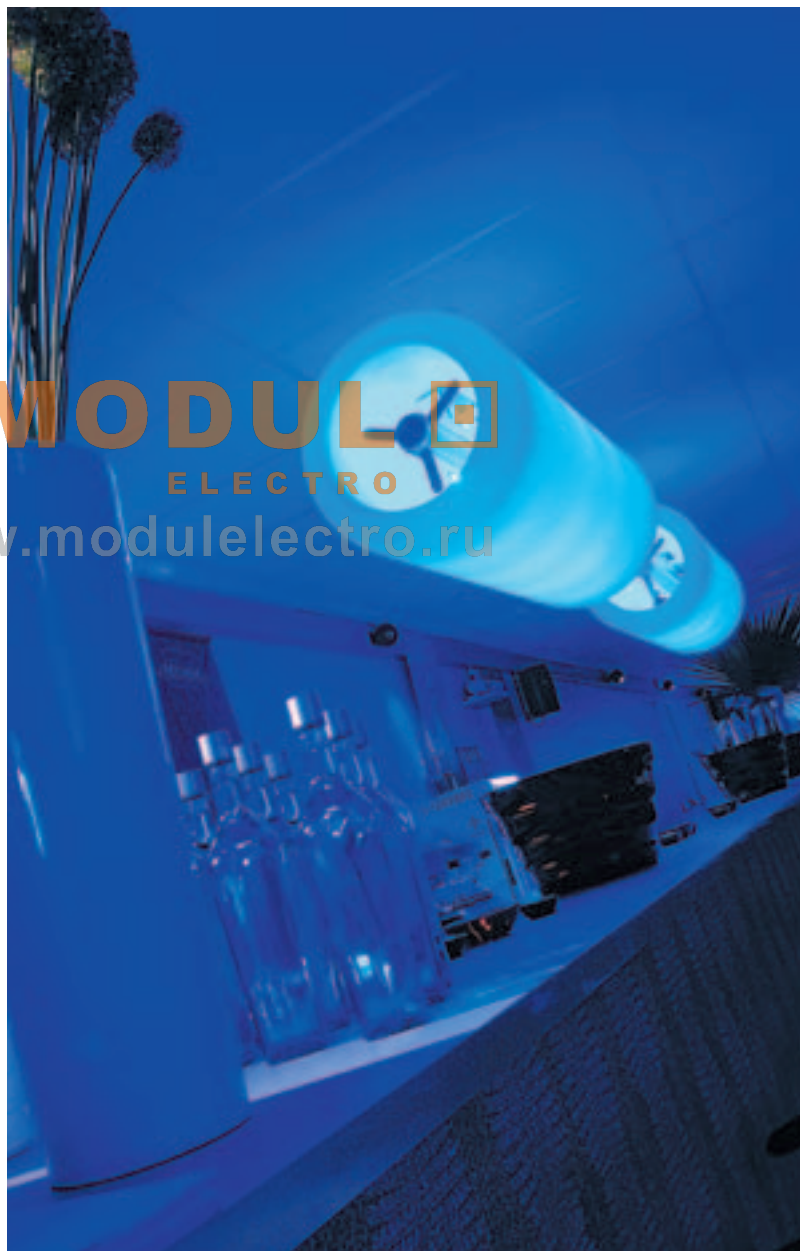

CROSSLIGHT

NO COPY

NO COPY _ METROPOLIS

Project: Dodds, Knokke

Concept: Dark studio



MODUL
ELECTRO
www.modulelectro.ru





MODUL
ELECTRO

www.modulelectro.ru

12-25 _ CROSSLIGHT

Project: De Brooderie, Diksmuide
Concept: Dark studio



MODUL
ELECTRO
www.modulelectro.ru

SQUARE ANGEL

Project: Galerie St-Hubert
Concept: Luc Vincent





BRIDGE _ FRANJE _ CYBE

Project: Priva Campus, Rotterdam
Architect: Confetti reclamefabriek



PAROQ 3

Project: Lingerie Marie-Paule, Wetteren
Concept: Lightlab





MODUL
ELECTRO
www.modulelectro.ru



MODUL
ELECTRO
www.modulelectro.ru

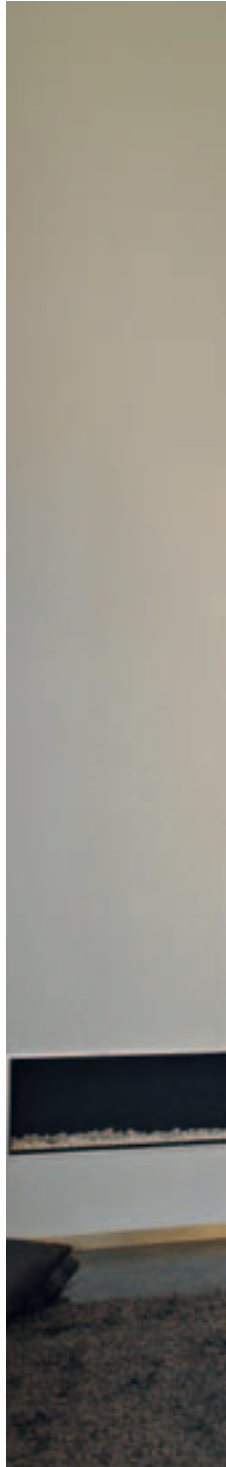



MODUL
ELECTRO
www.modulelectro.ru

OBLIVION

Project: Pami, Brussel
Architect: Wim Vos

TWOLVE

Project: Dilanno, Sint Martens Latem



MODULO
ELECTRO
www.modulelectro.ru



MODULO
ELECTRO
www.modulelectro.ru



CHUBBY
Project: Dodds, Knokke

FRANJE_POC
Project: La Perla, Brussel
Concept: Dark studio

FRANJE

Project: Dudok, Arnhem

GUM

Project: Sweet coffee, Beveren

Architect: Lieven Musschoot





MODUL
ELECTRO
www.modulelectro.ru



MODUL
ELECTRO
www.modulelectro.ru

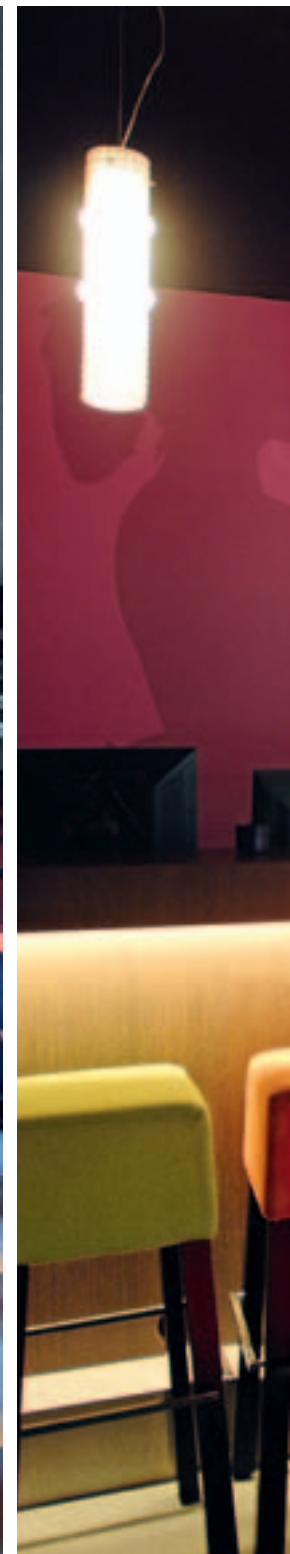

NO FRUIT _ TRAPPED

Project: Tao, Oostende
Architect: Crayon Projects



MODUL
ELECTRO
www.modulelectro.ru



MODUL
ELECTRO
www.modulelectro.ru

SPACEWALKER _ T&T _ PAWWW _ TWOLVE
Reddot Design Museum, Singapore

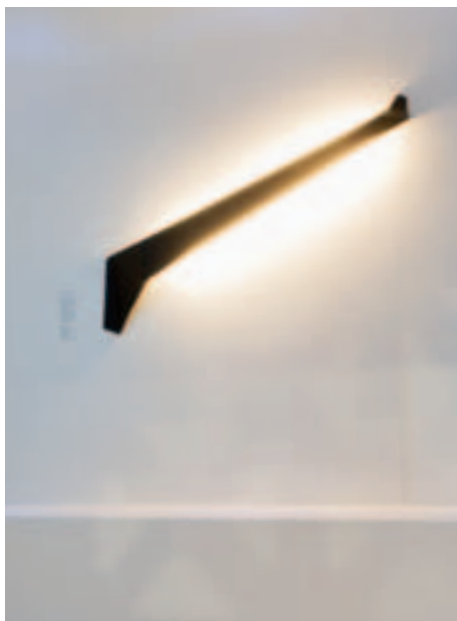



ICE _ JUICE

Project: Willemen, Mechelen
Lighting design: Ivan Missinne



MODULO
ELECTRO
www.modulelectro.ru



 **MODUL** 
ELECTRO
www.modulelectro.ru

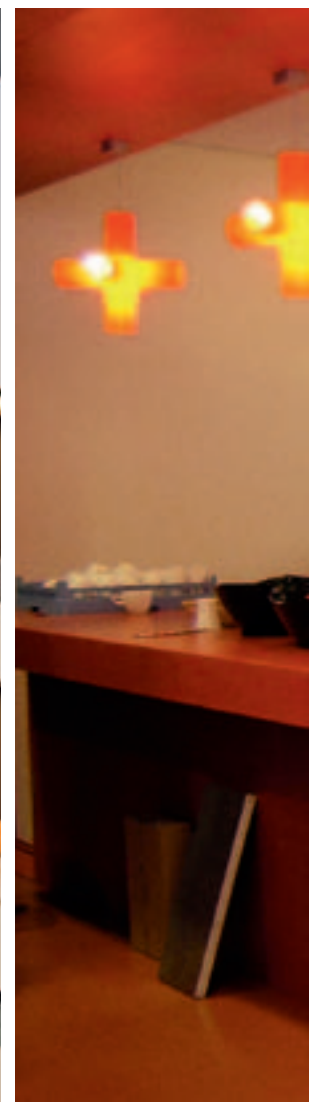

METROPOLIS

Project: Axxent

CROSSLIGHT

Project: Dienst Ruimtelijke orde en Economische zaken, Groningen

Architect: Nicole Lagarde for De Zwarte Hond



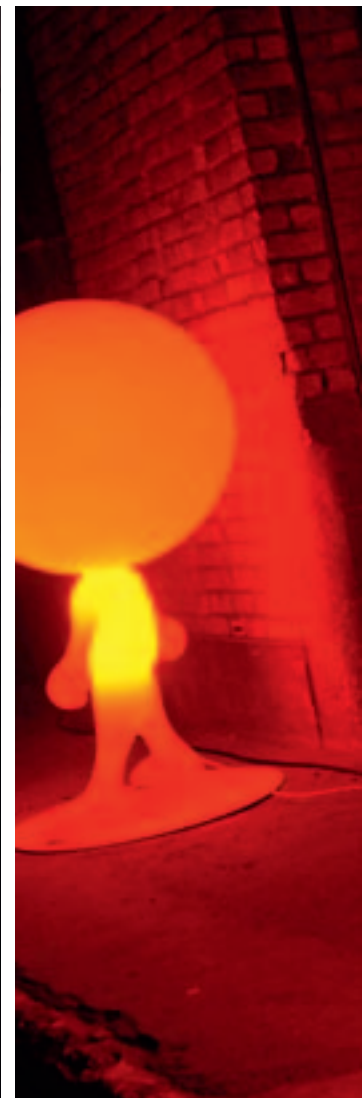

D2V2 _ NO FRUIT

Project: Kinopolis, Luik
Architect: Es°te group

SPACEWALKER

Exterieur 2008









MODUL
ELECTRO
www.modulelectro.ru

NO COPY _ SNOWDOME

Project: Acta, Bommel
Concept: IngeClaudia

CYBE MAX

Project: Scheelinck

SNOWDOME

Project: Hotel Orchidee, Aalter

TSJOEPY

Project: Mr. Grill, Brugge
Architect: Expansion Team

D2V2 _ BRIDGE

Project: Mr. Grill, Brugge
Architect: Expansion Team



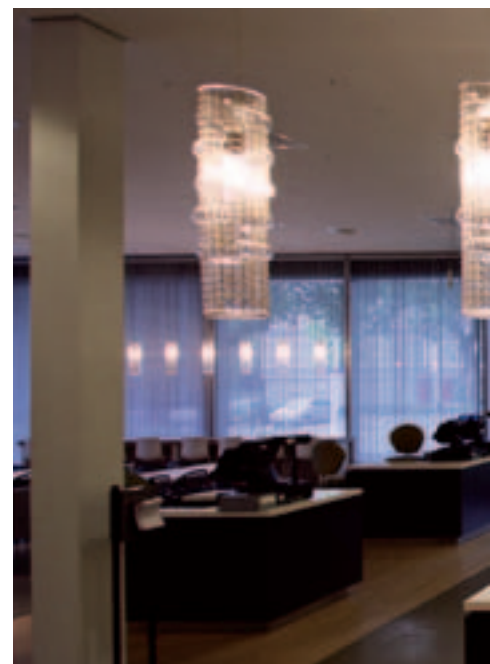



MODUL
ELECTRO
www.modulelectro.ru



ICE

Project: Wim Motors, Lotenhulle
Concept: Dark studio

TSJOEPY

Project: Bultaup

NO FRUIT



Project: Regis Zen Building, Utrecht
Lighting designer: Nadja Smits

TRAPPED

Project: Belastingdienst, Eindhoven
Architects: Jos Brouwers & Minka Weeda

CROSSLIGHT _ HOPPY

Project: Cannockchase, Den Haag
Interior design: Boo

 **MODUL** 
ELECTRO
www.modulelectro.ru





MODULO
ELECTRO
www.modulelectro.ru

POC _d-CONCRETE _ D2V2 FLOOR _ ICE

Project: Espace Concept, GHLuxembourg





MODUL
ELECTRO
www.modulelectro.ru

© Copyright Dark®

Dark has the right to change any technical data, dimensions, colours and characteristics without prior notice. - All rights reserved.

Any reproduction of the Dark products is strictly forbidden and can seriously damage your health and endanger your bank account.

CONCEPT & GRAPHIC DESIGN

Headline

PHOTOGRAPHY

Kris Dekeijser

Wolf+Dort

Verne

Ben Urbain

Marco Mertens

Jorge Ovaa

Hans Morren

Jons Jeronimus

Koen Van Damme



WITH THE SUPPORT OF

Flanders Investment & Trade

Government of Flanders - Belgium

The logo for MODUL ELECTRO features the word "MODUL" in a large, bold, orange sans-serif font, with "ELECTRO" in a smaller, orange sans-serif font below it. The text is flanked by two square icons, each containing a smaller square. Below the logo, the website address "www.modulelectro.ru" is displayed in a grey sans-serif font.

MODUL
ELECTRO
www.modulelectro.ru

 **MODUL** 
ELECTRO
www.modulelectro.ru

HEAD OFFICE:

DARK nv
Beversesteenweg 565
8800 Roeselare – Belgium
Phone +32 51 25 25 55
Fax +32 51 25 25 56
info@dark.be
www.dark.be

DARK WORLDWIDE:

THE NETHERLANDS

Illum
Waaier 50
2451 VW Leimuiden – Nederland
Phone +31 172 506 668
Fax +31 172 506 669
info@illum.nl

UK

13-16 Britton Street
Farringdon
London EC1M 5SX - United Kingdom
Phone +44 20 7253 0402
Fax +44 20 7253 0404
Phone 00800 36 25 36 25 (toll free nr)
Fax 00800 45 60 78 90
uk@dark.eu

ITALY

Via Isonzo 96
10141 Torino – Italia
Phone +39 011 38 35 177
Fax +39 011 38 35 172
italy@dark.eu

GERMANY

Schanzenstrasse 39 D17
51063 Köln – Deutschland
Phone +49 221 96447510
Fax +49 221 96447515
Phone 00800 36 25 36 25 (toll free nr)
Fax 00800 45 60 78 90
germany@dark.eu

IBERIA

Latinoamérica – Angola
C/Emilio Rubín 11
28033 Madrid – España
Phone +34 913 005 470
Fax +34 913 004 730
spain@dark.eu

ASIA PACIFIC LTD.

RM. 1413, Block A, Sea View Estate
2 Watson Road
North Point – Hong Kong
Phone +852 2110 6955
Fax +852 3106 4096
asia@dark.eu



Member of the 2B Delighted® group  **delighted**