

MODULO
ELECTRO

www.modulelectro.ru

el torrent
ILUMINACIÓN LIGHTING



ELECTRO
www.modulelectro.ru

el torrent
ILUMINACIÓN LIGHTING 

DISEÑO

El Torrent nace en Girona en el año 1997 de la mano del diseñador Eloy Puig, con un producto y una producción propios.
 Desde nuestro origen, y gracias al trabajo en equipo y a la colaboración de diseñadores y clientes, hemos apostado por la innovación y la evolución.
 Nuestra exigencia por dar respuestas y soluciones a las necesidades cambiantes del mercado de la iluminación, nos ha llevado a ofrecer una gran adaptabilidad y flexibilidad en nuestros diseños, materiales, medidas y acabados. Actuamos con rapidez ante cualquier reto que se nos proponga, y somos especialistas en proyectos contract y espacios tanto privados como públicos. Fruto de este esfuerzo y dinamismo, actualmente contamos con presencia en más de 47 países.

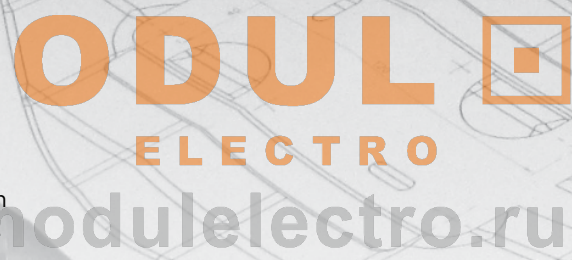
El Torrent wurde 1997 in Girona vom Designer Eloy Puig mit einem eigenen Produkt und eigener Produktion ins Leben gerufen.
 Seit unseren Ursprüngen und dank Teamarbeit und der Zusammenarbeit von Designern und Kunden haben wir auf Innovation und Entwicklung gesetzt.
 Unser Anspruch den sich ändernden Bedürfnissen des Beleuchtungsmarktes Antworten und Lösungen zu liefern, hat uns dazu geführt, eine große Anpassungsfähigkeit und Flexibilität bei unseren Designs, Materialien, Größen und Finishes anzubieten. Vor jeder sich uns stellenden Herausforderung handeln wir schnell, wobei wir Spezialisten für Objektprojekte und öffentliche sowie private Räume sind. Als Ergebnis dieser Anstrengung und Dynamik sind wir zurzeit in mehr als 47 Ländern vertreten.



El Torrent was formed in 1997 in Girona by the designer Eloy Puig, with its own production and its own products.
 From our beginning, through teamwork and the collaboration of designers and clients, we have opted for innovation and evolution.
 It is essential to us to supply answers and solutions to the changing needs of the lighting market which has led to the great adaptability and flexibility of our designs, materials, sizes and finishes. We react fast to any challenge, and are specialists in contract projects and both private and public spaces. As a result of our work and dynamic attitude we currently have a market presence in more than 47 countries.

El Torrent naît en 1997, à Girona, de la main du designer Eloy Puig, avec son propre produit et sa propre production.
 Dès nos débuts, grâce à un travail d'équipe et à la collaboration de designers et de clients, nous avons misé sur l'innovation et l'évolution.
 Notre souci en vue d'apporter des réponses et des solutions aux besoins changeants du marché de l'éclairage nous a conduits à offrir une grande adaptabilité et une grande flexibilité sur nos designs, matériaux, dimensions et finitions, en agissant avec rapidité face à tout défi qui nous est lancé, en tant que spécialistes en projets contract et espaces aussi bien privés que publics. Fruit de cet effort et de ce dynamisme, nous sommes aujourd'hui présents dans 47 pays au bas mot.

ELOY PUIG



ENRIC MIRALBELL

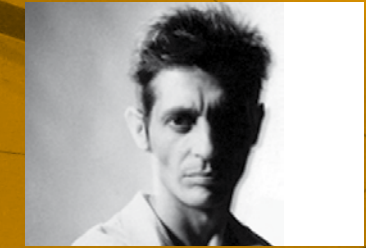

STIMULO



ANDREU CARULLA



JOAN GENEBA



colaborador collaborator

	AFRO ☐☐ 192		ANKARA ☐☐☐☐ 126		AQUA ☐☐☐ 146		ARKA ☐ 228		AYDA ☐ 220		BERTA ☐☐☐ 104
	COCO ☐☐ 188		DAYA ☐ 174		DONNA ☐☐ 100		DOUCE ☐☐☐☐ 168		DUNA ☐ 054		ELSA ☐☐☐☐ 018
	EVA ☐ 058		FINE ☐☐☐☐ 014		FLOCK ☐☐☐☐ 034		HALL ☐ 164		ISSABEL ☐☐☐ 110		KOORAL BYN ☐☐☐ 070
	LEAF ☐ 044		LIA ☐☐☐☐ 120		LYZZA ☐ 160		MALAKA ☐ 136		NAGAR ☐ 216		NANSSA ☐☐☐ 080
	NATUR ☐☐ 132		NEO ☐☐☐☐ 154		NEX ☐☐☐☐ 022		NONA ☐☐☐ 074		NUVIA ☐☐ 092		OBELISK ☐☐ 200
	ODA ☐☐☐☐ 048		OVLA ☐ 224		PISTŌ ☐☐ 196		QUEEN ☐☐ 150		ROMA ☐☐☐☐ 026		SAND ☐☐☐ 116

MODULO
ELECTRO
www.modulselectro.ru

006.



SENA
□
212



SERENA
□ □
096



SONORA
□ □ □ □
030



SUITE
□ □
140



SWARS
□
038



SYLVA
□
180

.007



TELMA
□ □
184

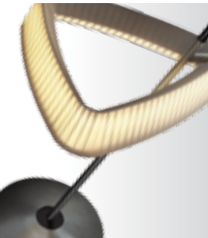

TREBOLA
□ □ □ □
010



TRUDY
□ □ □
086



VERSATIL
□
064



XENIA
□ □ □ □
204



YUOK
□ □ □ □
208

INDEX CONTRACT

INDEX EXTRAS



ANDREA
□
242



APLIQUES
□
284



AROS
□
266



AROS 2X
□
270



AROS DOBLES
□
272

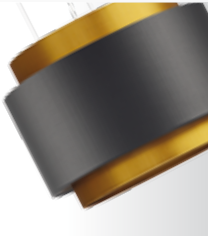

AROS TRIPLES
□
274



KEOPS
□
246



PLAFO NES
□
278



SMOOTH
□
260



SQUARE
□
254

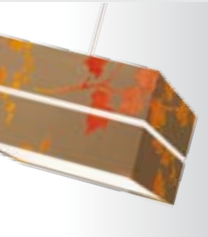

SQUARE 2X
□
258



TRYP
□
250



TUBS
□ □ □
234



PERSONALIZAR
□
294



TELAS

296



SOPORTES

306



CABLES

307

MODUL ELECTRO
www.modulelectro.ru



MODUL
ELECTRO

COLECCIONES

www.modulelectro.ru

COLECCIONES

El Torrent presenta sus innovadoras colecciones, adaptadas a las tecnologías más actuales y apostando por un diseño sutil que busca la calidez y el confort.

Luminarias con acabados de gran calidad que, por las posibilidades que ofrecen sus materiales, pueden transformarse para ser integradas en cualquier ambiente.

COLLECTIONS

El Torrent introduces its innovative collections which combine up-to-date technology with subtle designs that create warmth and comfort.

Our lights have high quality finishes in a variety of materials so they can be integrated into any environment.

KOLLEKTIONEN

El Torrent präsentiert seine innovativen, an die aktuellsten Technologien angepassten Kollektionen, wobei auf ein subtiles, auf Wärme und Komfort ausgerichtetes Design gesetzt wird.

Beleuchtungen mit Finishes von höchster Qualität, die aufgrund der Möglichkeiten, die ihre Materialien bieten, verwandelt werden können, um in allen möglichen Umgebungen integriert zu werden.

COLLECTIONS

El Torrent présente ses collections innovantes, adaptées aux technologies les plus actuelles, et cela en misant sur un design subtil recherchant la qualité et le confort.

Luminaires à finitions de grande qualité qui, de par les possibilités qu'offrent leurs matériaux, peuvent se transformer pour être intégrés dans n'importe quelle ambiance.

010.TREBOLA

Modelo de mesa con
iluminación por LEDs.
Acabado niquelado y pantalla
encintada blanca.

Table lamp, LED lighting.
Nickel plated finish and white
pleated lampshade.

Tischmodell, Beleuchtung
durch LEDs.
Vernickeltes Finish, Schirm
weiß foliert.

Modèle de table, éclairage
par LED.
Finition nickel et abat-jour
enrubanné blanc.

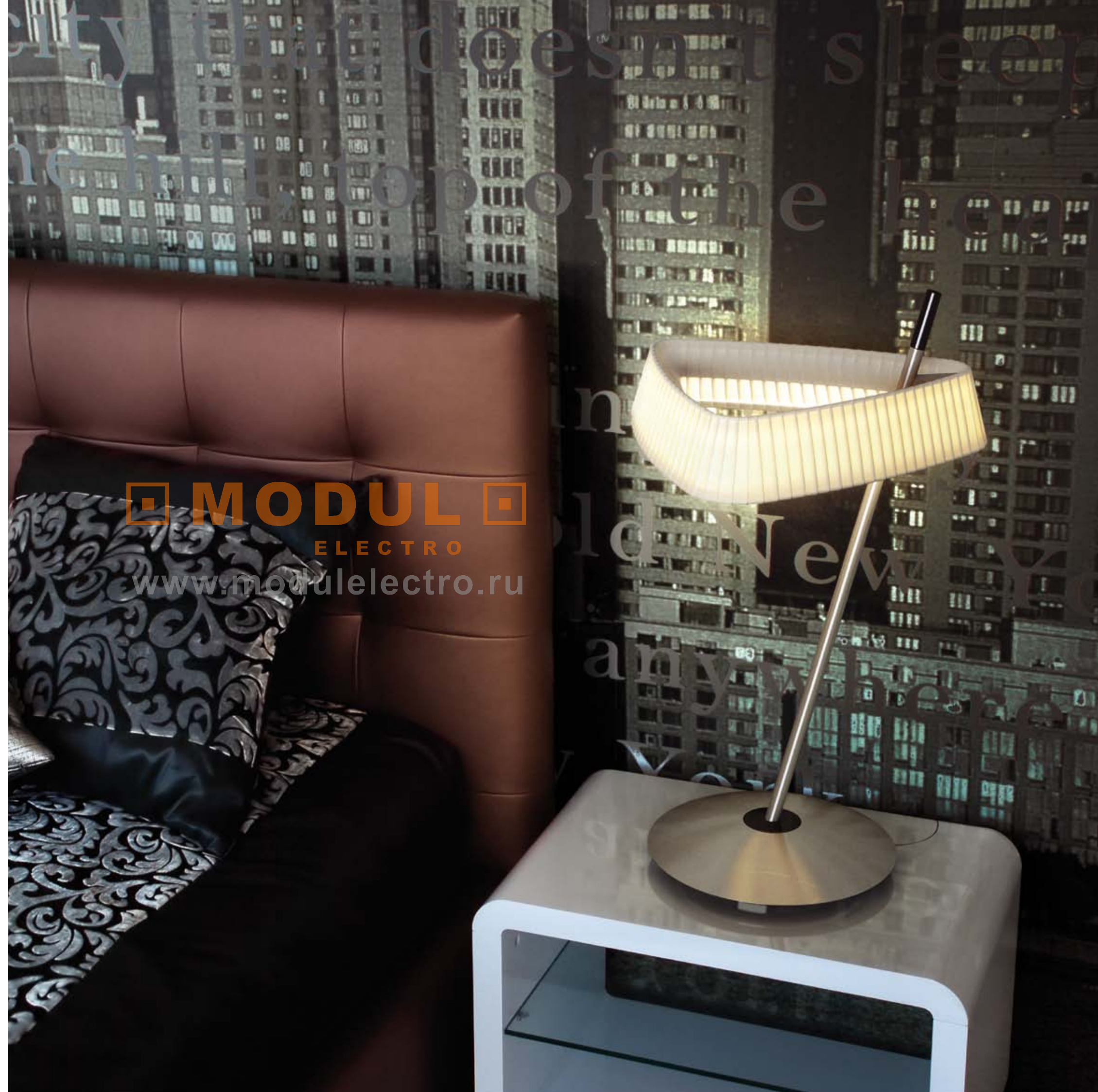

MODUL
ELECTRO
www.modulelectro.ru



design Stimulo
year 2010



012.

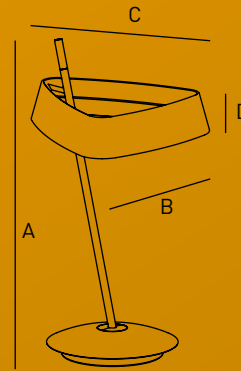

	A	B	C	D	DIF	
TL.001	62cm	33cm	36cm	8cm		LEDs 20w

MODUL
ELECTRO
www.modulelectro.ru

.013



014.FINE

Colgante extraplana de 6cm con iluminación por LEDs. Difusor superior de aluminio pulido y difusor inferior de metacrilato. Pantalla disponible en cualquier material. Florón niquelado y cable transparente.

6cm slim-line pendant light, LED lighting. Upper diffuser in polished aluminium, lower diffuser in acrylic. Lampshade available in any material. Nickel plated ceiling rose, transparent cable.

Deckenleuchte extraflach 6cm, Beleuchtung durch LEDs. Oberer Diffusor aus poliertem Aluminium, unterer aus Metacrylat. Schirm in allen Materialien verfügbar. Vernickelter Baldachin, transparentes Kabel.

Lustre extraplat de 6 cm, éclairage par LED. Diffuseur supérieur en aluminium poli, inférieur en méthacrylate. Abat-jour disponible dans n'importe quel matériel. Fleuron nickelé câble transparent.



design Eloy Puig
year 2010



016.



MODUL
ELECTRO
www.modulelectro.ru

.017

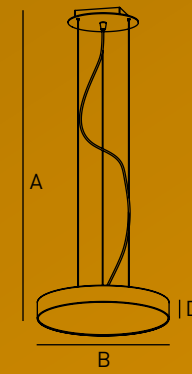

	A	BØ	D	DIF	LED
FI.001	130cm	45cm	6cm	•	LEDS 30w
FI.002	130cm	60cm	6cm	•	LEDS 60w



018.ELSA

Colgante con difusor troncocónico y difusor superior cromado. Iluminación oculta en el interior. Pantalla disponible en cualquier material. Florón cromado.

Pendant light with truncated cone diffuser and chromed upper diffuser. Hidden interior lighting. Lampshade available in any material. Chromed ceiling rose.

Deckenleuchte mit kegelstumpfarmigem Diffusor und verchromtem oberem Diffusor. Beleuchtung im Inneren versteckt. Schirm in jedem Material erhältlich. Verchromter Baldachin.

Lustre à diffuseur tronconique et diffuseur supérieur chromé. Éclairage dissimulé à l'intérieur. Abat-jour disponible dans n'importe quel matériel. Fleuron chromé.



design Andreu Carulla
year 2010



MODUL
ELECTRO
www.modulelectro.ru



020



021

	A	BØ	D	DIF	
EL.001	130cm	47cm	22cm	•	1xTLE 60w

MODUL
ELECTRO
www.modulelectro.ru



022.NEX

Colgante de doble pantalla.
Difusor superior de aluminio pulido y difusor inferior de metacrilato. Florón niquelado. Pantalla interior a escoger entre materiales lisos.

Pendant light with double lampshade. Upper diffuser in polished aluminium, lower diffuser in acrylic. Nickel plated ceiling rose. Choice of plain materials for interior lampshade.

Deckenleuchte mit zwei Schirmen. Oberer Diffusor aus poliertem Aluminium, unterer aus Metacrylat. Vernickelter Baldachin. Innerer Schirm aus glattem Material zu wählen.

Lustre à double abat-jour. Diffuseur supérieur en aluminium poli, inférieur en méthacrylate. Fleuron nickelé. Abat-jour intérieur au choix en matériel lisse.



design Eloy Puig
year 2010



MODULO
ELECTRO
www.modulelectro.ru



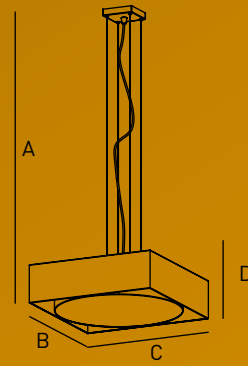

	A	B	C	D	DIF	
NX.001	130cm	50cm	50cm	15cm	•	4xE-27 FLC 20w



MODUL
ELECTRO
www.modulelectro

026.ROMA

Colgante rectangular
extraplana de 6cm con
iluminación por LEDs. Difusor
superior de aluminio pulido y
difusor inferior de metacrilato.
Pantalla disponible en
cualquier material. Florón
níquelado y cable transparente.

6cm slim-line rectangular
pendant light, LED lighting.
Upper diffuser in polished
aluminium, lower diffuser in
acrylic. Lampshade available
in any material. Nickel plated
ceiling rose, transparent cable.

Deckenleuchte, rechteckig,
extraflach 6 cm, Beleuchtung
durch LEDs. Oberer Diffusor
aus poliertem Aluminium,
unterer aus Metacrylat. Schirm
in jedem Material erhältlich.
Vernickelter Baldachin,
transparentes Kabel.

Lustre rectangulaire extraplat
de 6 cm, éclairage par LED.
Diffuseur supérieur en
aluminium poli, inférieur
en méthacrylate. Abat-jour
disponible dans n'importe quel
matériel. Fleuron nickelé câble
transparent.



design Eloy Puig
year 2010



MODUL
ELECTRO
www.modulelectro.ru

028.



MODUL
ELECTRO
www.modulelectro.ru

.029

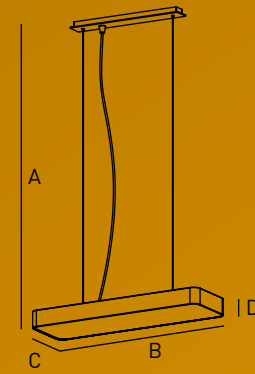

	A	B	C	D	DIF	LED
RM.001	130cm	65cm	20cm	6cm	•	LEDS 30w
RM.002	130cm	120cm	20cm	6cm	•	LEDS 60w



030.SONORA

Colgante de textil negro exterior y vinilo grabado interior. Difusor superior de aluminio pulido e inferior semiesférico de metacrilato. Florón cromado y cable textil naranja.

Pendant light with black textile exterior and engraved vinyl interior. Upper diffuser in polished aluminium, semi-spherical lower diffuser in acrylic. Chromed ceiling rose with orange fabric cable.

Deckenleuchte aus schwarzem Stoff außen und geprägtem Vinyl innen. Oberer Diffusor aus poliertem Aluminium, unterer halbkugelförmig aus Metacrylat. Verchromter Baldachin, oranges Stoffkabel.

Lustre en textile noir extérieur et vinyle gravé intérieur. Diffuseur en aluminium poli, inférieur semi-sphérique en méthacrylate. Fleuron chromé câble textile orange.



design Eloy Puig
year 2010



MODUL
ELECTRO
www.modulelectro.ru





MODUL
ELECTRO
www.modulelectro.ru

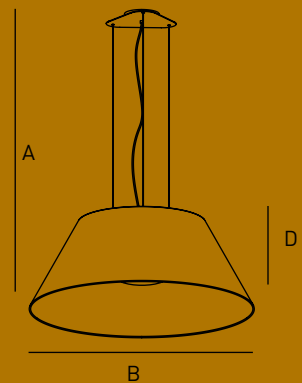

	A	BØ	D	DIF	
50.001	130cm	80cm	40cm	•	1xTLE 60w



034.FLOCK

Modelo de pie con cuerpo cromado y pantalla esférica encintada grupo C.

Floor lamp with chrome body and spherical group C pleated lampshade.

Stehmodell, Körper verchromt, kugelförmiger Schirm, foliert Gruppe C.

Modèle sur pied, corps chromé, abat-jour sphérique enrubanné groupe C.

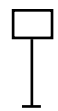

Colgante con florón cromado, pantalla esférica encintada grupo C.

Pendant light with chrome ceiling rose and spherical group C pleated lampshade.

Deckenleuchte, verchromte Basis, kugelförmiger Schirm, foliert Gruppe C.

Lustre, fleuron chromé, abat-jour sphérique enrubanné groupe C.



design Eloy Puig
year 2010



MODULO
ELECTRO
www.modulelectro.ru

036



037

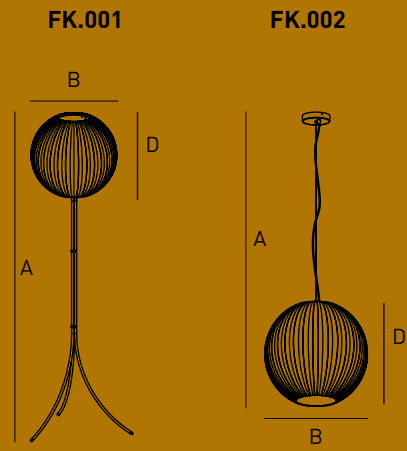

	A	BØ	D	DIF	⚡
FK.001	160cm	45cm	45cm		1xE-27 FLC 65w
FK.002	130cm	45cm	45cm		1xE-27 FLC 65w

MODUL
ELECTRO
www.modulelectro.ru



038.SWARS

Modelo de pie con base cromada, pantallas de **"Cristal" blanco y negro**, difusor de metacrilato inferior y superior en la pantalla central.

Floor lamp with chromed base, lampshades in **black and white "Cristal"** material, upper and lower acrylic diffuser in central lampshade.

Stehmodell, verchromte Basis, Schirme aus **schwarzem und weißem "Glas"**-Material, oberer und unterer Diffusor im zentralen Schirm aus Metacrylat.

Modèle sur pied, base chromée, abat-jour en matériel **«Cristal» blanc et noir**, diffuseur en méthacrylate inférieur et supérieur sur abat-jour central.

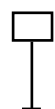

Colgante, florón cromado, pantallas de **"Cristal" blanco y negro**, difusor de metacrilato inferior y superior en la pantalla central.

Pendant light with chrome ceiling rose, lampshades in **black and white "Glass"**, upper and lower acrylic diffuser in central lampshade.



Deckenleuchte, verchromte Basis, Schirme aus **schwarzem und weißem "Glas"**-Material, oberer und unterer Diffusor im zentralen Schirm aus Metacrylat.

Lustre, fleuron chromé, abat-jour en matériel **«Cristal» blanc et noir**, diffuseur en méthacrylate inférieur et supérieur sur abat-jour central.



design Eloy Puig
year 2010



 **MODUL** 
ELECTRO
www.modulelectro.ru

040.

.041



MODULO
ELECTRO
www.modulelectro.ru

SW.001



SW.002

MODUL
ELECTRO
www.modulelectro.ru

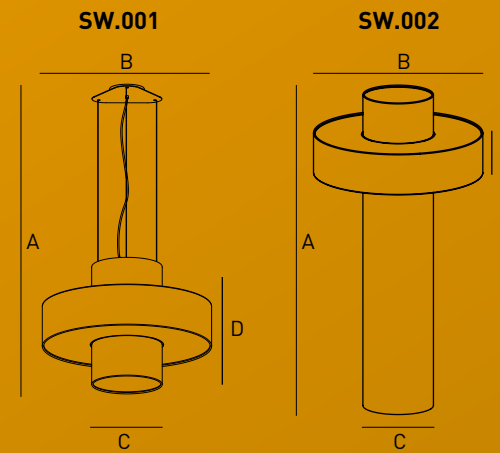

	A	BØ	CØ	D	DIF	⊕
SW.001	130cm	60cm	25cm	50cm	•	4xE-27 FLC 21w
SW.002	175cm	60cm	25cm	15cm	•	7xE-27 FLC 21w





044.LEAF

Aplique de polímero mineral
translúcido, iluminado por LEDs.
Modular mediante una sola toma
de corriente hasta 12 unidades.

Translucent mineral-polymer
wall light with LED lighting.
Modular use from one power
point for up to 12 units.

Wandlampe aus
durchscheinendem Polymer-
Mineral, durch LEDs
beleuchtet.
Mit einer einzigen Steckdose
sind bis zu zwölf Einheiten
modulierbar.

Applique en polymère-minéral
translucide, éclairage par LED.
Modulable au moyen d'une
seule prise de courant jusqu'à
12 unités.

 **MODUL** 
ELECTRO
www.modulelectro.ru



design Andreu Carulla
year 2010



OFF

ON



MODUL
ELECTRO
www.modulelectro.ru

Possibles combinaciones
Possible combinations
Mögliche Kombinationen
Possibles combinaisons

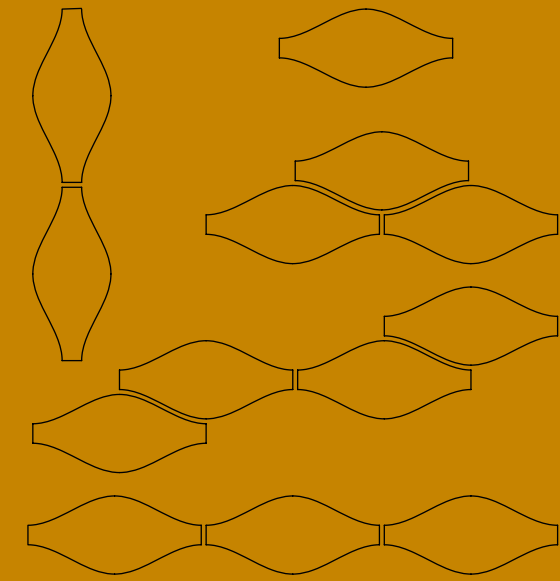
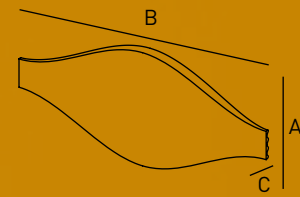

	A	B	C	DIF	
LF.001	16cm	35cm	3,5cm		LEDS 10w



048.ODA

Colgante de cristal fusión,
iluminado por LEDs, con
cuerpo niquelado y cable
textil rojo.

Crystal fusion pendant light
with LED lighting, nickel plated
body and red fabric cable.



Deckenleuchte aus
verschmolzenem Glas,
beleuchtet durch LEDs, Körper
vernickelt und rotes Stoffkabel.

Lustre en verre fusion,
éclairage par LED, corps
nickelé et câble textile rouge.



design Andreu Carulla
year 2010



 **MODUL** 
ELECTRO
www.modulelectro.ru





MODUL
ELECTRO
www.modulelectro.ru

OD.003



MODUL
ELECTRO
www.modulelectro.ru

OD.001

	A	BØ	D	DIF	Light Bulb
OD.001	80cm	20cm	25cm		1xLED 3w
OD.002	80cm	50cm	25cm		5xLEDS 3w
OD.003	80cm	50cm	25cm		8xLEDS 3w



054.DUNA

Colgante con florón niquelado
y pantalla encintada grupo C.

Pendant light with nickel
plated ceiling rose and group C
pleated lampshade.

Deckenleuchte mit
vernicheltem Baldachin und
Schirm foliert Gruppe C.

Lustre à fleuron nickelé et
abat-jour enrubanné groupe C.



MODUL
ELECTRO

www.modulelectro.ru



design Eloy Puig
year 2005





DU.012

MODUL
ELECTRO
www.modulelectro.ru

	A	B	C	D	DIF	
DU.012	130cm	80cm	30cm	20cm		2xE-27 FLC 20w
DU.013	130cm	100cm	35cm	25cm		2xE-27 FLC 20w
DU.014	130cm	120cm	40cm	30cm		2xE-27 FLC 20w
DU.064	130cm	170cm	60cm	40cm		6xE-27 FLC 20w



058.EVA

Colgante con florón niquelado y cúpula encintada grupo C.

Pendant light with nickel plated ceiling rose and group C pleated dome.

Deckenleuchte mit vernickeltem Baldachin und Kuppel foliert Gruppe C.

Lustre à fleuron nickelé et coupole enrubannée groupe C.



MODUL
ELECTRO
www.modulelectro.ru



design Eloy Puig
year 2009





EV.419 **MODUL** ELECTRO
www.modulelectro.ru



EV.419

MODUL
ELECTRO
www.modulelectro.ru

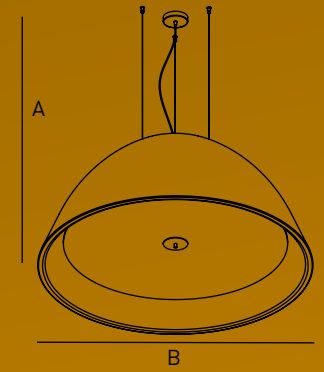

	A	BØ	D	DIF	⚡
EV.419	130cm	60cm	30cm	•	3xE-27 FLC 11w
EV.420	130cm	80cm	40cm	•	4xE-27 FLC 21w
EV.421	130cm	130cm	70cm	•	6xE-27 FLC 45w



064.VERSATIL

Colgante modular disponible en dos tamaños.

VE.474 permite formar círculos de hasta 225 cm de diámetro.

VE.475 permite formar círculos de hasta 300 cm de diámetro.

Cualquier otra geometría es posible combinándola también con el modelo rectangular **SQ.054**.

Florón niquelado.

Pantalla disponible en cualquier material.

Modular pendant lamp available in two sizes.

VE.474 gives spotlighting of up to Ø 225 cm.

VE.475 gives spotlighting of up to Ø 300 cm.

Any other size can be created when combined with the **SQ.054** rectangular model.

Nickel plated ceiling rose.

Lampshade available in any material.

Moduldeckenleuchte, verfügbar in zwei Größen.

VE.474 ermöglicht es, Kreise von bis zu Ø 225 cm zu formen.

VE.475 ermöglicht es, Kreise von bis zu Ø 300 cm zu formen.

Oder jegliche andere mögliche geometrische Form auch in Kombination mit dem rechteckigen Modell **SQ.054**.

Vernickelter Baldachin.

Schirm in jedem Material erhältlich.

Lustre modulaire disponible en deux tailles.

VE.474 permet de former des cercles jusqu'à Ø 225 cm .

VE.475 permet de former des cercles jusqu'à Ø 300 cm .

Ou toute autre géométrie possible en le combinant aussi avec le modèle rectangulaire **SQ.054**.

Fleuron nickelé.

Abat-jour disponible dans n'importe quel matériel.



design Eloy Puig
year 2009





MODUL
ELECTRO
www.modulelectro.ru





VE.474



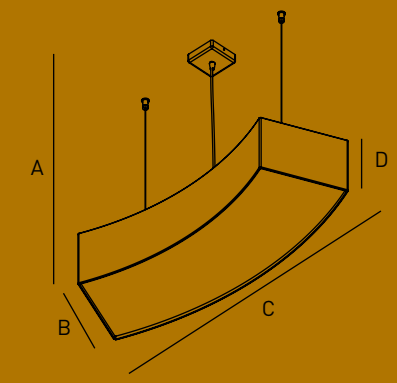

MODUL
ELECTRO
www.modulelectro.ru



	A	B	C	D	DIF	
VE.474	130cm	25cm	85cm	17cm	•	4xE-27 11w
VE.475	130cm	35cm	120cm	25cm	•	4xE-27 21w

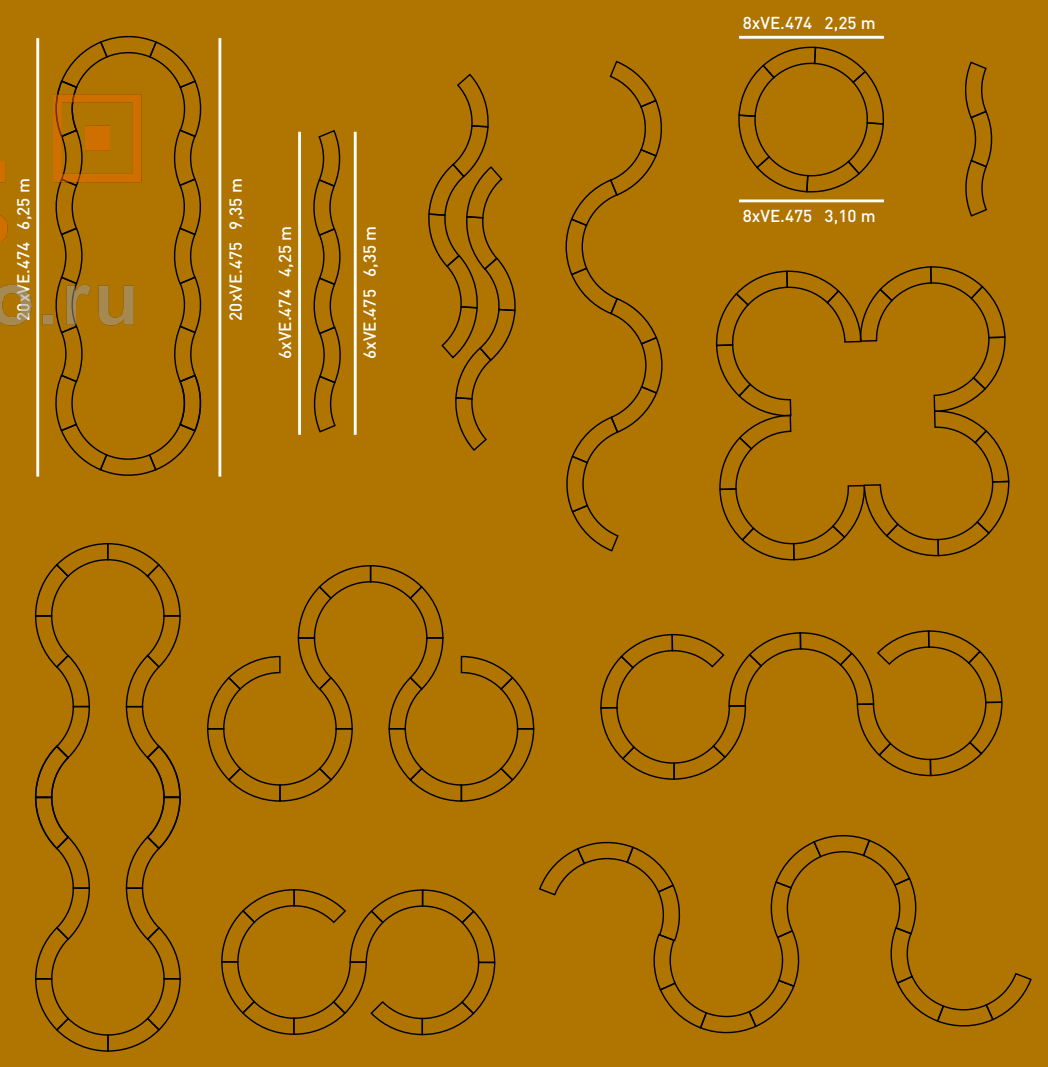

070.KOORALBYN

Modelo de sobremesa con base cromada y grafito negro; pantalla de chenilla negra y cristal Swarovski.

Table lamp with a chromed and black graphite base and a black chenille and Swarovski crystal lampshade.

Tischlampe, Basis verchromt und schwarzer Grafit, Schirm aus schwarzer Chenille und Swarovski Kristall.

Modèle de table, base chromée et graphite noir, abat-jour en chenille noire et verre Swarovski.



Colgante cromado y grafito negro; pantalla de chenilla negra y cristal Swarovski.

Chromed and black graphite pendant light with black chenille and Swarovski crystal lampshade.

Deckenleuchte verchromt und schwarzer Grafit, Schirm aus schwarzer Chenille und Swarovski Kristall.

Lustre chromé et graphite noir, abat-jour en chenille noire et verre Swarovski.



design Eloy Puig
year 2009





www.modulelectro.ru



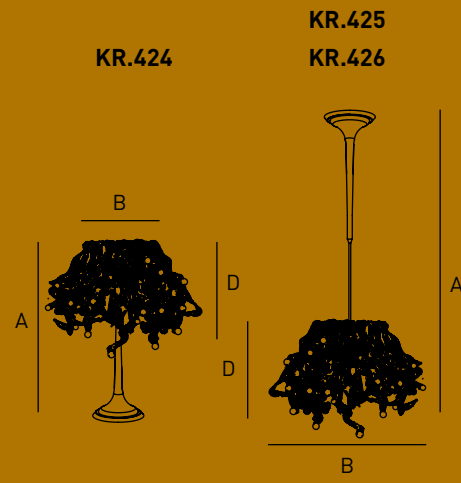

KR.424

MODUL
ELECTRO
www.modulelectro.ru



	A	BØ	D	DIF	⚡
KR.424	48cm	40cm	40cm	•	1xE-27 FLC 11w
KR.425	130cm	40cm	40cm	•	1xE-27 FLC 21w
KR.426	130cm	60cm	50cm	•	1xE-27 FLC 45w



074.NONA

Modelo con base niquelada, doble pantalla, exterior de organza bordada e interior blanco.

Floor lamp with nickel plated base, double lampshade with embroidered organdie exterior and white interior.

Modell, vernickelte Basis, doppelter Schirm, außen bestickter Organza, innen weiß.

Modèle à base nickelée, double abat-jour, extérieur organza brodé intérieur blanc.

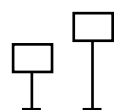

Colgante niquelado, doble pantalla, exterior de organza bordada e interior blanco.

Pendant light with nickel plated base, double lampshade with embroidered organdie exterior and white interior.

Deckenleuchte vernickelt, doppelter Schirm, außen bestickter Organza, innen weiß.

Lustre nickelé, double abat-jour, extérieur organza brodé intérieur blanc.



design Eloy Puig
year 2009

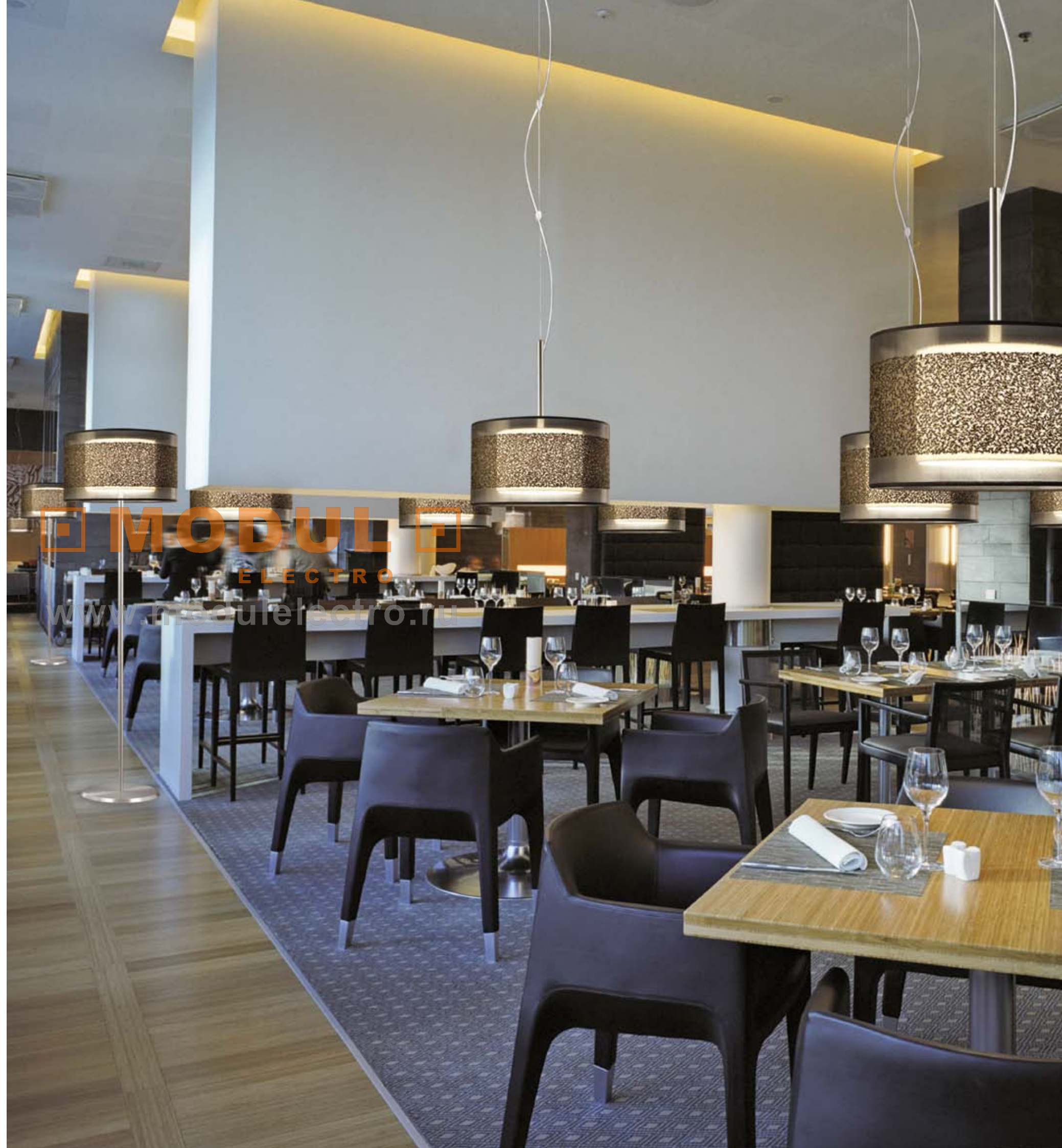



NN.455



www.modulelectro.ru



NN.456

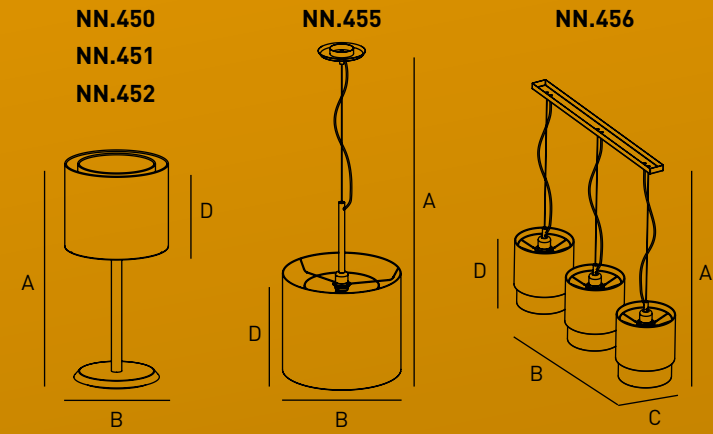

MODUL
ELECTRO
www.modulelectro.ru



	A	BØ	D	DIF	⚡
NN.450	40cm	20cm	17cm		1xE-27 FLC 15w
NN.451	75cm	40cm	27cm		1xE-27 FLC 25w
NN.452	165cm	40cm	27cm		1xE-27 FLC 25w
NN.455	130cm	40cm	27cm		1xE-27 FLC 25w
NN.456	130cm	85cm	25cm	20cm	3xE-27 FLC 21w



080.NANSSA

Modelo con base niquelada,
doble pantalla, exterior de
rejilla tafetán e interior blanco.

Floor lamp with nickel plated
base, double lampshade with
taffeta grille exterior and
white interior.

Modell, vernickelte Basis,
doppelter Schirm, außen
Taftgitter, innen weiß.

Modèle à base nickelée, double
abat-jour, extérieur résille
taffetas intérieur blanc.

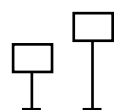

Colgante niquelado con doble
pantalla, exterior de rejilla
tafetán e interior blanco.

Nickel pendant light with
double lampshade with a
taffeta grille exterior and
white interior.

Deckenleuchte vernickelt,
doppelter Schirm, außen
Taftgitter, innen weiß.

Lustre nickelé, double abat-
jour, extérieur résille
taffetas intérieur blanc.



design Eloy Puig
year 2009



MODUL
ELECTRO
www.modulelectro.ru





MODUL
ELECTRO
www.modulelectro.ru

NS.467



NS.466





NS.470



NS.472

MODUL
ELECTRO
www.modulelectro.ru

NS.466
NS.467
NS.468

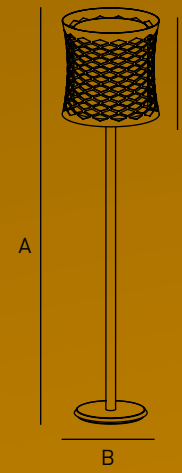

NS.469
NS.470
NS.471
NS.472
NS.473

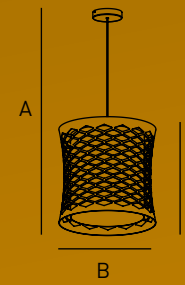

	A	B	D	DIF	⚡
NS.466	40cm	20cm	22cm		1xE-27 FLC 11w
NS.467	85cm	40cm	40cm		1xE-27 FLC 25w
NS.468	175cm	40cm	40cm		1xE-27 FLC 25w
NS.469	130cm	40cm	40cm		1xE-27 FLC 21w
NS.470	130cm	60cm	40cm		1xE-27 FLC 25w
NS.471	130cm	80cm	40cm		3xE-27 FLC 25w
NS.472	130cm	100cm	45cm		4xE-27 FLC 25w
NS.473	130cm	40cm	90cm		4xE-27 FLC 25w



086.TRUDY

Modelo con base niquelada, triple pantalla troquelada e interior liso a escoger.

Floor lamp with nickel base, triple die-cut lampshade with choice of plain interior.

Modell, vernickelte Basis, geprägter dreifacher Schirm, innen glatt auswählbar.

Modèle à base nickelée, triple abat-jour imprimé, intérieur uni au choix..

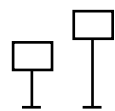

Colgante niquelado con triple pantalla troquelada e interior liso a escoger.

Pendant light with nickel base, triple die-cut lampshade with choice of plain interior.

Vernickelte Deckenleuchte, geprägter dreifacher Schirm, innen glatt auswählbar.

Lustre nickelé, triple abat-jour imprimé, intérieur uni au choix.



design Eloy Puig
year 2009





TD.418

MODUL
ELECTRO
www.modulelectro.ru



TD.417



.089



TD.416



TD.415

MODUL
ELECTRO
www.modulelectro.ru

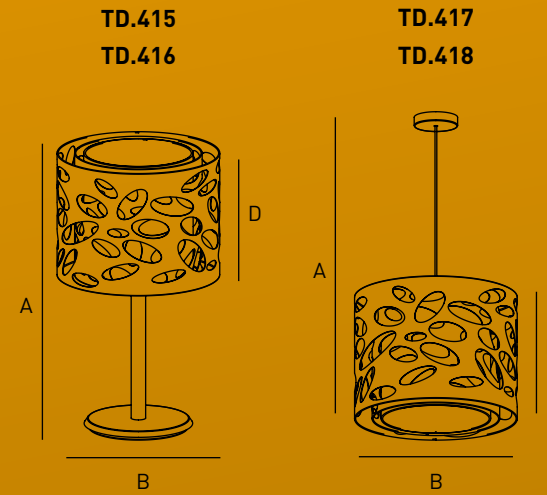

	A	BØ	D	DIF	☑
TD.415	80cm	45cm	35cm		1xE-27 FLC 25w
TD.416	170cm	45cm	35cm		1xE-27 FLC 25w
TD.417	130cm	45cm	35cm		1xE-27 FLC 25w
TD.418	130cm	60cm	35cm		1xE-27 FLC 25w



092.NUVIA

Modelo con base niquelada y pantalla disponible en cualquier material.

Floor lamp with nickel plated base, lampshade available in any material.

Modell, vernickelte Basis, Schirm in allen Materialien verfügbar.

Modèle à base nickelée, abat-jour disponible dans n'importe quel matériel.

www.modulelectro.ru

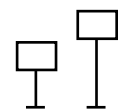

design Equipo ElTorrent
year 2006





NV.433



NV.432



NV.431



MODUL ELECTRO
www.modulelectro.ru

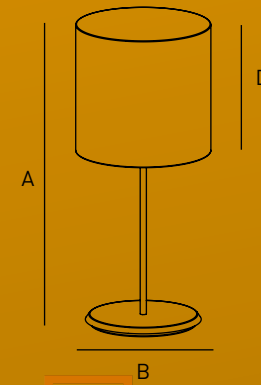

	A	BØ	D	DIF	⚡
NV.431	38cm	18cm	18cm		1xE-27 FLC 11w
NV.432	80cm	35cm	35cm		1xE-27 FLC 25w
NV.433	170cm	35cm	35cm		1xE-27 FLC 25w



096.SERENA

Modelo con base niquelada
y pantalla disponible en
cualquier material.

Floor lamp with nickel plated
base, lampshade available in
any material.

Modell, vernickelte Basis,
Schirm in allen Materialien
verfügbar.

Modèle à base nickelée, abat-
jour disponible dans n'importe
quel matériel.

www.modulelectro.ru

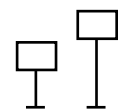

design Equipo ElTorrent
year 2006





MODULO
ELECTRO
www.modulelectro.ru

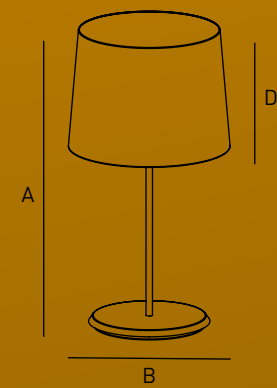

	A	BØ	D	DIF	⚡
SR.442	33cm	18cm	13cm		1xE-27 FLC 11w
SR.443	72cm	30cm	20cm		1xE-27 FLC 25w
SR.444	162cm	40cm	25cm		1xE-27 FLC 25w

100.DONNA

Modelo de cuerpo cónico cromado y pantalla disponible en cualquier material.

Floor lamp with chromed conical body, lampshade available in any material.

Modell mit kegelförmigem, verchromtem Körper, Schirm in allen Materialien verfügbar.

Modèle à corps conique chromé, abat-jour disponible dans n'importe quel matériel.



DN.429

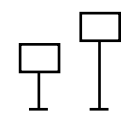

design Eloy Puig
year 2009



MODUL
ELECTRO
www.modulelectro.ru





DN.428



DN.427

MODUL
ELECTRO
www.modulelectro.ru

	A	BØ	D	DIF	⚡
DN.427	40cm	25cm	20cm		1xE-27 FLC 11w
DN.428	80cm	40cm	28cm		1xE-27 FLC 25w
DN.429	170cm	40cm	28cm		1xE-27 FLC 25w

104.BERTA

Modelo de cuerpo cónico cromado y pantalla de poliéster imitación cromo.

Floor lamp with chromed conical body and imitation chrome polyester lampshade.

Modell mit kegelförmigem, verchromtem Körper, Schirm aus Polyester Chromimitation.

Modèle à corps conique chromé, abat-jour polyester imitation chrome.

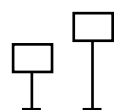

Colgante de cuerpo cónico cromado y pantalla de poliéster imitación cromo.

Pendant light with chromed conical body and imitation chrome polyester lampshade.

Deckenleuchte mit kegelförmigem, verchromtem Körper, Schirm aus Polyester-Chromimitation.

Lustre à corps conique chromé, abat-jour polyester imitation chrome.



design Eloy Puig
year 2009





MODULO
ELECTRO
www.modulelectro.ru

106.



BE.484

 **MODUL** 
ELECTRO
www.modulelectro.ru

.107



BE.483

BE.482



BE.497



MODUL
ELECTRO
www.modulelectro.ru

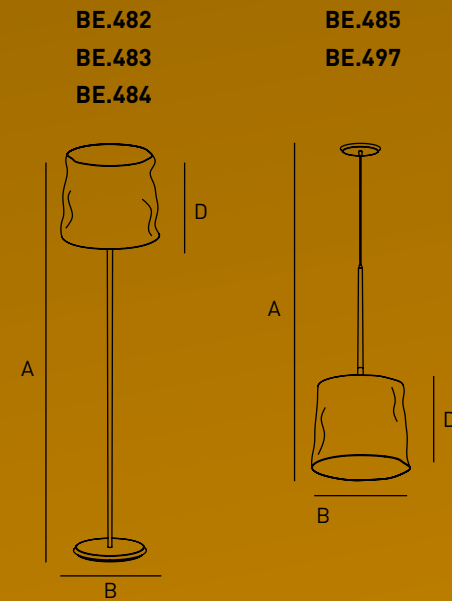

	A	BØ	D	DIF	☛
BE.482	41cm	20cm	20cm		1xE-27 FLC 11w
BE.483	80cm	40cm	35cm		1xE-27 FLC 25w
BE.484	170cm	40cm	35cm		1xE-27 FLC 25w
BE.485	130cm	40cm	35cm		1xE-27 FLC 25w
BE.497	130cm	20cm	20cm		1xE-27 FLC 21w



Poliéster imitación cromo.
Imitation chrome polyester.
Polyester Chromimitation
Polyester imitation chrome.

110.ISSABEL

Modelo acabado en cobre brillo, pantalla exterior de algodón negro e interior de poliéster cobre.

Floor lamp with shiny copper finish, black cotton outer lampshade and copper polyester interior lampshade.

Modell mit glänzendem Kupferfinish, Schirm außen schwarze Baumwolle, innen kupfernes Polyester.

Modèle à finition en cuivre brillant, abat-jour extérieur coton noir, intérieur polyester cuivre.

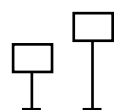

Colgante acabado en cobre brillo, pantalla exterior de algodón negro e interior de poliéster cobre.

Pendant light with shiny copper finish, black cotton outer lampshade and copper polyester interior lampshade.

Deckenleuchte mit glänzendem Kupferfinish, Schirm außen schwarze Baumwolle, innen kupfernes Polyester.

Lustre à finition en cuivre brillant, abat-jour extérieur coton noir, intérieur polyester cuivre.



design Eloy Puig
year 2009



 **MODULO**
ELECTRO
www.modulelectro.ru

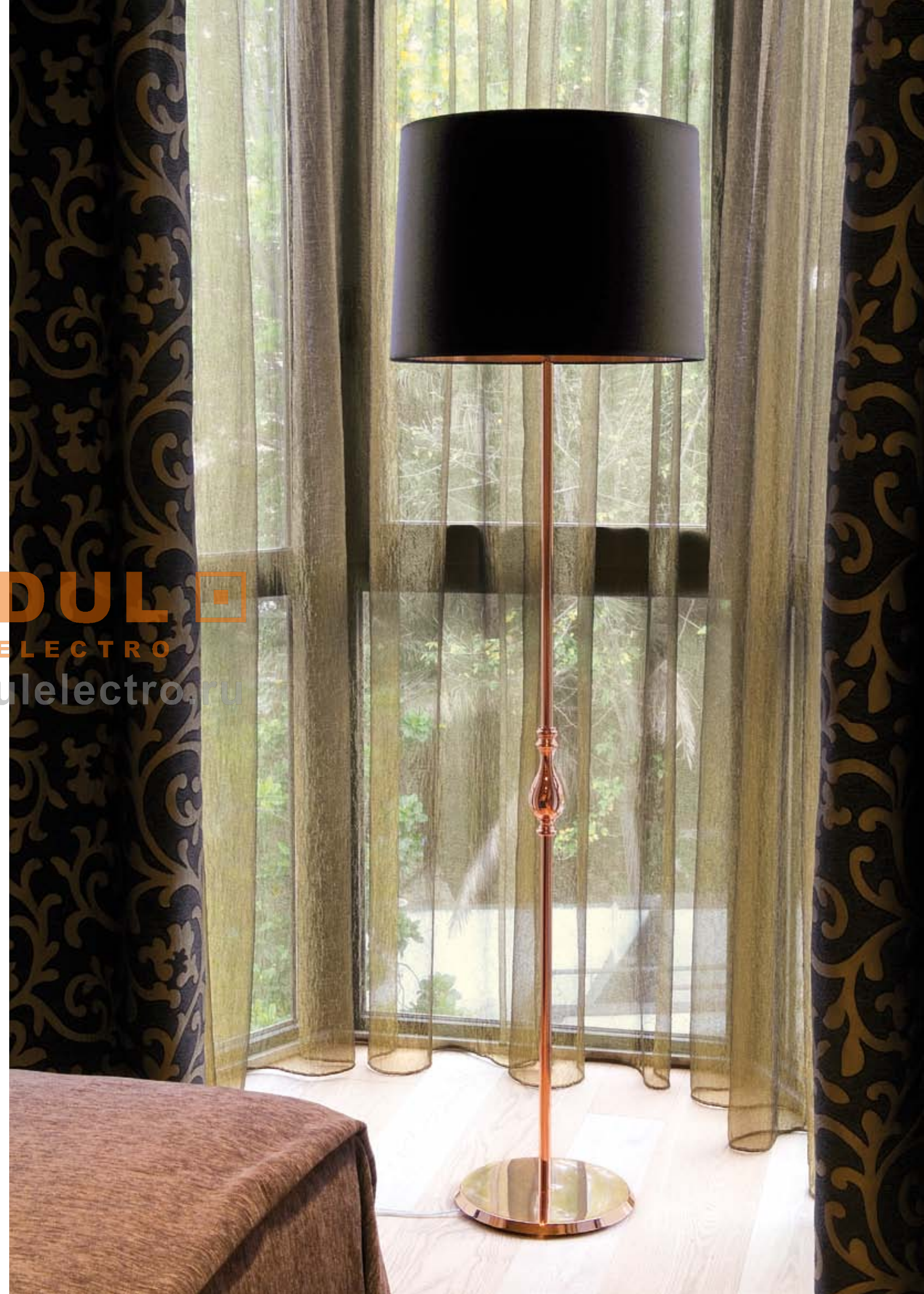



112.



IS.496

IS.495

 **MODUL** 
ELECTRO
www.modulelectro.ru

.113





IS.497

MODUL
ELECTRO
www.modulelectro.ru

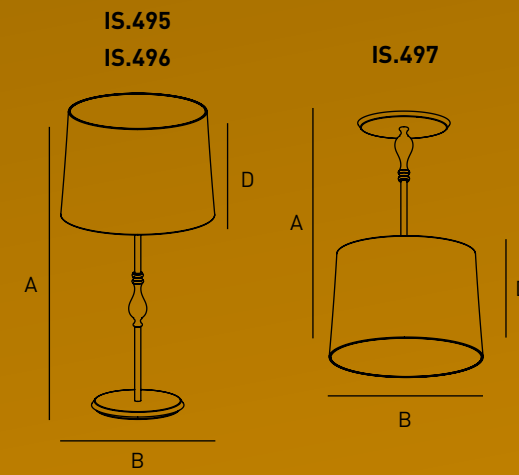

	A	BØ	D	DIF	
IS.495	100cm	50cm	33cm		1xE-27 FLC 25w
IS.496	165cm	50cm	33cm		1xE-27 FLC 25w
IS.497	80cm	50cm	33cm		1xE-27 FLC 25w



116.SAND

Modelo con base niquelada y pantalla de organza bordada.

Floor lamp with nickel plated base and embroidered organdie lampshade.

Modell mit vernickelter Basis, Schirm bestickter Organza.

Modèle à base nickelée, abat-jour organza brodé.

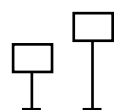

SA.462

Colgante niquelado y pantalla de organza bordada.

Nickel pendant lamp with embroidered organdie lampshade.

Deckenleuchte vernickelt, Schirm bestickter Organza.

Lustre nickelé, abat-jour organza brodé.



design Eloy Puig
year 2009



MODUL
ELECTRO
www.modulelectro.ru



SA.463

SA.461

SA.460

MODUL
ELECTRO
www.modulelectro.ru

SA.460
SA.461
SA.462

SA.463

	A	BØ	D	DIF	☑
SA.460	40cm	20cm	20cm		1xE-27 FLC 15w
SA.461	80cm	40cm	40cm		1xE-27 FLC 25w
SA.462	170cm	40cm	40cm		1xE-27 FLC 25w
SA.463	130cm	40cm	40cm		1xE-27 FLC 25w

120 LIA

Modelo con base cromada y flexo textil metalizado. Pantalla disponible en cualquier material.

Floor lamp with chromed base and metallic-fabric cable. Lampshade available in any material.

Modell, verchromte Basis und Schlauch aus mit Metallschicht versehenem Stoff, Schirm in allen Materialien verfügbar.

Modèle à base chromée et tige textile métallisée, abat-jour disponible dans n'importe quel matériel.

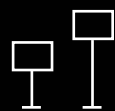

LA.435

LA.498

Colgante y aplique cromado y flexo textil metalizado. Pantalla disponible en cualquier material.

Chrome pendant light and wall lamp, metallic-fabric cable, lampshade available in any material.

Deckenleuchte und Wandlampe verchromt und Schlauch aus mit Metallschicht versehenem Stoff, Schirm in allen Materialien verfügbar.

Lustre et applique chromés et tige textile métallisée, abat-jour disponible dans n'importe quel matériel.



design Eloy Puig
year 2007



MODULO
ELECTRO
www.modulelectro.ru





LA.066





LA.068



LA.067



 **MODULO** 
ELECTRO
www.modulelectro.ru



LA.107



LA.109



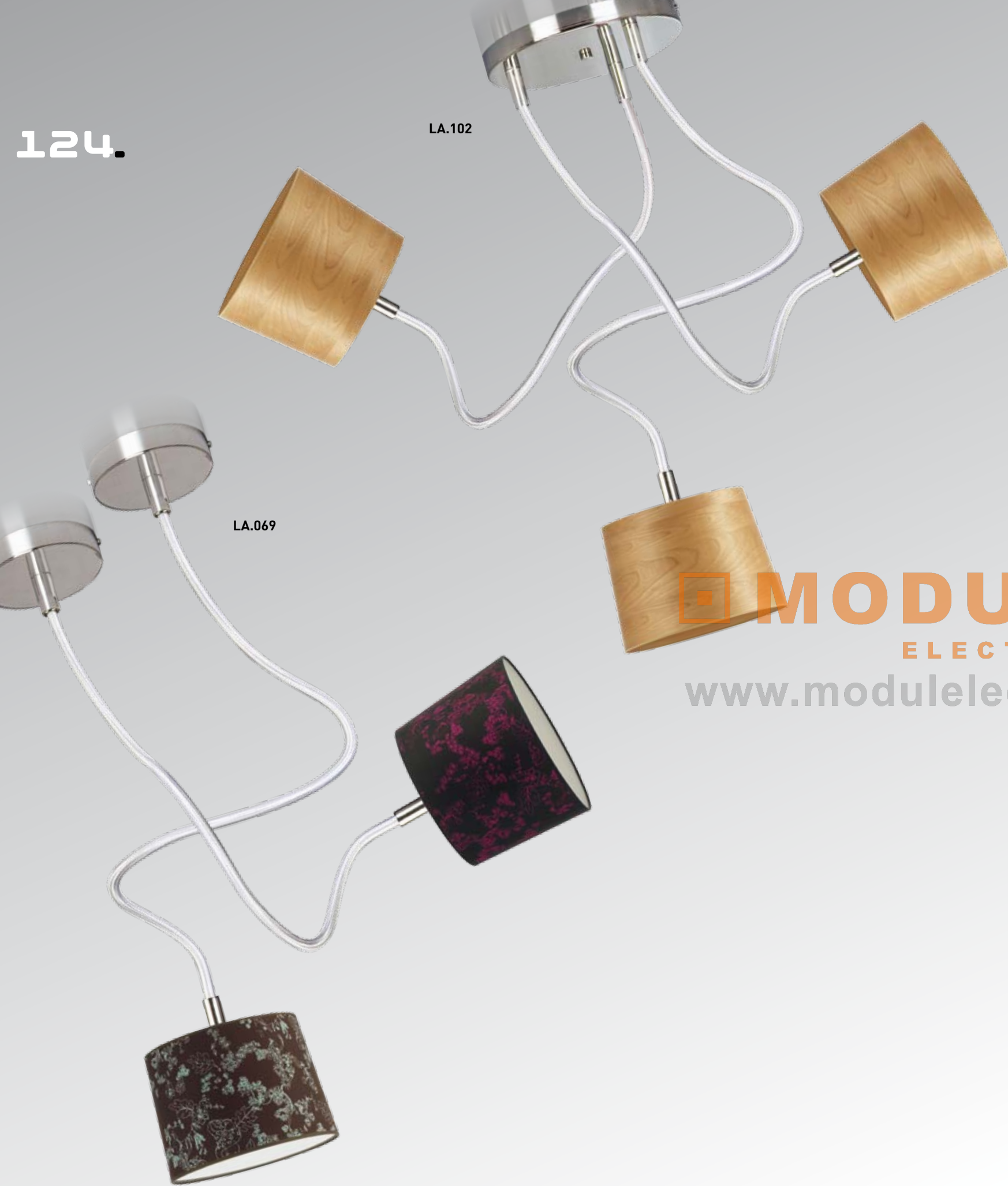

LA.102

LA.069

LA.102

MODULO
ELECTRO
www.modulelectro.ru

	A	BØ	D	DIF	⚡
LA.435	159cm	25cm	20cm		1xE-27 FLC 21w
LA.498	80cm	25cm	20cm		1xE-27 FLC 25w
LA.105	40cm	18cm	15cm		1xE-27 FLC 21w
LA.106	40cm	18cm	15cm		1xE-27 FLC 21w
LA.107	40cm	18cm	15cm		1xE-27 FLC 21w
LA.108	40cm	2x18cm	15cm		2xE-27 FLC 21w
LA.109	40cm	2x18cm	15cm		2xE-27 FLC 21w
LA.110	40cm	2x18cm	15cm		2xE-27 FLC 21w
LA.066	100cm	18cm	15cm		1xE-27 FLC 21w
LA.067	100cm	18cm	15cm		1xE-27 FLC 21w
LA.068	100cm	18cm	15cm		1xE-27 FLC 21w
LA.069	100cm	18cm	15cm		1xE-27 FLC 21w
LA.070	100cm	18cm	15cm		1xE-27 FLC 21w
LA.071	100cm	18cm	15cm		1xE-27 FLC 21w
LA.102	100cm	3x18cm	15cm		3xE-27 FLC 21w
LA.103	100cm	3x18cm	15cm		3xE-27 FLC 21w
LA.104	100cm	3x18cm	15cm		3xE-27 FLC 21w

126.ANKARA

Modelo con base niquelada y pantalla disponible en cualquier material.

Floor lamp with nickel plated base, lampshade available in any material.

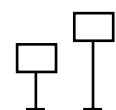

Modell, vernickelte Basis, Schirm in allen Materialien verfügbar.

Modèle à base nickelée, abat-jour disponible dans n'importe quel matériel.



AK.502



 **MODUL** 
ELECTRO
www.modulelectro.ru



Colgante y aplique niquelado y pantalla disponible en cualquier material.

Nickel plated pendant light and wall lamp, lampshade available in any material.

Deckenleuchte und Wandlampe vernickelt, Schirm in allen Materialien verfügbar.

Lustre et applique nickelés, abat-jour disponible dans n'importe quel matériel.

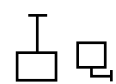

design Eloy Puig
year 2009





AK.503

MODUL
ELECTRO

www.modulelectro.ru



AK.501



AK.500





AK.504

MODUL
ELECTRO
www.modulelectro.ru

AK.500
AK.501
AK.502

AK.504

AK.503

	A	B	C	D	DIF	⚡
AK.500	38cm	18cm	18cm	18cm		1xE-27 LFC 11w
AK.501	75cm	30cm	30cm	30cm		1xE-27 LFC 25w
AK.502	165cm	30cm	30cm	30cm		1xE-27 LFC 25w
AK.503	32cm	18cm	18cm	23cm		1xE-27 LFC 25w
AK.504	130cm	30cm	30cm	30cm		1xE-27 LFC 25w

132.NATUR

Modelo de pie y mesa con cuerpo niquelado u oro y pantalla disponible en cualquier material.

Floor and table lamp with nickel plated or gold body, lampshade available in any material.

Steh- und Tischmodell mit vernickeltem oder vergoldetem Körper, Schirm in allen Materialien verfügbar.

Modèle sur pied et de table à corps nickelé ou or, abat-jour disponible dans n'importe quel matériel.

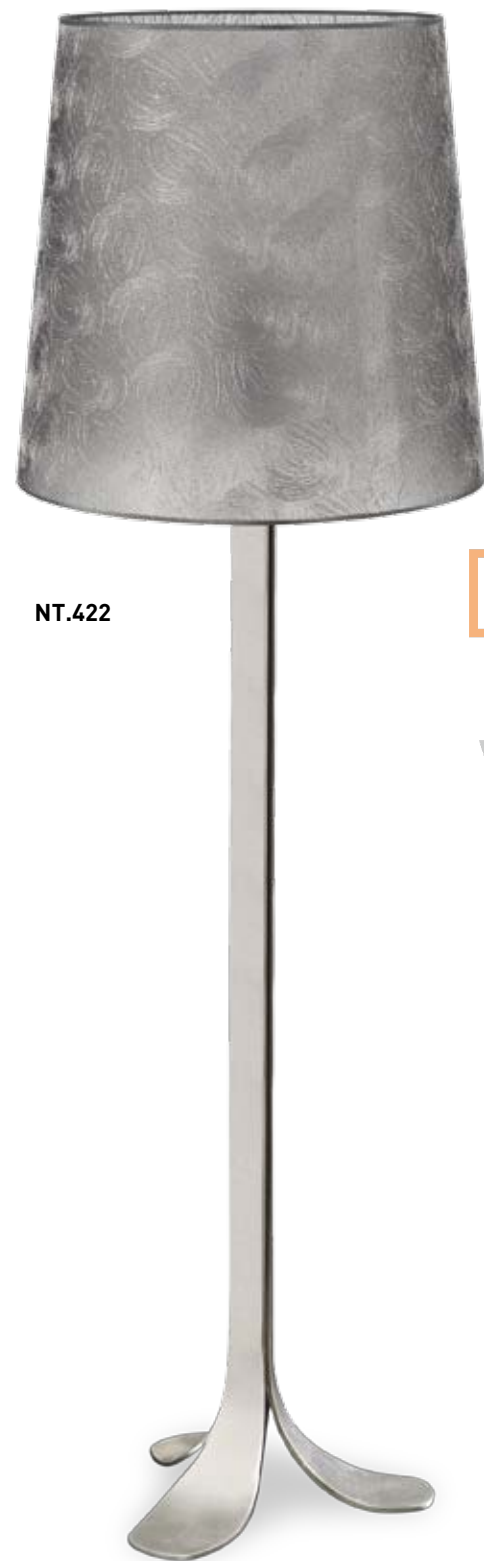

NT.422

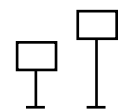

design Eloy Puig
year 2007

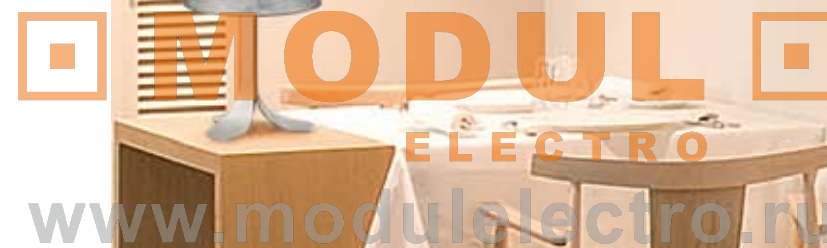

 www.modulelectro.ru





MODUL
ELECTRO
www.modulelectro.ru

	A	BØ	D	DIF	☑
NT.089	50cm	20cm	20cm		1xE-27 21w
NT.090	50cm	20cm	20cm		1xE-27 21w
NT.422	170cm	50cm	50cm		1xE-27 45w

136.MALAKA

Modelo de madera tallada a mano y acabado de haya o wengué. Pantalla de chapa de madera natural de haya o wengué.

Hand-crafted wooden floor lamp with beech or wengue finish. Natural beech or wengue veneer screen.

Modell aus handgeschnitztem Holz, Finish Buche oder Wenge. Schirm Naturholz furnier Buche oder Wenge.

Modèle en bois taillé à la main, finition hêtre ou wengé. Abat-jour plaqué bois naturel hêtre ou wengé.



MODUL
ELECTRO
www.modulelectro.ru



design Enric Miralbell
year 2007





MK.080

MK.079

MODUL
ELECTRO
www.modulelectro.ru

 This section provides detailed information for the lamp MK.079. It includes a technical drawing with dimensions A (height), B (base width), and D (shade diameter). A close-up photograph shows the dark, glossy, sculptural base. A lifestyle photograph shows the lamp on a dark coffee table in front of a beige sofa.

	A	BØ	D	DIF	⚡
MK.079	63cm	28cm	23cm		1xE-27 21w
MK.080	63cm	28cm	23cm		1xE-27 21w



140.SUITE

Modelo de mesa con cuerpo de cristal soplado. Pantalla disponible en cualquier material.

Table lamp with blown-glass body. Lampshade available in any material.

Tischmodell, Körper aus geblasenem Glas. Schirm in jedem Material erhältlich.

Modèle de table, corps verre soufflé. Abat-jour disponible dans n'importe quel matériel.



Colgante niquelado y pantalla disponible en cualquier material.

Nickel plated pendant light, lampshade available in any material.

Deckenleuchte vernickelt, Schirm in allen Materialien verfügbar.

Lustre nickelé, abat-jour disponible dans n'importe quel matériel.



design Eloy Puig
year 2006



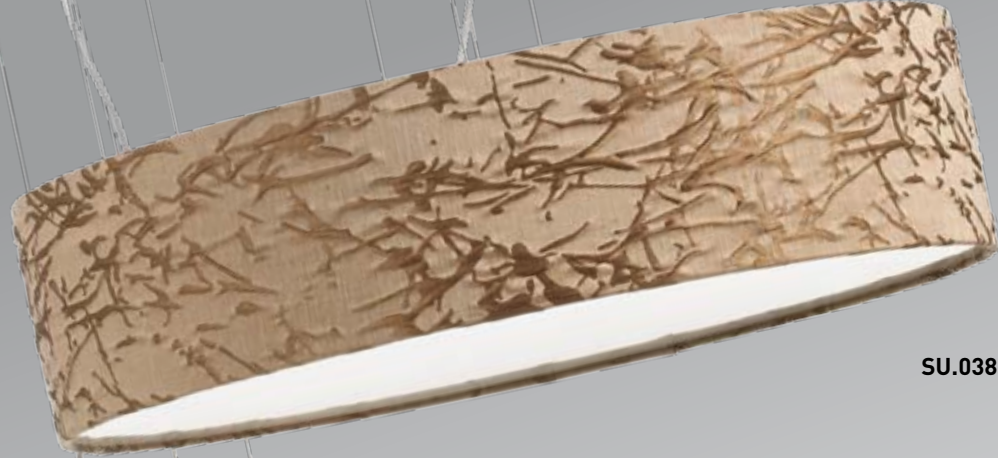
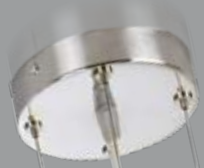

MODULO
ELECTRO
www.modulelectro.ru



SU.038



SU.037

 **MODUL** 
ELECTRO
www.modulelectro.ru



SU.039



SU.036



SU.035



MODUL ELECTRO
www.modulelectro.ru

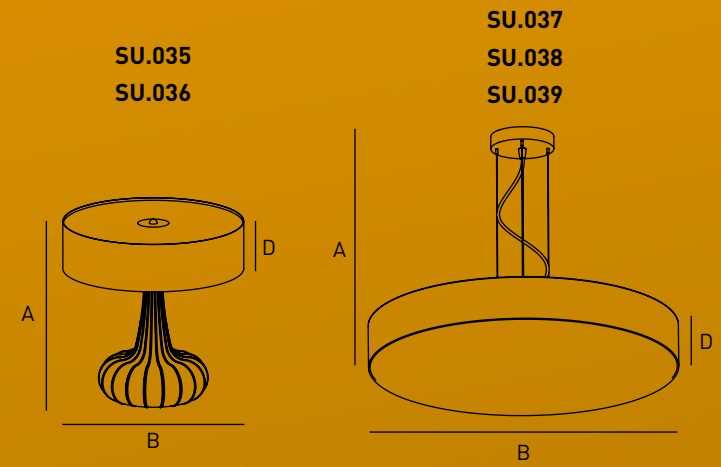

	A	BØ	D	DIF	⚡
SU.035	40cm	35cm	17cm	•	2xE-27 11w
SU.036	70cm	50cm	17cm	•	3xE-27 21w
SU.037	130cm	45cm	17cm	•	3xE-27 21w
SU.038	130cm	60cm	17cm	•	3xE-27 21w
SU.039	130cm	80cm	17cm	•	6xE-27 21w



146.AQUA

Modelo con base de cristal
fusión y cuerpo cromado.
Pantalla disponible en
cualquier material.

Floor lamp with crystal
fusion base and chromed
body, lampshade available in
any material.

Modell, Basis aus Glasfusion
und verchromtem Körper,
Schirm in allen Materialien
verfügbar.

Modèle à base en verre fusion
et corps chromé, abat-jour
disponible dans n'importe
quel matériel.

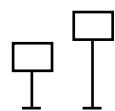

Aplique con base de cristal
fusión y cuerpo cromado.
Pantalla disponible en
cualquier material.

Wall lamp with crystal
fusion base and chromed
body, lampshade available
in any material.

Wandlampe, Basis aus
Glasfusion und verchromtem
Körper, Schirm in allen
Materialien verfügbar



Applique à base en verre
fusion et corps chromé, abat-
jour disponible dans n'importe
quel matériel.

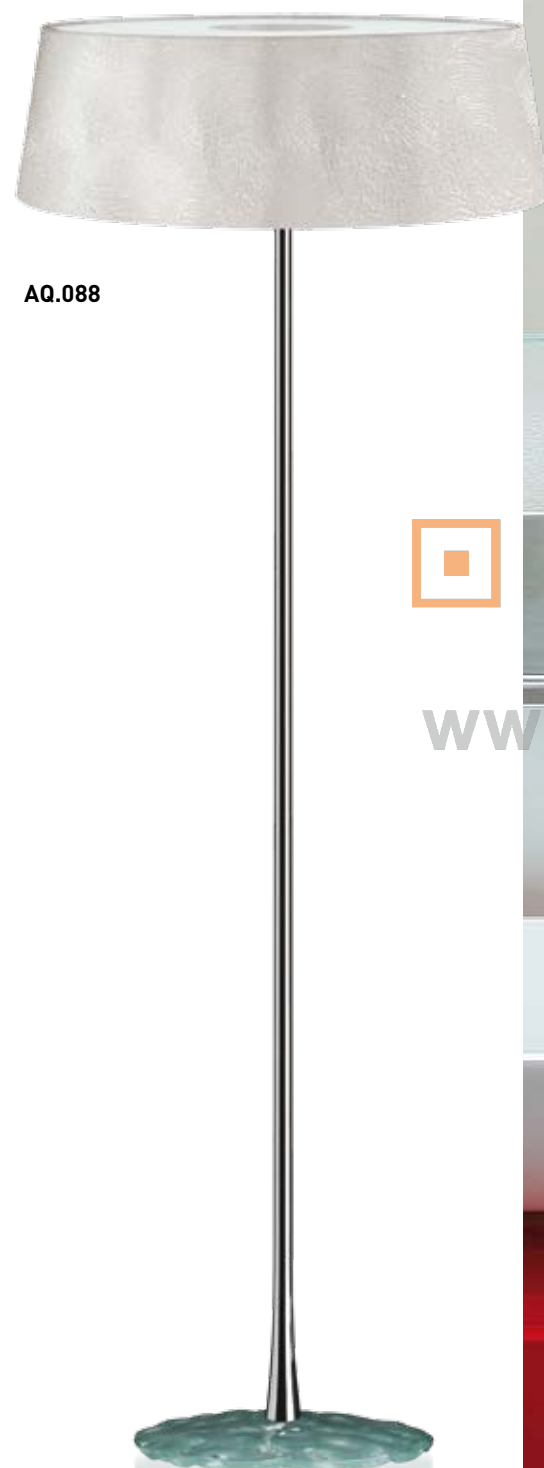

design Eloy Puig
year 2006



AQ.088

 **MODULO** 
ELECTRO
www.modulelectro.ru





AQ.486



AQ.087



AQ.086

MODUL
ELECTRO
www.modulelectro.ru



	A	BØ	C	D	DIF	⚡
AQ.086	45cm	25cm	-	15cm	•	1xE-27 11w
AQ.087	75cm	35cm	-	18cm	•	1xE-27 25w
AQ.088	165cm	50cm	-	18cm	•	1xE-27 25w
AQ.486	32cm	25cm	32cm	15cm	•	1xE-27 11w

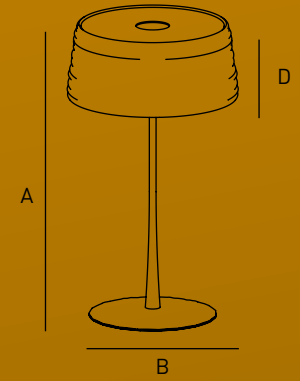

AQ.086
AQ.087
AQ.088

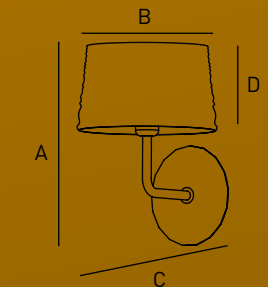

AQ.486

150.QUEEN

Modelo de pie con base cromada y cuerpo de cristal negro.
Pantalla de organza tornasolada y damasco.

Floor lamp with chromed base and black crystal body.
Iridescent organzie and damask lampshade.

Stehmodell, verchromte Basis und Körper aus schwarzem Glas.
Schirm aus changierendem Organza und Damast.

Modèle sur pied, base chromée et corps verre noir.
Abat-jour organza chatoyant et damas.

QU.092

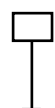

Colgante cromado.
Pantalla de organza tornasolada y damasco.

Chromed pendant light.
Iridescent organzie and damask lampshade.

Deckenleuchte verchromt.
Schirm aus changierendem Organza und Damast.

Lustre chromé.
Abat-jour organza chatoyant et damas.



design Eloy Puig
year 2007



MODULO
ELECTRO
www.modulelectro.ru





QU.093

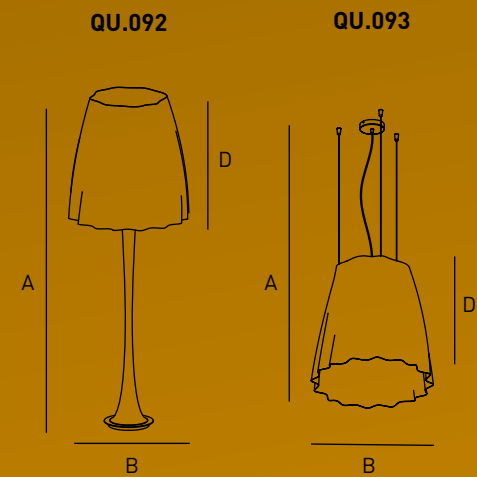

	A	BØ	D	DIF	☛
QU.092	160cm	50cm	60cm		1xE-27 25w
QU.093	130cm	50cm	60cm		3xE-27 21w

MODUL
ELECTRO
www.modulelectro.ru

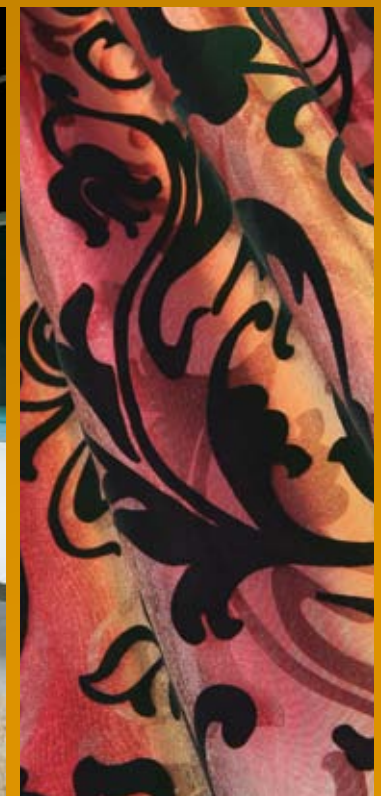

154 NEO

Modelo de pie y mesa
niquelado.
Pantalla disponible en
cualquier material.

Nickel plated floor
and wall lamp.
Lampshade available
in any material.

Steh- und Tischmodell
vernickelt.
Schirm in jedem
Material erhältlich.

Modèle sur pied et de
table nickelé.
Abat-jour disponible dans
n'importe quel matériel.



NE.507

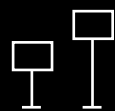

Colgante y aplique niquelado.
Pantalla disponible en
cualquier material.

Nickel plated pendant
light and wall lamp.
Lampshade available
in any material.

Hänge- und Wandlampe
vernickelt.
Schirm in jedem
Material erhältlich.

Lustre et applique nickelés.
Abat-jour disponible dans
n'importe quel matériel.



design Equipo ElTorrent
year 2009





MODUL
ELECTRO
www.modulelectro.ru





NE.508

 **MODUL**  NE.506
ELECTRO
www.modulelectro.ru

NE.505





NE.509

MODUL
ELECTRO
www.modulelectro.ru

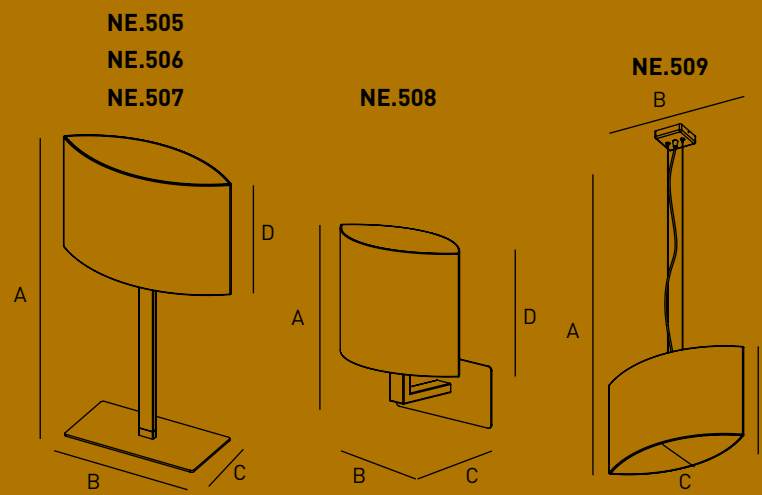

	A	B	C	D	DIF	⚡
NE.505	41cm	25cm	12cm	20cm		1xE-27 FLC 11w
NE.506	75cm	45cm	17cm	30cm		1xE-27 FLC 25w
NE.507	165cm	45cm	17cm	30cm		1xE-27 FLC 25w
NE.508	38cm	25cm	15cm	20cm		1xE-27 FLC 11w
NE.509	130cm	45cm	17cm	30cm		1xE-27 FLC 25w



160.LYZZA

Modelo de mesa con
cuerpo de cristal soplado.
Pantalla de algodón
y plumas naturales.

Table lamp with
blown-glass body.
Cotton lampshade with
real feathers.



Tischmodell, Körper aus
geblasenem Glas.
schirm Baumwolle und
natürliche Federn.

Modèle de table, corps
verre soufflé.
Abat-jour coton et
plumes naturelles.



design Eloy Puig
year 2006



 **MODUL** 
ELECTRO
www.modulelectro.ru





LY.063

MODUL
ELECTRO
www.modulelectro.ru

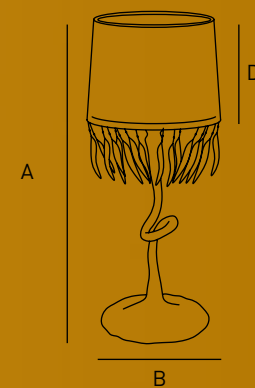

	A	BØ	D	DIF	⚡
LY.063	50cm	20cm	13cm	•	1x40w G9
LY.064	50cm	20cm	13cm	•	1x40w G9





164.HALL

Modelo de mesa con cuerpo de cristal soplado. Pantalla disponible en cualquier material.

Table lamp with blown-glass body. Lampshade available in any material.

Tischmodell, Körper aus geblasenem Glas. Schirm in jedem Material erhältlich.

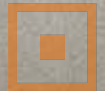
Modèle de table, corps verre soufflé. Abat-jour disponible dans n'importe quel matériel.

 **MODUL** 
ELECTRO
www.modulelectro.ru



design Eloy Puig
year 2007



166.



HL.116

HL.115

MODULO
ELECTRO

www.modulelectro.ru

.167

	A	BØ	D	DIF	☑
HL.115	55cm	25cm	20cm		1xE-27 11w
HL.116	90cm	40cm	35cm		1xE-27 21w

168.DOUCE

Modelo de pie y mesa con cuerpo cromado y de grafito negro. Pantalla disponible en cualquier material.

Floor and table lamp with chromed and black graphite body, lampshade available in any material.

Steh- und Tischmodell, Körper verchromt und mit schwarzem Grafit, Schirm in allen Materialien verfügbar.

Modèle sur pied et de table à corps chromé et graphite noir, abat-jour disponible dans n'importe quel matériel.

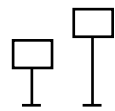

DC.030

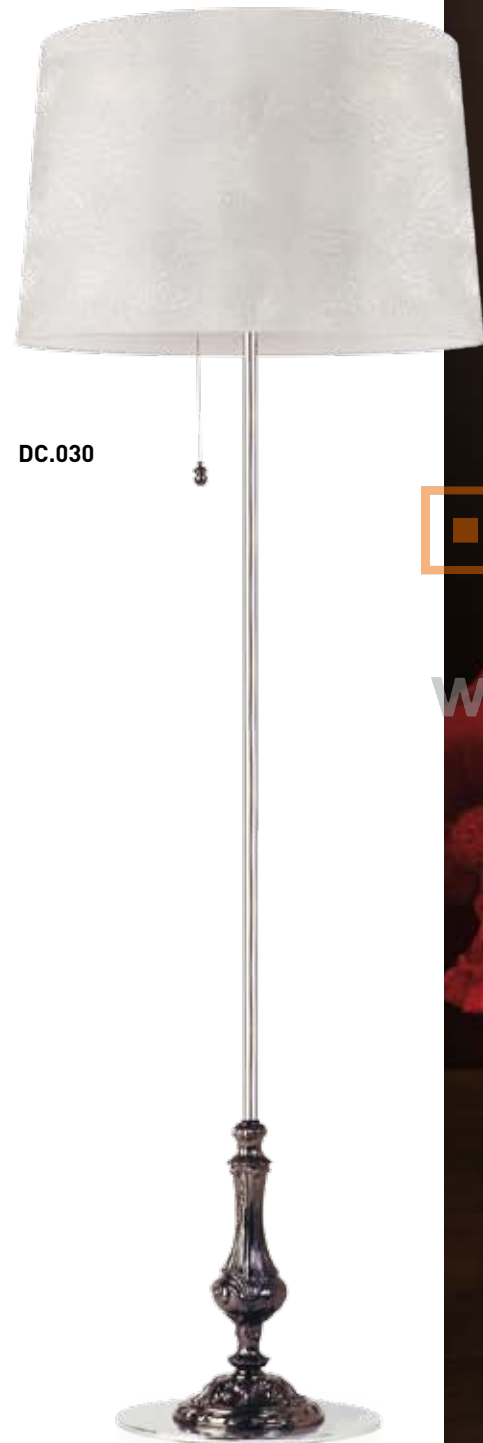

Colgante y aplique cromado y de grafito negro. Pantalla disponible en cualquier material.

Chromed and black graphite pendant light and wall lamp, lampshade available in any material.

Hänge- und Wandlampe verchromt und mit schwarzem Grafit, Schirm in allen Materialien verfügbar.

Lustre et applique chromés et graphite noir, abat-jour disponible dans n'importe quel matériel.

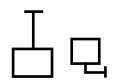

design Eloy Puig
year 2006



MODUL
ELECTRO
www.modulelectro.ru



www.modulelectro.ru



DC.031

DC.065

DC.029



DC.028



DC.033



DC.032

MODUL
ELECTRO
www.modulelectro.com

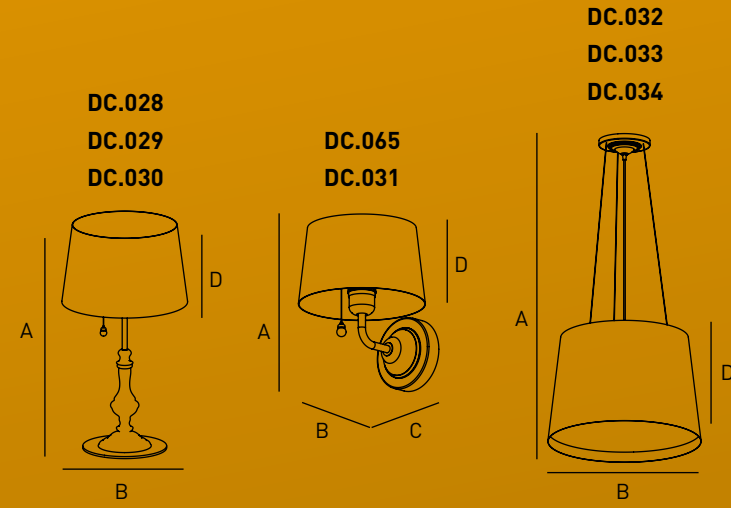

	A	BØ	C	D	DIF	⊕
DC.028	55cm	30cm		20cm		1xE-27 FCL 11w
DC.029	78cm	40cm		27cm		1xE-27 FCL 21w
DC.030	175cm	50cm		34cm		1xE-27 FCL 21w
DC.065	25cm	18cm	21cm	21cm		1xE-27 FCL 11w
DC.031	35cm	30cm	32cm	32cm		1xE-27 FCL 11w
DC.032	130cm	40cm		20cm	•	1xE-27 FCL 21w
DC.033	130cm	50cm		27cm	•	3xE-27 FCL 11w
DC.034	130cm	60cm		34cm	•	3xE-27 FCL 11w
DC.409	130cm	80cm		40cm	•	3xE-27 FCL 11w



174.DAYA

Colgante niquelado con pantalla disponible en cualquier material.

Nickel plated pendant light, lampshade available in any material.

Deckenleuchte vernickelt, Schirm in allen Materialien verfügbar.

Lustre nickelé, abat-jour disponible dans n'importe quel matériel.



Soporte niquelado y pantalla disponible en cualquier material.

Nickel plated support, lampshade available in any material.

Halterung vernickelt, Schirm in allen Materialien verfügbar.

Support nickelé, abat-jour disponible dans n'importe quel matériel.



design Eloy Puig
year 2005





MODUL
ELECTRO
www.modulelectro.ru

DA.050



DA.014



DA.049



DA.047

DA.045

MODUL
ELECTRO
www.modulelectro.com

DA.048
DA.049
DA.050

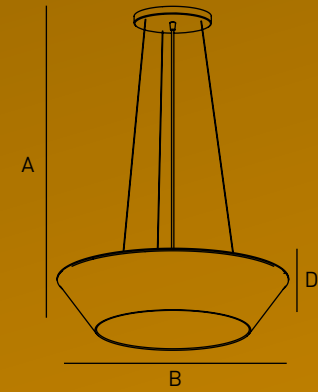

DA.019
DA.014
DA.015

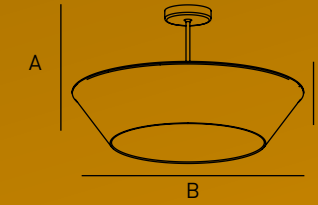

DA.045
DA.046
DA.047

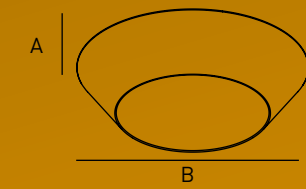

	A	BØ	D	DIF	☉
DA.048	130cm	50cm	15cm	•	2xE-27 FCL 11w
DA.049	130cm	60cm	15cm	•	3xE-27 FCL 11w
DA.050	130cm	80cm	17cm	•	6xE-27 FCL 11w
DA.019	36cm	50cm	15cm	•	2xE-27 FCL 11w
DA.014	36cm	60cm	15cm	•	3xE-27 FCL 11w
DA.015	36cm	80cm	17cm	•	6xE-27 FCL 11w
DA.045	15cm	50cm		•	2xE-27 FCL 11w
DA.046	15cm	60cm		•	3xE-27 FCL 11w
DA.047	17cm	80cm		•	6xE-27 FCL 11w



180.SYLVA

Colgante niquelado
y pantalla disponible
en cualquier material.

Nickel plated pendant
light, lampshade available
in any material.

Deckenleuchte vernickelt,
Schirm in allen Materialien
verfügbar.

Lustre nickelé, abat-jour
disponible dans n'importe
quel matériel.



MODUL
ELECTRO
www.modulelectro.ru



design Eloy Puig
year 2006





SY.010

MODUL
 ELECTRO
www.modulelectro.ru

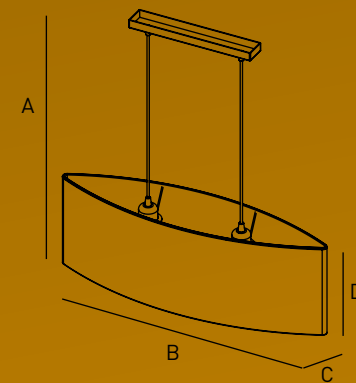

	A	B	C	D	DIF	
SY.010	130cm	65cm	17cm	22cm		2xE-27 FCL 11w
SY.011	130cm	100cm	17cm	22cm		4xE-27 FCL 11w



184.TELMA

Modelo de pie y mesa con base de madera de color wengué y cuerpo de metal gris.
Pantalla disponible en cualquier material.

Floor and table lamp with wengue-coloured wooden base and grey metal body.
Lampshade available in any material.

Steh- und Tischmodell mit Basis aus wengefarbenem Holz und Körper aus grauem Metall, Schirm in allen Materialien verfügbar.

Modèle sur pied et de table à base bois couleur wengé et corps métal gris, abat-jour disponible dans n'importe quel matériel.

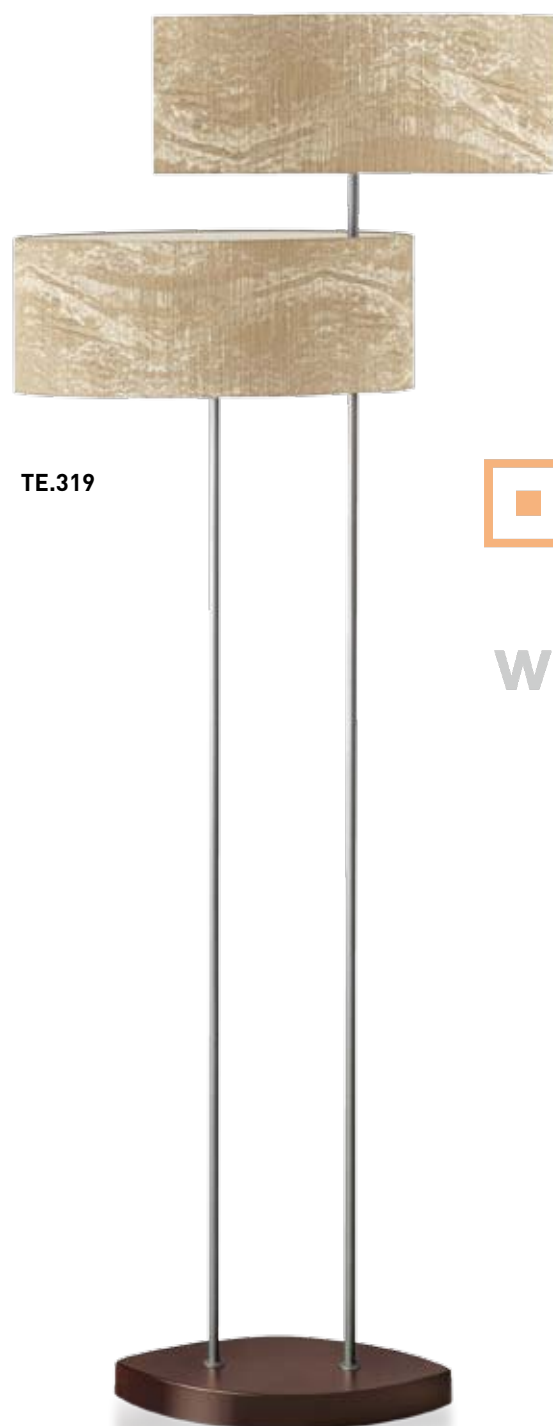

TE.319



MODUL
ELECTRO
www.modulselectro.ru

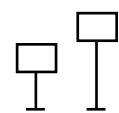

design Eloy Puig
year 2005





TE.318



TE.317

MODULO
ELECTRO

www.modulelectro.ru

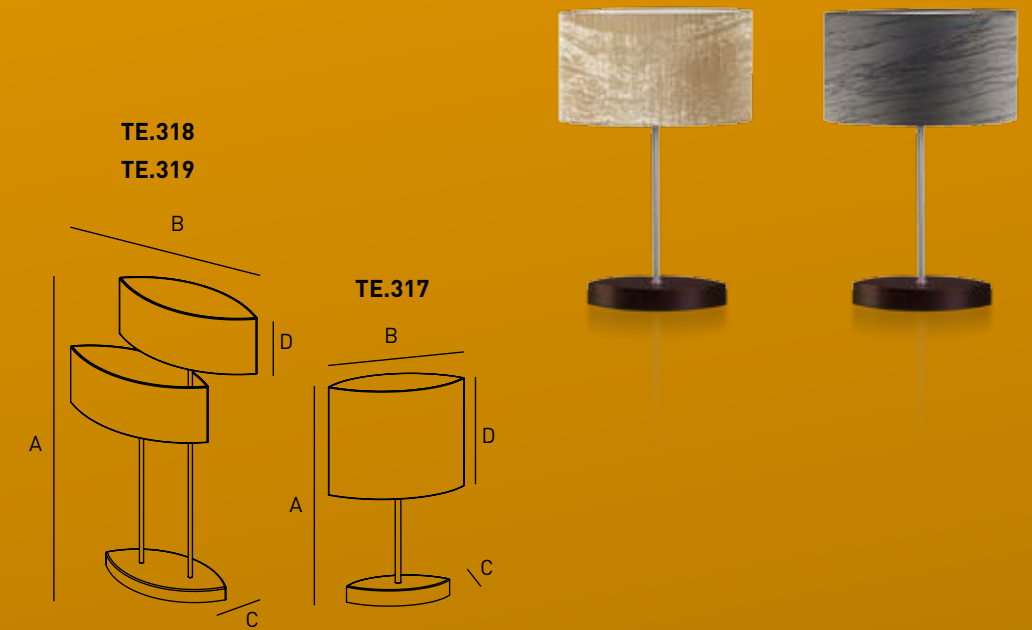

	A	B	C	D	DIF	⚡
TE.317	40cm	25cm	10cm	20cm		1xE-27 FCL 9w
TE.318	70cm	60cm	19cm	20cm		2xE-27 FCL 21w
TE.319	160cm	60cm	22cm	20cm		2xE-27 FCL 21w



188.COCO

Modelo de pie y mesa con cuerpo de madera wengué y pantalla disponible en cualquier material.

Floor lamp and table lamp in wengue, lampshade available in any material.

Steh- und Tischmodell, Körper aus Wenge-Holz, Schirm in allen Materialien verfügbar.

Modèle sur pied et de table corps en bois wengé, abat-jour disponible dans n'importe quel matériel.

MODULO
ELECTRO
www.modulelectro.ru

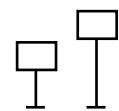

design Eloy Puig
year 2005





CO.304

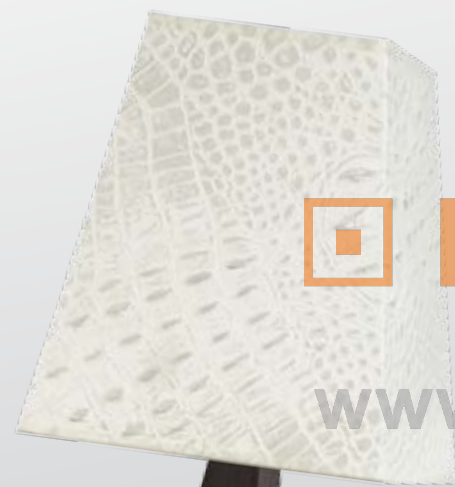



CO.323

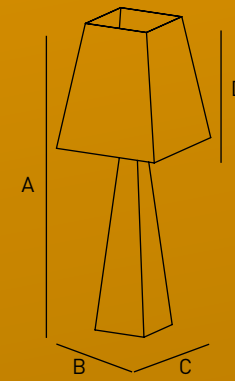

CO.303

MODUL ELECTRO
www.modulelectro.ru



	A	B	C	D	DIF	
CO.303	55cm	20cm	20cm	22cm		1xE-27 FCL 11w
CO.323	90cm	32cm	32cm	34cm		1xE-27 FCL 21w
CO.304	170cm	40cm	40cm	44cm		1xE-27 FCL 21w



192.AFRO

Modelo de mesa con cuerpo de madera wengué y pantalla disponible en cualquier material.

Table lamp with wengue body, lampshade available in any material.

Tischmodell, Körper aus Wenge-Holz, Schirm in allen Materialien verfügbar.

Modèle de table corps en bois wengé, abat-jour disponible dans n'importe quel matériel.



Colgante niquelado con cuerpo de madera wengué y pantalla disponible en cualquier material.

Nickel pendant light with wengue body, lampshade available in any material.

Deckenleuchte vernickelt, Körper aus Wenge-Holz, Schirm in allen Materialien verfügbar.

Lustre nickelé, corps en bois wengé, abat-jour disponible dans n'importe quel matériel.

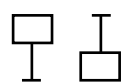

design Eloy Puig
year 2005



AF.272

AF.271

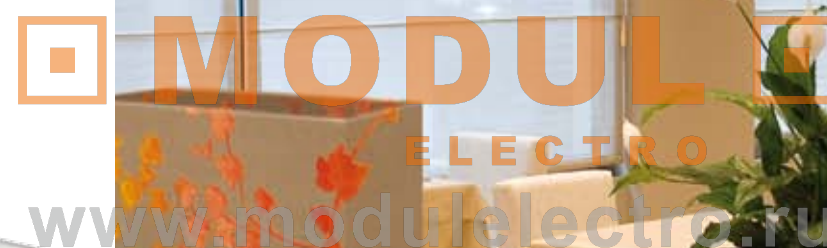
 MODULO
ELECTRO
www.modulelectro.ru





AF.417

MODUL
ELECTRO
www.modulelectro.ru



AF.417
AF.418

AF.271
AF.272

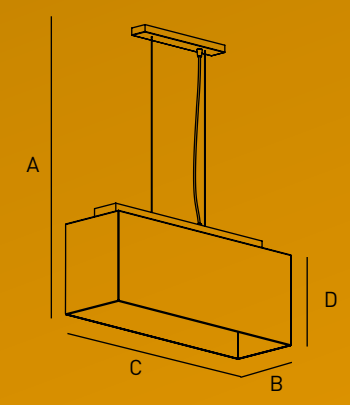
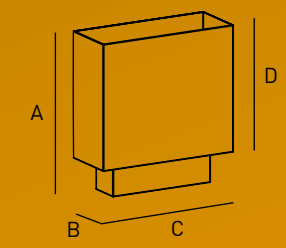

	A	B	C	D	DIF	
AF.271	24cm	12cm	20cm			1xE-27 FCL 9w
AF.272	38cm	16cm	40cm			1xE-27 FCL 21w
AF.417	130cm	20cm	65cm	25cm	•	2xE-27 FCL11w
AF.418	130cm	20cm	90cm	25cm	•	3xE-27 FCL11w

196.PISTÓ

Modelo pie y mesa con cuerpo de metal marrón óxido y pantalla disponible en cualquier material.

Floor and table lamp, rusty brown metal body, lampshade available in any material.

Steh- und Tischmodell, Körper aus braunem rostfarbenem Metall, Schirm in allen Materialien verfügbar.

Modèle pied et table, corps en métal marron oxyde, abat-jour disponible dans n'importe quel matériel.

PI.284

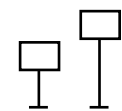

design Eloy Puig
year 2003



MODULO
ELECTRO

www.modulelectro.ru

.197





MODUL
ELECTRO
www.modulelectro.ru

Technical diagram showing dimensions A, B, and D.

	A	BØ	D	DIF	☼
PI.259	43cm	12cm	25cm		1xE-27 FLC 11w
PI.258	74cm	18cm	50cm		1xE-27 FLC 21w
PI.284	160cm	35cm	90cm		2xE-27 FLC 21w

200.OBELISK



Modelo pie y mesa con base de madera wengué y pantalla de algodón blanco.

Floor and table lamp with wengue base and white cotton lampshade.

Steh- und Tischmodell, Basis aus Wenge-Holz, Schirm aus weißer Baumwolle.

Modèle pied et table, base en bois wengé, abat-jour en coton blanc.



 **MODUL** 
ELECTRO
www.modulelectro.ru

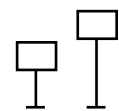

design Eloy Puig
year 2003



OB.277



OB.275



OB.276

MODUL
ELECTRO
www.modulelectro.ru

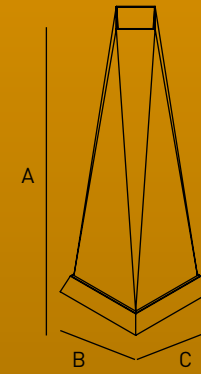

	A	B	C	DIF	
OB.275	45cm	16cm	16cm		1xE-14 FLC 11w
OB.276	70cm	21cm	21cm		1xE-27 FLC 21w
OB.277	165cm	34cm	34cm		4xE-27 FLC 21w



204.XÈNIA

Modelo pie y mesa con cuerpo cromado y pantalla disponible en cualquier material.

Floor and table lamp with chromed body, lampshade available in any material.

Steh- und Tischmodell, verchromter Körper, Schirm in allen Materialien verfügbar.

Modèle pied et table, corps chromé, abat-jour disponible dans n'importe quel matériel.



XE.321

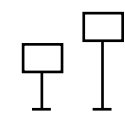

design Eloy Puig
year 2004



MODULO
ELECTRO
www.modulelectro.ru



XE.329

XE.320

MODUL
ELECTRO

www.modulelectro.ru

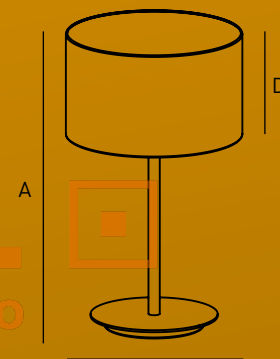

	A	BØ	D	DIF	☑
XE.320	45cm	25cm	20cm		1xE-14 FCL 11w
XE.329	75cm	35cm	25cm		1xE-27 FCL 21w
XE.321	165cm	45cm	25cm		1xE-27 FCL 21w



208.YUROK

Modelo pie y mesa con cuerpo cromado y pantalla disponible en cualquier material.

Floor and table lamp with chromed body, lampshade available in any material.

Steh- und Tischmodell, verchromter Körper, Schirm in allen Materialien verfügbar.

Modèle pied et table, corps chromé, abat-jour disponible dans n'importe quel matériel.

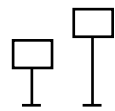

Colgante cromado y pantalla disponible en cualquier material

Chromed pendant light, lampshade available in any material.

Verchromte Deckenleuchte, Schirm in allen Materialien verfügbar.

Lustre chromé, abat-jour disponible dans n'importe quel matériel



design Eloy Puig
year 2006





MODUL
ELECTRO
www.modulelectro.ru

YU.022 / YU.023 / YU.024

YU.025 / YU.026 / YU.027

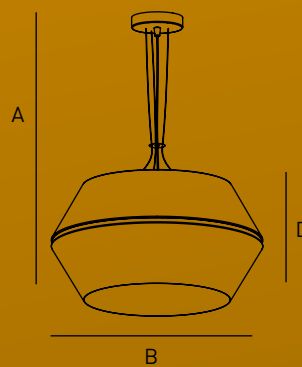
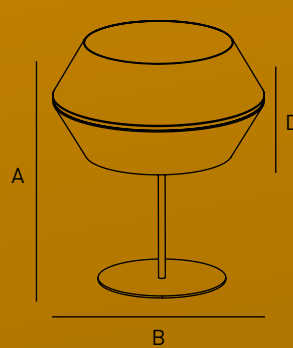

	A	BØ	D	DIF	⚡
YU.022	46cm	30cm	20cm	•	1xE-27 11w
YU.023	65cm	50cm	28cm	•	1xE-27 21w
YU.024	165cm	50cm	28cm	•	1xE-27 21w
YU.025	130cm	50cm	28cm	•	3xE-27 11w
YU.026	130cm	60cm	28cm	•	3xE-27 11w
YU.027	130cm	80cm	28cm	•	6xE-27 11w



212.SENA

Modelo mesa con cuerpo oro, níquel o marrón óxido. Pantalla disponible en cualquier material.

Table lamp with gold, nickel or rusty brown body, lampshade available in any material.

Tischlampe, Körper Gold, Nickel oder rostfarbenes Braun, Schirm in allen Materialien verfügbar.

Modèle table, corps or, nickel ou marron oxyde, abat-jour disponible dans n'importe quel matériel.



MODUL
ELECTRO
www.modulelectro.ru



design Equipo ElTorrent
year 2007



SE.098



SE.446



SE.448



MODUL ELECTRO
www.modulelectro.ru

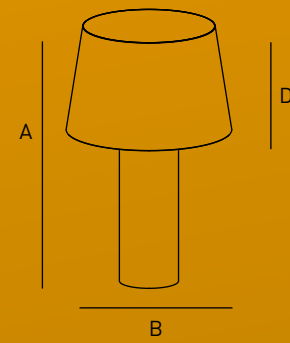

	A	BØ	D	DIF	☑
SE.446	32cm	18cm	13cm	•	1xE-27 FLC 9w
SE.447	32cm	18cm	13cm	•	1xE-27 FLC 9w
SE.448	32cm	18cm	13cm	•	1xE-27 FLC 9w
SE.449	50cm	30cm	20cm	•	1xE-27 FLC 20w
SE.450	50cm	30cm	20cm	•	1xE-27 FLC 20w
SE.451	50cm	30cm	20cm	•	1xE-27 FLC 20w



216.NAGAR

Colgante cromado
y pantalla disponible
en cualquier material.

Chromed pendant light,
lampshade available in
any material.

Deckenleuchte verchromt,
Schirm in allen Materialien
verfügbar.

Lustre chromé, abat-jour
disponible dans n'importe
quel matériel



MODUL
ELECTRO
www.modulelectro.ru



design Eloy Puig
year 2007





NG.075

NG.077

MODUL
ELECTRO
www.modulelectro.ru

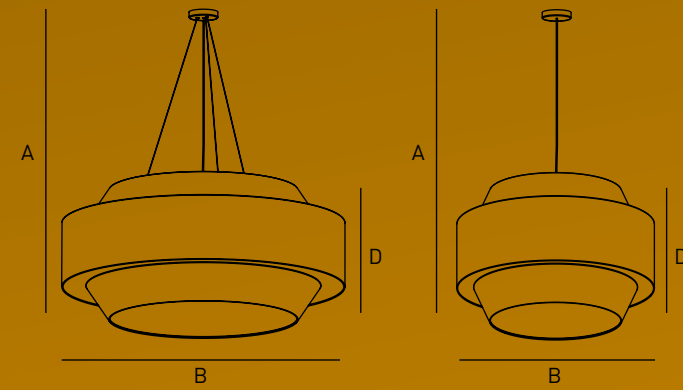

	A	BØ	D	DIF	☑
NG.075	80cm	35cm	35cm	•	1xE-27 FCL 21w
NG.076	100cm	45cm	35cm	•	3xE-27 FCL 21w
NG.077	130cm	60cm	35cm	•	3xE-27 FCL 21w
NG.410	130cm	80cm	35cm	•	3xE-27 FCL 21w
NG.411	130cm	100cm	35cm	•	6xE-27 FCL 21w



220.AYDA

Colgante cromado
y pantalla disponible
en cualquier material.

Chromed pendant light,
lampshade available in
any material.

Verchromte Deckenleuchte,
Schirm in allen Materialien
verfügbar.

Lustre chromé, abat-jour
disponible dans n'importe
quel matériel.



MODUL
ELECTRO
www.modul-electro.ru



design Eloy Puig
year 2007





AY.040



AY.042

MODUL
ELECTRO
www.modulelectro.ru

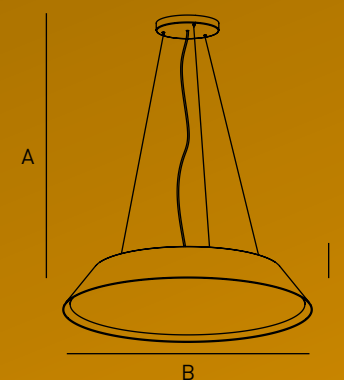

	A	BØ	D	DIF	☉
AY.040	130cm	50cm	15cm	•	2xE-27 FLC 11w
AY.041	130cm	60cm	15cm	•	3xE-27 FLC 11w
AY.042	130cm	80cm	17cm	•	6xE-27 FLC 11w



224.OVLA

Colgante cromado
y pantalla disponible
en cualquier material.

Chromed pendant light,
lampshade available in
any material.

Verchromte Deckenleuchte,
Schirm in allen Materialien
verfügbar.

Lustre chromé, abat-jour
disponible dans n'importe
quel matériel.



design Eloy Puig
year 2006





MODUL
ELECTRO
www.modulelectro.ru

	A	B	C	D	DIF	
OV.078	130cm	100cm	18cm	15cm	•	4xE-27 FLC 21w



228.ARKA

Colgante niquelado
y **pantalla oval** disponible
en cualquier material

Nickel plated pendant light,
oval lampshade available
in any colour.

Deckenleuchte vernickelt,
ovaler Schirm verfügbar
in allen Materialien.

Lustre nickelé, **abat-jour**
ovale disponible dans
n'importe quel matériel



MODUL
ELECTRO
www.modulelectro.ru



design Eloy Puig
year 2005





AR.419

MODULO
ELECTRO
www.modulelectro.ru

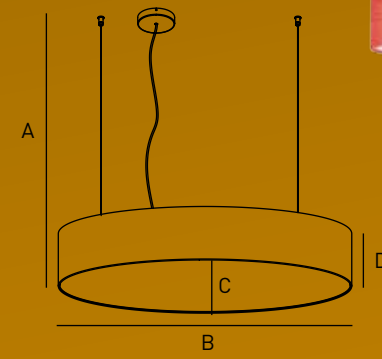

	A	B	C	D	DIF	⚙️
AR.419	130cm	65cm	36cm	20cm	•	2xE-27 FLC 21w
AR.420	130cm	95cm	36cm	20cm	•	3xE-27 FLC 21w

Pantalla oval
Oval lampshade

Ovaler Schirm
Abat-jour ovale



MODUL
ELECTRO

www.modulelectro.ru

CONTRACT

Posibilidades y opciones

Nuestro departamento de diseño y producción le puede ofrecer cualquier opción de tamaño, forma, material y color, para dar un toque personalizado a cada uno de sus proyectos.

Somos especialistas en pantallas XXL y luminarias decorativas de interior especiales para proyectos y contract.

En las siguientes páginas puede ver algunos ejemplos de tamaños y formas.

Possibilities and options.

Our design and production department can offer you any size, shape, material or colour to give a personal touch to each of your projects.

We are specialists in XXL lampshade and special decorative lamps for projects and contracts.

Please see the following pages for some examples of our sizes and shapes.

Möglichkeiten und Optionen

Unsere Design- und Produktionsabteilung kann Ihnen jede Größe, Form, Material und Farbe anbieten, um Ihren Projekten einen persönlichen Touch zu verleihen.

Wir sind spezialisiert auf XXL-Schirme und dekorative Innenlampen für Projekte und Objekt.

Auf den folgenden Seiten können Sie einige Beispiele für Größen und Formen sehen.

Possibilités et options

Notre département de design et de production peut vous offrir n'importe quelle option en taille, forme, matériel et couleur, pour donner une touche personnalisée à chacun de vos projets.

Nous sommes des spécialiste en abat-jour XXL et lampes décoratives d'intérieur spéciaux pour projets et contract.

Sur les pages suivantes, vous pouvez voir quelques exemples de tailles et formes.

234.TUBS

Modelo pie y mesa con base cromada y pantalla disponible en cualquier material.

Floor and table lamp with chromed base, lampshade available in any material.

Steh- und Tischmodell, verchromte Basis, Schirm verfügbar in allen Materialien.

Modèle pied et table, base chromée, abat-jour disponible dans n'importe quel matériel.

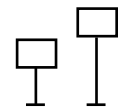

Colgante cromado y pantalla disponible en cualquier material.

Chromed pendant light, lampshade available in any material.

Verchromte Deckenleuchte, Schirm in allen Materialien verfügbar.

Lustre chromé, abat-jour disponible dans n'importe quel matériel.



TB.095



MODUL
ELECTRO
www.modulelectro.ru



236.



TB.409



TB.410

 **MODUL** 
ELECTRO
www.modulelectro.ru

.237



TB.094



MODUL
ELECTRO

www.modulelectro.ru

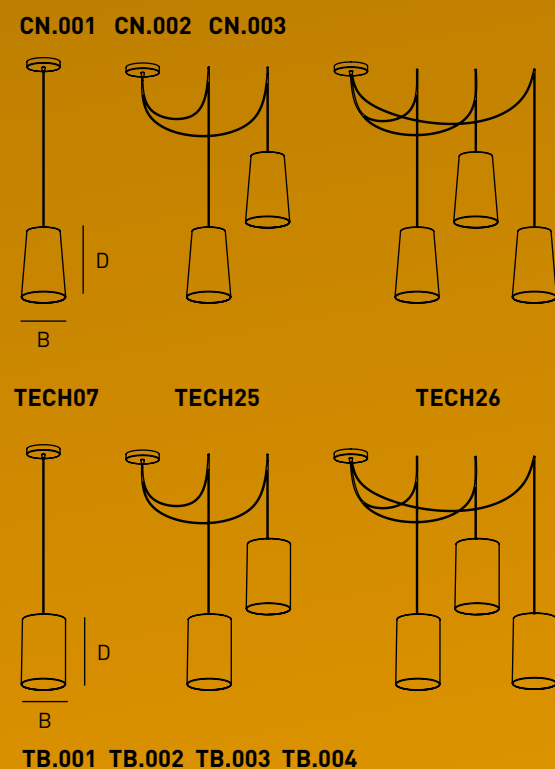
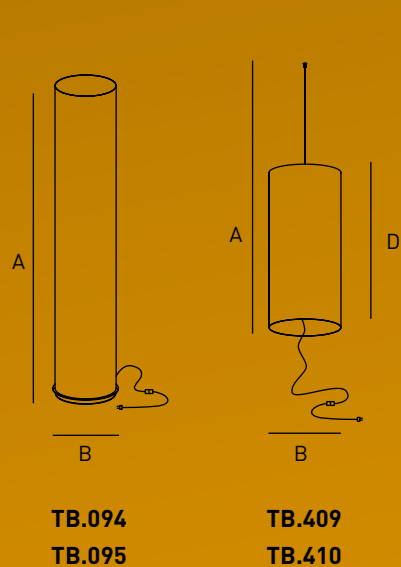

	A	BØ	D	DIF	☛
TB.094	32cm	14cm			1xE-27 FLC 11w
TB.095	150cm	28cm			6xE-27 FLC 21w
TB.409	90/190cm	35cm	70cm		2xE-27 FLC 21w
TB.410	120/220cm	45cm	110cm		4xE-27 FLC 21w

Optional con **TECH25** o **TECH26**
Optional with **TECH25** or **TECH26**

Optional mit **TECH25** oder **TECH26**
Optionnel avec **TECH25** ou **TECH26**

	A	BØ	D	DIF	☛
TB.001		12cm	25cm		1xE-27 FLC 21w
TB.002		18cm	25cm		1xE-27 FLC 21w
TB.003		20cm	30cm		1xE-27 FLC 21w
TB.004		25cm	50cm		1xE-27 FLC 21w
CN.001		20cm	31cm		1xE-27 FLC 21w
CN.002		30cm	45cm		1xE-27 FLC 21w
CN.003		40cm	60cm		1xE-27 FLC 21w



MODUL
ELECTRO
www.modulelectro.ru



242.ANDREA

Colgante cromado
y pantalla disponible
en cualquier material.

Chromed pendant light,
lampshade available in
any material.

Verchromte Deckenleuchte,
Schirm in allen Materialien
verfügbar.

Lustre chromé, abat-jour
disponible dans n'importe
quel matériel.



MODULO
ELECTRO
www.modulelectro.ru





AN.009



AN.007



MODULO
ELECTRO
www.modulelectro.ru

- AN.008
- AN.009
- AN.129
- AN.130
- AN.131

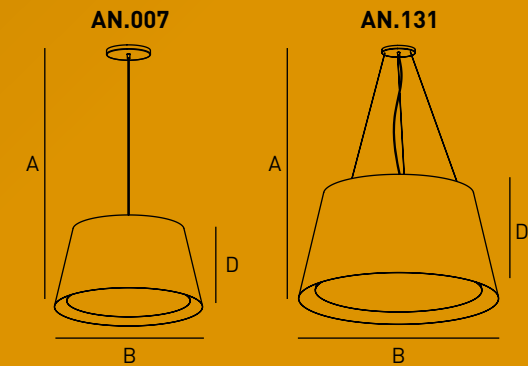

	A	BØ	D	DIF	⚡
AN.007	100cm	40cm	27cm	•	1xE-27 FLC 21w
AN.008	130cm	50cm	34cm	•	3xE-27 FLC 11w
AN.009	130cm	60cm	40cm	•	3xE-27 FLC 11w
AN.129	130cm	80cm	40cm	•	6xE-27 FLC 11w
AN.130	150cm	100cm	40cm	•	6xE-27 FLC 11w
AN.131	150cm	120cm	45cm	•	6xE-27 FLC 11w

246.KEOPS

Colgante cromado
y pantalla disponible
en cualquier material.

Chromed pendant light,
lampshade available in
any material.

Verchromte Deckenleuchte,
Schirm in allen Materialien
verfügbar.

Lustre chromé, abat-jour
disponible dans n'importe
quel matériel.





KE.113



KE.111



MODUL
ELECTRO
www.modulelectro.ru

KE.112
KE.113
KE.114

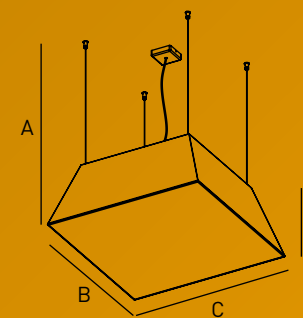

KE.514

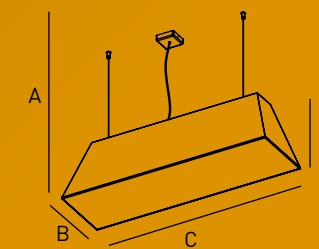

KE.111

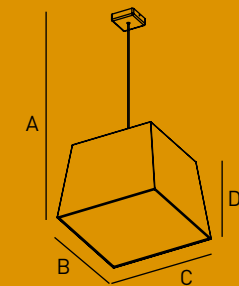

	A	B	C	D	DIF	☛
KE.111	100cm	40cm	40cm	30cm	•	1xE-27 FLC 21w
KE.112	130cm	50cm	50cm	30cm	•	3xE-27 FLC 21w
KE.113	130cm	70cm	70cm	30cm	•	4xE-27 FLC 21w
KE.114	130cm	90cm	90cm	35cm	•	4xE-27 FLC 21w
KE.514	130cm	25cm	95cm	30cm	•	4xE-27 FLC 21w

250.TRYP

Colgante cromado
y pantalla disponible
en cualquier material.

Chromed pendant light,
lampshade available in
any material.

Verchromte Deckenleuchte,
Schirm in allen Materialien
verfügbar.

Lustre chromé, abat-jour
disponible dans n'importe
quel matériel.

TR.072



MODULO
ELECTRO
www.modulelectro.ru





TR.072

MODUL
ELECTRO
www.modulelectro.ru

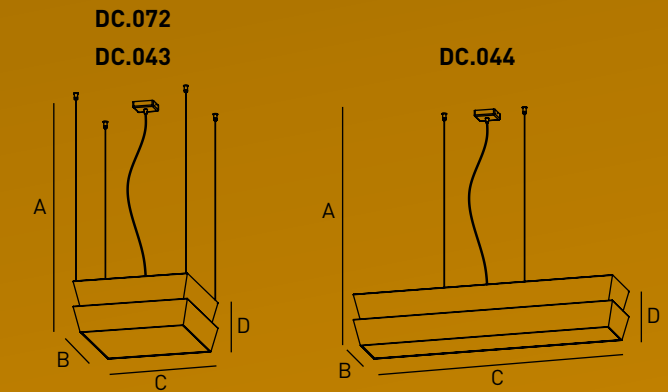
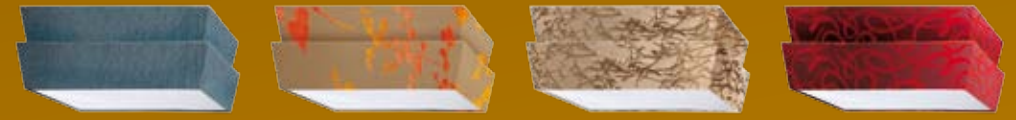

	A	B	C	D	DIF	⊕
TR.072	130cm	50cm	50cm	22cm	•	4xE-27 FLC 21w
TR.043	130cm	70cm	70cm	22cm	•	4xE-27 FLC 21w
TR.044	130cm	25cm	95cm	22cm	•	4xE-27 FLC 21w



254.SQUARES

Colgante cromado
y pantalla disponible
en cualquier material.

Chromed pendant light,
lampshade available in
any material.

Verchromte Deckenleuchte,
Schirm in allen Materialien
verfügbar.

Lustre chromé, abat-jour
disponible dans n'importe quel
matériel.



MODULO
ELECTRO
www.modulelectro.ru





MODUL
ELECTRO

www.modulelectro.ru

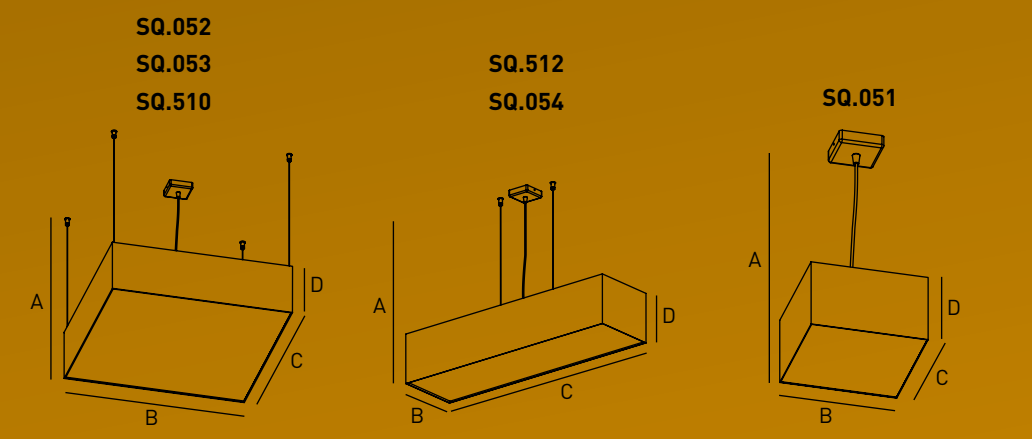

	A	B	C	D	DIF	⚙️
SQ.051	130cm	40cm	40cm	20cm	•	1xE-27 FLC 21w
SQ.052	130cm	50cm	50cm	20cm	•	4xE-27 FLC 21w
SQ.053	130cm	70cm	70cm	20cm	•	4xE-27 FLC 21w
SQ.0510	130cm	90cm	90cm	20cm	•	4xE-27 FLC 21w
SQ.0512	130cm	25cm	70cm	20cm	•	2xE-27 FLC 21w
SQ.054	130cm	25cm	95cm	20cm	•	4xE-27 FLC 21w



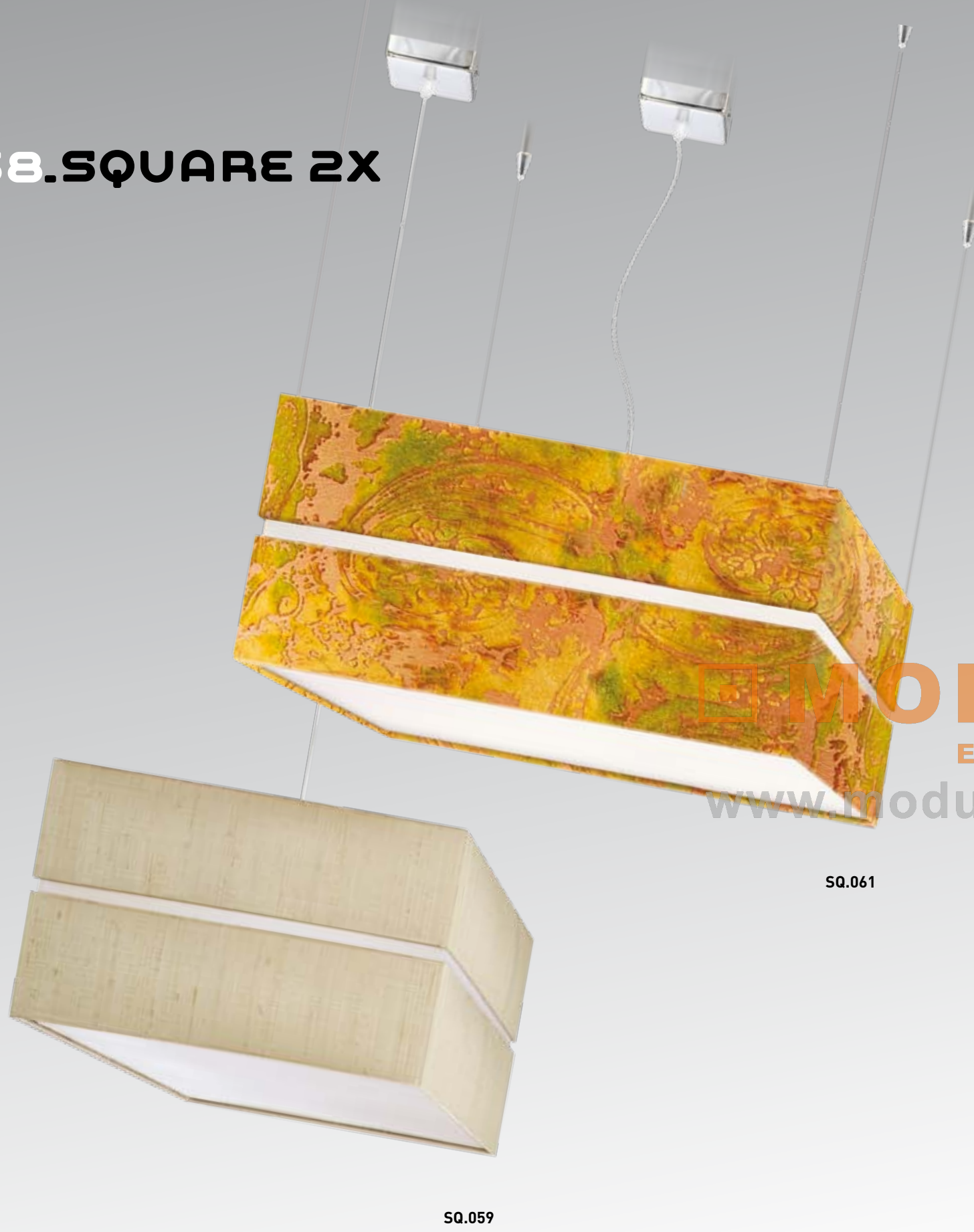

SQ.061

SQ.059



SQ.060
SQ.061
SQ.511

SQ.513
SQ.062

SQ.059

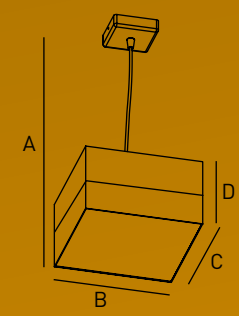
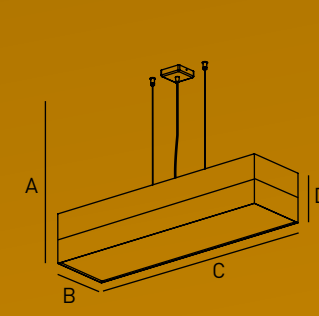
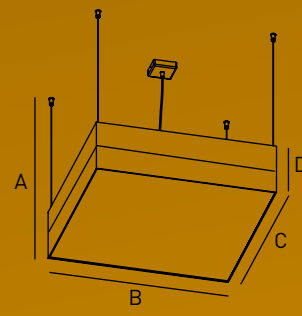

	A	B	C	D	DIF	⚙️
SQ.059	130cm	40cm	40cm	22cm	•	1xE-27 FLC 21w
SQ.060	130cm	50cm	50cm	22cm	•	4xE-27 FLC 21w
SQ.061	130cm	70cm	70cm	22cm	•	4xE-27 FLC 21w
SQ.511	130cm	90cm	90cm	22cm	•	4xE-27 FLC 21w
SQ.513	130cm	25cm	70cm	22cm	•	2xE-27 FLC 21w
SQ.062	130cm	25cm	95cm	22cm	•	4xE-27 FLC 21w

MODUL
ELECTRO
www.modulelectro.ru



260.SMOOTH

Colgante niquelado
y pantalla cuadrada con
canto romo, disponible
en cualquier material.

Nickel plated pendant lamp
with round-edged square
lampshade, available in
any material.

Vernickelte Deckenleuchte,
quadratischer Schirm mit
abgestumpfter Kante,
verfügbar in allen Materialien.

Lustre nickelé, abat-jour carré
à tranche émousée, disponible
dans n'importe quel matériel.



MODUL
ELECTRO
www.modulelectro.ru





MODUL
ELECTRO
www.modulelectro.ru

SM.001

	A	B	C	D	DIF	⚙️
SM.001	130cm	45cm	45cm	15cm	•	4xE-27 FLC 21w
SM.002	130cm	60cm	60cm	15cm	•	4xE-27 FLC 21w



MODULO
ELECTRO
www.modulelectro.ru

266.AROS

Todos los AROS llevan por defecto el soporte **Tech-07**. Puede escoger cualquier otro soporte en la página 306.

All products in the AROS collection have **Tech-07** support as standard but you can choose a different support from the selection on page 306.

Alle AROS haben standardmäßig die **Tech-07** Halterung, auf Seite 306 können Sie jegliche andere Halterung wählen.

Tous les AROS présentent par défaut le support **Tech-07**, on peut choisir n'importe quel autre support à la page 306.



268.AROS SIMPLES



MODUL
ELECTRO
www.modulelectro.ru

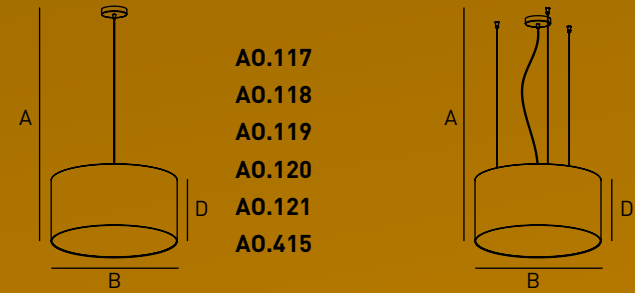

- A0.117
- A0.118
- A0.119
- A0.120
- A0.121
- A0.415

	A	BØ	D	DIF	☑
A0.117	-	25cm	25cm	•	1xE-27 FLC 11w
A0.118	-	35cm	25cm	•	1xE-27 FLC 11w
A0.119	-	40cm	25cm	•	1xE-27 FLC 11w
A0.120	-	45cm	25cm	•	2xE-27 FLC 11w
A0.121	-	50cm	25cm	•	3xE-27 FLC 11w
A0.122	-	60cm	30cm	•	3xE-27 FLC 11w
A0.123	-	70cm	30cm	•	3xE-27 FLC 11w
A0.124	-	80cm	35cm	•	3xE-27 FLC 11w
A0.125	-	90cm	35cm	•	3xE-27 FLC 11w
A0.126	-	100cm	40cm	•	6xE-27 FLC 11w
A0.127	-	120cm	40cm	•	6xE-27 FLC 11w
A0.128	-	140cm	40cm	•	6xE-27 FLC 11w
A0.415	-	45cm	15cm	•	3xE-27 FLC 11w
A0.416	-	60cm	15cm	•	3xE-27 FLC 11w



270.AROS 2X



A2.136



A2.135

MODUL
ELECTRO
www.modulelectro.ru

.271

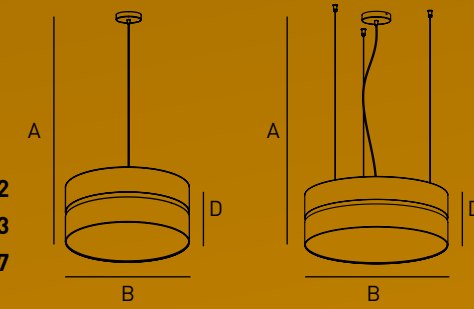
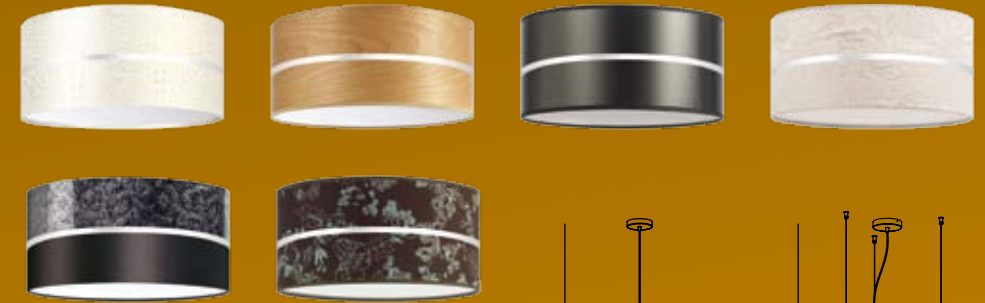

A2.132
A2.133
A2.517

	A	BØ	D	DIF	⚙️
A2.132	130cm	35cm	22cm	•	1xE-27 FLC 21w
A2.133	130cm	45cm	22cm	•	3xE-27 FLC 11w
A2.517	130cm	50cm	22cm	•	3xE-27 FLC 11w
A2.134	130cm	60cm	22cm	•	3xE-27 FLC 11w
A2.518	130cm	70cm	22cm	•	3xE-27 FLC 11w
A2.135	130cm	80cm	22cm	•	3xE-27 FLC 11w
A2.519	130cm	90cm	22cm	•	4xE-27 FLC 11w
A2.136	200cm	100cm	22cm	•	6xE-27 FLC 11w



272.AROS DOBLE



AD.401

AD.403

MODUL
ELECTRO
www.modulelectro.ru

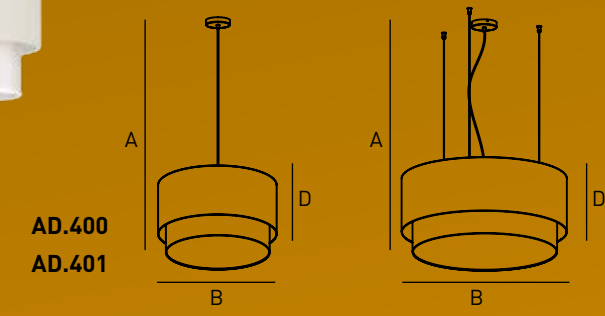

	A	BØ	D	DIF	☛
AD.400	130cm	35cm	33cm	•	1xE-27 FLC 21w
AD.401	130cm	45cm	35cm	•	3xE-27 FLC 11w
AD.402	130cm	60cm	35cm	•	3xE-27 FLC 11w
AD.403	130cm	80cm	35cm	•	3xE-27 FLC 11w
AD.404	200cm	100cm	40cm	•	6xE-27 FLC 11w
AD.405	200cm	120cm	40cm	•	6xE-27 FLC 11w



274.AROS TRIPLE



AT.407

AT.408

AT.406

MODUL
ELECTRO
www.modulelectro.ru

Technical diagrams showing dimensions A, B, D, and DIF for models AT.406 and AT.407.

	A	BØ	D	DIF	⚙️
AT.406	130cm	35cm	34cm	•	1xE-27 FLC 21w
AT.407	130cm	45cm	35cm	•	3xE-27 FLC 11w
AT.408	130cm	60cm	45cm	•	3xE-27 FLC 11w



MODUL
ELECTRO
www.modulelectro.ru



278. PLAFONES

Pantalla disponible
en cualquier material.
Sujeción por imanes
hasta un diámetro de 80 cm.

Lampshade available in any
material, attached by magnets
at up to 80cm in diameter.

Schirm in allen Materialien
verfügbar, Halterung durch
Magnete bis zu einem
Durchmesser von 80cm.

Abat-jour disponible dans
n'importe quel matériel,
fixation par aimants
jusqu'à 80 cm.





SQP.052

SQP.059

A2P.132

AOP.118

AOP.121



MODULO
ELECTRO

www.modulelectro.ru

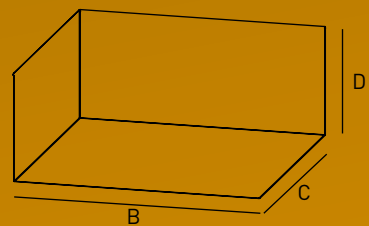

SQP.051
SQP.052
SQP.053
SQP.054
SQP.510
SQP.512

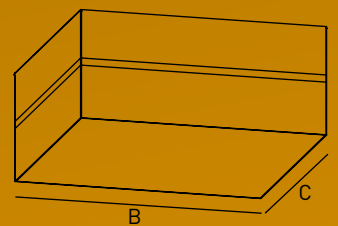

SQP.059
SQP.060
SQP.061
SQP.062
SQP.511
SQP.513

	A	B	C	D	DIF	☉
SQP.051	-	40cm	40cm	20cm	•	2xE-27 FLC 25w
SQP.052	-	50cm	50cm	20cm	•	4xE-27 FLC 11w
SQP.053	-	70cm	70cm	20cm	•	4xE-27 FLC 11w
SQP.510	-	90cm	90cm	20cm	•	4xE-27 FLC 11w
SQP.512	-	25cm	70cm	20cm	•	2xE-27 FLC 21w
SQP.054	-	25cm	95cm	20cm	•	4xE-27 FLC 21w
SQP.059	-	40cm	40cm	22cm	•	2xE-27 FLC 25w
SQP.060	-	50cm	50cm	22cm	•	4xE-27 FLC 11w
SQP.061	-	70cm	70cm	22cm	•	4xE-27 FLC 11w
SQP.511	-	90cm	90cm	22cm	•	4xE-27 FLC 11w
SQP.513	-	25cm	70cm	22cm	•	2xE-27 FLC 21w
SQP.062	-	25cm	95cm	22cm	•	4xE-27 FLC 21w

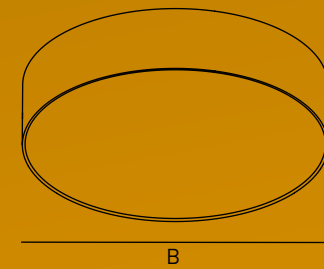

AOP.118
AOP.119
AOP.120
AOP.121
AOP.122
AOP.123
AOP.124

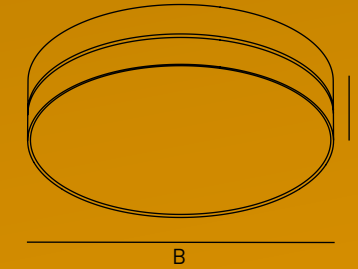

A2P.132
A2P.133
A2P.134
A2P.135
A2P.517
A2P.518
A2P.519

	A	BØ	D	DIF	☉
AOP.118	-	35cm	20cm	•	1xE-27 FLC 25w
AOP.119	-	40cm	20cm	•	2xE-27 FLC 21w
AOP.120	-	45cm	20cm	•	3xE-27 FLC 11w
AOP.121	-	50cm	20cm	•	3xE-27 FLC 11w
AOP.122	-	60cm	20cm	•	3xE-27 FLC 11w
AOP.123	-	70cm	20cm	•	3xE-27 FLC 21w
AOP.124	-	80cm	20cm	•	6xE-27 FLC 21w
A2P.132	-	35cm	22cm	•	1xE-27 FLC 21w
A2P.133	-	45cm	22cm	•	3xE-27 FLC 11w
A2P.517	-	50cm	22cm	•	3xE-27 FLC 11w
A2P.134	-	60cm	22cm	•	3xE-27 FLC 11w
A2P.518	-	70cm	22cm	•	3xE-27 FLC 11w
A2P.135	-	80cm	22cm	•	6xE-27 FLC 11w
A2P.519	-	90cm	22cm	•	6xE-27 FLC 11w



MODULO ELECTRO
www.modulelectro.ru



284. APLIQUES

Apliques disponibles en diferentes acabados y pantallas en cualquier material.

Wall lamps are available in different finishes with lampshades in any material.

Wandlampen in verschiedenen Finishes und Schirme in allen Materialien erhältlich.

Appliques disponibles dans différentes finitions et abat-jour dans n'importe quel matériel.

MODUL
ELECTRO
www.modulelectro.ru





MODUL
ELECTRO
www.modulelectro.ru



Cuerpo niquelado y pantalla disponible en cualquier material.

Nickel plated body, lampshade available in any material.

Vernickelter Körper, Schirm in allen Materialien verfügbar.

Corps nickelé, abat-jour disponible dans n'importe quel matériel.

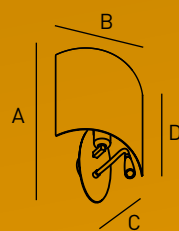

	A	B	C	D		
AP.521	38cm	20cm	25cm	25cm	1xE-27 FLC 11w	1xLEDs 3w



Cuerpo cromado y pantalla disponible en cualquier material.

Chromed body, lampshade available in any material.

Verchromter Körper, Schirm in allen Materialien verfügbar.

Corps chromé, abat-jour disponible dans n'importe quel matériel.

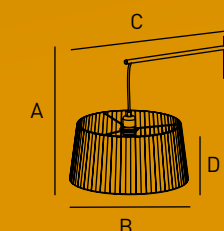

	A	B	C	D		
AP.524	40cm	40cm	50cm	20cm	1xE-27 FLC 11w	



MODULO
ELECTRO

www.modulelectro.ru

Cuerpo niquelado y pantalla disponible en cualquier material.
Nickel plated body, lampshade available in any material.
Vernickelter Körper, Schirm in allen Materialien verfügbar.
Corps nickelé, abat-jour disponible dans n'importe quel matériel.

Cuerpo niquelado y flexo con led de 3W.
Nickel plated body, cable with 3W LED.
Vernickelter Körper, Schlauchlampe mit 3W-LED.
Corps nickelé, tige à led de 3W.

Cuerpo cromado y pantalla disponible en cualquier material.
Chromed body, lampshade available in any material.

Verchromter Körper, Schirm in allen Materialien verfügbar.
Corps chromé, abat-jour disponible dans n'importe quel matériel.



	A	BØ	C	D	Light Source
AP.492	28cm	18cm	18cm	13cm	1xE-27 FLC 11w

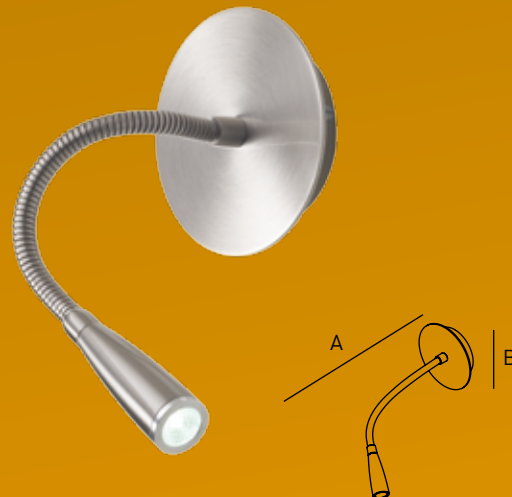

	A	B	C	D	Light Source
AP.520	25cm	10cm			1xLEDs 3w



	A	BØ	C	D	Light Source
AP.494	28cm	15cm	18cm	13cm	1xE-27 FLC 11w



	A	B	C	D	Light Source
AP.490	28cm	18cm	20cm	18cm	1xE-27 FLC 11w



MODULO
ELECTRO

www.modulelectro.ru

Cuerpo niquelado y pantalla disponible en cualquier material.
Nickel plated body, lampshade available in any material.

Vernickelter Körper, Schirm in allen Materialien verfügbar.
Corps nickelé, abat-jour disponible dans n'importe quel matériel.

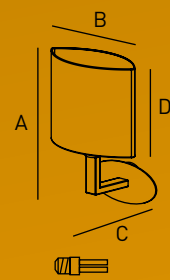

	A	B	C	D	
AP.491	38cm	25cm	20cm	20cm	1xE-27 FLC 11w

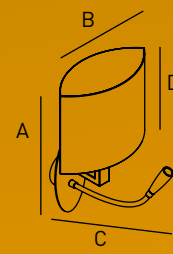

	A	B	C	D		
AP.523	40cm	25cm	25cm	20cm	1xE-27 FLC 11w	1xLEDs 3w

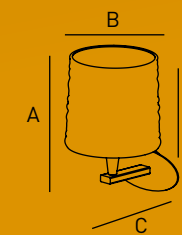

	A	BØ	C	D	
AP.489	32cm	20cm	22cm	20cm	1xE-27 FLC 11w

Cuerpo de oro y pantalla disponible en cualquier material.

Gold body, lampshade available in any material.

Körper Gold, Schirm in allen Materialien verfügbar.

Corps or, abat-jour disponible dans n'importe quel matériel.



MODULO
ELECTRO
www.modulelectro.ru

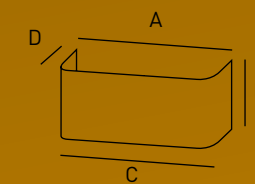

	A	B	C	D	
WL.199	30cm	25cm	30cm	14cm	1xE-27 FLC 21w
WL.223	14cm	40cm	14cm	14cm	1xE-27 FLC 21w
WL.287	20cm	30cm	20cm	14cm	1xE-27 FLC 21w



	A	B	C	D	
WL.416	60cm	25cm	60cm	16cm	2xE-27 FLC 21w
WL.417	90cm	25cm	90cm	16cm	4xE-27 FLC 21w
WL.418	90cm	25cm	90cm	18cm	5xE-27 FLC 21w



	A	B	C	D	
WL.414	30cm	25cm	30cm	14cm	1xE-27 FLC 21w
WL.415	50cm	25cm	50cm	14cm	2xE-27 FLC 21w



	A	B	C	D	
WL.174	30cm	30cm	15cm	14cm	1xE-27 FLC 21w



	A	B	C	D	
WL.411	100cm	30cm	100cm	14cm	4xE-27 FLC 21w
WL.016	45cm	22cm	45cm	14cm	1xE-27 FLC 21w
WL.017	70cm	26cm	70cm	14cm	2xE-27 FLC 21w



	A	B	C	D	
WL.175	30cm	25cm	30cm	14cm	1xE-27 FLC 21w
WL.228	30cm	60cm	30cm	14cm	2xE-27 FLC 21w
WL.286	22cm	25cm	22cm	14cm	1xE-27 FLC 21w



	A	B	C	D	
WL.412	22cm	140 cm	22cm	14cm	1xTLD 36W
WL.018	40cm	140cm	40cm	14cm	2xTLD 36W



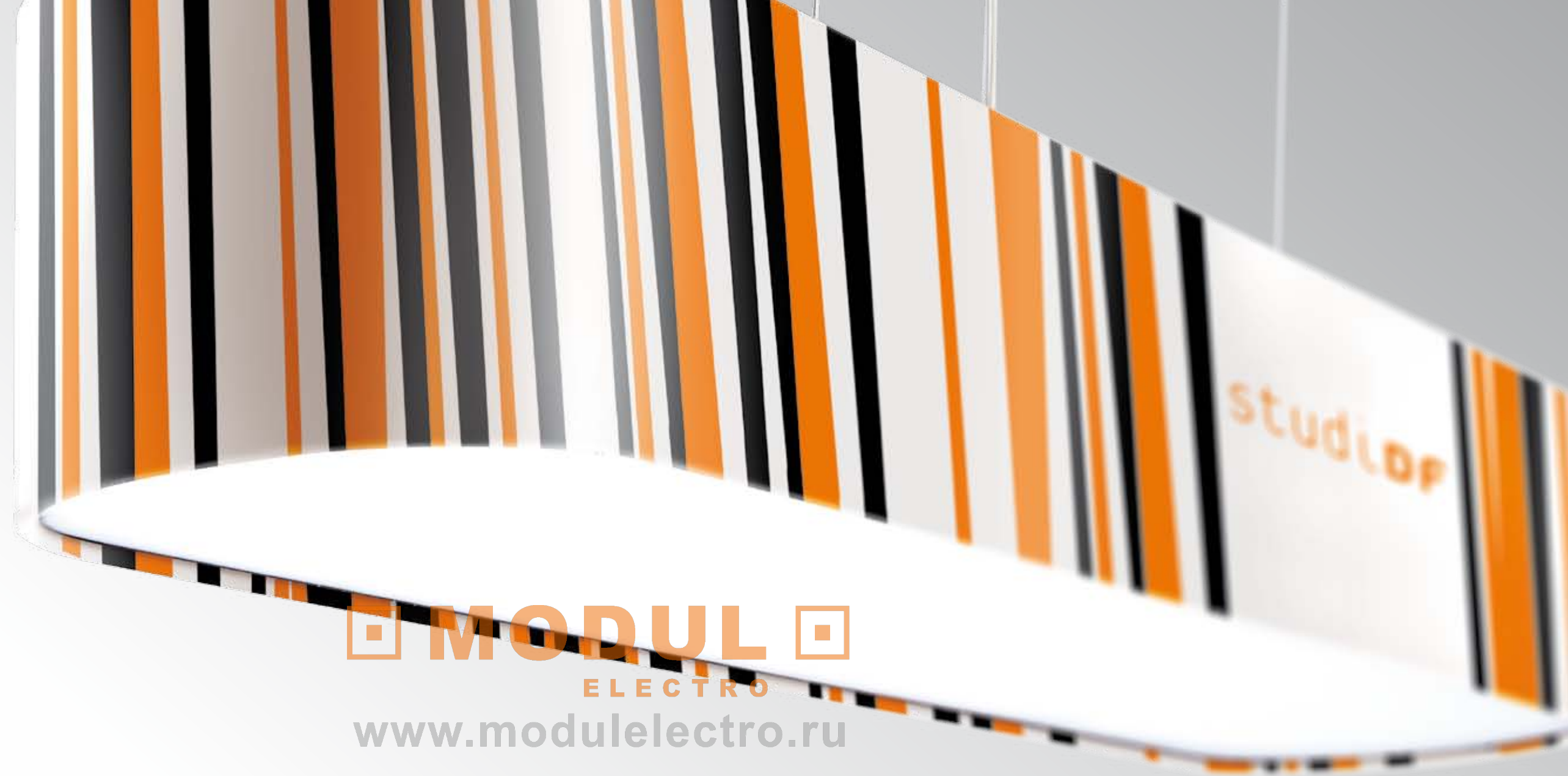

MODUL
ELECTRO
www.modulelectro.ru

PERSONALIZACIÓN

PERSONALIZACIÓN

Posibilidad de fabricar sus pantallas serigrafiando cualquier estampado, anagrama corporativo, foto o dibujo en cualquier pantalla. Bajo presupuesto.

PERSONALIZATION

It is possible to screen print any pattern, corporate logo, photograph or drawing onto any lampshade. Estimate on request.

PERSONALISIERUNG

Möglichkeit Ihre Schirme im Siebdruckverfahren mit jeglichem Aufdruck, Firmenlogo, Foto oder Zeichnung zu versehen, möglich für alle Schirme. Nach Kostenvoranschlag.

PERSONNALISATION

Possibilité de fabriquer vos abat-jour en appliquant par sérigraphie n'importe quel imprimé, anagramme corporatif, photo ou dessin, quel que soit l'abat-jour. Sur devis.



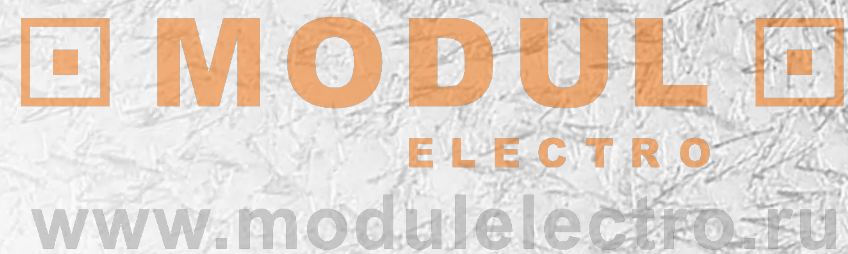

TELAS Y SOPORTES

TELAS Y SOPORTES

Esta es la gran variedad de tejidos y acabados que podemos ofrecer.

También es posible utilizar tejidos del cliente.

FABRICS AND SUPPORTS

We can offer a huge variety of fabrics and finishes.

It also possible to use a client's own fabrics.

STOFFE UND HALTERUNGEN

Das ist die große Auswahl an Stoffen und Finishes, die wir anbieten können.

Es ist auch möglich, Stoffe des Kunden zu verwenden.

TISSUS ET SUPPORTS

Voici la grande variété de tissus et finitions que nous pouvons offrir.

Il est également possible d'utiliser les tissus du client.

298.A - GROUP

B - GROUP .299



ALW

tejido lino
linen leinenstoff
tissu lin



ACA

tejido lino
linen leinenstoff
tissu lin



ALB

tejido algodón
cotton baumwollstoff
tissu coton



AZT

tejido brillante
shiny fabric glänzender Stoff
tissu brillant



BHG

tafetán
taffeta taft
taffetas



BHC

tafetán
taffeta taft
taffetas



ANG

tejido algodón
cotton baumwollstoff
tissu coton



ARD

tejido algodón
cotton baumwollstoff
tissu coton



APB

tejido algodón
cotton baumwollstoff
tissu coton



AZA

tejido brillante
shiny fabric glänzender Stoff
tissu brillant

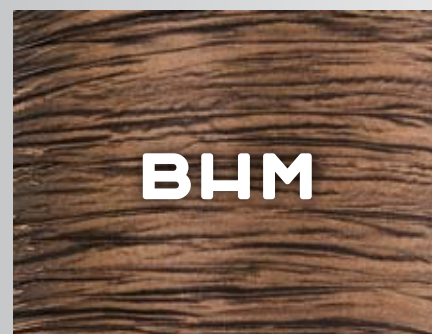

BHM

tafetán
taffeta taft
taffetas



BHS

tafetán
taffeta taft
taffetas



APN

tejido algodón
cotton baumwollstoff
tissu coton



ABG

tejido tornasolado
iridescent fabric changierende Stoff
tissu chatoyant



AOR

tejido tornasolado
iridescent fabric changierende Stoff
tissu chatoyant



AZM

tejido brillante
shiny fabric glänzender Stoff
tissu brillant



BVO

terciopelo
velvet samt
velours



BVL

terciopelo
velvet samt
velours



AGT

tejido tornasolado
iridescent fabric changierende Stoff
tissu chatoyant

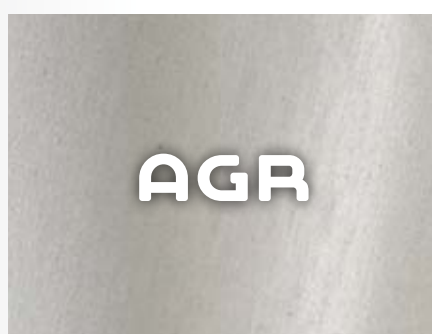

AGR

tejido tornasolado
iridescent fabric changierende Stoff
tissu chatoyant



ANA

tejido tornasolado
iridescent fabric changierende Stoff
tissu chatoyant



BTO

tafetán flocado
flocked taffeta geflockter Taft
taffetas floqué



BTB

tafetán flocado
flocked taffeta geflockter Taft
taffetas floqué

MODULO ELECTRO

www.modulelectro.ru

300.B - GROUP

B - GROUP .301



BSB

seda salvaje
wild silk
wilde Seide
soie sauvage



BSM

seda salvaje
wild silk
wilde Seide
soie sauvage



BSP

ante
suede
wildleder
daim



BAP

poliéster de aluminio
aluminium polyester
aluminium-Polyester
polyester aluminium

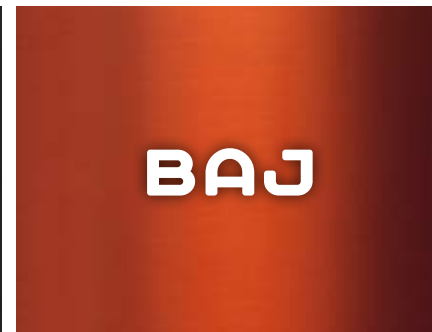

BAJ

poliéster de aluminio
aluminium polyester
aluminium-Polyester
polyester aluminium



BTG

tejido poliéster
polyester fabric
polyesterstoff
tissu polyester



BCR

ecopiel
eco-leather
ecopiel
éco-cuir



BSG

ecopiel
eco-leather
ecopiel
éco-cuir



BNH

tejido flocado
flocked fabric
geflockter Stoff
tissu floqué



BTS

tejido poliéster
polyester fabric
polyesterstoff
tissu polyester



BNB

exterior tejido e interior de poliéster cobre
fabric exterior, copper polyester interior



BCG

vinilo
vinyl
vinyl
vinyle



BAV

tejido flocado
flocked fabric
geflockter Stoff
tissu floqué



BDV

terciopelo damasco
damask velvet
damastamt
velours damas



BGF

organza bordada
embroidered organdie
bestickter Organza
organza brodé

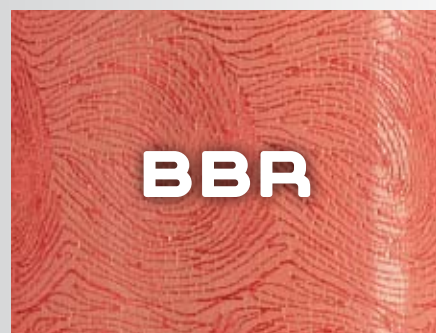

BBR

organza bordada
embroidered organdie
bestickter Organza
organza brodé



BBS

organza bordada
embroidered organdie
bestickter Organza
organza brodé



BBB

organza bordada
embroidered organdie
bestickter Organza
organza brodé

MODULO ELECTRO

www.modulelectro.ru



tejidos con nombre propio
brand name fabrics
stoffe mit Eigennamen
tissus avec nom perso



BNW

algodón
cotton
baumwolle
coton

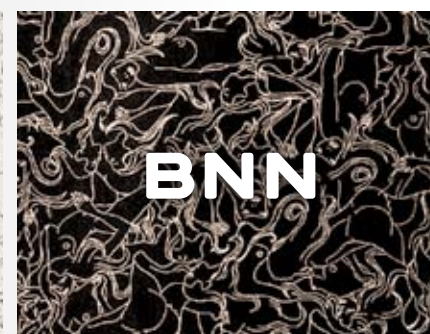

BNN

algodón
cotton
baumwolle
coton

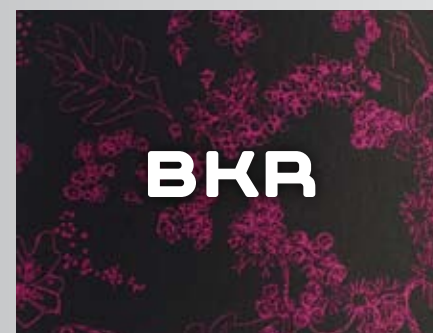

BKR

algodón
cotton
baumwolle
coton



BKM

algodón
cotton
baumwolle
coton



BTX

algodón
cotton
baumwolle
coton

302.C - GROUP



COR

cinta plisada
pleated fabrics



CGI

cinta plisada
pleated fabrics



CRU

cinta plisada
pleated fabrics



CBD

cinta plisada
pleated fabrics



CBK

cinta plisada
pleated fabrics



CWH

cinta plisada
pleated fabrics

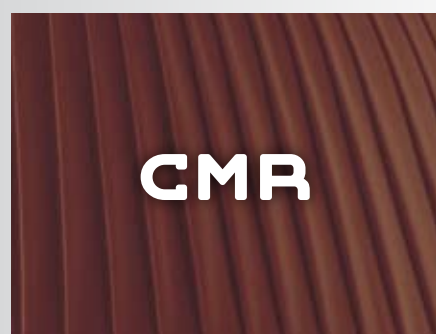

CMR

cinta plisada
pleated fabrics



CRJ

cinta plisada
pleated fabrics

D - GROUP .303



DDB

seda
silk

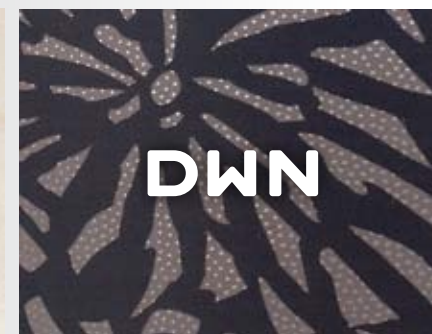

DWN

tejido perforado
perforated fabrics



DWB

tejido perforado
perforated fabrics



DVC

vinilo
vinyl



DVN

vinilo
vinyl

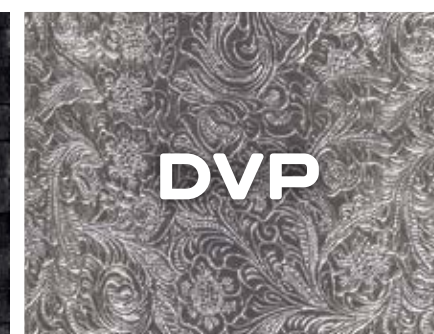

DVP

vinilo
vinyl



DCN

cristal
crystal



DCB

cristal
crystal



DMN

madera laminada
varnished wood



DOZ

tejido
fabric

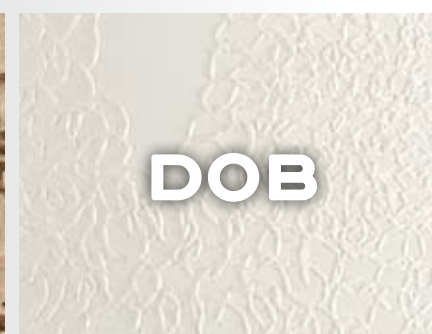

DOB

tejido
fabric



DMW

madera laminada
varnished wood

MODULO
ELECTRO
www.modulelectro.ru



organza bordada
embroidered organzie

bestickter Organza
organza brodé



damasco
damask

damast
damas

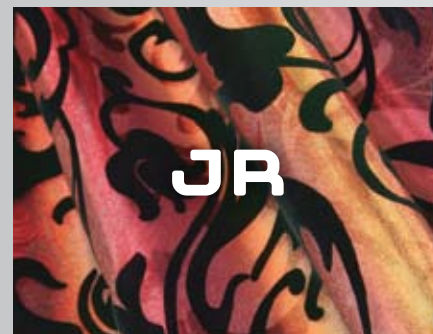

organza y damasco
organzie and damask

organza und Damast
organza et damas

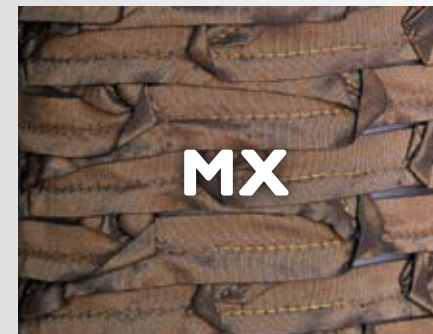

tejido
fabric

stoff
tissu

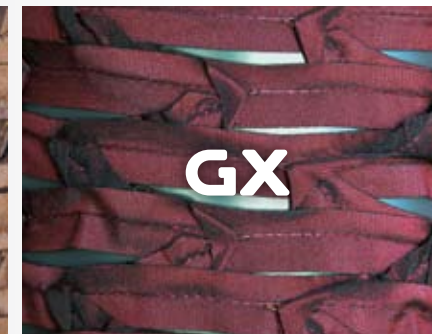

tejido
fabric

stoff
tissu



poliester
polyester

polyester
polyester



organza bordada
embroidered organzie

bestickter Organza
organza brodé



Los materiales **DGN** y **DGB**, **DDN** y **DDG** se utilizan sólo para pantallas cilíndricas.

DGN and **DGB**, **DDN** and **DDG** are only for use on cylindrical lampshades.

die Materialien **DGN** und **DGB**, **DDN** und **DDG** nur für zylindrische Schirme.

Les matériaux **DGN** et **DGB**, **DDN** et **DDG**, seulement pour abat-jour cylindriques.



organza bordada
embroidered organzie

bestickter Organza
organza brodé

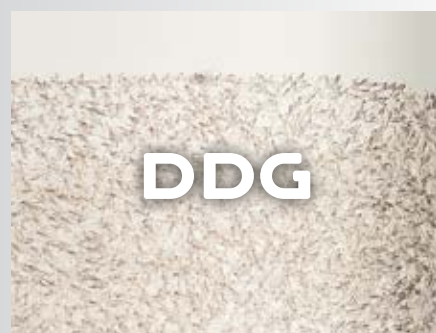

organza bordada
embroidered organzie

bestickter Organza
organza brodé

Material utilizado sólo para el modelo QUEEN.

Material only for use on the QUEEN model.

Material nur für das Modell QUEEN.

Matériel seulement pour le modèle QUEEN.

Los materiales MX y GX sólo se utilizan para el modelo NANSSA.

MX and GX materials are only for use on the NANSSA model.

Die Materialien MX, GX, nur für die Modelle NANSSA.

Les matériaux MX, GX, seulement pour le modèle NANSSA.

Los materiales MX y GX sólo se utilizan para el modelo NANSSA.

MX and GX materials are only for use on the NANSSA model.

Die Materialien MX, GX, nur für die Modelle NANSSA.

Les matériaux MX, GX, seulement pour le modèle NANSSA.

Material utilizado sólo para el modelo BERTA.

Material only for use on the BERTA model.

material nur für das Modell BERTA.

Matériel seulement pour modèle BERTA.

MODULO ELECTRO



organza y damasco
organzie and damask

organza und Damast
organza et damas

Material utilizado sólo para el modelo QUEEN.

Material only for use on the QUEEN model.

Material nur für das Modell QUEEN.

Matériel seulement pour le modèle QUEEN.



organza
organzie

organza
organza

Los materiales QB y QG se utilizan sólo para el modelo TRUDY.

QB and QG materials only for use on the TRUDY model.

Die Materialien QB, QG nur für das Modell TRUDY.

Les matériaux QB, QG, seulement pour le modèle TRUDY.

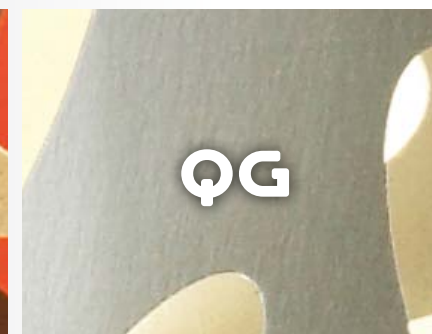

organza
organzie

organza
organza

Los materiales QB y QG se utilizan sólo para el modelo TRUDY.

QB and QG materials only for use on the TRUDY model.

Die Materialien QB, QG nur für das Modell TRUDY.

Les matériaux QB, QG, seulement pour le modèle TRUDY.



rejilla negra
black grille

schwarzes Netz
résille noire

Material utilizado sólo para el modelo NEX.

Material only for use on the NEX model.

Material nur für das Modell NEX.

Matériel seulement pour le modèle NEX.



TECH 01

Cuadrado marrón.
Brown square support.
Quadratisch Braun.
Carré marron.



TECH 02

Cuadrado gris.
Grey square support.
Quadratisch Grau.
Carré gris.



TECH 04

Cuadrado cromo.
Chromed square support.
Quadratisch Chrom.
Carré chrome.



TECH 05

Redondo marrón.
Brown round support.
Rund Braun.
Rond marron.



TECH 06

Redondo gris.
Grey round support.
Rund Grau.
Rond gris.



TECH 07

Redondo cromo.
Chromed round support.
Rund Chrom.
Rond chrome.



TECH 08

Redondo níquel.
Nickel plated round support.
Rund Nickel.
Rond nickel.



TECH 09

Redondo cromo y cable de acero.
Chromed round support, steel cable.
Rund Chrom, Stahlkabel.
Rond chrome, câble en acier.



TECH 10

Cuadrado cromo y cable de acero.
Chromed round support, steel cable.
Quadratisch Chrom, Stahlkabel.
Carré chrome, câble en acier.



FAW 01



FAW 12



FAW 10



FAW 09



FAW 02



FAW 08



FAW 11



KO 024



KO 003



KO 014



TECH 11

Redondo níquel y cable de acero.
Nickel plated round support, steel cable.
Rund Nickel, Stahlkabel.
Rond nickel, câble en acier.



TECH 12

Redondo S/C cromo.
Chromed S/C round support.
Rund S/C Chrom.
Rond S/C chrome.



TECH 13

Redondo S/C níquel.
Nickel plated S/C round support.
Rund S/C Nickel.
Rond S/C nickel.



TECH 14

Redondo S/C Oro.
Gold S/C round support.
Rund S/C Gold.
Rond S/C or.



TECH 16

Redondo Gris, vástago de 25cm.
Grey round support, 25 cm rod.
Rund Grau, Schaft 25cm.
Rond gris, tige 25 cm.



TECH 17

Redondo cromo, vástago de 25cm.
Chromed round support, 25cm rod.
Rund Chrom, Schaft 25cm.
Rond chrome, tige 25 cm.



TECH 18

Redondo níquel, vástago 25cm.
Nickel plated round support, 25cm rod.
Rund Nickel, Schaft 25cm.
Rond nickel, tige 25 cm.



TECH 19

Cuadrado gris, vástago de 25cm.
Grey square support, 25 cm rod.
Quadratisch Grau, Schaft 25cm.
Carré gris, tige 25 cm.



TECH 20

Cuadrado cromo, vástago de 25cm.
Chromed square support, 25cm rod.
Quadratisch Chrom, Schaft 25cm.
Carré chrome, tige 25 cm.



TECH 21

Cuadrado níquel, vástago de 25cm.
Nickel plated square support, 25cm rod.
Quadratisch Nickel, Schaft 25cm.
Carré nickel, tige 25 cm.



TECH 23

Redondo cromo, 3 cables de acero.
Chromed round support, 3 steel cables.
Rund Chrom, 3 Stahlkabel.
Rond chrome, 3 câbles en acier.



TECH 25

Redondo cromo, 2 cables transparentes.
Chromed round support, 2 transparent cables.
Rund Chrom, 2 transparente Kabel.
Rond chrome, 2 câbles transparent.

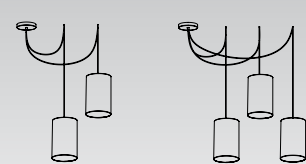

TECH 26

Redondo cromo, 3 cables transparentes.
Chromed round support, 3 transparent cables.
Rund Chrom, 3 transparente Kabel.
Rond chrome, 3 câbles transparent.



TECH 27

Redondo negro.
Black round support.
Rund Schwarz.
Rond noir.



TECH 28

Redondo Oro.
Gold round support.
Rund Gold.
Rond or.



EK 18

PVC negro.
Black PVC.
PVC Schwarz.
PVC noir.



EK 19

PVC blanco.
White PVC.
PVC Weiß.
PVC blanc.

MODULO
ELECTRO
www.modulelectro.ru

Todos los productos de El Torrent Il·luminació, S.L. están fabricados siguiendo las normativas españolas y europeas UNE-EN 60598-1:05 / UNE-EN 60598-2-1:93 / UNE-EN 60598-2-4:99

El Torrent Il·luminació, S.L. se reserva el derecho de hacer los cambios que considere oportunos en beneficio del producto final y del cliente. Todo el contenido de este catálogo está protegido por derechos de autor y copyright.

Queda terminantemente prohibida la reproducción total o parcial de las imágenes, textos, ilustraciones y conceptos gráficos sin autorización expresa de El Torrent Il·luminació, S.L.

All El Torrent Il·luminació, sl. products are manufactured according to Spanish and European regulations UNE-EN 60598-1:05 / UNE-EN 60598-2-1:93 / UNE-EN 60598-2-4:99

El Torrent Il·luminació, sl. reserves the right to make any changes it believes are beneficial to the end product and are in the client's interests. The content of this catalogue is copyright protected.

The total or partial reproduction of the images, text, illustrations and graphic designs included this catalogue is categorically forbidden, without the express authorization of El Torrent Il·luminació, sl.

CE

el torrent
ILUMINACIÓN LIGHTING

El Torrent Il·luminació, SL.
C. Can Caló, s/n - 17830 Mieres (Girona) Spain
T +34 972 680 291 - F +34 972 680 011
eltorrent@eltorrent.com - www.eltorrent.com

Fotografía **Photography** Fotografie **Photographie** - www.9dotze.com - bipolar - foto disseny J.E.
Diseño **Design** Gestaltung **Design** - www.studidf.com
Impresión **Printing** Druck **Impression** - gràfiques alzamora
Dip legal - GI-702-2010

Alle Produkte von EL Torrent Il·luminació, SL. werden gemäß den spanischen und europäischen Richtlinien UNE-EN 60598-1:05 / UNE-EN 60598-2-1:93 / UNE-EN 60598-2-4:99 erzeugt.

El Torrent Il·luminació, sl. behaltet sich das Recht vor, die von ihm für zweckmäßig erachteten Abänderungen zum Vorteil des Endprodukts und des Kunden durchzuführen. Der gesamte Inhalt dieses Katalog ist durch Urheberrechte und Copyright geschützt.

Die teilweise oder ganze Vervielfältigung der Fotos, Texte, Illustrationen und graphischen Konzepte ist ohne ausdrückliche Erlaubnis von El Torrent Il·luminació, sl. ausdrücklich verboten.

Tous les produits de El Torrent Il·luminació, sl. sont fabriqués en suivant les réglementations espagnole et européennes UNE-EN 60598-1:05 / UNE-EN 60598-2-1:93 / UNE-EN 60598-2-4:99

El Torrent Il·luminació, sl. se réserve le droit de faire les changements jugés nécessaires au bénéfice du produit final et du client. Tout le contenu de ce catalogue est protégé par des droits d'auteur et par copyright.

La reproduction totale ou partielle des images, textes, illustrations et concepts graphiques est formellement interdite sans autorisation expresse de El Torrent Il·luminació, sl.

MODULO
ELECTRO
www.modulelectro.ru

ELECTRO

www.modulelectro.ru

el torrent
ILUMINACIÓN LIGHTING 

El Torrent Il·luminació, SL.
C. Can Caló, s/n - 17830 Mieres (Girona) Spain
T +34 972 680 291 - F +34 972 680 011
eltorrent@eltorrent.com - www.eltorrent.com