

 **MODUL** 

**ELECTRO**

[www.estiluz.com](http://www.estiluz.com)

[www.modulelectro.ru](http://www.modulelectro.ru)

# MODUL

## ELECTRO

**Think Green.** Environmentally friendly design. Being environmentally conscious influences our entire product's cycle. From the selection of materials and packing to light sources. Always respecting the environment. Our new collection strengthens the values of current and timeless designs, contributing to the sustainability of our planet thanks to its quality and lasting performance. Quality and design made in Europe. Estiluz is a company committed to the employment in Europe. We believe in the sustainability and quality of employment in our country. All our products are manufactured in our facilities in Sant Joan de les Abadesses. Our models are created by young and experienced designers with the support of our engineering team as well as our Design Studio. The aesthetics of design change as time goes by, good values remain.

**Going Green.** Design und Umwelt. Der umweltfreundliche Gedanke beeinflusst alle Vorgänge und Abläufe unserer Produkte, von der Materialien- und Verpackungsauswahl bis hin zur Verwendung von umweltfreundlichen und energiesparenden Lichtquellen. Unsere neue Leuchtenkollektion spiegelt die aktuellen, zeitlosen Designwerte wider und wirkt dank seiner Qualität und Lebensdauer bei der Nachhaltigkeit unseres Planeten mit. Qualität und Design Made in Europe. Estiluz glaubt an die Arbeitsplätze in Europa, da wir fest von der Qualität der Arbeit überzeugt sind. Die Fertigung unserer Produkte findet ausschließlich in Sant Joan de les Abadesses statt. Junge Designer kreieren unsere Modelle mit der Unterstützung unseres Ingenieurteams und Design Studios. Das Design ändert sich im Laufe der Zeit. Die guten Werte bleiben.

**Design et environnement.** La pensée écologique influe tout le cycle de nos produits, de la sélection des matériaux aux emballages et aux sources lumineuses. Toujours respectueux de l'environnement. Notre nouvelle collection renforce les valeurs de design actuel et intemporel, en contribuant à la protection de notre planète grâce à sa qualité et à sa durabilité. Qualité et design made in Europe. Estiluz est une société engagée pour l'emploi en Europe, nous croyons en la qualité du travail dans notre pays. Nous fabriquons dans nos installations de Saint Joan de les Abadesses nos modèles, dessinés par des jeunes créateurs expérimentés, avec le support de notre équipe d'ingénieurs et notre Bureau d'étude de Design. L'esthétique change au cours du temps. Les bonnes valeurs restent.



estiluz®



10



NEW

**MODUL**  
**ELECTRO**

Piensa Verde.

Diseño y medio ambiente. El pensamiento ecológico influye en todo el ciclo de nuestros productos, desde la selección de materiales y embalajes hasta las fuentes de luz. Siempre respetuosos con el medio ambiente. Nuestra nueva colección refuerza los valores de diseño actual y atemporal, contribuyendo a la sostenibilidad de nuestro planeta gracias a su calidad y durabilidad.

Calidad y diseño Made in Europe. Estiluz es una empresa comprometida con el empleo en Europa porque creemos en la sostenibilidad y calidad del empleo en nuestro país. Son productos fabricados en nuestras instalaciones de Sant Joan de les Abadesses, modelos creados por jóvenes y experimentados diseñadores con el apoyo de nuestro equipo de ingenieros y nuestro Estudio de Diseño. La estética del diseño cambia con el transcurso del tiempo. Los buenos valores permanecen.

nan A-3000 | A-3001



guimeràicina



nan M-3004

guimeràicinca



 **MODUL**   
ELECTRO  
[www.modulelectro.ru](http://www.modulelectro.ru)



carpet A-2910

serra&delarocha

 **MODUL**   
ELECTRO

[www.modulelectro.ru](http://www.modulelectro.ru)



carpet A-2911

serra&delarocha

  
ELECTRO

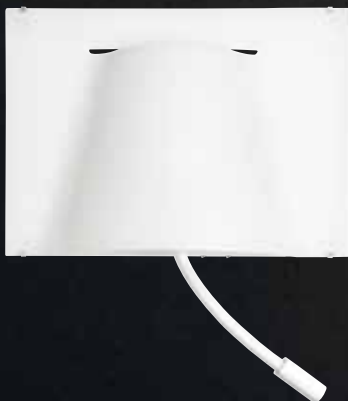

[www.modulelectro.ru](http://www.modulelectro.ru)

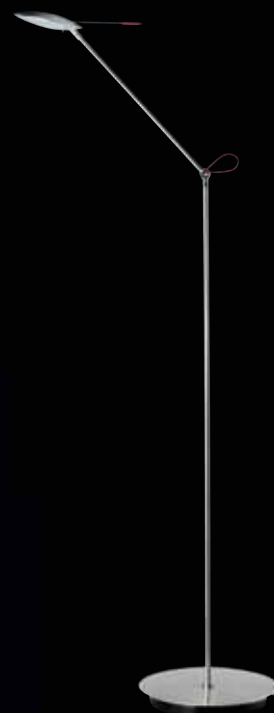

moon p-3007

estudi ribaudí



 **MODUL**   
ELECTRO  
[www.modulelectro.ru](http://www.modulelectro.ru)



moon P-3008

estudi ribaudí

 **MODUL** 

**ELECTRO**

[www.modulelectro.ru](http://www.modulelectro.ru)



# moon P-3009

estudi ribaudí

 **MODUL**   
ELECTRO

[www.modulelectro.ru](http://www.modulelectro.ru)



wall A-3002 | A-3002L

serra&delarocha



 **MODUL**   
ELECTRO

[www.modulelectro.ru](http://www.modulelectro.ru)

# libra T-2916

estudi estiluz



**MODUL**  
ELECTRO  
[www.modulelectro.ru](http://www.modulelectro.ru)



**maiden T-2825**

estudi estiluz

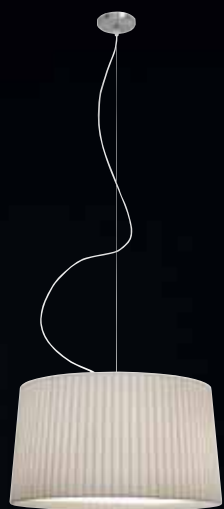

**MODUL**  
ELECTRO  
[www.modulelectro.ru](http://www.modulelectro.ru)

**MODUL**  
ELECTRO  
[www.modulelectro.ru](http://www.modulelectro.ru)

## nan A-3000 | A-3001

guimeràicnca

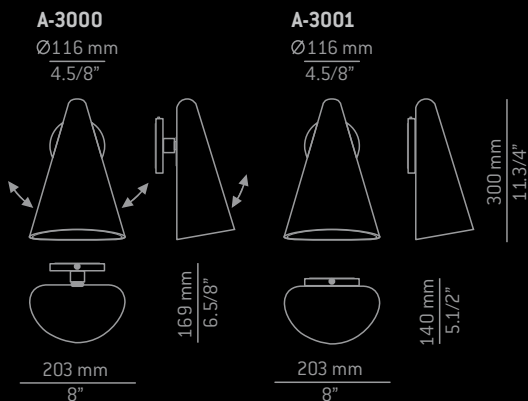

Aplicue con pantalla de cristal opal. Luz directa e indirecta. Versión fija (A-3001) y versión con pantalla orientable (A-3000)

Wall sconce providing direct and indirect light. White opal glass (adjustable in A-3000).

Wandleuchte. Direktes und indirektes Licht. Opalglas weiß satiniert. Drehbar (A-3000)

Applique lumière directe et indirecte. Verre opalin blanc. Version fixe (A-3001). Version Orientable (A-3000)

● 74BL

Hal. | BT | E27 | 100W | 230V

El. fluorescent | E27 | 20W | 230V

Inc. | E27 | 100W | 230V



# MODUL

## ELECTRO

www.modul-electro.ru

## nan M-3004

guimeràicnca

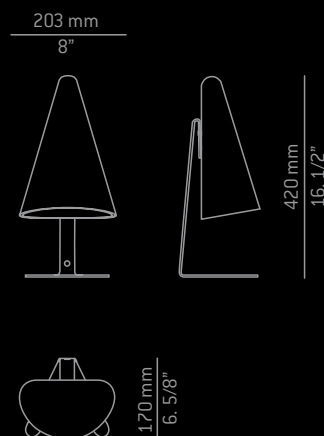

Lámpara de sobremesa metálica con pantalla de cristal opal. Luz directa e indirecta.

Metallic table lamp providing direct and indirect light. White opal glass.

Metalltischleuchte. Direktes und indirektes Licht. Opalglas weiß satiniert.

Lampe à poser en métal avec lumière directe et indirecte. Verre opalin blanc.

● 74BL

Hal. | BT | E27 | 100W | 230V

El. fluorescent | E27 | 20W | 230V

Inc. | E27 | 100W | 230V



## carpet A-2910 | A-2911

serra&delarocha

A-2910

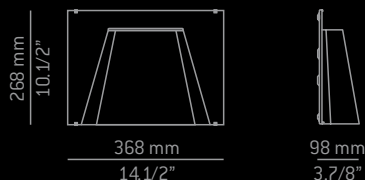

A-2911

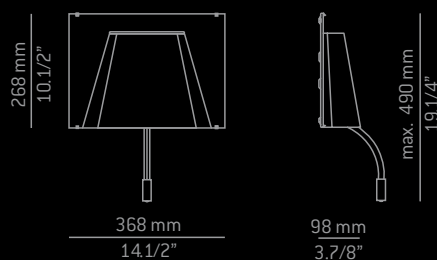

Aplicae con pantalla de cristal blanco satinado. Luz directa e indirecta. Difusor inferior metálico. A-2911 incorpora un brazo de lectura orientable y dos interruptores para encendida independiente.

Wall sconce providing direct and indirect light. White satin glass and bottom metal diffuser. A-2911 has a flexible arm for reading and two independent switches.

Wandleuchte. Direktes und indirektes Licht. Opalglas weiß satiniert. A-2911: Leselicht mit Flexarm. Doppelschalter getrennt einschaltbar.

Applique lumière directe et indirecte. Verre blanc satiné et diffuseur inférieur en métal blanc. A-2911: Bras flexible pour lecture et allumage indépendant (deux interrupteurs).

● 74BL

### A-2910

Hal. | BT | E27 | 100W | 230V

El. fluorescent | E27 | 20W | 230V 

Inc. | E27 | 100W | 230V



### A-2911

Hal. | BT | E27 | 100W | 230V + LED 1W

El. fluorescent | E27 | 20W

230V + LED 1W 

Inc. | E27 | 100W | 230V + LED 1W



# MODUL



## moon p-3007

estudi ribaudí

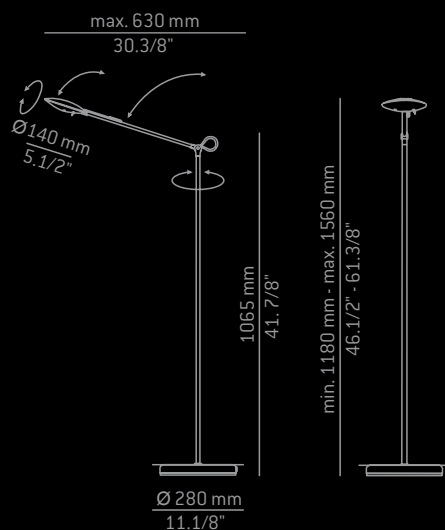

Lámpara de pie de lectura. Brazo articulado con interruptor en la pantalla.

Metallic reading light. Swing arm with switch built in the head.

Leseleuchte aus Metall. Beweglicher Lesearm. Schalter am Leuchtenkopf.

Liseuse métallique. Bras articulé avec interrupteur intégré au réflecteur.

●● 22CR 26NE 37NI

LED | hi-power warm white | 5W | 230V 





## moon P-3008

estudi ribaudí

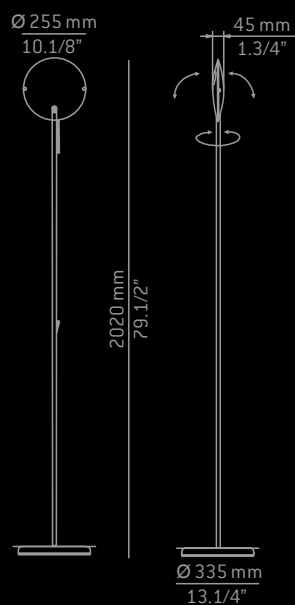

Lámpara de pie metálica. Regulador en forma de pulsador en el cuerpo de la lámpara.





Metallic floor lamp. Dimmer in the body of the lamp for easy access.

Metallstehleuchte Lichtregler in Handreichhöhe.

Lampadaire métallique. Bouton variateur sur la tige.

●● 22CR 26NE 37NI

Hal. | R7s | 118 mm | 130W | 230V | ES\* 

CE    

# MODUL

## ELECTRO

## moon P-3009

estudi ribaudí

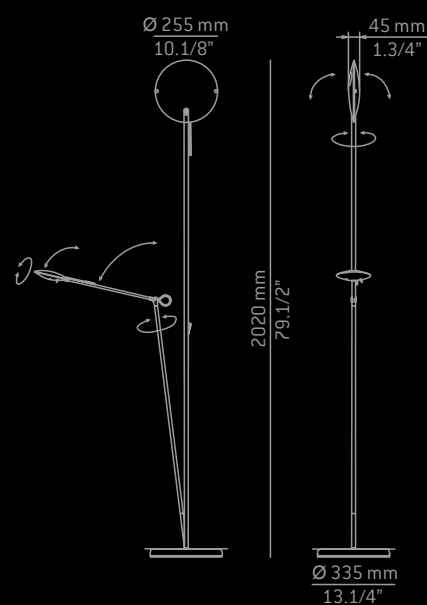

Lámpara de pie con con brazo de lectura. Regulador en forma de pulsador en el cuerpo de la lámpara e interruptor en la pantalla del brazo de lectura.

Floor lamp with reading arm. Dimmer in the body of the lamp for easy access and switch is built in the head of the arm.





Stehleuchte mit Lesearm. Lichtregler in Handreichhöhe. Schalter am Kopf des Lesearms.

Lampadaire avec liseuse intégrée. Bouton variateur sur la tige et interrupteur du bras de lecture sur son réflecteur.

●● 22CR 26NE 37NI

Hal. | R7s | 118 mm | 130W | 230V | ES\* 

⊕ LED | hi-power warm white | 5W | 230V | ES

CE    

[www.modulelectro.ru](http://www.modulelectro.ru)

## wall A-3002 | A-3002L

serra&delarocha

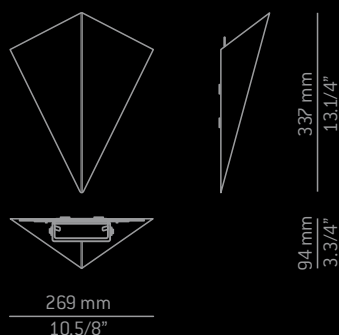

Aplicque metálico con luz indirecta.  
Metallic wall sconce providing indirect light.  
Metallwandleuchte. Indirektes Licht.  
Applique en métal. Lumière indirecte.

●● 56NEM 61ORS 76BLM

### A-3002

Hal. | R7s | 78 mm | 100W | 230V ES\*



### A-3002L

LED 6W ▽ ES



# MODUL

## ELECTRO

## libra T-2916

estudi estiluz

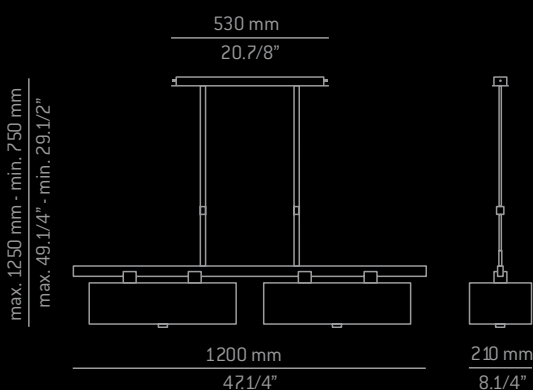

Lámpara de techo con luz directa e indirecta. Pantalla de fibra de poliéster recubierta de PVC. Vidrio satinado en parte inferior. Altura regulable.

Pendant providing direct and indirect light. Shade is made of polyester fibre protected by a PVC coating. Bottom glass diffuser. Adjustable height.

Pendelleuchte. Direktes und indirektes Licht. Polyester-fiberschirm mit innerem PVC Belag. Unteres Glas weiß satiniert. Höhenverstellbar.

Suspension lumière directe et indirecte. Abat-jour en tissu polyester et intérieur en PVC blanc. Verre blanc satiné inférieur. Hauteur réglable.

● 37NI

Pantalla | Shade | Schirm | Abat-jour

●● 26NE 27BL

Hal. | BT | E27 | 4X60W | 230V ▽



El. Fluorescent | E27 | 4X15W | 230V ▽ ES



Inc. | E27 | 4X60W | 230V ▽



# maiden T-2825

estudi estiluz

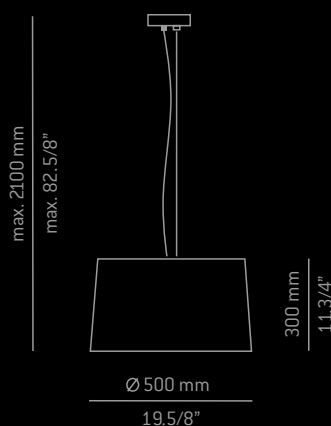

Lámpara de techo con pantalla plisada de algodón. Cristal difusor inferior. Altura regulable.

Pendant with pleated cotton shade. Adjustable Height. Bottom glass diffuser.



Pendelleuchte. Baumwollschirm plissiert. Höhenverstellbar. Unterer Glasdiffusor.



Suspension avec abat-jour en coton plissé. Verre diffuseur inférieur. Réglable en hauteur.

● 37NI

Pantalla | Shade | Schirm | Abat-jour

● 26NE 27BL

Hal. | BT | E27 | 2X100W | 230V  

El. Fluorescent | E37 | 2X30W | 230V  ES 

Inc. | E27 | 2X100W | 230V  



familia | family | famille | familie | P p.258 estiluz catalogue

# MODUL

## acabados

finishes | Oberflächen | finitions

● 22CR

Cromo | Polished chrome | Chrom | Chromé

○ 26NE

Lacado negro | Black lacquer | Mattschwarz lackiert | Laqué noir

● 37NI

Níquel | Brushed Nickel | Nickel gebürstet | Nickel satiné

○ 56NE M

Negro mate [rugoso] | Matt Black [rough] | Mattschwarz [rau]  
Noir mat [ruguex]

● 61ORS

Oro 24 q. satinado | 24 carat satin gold | Goldmatt 24 karat  
Or satiné 24 carats

● 74BL

Lacado blanco brillante | White lacquer | Weiß glänzend lackiert  
Laqué blanc brillant

● 76BL M

Blanco mate [rugoso] | Matt white [rough] | mattweiß [rau]  
Blancmat [ruguex]

## pantalla

shade | schirm | abat-jour

○ 26NE



Negro | Black | Schwarz | Noir

● 27BL

Blanco | White | Weiß | Blanc

ES\*

nueva bombilla de Economía de Energía | new Energy Saving bulb | nouvelle ampoule Economie d'énergie  
neues energiesparendes Leuchtmittel

 **MODUL**   
**ELECTRO**  
[www.modulelectro.ru](http://www.modulelectro.ru)