

**MODUL**  
ELECTRO

[www.modulelectro.ru](http://www.modulelectro.ru)

  
formia  
luxury glass  
murano

designlights

# COLORI COLORS



acciaio - steel



ambra - amber



ametista  
amethyst



alessandrite  
alexandrite



acqua chiaro  
light aqua



acquamarina  
aquamarine



arancio - orange



bluino - light blue



blu cobalto  
blue



blu grigio  
blue grey



cristallo - crystal



cristallo oro \*  
crystal gold \*



fumè - smoked



giallo - yellow



bianco - white

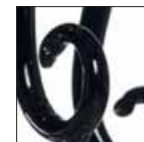

nero - black



rosso - red



rubino chiaro  
light ruby

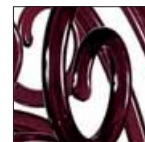

rubino scuro  
dark ruby



seta - silk



seta oro - silk gold



tabacco - tobacco



topazio - topaz



verde scuro  
dark green



verde  
green



viola - violet

\* l'oro può essere applicato ad ogni altro colore - \* gold finishing is available with any other color

le tonalità cromatiche di questi campioni sono solamente indicative e potrebbero risultare leggermente diverse  
the colours of these samples are intended as a rough guide and may differ slightly from the real shades

i pesi indicati a catalogo sono solamente indicativi - weights shown in our catalogue are approximately only

i lampadari sono forniti con rosone a soffitto, catena e parti di ricambio  
the lights are supplied with canopy, chain and spare parts

applicazione disponibile - available application

## LEDyBulb Innovative LED Technology

Formia International's patent

**LEDyBulb** consiste in una parte metallica, cromata o dorata, di h cm 7 o h cm 12, equipaggiata con 3 LED, per un consumo totale di 4 Watt. In questo tubo metallico viene alloggiato un diffusore, in materiale plastico (PMMA), di forma tonda o ad oliva, come le tradizionali lampadine ad incandescenza. L'intensità della luce è come quella di una lampadina a 40 Watt, la diffusione è a 360° e la resa cromatica è a scelta tra: fredda/bianca; normale /bianca o calda/gialla.

**LEDyBulb** comprises a 7- or 12-cm-long chrome- or gold-plated metal component equipped with three LEDs for a total power consumption of 4 Watts. A plastic (PMMA) diffuser is then fitted into this metal tube with a rounded or oval shape similar to that of traditional incandescent light bulbs. The light intensity is the same as that of a 40 Watts light bulb, guaranteeing a 360° diffusion and the shades available are: cold/white; normal/white or warm/yellow.

### i 7 vantaggi di LEDyBulb

- bassi consumi: 4 Watt contro i 40 Watt della lampadina incandescente
- durata di 50.000 ore
- durata infinita del diffusore a forma di lampadina
- medesima intensità luce di una lampadina a 40 Watt (LUX)
- medesima diffusione di una lampadina (360°)
- medesima estetica di una lampadina (tonda o oliva)
- colore della luce o resa cromatica a scelta: fredda/bianca; normale/bianca; calda/gialla



### 7 advantages of using LEDyBulb

- low energy consumption: 4 Watts instead of the 40 Watts of an incandescent light bulb
- lifetime of 50,000 hours
- the light-bulb-shaped diffuser has an extra-long lifetime
- same light intensity as a 40 Watt light bulb (LUX)
- same diffusion as a traditional light bulb (360°)
- same shape (rounded or oval) as a traditional light bulb
- range of shades available: cold/white; normal/white; warm/yellow



MODULO  
ELECTRO  
www.modulelectro.ru

formia  
luxury glass  
murano

 **MODUL**   
ELECTRO  
[www.modulelectro.ru](http://www.modulelectro.ru)

PURE DESIGN

# FONTANA

design Denise Gemin

4

**MODULO**  
ELECTRO  
[www.modulelectro.ru](http://www.modulelectro.ru)

5



# FONTANA

h cm 120 x Ø cm 100 - h 47 1/4" x Ø 39 1/3" - see page 140

# FONTANA vs FONTANA

Fornia Design Studio

6

**MODUL**  
ELECTRO  
[www.modulelectro.ru](http://www.modulelectro.ru)

7



FONTANA  
vs FONTANA

h cm 200 x Ø cm 100 - h 94 1/2" x Ø 39 1/3" - see page 140

# TRANSILVANIA

design Giorgio Barera

**MODUL**  
ELECTRO  
[www.modulelectro.ru](http://www.modulelectro.ru)



TRANSILVANIA

h cm 55 x Ø cm 70 - h 21 2/3" x Ø 27 1/2" - see page 147

DOHA  
design Giorgio Barera



10

 **MODUL**  
ELECTRO  
[www.modulelectro.ru](http://www.modulelectro.ru)



11

DOHA

h cm 105 x Ø cm 97 - h 41" x Ø 38 1/4" - see page 138

CAPRI  
design Denise Gemin

12



MODUL  
ELECTRO  
www.modulelectro.ru

13



CAPRI

h cm 110 x Ø cm 110 - h 43 1/3" x Ø 43 1/3" - see page 137



# TRIPODE

design Denise Gemin

14



**MODUL**  
ELECTRO  
[www.modulelectro.ru](http://www.modulelectro.ru)

15



## TRIPODE

h cm 105 x Ø cm 80 - h 41" x Ø 31" - see page 148

# MARS

design Giulia Rioda

16



**MODUL**  
ELECTRO  
[www.modulelectro.ru](http://www.modulelectro.ru)

17



MARS



h cm 108 x Ø cm 108 - h 42 1/2" x Ø 42 1/2" - see page 142

# ODESSA

design Giulia Rioda

18



 **MODUL**   
ELECTRO  
[www.modulelectro.ru](http://www.modulelectro.ru)

19





## ODESSA

h cm 110 x Ø cm 100 - h 43 1/3" x Ø 40" - see page 144

# NEW YORK

design Giulia Rioda

20

 **MODUL**   
ELECTRO  
[www.modulelectro.ru](http://www.modulelectro.ru)

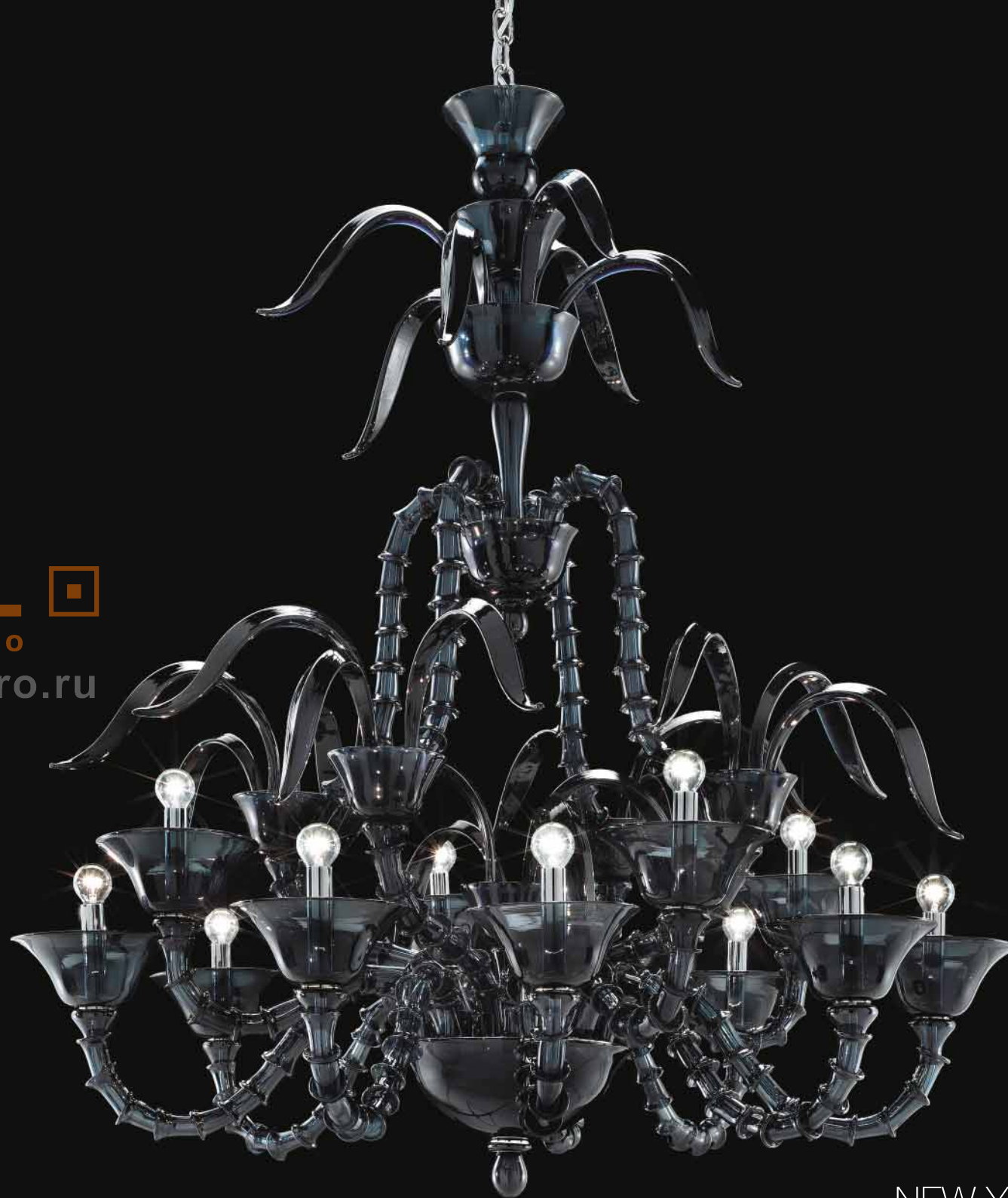

21

NEW YORK

h cm 130 x Ø cm 115 - h 51 1/4" x Ø 45 1/4" - see page 143

BALI  
design Denise Gemin



22

  
ELECTRO  
[www.modulelectro.ru](http://www.modulelectro.ru)



23

BALI

h cm 143 x Ø cm 100 - h 56 1/3" x Ø 40" - see page 136

BALI



24

**MODUL**  
ELECTRO  
[www.modulelectro.ru](http://www.modulelectro.ru)

h cm 110 x Ø cm 105 - h 43 1/3" x Ø 41 1/3"



25

BALI

h cm 90 x Ø cm 70 - h 35 1/2" x Ø 27 1/2" - see page 136

# ISTANBUL

design Giorgio Barera

26

**MODUL**  
ELECTRO  
[www.modulelectro.ru](http://www.modulelectro.ru)

27



ISTANBUL

h cm 130 x Ø cm 120 - h 51 1/4" x Ø 47 1/4" - see page 141

ISTANBUL



28

h cm 130 x Ø cm 120 - h 51 1/4" x Ø 47 1/4"



MODULO  
ELECTRO  
www.modulelectro.ru



29

ISTANBUL

h cm 69 x Ø cm 70 - h 27 1/4" x Ø 27 1/2" - see page 141



SHANGAI  
design Giulia Rioda

30

**MODUL**  
ELECTRO  
[www.modulelectro.ru](http://www.modulelectro.ru)



31

SHANGAI

h cm 88 x Ø cm 80 - h 34 2/3" x Ø 31 1/2" - see page 146

SHANGAI

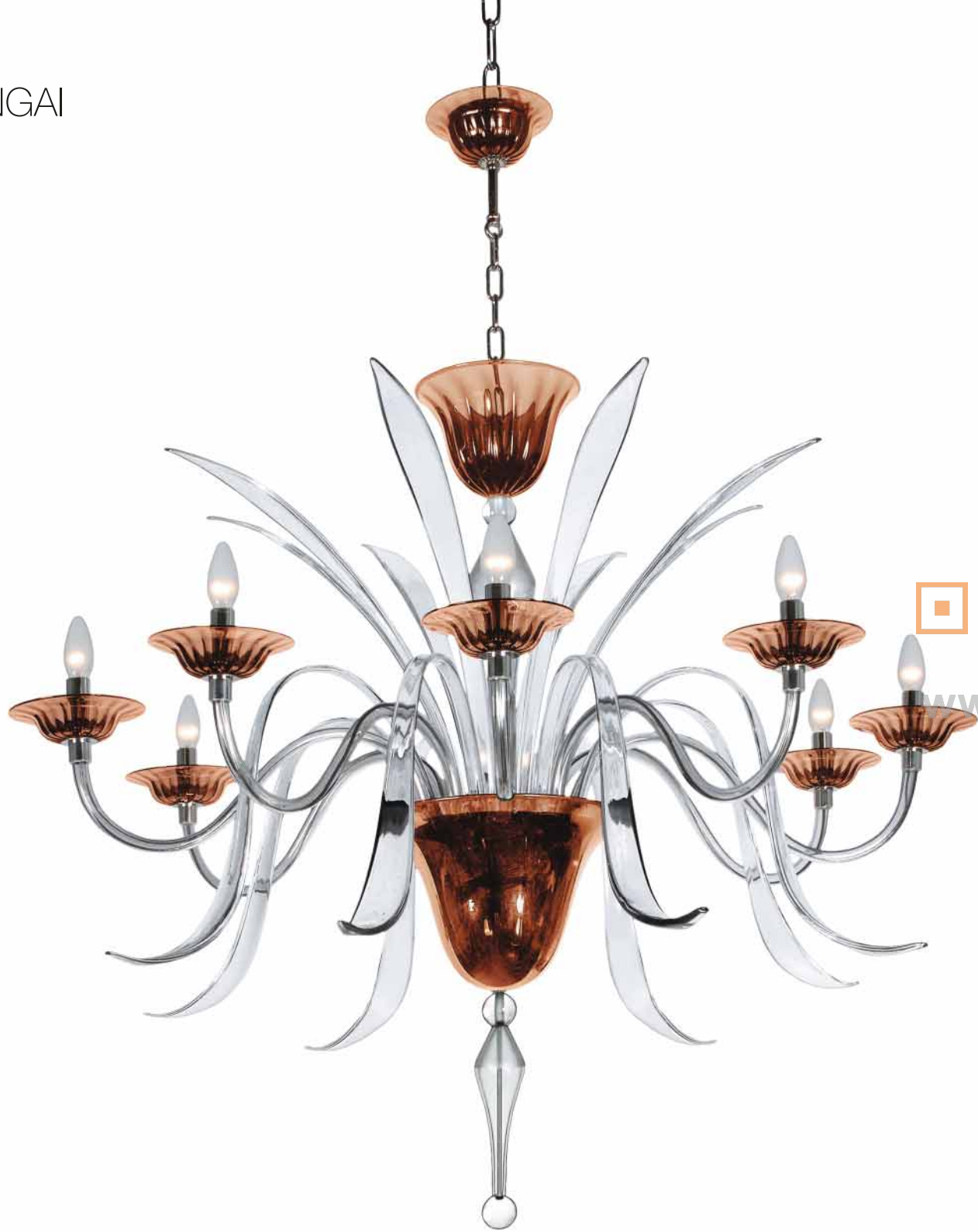

32

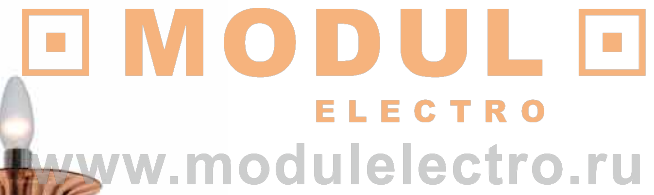
 **MODUL**  
ELECTRO  
[www.modulelectro.ru](http://www.modulelectro.ru)

h cm 100 x Ø cm 110 - h 39 1/3" x Ø 43 1/3"



33

SHANGAI



h cm 140 x Ø cm 118 - h 55" x Ø 46 1/2" - see page 146

# DEHLI

Forma Giulia Rioda

34



 **MODUL**   
ELECTRO  
[www.modulelectro.ru](http://www.modulelectro.ru)

35

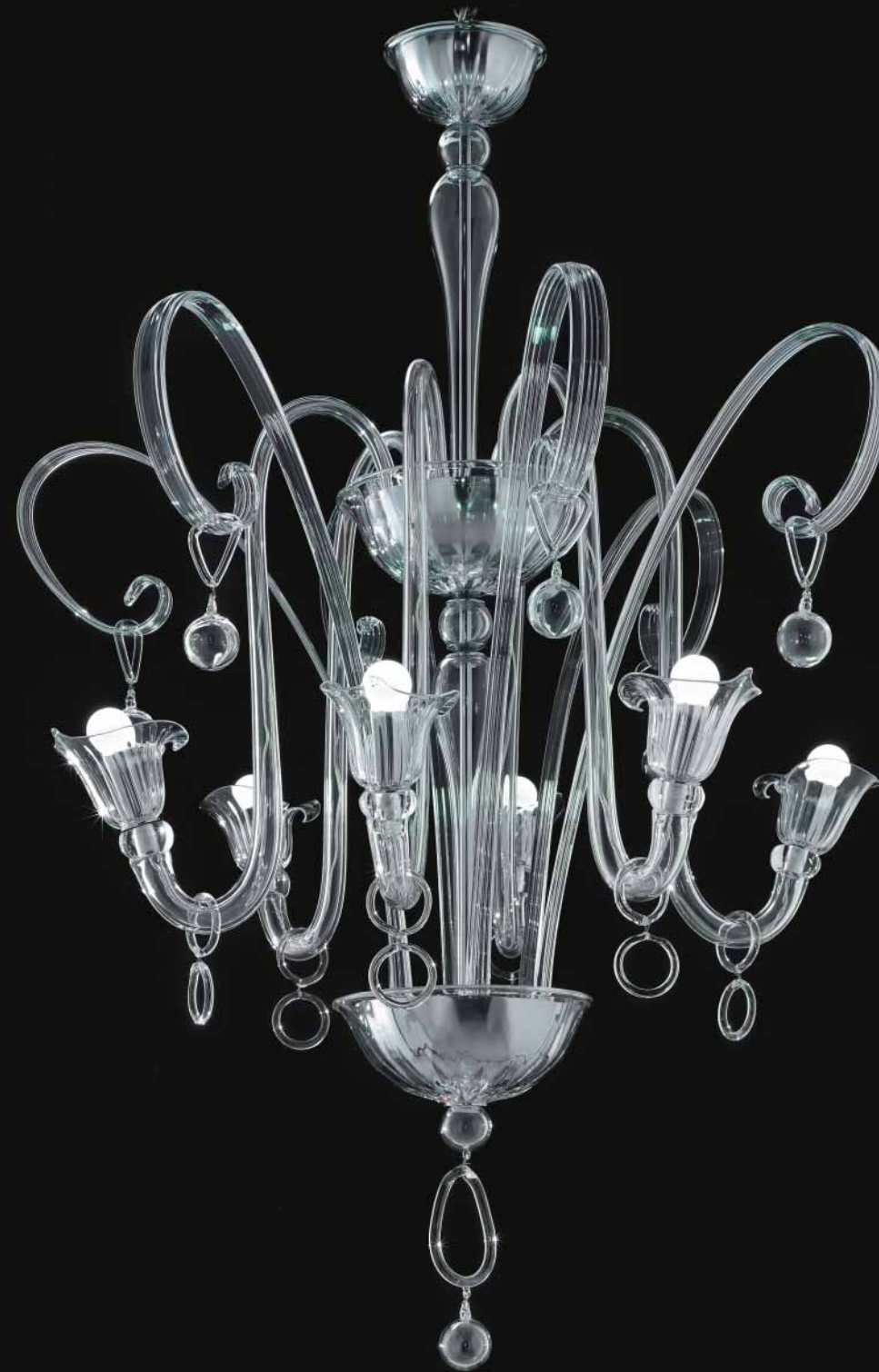

DEHLI



h cm 125 x Ø cm 110 - h 49 1/3" x Ø 43 1/3" - see page 138

# INFERNO

design Giorgio Barera

36



 **MODUL**   
ELECTRO  
[www.modulelectro.ru](http://www.modulelectro.ru)

37





INFERNO

h cm 120 x Ø cm 90 - h 47 1/4" x Ø 35 1/2" - see page 140

INFERNO

38

 **MODUL**   
ELECTRO  
[www.modulelectro.ru](http://www.modulelectro.ru)



39

INFERNO

h cm 120 x Ø cm 90 - h 47 1/4" x Ø 35 1/2" - see page 140

# TOKYO

design Giulia Rioda



MODULO  
ELECTRO  
www.electro.ru



TOKYO

h cm 113 x Ø cm 90 - h 44 1/2" x Ø 35 1/2" - see page 148

# DUBLINO

design Giulia Rioda

42

 **MODULE**  
ELECTRO  
[www.modulelectro.ru](http://www.modulelectro.ru)



43

DUBLINO

h cm 110 x Ø cm 110 - h 43 1/3" x Ø 43 1/3" - see page 139

DUBLINO



44

MODULO  
ELECTRO  
www.modulelectro.ro



45

DUBLINO

h cm 110 x Ø cm 110 - h 43 1/3" x Ø 43 1/3" - see page 139



# ONE THOUSAND AND ONE NIGHT

design Hilton McConnico



46

**MODUL**  
ELECTRO  
[www.modulelectro.ru](http://www.modulelectro.ru)



47

## ONE THOUSAND AND ONE NIGHT

limited edition 50 pieces - h cm 105+30 x Ø cm 50 - h 41 1/3" +12" x Ø 19 2/3" - see page 144

# ONE THOUSAND AND ONE NIGHT

design Hilton McConnico

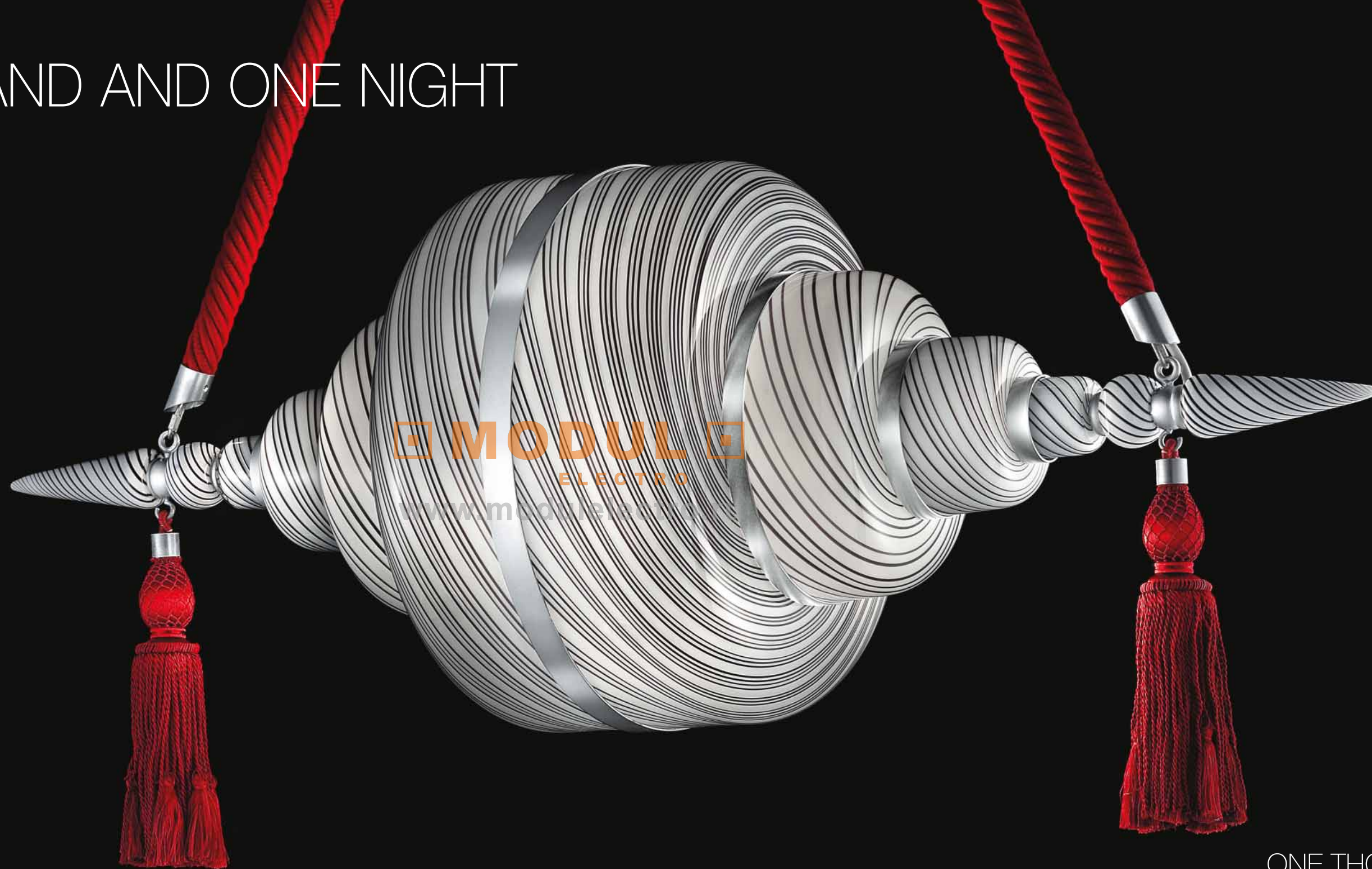

MODUL  
ELECTRO  
[www.modulelectro.com](http://www.modulelectro.com)

48

49



ONE THOUSAND  
AND ONE NIGHT

limited edition 10 pieces - h cm 134+30 x Ø cm 50 x l cm 105 - h 52 3/4" + 12" x Ø 19 2/3" x l 41 1/3" - see page 144

# CHILDHOOD MEMORIES

design Hilton McConnico

50



 **MODULO**  
ELECTRO  
[www.modulelectro.ru](http://www.modulelectro.ru)



51

CHILDHOOD MEMORIES

h cm 100 x Ø cm 55 - h 39 1/3" x Ø 21 2/3" - see page 137

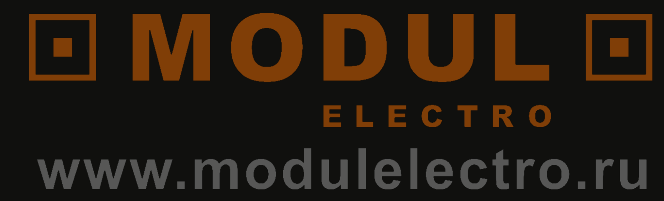

INNOVATIVE DESIGN

# VERSAILLES

Fornia Design Studio

LED  
technology

  
ELECTRO  
[www.modulelectro.ru](http://www.modulelectro.ru)

54

55



VERSAILLES

h cm 265 x Ø cm 220 - h 104" x Ø 86 1/2" - see page 148

# STARS OF ISTANBUL

Fornia Design Studio

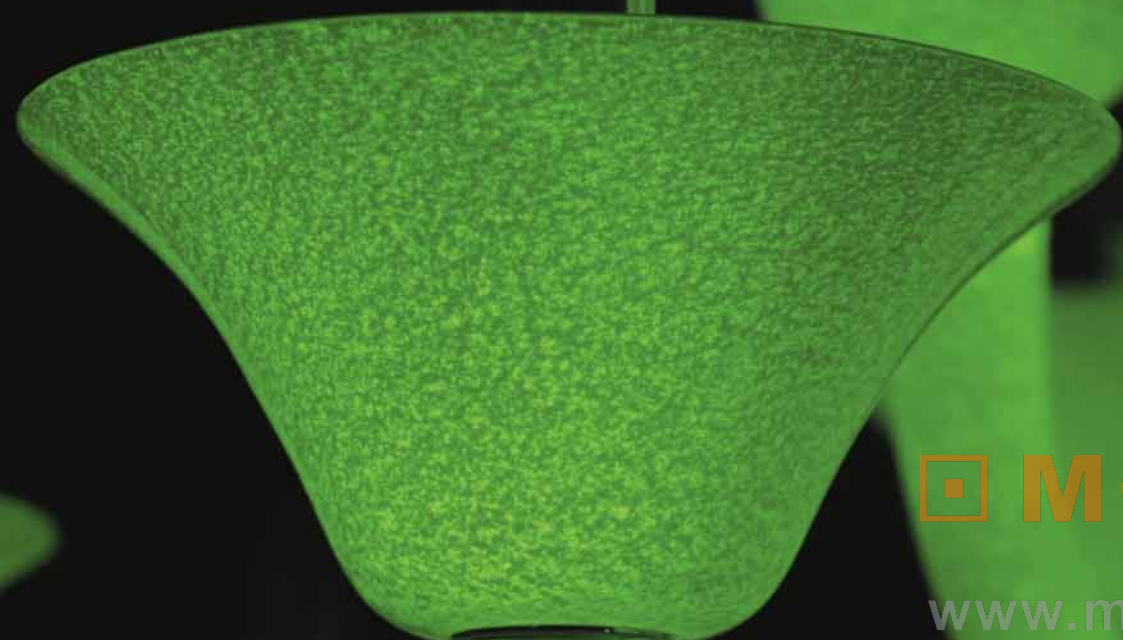

**MODUL**  
ELECTRO  
[www.modulelectro.ru](http://www.modulelectro.ru)

FLUORESCENT GLASS  
technology

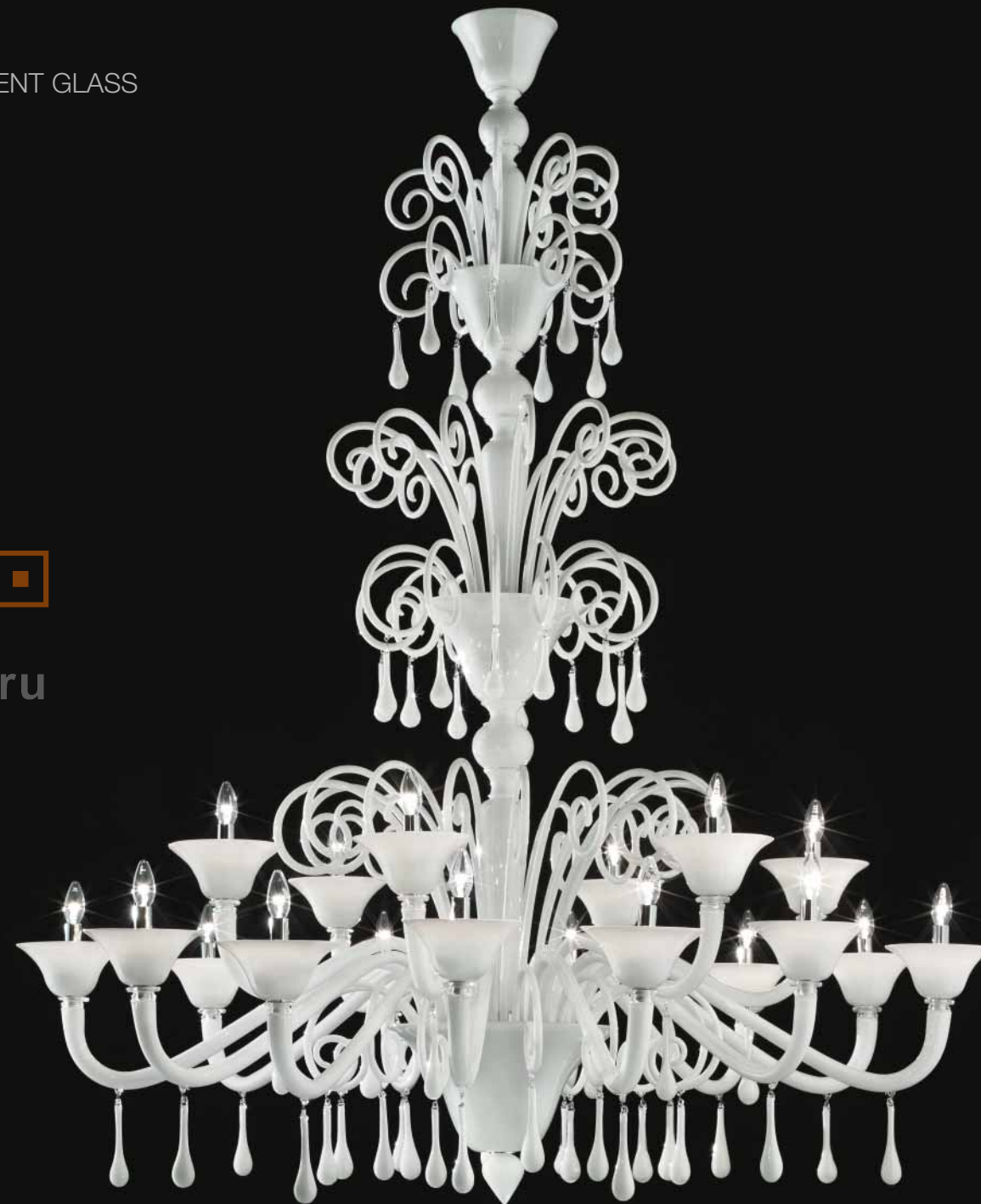



STARS of ISTANBUL

h cm 200 x Ø cm 165 - h 78 3/4" x Ø 65" - see page 147

# KIEV STARDUST

Fornia Design Studio

FLUORESCENT GLASS  
technology

 **MODUL**   
ELECTRO  
[www.modulelectro.ru](http://www.modulelectro.ru)



KIEV STARDUST

h cm 90 x Ø cm 82 - h 35 1/2" x Ø 32 1/4" - see page 141

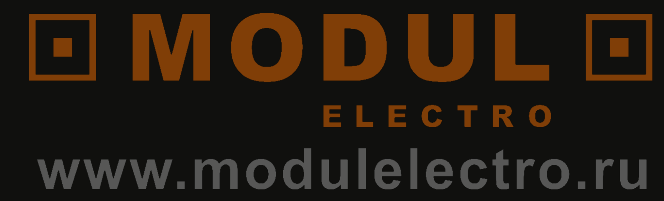

ART DÉCO DESIGN





MODUL  
ELECTRO  
www.modulelectro.ru



# MONTREAL

design Denise Gemin



64

 **MODULO**   
ELECTRO

[www.modulelectro.it](http://www.modulelectro.it)



65

MONTREAL

h cm 90 x Ø cm 96 - h 35 1/2" x Ø 37 3/4" - see page 143

# CHICAGO

Formia Design Studio

66



**MODUL**  
ELECTRO  
[www.modulelectro.ru](http://www.modulelectro.ru)

67



# CHICAGO

h cm 80 x Ø cm 90 - h 31 1/2" x Ø 35 1/2" - see page 137

# MANHATTAN

Formia Design Studio

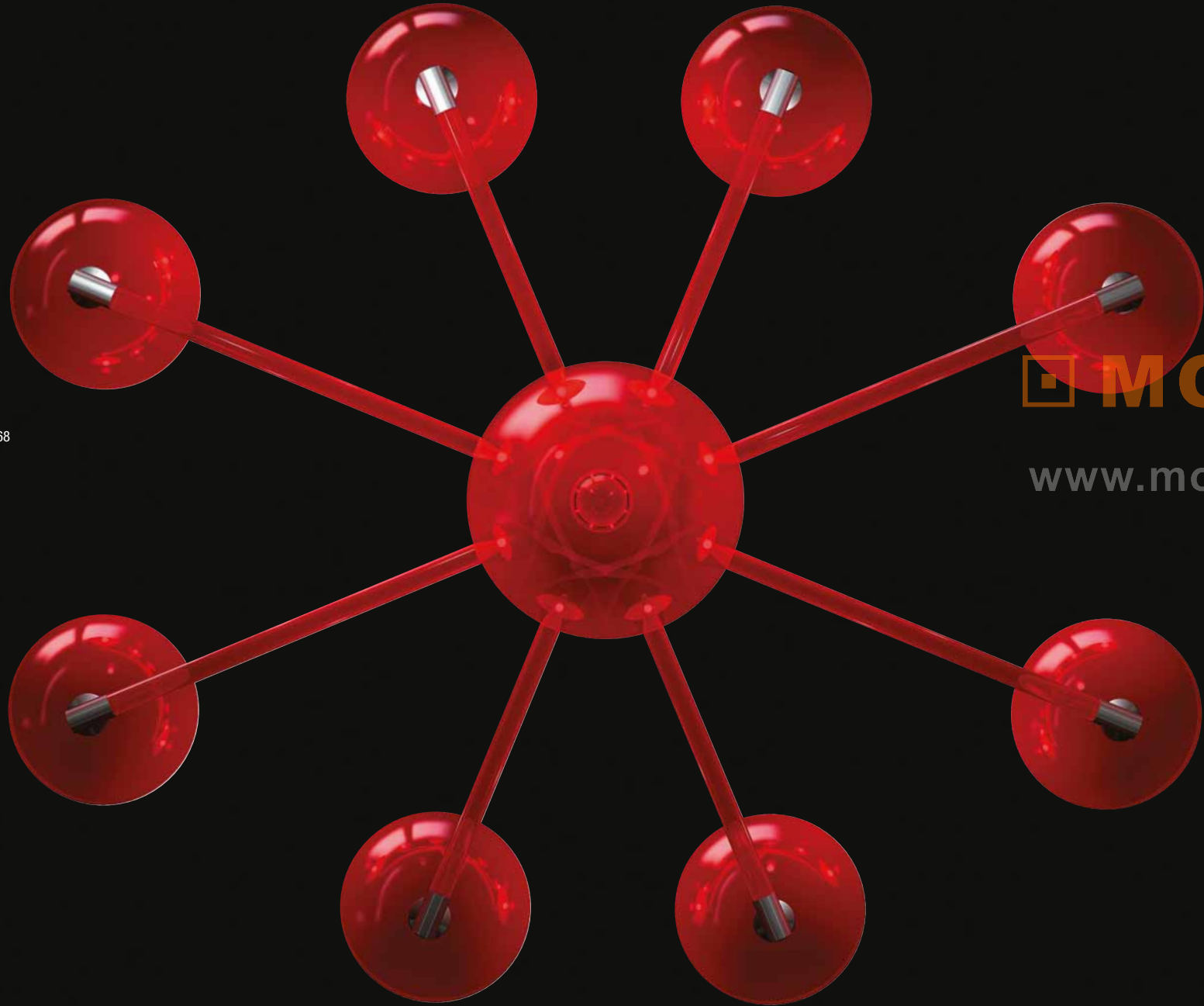

68

 **MODUL**   
ELECTRO  
[www.modulelectro.ru](http://www.modulelectro.ru)

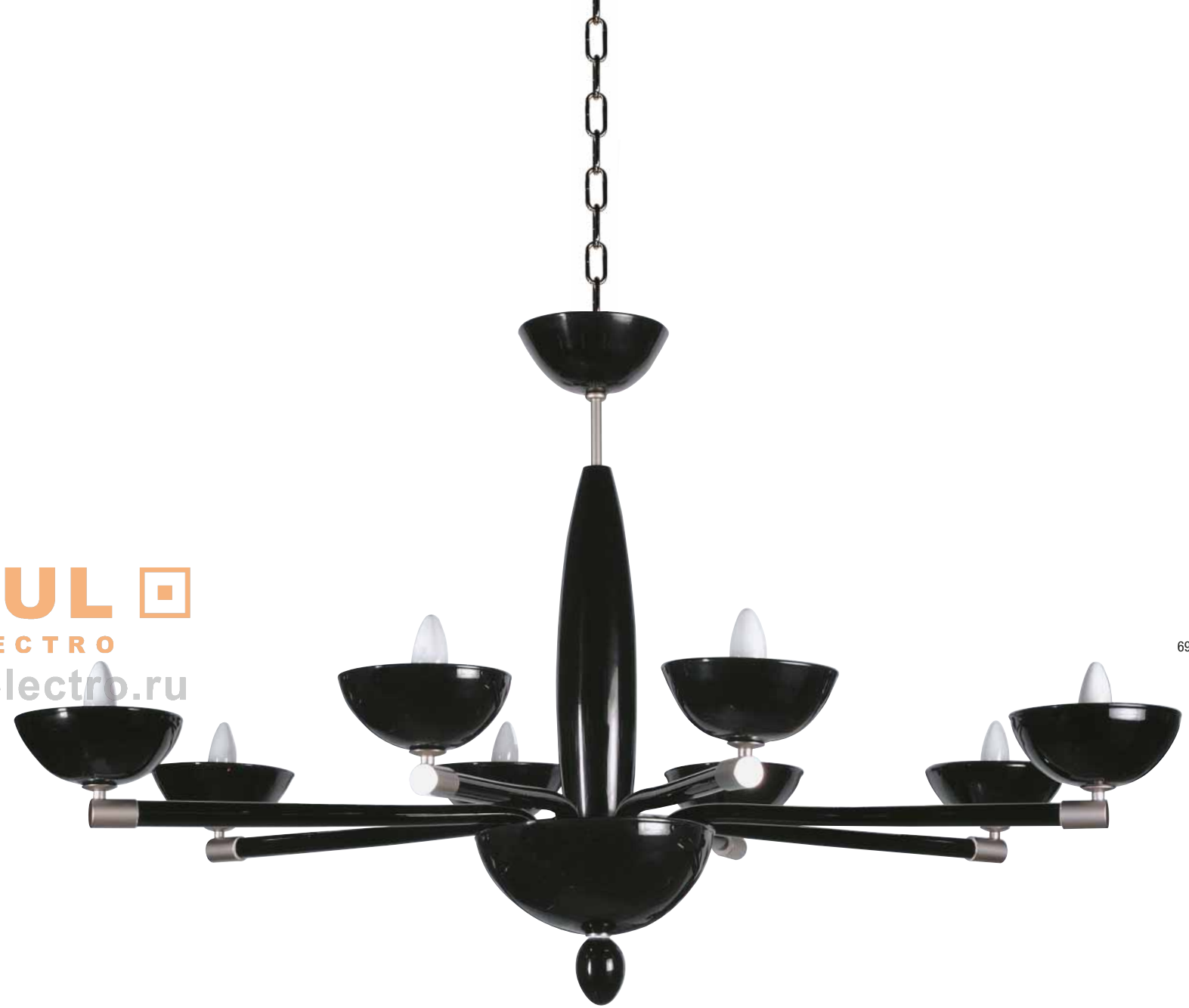

69

MANHATTAN

h cm 80 x Ø cm 120 x 74 - h 31 1/2" x Ø 47 1/4 x 29 1/4" - see page 142

# BERLINO

Formia Design Studio



70

**MODUL**  
ELECTRO  
[www.modulelectro.ru](http://www.modulelectro.ru)



71

BERLINO

h cm 71 x Ø cm 70 - h 28" x Ø 27 1/2" - see page 137

# MARIENBAD

Formia Design Studio



72

**MODUL**  
ELECTRO  
[www.modulelectro.ru](http://www.modulelectro.ru)



73

MARIENBAD

h cm 102 x Ø cm 85 - h 40" x Ø 33" - see page 142



**MODULE**  
ELECTRO  
[www.modulestro.ru](http://www.modulestro.ru)



PRAGA

Formia Design Studio

76

  
www.modulelectro.eu

77

PRAGA

h cm 65 x Ø cm 90 - h 25 2/3" x Ø 35 1/2" - see page 145



PALAZZO

Formia Design Studio



78

MODULO  
ELECTRO  
www.modulelectro.ru



79

PALAZZO



h cm 85 x Ø cm 100 - h 33 1/2" x Ø 39 1/3" - see page 144

MODUL  
ELECTRO  
[www.modulelectro.ru](http://www.modulelectro.ru)



MILANO  
Formia Design Studio

82

 **MODUL**   
ELECTRO  
[www.modulelectro.ru](http://www.modulelectro.ru)



83

MILANO

h cm 70 x Ø cm 70 - h 27 1/2" x Ø 27 1/2" - see page 143

NANCY  
Formia Design Studio

84

  
ELECTRO  
[www.modulelectro.ru](http://www.modulelectro.ru)

85



NANCY

h cm 180 x Ø cm 160 - h 70 3/4" x Ø 63" - see page 143

# POMPEI

Formia Design Studio



86

**MODUL**  
ELECTRO  
[www.modulelectro.ru](http://www.modulelectro.ru)



87

POMPEI



h cm 210 x Ø cm 180 - h 82 2/3" x Ø 70 3/4" - see page 144

# FIRENZE

design Maria Teresa Gaudenzi

88



 **MODUL**   
ELECTRO  
[www.modulelectro.ru](http://www.modulelectro.ru)

89





FIRENZE

h cm 70 x Ø cm 50 - h 27 1/2" x Ø 19 2/3" - see page 139

PARIGI  
design Denise Gemin

90

 **MODUL**   
ELECTRO  
[www.modulelectro.ru](http://www.modulelectro.ru)



91

PARIGI

h cm 100 x Ø cm 70 - h 39 1/2" x Ø 27 1/2" - see page 145

# VIENNA

design Denise Gemin

92



**MODUL**  
ELECTRO  
[www.modulselectro.ru](http://www.modulselectro.ru)

93



# VIENNA

h cm 135 x Ø cm 73 - h 53 1/4" x Ø 28 3/4" - see page 149



 **MODUL**  WALL & TABLE & FLOOR  
ELECTRO  
DESIGN  
[www.modulelectro.ru](http://www.modulelectro.ru)

# CAPRI

design Denise Gemin

96



**MODUL**  
ELECTRO  
[www.modulelectro.ru](http://www.modulelectro.ru)

97



CAPRI

h cm 80 x Ø cm 65 - h 31 1/2" x Ø 25 1/2" - see page 137

# DOHA

design Giorgio Barera

98



**MODUL**  
ELECTRO  
[www.modulelectro.ru](http://www.modulelectro.ru)

99



DOHA  
h cm 70 - h 21 1/2" - see page 138

# TRANSILVANIA

design Giorgio Barera

100

**MODUL**  
ELECTRO  
[www.modulelectro.ru](http://www.modulelectro.ru)

101

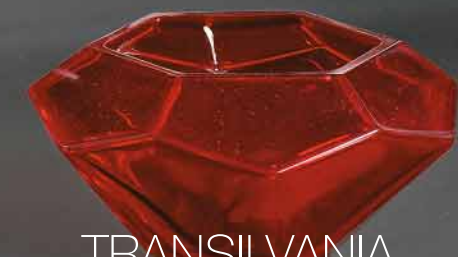

TRANSILVANIA

h cm 60 x Ø cm 58 - h 23 2/3" x Ø 23" - see page 147

# TRIPODE

design Denise Gemin



h cm 70 x l cm 16 - h 27 1/2" x l 6 1/8"

**MODUL**  
ELECTRO  
[www.modulelectro.ru](http://www.modulelectro.ru)



# TRIPODE

h cm 64 x l cm 27 - h 25 1/4" x l 10 2/3" - see page 148

# DIAMANTI

design Denise Gemin & Giorgio Barera



**MODUL**  
ELECTRO  
[www.modulelectro.ru](http://www.modulelectro.ru)



h cm 12 x l cm 11 - h 4 2/3" x l 4 1/3"



# DIAMANTI

h cm 80 x Ø cm 39 - h 31 1/2" x Ø 15 1/3" - see page 138

BALI  
design Denise Gemin



106

**MODUL**  
ELECTRO  
[www.modulelectro.ru](http://www.modulelectro.ru)

h cm 43 x l cm 49 - h 17" x l 19 1/3"



107



BALI

h cm 73 x Ø cm 38 - h 28 3/4" x Ø 15" - see page 136

# GLASGOW

design Giulia Rioda

108

 **MODUL**   
ELECTRO  
[www.modulelectro.ru](http://www.modulelectro.ru)



109

GLASGOW

h cm 81 x Ø cm 52 - h 32" x Ø 20 1/2" - see page 140





**MODUL**  
ELECTRO  
[www.modulelectro.ru](http://www.modulelectro.ru)



h cm 72 - h 28 1/3"

# MONTREAL



design Denise Gemin



112

h cm 100 x Ø cm 32 - h 39 1/3" x Ø 12 1/2" - see page 143



 **MODUL**   
ELECTRO  
[www.modulelectro.ru](http://www.modulelectro.ru)

# MANHATTAN

Formia Design Studio

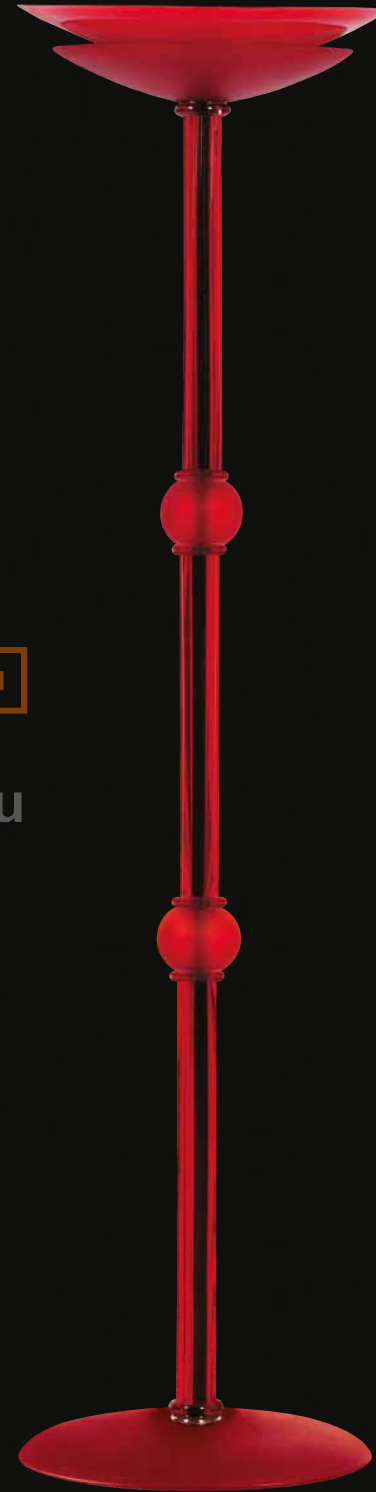



h cm 185 x Ø cm 50 - h 72 3/4" x Ø 19 3/4"





113

h cm 70 x Ø cm 40 - h 27 1/2" x Ø 15 3/4" - see page 142



 **MODUL**   
ELECTRO  
[www.modulelectro.ru](http://www.modulelectro.ru)



 **MODUL**   
ELECTRO  
[www.modulelectro.ru](http://www.modulelectro.ru)



# FIRENZE

design Maria Teresa Gaudenzi

118

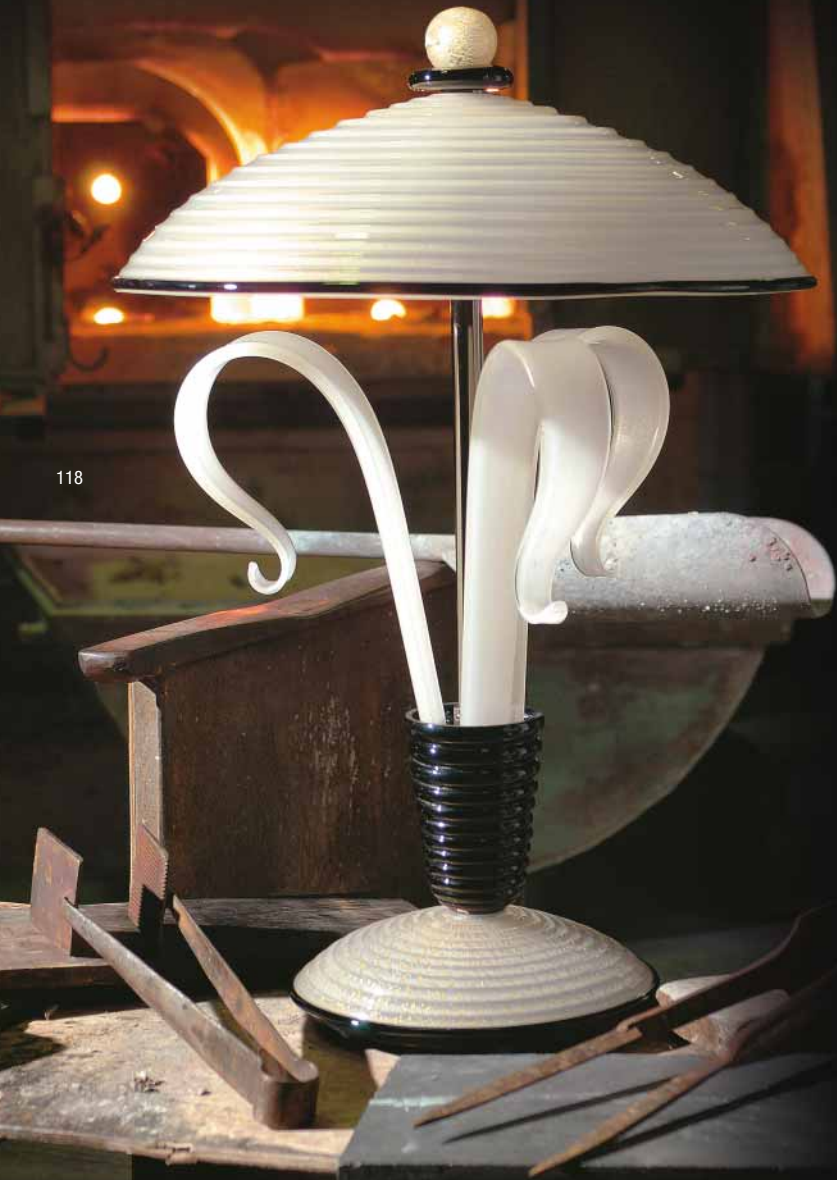

h cm 60 x Ø cm 50 - h 23 1/2" x Ø 19 2/3"



h cm 47 x l cm 35 - h 18 1/2" x l 13 2/3"

**MODUL**  
ELECTRO  
[www.modulelectro.ru](http://www.modulelectro.ru)

119



FIRENZE

h cm 185 x Ø cm 50 - h 72 2/3" x Ø 19 2/3" - see page 139

# PARIGI

design Denise Gemin

120



h cm 78 x Ø cm 50 - h 30 3/4" x Ø 19 2/3"

**MODUL**  
ELECTRO  
[www.modulelectro.ru](http://www.modulelectro.ru)

121



PARIGI  
h cm 180 x Ø cm 68 - h 70 3/4" x Ø 26 3/4" - see page 145

# VIENNA

design Denise Gemin



122

**MODUL**  
ELECTRO  
[www.modulelectro.ru](http://www.modulelectro.ru)

h cm 73 x Ø cm 73 - h 28 3/4" x Ø 28 3/4"



123

VIENNA

h cm 180 x Ø cm 73 - h 70 3/4" x Ø 28 3/4"



h cm 74 x l cm 73 - h 29" x l 28 3/4" - see page 149

# SHANGAI

design Giulia Rioda

124



 **MODUL**   
ELECTRO  
[www.modulelectro.ru](http://www.modulelectro.ru)

125



SHANGAI

h cm 178 x Ø cm 55 - h 70 3/4" x Ø 21 2/3" - see page 146



# SHIRAZ

design Giulia Rioda

126

**MODUL**  
ELECTRO  
[www.modulelectro.ru](http://www.modulelectro.ru)

127





SHIRAZ

h cm 187 x Ø cm 66 - h 73 2/3" x Ø 26" - see page 146

MIAMI  
design Hilton McConnico

128



 **MODUL**   
ELECTRO  
[www.modulelectro.ru](http://www.modulelectro.ru)

129



MIAMI

h cm 60 x Ø cm 16 - h 23 2/3" x Ø 6 1/3" - see page 142

# ONE THOUSAND AND ONE NIGHT

design Hilton McConnico



**MODUL**  
ELECTRO  
[www.modulelectro.ru](http://www.modulelectro.ru)



ONE THOUSAND  
AND ONE NIGHT

h cm 64+30 x Ø cm 20 - h 25 1/4" + 12" x Ø 8" - see page 144

# CHILDHOOD MEMORIES

design Hilton McConnico



132

h cm 28 x Ø cm 30 - h 11" x Ø 12"

**MODUL**  
ELECTRO  
[www.modulelectro.ru](http://www.modulelectro.ru)



133

Ø cm 26 - Ø 10 1/4"

CHILDHOOD MEMORIES

Ø cm 33 - Ø 13" - see page 137

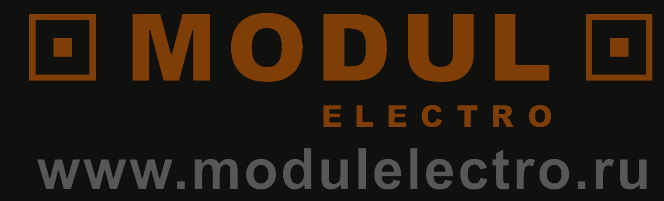

TECHNICAL DATA

## BERLINO

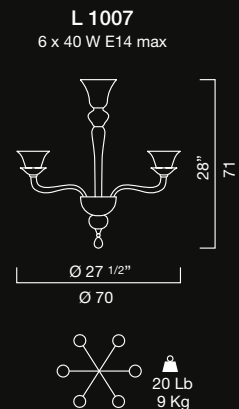

colori suggeriti:  
Rosso, Nero, Cristallo,  
Verde, Acqua chiaro, Bianco

suggested colors:  
Red, Black, Crystal,  
Green, Light Aqua, White

applique  
disponibile su richiesta

sconce lamp  
available on request

## CAPRI

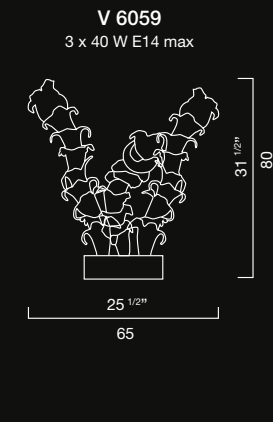
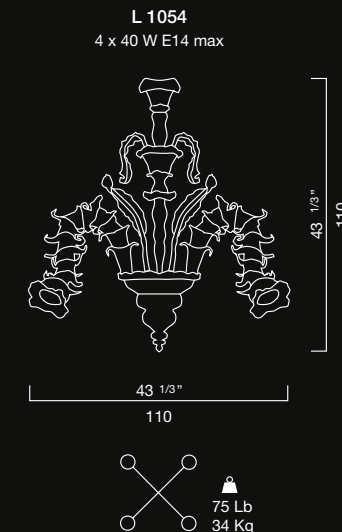

colori suggeriti:  
Cristallo

suggested colors:  
Crystal

## BALI

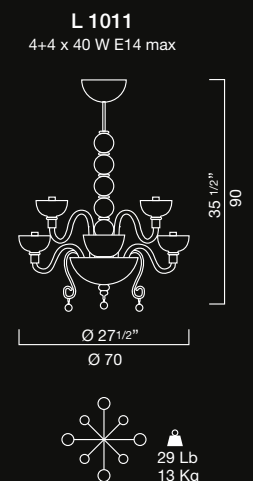
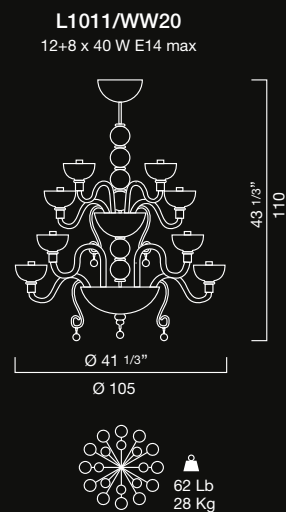
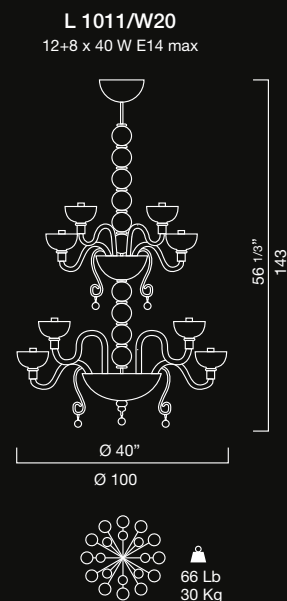

colori suggeriti:  
Nero, Cristallo,  
Blu Grigio

suggested colors:  
Black, Crystal,  
Blue Grey

piantana  
disponibile su richiesta

standing lamp  
available on request

**MODUL**  
ELECTRO  
CHICAGO  
www.modulelectro.ru

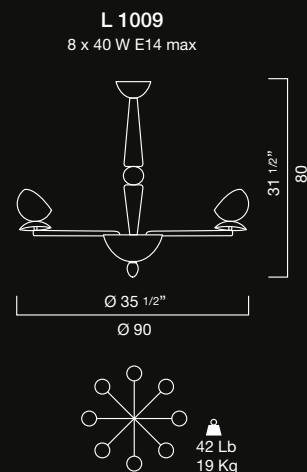

colori suggeriti:  
Cristallo/Cristallo satinato,  
Cristallo/Rubino chiaro/ Rubino chiaro satinato

suggested colors:  
Crystal/Crystal satin,  
Crystal/Light Ruby/Light Ruby Satin

## CHILDHOOD MEMORIES

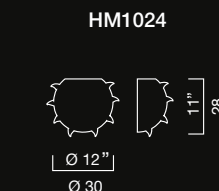
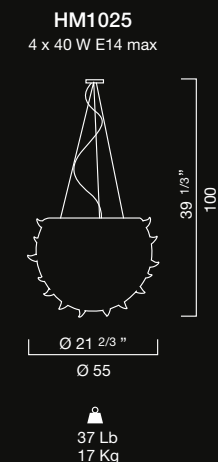

## DEHLI

**L 1028**

6 x 40 W E14 max

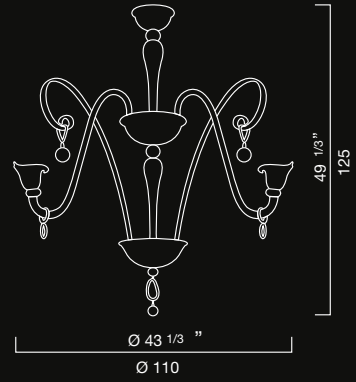

colori suggeriti:  
Nero, Viola,  
Cristallo, Rosso

suggested colors:  
Black, Violet,  
Crystal, Red

applique e piantana  
disponibili su richiesta

sconce  
and standing lamp  
available on request

## DEHLI

**V 6057/G**

1 x 40 W E27 max

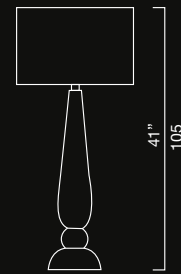

**V 6057**

1 x 40 W E14 max

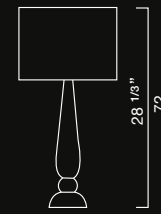

colori suggeriti:  
Nero, Viola,  
Cristallo, Oro

suggested colors:  
Black, Violet,  
Crystal, Gold

## DUBLINO

**L 1017**

8 x 40 W E14 max

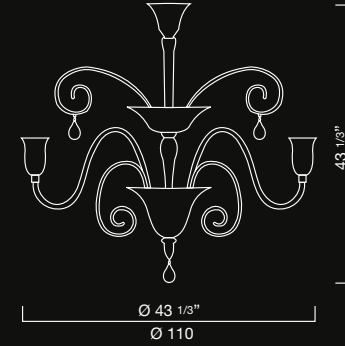

colori suggeriti:  
Cristallo/Verde/Verde scuro,  
Cristallo/Rosso,  
Cristallo/Nero

suggested colors:  
Crystal/Green/Dark Green,  
Crystal/Red,  
Crystal/Black

applique e piantana  
disponibili su richiesta

sconce and standing lamp  
available on request

## ESTE

**V 6021**

1 x 40 W E27 max

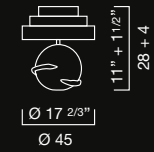

**paralume  
shade**

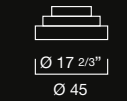

colori suggeriti:  
Rosso/Morisa Cristallo

suggested colors:  
Red/Crystal decoration

**70931/3**  
avorio/nero/avorio  
ivory/black/ivory

**70932/3**  
nero/rosso/avorio  
black/red/ivory

## DIAMANTI

**V 6046**

1 x 40 W E27 max

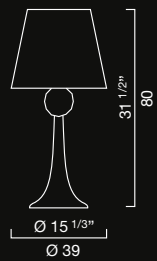

colori suggeriti:  
Cristallo/Nero

suggested colors:  
Crystal/Black

**M 80130**

1 x 60 W G9 max



## DOHA

**L 1029/W12**

12 x 40 W E14 max

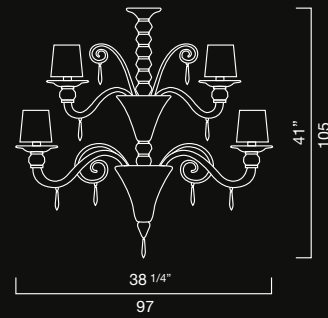

**V 6061**

1 x 40 W E14 max



colori suggeriti:  
Nero/Cristallo

suggested colors:  
Black/Crystal

applique  
e piantana  
disponibili  
su richiesta

sconce and  
standing  
lamp  
available  
on request

**MODUL**  
ELECTRO  
FIRENZE  
www.modulelectro.ru

**L 1003**

3 x 40 W E14 max

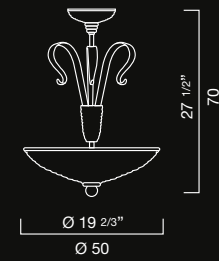

**V 6032**

3 x 40 W E14 max

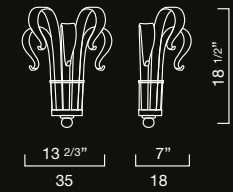

**V 6031**

3 x 40 W E14 max

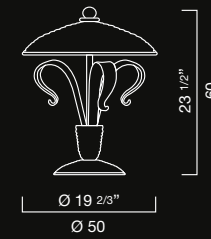

**V 6030**

1 x 60 W E27 max

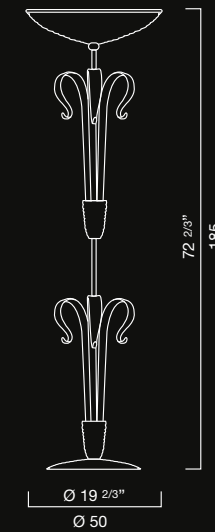

colori suggeriti:  
Seta Oro/Nero,  
Nero/Seta Oro

suggested colors:  
Silk Gold/Black,  
Black/Silk Gold

# FONTANA vs FONTANA

**L 1024/BIS**  
54+54 x 5 W G4 max

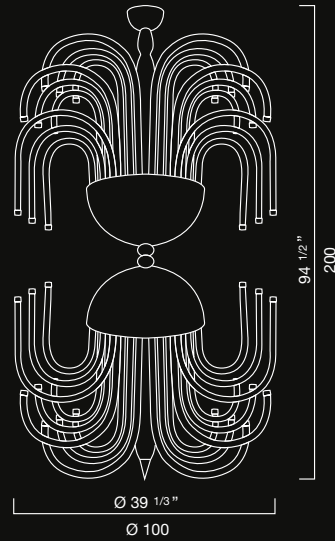

colori suggeriti:  
Cristallo,  
Blu Grigio

suggested colors:  
Crystal,  
Blue Grey

94 1/2"

200

Ø 39 1/3"

Ø 100

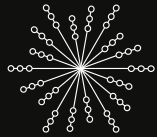

242 Lb  
110 Kg

# GLASGOW

**L 1027/APPLIQUE**  
5 x 40 W E14 max

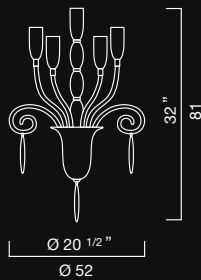

colori suggeriti:  
Nero, Cristallo,  
Bianco/Cristallo

suggested colors:  
Black, Crystal,  
White/Crystal

32"

81

Ø 20 1/2"

Ø 52

# FONTANA

**L 1024**  
54 x 5 W G4 max

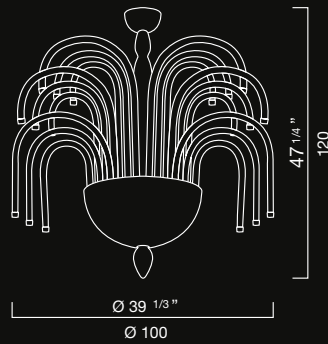

colori suggeriti:  
Cristallo,  
Blu Grigio

suggested colors:  
Crystal,  
Blue Grey

47 1/4"

120

Ø 39 1/3"

Ø 100

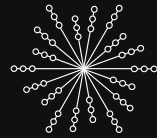

119 Lb  
54 Kg

# INFERNO

**L 1052**  
6+3 x 40 W E14 max

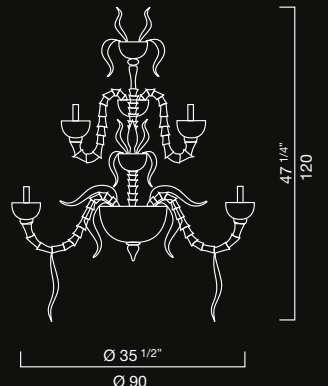

colori suggeriti:  
Cristallo/Viola,  
Nero/Ambra/Rosso

suggested colors:  
Crystal/Violet  
Black/Ambra/Red

47 1/4"

120

Ø 35 1/2"

Ø 90



60 Lb  
27 Kg

applique  
disponibile su richiesta

sconce lamp  
available on request

# ISTANBUL

**L 1014/H12**  
6+6 x 40 W E14 max

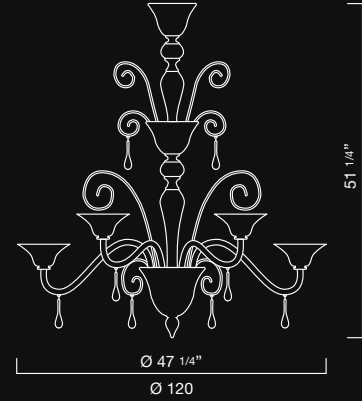

51 1/4"

130

Ø 47 1/4"

Ø 120



66 Lb  
30 Kg

**L 1014/6**  
6 x 40 W E14 max

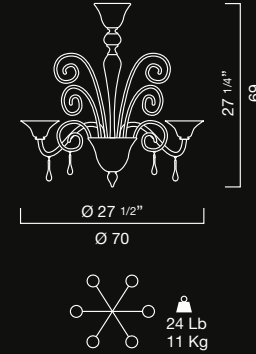

27 1/4"

69

Ø 27 1/2"

Ø 70

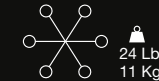

24 Lb  
11 Kg

colori suggeriti:  
Viola, Rosso, Cristallo,  
Rubino scuro, Bianco,  
Bianco/Cristallo

suggested colors:  
Violet, Red, Crystal,  
Dark Ruby, White,  
White/Crystal

applique, piantana  
e flambeau  
disponibili su richiesta

sconce, standing lamp  
and flambeau  
available on request

# KIEV

**L 1008**  
6 x 40 W E14 max

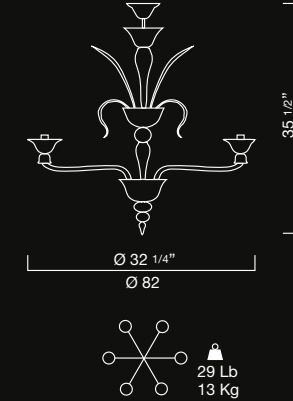

35 1/2"

90

Ø 32 1/4"

Ø 82



29 Lb  
13 Kg

colori suggeriti:  
Bianco/Nero,  
Nero/Bianco

suggested colors:  
Black/White,  
White/Black

applique  
disponibile su richiesta

sconce lamp  
available on request

# MODUL

ELECTRO

www.modulelectro.ru

# KIEV STARDUST

**L 1008/NZ**  
6 x 40 W E14 max

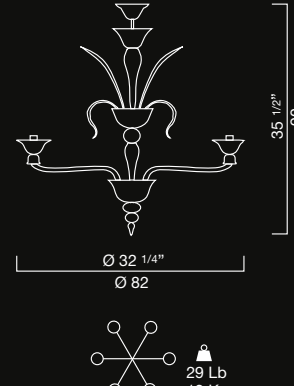

colori suggeriti:  
decoro Fosforescente

suggested colors:  
Fosforescent decoration

35 1/2"

90

Ø 32 1/4"

Ø 82



29 Lb  
13 Kg

# LONDRA

**L 1006**  
6 x 40 W E14 max

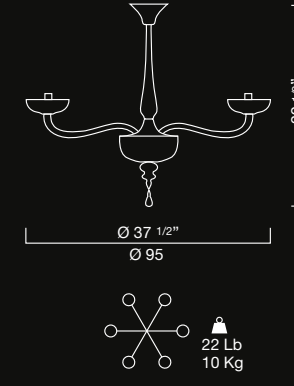

29 1/2"

75

Ø 37 1/2"

Ø 95

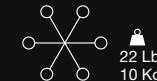

22 Lb  
10 Kg

colori suggeriti:  
Rosso, Acqua chiaro,  
Cristallo, Blu Grigio,  
Bianco

suggested colors:  
Red, Light Aqua,  
Crystal, Blue Grey,  
White

applique  
disponibile su richiesta

sconce lamp  
available on request



# MANHATTAN

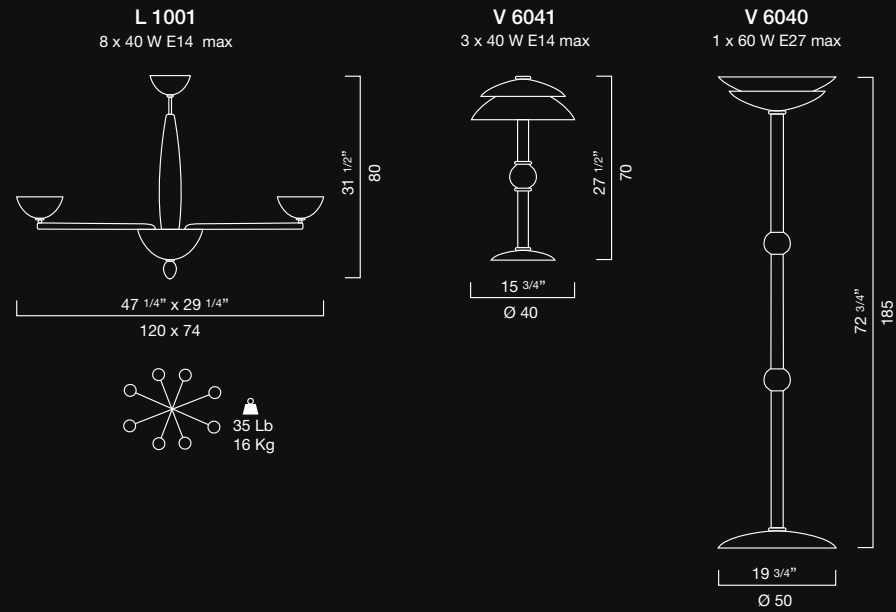

colori suggeriti:

Blu Grigio,  
Rosso, Nero

suggested colors:

Blue Grey,  
Red, Black

# MILANO

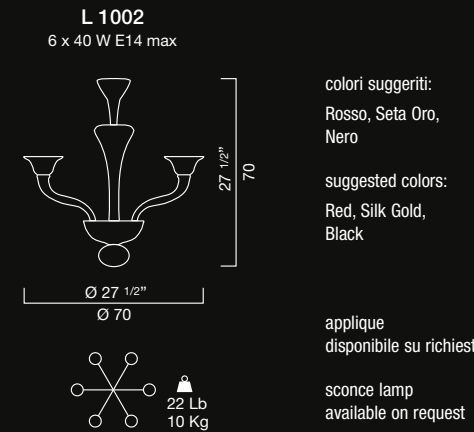

colori suggeriti:

Rosso, Seta Oro,  
Nero

suggested colors:

Red, Silk Gold,  
Black

applique  
disponibile su richiesta

sconce lamp  
available on request

# MONTREAL

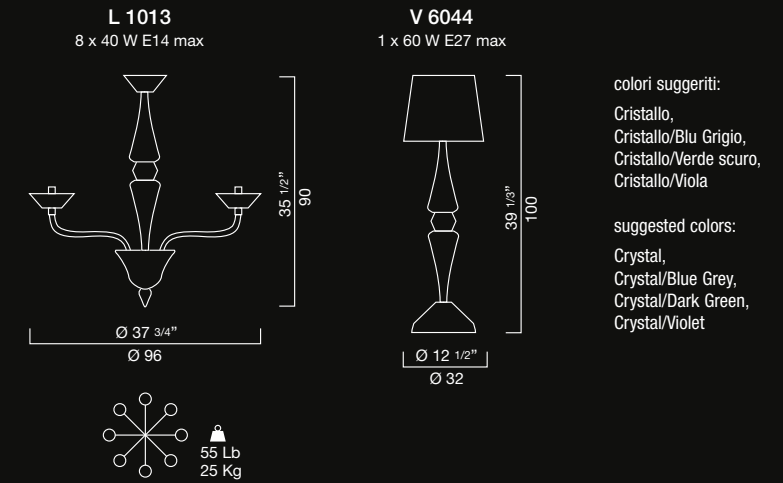

colori suggeriti:

Cristallo,  
Cristallo/Blu Grigio,  
Cristallo/Verde scuro,  
Cristallo/Viola

suggested colors:

Crystal,  
Crystal/Blue Grey,  
Crystal/Dark Green,  
Crystal/Violet

# MARIENBAD

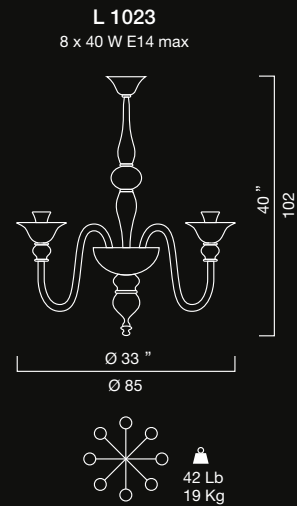

colori suggeriti:

Acciaio/Arancio,  
Cristallo/Nero,  
Acciaio/Viola

suggested colors:

Steel/Orange,  
Crystal/Black,  
Steel/Violet

applique e piantana  
disponibili  
su richiesta

sconce  
and standing lamp  
available on request

# MARS

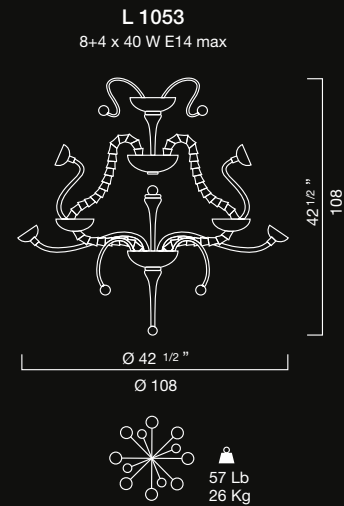

colori suggeriti:

Cristallo/Bianco,  
Cristallo/Nero, Nero

suggested colors:

Crystal/White,  
Crystal/Black, Black

applique  
disponibile su richiesta

sconce lamp  
available on request

# MODULO ELECTRO

# MIAMI

HM1027

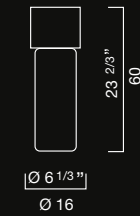

**L 1021**  
24 x 40 W E14 max

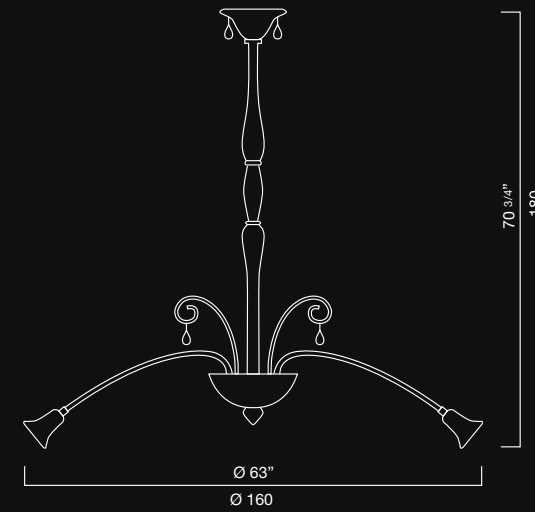

colori suggeriti:

Cristallo,  
Acciaio

suggested colors:

Crystal,  
Steel

applique  
disponibile  
su richiesta

sconce lamp  
available  
on request

# NEW YORK

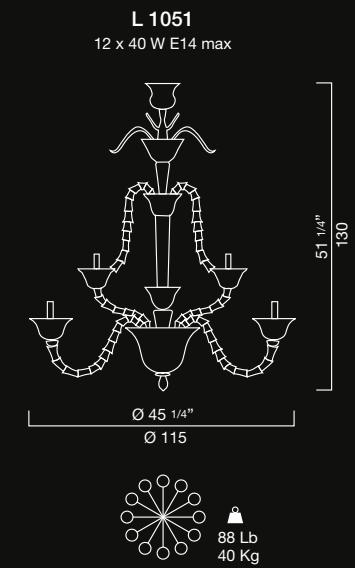

colori suggeriti:

Blu Grigio,  
Rubino scuro

suggested colors:

Blue Grey,  
Dark Ruby

applique  
disponibile su richiesta

sconce lamp  
available on request

# ONE THOUSAND AND ONE NIGHT

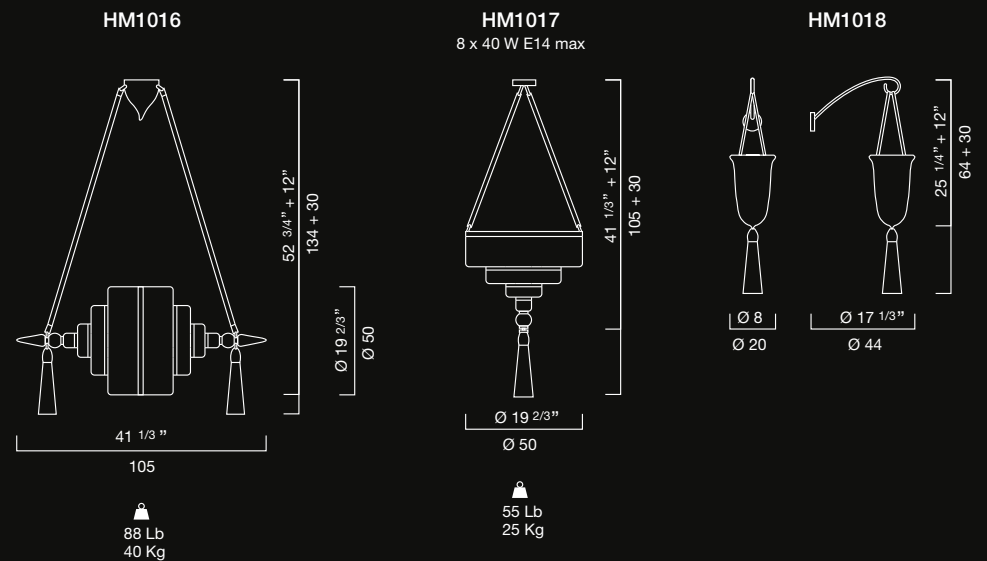

# PARIGI

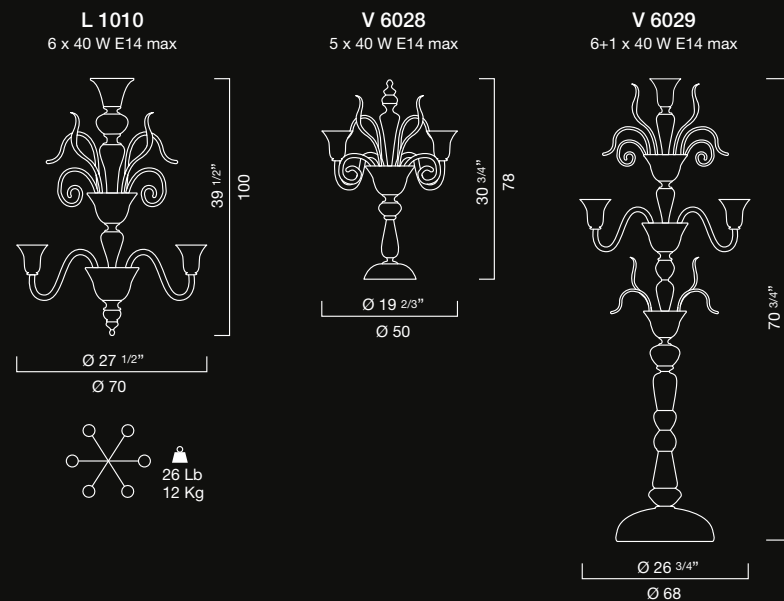

colori suggeriti:  
Cristallo specchiato, Ambra specchiato,  
Ametista specchiato, Nero

suggested colors:  
Crystal mirror finishing, Amber mirror finishing,  
Amethyst mirror finishing, Black

applique disponibile su richiesta  
sconce lamp available on request

# ODESSA

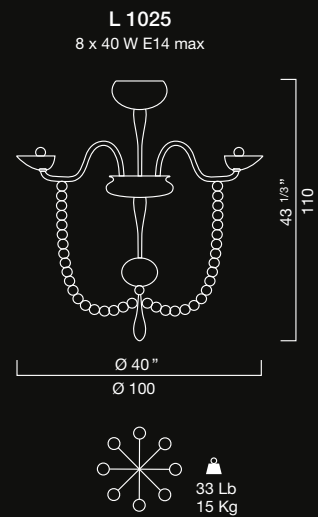

colori suggeriti:  
Cristallo/Bianco,  
Cristallo/Nero,  
Nero

suggested colors:  
Crystal/White,  
Crystal/Black,  
Black

applique  
e piantana  
disponibili  
su richiesta

sconce and  
standing lamp  
available  
on request

# PALAZZO

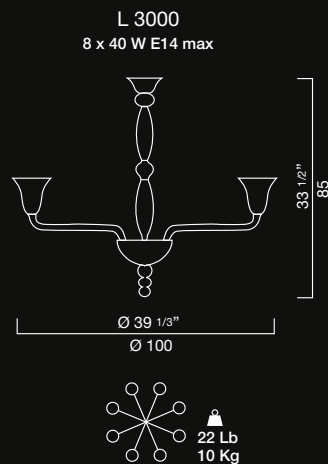

colori suggeriti:  
Cristallo, Rosso,  
Fumè

suggested colors:  
Crystal, Red,  
Smoked

applique  
disponibile su richiesta

sconce lamp  
available on request

# PRAGA

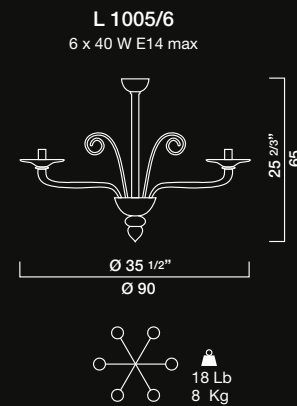
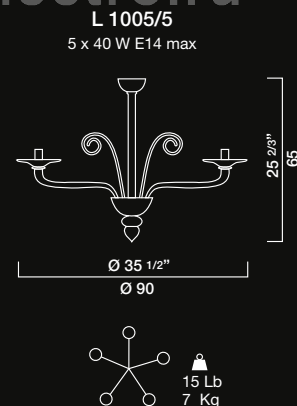

colori suggeriti:  
Cristallo/Nero,  
Cristallo/Rubino chiaro,  
Cristallo/Acquamarina

suggested colors:  
Crystal/Black,  
Crystal/Light Ruby,  
Crystal/Aquamarine

applique  
disponibile  
su richiesta

sconce lamp  
available  
on request

# POMPEI

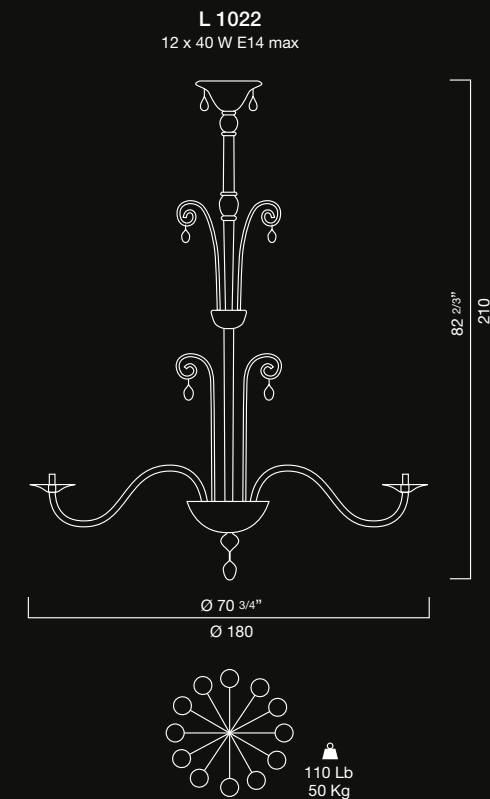

colori suggeriti:  
Cristallo,  
Acciaio,  
Nero

suggested  
colors:  
Crystal,  
Steel,  
Black

applique  
disponibile  
su richiesta

sconce lamp  
available  
on request

**MODUL**  
ELECTRO  
www.modulelectro.ru

# SHANGAI

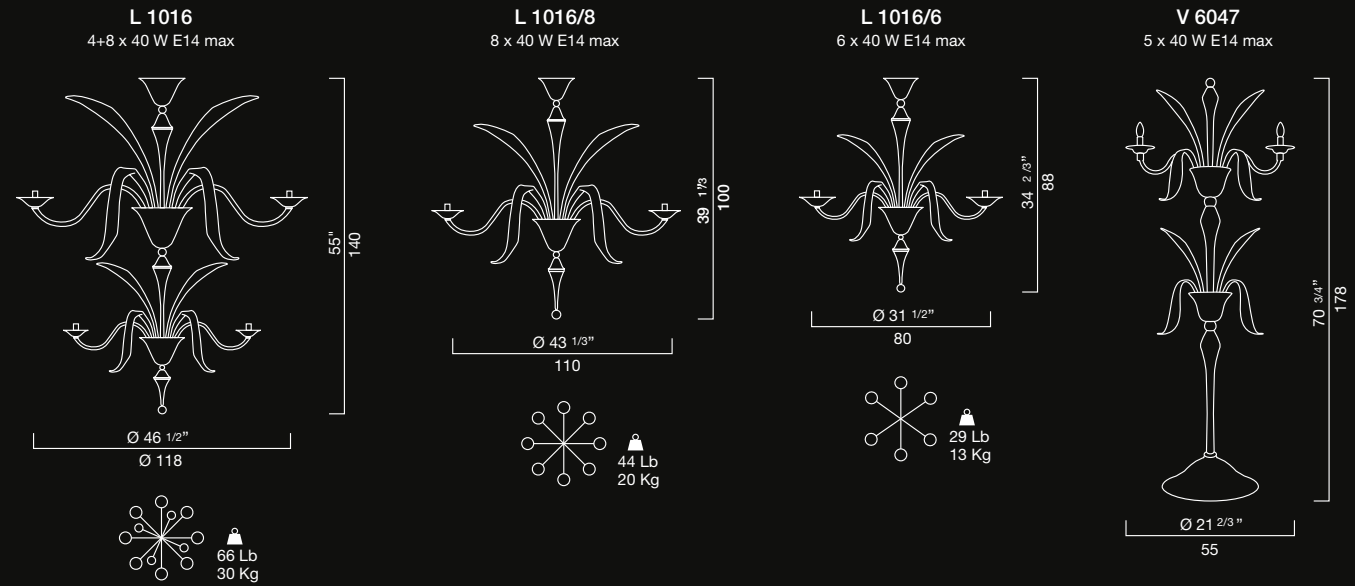

colori suggeriti:  
Cristallo/Blu Grigio,  
Cristallo/Tabacco

suggested colors:  
Crystal/Blue Grey,  
Crystal/Tobacco

applique  
e flambeau  
disponibili  
su richiesta

sconce and  
flambeau  
available  
on request

# STARS of ISTANBUL

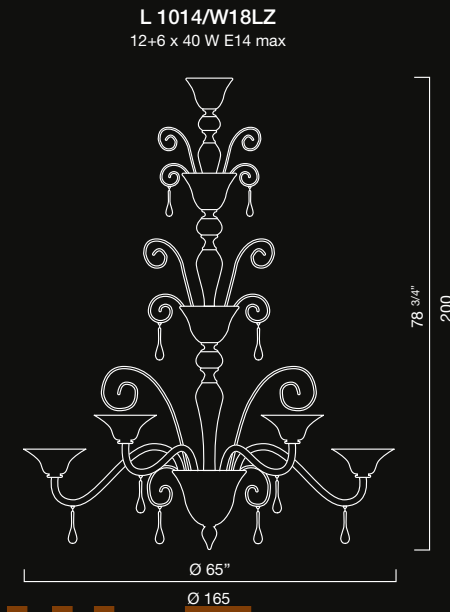

colori suggeriti:  
tutto  
Fosforescente

suggested colors:  
all Fosforescent

applique  
e piantana  
disponibili  
su richiesta

sconce and  
standing lamp  
available  
on request

# ROSTOV

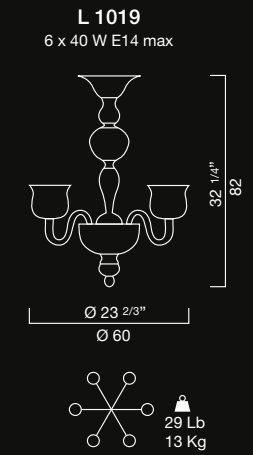

colori suggeriti:  
Fumè, Acciaio

suggested colors:  
Smoked, Steel

applique, piantana  
e flambeau  
disponibili su richiesta

sconce, standing lamp  
and flambeau  
available on request

# SHIRAZ

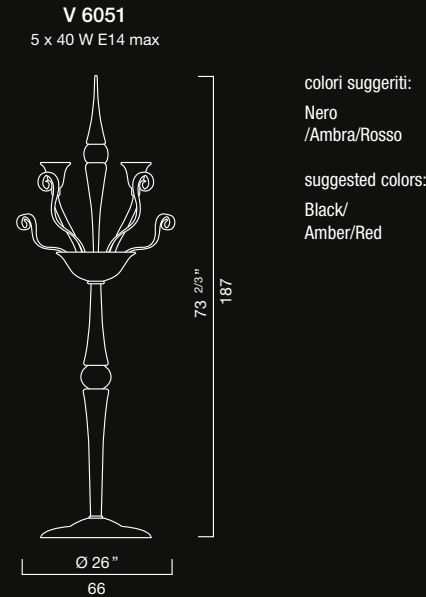

colori suggeriti:  
Nero  
/Ambra/Rosso

suggested colors:  
Black/  
Amber/Red

# SIENA

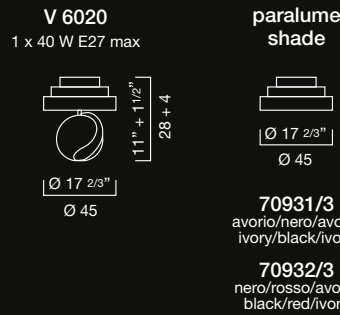

colori suggeriti:  
Nero/Morisa Cristallo

suggested colors:  
Black/Crystal decoration

# TRANSILVANIA

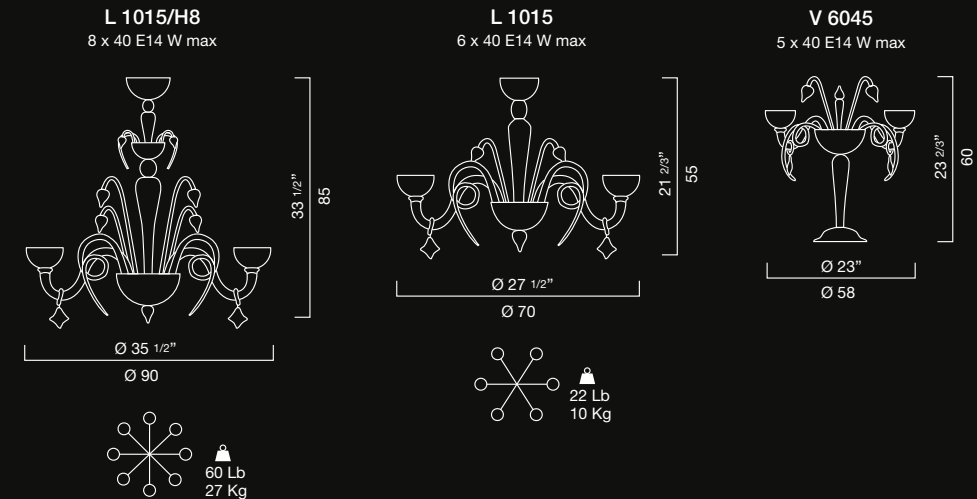

colori suggeriti:  
Nero/Rosso

suggested colors:  
Black/Red

applique e piantana  
disponibili su richiesta

sconce and standing lamp  
available on request

**MODULO**  
ELECTRO  
www.modulelectro.ru

# TRIPODE

**L 1026**

11 x 40 W G9 max

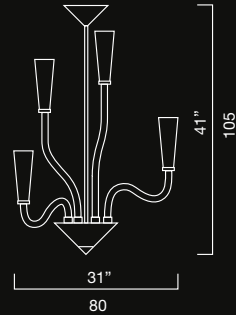

**V 6042**

3 x 40 W G9 max

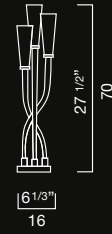

**V 6043**

3 x 40 W G9 max

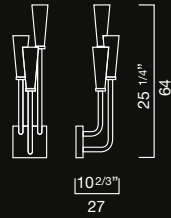

colori suggeriti:

Cristallo/Viola,  
Cristallo/Blu Grigio,  
Cristallo/Rosso,  
Cristallo/Ambra

suggested colors:

Crystal/Violet,  
Crystal/Blue Grey,  
Crystal/Red,  
Crystal/Amber

# TWEED

**V 6055**

1 x 40 W E 27 max

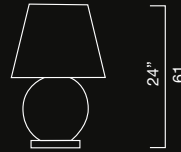

colori suggeriti:

come foto

suggested colors:

like picture

# VIENNA

**L 1012**

3 x 40 W E14 max

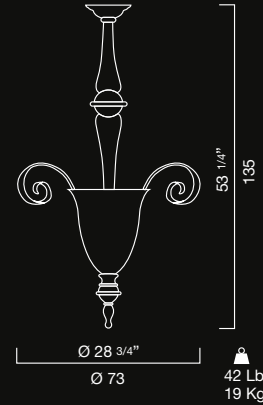

**L 1012/A**

2 x 40 W E14 max

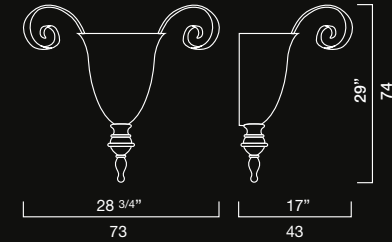

**V 6039**

3 x 40 W E14 max

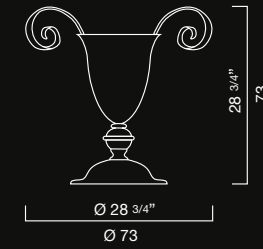

**V 6038**

3 x 40 W E14 max

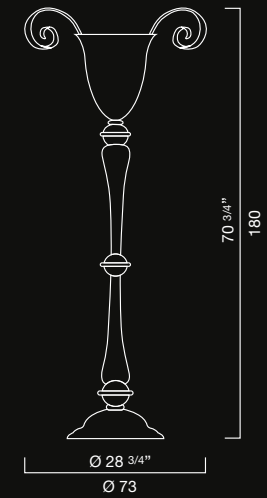

colori suggeriti:

Ambra  
Oro/Nero

suggested colors:

Amber  
Gold/Black

# TOKYO

**L 1050**

9 x 40 W E14 max

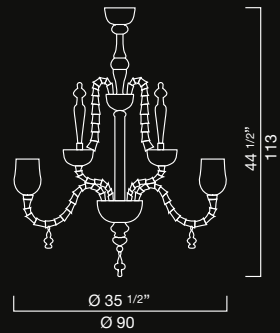

colori suggeriti:

Giallo, Blu Cobalto, Fuxia, Rosso,  
Cromo, Oro, Viola.  
la montatura è disponibile  
a richiesta in qualsiasi  
colore della scala RAL

suggested colors:

Yellow, Blue, Fuxia, Red,  
Chrome, Gold, Violet.  
frame available  
in all RAL colours upon request

applique  
disponibile su richiesta

sconce lamp  
available on request

# VERSAILLES

**L 1055**

LED 25 x 3,5 W

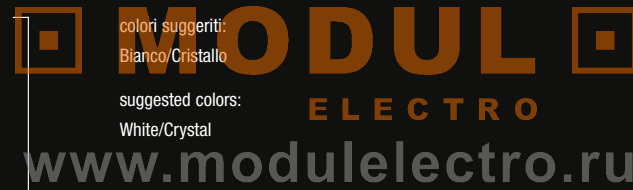
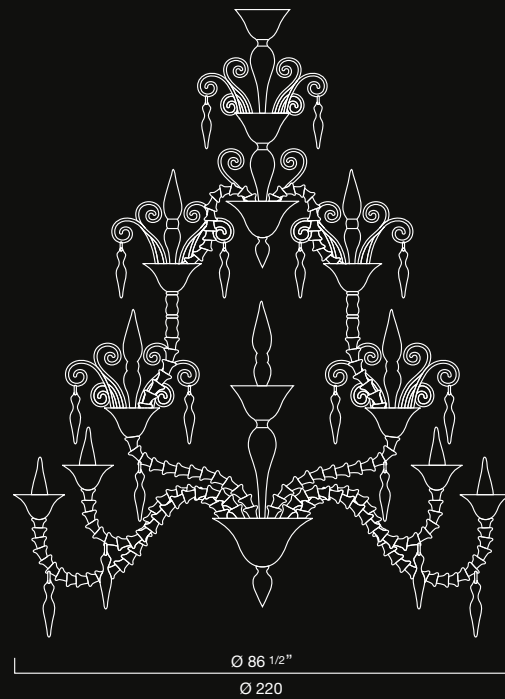

colori suggeriti:  
Bianco/Cristallo

suggested colors:  
White/Crystal

applique,  
piantana  
e flambeau  
disponibili  
su richiesta

sconce,  
standing lamp  
and flambeau  
available  
on request

# indice index

BALI page 22/24 · 136



BALI 107 · 136



BALI 106 · 136



MARIENBAD 72 · 142



MARS 16 · 142



MI AMI 128 · 142



MILANO 82 · 143



MONTREAL 64 · 143



MONTREAL 112 · 143



BERLINO 70 · 137



CAPRI 12 · 137

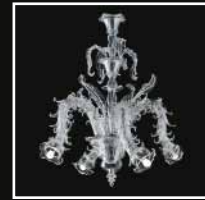

CAPRI 96 · 137



CHICAGO 68 · 137



CHILDHOOD M. 50 · 137



CHILDHOOD M. 132 · 137



NANCY 84 · 143



NEW YORK 20 · 143



ODESSA 18 · 144



ONE THOUSAND... 48 · 144

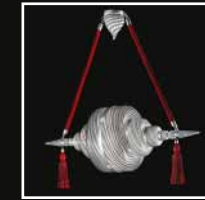

ONE THOUSAND... 48 · 144



ONE THOUSAND... 130 · 144



CHILDHOOD M. 133 · 137

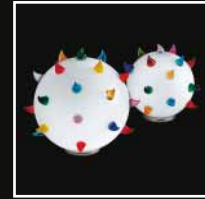

DEHLI 34 · 138



DEHLI 110 · 138



DIAMANTI 105 · 138



DIAMANTI 104 · 138



DOHA 10 · 138



PALAZZO 78 · 144



PARIGI 90 · 145



PARIGI 120 · 145



PARIGI 121 · 145



POMPEI 86 · 145



PRAGA 76 · 145



DOHA 98 · 138



DUBLINO 42/44 · 139



ESTE 115 · 139



FIRENZE 88 · 139



FIRENZE 118 · 139



FIRENZE 118 · 139



ROSTOV 80 · 147



SHANGAI 30/32 · 146



SHANGAI 124 · 146



SHIRAZ 126 · 146



SIENA 114 · 146



STARS OF ISTANBUL 56 · 147



FIRENZE 119 · 139



FONTANA 4 · 140



FONTANA vs FONTANA 6 · 140

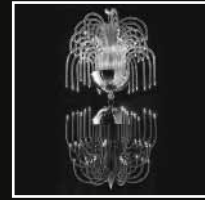

GLASGOW 108 · 140



INFERNO 36/38 · 140



ISTANBUL 26/28 · 141



TOKYO 40 · 148



TRANSILVANIA 8 · 147



TRANSILVANIA 100 · 147



TRIPODE 14 · 148



TRIPODE 103 · 148



TRIPODE 102 · 148

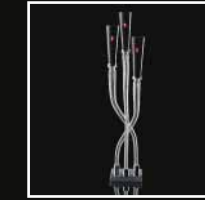

KIEV 62 · 141



KIEV STARDUST 58 · 141



LONDRA 74 · 141



MANHATTAN 68 · 142



MANHATTAN 113 · 142



MANHATTAN 113 · 142

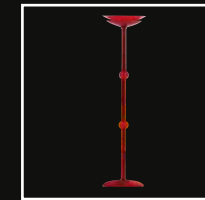

TWEED 116 · 148



VERSAILLES 54 · 148



VIENNA 92 · 149



VIENNA 123 · 149



VIENNA 122 · 149



VIENNA 123 · 149



MODULO  
ELECTRO  
www.modulelectro.ru

**MODUL**  
ELECTRO  
[www.modulelectro.ru](http://www.modulelectro.ru)



Tutti gli articoli delle nostre collezioni sono eseguiti a mano nella nostra fornace a Murano.

Ogni nostro prodotto è firmato e riporta l'etichetta di garanzia Murano con il nostro numero di certificazione: n.037.

Tutte le lampade sono in conformità alle direttive europee e alla UL General Coverage per Stati Uniti e Canada.

L'azienda si riserva di apportare ai propri prodotti eventuali modifiche estetiche e/o tecniche che ritiene opportune.

Each item of our collections is handmade in our furnace in Murano.

Our pieces are all signed and marked with the Murano glass guarantee, including our certification number 037.

Our lamps comply with the EU directives and with the UL General Coverage standards for USA and Canada.

Our firm reserves the right to modify its items for the technical or design aspects whenever necessary without previous notice to the customer.



**MODULO**  
ELECTRO  
[www.modulelectro.ru](http://www.modulelectro.ru)

**Formia International s.r.l.**

Fondamenta Vetrai, 138  
30141 Murano Venezia - Italy  
tel.: +39 041 739285  
fax: +39 041 5274357  
[info@formiaglass.it](mailto:info@formiaglass.it)  
[www.formiaglass.it](http://www.formiaglass.it)