

Aggiornamento Ottone

Brass Update

2010 - 2011



fonderie componenti per illuminazione

MODULO
ELECTRO
www.modulelectro.ru

Aggiornamento Update





Cover bodies - Copricentri



17-095

Ø100 x H40 · foro/hole Ø10,5
piano sopra/upper flat Ø15

17-096

Ø120 x H45 · foro/hole Ø10,5
piano sopra/upper flat Ø18

17-097

Ø140 x H55 · foro/hole Ø10,5
piano sopra/upper flat Ø18



17-100

Ø80 x H20 · foro/hole Ø10,5
piano sopra/upper flat Ø15

17-101

Ø100 x H25 · foro/hole Ø10,5
piano sopra/upper flat Ø17

17-102

Ø120 x H30 · foro/hole Ø10,5
piano sopra/upper flat Ø18

17-103

Ø200 x H45 · foro/hole Ø10,5
piano sopra/upper flat Ø30

17-104

Ø250 x H57 · foro/hole Ø10,5
piano sopra/upper flat Ø40

lettura corretta delle misure:
measurement legenda:

piano sopra/upper flat

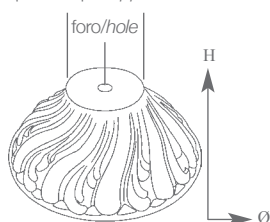



Ø160

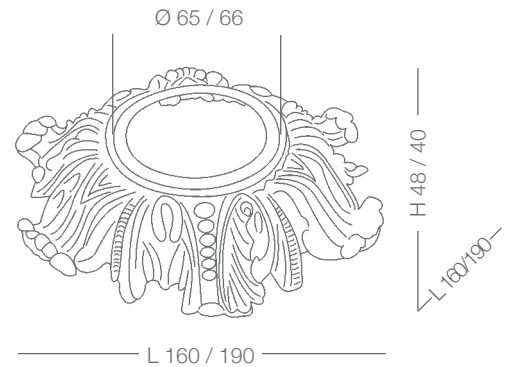

32-028

L160 x L160 x H48

32-070

L200 x L200 x H40

MODULO
ELECTRO

www.modulelectro.ru



Ø120

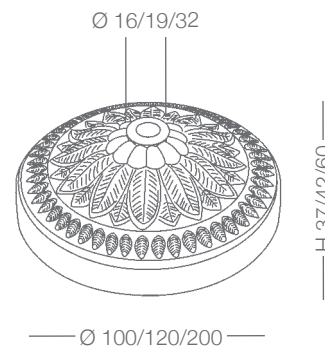

32-071

Ø100 x H37

32-072

Ø120 x H42

32-073

Ø200 x H60

lettura corretta delle misure:
measurement legenda:

N.B. la quota delle sedi viene specificata in **NERO**
housing dimension in BLACK

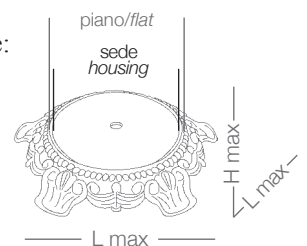



Bobeches - Fadelline



G162-F

Ø100 x H15 · foro/hole Ø10,5
piano sopra/upper flat Ø18
pressofuso - die casted

G162

Ø100 x H15 · foro/hole Ø10,5
piano sopra/upper flat Ø18
stampato - printed



G171-F

Ø100 x H20 · foro/hole Ø10,5
piano sopra/upper flat Ø19
pressofuso - die casted

G171

Ø100 x H15 · foro/hole Ø10,5
piano sopra/upper flat Ø18
stampato - printed



lettura corretta delle misure:
measurement legenda:

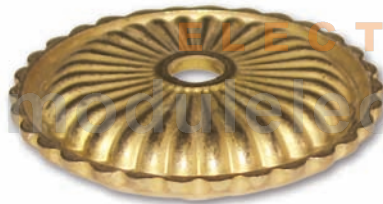
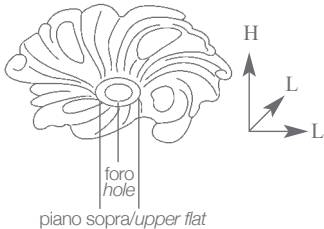

G005

Ø53 x H9 · foro/hole Ø10,5
piano sopra/upper flat Ø13

18-073

Ø70 x H10 · foro/hole Ø10,5
piano sopra/upper flat Ø16

Candle holders - Portacandele

lettura corretta delle misure:
measurement legenda:

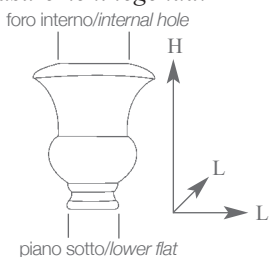

19-020

Ø40 x H46
piano sotto/lower flat Ø16
foro interno/internal hole Ø30
primo foro/first hole Ø22



19-021

Ø35 x H36
piano sotto/lower flat Ø16
foro interno/internal hole Ø28
primo foro/first hole Ø22

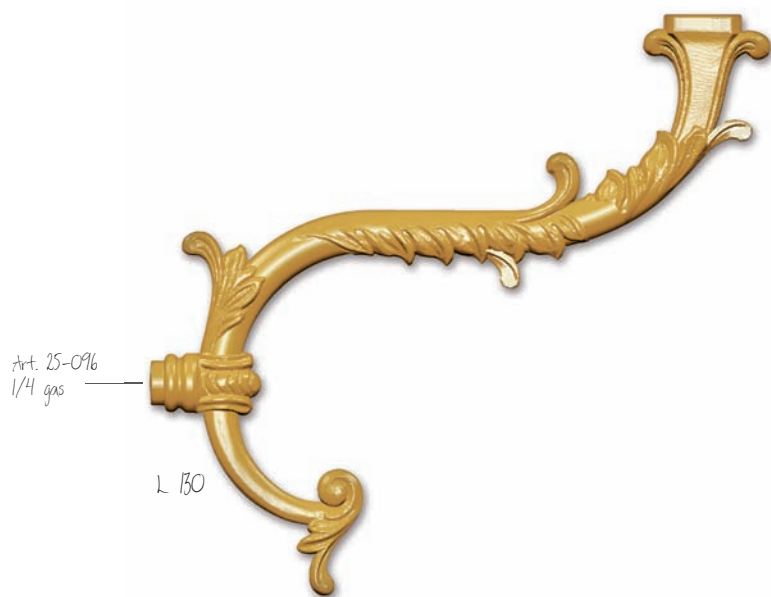

25-093

L130 x L125 x H24
filetto/thread M 10/1

25-094

L190 x L170 x H31
filetto/thread M 10/1

25-095

L250 x L230 x H40
filetto/thread M 10/1

25-096

L350 x L300 x H55
filetto/thread M 10/1
filetto/thread 1/4 gas

MODUL
ELECTRO

www.modulelectro.ru



25-042

L130 x L130 x H24
filetto/thread M 10/1

25-041

L170 x L170 x H25
filetto/thread M 10/1

25-090

L250 x L220 x H30
filetto/thread M 10/1

25-091

L315 x L280 x H33
filetto/thread M 10/1

25-092

L420 x L270 x H35
filetto/thread M 10/1
filetto/thread 1/4 gas

lettura misure:
measurement legenda:

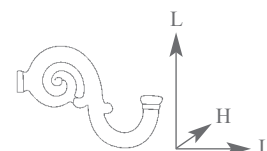



Wall brackets - Appliques



L 205

lettura corretta delle misure:
measurement legenda:

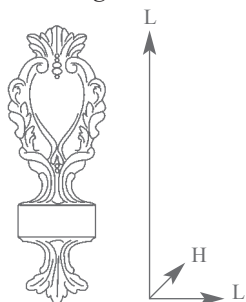

Q120
L400 x L205 x H21

31-046
L500 x L240 x H25

Recessed spotlight - Faretti a incasso



35-001
Ø100 x H45 · foro/hole Ø50



MODULO
ELECTRO
www.modulelectro

35-002
L100 x L100 x H40 · foro/hole Ø50



35-003
Ø100 x H45 · foro/hole Ø50

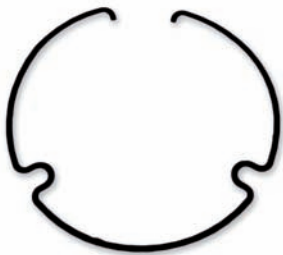

F1273-08-039



F1273-08-038



Esempio 35-002 assemblato - 35-002 Assembled example



Note

ELECTRO
www.modulelectro.ru

MODULO
ELECTRO
www.modulelectro.ru



FRAMON
fonderie componenti per illuminazione S.P.A. ©

Via F. Lana, 31

25065 Lumezzane (BS) Italy

Tel. (+39) 0308920977 r.a. · Fax (+39) 0308922544

www.framon.it · E-mail: info@framon.it