



 **FRAMON** S.p.A.®



MODUL
ELECTRO
www.modulelectro.ru

Outdoor Lighting

MODULO
ELECTRO
www.modulelectro.ru

The Company

Relying on the professional assistance of qualified and experienced staff and helped by a high technological and computerization level, today FRAMON S.p.A. is an important company. For 40 years it has been on the market as a manufacturing company of non-ferrous casting components for the furniture and lighting industry. It has three catalogues with about 10.000 articles ; a very good part of them is available in the warehouse. Furthermore, it realizes components by the customer's request, exclusively and with the utmost respect for the privacy. FRAMON S.p.A. is a very versatile "foundry" that makes use of some of the most important technologies of transformation of the raw materials, such as die-casting, shell casting with and without core, hot stamping, and that uses aluminium, brass, zama and some types of plastic materials. With the support of an internal designer and qualified technicians, today FRAMON S.p.A. is able to conceive, propose and develop new articles starting with the realization of drawings and possible prototypes, creating projects and stamps, up to the concrete manufacturing. The company is extremely flexible as it is able to perform every kind of mechanical processing on the castings using technological advanced and continually renewed machinery like transfers, lathes CN and machining centers. FRAMON S.p.A. proposes its articles with a surface finishing at the first step of bolting and sandblasting. On specific demand, with the help of a well-organized local craftsmanship, can also be provided the material with the superficial finishing required by the customer. Tradition and innovation, quality and competitiveness of the product, entrepreneurial ability and reliability make FRAMON S.p.A. to be an important partner for all the companies working in the lighting and furniture industry. The success of FRAMON S.p.A. is the capability to accept the challenge of the market maintaining during the years the fidelity to a working culture based on seriousness, constant inventive effort and careful technological updating.

MANUFACTURED ENTIRELY IN ITALY



MATERIALS & PROCESSES

ALUMINIUM:

- EN AB 46100 alloy for die-cast components sand-blasted with steel granules
- EN 10003/1 alloy drawn out flat using extrusion techniques
- EN 573/3 alloy drawn out into tubes using extrusion techniques

COPPER:

- EN 10204 Copper plate - 3.1B worked on a lathe

POLYCARBONATE:

- 2002/95/CE (RoHS) used for diffusers (PC) transparent and opal versions available highly resistant to atmospheric agents and impact, UV treated

GLASS:

- glass sheets 3-4 mm thick

BRASS:

- EN 1982/2000 CB 754S alloy for die-cast components in brass burnished, chrome-plated & satin finishes available

OTHER ARTICLES:

- Flood lights: AL Aluminium - Anodized
- Electrical back boxes : Polypropylene
- Gaskets : EPDM- SH
- Urban Furniture accessories: Galvanized Steel

MODULO
ELECTRO
www.modulelectro.ru

ALUMINIUM SERIES

Botticelli	25
Bramante	21
Canova	36
Caravaggio	82
Cezanne	39
Dalì	54
Degas	102
Donatello	29
Gauguin	43
Giotto	18
Goya	56
Klimt	59
Leonardo	9
Mantegna	33
Matisse	95
Michelangelo	3
Mondrian	63
Monet	67
Picasso	71
Pissarro	104
Pollok	103
Raffaello	46
Rembrandt	84
Renoir	75
Rubens	79
Sisley	15
Tiepolo	86
Tintoretto	92
Tiziano	89
Van Gogh	49

OUTDOOR BRASS SERIES 105

Boccioni	110
Chagall	115
Gaudì	106
Guttuso	114
Modigliani	112
Munch	108
Warhol	113

MODULO
ELECTRO
www.modulelectro.ru

NYLON & POLYCARBONATE SERIES 117

Botero	122
Brunelleschi	125
De Chirico	118
Kandinskij	124
Mirò	120

MODULO
ELECTRO
www.modulelectro.ru





MODUL
ELECTRO
www.modulelectro.ru

Michnelangelo

3 serie

For all technical inquiries or clarification please refer to our area distributor or local agent

Michelangelo

E 27
IP 44
100W 
23W 

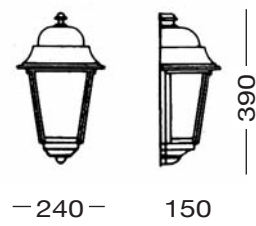

095-1000-NT30
EX ART. 00080



095-1003-NT30
EX ART. 00070



095-1017-NT30
EX ART. 00090

MODUL ELECTRO

www.modulelectro.ru

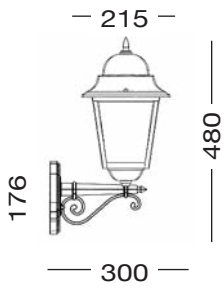

095-1001-NT30
EX ART. 00040



095-1015-NT30
EX ART. 00050

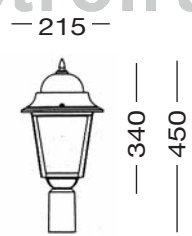

095-1005-NT30
EX ART. 00110

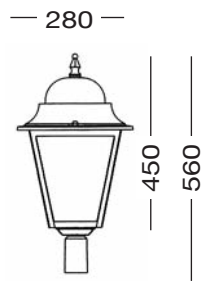

095-1019-NT30
EX ART. 00100

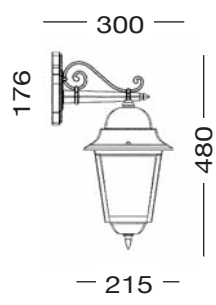

095-1002-NT30
EX ART. 00030

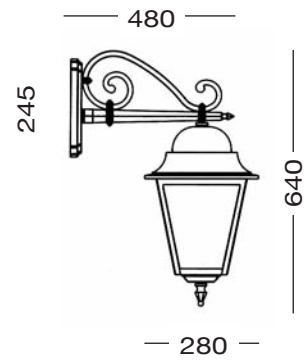

095-1016-NT30
EX ART. 00060

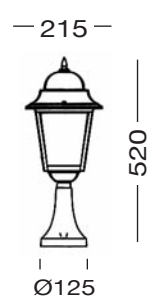

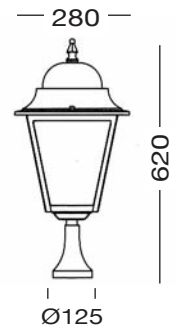

095-1004-NT30
EX ART. 00130



095-1018-NT30
EX ART. 00120

aluminium

Michelangelo

	BLACK COLOUR
	GREEN COLOUR
	WHITE COLOUR
GLASS	TRANSPARENT OR SATINED

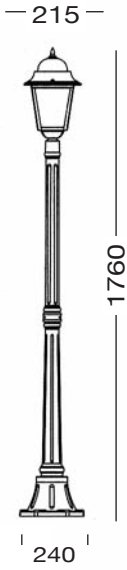

095-1008-NT30
EX ART. 00150

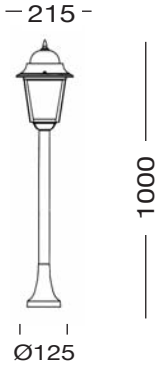

095-1006-NT30
EX ART. 00140

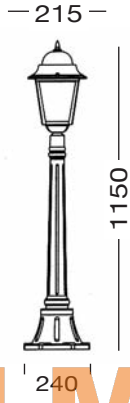

095-1007-NT30
EX ART. 00160

MODULO
ELECTRO

www.modulelectro.ru

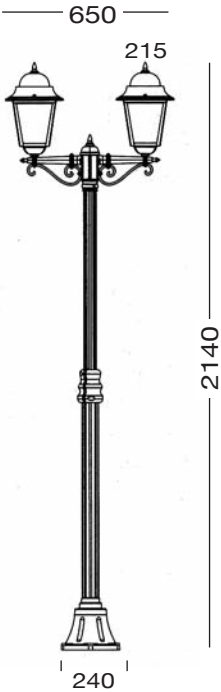

095-1009-NT30
EX ART. 00210

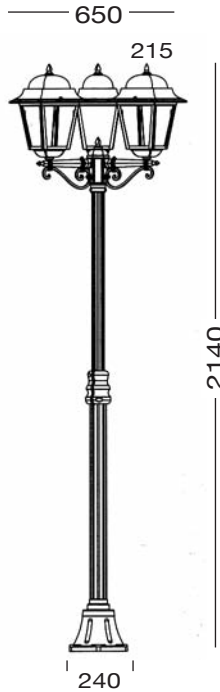

095-1010-NT30
EX ART. 00200



aluminium

Michelangelo

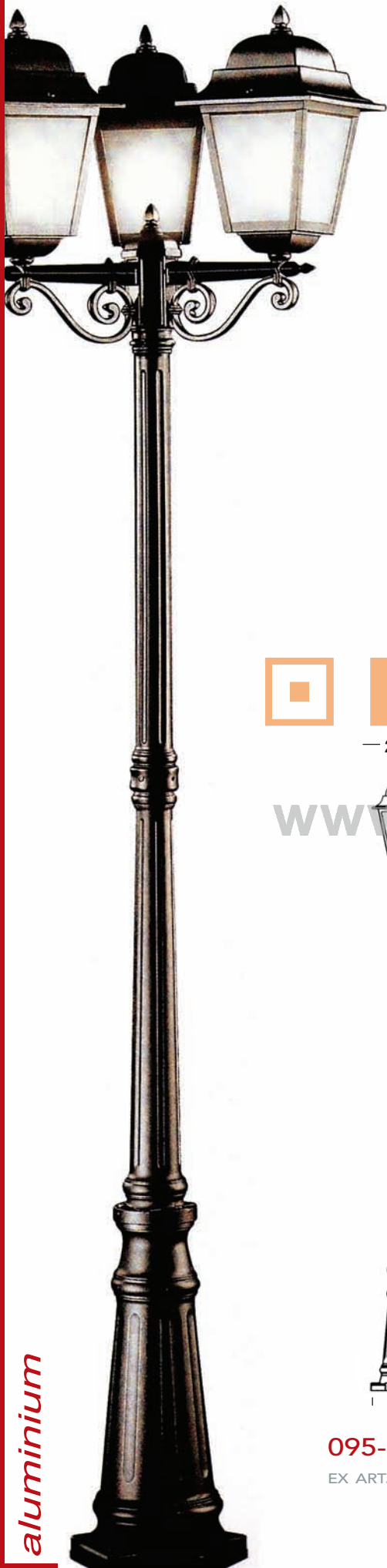

— 280 —



260

095-1020-NT30

EX ART. 00170

— 650 —



260

095-1011-NT30

EX ART. 00230

— 650 —



260

095-1012-NT30

EX ART. 00220

MODULO
ELECTRO

www.moduloelectro.ru

— 280 —



260

095-1021-NT30

EX ART. 00180

— 650 —

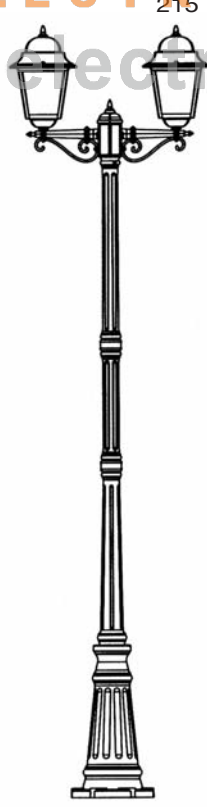

260

095-1013-NT30

EX ART. 00240

— 650 —

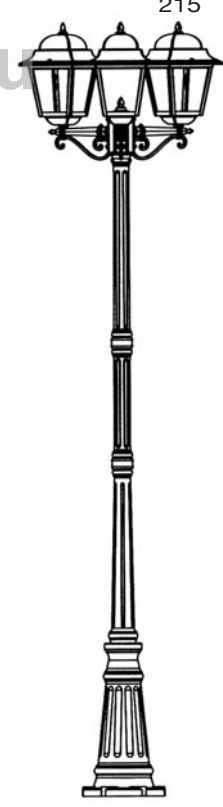



260



095-1014-NT30

EX ART. 00250

aluminium

Michelangelo

	BLACK COLOUR
	GREEN COLOUR
	WHITE COLOUR
GLASS	TRANSPARENT OR SATINED

E 27
IP 44
100W 
23W 

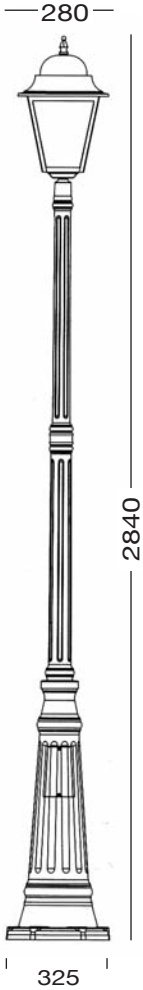

095-1022-NT30
EX ART. 00190

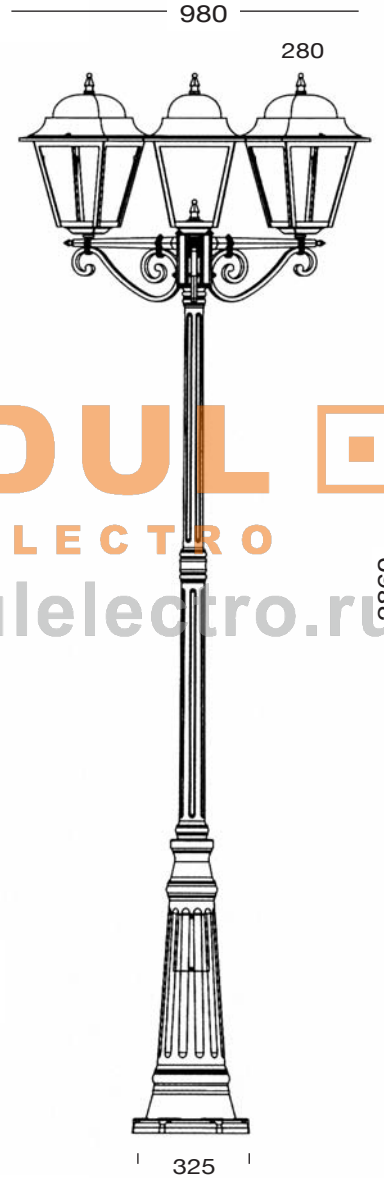

095-1024-NT30
EX ART. 00270

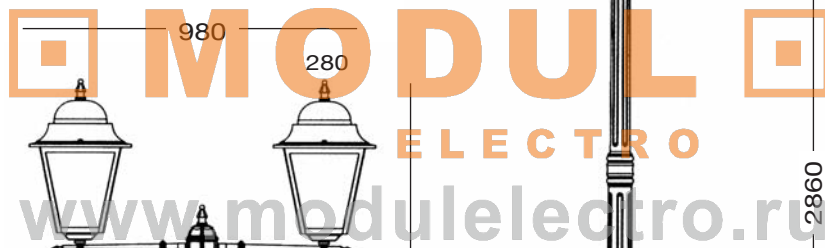

095-1023-NT30
EX ART. 00260



MODULO
ELECTRO
www.modulelectro.ru



MODUL
ELECTRO
www.modulelectro.ru

Leonardo

serie

For all technical inquiries or clarification please refer to our area distributor or local agent

Leonardo

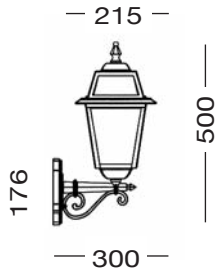

095-1028-NT30
EX ART. 00290

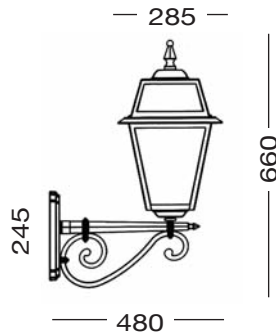

095-1040-NT30
EX ART. 00320

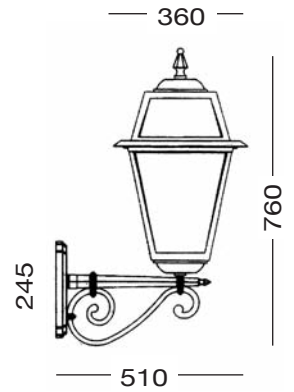

EX ART. 00300

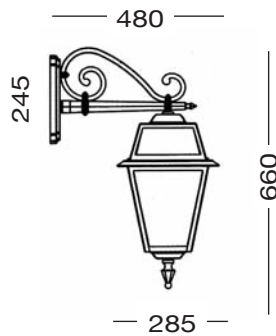
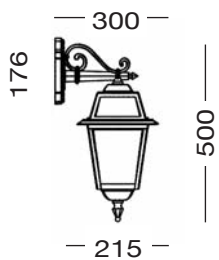

095-1029-NT30
EX ART. 00280

095-1041-NT30
EX ART. 00330



095-1027-NT30
EX ART. 00310

MODULO
ELECTRO

www.modulelectro.ru



095-1030-NT30
EX ART. 00350



095-1042-NT30
EX ART. 00360



EX ART. 00340

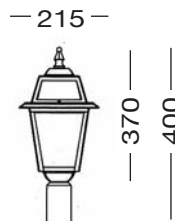

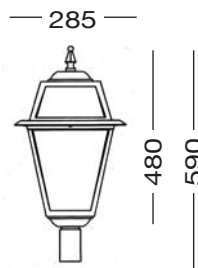

095-1032-NT30
EX ART. 00370





095-1044-NT30
EX ART. 00380

aluminium

Leonardo

	BLACK COLOUR
	GREEN COLOUR
	WHITE COLOUR
GLASS	TRANSPARENT OR SATINED

E 27
IP 44
100W 
23W 

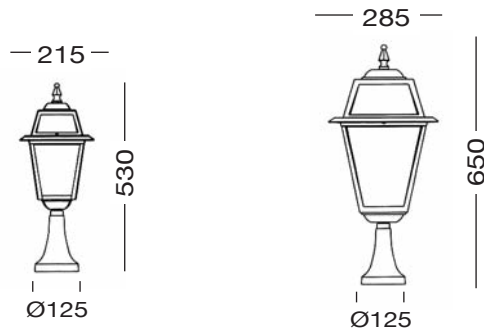

095-1031-NT30
EX ART. 00410

095-1043-NT30
EX ART. 00390

MODULO
ELECTRO

www.modulelectro.ru

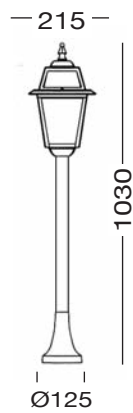
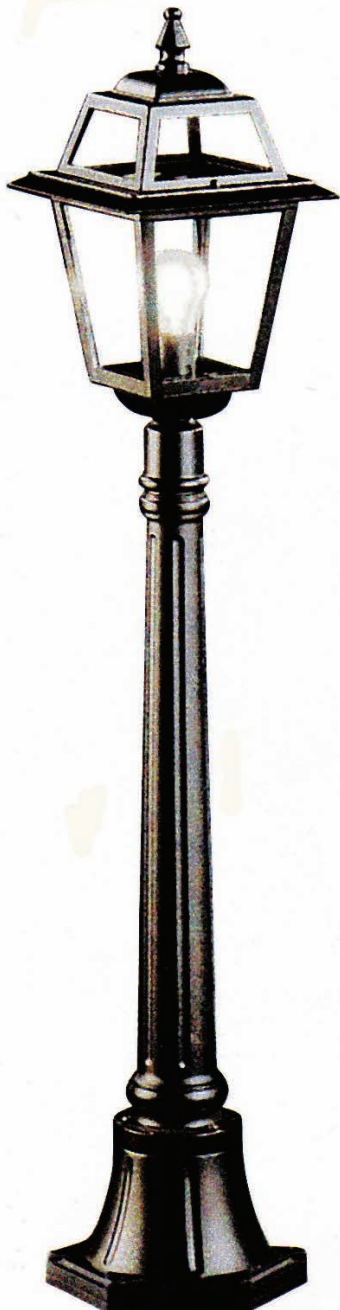

095-1033-NT30
EX ART. 00400

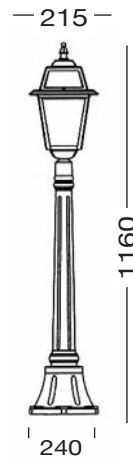

095-1034-NT30
EX ART. 00430

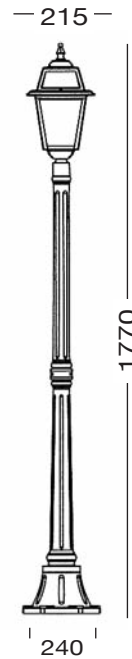

095-1035-NT30
EX ART. 00420

Leonardo



285



2880

325

360



3500

325

MODULO
ELECTRO

095-1045-NT30

EX ART. 00460

095-1049-NT3

EX ART. 00470

www.modulelectro.ru

360



2970

325

980

360

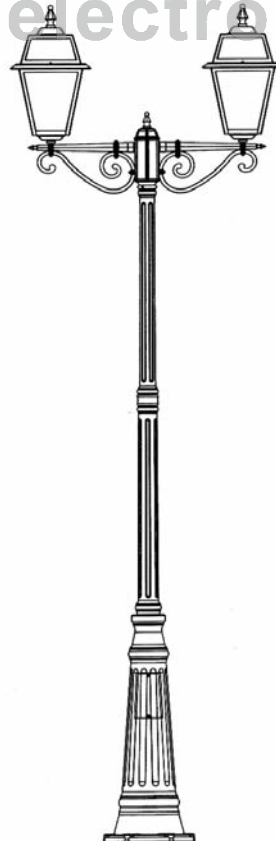

2980

325

980

360

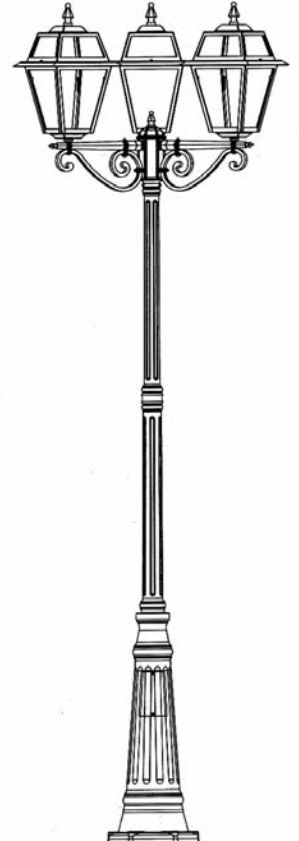

2980

325

095-1046-NT30

EX ART. 00480



095-1047-NT30



EX ART. 00490

095-1048-NT30

EX ART. 00500

aluminium

	BLACK COLOUR
	GREEN COLOUR
	WHITE COLOUR
GLASS	TRANSPARENT OR SATINED

E 27
IP 44
100W 
23W 

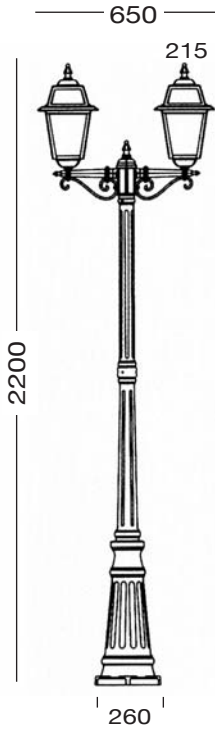

095-1036-NT30
EX ART. 00520

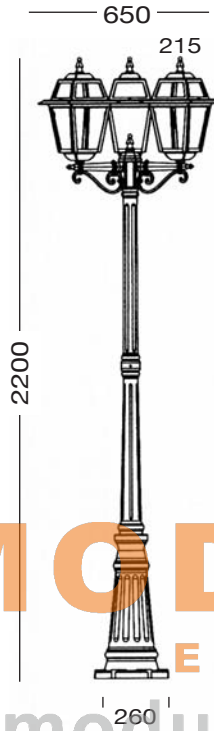

095-1037-NT30
EX ART. 00510

MODULO
ELECTRO
www.modulelectro.ru

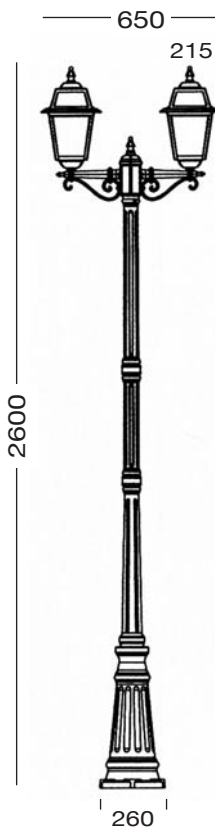

095-1038-NT30
EX ART. 00530

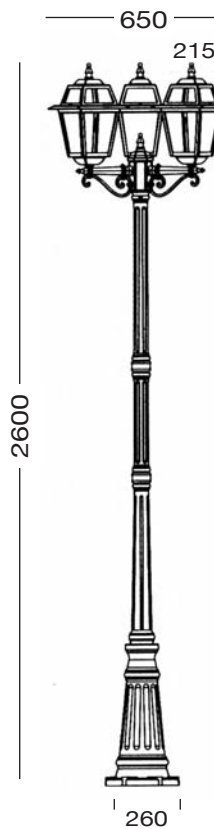

095-1039-NT30
EX ART. 00540



aluminium

MODULO
ELECTRO
www.modulelectro.ru



MODUL
ELECTRO
www.modulelectro.ru

S i s l e y

For all technical inquiries or clarification please refer to our area distributor or local agent

Sisley

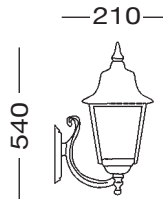
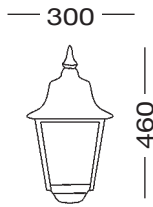

095-1053-NT30

EX ART. 01080

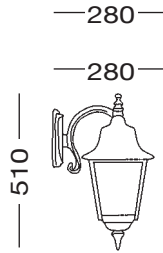

095-1054-NT30

EX ART. 01085

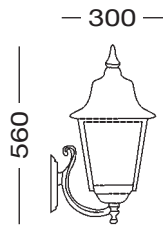

095-1062-NT30

EX ART. 01090

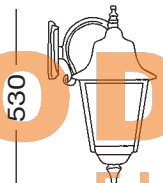
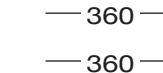

095-1063-NT30

EX ART. 01095



095-1055-NT30

EX ART. 00560

MODULO ELECTRO

www.modulelectro.ru

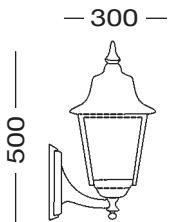

095-1064-NT30

EX ART. 00600

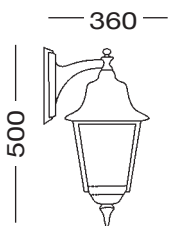
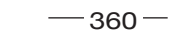

095-1065-NT30

EX ART. 00580

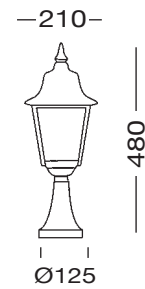

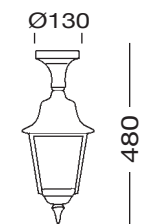

095-1056-NT30

EX ART. 00570





095-1057-NT30

EX ART. 00550

E 27
IP 44
100W 
23W 
CE

aluminium

	BLACK COLOUR
	GREEN COLOUR
	WHITE COLOUR
GLASS	TRANSPARENT OR SATINED

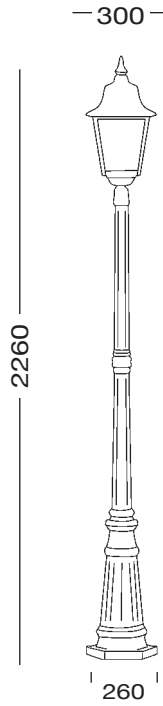

095-1067-NT30
EX ART. 00615

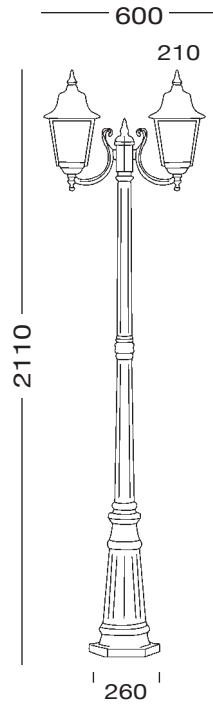

095-1060-NT30
EX ART. 00610

095-1059-NT30 1luce
095-1061-NT30 2luci

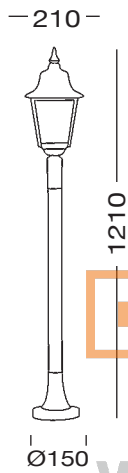

095-1058-NT30
EX ART. 00625

MODULO
ELECTRO

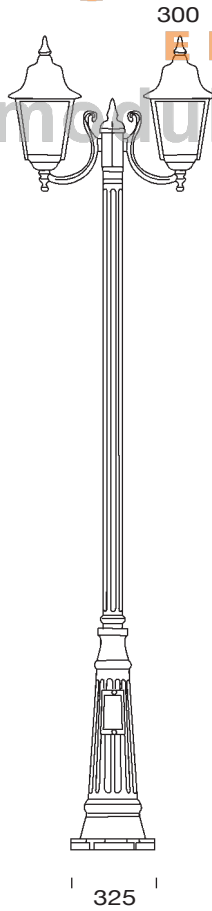

095-1068-NT30
EX ART. 01120/2

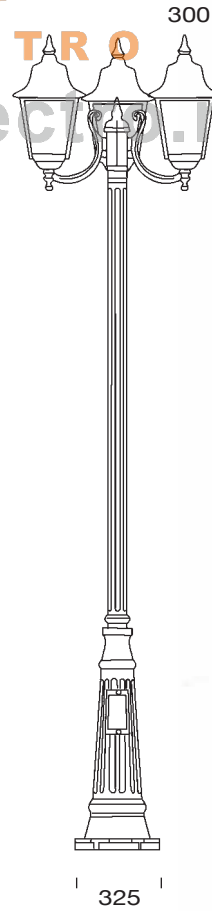

095-1069-NT30
EX ART. 01120/3



095-1066-NT30
EX ART. 00620



aluminium

Giotto



serie



18

MODULO
ELECTRO
www.modulelectro.ru



For all technical inquiries or clarification please refer to our area distributor or local agent

	BLACK COLOUR
	GREEN COLOUR
	WHITE COLOUR
GLASS	TRANSPARENT OR SATINED

E 27
IP 44
100W 
23W 

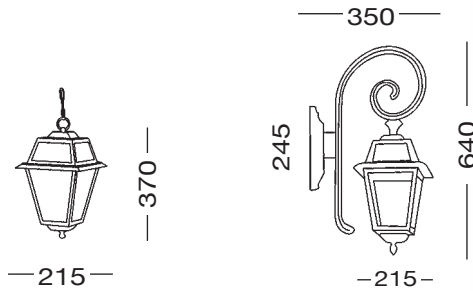
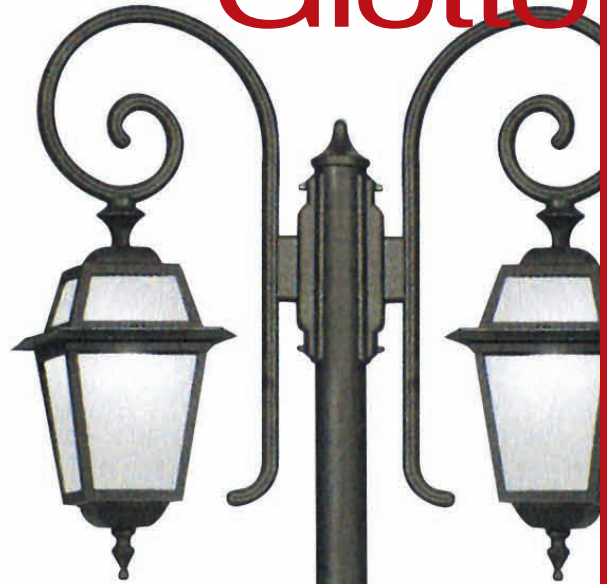

095-1073-NT30

EX ART. 00630

095-1072-NT30

EX ART. 00640

MODULO
ELECTRO

www.modulelectro.ru

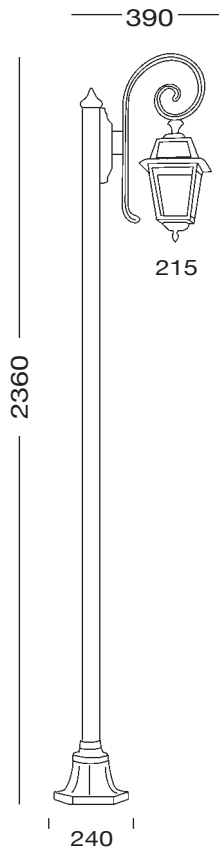

095-1074-NT30

EX ART. 00650

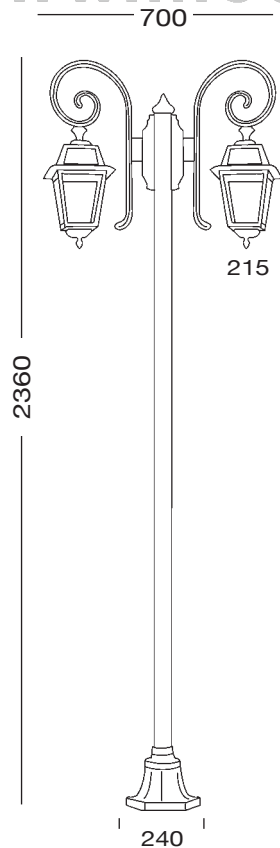

095-1075-NT30

EX ART. 00670

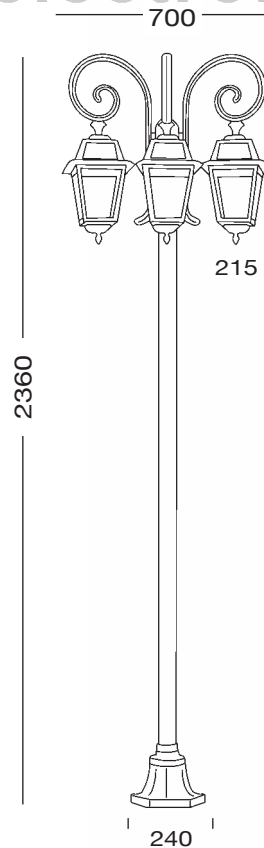

095-1076-NT30

EX ART. 00660



MODULO
ELECTRO
www.modulelectro.ru



MODUL
ELECTRO
www.modulelectro.ru

Bramante

For all technical inquiries or clarification please refer to our area distributor or local agent

Bramante

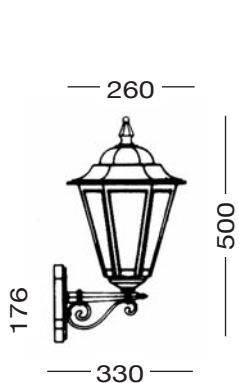

095-1081-NT30
EX ART. 00720

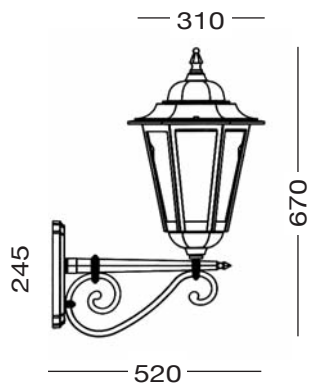

095-1093-NT30
EX ART. 00680

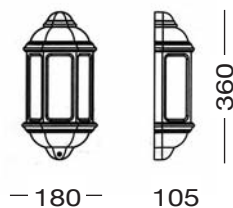

095-1080-NT30
EX ART. 00750

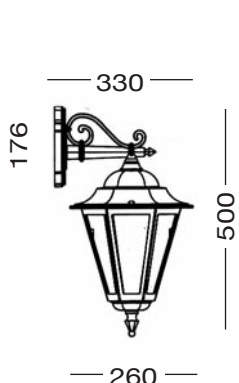

095-1082-NT30
EX ART. 00730

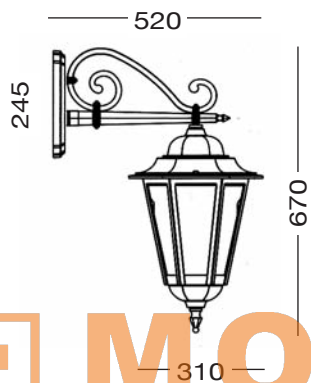

095-1094-NT30
EX ART. 00690

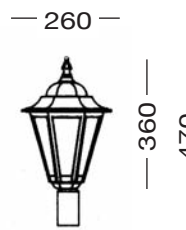

095-1085-NT30
EX ART. 00790

MODULO
ELECTRO
www.modulelectro.ru

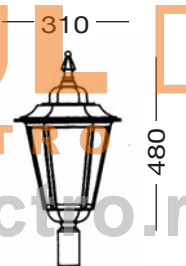

095-1097-NT30
EX ART. 00780

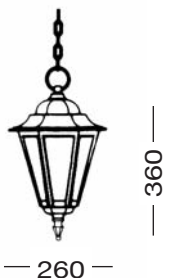

095-1083-NT30
EX ART. 00760

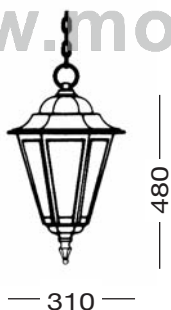

095-1095-NT30
EX ART. 00770

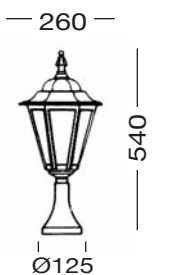

095-1084-NT30
EX ART. 00810



095-1096-NT30
EX ART. 00800

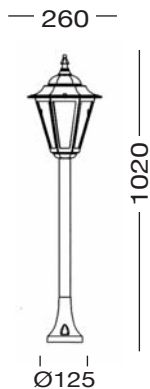

095-1086-NT30
EX ART. 00820

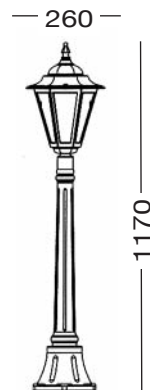

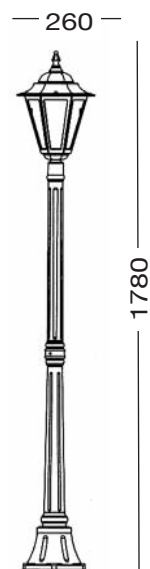

095-1087-NT30
EX ART. 00840





095-1088-NT30
EX ART. 00830



Bramante

	BLACK COLOUR
	GREEN COLOUR
	WHITE COLOUR
GLASS	TRANSPARENT OR SATINED

E 27
IP 44
100W 
23W 

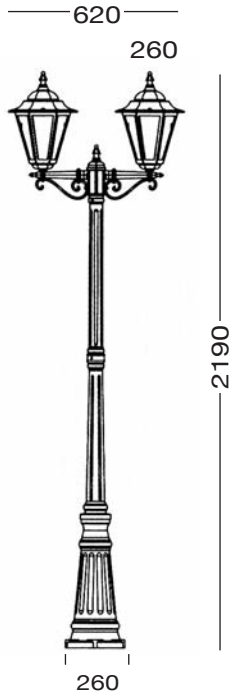

095-1089-NT30
EX ART. 00890

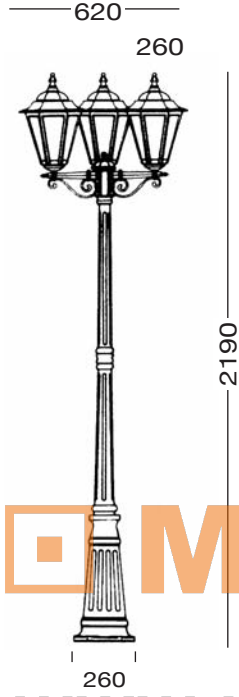

095-1090-NT30
EX ART. 00880

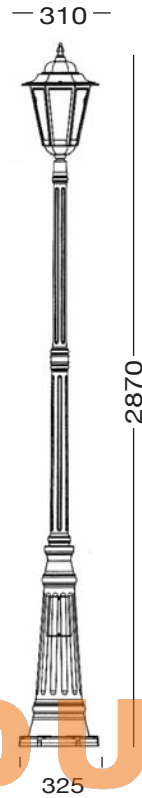

095-1098-NT30
EX ART. 00870

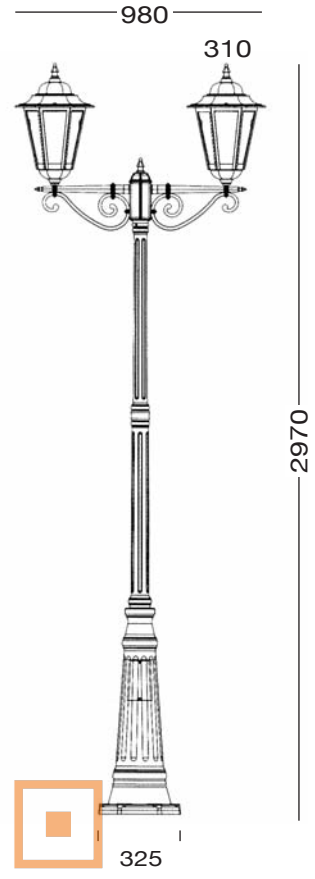

095-1099-NT30
EX ART. 00920

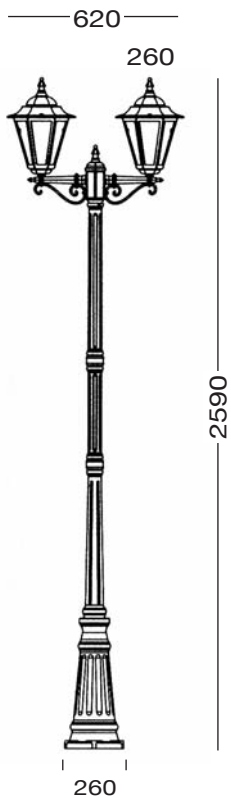

095-1091-NT30
EX ART. 00900

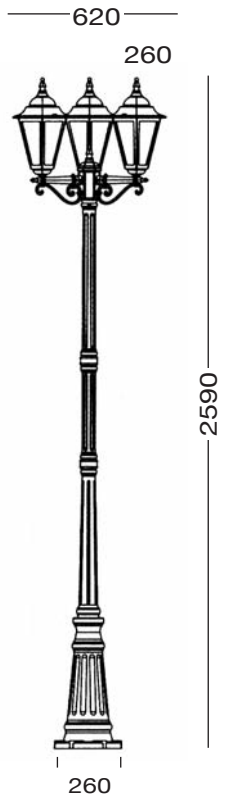

095-1092-NT30
EX ART. 00910

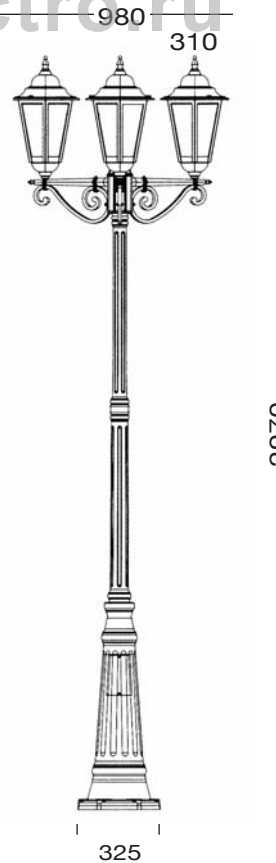

095-1100-NT30
EX ART. 00930

MODULO
ELECTRO
www.modulelectro.ru

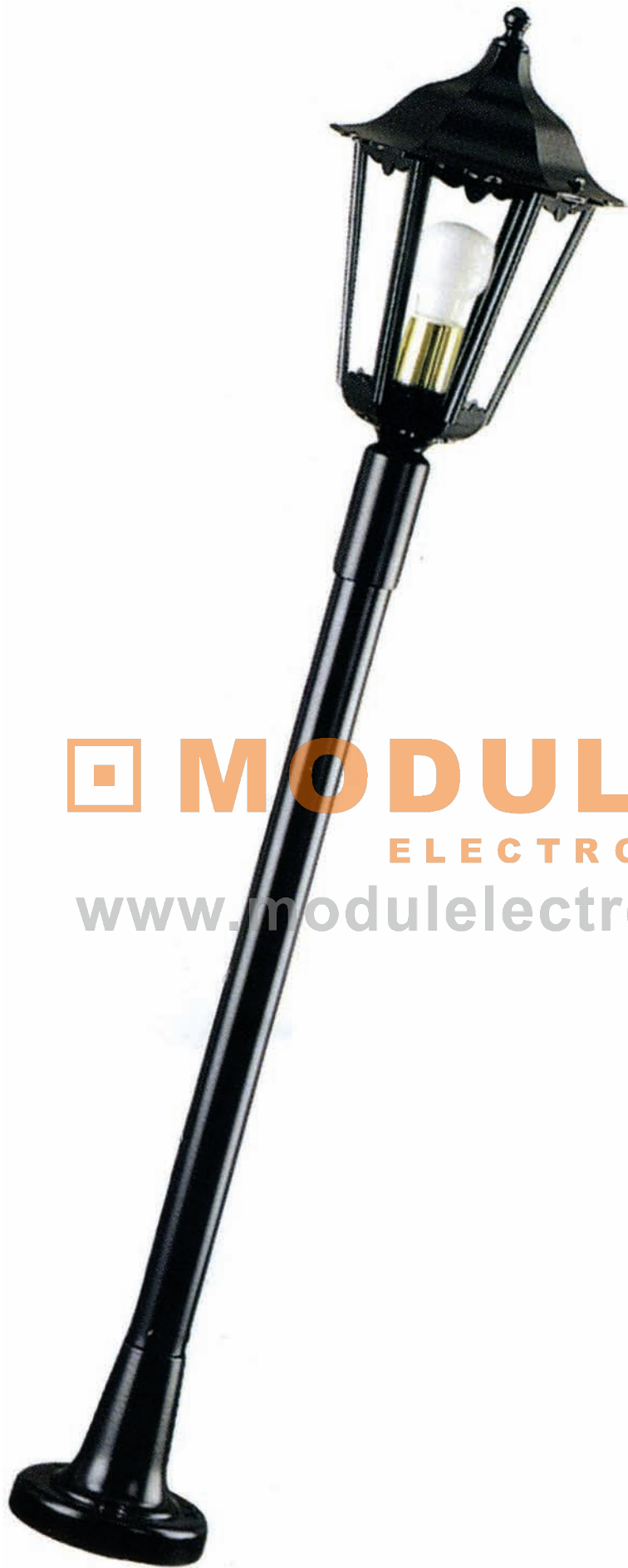

MODUL
ELECTRO
www.modulelectro.ru

Botticelli

For all technical inquiries or clarification please refer to our area distributor or local agent

Botticelli

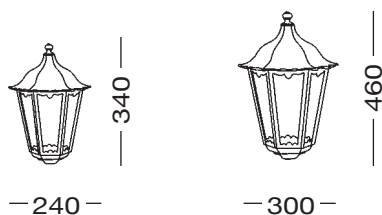

	BLACK COLOUR	E 27
	GREEN COLOUR	IP 44
	WHITE COLOUR	100W
		23W
GLASS	TRANSPARENT OR SATINED	

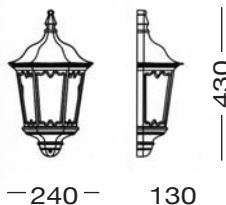

095-1103-NT30
EX ART. 00740



095-1106-NT30
EX ART. 00950



095-1107-NT30
EX ART. 00980

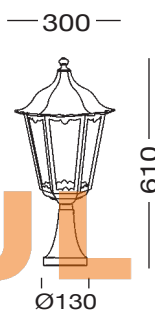

095-1111-NT30
EX ART. 01100

MODULO
ELECTRO
www.modulelectro.ru

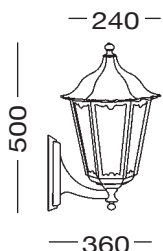

095-1104-NT30
EX ART. 00960

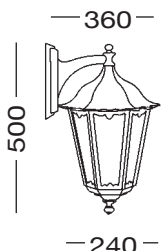

095-1105-NT30
EX ART. 00965

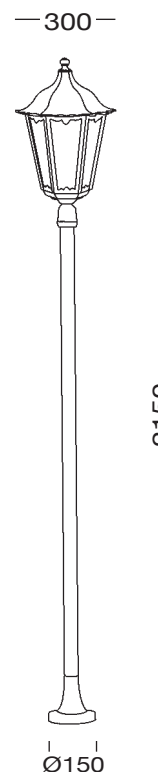

095-1112-NT30
EX ART. 01010

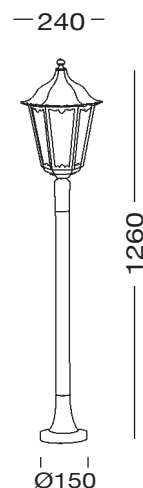

095-1108-NT30
EX ART. 01000



aluminium

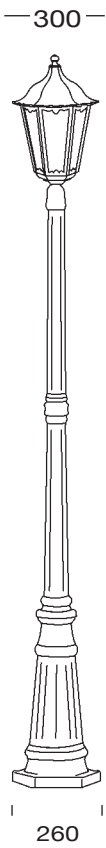

095-1113-NT30
EX ART. 01020

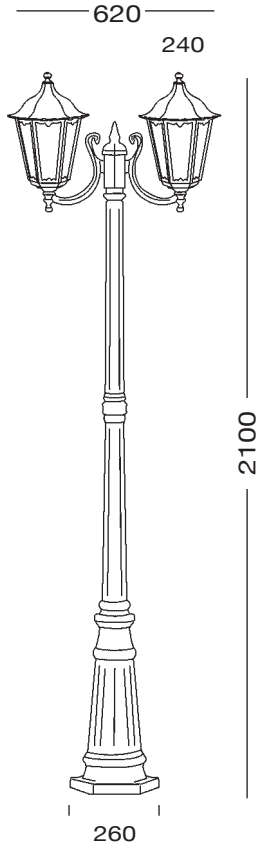

095-1109-NT30
EX ART. 00990/2

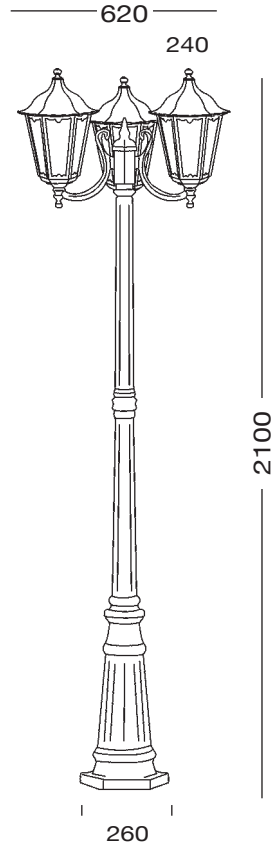

095-1110-NT30
EX ART. 00990/3

MODUL

ELECTRO

www.modul-electro.ru

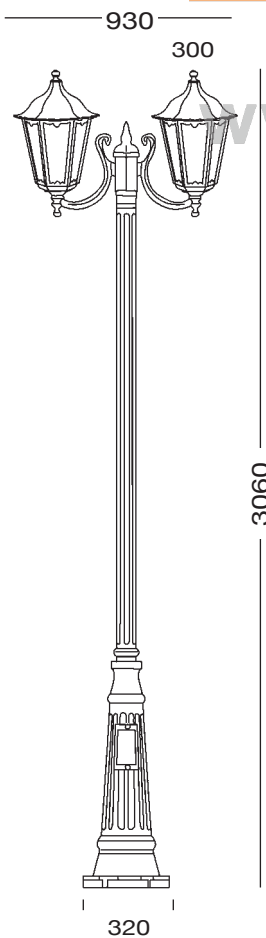

095-1114-NT30
EX ART. 01130/2

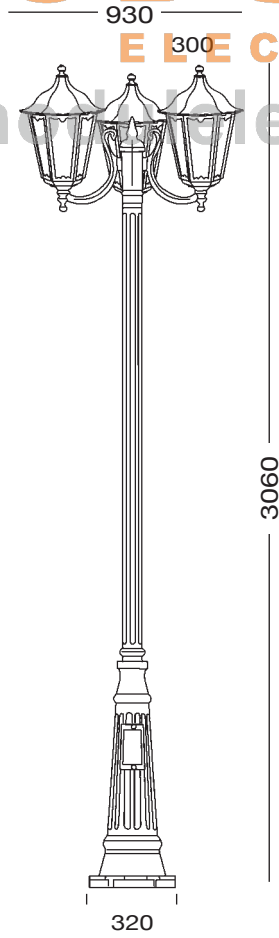

095-1115-NT30
EX ART. 01130/3

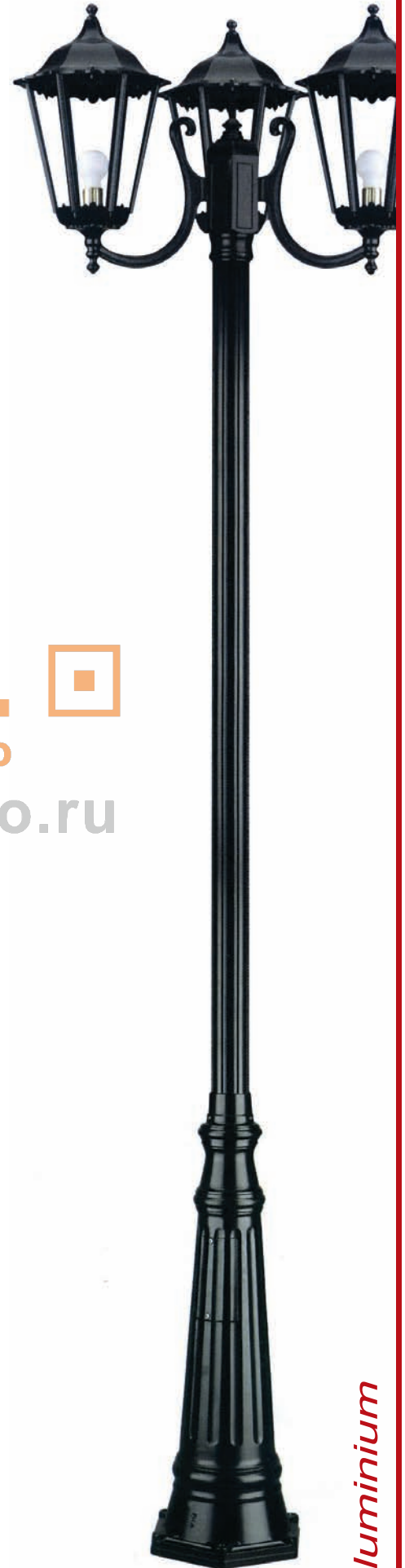

aluminium

MODULO
ELECTRO
www.modulelectro.ru



Donatello

29 serie

For all technical inquiries or clarification please refer to our area distributor or local agent

Donatello

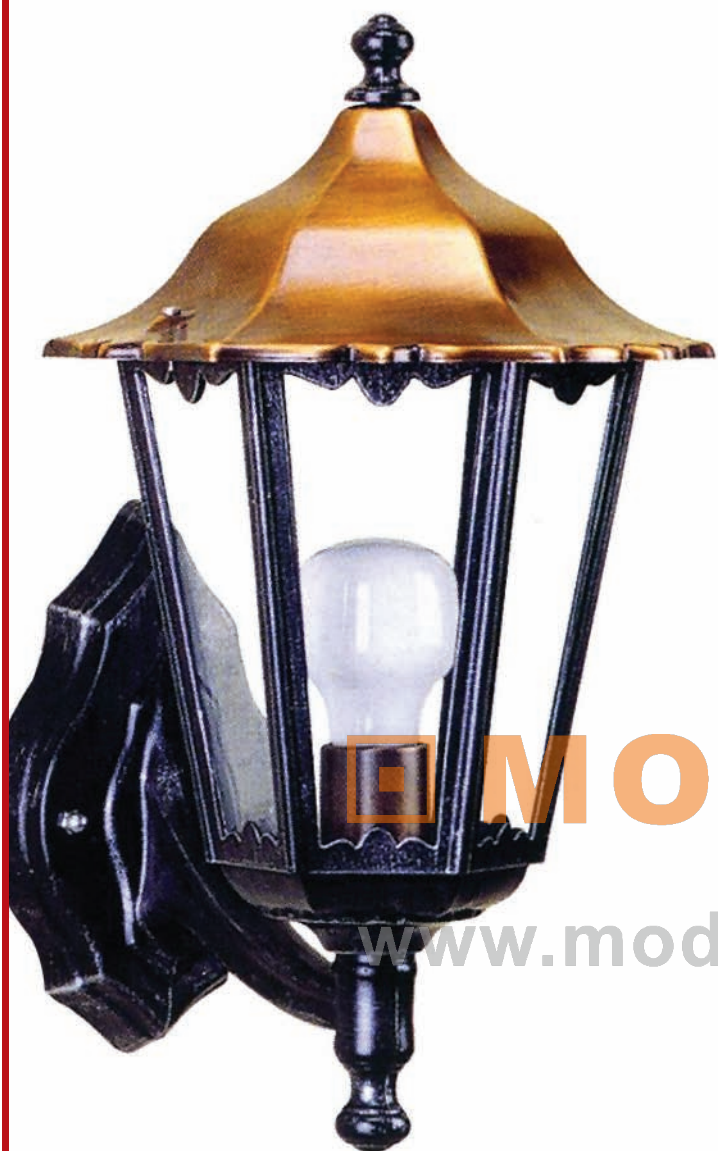

095-1106-RT30

EX ART. 01060



MODULO
ELECTRO

www.modulelectro.ru



095-1104-RT30

EX ART. 01070

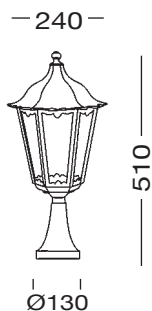
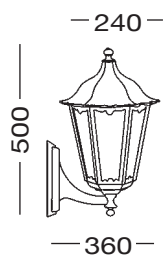

095-1107-RT30

EX ART. 01050



095-1105-RT30

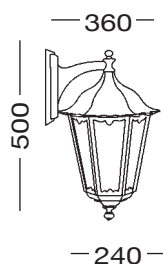

EX ART. 01075



aluminium

Donatello

	BLACK COLOUR
	GREEN COLOUR
	WHITE COLOUR
GLASS	TRANSPARENT OR SATINED

E 27
IP 44
100W 
23W 
CE

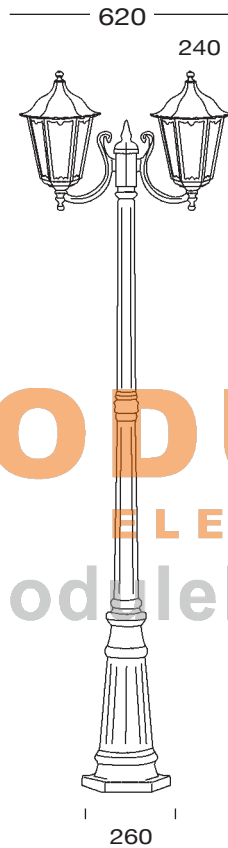

095-1109-RT30
EX ART. 01030/2

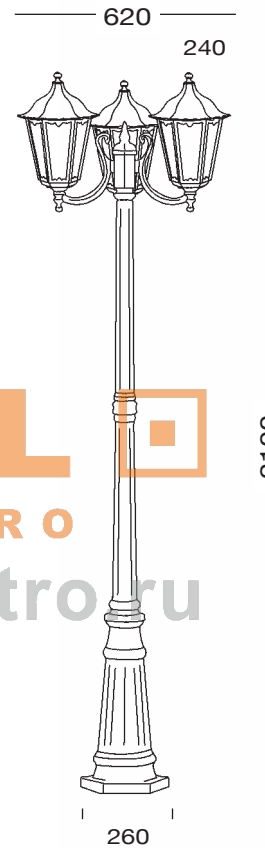

095-1110-RT30
EX ART. 01030/3

MODULO
ELECTRO
www.modulelectro.ru

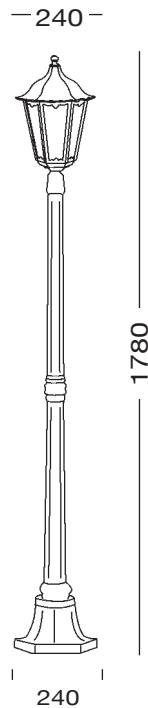

095-1118-RT30
EX ART. 01040



aluminium



MODULO
ELECTRO
www.modulelectro.ru



MODUL
ELECTRO
www.modulelectro.ru

For all technical inquiries or clarification please refer to our area distributor or local agent

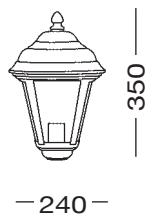
Mantegna



095-1130-NT30

EX ART. 01160

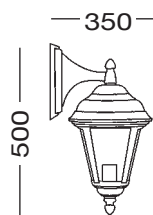

095-1131-NT30

EX ART. 01150

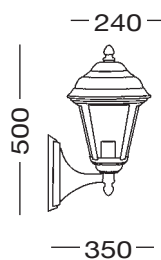

MODULO
ELECTRO

www.modulelectro.ru

095-1132-NT30

EX ART. 01140

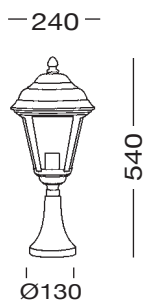

095-1133-NT30

EX ART. 01180

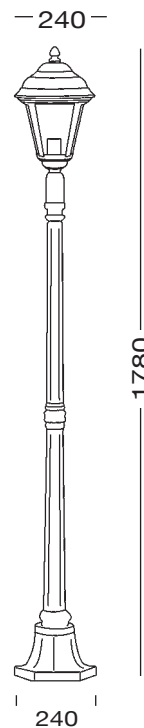







095-1134-NT30

EX ART. 01200

aluminium

Mantegna

	BLACK COLOUR
	GREEN COLOUR
	WHITE COLOUR
PC	TRANSPARENT OR OPAL

E 27
IP 44
100W 
23W 



MODUL
ELECTRO

www.modulelectro.ru

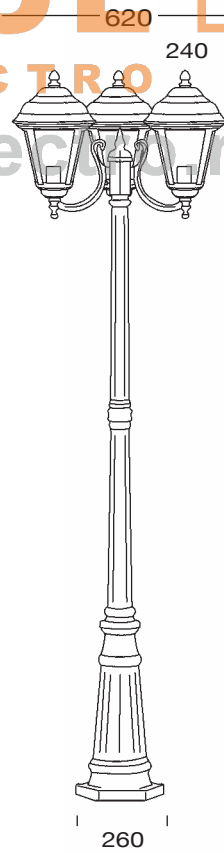
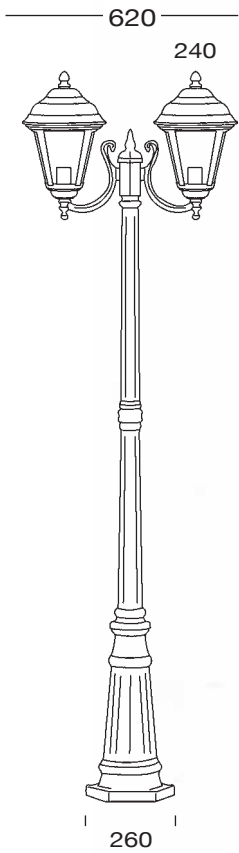

095-1135-NT30
EX ART. 01190



095-1136-NT30
EX ART. 01210



Canova



MODULO
ELECTRO
www.modulelectro.ru

For all technical inquiries or clarification please refer to our area distributor or local agent

	BLACK COLOUR
	GREEN COLOUR
	WHITE COLOUR
PC	TRANSPARENT OR OPAL

E 27
IP 44
100W 
23W 



095-1141-NO30

EX ART. 01220

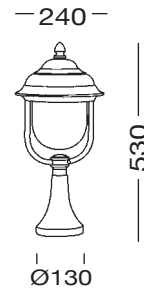

095-1142-NO30

EX ART. 01240

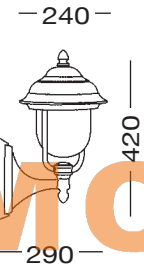

095-1140-NO30

EX ART. 01230

MODULO
ELECTRO

www.modulelectro.ru

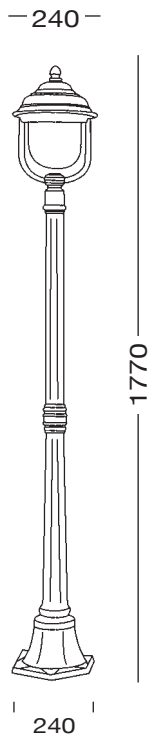

095-1143-NO30

EX ART. 01250

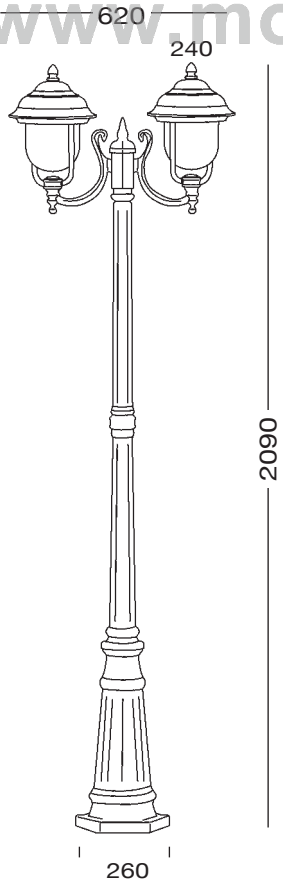

095-1144-NO30

EX ART. 01260

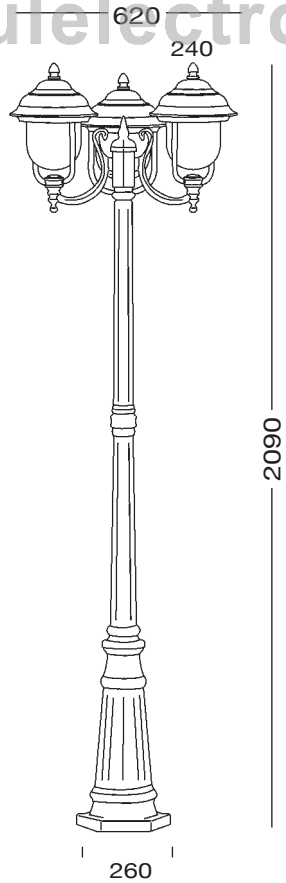

095-1145-NO30

EX ART. 01270



aluminium

MODULO
ELECTRO
www.modulelectro.ru



MODULO
ELECTRO
www.modulelectro.ru

CeZanne

For all technical inquiries or clarification please refer to our area distributor or local agent

Cezanne

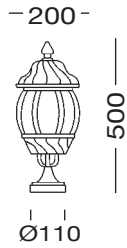

095-1155-NT30

EX ART. 01310



095-1156-NT30

EX ART. 01380



095-1154-NT30

EX ART. 01280



095-1150-NT30

EX ART. 01345

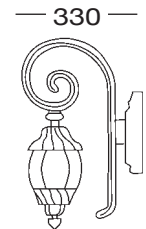

095-1151-NT30

EX ART. 01290



MODULO
ELECTRO

www.modulelectro.ru

470



095-1160-NT30

EX ART. 01320

700

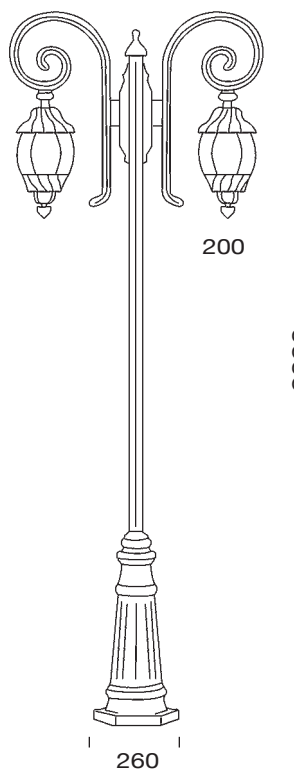

095-1161-NT30

EX ART. 01330

700

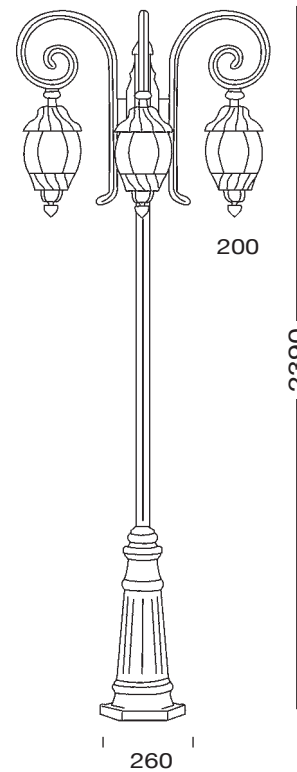







095-1162-NT30

EX ART. 01340

aluminium

Cezanne

	BLACK COLOUR
	GREEN COLOUR
	WHITE COLOUR
PC	TRANSPARENT OR OPAL

E 27
IP 44
100W 
23W 

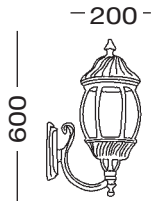

095-1150-NT30
EX ART. 01370

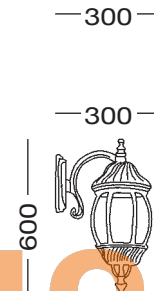

095-1153-NT30
EX ART. 01360

MODULO
ELECTRO

www.modulelectro.ru

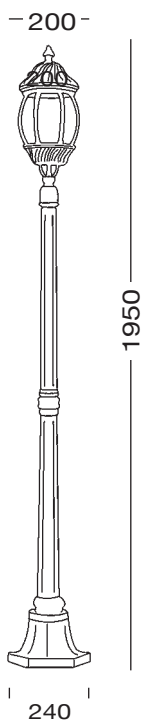

095-1157-NT30
EX ART. 01400

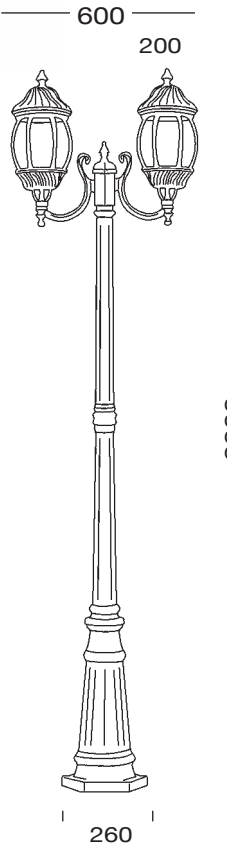

095-1158-NT30
EX ART. 01390

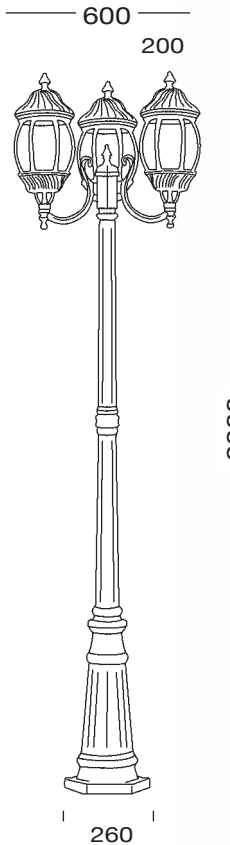

095-1159-NT30
EX ART. 01410



aluminium

MODULO
ELECTRO
www.modulelectro.ru



MODUL
ELECTRO
www.modulelectro.ru

Gauguin

For all technical inquiries or clarification please refer to our area distributor or local agent

Gauguin

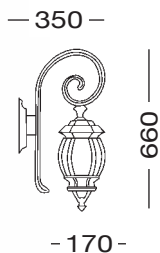

095-1165-NT30
EX ART. 01430

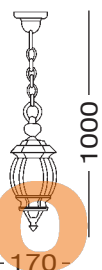

MODUL

095-1168-NT30 EX ART. 01470 **095-1170-NT30** EX ART. 01450

www.modulelectro.ru



095-1169-NT30
EX ART. 01510

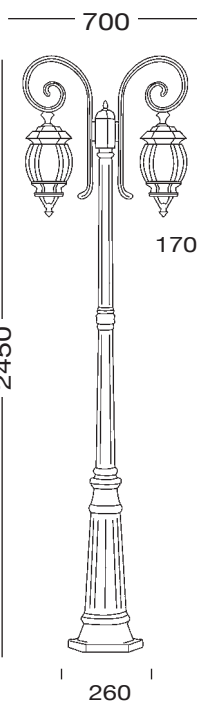

095-1175-NT30
EX ART. 01480

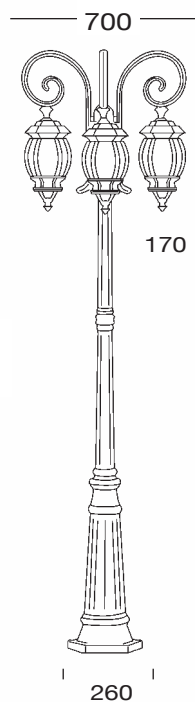







095-1176-NT30
EX ART. 01485



aluminium

Gauguin

	BLACK COLOUR
	GREEN COLOUR
	WHITE COLOUR
PC	TRANSPARENT OR OPAL

E 27
IP 44
100W 
23W 



095-1171-NT30
EX ART. 01500

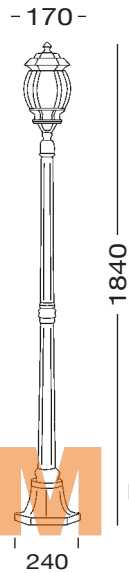

MODULO
ELECTRO
www.modulelectro.ru

095-1172-NT30
EX ART. 01530

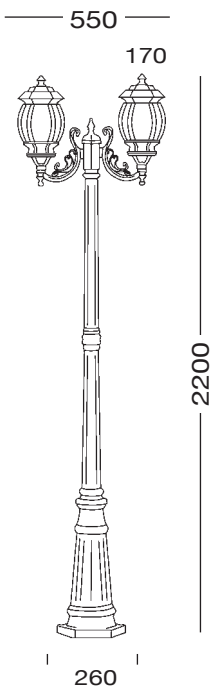

095-1173-NT30
EX ART. 01540

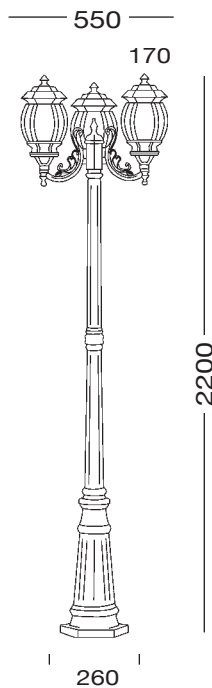

095-1174-NT30
EX ART. 01550



095-1166-NT30
EX ART. 01440



095-1167-NT30
EX ART. 01420

aluminium

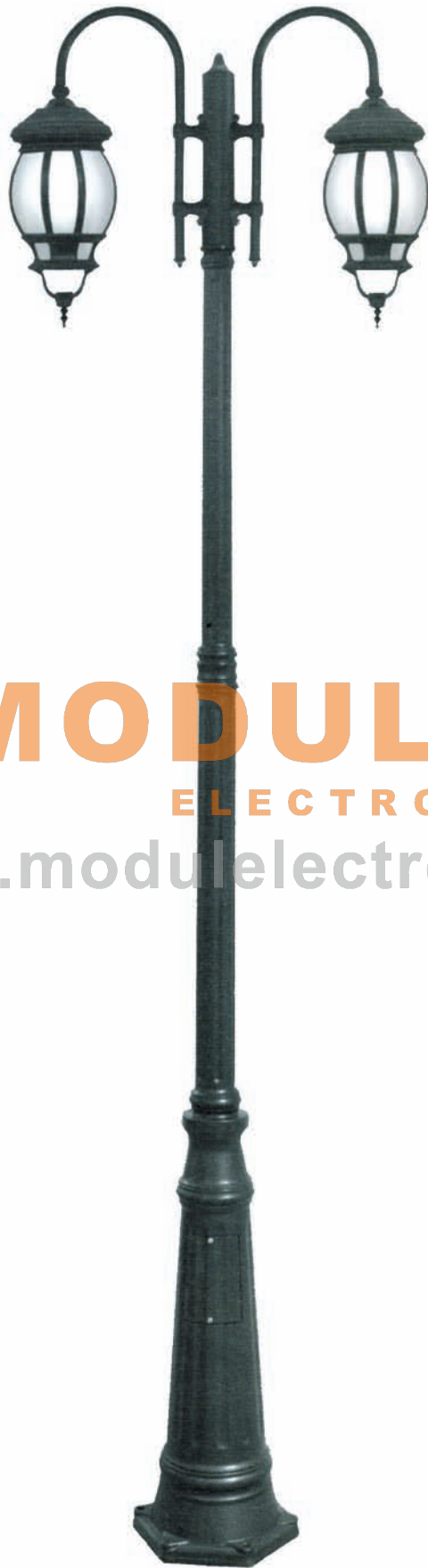

Raffaello





MODULO
ELECTRO
www.modulelectro.ru

For all technical inquiries or clarification please refer to our area distributor or local agent

Raffaello

	BLACK COLOUR
	GREEN COLOUR
	WHITE COLOUR
GLASS	TRANSPARENT OR SATINED

E 27
IP 44
100W 
23W 

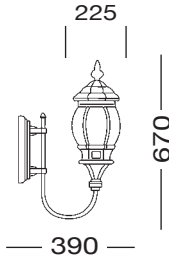

095-1180-NT30
EX ART. 01590

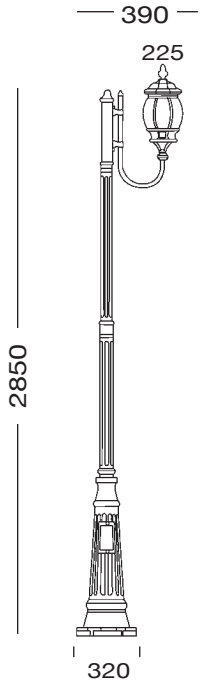

095-1181-NT30
EX ART. 01600

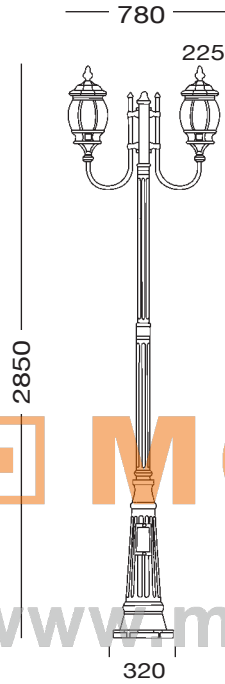

095-1182-NT30
EX ART. 01580

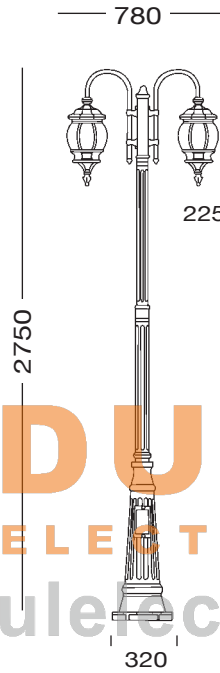

095-1183-NT30
EX ART. 01570

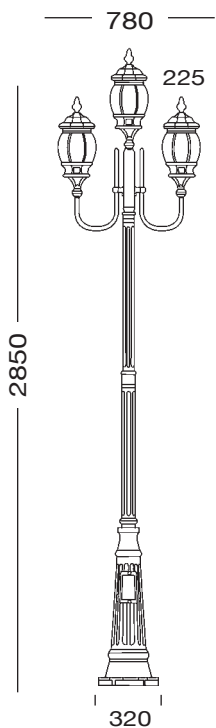

095-1184-NT30
EX ART. 01610

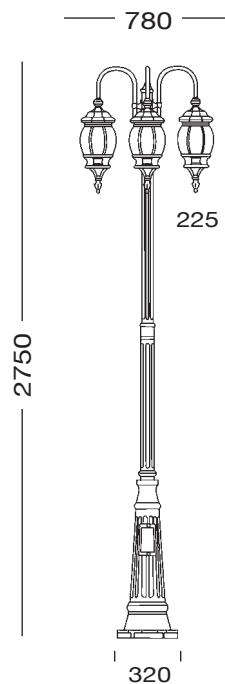

095-1185-NT30
EX ART. 01620

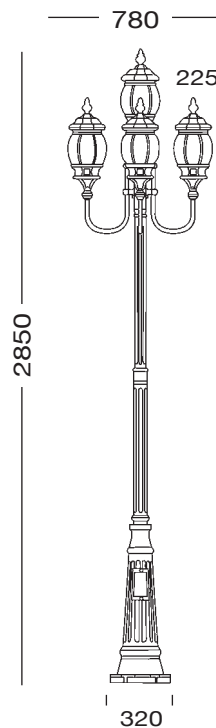

095-1186-NT30
EX ART. 01630



aluminium

MODUL
ELECTRO
www.modulelectro.ru

MODULO
ELECTRO
www.modulelectro.ru

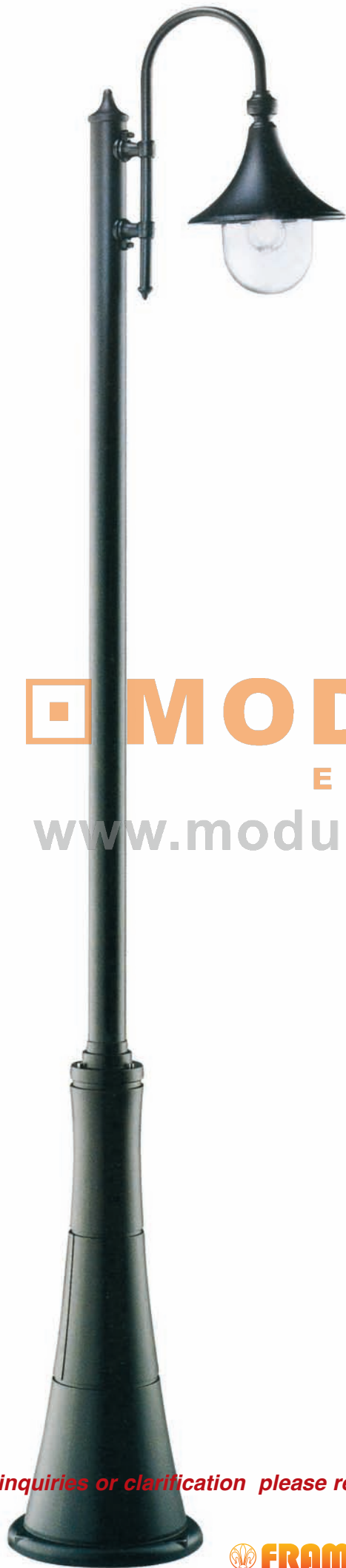

MODUL
ELECTRO
www.modulelectro.ru

For all technical inquiries or clarification please refer to our area distributor or local agent



Van Gogh

49 serie

Van Gogh

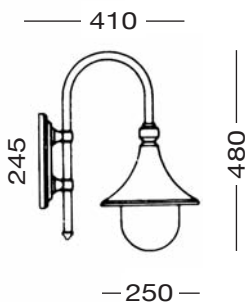

095-1200-NT30
EX ART. 01660

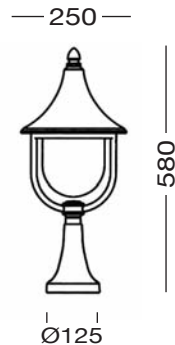

095-1202-NT30
EX ART. 01650

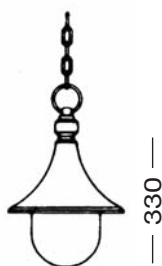

095-1201-NT30
EX ART. 01640

MODULO
ELECTRO

www.modulelectro.ru

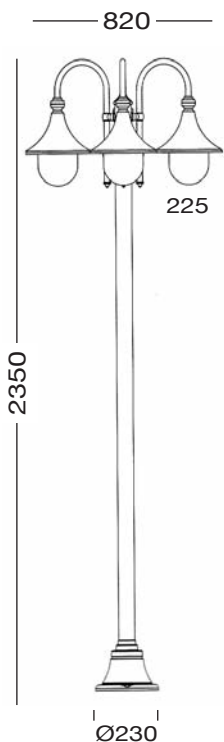

095-1206-NT30
EX ART. 01700

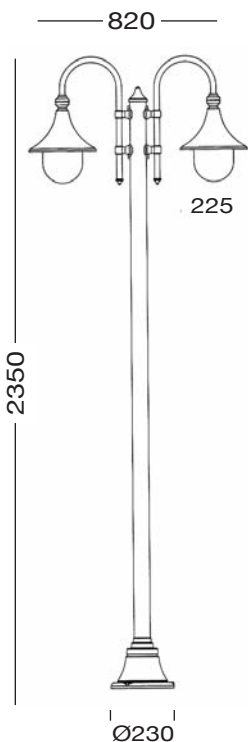

095-1205-NT30
EX ART. 01690

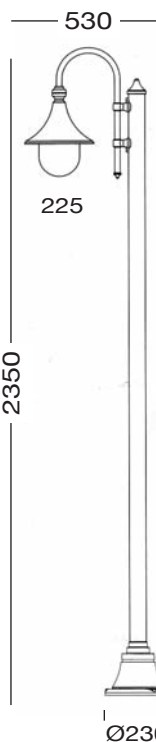

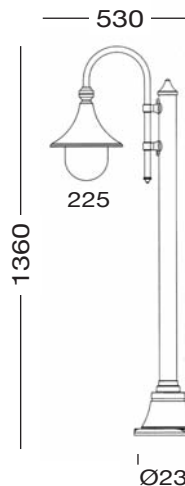
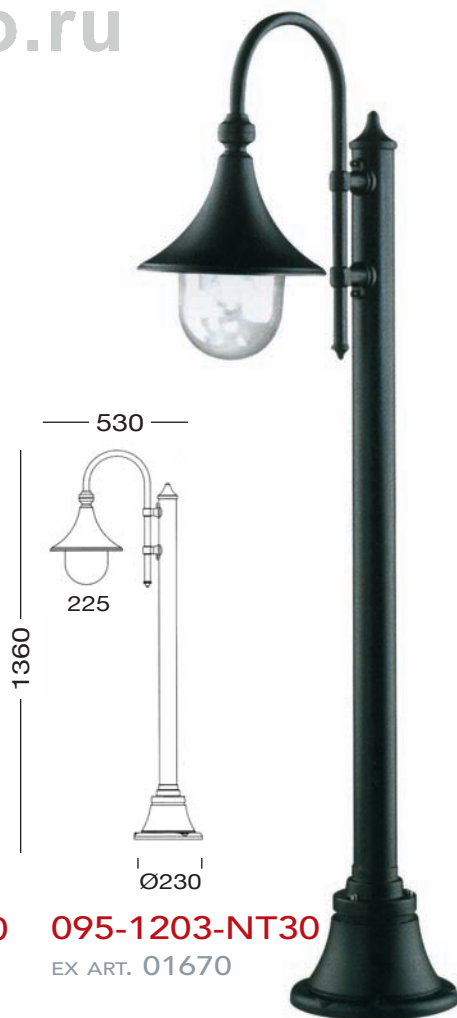

095-1204-NT30
EX ART. 01680





095-1203-NT30
EX ART. 01670

aluminium

Van Gogh

	BLACK COLOUR
	GREEN COLOUR
	WHITE COLOUR
PC	TRANSPARENT OR OPAL

E 27
IP 44
100W 
23W 

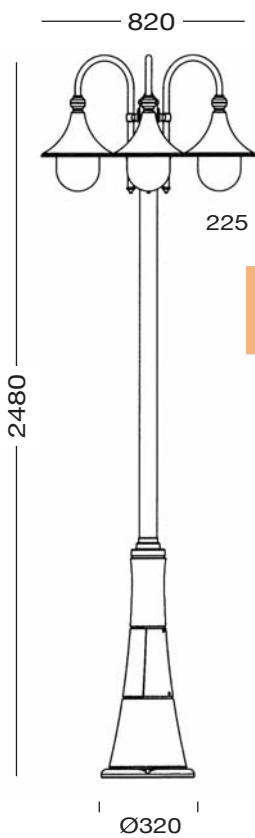
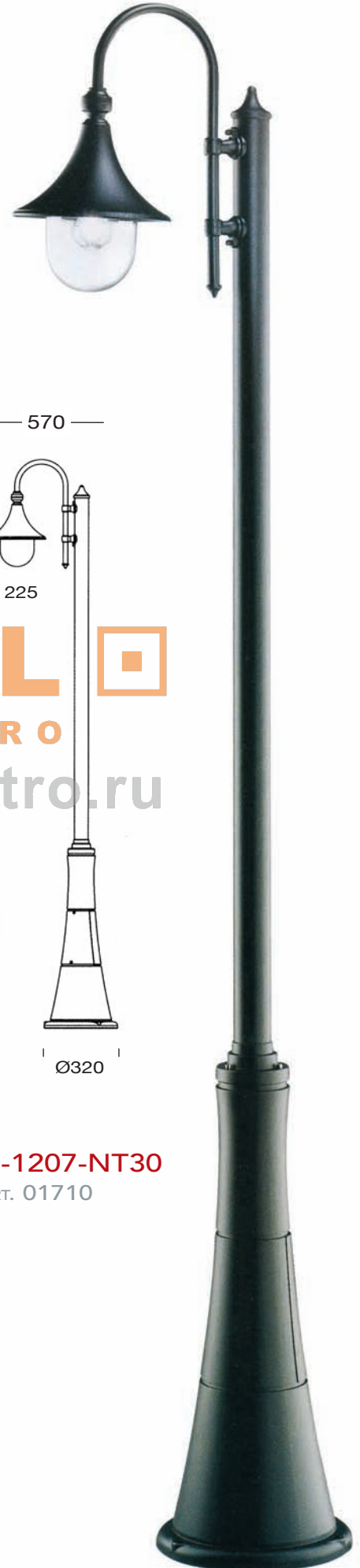

095-1209-NT30
EX ART. 01730

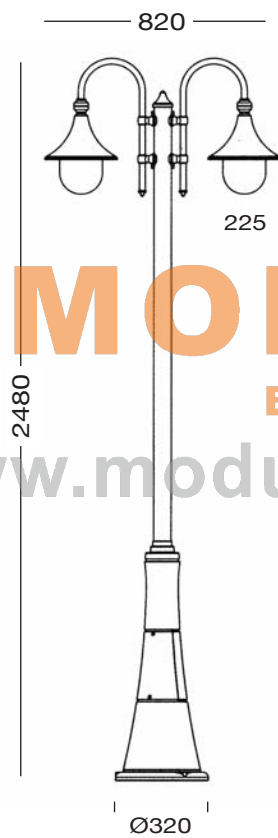

095-1208-NT30
EX ART. 01720

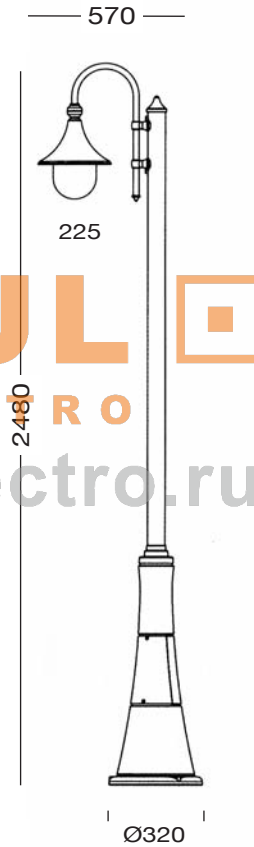

095-1207-NT30
EX ART. 01710

MODULO
ELECTRO
www.modulelectro.ru

Van Gogh

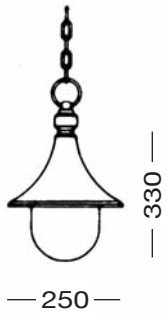

095-1201-RT30
EX ART. 01750

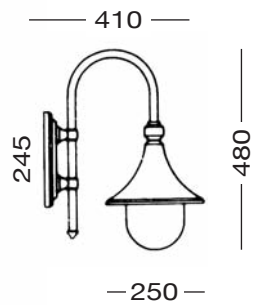

095-1200-RT30
EX ART. 01740

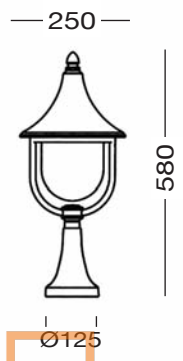

095-1202-RT30
EX ART. 01760

MODULO ELECTRO

www.modulelectro.ru

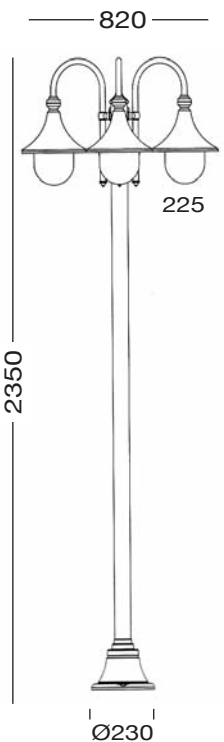

095-1206-RT30
EX ART. 01800

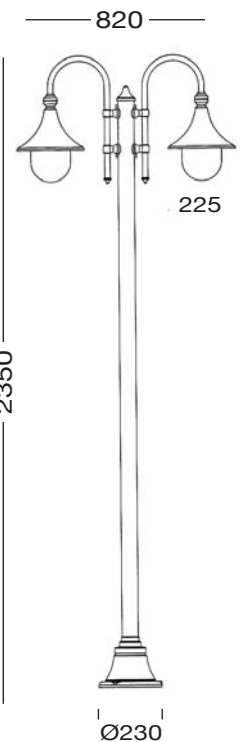

095-1205-RT30
EX ART. 01790

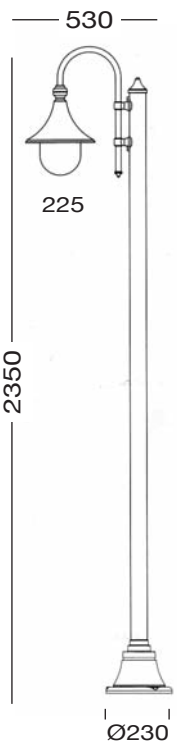

095-1204-RT30
EX ART. 01780

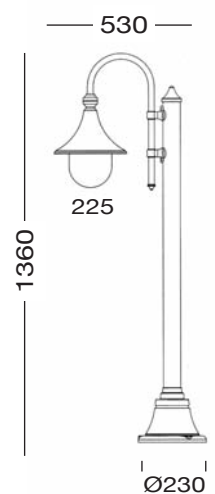







095-1203-RT30
EX ART. 01770



aluminium

Van Gogh

	BLACK COLOUR
	GREEN COLOUR
	WHITE COLOUR
PC	TRANSPARENT OR OPAL

E 27
IP 44
100W 
23W 

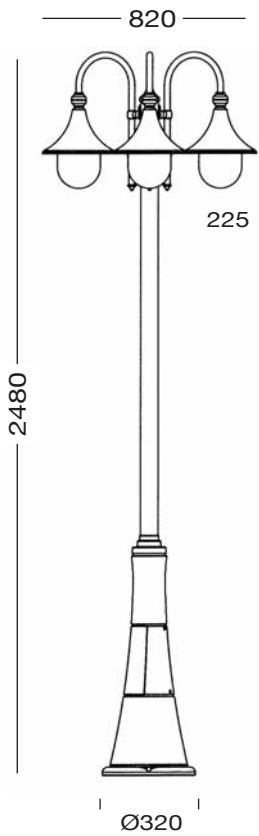

095-1209-RT30
EX ART. 01830

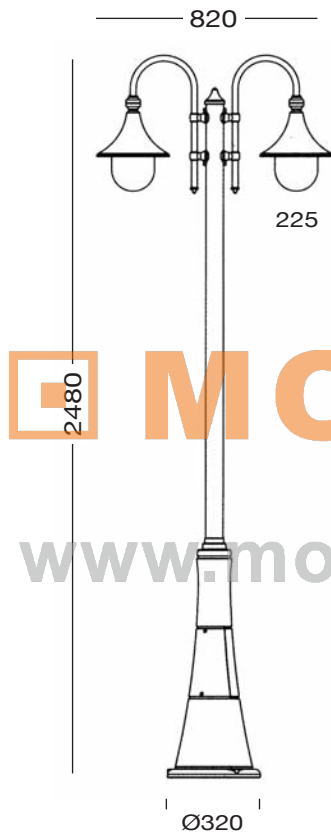

095-1208-RT30
EX ART. 01810



095-1207-RT30
EX ART. 01820

MODULO
ELECTRO
www.modulelectro.ru

Dali

serie

MODULO
ELECTRO
www.moduloelectro.ru

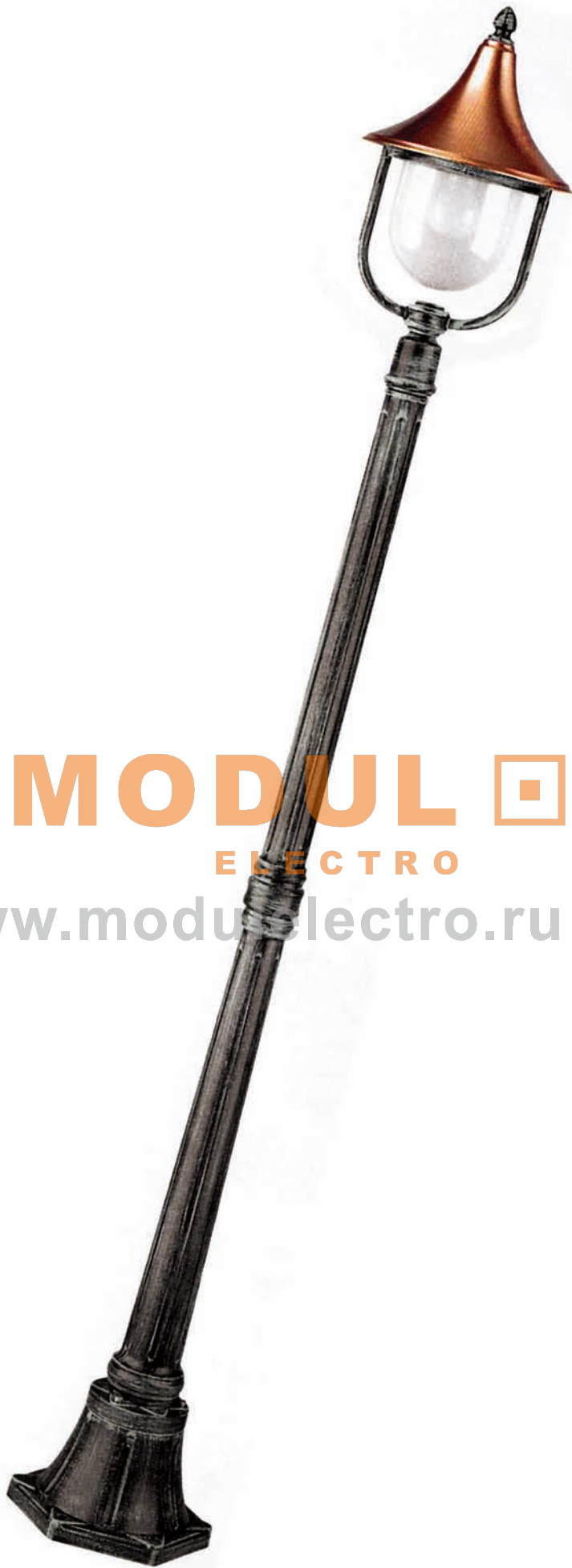

For all technical inquiries or clarification please refer to our area distributor or local agent