

MADE IN ITALY  
**TECHNICAL**

 **MODUL** 

 **FRAMION** ELECTRO <sup>®</sup> S.p.A.  
[www.modulelectro.it](http://www.modulelectro.it)

**2011**

  
**MODULO**  
**ELECTRO**  
[www.modulelectro.ru](http://www.modulelectro.ru)



 **MODUL**   
 **FRAMON** S.p.A. ©  
*fonderie componenti per illuminazione*  
[www.modulelectro.ru](http://www.modulelectro.ru)

2011

# Technical Series

## CARATTERISTICHE TECNICHE

Corpi: Alluminio  
 Coperture: Alluminio  
 Diffusore: Vetro temperato  
 Classe I  
 IP 66  
 Guarnizioni in silicone  
 Viti in acciaio inox  
 Colori: Nero **N** ■  
 Antracite **A** ■  
 Grigio **G** ■

## TECHNICAL SPECIFICATIONS

Bodies: Aluminium  
 Covers: Aluminium  
 Diffusers: Temperate glass  
 Class I  
 IP 66  
 Silicon Gaskets  
 Screws in stainless steel  
 Colors: Black **N** ■  
 Anthracite **A** ■  
 Grey **G** ■

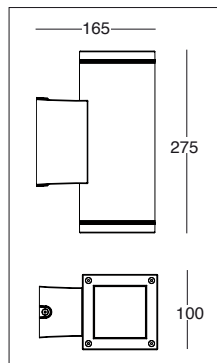







### MODELLO MODEL

### PORTALAMPADA LAMPHOLDER

### CODICE-CODE serie finita/assemblata cablata/verniciata

### CODICE-CODE kit non assemblato non cablato/verniciato

### CODICE-CODE kit non assemblato non cablato/non verniciato

 1 LUCE - 1 LIGHT	E27	 PAR 20 50W	<b>092-200-...30</b>	<b>095-200-...30</b>	<b>097-200-30</b>
	GU10	 PAR 20 50W	<b>092-200-...51</b>	<b>095-200-...51</b>	<b>097-200-51</b>
 2 LUCI - 2 LIGHTS	E27	 PAR 20 50W	<b>092-201-...30</b>	<b>095-201-...30</b>	<b>097-201-30</b>
	GU10	 PAR 20 50W	<b>092-201-...51</b>	<b>095-201-...51</b>	<b>097-201-51</b>

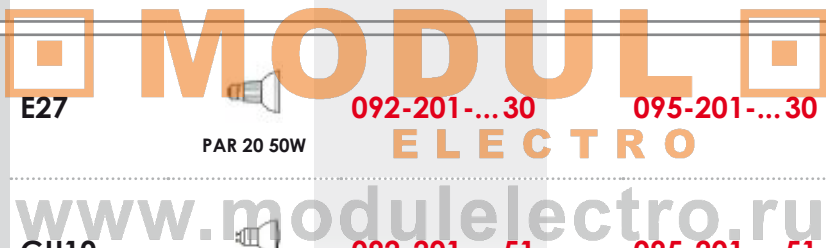

### COLORI DISPONIBILI - COLOR AVAILABLE

Scegliere il colore aggiungendo la lettera (N-A-G) al codice PRIMA DELLE ULTIME DUE CIFRE.  
 For choose the color to add the letter (N-A-G) BEFORE THE LAST TWO NUMBERS OF CODE.

 092-200-**N**30  
nero - black

 092-200-**A**30  
antracite - anthracite

 092-200-**G**30  
grigio - grey

### COMPONENTI - COMPONENTS

 <b>13016-A</b> E27	 <b>13015-A</b> GU10	 <b>F1273-06-050</b> kit viti per fissaggio vetri screws kit for glass fixing	 <b>13012-A</b> per versione 1 luce for 1 light version
 <b>13014-A</b> passacavo cable pass	 <b>13011-A</b> placca plate	 <b>13009-A</b> guarnizione gasket	 <b>13005-A</b> cornice - cover
 <b>13010-A</b> braccio arm	 <b>13017-A</b> guarnizione gasket	 <b>13000-A</b> corpo - body	 <b>13001-A</b> guarnizione - gasket
			 <b>13013-A</b> vetro - glass
			 <b>13006-A</b> guarnizione - gasket
			 <b>13007-A</b> ghiera - frame
			 <b>13008-A</b> guarnizione - gasket



**CARATTERISTICHE TECNICHE**

Corpi: Alluminio  
 Coperture: Alluminio  
 Diffusore: Vetro temperato  
 Classe I  
 IP 66  
 Guarnizioni in silicone  
 Viti in acciaio inox  
 Colori: Nero  
 Antracite  
 Grigio



**TECHNICAL SPECIFICATIONS**

Bodies: Aluminium  
 Covers: Aluminium  
 Diffusers: Temperate glass  
 Class I  
 IP 66  
 Silicon Gaskets  
 Screws in stainless steel  
 Colors: Black  
 Anthracite  
 Grey

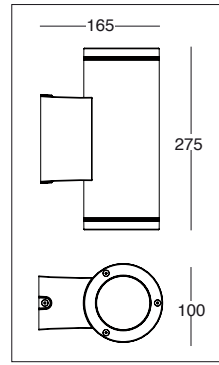







**MODELLO  
MODEL**

**PORTALAMPADA  
LAMPHOLDER**

**CODICE-CODE**  
serie finita/assemblata  
cablata/verniciata

**CODICE-CODE**  
kit non assemblato  
non cablato/verniciato

**CODICE-CODE**  
kit non assemblato  
non cablato/non verniciato

 1 LUCE - 1 LIGHT	E27	 PAR 20 50W	092-210-...30	095-210-...30	097-210-30
	GU10	 PAR 20 50W	092-210-...51	095-210-...51	097-210-51
 2 LUCI - 2 LIGHTS	E27	 PAR 20 50W	092-211-...30	095-211-...30	097-211-30
	GU10	 PAR 20 50W	092-211-...51	095-211-...51	097-211-51

**COLORI DISPONIBILI - COLOR AVAILABLE**

Scegliere il colore aggiungendo la lettera (N-A-G) al codice PRIMA DELLE ULTIME DUE CIFRE.  
 For choose the color to add the letter (N-A-G) BEFORE THE LAST TWO NUMBERS OF CODE.

 092-210-**N**30  
nero - black

 092-210-**A**30  
antracite - anthracite

 092-210-**G**30  
grigio - grey

**COMPONENTI - COMPONENTS**

 <b>13016-A</b> E27	 <b>13015-A</b> GU10	 <b>F1273-06-050</b> kit viti per fissaggio vetri screws kit for glass fixing	 <b>13112-A</b> per versione 1 luce for 1 light version
 <b>13014-A</b> passacavo cable pass	 <b>13011-A</b> placca plate	 <b>13009-A</b> guarnizione gasket	 <b>13105-A</b> cornice - cover
 <b>13110-A</b> braccio arm	 <b>13017-A</b> guarnizione gasket	 <b>13100-A</b> corpo - body	 <b>13111-A</b> guarnizione - gasket
			 <b>13113-A</b> vetro - glass
			 <b>13106-A</b> guarnizione - gasket
			 <b>13107-A</b> ghiera - frame
			 <b>13108-A</b> guarnizione - gasket

## CARATTERISTICHE TECNICHE

Corpi: Alluminio  
 Coperture: Alluminio  
 Diffusore: Vetro temperato  
 Classe I  
 IP 65  
 Guarnizioni in silicone  
 Viti in acciaio inox  
 Colori: Nero **N** ■  
 Antracite **A** ■  
 Grigio **G** ■

## TECHNICAL SPECIFICATIONS

Bodies: Aluminium  
 Covers: Aluminium  
 Diffusers: Temperate glass  
 Class I  
 IP 65  
 Silicon Gaskets  
 Screws in stainless steel  
 Colors: Black **N** ■  
 Anthracite **A** ■  
 Grey **G** ■

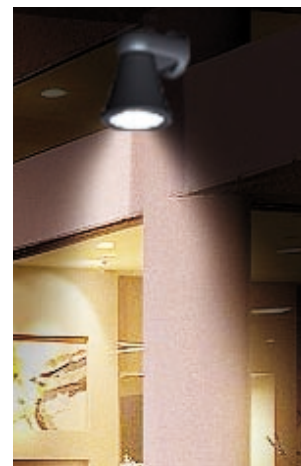
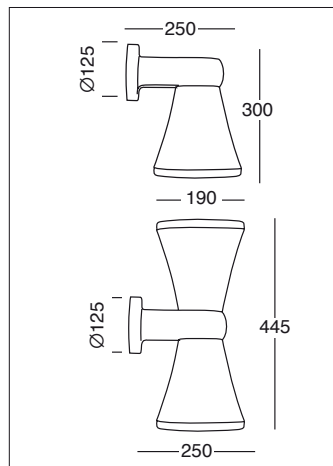







### MODELLO MODEL

### PORTALAMPADA LAMPHOLDER

### CODICE-CODE serie finita/assemblata cablata/verniciata

### CODICE-CODE kit non assemblato non cablato/verniciato

### CODICE-CODE kit non assemblato non cablato/non verniciato

 1 LUCE - 1 LIGHT	E27	 75W	092-212-...30	095-212-...30	097-212-30
	GX24d-3	 TC-D 26W	092-212-...40	095-212-...40	097-212-40
 2 LUCI - 2 LIGHTS	E27	 75W	092-213-...30	095-213-...30	097-213-30
	GX24d-3	 TC-D 26W	092-213-...40	095-213-...40	097-213-40

MODULO ELECTRO  
www.modulelectro.ru

### COLORI DISPONIBILI - COLOR AVAILABLE

Scegliere il colore aggiungendo la lettera (N-A-G) al codice PRIMA DELLE ULTIME DUE CIFRE.  
 For choose the color to add the letter (N-A-G) BEFORE THE LAST TWO NUMBERS OF CODE.



092-212-**N**30  
nero - black



092-212-**A**30  
antracite - anthracite



092-212-**G**30  
grigio - grey

### COMPONENTI - COMPONENTS



**5975-A**  
cornice in alluminio  
aluminium cover



**7184-A**  
guarnizione - gasket



**7879-A**  
vetro temperato  
temperate glass



**5965-A**  
ghiera - frame



**7911-A**  
riflettore - reflector



**7188-A**  
guarnizione - gasket



**2300-A**  
corpo in alluminio  
aluminium body



**7189-A**  
guarnizione - gasket



**1032-A**  
braccio - arm  
**1032-A-1**  
braccio 1 luce  
1 light arm



**8144-A**  
accessorio  
accessory



**097-TM125**  
guarnizione  
gasket



**1354-A**  
piastra  
plate



**7003-A**  
passacavo  
cable pass



**CARATTERISTICHE TECNICHE**

Corpi: Alluminio  
 Coperture: Alluminio  
 Diffusore: Vetro temperato  
 Classe I  
 IP 65  
 Guarnizioni in silicone  
 Viti in acciaio inox  
 Colori: Nero  
 Antracite  
 Grigio

**N** ■  
**A** ■  
**G** ■

**TECHNICAL SPECIFICATIONS**

Bodies: Aluminium  
 Covers: Aluminium  
 Diffusers: Temperate glass  
 Class I  
 IP 65  
 Silicon Gaskets  
 Screws in stainless steel  
 Colors: Black  
 Anthracite  
 Grey

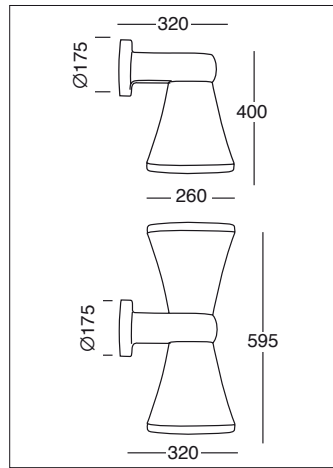









**MODELLO  
MODEL**

**PORTALAMPADA  
LAMPHOLDER**

**CODICE-CODE**  
serie finita/assemblata  
cablata/verniciata

**CODICE-CODE**  
kit non assemblato  
non cablato/verniciato

**CODICE-CODE**  
kit non assemblato  
non cablato/non verniciato

 1 LUCE - 1 LIGHT	<b>E27</b>  75W	<b>092-214-...30</b>	<b>095-214-...30</b>	<b>097-214-30</b>
	<b>E27 HQI</b> <i>discharge lamp</i>  HQI 70W	<b>092-214-...14</b>	<b>095-214-...14</b>	<b>097-214-14</b>
	<b>GX24d-3</b>  TC-D 26W	<b>092-214-...40</b>	<b>095-214-...40</b>	<b>097-214-40</b>
 2 LUCI - 2 LIGHTS	<b>E27</b>  75W	<b>092-215-...30</b>	<b>095-215-...30</b>	<b>097-215-30</b>
	<b>E27 HQI</b> <i>discharge lamp</i>  HQI 70W	<b>092-215-...14</b>	<b>095-215-...14</b>	<b>097-215-14</b>
	<b>GX24d-3</b>  TC-D 26W	<b>092-215-...40</b>	<b>095-215-...40</b>	<b>097-215-40</b>

**COLORI DISPONIBILI - COLOR AVAILABLE**

Scegliere il colore aggiungendo la lettera (N-A-G) al codice PRIMA DELLE ULTIME DUE CIFRE.  
 For choose the color to add the letter (N-A-G) BEFORE THE LAST TWO NUMBERS OF CODE.

■ 092-214-**N**30  
nero - black

■ 092-214-**A**30  
antracite - anthracite

■ 092-214-**G**30  
grigio - grey

**COMPONENTI - COMPONENTS**

 <b>5970-A</b> cornice in alluminio aluminium cover	 <b>7910-A</b> riflettore - reflector
 <b>7183-A</b> guarnizione - gasket	 <b>097-TM105</b> guarnizione - gasket
 <b>7880-A</b> vetro temperato temperate glass	 <b>097-TM120</b> corpo in alluminio aluminium body
 <b>5960-A</b> ghiera - frame	 <b>097-TM125</b> guarnizione - gasket
	 <b>1033-A</b> braccio - arm  <b>1033-A-1</b> braccio 1 luce 1 light arm
	 <b>8143-A</b> accessorio accessory
	 <b>8133-A</b> guarnizione gasket
	 <b>1353-A</b> piastra plate
	 <b>7003-A</b> passacavo cable pass

# Technical Series

## CARATTERISTICHE TECNICHE

Corpi: Alluminio  
 Coperture: Alluminio  
 Diffusore: Vetro temperato  
 Classe I  
 IP 65  
 Guarnizioni in silicone  
 Viti in acciaio inox  
 Colori: Nero **N** ■  
 Antracite **A** ■  
 Grigio **G** ■

## TECHNICAL SPECIFICATIONS

Bodies: Aluminium  
 Covers: Aluminium  
 Diffusers: Temperate glass  
 Class I  
 IP 65  
 Silicon Gaskets  
 Screws in stainless steel  
 Colors: Black **N** ■  
 Anthracite **A** ■  
 Grey **G** ■



www.modulelectro.ru

## COMPONENTI - COMPONENTS



**13203-A**  
 corpo esterno  
 external body



**13201-A**  
 corpo interno  
 internal body



**7003-A**  
 passacavo  
 cable pass



**13204-A**  
 accessorio  
 accessory



**13207-A**  
 riflettore  
 reflector



**13206-A**  
 guarnizione  
 gasket



**13202-A**  
 policarbonato trasparente  
 transparent polycarbonate



**13205-A**  
 guarnizione  
 gasket



**13200-A**  
 cornice - cover

**13202-A-O**  
 policarbonato opale  
 opal polycarbonate



**13219-A**  
 copertura - cover



**13218-A**  
 placca - plate

**13220-A**  
 h. 500

**13221-A**  
 h. 750

**13222-A**  
 h. 1000



**13225-A**  
 h. 500



**13226-A**  
 h. 750



**13227-A**  
 h. 1000



**13220-A-10**  
 h. 500



**13221-A-10**  
 h. 750

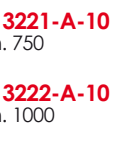

**13222-A-10**  
 h. 1000



**13209-A**  
 placca - plate



MODELLO MODEL	PORTALAMPADA LAMPHOLDER	CODICE-CODE serie finita/assemblata cablata/verniciata	CODICE-CODE kit non assemblato non cablato/verniciato	CODICE-CODE kit non assemblato non cablato/non verniciato
	<b>GX24d-3</b>  TC-D 26W	<b>092-300-... 40</b>	<b>095-300-... 40</b>	<b>097-300-40</b>

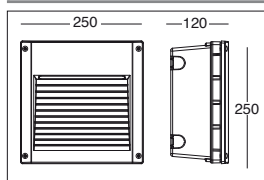



**COLORI DISPONIBILI - COLOR AVAILABLE**

Scegliere il colore aggiungendo la lettera (N-A-G) al codice PRIMA DELLE ULTIME DUE CIFRE.  
For choose the color to add the letter (N-A-G) BEFORE THE LAST TWO NUMBERS OF CODE.

 **092-300-N40**  
nero - black

 **092-300-A40**  
antracite - anthracite

 **092-300-G40**  
grigio - grey

MODELLO MODEL	PORTALAMPADA LAMPHOLDER	CODICE-CODE serie finita/assemblata cablata/verniciata	CODICE-CODE kit non assemblato non cablato/verniciato	CODICE-CODE kit non assemblato non cablato/non verniciato
 h.500	<b>GX24d-3</b>  TC-D 26W	<b>092-301-... 40</b>	<b>095-301-... 40</b>	<b>097-301-40</b>

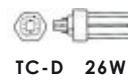

[www.modulelectro.ru](http://www.modulelectro.ru)

 h.750	<b>GX24d-3</b>  TC-D 26W	<b>092-302-... 40</b>	<b>095-302-... 40</b>	<b>097-302-40</b>
--	---	-----------------------	-----------------------	-------------------

 h.1000	<b>GX24d-3</b>  TC-D 26W	<b>092-303-... 40</b>	<b>095-303-... 40</b>	<b>097-303-40</b>
---	---	-----------------------	-----------------------	-------------------

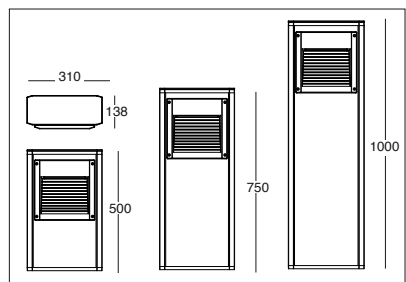

**COLORI DISPONIBILI - COLOR AVAILABLE**

Scegliere il colore aggiungendo la lettera (N-A-G) al codice PRIMA DELLE ULTIME DUE CIFRE.  
For choose the color to add the letter (N-A-G) BEFORE THE LAST TWO NUMBERS OF CODE.

 **092-301-N40**  
nero - black

 **092-301-A40**  
antracite - anthracite

 **092-301-G40**  
grigio - grey

# Technical Series

## CARATTERISTICHE TECNICHE

Corpi: Alluminio  
 Coperture: Alluminio  
 Diffusore: Vetro temperato  
 Classe I  
 IP 65  
 Guarnizioni in silicone  
 Viti in acciaio inox  
 Colori: Nero **N** ■  
 Antracite **A** ■  
 Grigio **G** ■

## TECHNICAL SPECIFICATIONS

Bodies: Aluminium  
 Covers: Aluminium  
 Diffusers: Temperate glass  
 Class I  
 IP 65  
 Silicon Gaskets  
 Screws in stainless steel  
 Colors: Black **N** ■  
 Anthracite **A** ■  
 Grey **G** ■



**MODUL**  
ELECTRO

[www.modulelectro.ru](http://www.modulelectro.ru)

## COMPONENTI - COMPONENTS



**13213-A**  
corpo esterno  
external body



**13211-A**  
corpo interno  
internal body



**7003-A**  
passacavo  
cable pass



**13214-A**  
accessorio  
accessory



**13207-A**  
riflettore  
reflector



**13216-A**  
guarnizione  
gasket



**13202-A**  
poli-carbonato trasparente  
transparent polycarbonate

**13202-A-O**  
poli-carbonato opale  
opal polycarbonate



**13205-A**  
guarnizione  
gasket



**13210-A**  
cornice - cover



**13219-A**  
copertura - cover



**13218-A**  
placca - plate

**13220-A**  
h. 500

**13221-A**  
h. 750

**13222-A**  
h. 1000

**13225-A**  
h. 500

**13226-A**  
h. 750

**13227-A**  
h. 1000

**13220-A-20**  
h. 500

**13221-A-20**  
h. 750

**13222-A-20**  
h. 1000



**13209-A**  
placca - plate

MODELLO MODEL	PORTALAMPADA LAMPHOLDER	CODICE-CODE serie finita/assemblata cablata/verniciata	CODICE-CODE kit non assemblato non cablato/verniciato	CODICE-CODE kit non assemblato non cablato/non verniciato
	<b>GX24d-3</b>  TC-D 26W	<b>092-310-... 40</b>	<b>095-310-... 40</b>	<b>097-310-40</b>

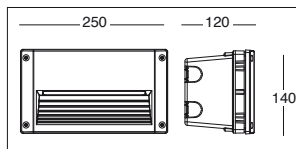



**COLORI DISPONIBILI - COLOR AVAILABLE**

Scegliere il colore aggiungendo la lettera (N-A-G) al codice PRIMA DELLE ULTIME DUE CIFRE.  
For choose the color to add the letter (N-A-G) BEFORE THE LAST TWO NUMBERS OF CODE.

 092-310-**N**40  
nero - black

 092-310-**A**40  
antracite - anthracite

 092-310-**G**40  
grigio - grey

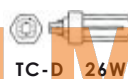
MODELLO MODEL	PORTALAMPADA LAMPHOLDER	CODICE-CODE serie finita/assemblata cablata/verniciata	CODICE-CODE kit non assemblato non cablato/verniciato	CODICE-CODE kit non assemblato non cablato/non verniciato
 h.500	<b>GX24d-3</b>  TC-D 26W	<b>092-311-... 40</b>	<b>095-311-... 40</b>	<b>097-311-40</b>



[www.modulelectro.ru](http://www.modulelectro.ru)

 h.750	<b>GX24d-3</b>  TC-D 26W	<b>092-312-... 40</b>	<b>095-312-... 40</b>	<b>097-312-40</b>
--	---	-----------------------	-----------------------	-------------------

 h.1000	<b>GX24d-3</b>  TC-D 26W	<b>092-313-... 40</b>	<b>095-313-... 40</b>	<b>097-313-40</b>
---	---	-----------------------	-----------------------	-------------------

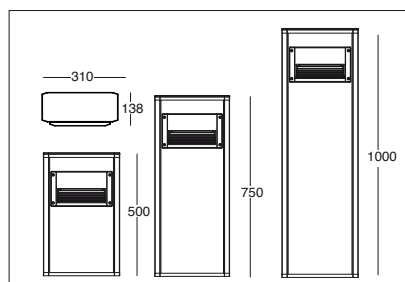

**COLORI DISPONIBILI - COLOR AVAILABLE**

Scegliere il colore aggiungendo la lettera (N-A-G) al codice PRIMA DELLE ULTIME DUE CIFRE.  
For choose the color to add the letter (N-A-G) BEFORE THE LAST TWO NUMBERS OF CODE.

 092-311-**N**40  
nero - black

 092-311-**A**40  
antracite - anthracite

 092-311-**G**40  
grigio - grey

**CARATTERISTICHE TECNICHE**

Corpi: Alluminio  
 Coperture: Alluminio  
 Diffusore: Vetro temperato  
 Classe II  
 IP 67  
 Guarnizioni in silicone  
 Viti in acciaio inox  
 Colori: Nero **N ■**

**TECHNICAL SPECIFICATIONS**

Bodies: Aluminium  
 Covers: Aluminium  
 Diffusers: Temperate glass  
 Class II  
 IP 67  
 Silicon Gaskets  
 Screws in stainless steel  
 Colors: Black **N ■**

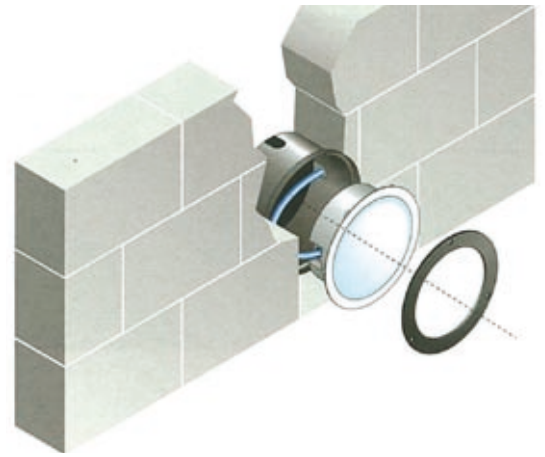

**COMPONENTI - COMPONENTS**



**14200-A**  
 Ø 228 x H 9  
 cornice in alluminio  
 aluminium cover



**14201-A**  
 Ø 228 x H 9  
 cornice in alluminio  
 aluminium cover



**14210-A-O**  
 Ø 195 x H 16  
 vetro opale - opal glass

**14210-A**  
 Ø 195 x H 16  
 vetro trasparente  
 transparent glass



**14111-A**  
 porta componenti  
 components-holder



**14223-A**  
 guarnizione - gasket



**14224-A**  
 Ø 228 x H 100  
 corpo interno  
 polycarbonato  
 polycarbonate  
 internal body



**14202-A**  
 Ø 228 x H 39  
 cornice in alluminio  
 aluminium cover



**14203-A**  
 Ø 228 x H 54  
 cornice in alluminio  
 aluminium cover



**14204-A**  
 Ø 228 x H 54  
 cornice in alluminio  
 aluminium cover



**14211-A**  
 Ø 195 x H 32  
 vetro trasparente  
 transparent glass

**14211-A-O**  
 Ø 195 x H 32  
 vetro opale - opal glass



**14225-A**  
 Ø 230 x H 114  
 corpo esterno  
 polycarbonato  
 polycarbonate  
 external body



**7003-A**  
 passacavo  
 cable pass



MODELLO MODEL	PORTALAMPADA LAMPHOLDER	CODICE-CODE serie finita/assemblata cablata/verniciata	CODICE-CODE kit non assemblato non cablato/verniciato	CODICE-CODE kit non assemblato non cablato/non verniciato
	E27  INC 40W	092-240-N30	095-240-N30	097-240-30
	G23  DULUX S 7W	092-240-N44	095-240-N44	097-240-44

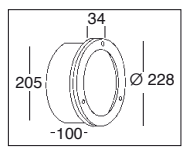

	E27  INC 40W	092-241-N30	095-241-N30	097-241-30
	G23  DULUX S 7W	092-241-N44	095-241-N44	097-241-44

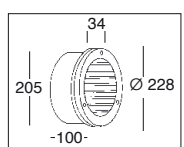

	E27  INC 40W	092-242-N30	095-242-N30	097-242-30
	G23  DULUX S 7W	092-242-N44	095-242-N44	097-242-44

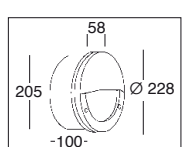

	E27  INC 40W	092-243-N30	095-243-N30	097-243-30
	G23  DULUX S 7W	092-243-N44	095-243-N44	097-243-44

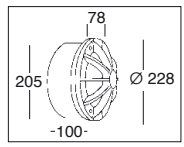

	E27  INC 40W	092-244-N30	095-244-N30	097-244-30
	G23  DULUX S 7W	092-244-N44	095-244-N44	097-244-44

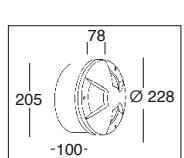

**MODULO**  
**ELECTRO**  
[www.modulelectro.ru](http://www.modulelectro.ru)

### CARATTERISTICHE TECNICHE

Corpi: Alluminio  
 Coperture: Alluminio  
 Diffusore: Vetro temperato  
 Classe I  
 IP 67  
 Guarnizioni in silicone  
 Viti in acciaio inox  
 Colori: Nero **N ■**

### TECHNICAL SPECIFICATIONS

Bodies: Aluminium  
 Covers: Aluminium  
 Diffusers: Temperate glass  
 Class I  
 IP 67  
 Silicon Gaskets  
 Screws in stainless steel  
 Colors: Black **N ■**

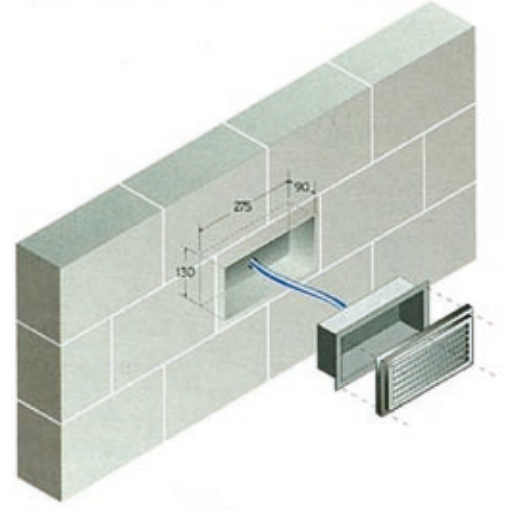
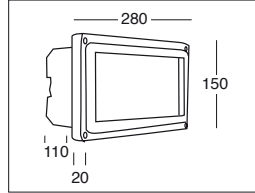

MODELLO MODEL	PORTALAMPADA LAMPHOLDER	CODICE-CODE serie finita/assemblata cablata/verniciata	CODICE-CODE kit non assemblato non cablato/verniciato	CODICE-CODE kit non assemblato non cablato/non verniciato
	E27 DULUX EL 20W	092-015-N30	095-015-N30	097-015-30
	G24d-2 DULUX D 18W	092-015-N41	095-015-N41	097-015-41
	E27 DULUX EL 20W	092-016-N30	095-016-N30	097-016-30
	G24d-2 DULUX D 18W	092-016-N41	095-016-N41	097-016-41

### COMPONENTI - COMPONENTS



**14250-A**  
L 280 x L 150 x H 25  
cornice in alluminio  
aluminium cover



**14251-A**  
L 280 x L 150 x H 25  
cornice in alluminio  
aluminium cover



**14252-A**  
L 265 x L 135 x H 4  
vetro - glass

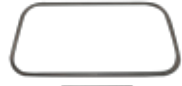

**14253-A**  
guarnizione - gasket



**14254-A**  
riflettore - reflector



**14255-A**  
L 270 x L 140 x H 75  
corpo interno  
internal body



**14256-A**  
L 270 x L 140 x H 75  
corpo esterno  
in policarbonato  
polycarbonate  
external body



**7003-A**  
passacavo  
cable pass



**CARATTERISTICHE TECNICHE**

Corpi: Alluminio  
Coperture: Alluminio  
Diffusore: Vetro temperato  
Classe I  
IP 67  
Guarnizioni in silicone  
Viti in acciaio inox  
Colori: Nero **N ■**

**TECHNICAL SPECIFICATIONS**

Bodies: Aluminium  
Covers: Aluminium  
Diffusers: Temperate glass  
Class I  
IP 67  
Silicon Gaskets  
Screws in stainless steel  
Colors: Black **N ■**

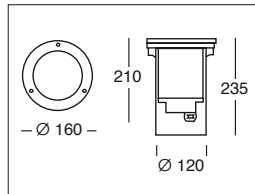



**MODELLO  
MODEL**

**PORTALAMPADA  
LAMPHOLDER**

**CODICE-CODE**  
serie finita/assemblata  
cablata/verniciata

**CODICE-CODE**  
kit non assemblato  
non cablato/verniciato

**CODICE-CODE**  
kit non assemblato  
non cablato/non verniciato

 <b>SMALL LED</b> <b>NON CALPESTABILE NOT WALKWAY LED</b>	<b>E27</b>	 INC. 50W	<b>092-226-N30</b>	<b>095-226-N30</b>	<b>097-226-30</b>
	<b>GY6,35</b>	 ALOS 50W	<b>092-226-N44</b>	<b>095-226-N44</b>	<b>097-226-44</b>

**COMPONENTI - COMPONENTS**



**14240-A**  
Ø 160 x H 9  
cornice in alluminio  
aluminium cover



**14242-A**  
guarnizione - gasket



**14244-A**  
Ø 104 x H 36  
corpo interno  
internal body



**14241-A**  
Ø 135 x H 15  
vetro trasparente  
transparent glass



**14246-A**  
guarnizione - gasket

**14241-A-O**  
Ø 135 x H 15  
vetro opale  
opal glass



**14245-A**  
Ø 165 x H 235  
corpo esterno  
in policarbonato  
polycarbonate  
external body



**14243-A**  
Ø 160 x H 137  
corpo interno  
internal body



**8122-A**  
pressacavo 2pcs  
cable gland 2pcs

## CARATTERISTICHE TECNICHE

Corpi: Alluminio  
 Coperture: Alluminio/Acciaio  
 Diffusore: Vetro temperato  
 Classe I  
 IP 67  
 Guarnizioni in silicone  
 Viti in acciaio inox  
 Colori: Nero **N** ■  
 Grigio **G** ■  
 Acciaio **AC** ■

## TECHNICAL SPECIFICATIONS

Bodies: Aluminium  
 Covers: Aluminium/Steel  
 Diffusers: Temperate glass  
 Class I  
 IP 67  
 Silicon Gaskets  
 Screws in stainless steel  
 Colors: Black **N** ■  
 Grey **G** ■  
 Steel **AC** ■



**MODULO**  
**ELECTRO**

[www.modulelectro.ru](http://www.modulelectro.ru)

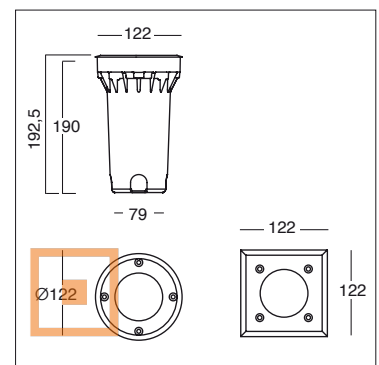

## COMPONENTI - COMPONENTS



**14001-A**  
 cornice quadra  
 in acciaio INOX  
 STAIN LESS steel  
 square cover

**14001-S**  
 cornice quadra  
 in acciaio INOX con  
 logo framon  
 STAIN LESS steel square  
 cover with framon logo



**14002-A**  
 cornice tonda  
 in acciaio INOX  
 STAIN LESS steel  
 round cover

**14002-S**  
 cornice tonda  
 in acciaio INOX con  
 logo framon  
 STAIN LESS steel round  
 cover with framon logo



**14000-A**  
 cornice tonda  
 in alluminio  
 aluminium round cover



**14003-A**  
 anello in alluminio,  
 accessorio per cornici acciaio  
 aluminium ring,  
 accessory for steel cover



**7997-A**  
 riflettore per G9  
 reflector for G9



**14012-A**  
 piastra orientabile  
 per GU10 e GU5,3  
 adjustable plate  
 for GU10 & GU5,3



**14004-A**  
 vetro temperato  
 temperate glass



**14005-A**  
 guarnizione - gasket



**14006-A**  
 corpo interno  
 in alluminio  
 aluminium  
 internal body



**14010-A**  
 pressacavo 2pcs  
 cable gland 2pcs



**14007-A**  
 corpo esterno  
 in policarbonato  
 polycarbonate  
 external body







**14009-A**  
 kit viteria - screw kit



**14011-A**  
 piastra porta componenti  
 components holder plate





MODELLO MODEL	PORTALAMPADA LAMPHOLDER	CODICE-CODE serie finita/assemblata cablata/verniciata	CODICE-CODE kit non assemblato non cablato/verniciato	CODICE-CODE kit non assemblato non cablato/non verniciato
 CORNICE ALLUMINIO ALUMINIUM COVER	<b>GU10</b> 1900 lm  MAX 35W	<b>092-220-... 51</b>	<b>095-220-... 51</b>	<b>097-220-51</b>
	<b>GU5,3</b> 900 lm 12v  MAX 35W	<b>092-220-... 20</b>	<b>095-220-... 20</b>	<b>097-220-20</b>
	<b>G9</b> 500 lm  MAX 40W	<b>092-220-... 50</b>	<b>095-220-... 50</b>	<b>097-220-50</b>
	<b>E14</b> 650 lm  PAR16 MAX40W	<b>092-220-... 31</b>	<b>095-220-... 31</b>	<b>097-220-31</b>





**COLORI DISPONIBILI - COLOR AVAILABLE**

Scegliere il colore aggiungendo la lettera (N-G) al codice PRIMA DELLE ULTIME DUE CIFRE.  
For choose the color to add the letter (N-G) BEFORE THE LAST TWO NUMBERS OF CODE.

 092-220-**N**51     092-220-**G**51  
nero - black                      grigio - grey



MODELLO MODEL	PORTALAMPADA LAMPHOLDER	CODICE-CODE serie finita/assemblata cablata/verniciata	CODICE-CODE kit non assemblato non cablato/verniciato	CODICE-CODE kit non assemblato non cablato/non verniciato
 CORNICE ACCIAIO STEEL COVER	<b>GU10</b> 1900 lm  MAX 35W	<b>092-221-AC51</b>	<b>095-221-AC51</b>	<b>097-221-AC51</b>
	<b>GU5,3</b> 900 lm 12v  MAX 35W	<b>092-221-AC20</b>	<b>095-221-AC20</b>	<b>097-221-AC20</b>
	<b>G9</b> 500 lm  MAX 40W	<b>092-221-AC50</b>	<b>095-221-AC50</b>	<b>097-221-AC50</b>
	<b>E14</b> 650 lm  PAR16 MAX40W	<b>092-221-AC31</b>	<b>095-221-AC31</b>	<b>097-221-AC31</b>

 CORNICE ACCIAIO STEEL COVER	<b>GU10</b> 1900 lm  MAX 35W	<b>092-222-AC51</b>	<b>095-222-AC51</b>	<b>097-222-AC51</b>
	<b>GU5,3</b> 900 lm 12v  MAX 35W	<b>092-222-AC20</b>	<b>095-222-AC20</b>	<b>097-222-AC20</b>
	<b>G9</b> 500 lm  MAX 40W	<b>092-222-AC50</b>	<b>095-222-AC50</b>	<b>097-222-AC50</b>
	<b>E14</b> 650 lm  PAR16 MAX40W	<b>092-222-AC31</b>	<b>095-222-AC31</b>	<b>097-222-AC31</b>

## CARATTERISTICHE TECNICHE

Corpi: Alluminio  
 Coperture: Alluminio/Acciaio  
 Diffusore: Vetro temperato  
 Classe I  
 IP 67  
 Guarnizioni in silicone  
 Viti in acciaio inox  
 Colori: Nero **N** ■  
 Grigio **G** ■  
 Acciaio **AC** ■

## TECHNICAL SPECIFICATIONS

Bodies: Aluminium  
 Covers: Aluminium/Steel  
 Diffusers: Temperate glass  
 Class I  
 IP 67  
 Silicon Gaskets  
 Screws in stainless steel  
 Colors: Black **N** ■  
 Grey **G** ■  
 Steel **AC** ■



## COLORI DISPONIBILI - COLOR AVAILABLE

Scegliere il colore aggiungendo la lettera (N-G) al codice PRIMA DELLE ULTIME DUE CIFRE.  
 For choose the color to add the letter (N-G) BEFORE THE LAST TWO NUMBERS OF CODE.

■ 092-223-**N**40  
 nero - black

■ 092-223-**G**40  
 grigio - grey



www.modulelectro.ru

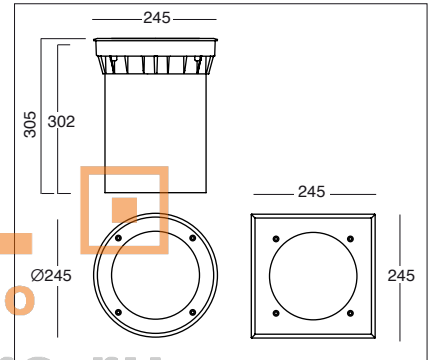

## COMPONENTI - COMPONENTS



**14101-A**  
 cornice quadra  
 in acciaio INOX  
 STAIN LESS steel  
 square cover



**14102-A**  
 cornice tonda  
 in acciaio INOX  
 STAIN LESS steel  
 round cover



**14103-A**  
 anello in alluminio,  
 accessorio per cornici acciaio  
 aluminium ring,  
 accessory for steel cover



**14100-A**  
 cornice tonda  
 in alluminio  
 aluminium round cover



**14104-A**  
 vetro temperato  
 temperate glass



**14105-A**  
 guarnizione - gasket

**14101-S**  
 cornice quadra  
 in acciaio INOX con  
 logo framon  
 STAIN LESS steel square  
 cover with framon logo

**14102-S**  
 cornice tonda  
 in acciaio INOX con  
 logo framon  
 STAIN LESS steel round  
 cover with framon logo



**14106-A**  
 corpo interno  
 in alluminio  
 aluminium  
 internal body



**7995-A**  
 riflettore per Rx7s asimmetrico  
 reflector for Rx7s asimmetrico



**7996-A**  
 riflettore per - reflector for  
 GX24d-3 / G12 / G8,5



**14100-A**  
 pressacavo 2pcs  
 cable gland 2pcs



**14107-A**  
 corpo esterno  
 in policarbonato  
 polycarbonate  
 external body



**7998-A**  
 riflettore per Rx7s simmetrico  
 reflector for Rx7s simmetrico



**14112-A**  
 riflettore orientabile per G12  
 adjustable reflector for G12



**14109-A**  
 kit viteria - screw kit



**14111-A**  
 piastra porta componenti  
 components holder plate











**MODELLO  
MODEL**







**PORTALAMPADA  
LAMPHOLDER**



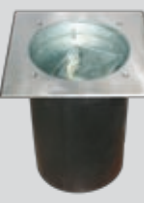





**CODICE-CODE**  
serie finita/assemblata  
cablata/verniciata

**CODICE-CODE**  
kit non assemblato  
non cablato/verniciato

**CODICE-CODE**  
kit non assemblato  
non cablato/non verniciato

 <b>CORNICE ALLUMINIO ALUMINIUM COVER</b>	<b>GX24d-3</b> 1800 lm low enery	 MAX 26W	<b>092-223-... 40</b>	<b>095-223-... 40</b>	<b>097-223-40</b>
	<b>Rx7s</b> 900 lm symmetrical discharge lamp	 MAX 70W	<b>092-223-... 10</b>	<b>095-223-... 10</b>	<b>097-223-10</b>
	<b>Rx7s</b> 900 lm asymmetrical reflector	 MAX 70W	<b>092-223-... 10A</b>	<b>095-223-... 10A</b>	<b>097-223-10A</b>
	<b>G12</b> 9300 lm discharge lamp	 MAX 70W	<b>092-223-... 15</b>	<b>095-223-... 15</b>	<b>097-223-15</b>
	<b>G8,5</b> 9300 lm discharge lamp	 MAX 70W	<b>092-223-... 11</b>	<b>095-223-... 11</b>	<b>097-223-11</b>
	<b>E27 PAR38</b> 11000 lm	 MAX 120W	<b>092-223-... 30</b>	<b>095-223-... 30</b>	<b>097-223-30</b>
	<b>E27 PAR20/30</b>	 50÷75	<b>092-223-... 30-1</b>	<b>095-223-... 30-1</b>	<b>097-223-30-1</b>

 <b>CORNICE ACCIAIO STEEL COVER</b>	<b>GX24d-3</b> 1800 lm low enery	 MAX 26W	<b>092-224-AC40</b>	<b>095-224-AC40</b>	<b>097-224-AC40</b>
	<b>Rx7s</b> 900 lm symmetrical discharge lamp	 MAX 70W	<b>092-224-AC10</b>	<b>095-224-AC10</b>	<b>097-224-AC10</b>
	<b>Rx7s</b> 900 lm asymmetrical reflector	 MAX 70W	<b>092-224-AC10A</b>	<b>095-224-AC10A</b>	<b>097-224-AC10A</b>
	<b>G12</b> 9300 lm discharge lamp	 MAX 70W	<b>092-224-AC15</b>	<b>095-224-AC15</b>	<b>097-224-AC15</b>
	<b>G8,5</b> 9300 lm discharge lamp	 MAX 70W	<b>092-224-AC11</b>	<b>095-224-AC11</b>	<b>097-224-AC11</b>
	<b>E27 PAR38</b> 11000 lm	 MAX 120W	<b>092-224-AC30</b>	<b>095-224-AC30</b>	<b>097-224-AC30</b>
	<b>E27 PAR20/30</b>	 50÷75	<b>092-224-AC30-1</b>	<b>095-224-AC30-1</b>	<b>097-224-AC30-1</b>

 <b>CORNICE ACCIAIO STEEL COVER</b>	<b>GX24d-3</b> 1800 lm low enery	 MAX 26W	<b>092-225-AC40</b>	<b>095-225-AC40</b>	<b>097-225-AC40</b>
	<b>Rx7s</b> 900 lm symmetrical discharge lamp	 MAX 70W	<b>092-225-AC10</b>	<b>095-225-AC10</b>	<b>097-225-AC10</b>
	<b>Rx7s</b> 900 lm asymmetrical reflector	 MAX 70W	<b>092-225-AC10A</b>	<b>095-225-AC10A</b>	<b>097-225-AC10A</b>
	<b>G12</b> 9300 lm discharge lamp	 MAX 70W	<b>092-225-AC15</b>	<b>095-225-AC15</b>	<b>097-225-AC15</b>
	<b>G8,5</b> 9300 lm discharge lamp	 MAX 70W	<b>092-225-AC11</b>	<b>095-225-AC11</b>	<b>097-225-AC11</b>
	<b>E27 PAR38</b> 11000 lm	 MAX 120W	<b>092-225-AC30</b>	<b>095-225-AC30</b>	<b>097-225-AC30</b>
	<b>E27 PAR20/30</b>	 50÷75	<b>092-225-AC30-1</b>	<b>095-225-AC30-1</b>	<b>097-225-AC30-1</b>

## CARATTERISTICHE TECNICHE

Corpi: Alluminio  
 Coperture: Alluminio  
 Diffusore: Vetro temperato  
 Classe I  
 IP 67  
 Guarnizioni in silicone  
 Viti in acciaio inox  
 Colori: Nero **N ■**

## TECHNICAL SPECIFICATIONS

Bodies: Aluminium  
 Covers: Aluminium  
 Diffusers: Temperate glass  
 Class I  
 IP 67  
 Silicon Gaskets  
 Screws in stainless steel  
 Colors: Black **N ■**

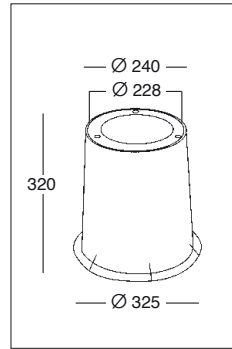

## COMPONENTI - COMPONENTS



**14200-A**  
 Ø 228 x H 9  
 cornice in alluminio  
 aluminium cover



**14201-A**  
 Ø 228 x H 9  
 cornice in alluminio  
 aluminium cover



**14210-A-O**  
 Ø 195 x H 16  
 vetro opale - opal glass

**14210-A**  
 Ø 195 x H 16  
 vetro trasparente  
 transparent glass



**7996-A**  
 riflettore per GX24d-3 e E27  
 reflector for GX24d-3 & E27



**7998-A**  
 riflettore per Rx7s  
 reflector for Rx7s



**14202-A**  
 Ø 228 x H 39  
 cornice in alluminio  
 aluminium cover



**14203-A**  
 Ø 228 x H 54  
 cornice in alluminio  
 aluminium cover



**14204-A**  
 Ø 228 x H 54  
 cornice in alluminio  
 aluminium cover



**14211-A**  
 Ø 195 x H 32  
 vetro trasparente  
 transparent glass

**14211-A-O**  
 Ø 195 x H 32  
 vetro opale - opal glass



**14212-A**  
 guarnizione - gasket



**14111-A**  
 piastrina - plate







**14214-A**  
 Ø 230 x H 240  
 corpo interno  
 internal body

**14215-A**  
 Ø 325 x H 300  
 corpo esterno in policarbonato  
 polycarbonate external body







**14010-A**  
 pressacavo 2pcs  
 cable gland 2pcs







MODELLO MODEL	PORTALAMPADA LAMPHOLDER	CODICE-CODE serie finita/assemblata cablata/verniciata	CODICE-CODE kit non assemblato non cablato/verniciato	CODICE-CODE kit non assemblato non cablato/non verniciato
 <b>WAYLIGHT 1</b>  NON CALPESTABILE NOT WALKWAY	<b>E27</b>  DICROICA 50W	<b>092-230-N30</b>	<b>095-230-N30</b>	<b>097-230-30</b>
	<b>Rx7s</b> <i>discharge lamp</i>  HQI-TS 70W JM	<b>092-230-N10</b>	<b>095-230-N10</b>	<b>097-230-10</b>
	<b>GX24d-3</b>  MAX 26W	<b>092-230-N41</b>	<b>095-230-N41</b>	<b>097-230-41</b>

 <b>WAYLIGHT 5</b>  CALPESTABILE WALKWAY	<b>E27</b>  DICROICA 50W	<b>092-232-N30</b>	<b>095-232-N30</b>	<b>097-232-30</b>
	<b>Rx7s</b> <i>discharge lamp</i>  HQI-TS 70W JM	<b>092-232-N10</b>	<b>095-232-N10</b>	<b>097-232-10</b>
	<b>GX24d-3</b>  MAX 26W	<b>092-232-N41</b>	<b>095-232-N41</b>	<b>097-232-41</b>

 <b>WAYLIGHT 2</b>  CARRABILE DRIVEWAY	<b>E27</b>  DICROICA 50W	<b>092-234-N30</b>	<b>095-234-N30</b>	<b>097-234-30</b>
	<b>Rx7s</b> <i>discharge lamp</i>  HQI-TS 70W JM	<b>092-234-N10</b>	<b>095-234-N10</b>	<b>097-234-10</b>
	<b>GX24d-3</b>  MAX 26W	<b>092-234-N41</b>	<b>095-234-N41</b>	<b>097-234-41</b>

 <b>WAYLIGHT 3</b>  CARRABILE DRIVEWAY	<b>E27</b>  DICROICA 50W	<b>092-236-N30</b>	<b>095-236-N30</b>	<b>097-236-30</b>
	<b>Rx7s</b> <i>discharge lamp</i>  HQI-TS 70W JM	<b>092-236-N10</b>	<b>095-236-N10</b>	<b>097-236-10</b>
	<b>GX24d-3</b>  MAX 26W	<b>092-236-N41</b>	<b>095-236-N41</b>	<b>097-236-41</b>

 <b>WAYLIGHT 4</b>  CARRABILE DRIVEWAY	<b>E27</b>  DICROICA 50W	<b>092-238-N30</b>	<b>095-238-N30</b>	<b>097-238-30</b>
	<b>Rx7s</b> <i>discharge lamp</i>  HQI-TS 70W JM	<b>092-238-N10</b>	<b>095-238-N10</b>	<b>097-238-10</b>
	<b>GX24d-3</b>  MAX 26W	<b>092-238-N41</b>	<b>095-238-N41</b>	<b>097-238-41</b>

  
[www.modulelectro.ru](http://www.modulelectro.ru)

## CARATTERISTICHE TECNICHE

Corpi: Alluminio  
 Coperture: Alluminio  
 Diffusore: Vetro  
 Policarbonato

Classe I  
 IP 55  
 Guarnizioni in silicone  
 Viti in acciaio inox  
 Colori: Nero



## TECHNICAL SPECIFICATIONS

Bodies: Aluminium  
 Covers: Aluminium  
 Diffusers: Glass  
 Polycarbonate

Class I  
 IP 55  
 Silicon Gaskets  
 Screws in stainless steel  
 Colors: Black

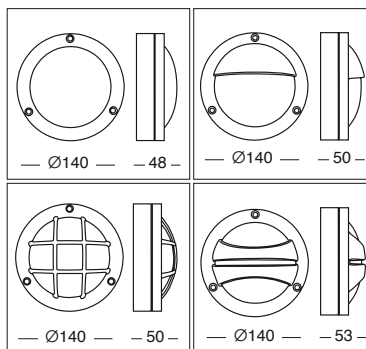

## MODELLO MODEL

## PORTALAMPADA LAMPHOLDER

**CODICE-CODE**  
serie finita/assemblata  
cablata/verniciata

**CODICE-CODE**  
kit non assemblato  
non cablato/verniciato

**CODICE-CODE**  
kit non assemblato  
non cablato/non verniciato

	<b>G9</b>	 MAX 1X25W	<b>092-001-N50</b>	<b>095-001-N50</b>	<b>097-001-50</b>
	<b>GX53</b>	 MAX 9W	<b>092-001-N42</b>	<b>095-001-N42</b>	<b>097-001-42</b>
	<b>G9</b>	 MAX 1X25W	<b>092-002-N50</b>	<b>095-002-N50</b>	<b>097-002-50</b>
	<b>GX53</b>	 MAX 9W	<b>092-002-N42</b>	<b>095-002-N42</b>	<b>097-002-42</b>
	<b>G9</b>	 MAX 1X25W	<b>092-003-N50</b>	<b>095-003-N50</b>	<b>097-003-50</b>
	<b>GX53</b>	 MAX 9W	<b>092-003-N42</b>	<b>095-003-N42</b>	<b>097-003-42</b>
	<b>G9</b>	 MAX 1X25W	<b>092-004-N50</b>	<b>095-004-N50</b>	<b>097-004-50</b>
	<b>GX53</b>	 MAX 9W	<b>092-004-N42</b>	<b>095-004-N42</b>	<b>097-004-42</b>

## COMPONENTI - COMPONENTS



**4400-A**  
Ø 140 x H 30  
base in alluminio  
aluminium base



**13014-A**  
passacavo  
cable pass



**4401-A**  
cornice in alluminio  
aluminium cover



**4402-A**  
cornice in alluminio  
aluminium cover



**4403-A**  
cornice in alluminio  
aluminium cover



**4404-A**  
cornice in alluminio  
aluminium cover

· COMPONENTI PER ELETTIFICAZIONE G9  
 · COMPONENTS FOR G9 ELECTRICAL SYSTEM

· COMPONENTI PER ELETTIFICAZIONE GX53  
 · COMPONENTS FOR GX53 ELECTRICAL SYSTEM

**7156-A**  
staffa per G9  
G9 stirrup



**7157-A**  
portalampada G9  
G9 lampholder



**7865-A**  
vetro - glass



**7867-A**  
guarnizione in silicone  
silicone gasket



**7147-A**  
portalampada GX53  
GX53 lampholder



**7887-A**  
policarbonato  
polycarbonate



**CARATTERISTICHE TECNICHE**

Corpi: Alluminio  
 Coperture: Alluminio  
 Diffusore: Policarbonato  
 Classe I  
 IP 66  
 Guarnizioni in silicone  
 Viti in acciaio inox

**TECHNICAL SPECIFICATIONS**

Bodies: Aluminium  
 Covers: Aluminium  
 Diffusers: Polycarbonate  
 Class I  
 IP 66  
 Silicon Gaskets  
 Screws in stainless steel

Colori: Nero



Colors: Black



**MODELLO  
MODEL**

**PORTALAMPADA  
LAMPHOLDER**

**CODICE-CODE**  
serie finita/assemblata  
cablata/verniciata

**CODICE-CODE**  
kit non assemblato  
non cablato/verniciato

**CODICE-CODE**  
kit non assemblato  
non cablato/non verniciato

	<b>E27</b>	 MAX 100W	<b>092-007-N30</b>	<b>095-007-N30</b>	<b>097-007-30</b>
	<b>GR8</b>	 2 PIN 16W	<b>092-007-N43</b>	<b>095-007-N43</b>	<b>097-007-43</b>
	<b>G24d-2</b>	 MAX 18W	<b>092-007-N41</b>	<b>095-007-N41</b>	<b>097-007-41</b>

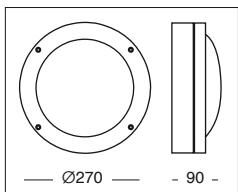

**MODULO**  
ELECTRO

www.modulelectro.ru

	<b>E27</b>	 MAX 100W	<b>092-008-N30</b>	<b>095-008-N30</b>	<b>097-008-30</b>
	<b>GR8</b>	 2 PIN 16W	<b>092-008-N43</b>	<b>095-008-N43</b>	<b>097-008-43</b>
	<b>G24d-2</b>	 MAX 18W	<b>092-008-N41</b>	<b>095-008-N41</b>	<b>097-008-41</b>

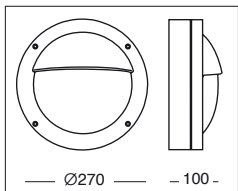

**COMPONENTI - COMPONENTS**



**4410-A**  
Ø 270 x H 45  
base in alluminio  
aluminium base



**7002-A**  
passacavo  
cable pass



**4411-A**  
cornice in alluminio  
aluminium cover



**4412-A**  
cornice in alluminio  
aluminium cover



**7877-A**  
guarnizione in silicone  
silicone gasket



**7875-A**  
policarbonato  
polycarbonate

# Technical Series

## CARATTERISTICHE TECNICHE

Corpi: Alluminio  
 Coperture: Alluminio  
 Diffusore: Vetro  
 Classe I  
 IP 66  
 Guarnizioni in silicone  
 Viti in acciaio inox  
 Colori: Nero



## TECHNICAL SPECIFICATIONS

Bodies: Aluminium  
 Covers: Aluminium  
 Diffusers: Glass  
 Class I  
 IP 66  
 Silicon Gaskets  
 Screws in stainless steel  
 Colors: Black

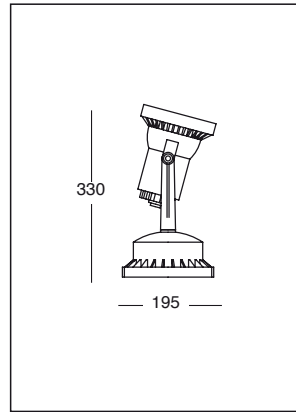

MODELLO MODEL	PORTALAMPADA LAMPHOLDER	CODICE-CODE serie finita/assemblata cablata/verniciata	CODICE-CODE kit non assemblato non cablato/verniciato	CODICE-CODE kit non assemblato non cablato/non verniciato
	<b>E27 PAR30</b>  MAX 50W	<b>092-525-N30</b>	<b>095-525-N30</b>	<b>097-525-30</b>
	<b>GY6,35</b> trasformatore incluso included transformer  MAX 50W	<b>092-525-N44</b>	<b>095-525-N44</b>	<b>097-525-44</b>
	<b>E27 PAR30</b>  MAX 50W	<b>092-526-N30</b>	<b>095-526-N30</b>	<b>097-526-30</b>
	<b>GY6,35</b> trasformatore incluso included transformer  MAX 50W	<b>092-526-N44</b>	<b>095-526-N44</b>	<b>097-526-44</b>



## COMPONENTI - COMPONENTS

- 9400-A**  
corpo - body
- 9410-A**  
guarnizione  
gasket
- 9409-A**  
vetro  
glass
- 9401-A**  
cornice  
cover
- 9408-A**  
cornice  
cover
- 9402-A**  
staffa - stirrup
- 9405-A**  
accessori per E27  
E27 accessories
- 9406-A**  
accessori per GY6,35  
GY6,35 accessories
- 9406-A-1**  
accessori per GY6,35  
GY6,35 accessories
- 9403-A**  
base - base
- 9404-A**  
sottobase  
underbase
- 9407-A**  
picchetto  
in policarbonato  
polycarbonate  
picket
- 9405-A-1**  
accessorio - accessory





### CARATTERISTICHE TECNICHE

Corpi: Alluminio  
 Coperture: Alluminio anodizzato  
 Diffusore: Vetro temperato  
 Classe I  
 IP 66  
 Guarnizioni in silicone  
 Viti in acciaio inox  
 Colori: Nero  
 Grigio



### TECHNICAL SPECIFICATIONS

Bodies: Aluminium  
 Covers: Anodized aluminium  
 Diffusers: Temperate glass  
 Class I  
 IP 66  
 Silicon Gaskets  
 Screws in stainless steel  
 Colors: Black  
 Grey



### MODELLO MODEL

### PORTALAMPADA LAMPHOLDER

### CODICE-CODE serie finita/assemblata cablata/verniciata

### CODICE-CODE kit non assemblato non cablato/verniciato

### CODICE-CODE kit non assemblato non cablato/non verniciato



**E40**  
discharge lamp

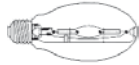

**092-520-... 13**

**095-520-... 13**

**097-520-13**

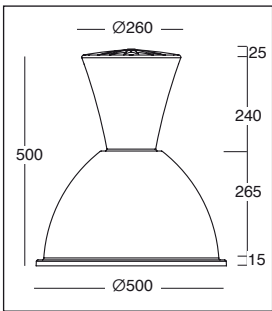

**COLORI DISPONIBILI - COLOR AVAILABLE**  
 Scegliere il colore aggiungendo la lettera (N-G) al codice PRIMA DELLE ULTIME DUE CIFRE.  
 For choose the color to add the letter (N-G) BEFORE THE LAST TWO NUMBERS OF CODE.

**ELECTRO**

■ 092-520-**N**13    ■ 092-520-**G**13  
 nero - black    grigio - grey

[www.modulelectro.ru](http://www.modulelectro.ru)

### COMPONENTI - COMPONENTS



**097-TM100**  
coperchio in alluminio  
aluminium cap



**097-TM110**  
piastra porta-reattori in ferro  
zincato  
ballast holder in zinc plated  
steel



**097-TM105**  
guarnizione in silicone  
silicone gasket



**097-TM120**  
cappello in alluminio  
aluminium cover



**097-TM125**  
guarnizione in silicone  
silicone gasket



**097-TM130**  
campana in  
alluminio anodizzato  
bell in anodized  
aluminium



**097-TM134**  
gancio in acciaio  
steel hook



**097-TM135**  
guarnizione  
in silicone  
silicone gasket



**097-TM140**  
vetro temperato  
temperate glass

# Technical Series

## CARATTERISTICHE TECNICHE

Corpi: Alluminio  
 Coperture: Alluminio  
 Diffusore: Vetro temperato  
 Classe I  
 IP 66  
 Guarnizioni in silicone  
 Viti in acciaio inox  
 Colori: Nero **N** ■  
 Grigio **G** ■



## TECHNICAL SPECIFICATIONS

Bodies: Aluminium  
 Covers: Aluminium  
 Diffusers: Temperate glass  
 Class I  
 IP 66  
 Silicon Gaskets  
 Screws in stainless steel  
 Colors: Black **N** ■  
 Grey **G** ■

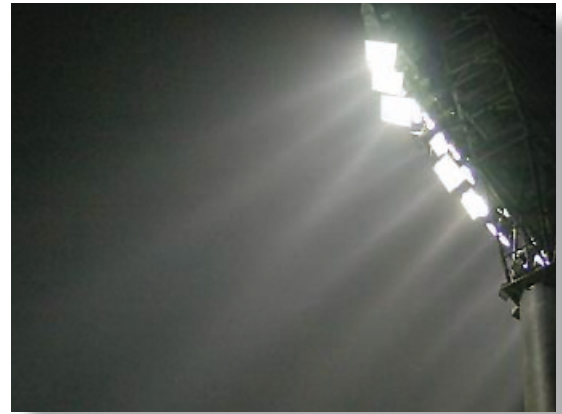



### MODELLO MODEL

### PORTALAMPADA LAMPHOLDER

### CODICE-CODE serie finita/assemblata cablata/verniciata

### CODICE-CODE kit non assemblato non cablato/verniciato

### CODICE-CODE kit non assemblato non cablato/non verniciato

	<p><b>Rx7s</b> discharge lamp</p>  <p><b>HQI-TS</b> 75+150W JM</p>	<p><b>092-510-... 10</b></p>	<p><b>095-510-... 10</b></p>	<p><b>097-510-10</b></p>
---	---	------------------------------	------------------------------	--------------------------

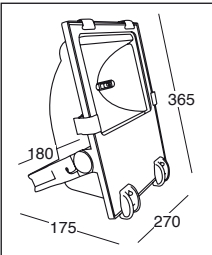

# MODULO

## COLORI DISPONIBILI - COLOR AVAILABLE

Scegliere il colore aggiungendo la lettera (N-G) al codice PRIMA DELLE ULTIME DUE CIFRE.  
 For choose the color to add the letter (N-G) BEFORE THE LAST TWO NUMBERS OF CODE.

[www.modulelectro.ru](http://www.modulelectro.ru)

**092-510-N10**  
nero - black

**092-510-G10**  
grigio - grey

## COMPONENTI - COMPONENTS

 <p><b>097-TM030</b> braccio - arm</p>	 <p><b>097-TM010</b> corpo - body</p>	 <p><b>097-TM011</b> guarnizione gasket</p>	 <p><b>097-TM015</b> vetro - glass</p>	 <p><b>097-TM075</b> guarnizione per 097-TM070 gasket for 097-TM070</p>	 <p><b>097-TM090</b> 4 pz per gabbia 4 pcs for cage</p>
 <p><b>097-TM012</b> riflettore - reflector</p>	 <p><b>097-TM013</b> separatore accessory</p>	 <p><b>097-TM014</b> portalampada lampholder</p>	 <p><b>097-TM070</b> grigio 2 pz per gabbia gray 2 pcs for cage</p> <p><b>097-TM070-N</b> nero 2 pz per gabbia black 2 pcs for cage</p>	 <p><b>097-TM080</b> grigio 2 pz per gabbia gray 2 pcs for cage</p> <p><b>097-TM080-N</b> nero 2 pz per gabbia black 2 pcs for cage</p>	



### CARATTERISTICHE TECNICHE

Corpi: Alluminio  
 Coperture: Alluminio  
 Diffusore: Vetro temperato  
 Classe I  
 IP 66  
 Guarnizioni in silicone  
 Viti in acciaio inox  
 Colori: Nero **N** ■  
 Grigio **G** ■



### TECHNICAL SPECIFICATIONS

Bodies: Aluminium  
 Covers: Aluminium  
 Diffusers: Temperate glass  
 Class I  
 IP 66  
 Silicon Gaskets  
 Screws in stainless steel  
 Colors: Black **N** ■  
 Grey **G** ■



### MODELLO MODEL

### PORTALAMPADA LAMPHOLDER

**CODICE-CODE**  
 serie finita/assemblata  
 cablata/verniciata

**CODICE-CODE**  
 kit non assemblato  
 non cablato/verniciato

**CODICE-CODE**  
 kit non assemblato  
 non cablato/non verniciato

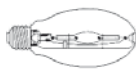
	<p><b>E40</b> discharge lamp</p>  <p>400W</p>	<b>092-500-... 10</b>	<b>095-500-... 10</b>	<b>097-500-10</b>
--	--	-----------------------	-----------------------	-------------------

# MODULO

### COLORI DISPONIBILI - COLOR AVAILABLE

Scegliere il colore aggiungendo la lettera (N-G) al codice PRIMA DELLE ULTIME DUE CIFRE.  
 For choose the color to add the letter (N-G) BEFORE THE LAST TWO NUMBERS OF CODE.

**092-500-N10**    **092-500-G10**  
 nero - black                      grigio - grey

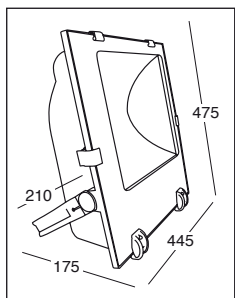

### COMPONENTI - COMPONENTS



**097-TM060**  
braccio - arm



**097-TM040**  
corpo - body

**097-TM047**  
piastra porta-cablaggi  
plate cable-holder



**097-TM041**  
guarnizione  
gasket



**097-TM045**  
vetro - glass



**097-TM075**  
guarnizione per  
097-TM070  
gasket for  
097-TM070



**097-TM090**  
4 pz per gabbia  
4 pcs for cage



**097-TM070**  
grigio  
2 pz per gabbia  
gray  
2 pcs for cage



**097-TM080**  
grigio  
2 pz per gabbia  
gray  
2 pcs for cage



**097-TM043**  
separatore  
accessory



**097-TM044**  
staff - stirrup



**097-TM042**  
riflettore - reflector



**097-TM046**  
portalampada  
lampholder

**097-TM070-N**  
nero  
2 pz per gabbia  
black  
2 pcs for cage

**097-TM080-N**  
nero  
2 pz per gabbia  
black  
2 pcs for cage

  
**MODULO**  
ELECTRO  
[www.modulelectro.ru](http://www.modulelectro.ru)



**MODUL**  
ELECTRO  
[www.modulelectro.ru](http://www.modulelectro.ru)



  
**MODULO**  
**ELECTRO**  
[www.modulelectro.ru](http://www.modulelectro.ru)



[www.modulselectro.ru](http://www.modulselectro.ru)

Via F. Lana 31 - 25065 Lumezzane BS Italy

Tel. (+39) 030 8920977 - Fax (+39) 030 8922544

[www.framon.it](http://www.framon.it) - [info@framon.it](mailto:info@framon.it)