

 GAMMA
 DELTA
 GROUP



 **MODUL** 
ELECTRO

www.modulelectro.ru

Contemporary
Lighting
Collection



Light
Collection
Luce
lumière

MODULO
ELECTRO
www.modulelectro.ru

 **MODULO** 
ELECTRO
www.modulelectro.ru

 GAMMADELTA GROUP

wing 2

 **MODUL** 
ELECTRO
www.modulelectro.ru



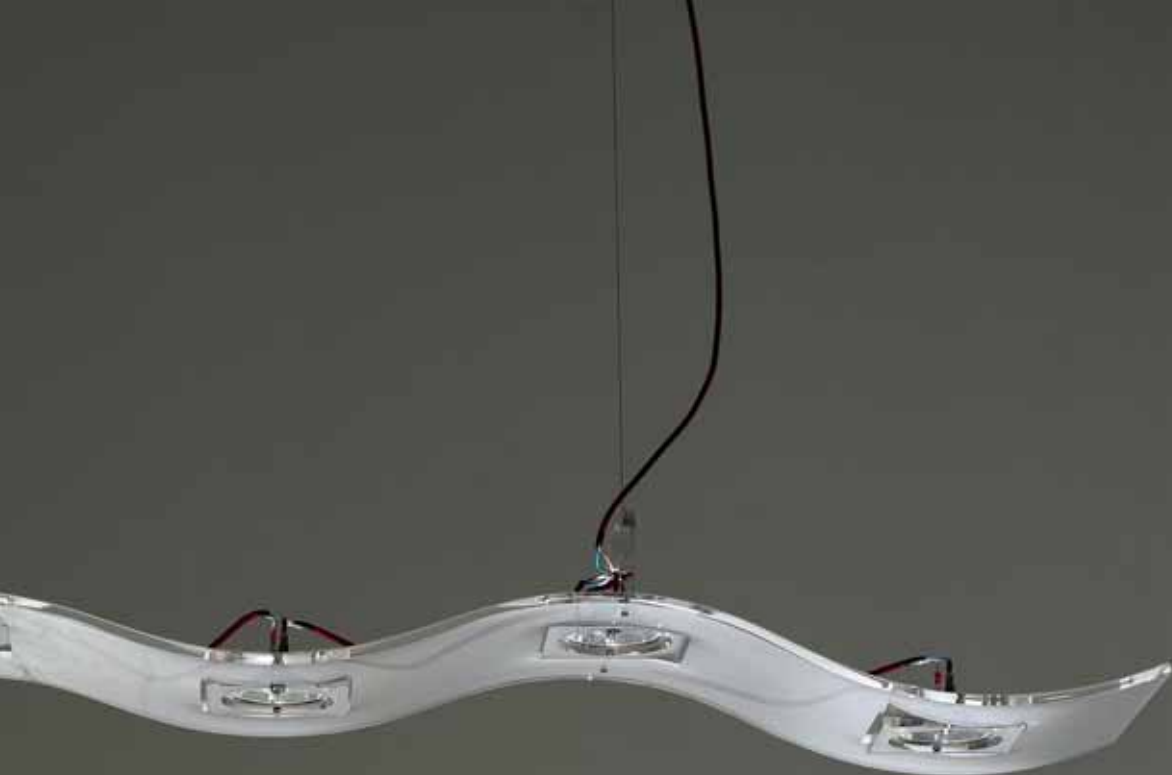

MODUL

ELECTRO

www.modulelectro.ru



6423
L160 P32 H50-150
5X50W G53



 **MODUL** 

ELECTRO

www.modulelectro.ru



wing 2



MODUL
ELECTRO
www.modulelectro.ru

6423
L160 P32 H50-150
5X50W G53



MODUL
ELECTRO
www.modulelectro.ru

wing 2



MODUL

ELECTRO

www.modulelectro.ru

6423
L160 P32 H50-150
5X50W G53



MODUL
ELECTRO
www.modulelectro.ru

wing 2





MODUL
ELECTRO
www.modulelectro.ru





MODUL
ELECTRO

www.modulelectro.ru



wing 2

MODUL
ELECTRO
www.modulelectro.ru

6430
L13 P13 H100-300
3X7W GU10 LED



wing 2



MODUL
ELECTRO
www.modulelectro.ru



6410
D60 H50-150
5X50W G53



MODUL
ELECTRO
www.modulelectro.ru

6411
L60 P60 H50-150
4X50W G53



MODUL
ELECTRO
www.modulelectro.ru

wing 2





MODUL
ELECTRO

www.modulelectro.ru













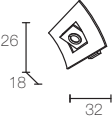

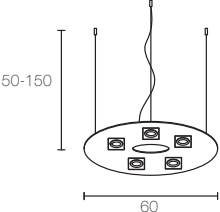
6451

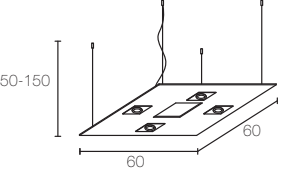
L32 P18 H26
1X7W GU10 LED

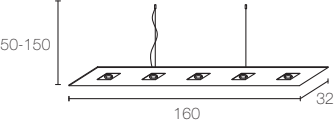

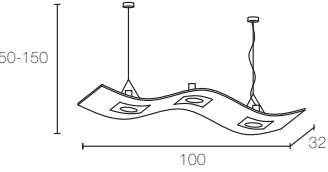
6422

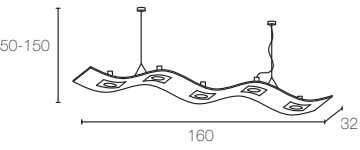
L100 P32 H50-150
3X7W GU10 LED

<p>WING 2 - 6401 - *6451 LED</p> 	 <p>1X50W G53</p>  <p>*1X7W GU10 LED</p>	<p>Applique Struttura: polimetilmetacrilato nei colori trasparente, nero o bianco - particolari cromo lucido.</p> <p>Wall lamp Structure: polymethyl metacrylate available in the following colours transparent, black or white - polished chrome details.</p> <p>⊕ ⚡ CE</p>
<p>WING 2 - 6410 - *6460 LED</p> 	 <p>5X50W G53</p>  <p>*5X7W GU10 LED</p>	<p>Sospensione Struttura: polimetilmetacrilato nei colori trasparente, nero o bianco - particolari cromo lucido.</p> <p>Hanging lamp Structure: polymethyl metacrylate available in the following colours transparent, black or white - polished chrome details.</p> <p>⊕ ⚡ CE</p>
<p>WING 2 - 6411 - *6461 LED</p> 	 <p>4X50W G53</p>  <p>*4X7W GU10 LED</p>	<p>Sospensione Struttura: polimetilmetacrilato nei colori trasparente, nero o bianco - particolari cromo lucido.</p> <p>Hanging lamp Structure: polymethyl metacrylate available in the following colours transparent, black or white - polished chrome details.</p> <p>⊕ ⚡ CE</p>
<p>WING 2- 6413 - *6463 LED</p> 	 <p>5X50W G53</p>  <p>*5X7W GU10 LED</p>	<p>Sospensione Struttura: polimetilmetacrilato nei colori trasparente, nero o bianco - particolari cromo lucido.</p> <p>Hanging lamp Structure: polymethyl metacrylate available in the following colours transparent, black or white - polished chrome details.</p> <p>⊕ ⚡ CE</p>
<p>WING 2 - 6422 - *6472 LED</p> 	 <p>3X50W G53</p>  <p>*3X7W GU10 LED</p>	<p>Sospensione Struttura: polimetilmetacrilato nei colori trasparente, nero o bianco - particolari cromo lucido.</p> <p>Hanging lamp Structure: polymethyl metacrylate available in the following colours transparent, black or white - polished chrome details.</p> <p>⊕ ⚡ CE</p>
<p>WING 2 - 6423 - *6473 LED</p> 	 <p>5X50W G53</p>  <p>*5X7W GU10 LED</p>	<p>Sospensione Struttura: polimetilmetacrilato nei colori trasparente, nero o bianco - particolari cromo lucido.</p> <p>Hanging lamp Structure: polymethyl metacrylate available in the following colours transparent, black or white - polished chrome details.</p> <p>⊕ ⚡ CE</p>

MODULO
ELECTRO
www.modulelectro.ru

WING 2 - 6430

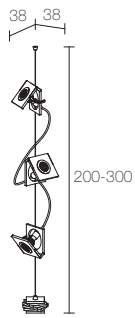

3X7W LED GU10



Lampada terra

Struttura: polimetilmetacrilato nei colori trasparente, nero o bianco - particolari cromo lucido.

Floor lamp

Structure: polymethyl metacrylate available in the following colours transparent, black or white - polished chrome details.



 **MODULO** 
ELECTRO
www.modulelectro.ru



GAMMADELTA GROUP

rosa

design THOMAS BALLARINI



MODUL
ELECTRO

www.modulelectro.ru



MODUL
ELECTRO
www.modulelectro.ru

6760
L80 P80 H50-150
4X50W GU10





MODULO
ELECTRO

www.modulelectro.ru





MODUL
ELECTRO
www.modul-electro.ru

rosa



MODUL
ELECTRO

www.modul.electro.ru

ROSA- 6751

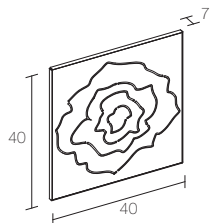

1X16W 2pin

Applique

Struttura: base laccato bianco - diffusore polimetilmetacrilato trasparente o arancio.

Wall lamp

Structure: base enamelled white - diffuser polymethyl metacrylate transparent or orange.



ROSA - 6760

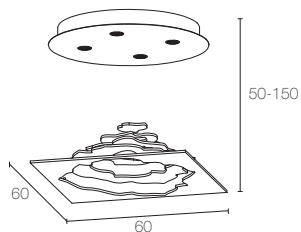

4X50W GU10



4X7W LED GU10



Sospensione

Struttura: base cromo lucido - diffusore polimetilmetacrilato nei colori trasparente o arancio.

Hanging lamp

Structure: base polished chrome - diffuser polymethyl metacrylate transparent or orange.



 **MODULO** 
ELECTRO
www.modulelectro.ru



MODUL
ELECTRO

www.modulelectro.ru





MODUL
ELECTRO
www.modulelectro.ru

4614
D70 H100-150
12X20W G4



freesby
design ATOCAIO



MODUL
ELECTRO
www.modulelectro.ru

4630
D70 H190
6X20W G4



4602
L65 P48 H70
6X20W G4

freesby



MODUL
ELECTRO
www.modulelectro.ru

4640
D40 P25 H45
2X20W G4



MODUL
ELECTRO
www.modul-electro.ru

4613
D85 H100-150
8X20W G4

freesby



MODUL
ELECTRO
www.modulelectro.ru

freesby



MODUL
ELECTRO
www.modulelectro.ru











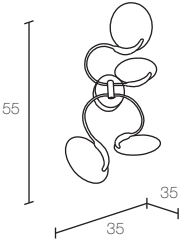

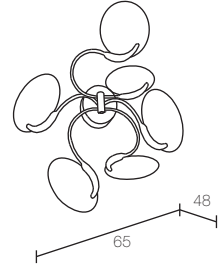
4614
D70 H100-150
12X20W G4

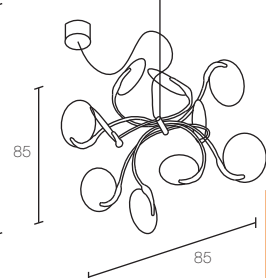

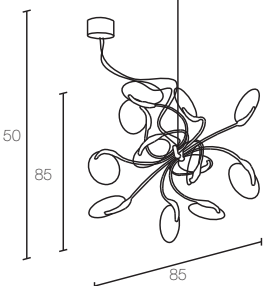
MODUL
ELECTRO
www.modulelectro.ru

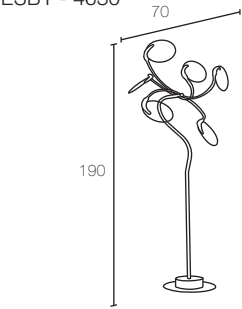
freesboy

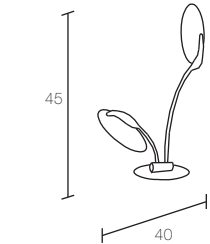

<p>FREESBY - 4601</p> 	 4X20W G4	<p>Applique Struttura: cromo lucido - policarbonato trasparente. Diffusore in metacrilato: nei colori ametista, verde, rosso, blu, giallo, ambra e trasparente.</p> <p>Wall lamp Structure: polished chrome - polycarbonate transparent. Diffuser in methacrylate: available in the following colours: amethyst, green, red, amber and transparent.</p> 
<p>FREESBY - 4602</p> 	 6X20W G4	<p>Applique Struttura: cromo lucido - policarbonato trasparente. Diffusore in metacrilato: nei colori ametista, verde, rosso, blu, giallo, ambra e trasparente.</p> <p>Wall lamp Structure: polished chrome - polycarbonate transparent. Diffuser in methacrylate: available in the following colours: amethyst, green, red, amber and transparent.</p> 
<p>FREESBY - 4613</p> 	 8X20W G4	<p>Sospensione Struttura: cromo lucido - policarbonato trasparente. Diffusore in metacrilato: nei colori ametista, verde, rosso, blu, giallo, ambra e trasparente.</p> <p>Hanging lamp Structure: polished chrome - polycarbonate transparent. Diffuser in methacrylate: available in the following colours: amethyst, green, red, amber and transparent.</p> 
<p>FREESBY - 4614</p> 	 12X20W G4	<p>Sospensione Struttura: cromo lucido - policarbonato trasparente. Diffusore in metacrilato: nei colori ametista, verde, rosso, blu, giallo, ambra e trasparente.</p> <p>Hanging lamp Structure: polished chrome - polycarbonate transparent. Diffuser in methacrylate: available in the following colours: amethyst, green, red, amber and transparent.</p> 
<p>FREESBY - 4630</p> 	 6X20W G4	<p>Lampada terra Struttura: cromo lucido - policarbonato trasparente. Diffusore in metacrilato: nei colori ametista, verde, rosso, blu, giallo, ambra e trasparente.</p> <p>Lampada terra Structure: polished chrome - polycarbonate transparent. Diffuser in methacrylate: available in the following colours: amethyst, green, red, amber and transparent.</p> 
<p>FREESBY - 4640</p> 	 2X20W G4	<p>Lampada tavolo Struttura: cromo lucido - policarbonato trasparente. Diffusore in metacrilato: nei colori ametista, verde, rosso, blu, giallo, ambra e trasparente.</p> <p>Table lamp Structure: polished chrome - polycarbonate transparent. Diffuser in methacrylate: available in the following colours: amethyst, green, red, amber and transparent.</p> 

MODULO
ELECTRO

www.modulselectro.ru



 **MODUL** 
ELECTRO

www.modulelectro.ru



6662
L31 P15 H50-150
2X75W E27

35

egg



MODUL
ELECTRO
www.modulelectro.ru



MODUL
ELECTRO
www.modulelectro.ru

EGG - 6661

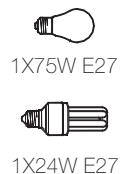
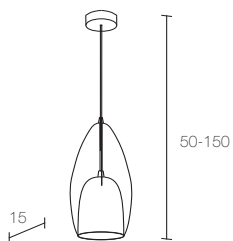

Sospensione

Struttura: cromo lucido.

Diffusore: cristallo pirex nei colori bianco, ametista, verde, rosso, ambra e trasparente.

Hanging lamp

Structure: polished chrome.

Diffuser: pyrex crystal available in the following colours white, amethyst, green, red, amber and transparent.



EGG - 6662

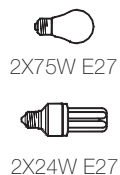
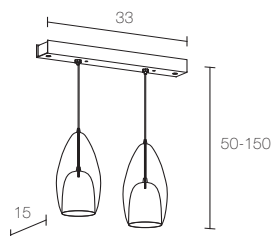

Sospensione

Struttura: cromo lucido.

Diffusore: cristallo pirex nei colori bianco, ametista, verde, rosso, ambra e trasparente.

Hanging lamp

Structure: polished chrome.

Diffuser: pyrex crystal available in the following colours white, amethyst, green, red, amber and transparent.



EGG - 6663

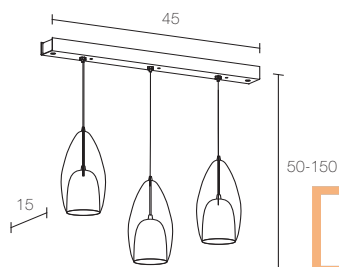

Sospensione

Struttura: cromo lucido.

Diffusore: cristallo pirex nei colori bianco, ametista, verde, rosso, ambra e trasparente.

Hanging lamp

Structure: polished chrome.

Diffuser: pyrex crystal available in the following colours white, amethyst, green, red, amber and transparent.



MODULO

ELECTRO

www.modulelectro.ru

soleil

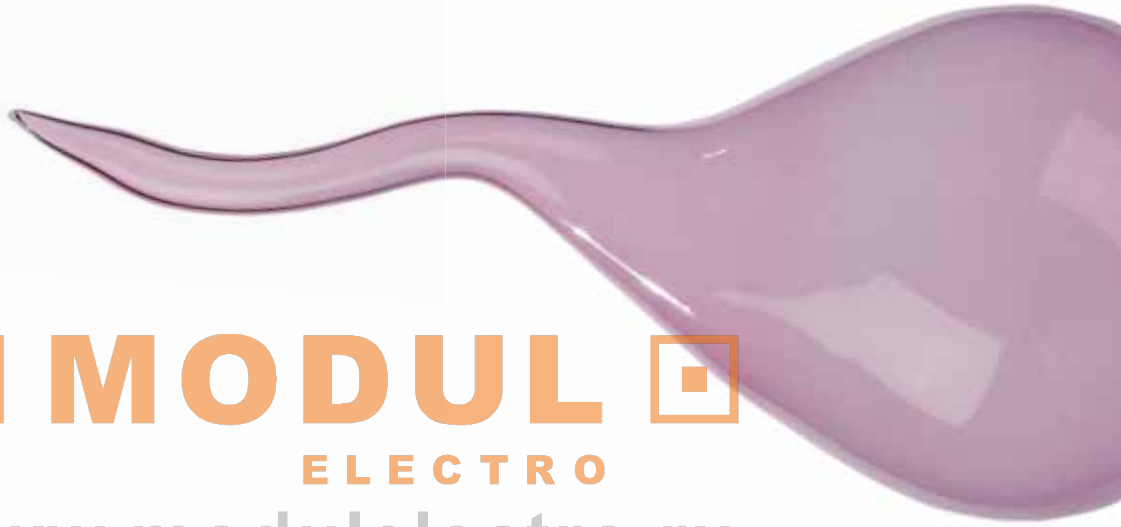

MODUL
ELECTRO

www.modulelectro.ru



MODUL

ELECTRO

www.modulelectro.ru

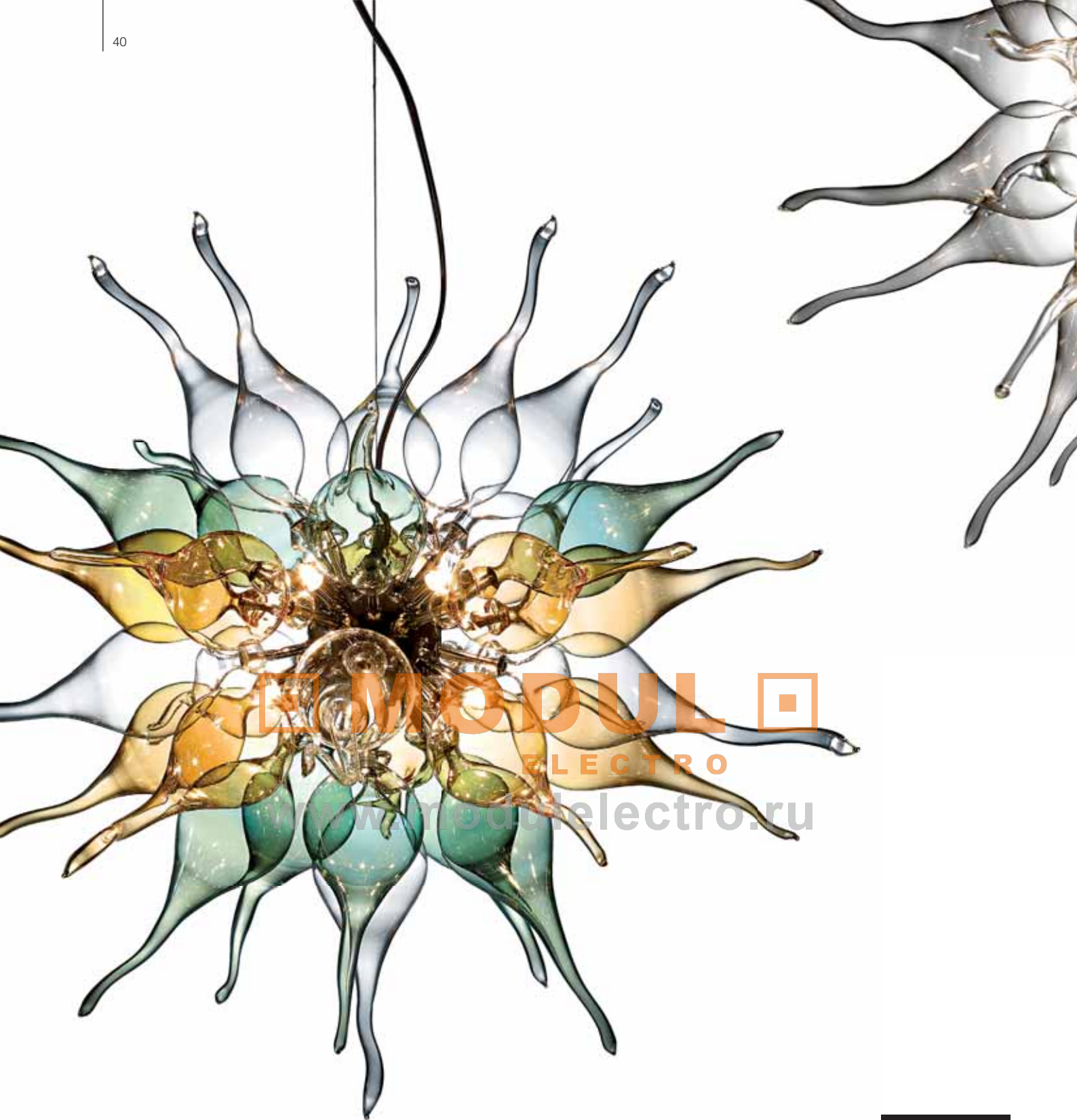



www.electro.ru
ELECTRO

SOLEIL

4713
D80 H90-150
10X40W G9



 **MODUL** 
ELECTRO
www.modulelectro.ru





4713
D80 H90-150
10X40W G9



MODUL
ELECTRO
www.modulelectro.ru



 **MODUL** 
ELECTRO
www.modulelectro.ru

soleil



MODULO
ELECTRO
www.modulelectro.ru



soleil



MODUL
ELECTRO
www.modulselectro.ru

4711
D60 H70-100
31X10W G4



 **MODUL** 
ELECTRO
www.modulelectro.ru



4702
L20 P20 H70-100
2x20W G4





4721
D20 H70-100
1x20W G4

4723
L40 P10 H50-150
3x20W G4

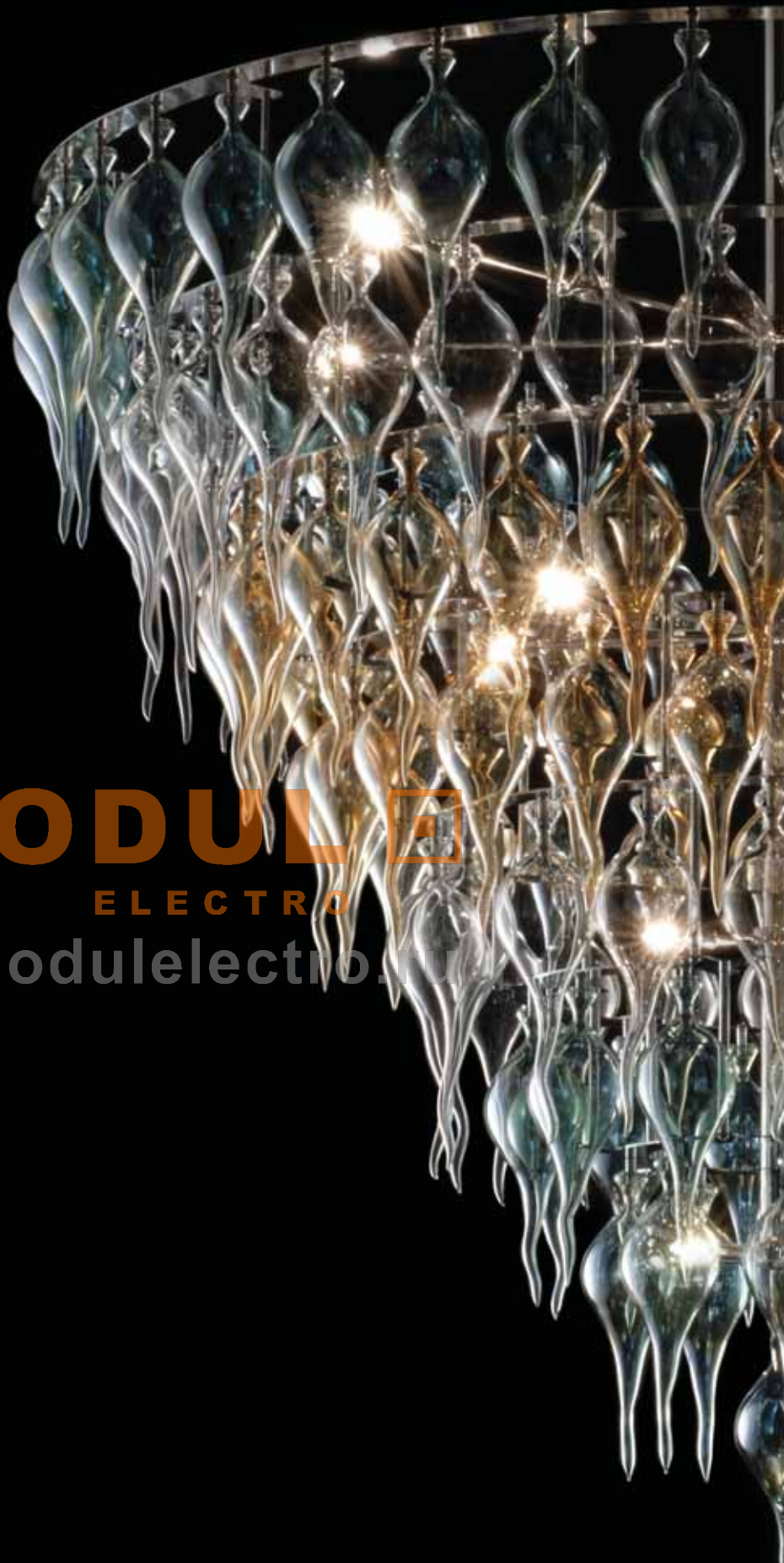
soleil



 **MODUL** 
ELECTRO
www.modulelectro.ru

soleil













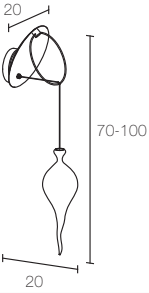

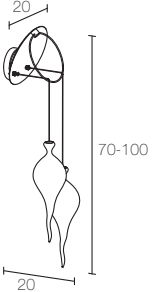
MODUL

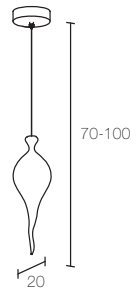

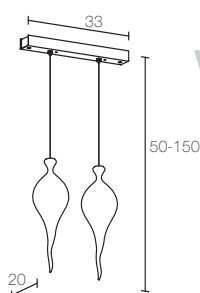

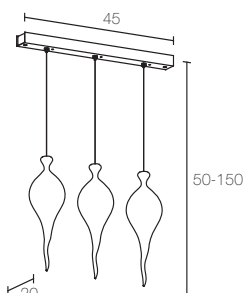

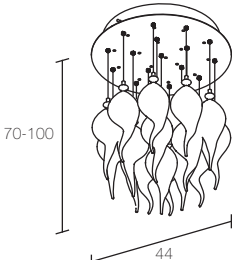



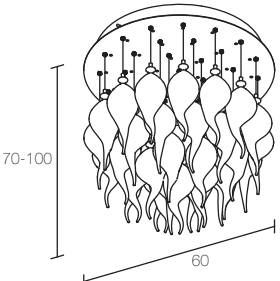

ELECTRO

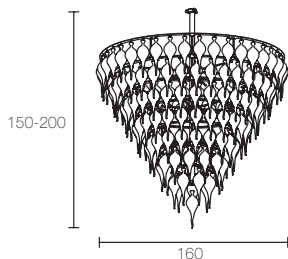
www.modulelectro.ru

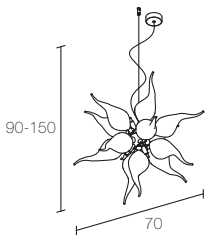
4715

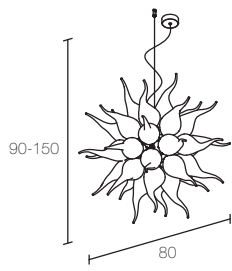
D180 H170-200
18X60W G9

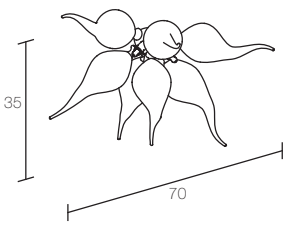
<p>SOLEIL - 4701 - *4751 LED</p> 	 <p>1X20W G4</p>  <p>*1X3W LED</p>	<p>Applique Struttura: foglia oro e argento. Diffusore: cristallo pirex nei colori ametista, verde, rosso, ambra e trasparente</p> <p>Wall lamp Structure: silver leaf or gold leaf. Diffuser: pyrex crystal available in the following colours amethyst, green, red, amber and transparent.</p> <p>⚡ ⚡ ⚡ CE</p>
<p>SOLEIL - 4702 - *4752 LED</p> 	 <p>2X20W G4</p>  <p>*2X3W LED</p>	<p>Applique Struttura: foglia oro e argento. Diffusore: cristallo pirex nei colori ametista, verde, rosso, ambra e trasparente</p> <p>Wall lamp Structure: silver leaf or gold leaf. Diffuser: pyrex crystal available in the following colours amethyst, green, red, amber and transparent.</p> <p>⚡ ⚡ ⚡ CE</p>
<p>SOLEIL - 4721 - *4771 LED</p> 	 <p>1X20W G4</p>  <p>*1X3W LED</p>	<p>Sospensione Struttura: cromo lucido. Diffusore: cristallo pirex nei colori ametista, verde, rosso, ambra e trasparente</p> <p>Hanging lamp Structure: polished chrome. Diffuser: pyrex crystal available in the following colours amethyst, green, red, amber and transparent.</p> <p>⚡ ⚡ ⚡ CE</p>
<p>SOLEIL - 4722 - *4772 LED</p> 	 <p>2X20W G4</p>  <p>*2X3W LED</p>	<p>Sospensione Struttura: cromo lucido. Diffusore: cristallo pirex nei colori ametista, verde, rosso, ambra e trasparente</p> <p>Hanging lamp Structure: polished chrome. Diffuser: pyrex crystal available in the following colours: amethyst, green, red, amber and transparent.</p> <p>⚡ ⚡ ⚡ CE</p>
<p>SOLEIL - 4723 - *4773 LED</p> 	 <p>3X20W G4</p>  <p>*3X3W LED</p>	<p>Sospensione Struttura: cromo lucido. Diffusore: cristallo pirex nei colori ametista, verde, rosso, ambra e trasparente</p> <p>Hanging lamp Structure: polished chrome. Diffuser: pyrex crystal available in the following colours amethyst, green, red, amber and transparent.</p> <p>⚡ ⚡ ⚡ CE</p>
<p>SOLEIL - 4710 - *4760 LED</p> 	 <p>16X10W G4</p>  <p>*16X3W LED</p>	<p>Plafoniera Struttura: finitura foglia oro, argento e cromo lucido. Diffusore: cristallo pirex nei colori ametista, verde, rosso, ambra e trasparente</p> <p>Ceiling lamp Structure: silver leaf, gold leaf or polished chrome. Diffuser: pyrex crystal available in the following colours amethyst, green, red, amber and transparent.</p> <p>⚡ ⚡ ⚡ CE</p>

<p>SOLEIL - 4711 - *4761 LED</p> 	 <p>31X10W G4</p>  <p>*31X3W LED</p>	<p>Plafoniera Struttura: foglia oro, argento e cromo lucido. Diffusore: cristallo pirex nei colori ametista, verde, rosso, ambra e trasparente.</p> <p>Ceiling lamp Structure: silver leaf, gold leaf or polished chrome. Diffuser: pyrex crystal available in the following colours amethyst, green, red, amber and transparent.</p> 
<p>SOLEIL - 4715</p> 	 <p>18X60W G9</p>	<p>Plafoniera Struttura: cromo lucido. Diffusore: cristallo pirex nei colori ametista, verde, rosso, ambra e trasparente</p> <p>Ceiling lamp Structure: polished chrome. Diffuser: pyrex crystal available in the following colours amethyst, green, red, amber and transparent.</p> 
<p>SOLEIL - 4712</p> 	 <p>6X60W G9</p>	<p>Sospensione Struttura: cromo lucido. Diffusore: cristallo pirex nei colori ametista, verde, rosso, ambra e trasparente.</p> <p>Hanging lamp Structure: polished chrome. Diffuser: pyrex crystal available in the following colours amethyst, green, red, amber and transparent.</p> 
<p>SOLEIL - 4713</p> 	 <p>10X40W G9</p>	<p>Sospensione Struttura: cromo lucido. Diffusore: cristallo pirex nei colori ametista, verde, rosso, ambra e trasparente.</p> <p>Hanging lamp Structure: polished chrome. Diffuser: pyrex crystal available in the following colours amethyst, green, red, amber and transparent.</p> 
<p>SOLEIL - 4720</p> 	 <p>5X60W G9</p>	<p>Plafoniera Struttura: finitura cromo lucido. Diffusore: cristallo pirex nei colori ametista, verde, rosso, ambra e trasparente.</p> <p>Ceiling lamp Structure: polished chrome. Diffuser: pyrex crystal available in the following colours amethyst, green, red, amber and transparent.</p> 



MODULO
ELECTRO
www.modulelectro.ru



SIRIUS

design MARIA GRAZIA ROSIN

5301
L10 P13 H36
2X50W GU10

 **MODUL** 
ELECTRO
www.modul-electro.ru







MODUL

ELECTRO

www.modulelectro.ru







 **MODUL** 
ELECTRO
www.modulselectro.ru



5315
D110 H108-150
16X50W GZ10

 **MODUL** 
ELECTRO
www.modulelectro.it

sirius



5313
D50 H80-150
4X40W G9+3X50W GZ10











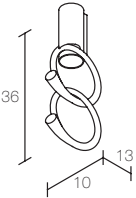

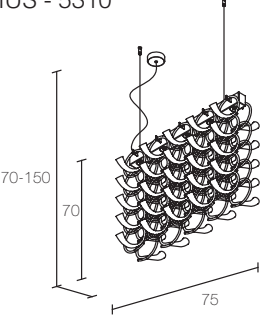

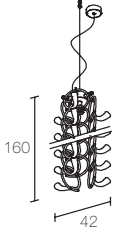
MODUL
ELECTRO
www.modulelectro.ru

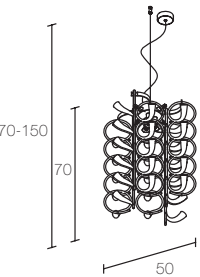

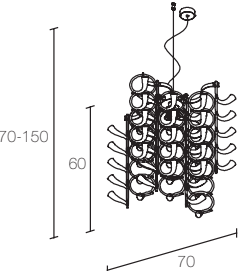

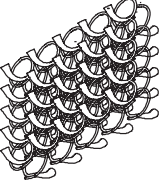





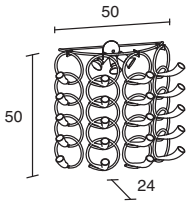

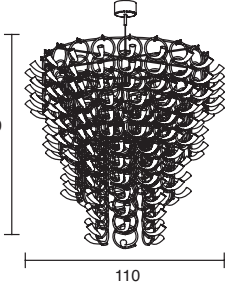

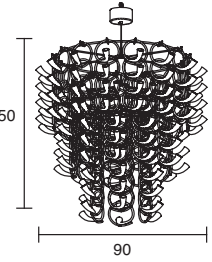
MODUL
ELECTRO
www.modulelectro.ru

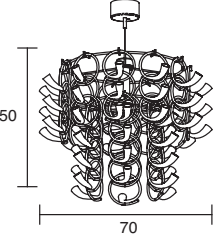
sirius

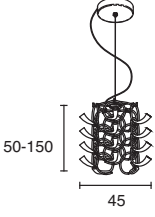
<p>SIRIUS - 5301</p> 	 2X50W GU10	<p>Applique Struttura: cromo lucido. Diffusore: pirex - sfera - cristallo trasparente.</p> <p>Wall lamp Structure: polished chrome. Diffuser: pyrex - sphere crystal transparent.</p> 
<p>SIRIUS - 5310</p> 	 5X50W GZ10	<p>Sospensione Struttura: cromo lucido. Diffusore: pirex - sfera - cristallo trasparente.</p> <p>Hanging lamp Structure: polished chrome. Diffuser: pyrex - sphere crystal transparent.</p> 
<p>SIRIUS - 5312</p> 	 5X40W G9 3x50W GZ10	<p>Sospensione Struttura: cromo lucido. Diffusore: pirex - sfera - cristallo trasparente.</p> <p>Hanging lamp Structure: polished chrome. Diffuser: pyrex - sphere crystal transparent.</p> 
<p>SIRIUS - 5313</p> 	 4X40W G9 3x50W GZ10	<p>Sospensione Struttura: cromo lucido. Diffusore: pirex - sfera - cristallo trasparente.</p> <p>Hanging lamp Structure: polished chrome. Diffuser: pyrex - sphere crystal transparent.</p> 
<p>SIRIUS - 5314</p> 	 4X40W G9 3x50W GZ10	<p>Sospensione Struttura: cromo lucido. Diffusore: pirex - sfera - cristallo trasparente.</p> <p>Hanging lamp Structure: polished chrome. Diffuser: pyrex - sphere crystal transparent.</p> 
<p>SIRIUS - CUSTOM</p> 		<p>Si realizzano modelli su misura.</p> <p>Custom model are realized.</p> 

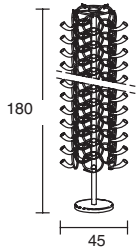
MODULO
ELECTRO
www.modulelectro.ru



<p>SIRIUS - 5302</p> 	 <p>3X50W GZ10</p>	<p>Sospensione Struttura: cromo lucido. Diffusore: pirex - sfera - cristallo trasparente.</p> <p>Hanging lamp Structure: polished chrome. Diffuser: pyrex - sphere crystal transparent.</p> <p>⚡ ⚡ ⚡ CE</p>
<p>SIRIUS - 5315</p> 	 <p>16X50W GZ10</p>	<p>Sospensione Struttura: cromo lucido. Diffusore: pirex - sfera - cristallo trasparente.</p> <p>Hanging lamp Structure: polished chrome. Diffuser: pyrex - sphere crystal transparent.</p> <p>⚡ ⚡ ⚡ CE</p>
<p>SIRIUS - 5316</p> 	 <p>7X50W GZ10</p>	<p>Sospensione Struttura: cromo lucido. Diffusore: pirex - sfera - cristallo trasparente.</p> <p>Hanging lamp Structure: polished chrome. Diffuser: pyrex - sphere crystal transparent.</p> <p>⚡ ⚡ ⚡ CE</p>
<p>SIRIUS - 5317</p> 	 <p>4X50W GZ10</p>	<p>Sospensione Struttura: cromo lucido. Diffusore: pirex - sfera - cristallo trasparente.</p> <p>Hanging lamp Structure: polished chrome. Diffuser: pyrex - sphere crystal transparent.</p> <p>⚡ ⚡ ⚡ CE</p>
<p>SIRIUS - 5318</p> 	 <p>3X50W GZ10</p>	<p>Sospensione Struttura: cromo lucido. Diffusore: pirex - sfera - cristallo trasparenteo.</p> <p>Hanging lamp Structure: polished chrome. Diffuser: pyrex - sphere crystal transparent.</p> <p>⚡ ⚡ ⚡ CE</p>
<p>SIRIUS - 5330</p> 	 <p>3X50W GZ10</p>	<p>Lampada terra Struttura: cromo lucido. Diffusore: pirex - sfera - cristallo trasparente.</p> <p>Floor lamp Structure: polished chrome. Diffuser: pyrex - sphere crystal transparent.</p> <p>⚡ ⚡ ⚡ CE</p>



ELECTRO

www.modulelectro.ru





 **MODUL** 
ELECTRO
www.modulelectro.ru

5610
L12 P12 H12-150
1X60W G9

5611
L25 P25 H25-150
4X60W G9



 **MODUL** 
ELECTRO
www.modulelectro.ru

stars



MODUL
ELECTRO
www.modulelectro.ru

stars



 **MODUL** 
ELECTRO
www.modulelectro.ru

5605
L40 P8 H40
4X40W G9



5607
L60 P12 H12
3X60W G9



MODULO
ELECTRO

www.modulelectro.ru

stars

5602

L20 P8 H20
1X40W G9

5603

L30 P8 H30
3X40W G9

5605

L40 P8 H40
4X40W G9



MODUL
ELECTRO
www.modulelectro.ru



MODUL
ELECTRO
www.modulelectro.ru



MODULO
ELECTRO

www.modulelectro.ru











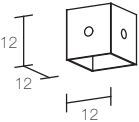

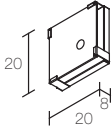
5613
L60 P12 H12-150
3X40W G9

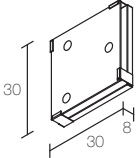

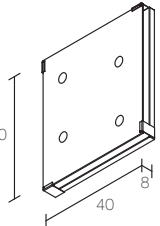

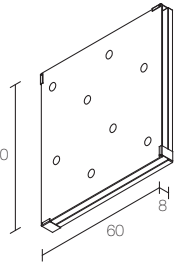

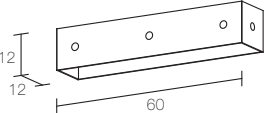



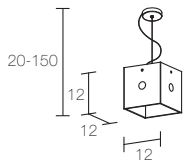

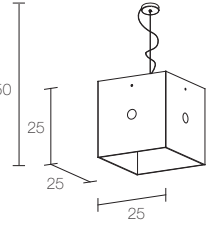

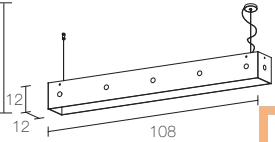
5640
L12 P12 H35
1X60W G9

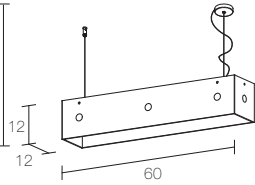
stars

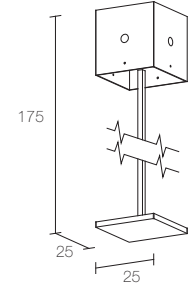

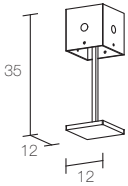
<p>STARS - 5601</p> 	 1X60W G9	<p>Applique Struttura: laccato bianco - particolari cromo lucido. Diffusore: cristallo serigrafato bianco - sfera cristallo trasparente.</p> <p>Wall lamp Structure: enamelled white - polished chrome details. Diffuser: crystal silkscreened white - sphere crystal transparent.</p> <p>⚡ ⚡ ⚡ CE</p>
<p>STARS - 5602</p> 	 1X40W G9	<p>Applique/Plafoniera Struttura: laccato bianco - particolari cromo lucido. Diffusore: cristallo serigrafato bianco - sfera cristallo trasparente.</p> <p>Wall lamp/Ceiling lamp Structure: enamelled white - polished chrome details. Diffuser: crystal silkscreened white - sphere crystal transparent.</p> <p>⚡ ⚡ ⚡ CE</p>
<p>STARS - 5603</p> 	 3X40W G9	<p>Applique/Plafoniera Struttura: laccato bianco - particolari cromo lucido. Diffusore: cristallo serigrafato bianco - sfera cristallo trasparente.</p> <p>Wall lamp/Ceiling lamp Structure: enamelled white - polished chrome details. Diffuser: crystal silkscreened white - sphere crystal transparent.</p> <p>⚡ ⚡ ⚡ CE</p>
<p>STARS - 5605</p> 	 4X40W G9	<p style="text-align: center;">ELECTRO</p> <p>Applique/Plafoniera Struttura: laccato bianco - particolari cromo lucido. Diffusore: cristallo serigrafato bianco - sfera cristallo trasparente.</p> <p>Wall lamp/Ceiling lamp Structure: enamelled white - polished chrome details. Diffuser: crystal silkscreened white - sphere crystal transparent.</p> <p>⚡ ⚡ ⚡ CE</p>
<p>STARS - 5606</p> 	 8X40W G9	<p>Applique/Plafoniera Struttura: laccato bianco - particolari cromo lucido. Diffusore: cristallo serigrafato bianco - sfera cristallo trasparente.</p> <p>Wall lamp/Ceiling lamp Structure: enamelled white - polished chrome details. Diffuser: crystal silkscreened white - sphere crystal transparent.</p> <p>⚡ ⚡ ⚡ CE</p>
<p>STARS - 5607</p> 	 3X60W G9	<p>Applique Struttura: laccato bianco - particolari cromo lucido. Diffusore: cristallo serigrafato bianco - sfera cristallo trasparente.</p> <p>Wall lamp Structure: enamelled white - polished chrome details. Diffuser: crystal silkscreened white - sphere crystal transparent.</p> <p>⚡ ⚡ ⚡ CE</p>

<p>STARS - 5610</p> 	 1X60W G9	<p>Sospensione Struttura: cromo lucido. Diffusore: cristallo serigrafato bianco - sfera cristallo trasparente.</p> <p>Hanging lamp Structure: polished chrome. Diffuser: crystal silkscreened white - sphere crystal transparent.</p> 
<p>STARS - 5611</p> 	 4X60W G9	<p>Sospensione Struttura: cromo lucido. Diffusore: cristallo serigrafato bianco - sfera cristallo trasparente.</p> <p>Hanging lamp Structure: polished chrome. Diffuser: crystal silkscreened white - sphere crystal transparent.</p> 
<p>STARS - 5612</p> 	 5X40W G9	<p>Sospensione Struttura: cromo lucido. Diffusore: cristallo serigrafato bianco - sfera cristallo trasparente.</p> <p>Hanging lamp Structure: polished chrome. Diffuser: crystal silkscreened white - sphere crystal transparent.</p> 
<p>STARS - 5613</p> 	 3X60W G9	<p>Sospensione Struttura: cromo lucido. Diffusore: cristallo serigrafato bianco - sfera cristallo trasparente.</p> <p>Hanging lamp Structure: polished chrome. Diffuser: crystal silkscreened white - sphere crystal transparent.</p> 
<p>STARS - 5630</p> 	 4X60W G9	<p>Lampada terra Struttura: cromo lucido. Diffusore: cristallo serigrafato bianco - sfera cristallo trasparente.</p> <p>Floor lamp Structure: polished chrome. Diffuser: crystal silkscreened white - sphere crystal transparent.</p> 
<p>STARS - 5640</p> 	 1X60W G9	<p>Lampada tavolo Struttura: cromo lucido. Diffusore: cristallo serigrafato bianco - sfera cristallo trasparente.</p> <p>Table lamp Structure: polished chrome. Diffuser: crystal silkscreened white - sphere crystal transparent.</p> 



MODUL
ELECTRO

www.modulelectro.ru

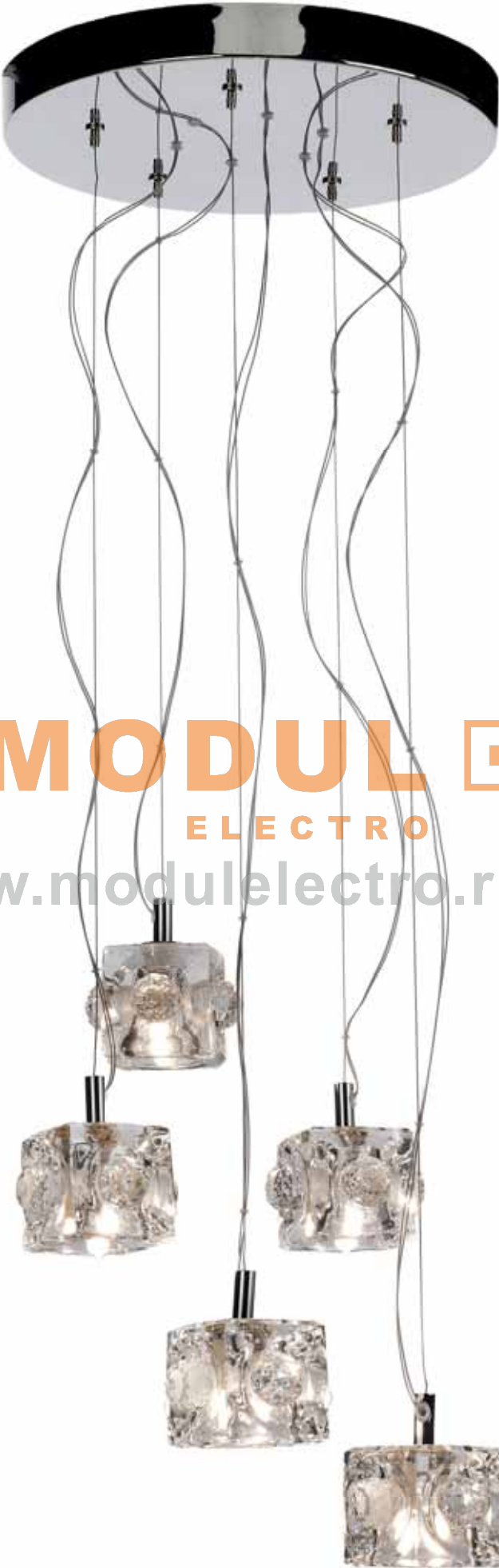

MODUL
ELECTRO
www.modulelectro.ru

ice

3015
D30 H50-120
5X40W G9



MODUL
ELECTRO

www.modulelectro.ru

3016
D60 H50-120
16X40W G9

MODULO
ELECTRO
www.modulelectro.ru



3011
L8 P8 H50-120
1X40W G9

ice





MODUL
ELECTRO
www.modulelectro.ru

3001
L10 P17 H10
1X40W G9

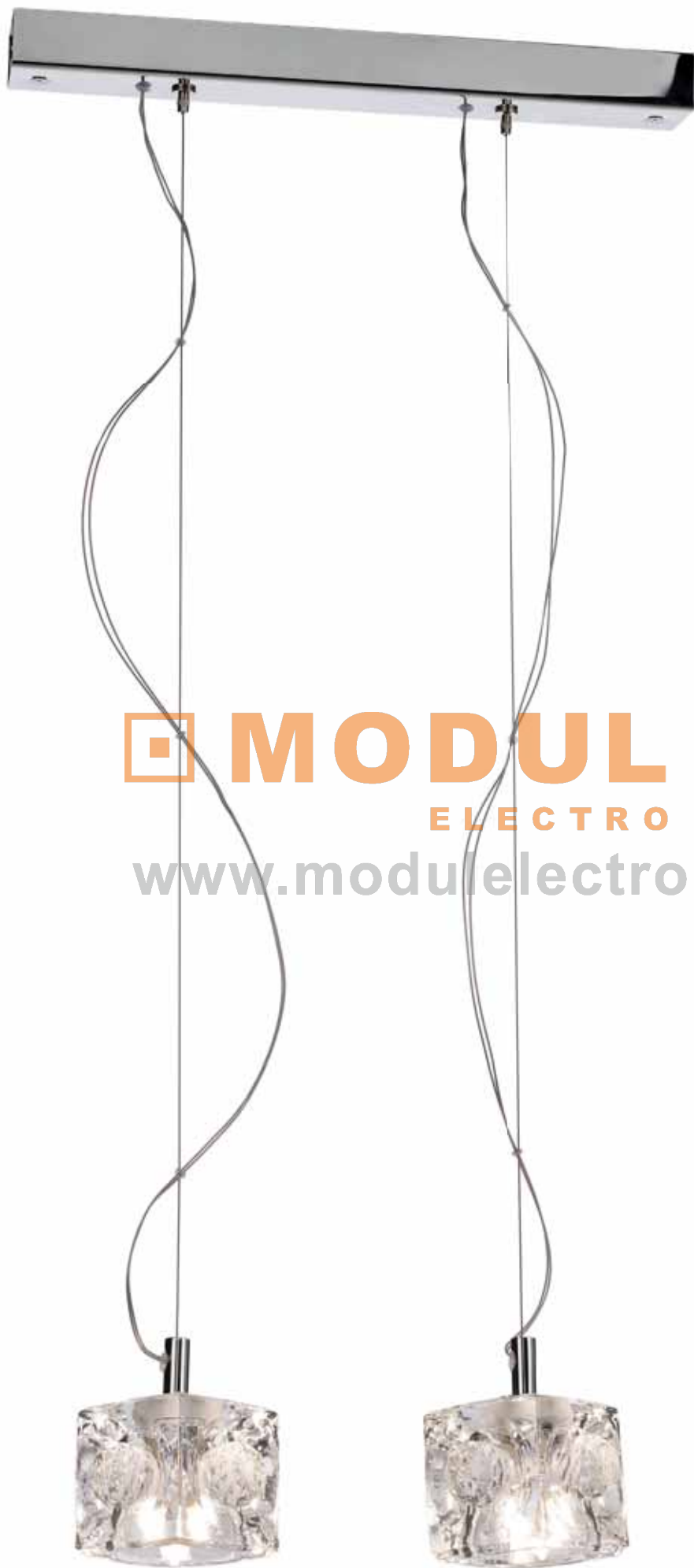









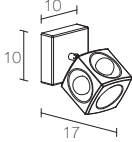

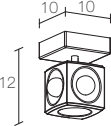
3021
L10 P10 H12
1X40W G9

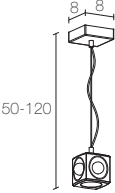

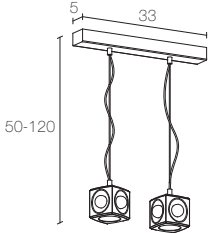
 **MODULO** 
ELECTRO
www.modulelectro.ru

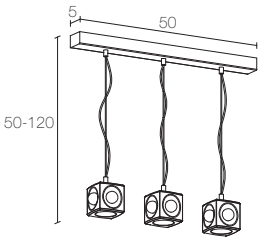
3022
L33 P5 H50-120
2X40W G9

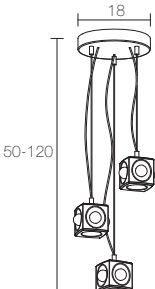
ice

<p>ICE - 3001 - *3051 LED</p> 	 1X40W G9  *1X3W LED	<p>Applique Struttura: cromo lucido. Diffusore: cristallo trasparente con sfera cristallo.</p> <p>Wall lamp Structure: polished chrome. Diffuser: crystal transparent with crystal sphere.</p> <p>⚡ ⚡ CE</p>
<p>ICE - 3021 - *3071 LED</p> 	 1X40W G9  *1X3W LED	<p>Plafoniera Struttura: cromo lucido. Diffusore: cristallo trasparente con sfera cristallo.</p> <p>Ceiling lamp Structure: polished chrome. Diffuser: crystal transparent with crystal sphere.</p> <p>⚡ ⚡ CE</p>
<p>ICE - 3011 - *3061 LED</p> 	 1X40W G9  *1X3W LED	<p>Sospensione Struttura: cromo lucido. Diffusore: cristallo trasparente con sfera cristallo.</p> <p>Hanging lamp Structure: polished chrome. Diffuser: crystal transparent with crystal sphere.</p> <p>⚡ ⚡ CE</p>
<p>ICE - 3022 - *3072 LED</p> 	 2X40W G9  *2X3W LED	<p>Sospensione Struttura: cromo lucido. Diffusore: cristallo trasparente con sfera cristallo.</p> <p>Hanging lamp Structure: polished chrome. Diffuser: crystal transparent with crystal sphere.</p> <p>⚡ ⚡ CE</p>
<p>ICE - 3023 - *3073 LED</p> 	 3X40W G9  *3X3W LED	<p>Sospensione Struttura: cromo lucido. Diffusore: cristallo trasparente con sfera cristallo.</p> <p>Hanging lamp Structure: polished chrome. Diffuser: crystal transparent with crystal sphere.</p> <p>⚡ ⚡ CE</p>
<p>ICE - 3013 - *3053 LED</p> 	 3X40W G9  *3X3W LED	<p>Sospensione Struttura: cromo lucido. Diffusore: cristallo trasparente con sfera cristallo.</p> <p>Hanging lamp Structure: polished chrome. Diffuser: crystal transparent with crystal sphere.</p> <p>⚡ ⚡ CE</p>

MODULO
ELECTRO
www.modulelectro.ru

ICE - 3015 - *3055 LED

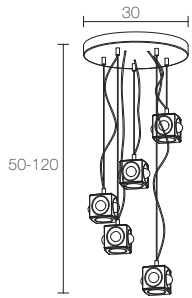

5X40W G9



*5X3W LED

Sospensione

Struttura: cromo lucido.

Diffusore: cristallo trasparente con sfera cristallo.

Hanging lamp

Structure: polished chrome.

Diffuser: crystal transparent with crystal sphere.



ICE - 3016 - *3066 LED

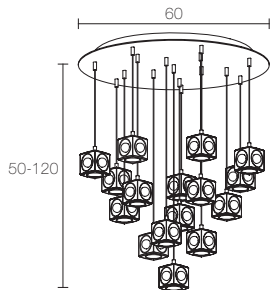

16X40W G9



*16X3W LED

Sospensione

Struttura: cromo lucido.



Diffusore: cristallo trasparente con sfera cristallo.



Hanging lamp

Structure: polished chrome.

Diffuser: crystal transparent with crystal sphere.



 **MODULO** 
ELECTRO
www.modulelectro.ru

 **MODUL** 
ELECTRO
www.modulelectro.ru

square



MODUL
ELECTRO
www.modulelectro.ru

6702
L50 P10 H50
4X60W E14

6701
L40 P10 H40
4X40W E14

6703
L60 P10 H60
4X60W E14



MODUL
ELECTRO
www.modulelectro.ru

starry

6522
D70 H14
4X60W E27

81

ELECTRO
www.modulelectro.ru

6521
D50 H12
4X60W E27

6520
D40 H10
2X60W E27

shiny

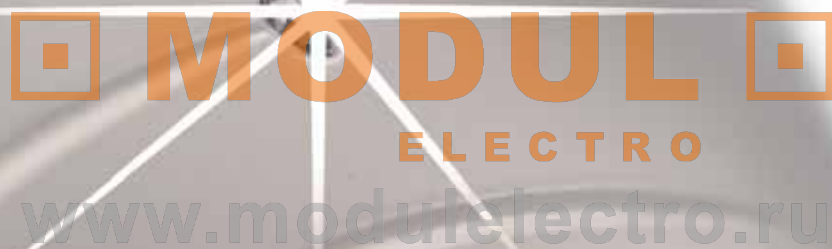
The logo for MODUL ELECTRO is centered on the page. It features the word "MODUL" in a large, bold, orange sans-serif font, flanked by two orange squares. Below "MODUL" is the word "ELECTRO" in a smaller, orange sans-serif font. At the bottom of the logo is the website address "www.modulelectro.ru" in a grey sans-serif font. A white starburst graphic with eight rays is positioned behind the logo, centered on a dark, curved metallic surface that reflects light, creating a sense of depth and shine.

MODUL
ELECTRO
www.modulelectro.ru



MODUL
ELECTRO

www.modulelectro.ru

6601

L30 P9 H17
1X75W E27

6620

D45 H22
3X75W E27

MODULO
ELECTRO
www.modulelectro.ru

shiny



MODUL
ELECTRO
www.modulelectro.ru

6510
D30 H12
2X60W E27

MODUL
ELECTRO
www.modulelectro.ru













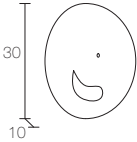

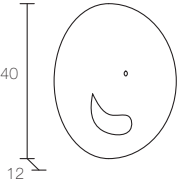
6512
D60 H14
4X60W E27

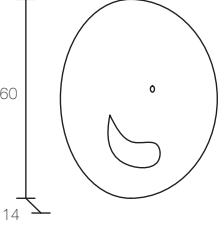

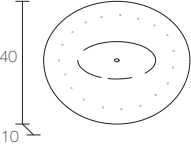

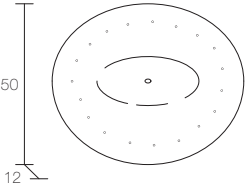

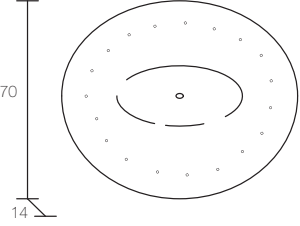



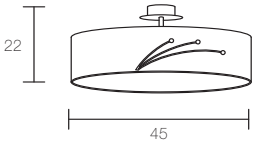

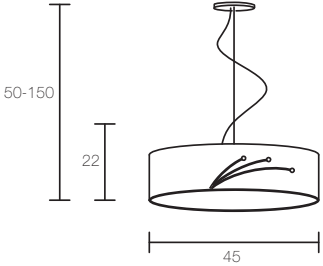
6511
D40 H12
4X60W E27

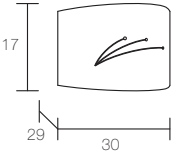
pierrrot

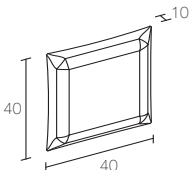

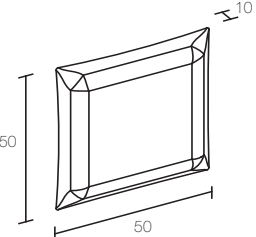
MODUL
ELECTRO
www.modulelectro.ru

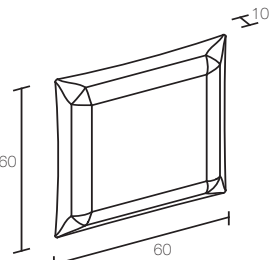
<p>PIERROT - 6510</p> 	 2X60W E27  2X20W E27	<p>Applique/Plafoniera Struttura: laccato bianco Diffusore: cristallo bianco.</p> <p>Wall lamp/Ceiling lamp Structure: enamelled white. Diffuser: white crystal.</p> <p>⚡ ⚡ CE</p>
<p>PIERROT - 6511</p> 	 4X60W E27  4X24W E27	<p>Applique/Plafoniera Struttura: laccato bianco Diffusore: cristallo bianco.</p> <p>Wall lamp/Ceiling lamp Structure: enamelled white. Diffuser: white crystal.</p> <p>⚡ ⚡ CE</p>
<p>PIERROT - 6512</p> 	 4X75W E27  4X24W E27	<p>Applique/Plafoniera Struttura: laccato bianco Diffusore: cristallo bianco.</p> <p>Wall lamp/Ceiling lamp Structure: enamelled white. Diffuser: white crystal.</p> <p>⚡ ⚡ CE</p>
<p>STARRY - 6520</p> 	 2X60W E27  2X20W E27	<p style="text-align: center;">ELECTRO</p> <p>Applique/Plafoniera Struttura: laccato bianco Diffusore: cristallo satinato bianco - particolari cristallo.</p> <p>Wall lamp/Ceiling lamp Structure: enamelled white. Diffuser: crystal satined white - details crystal.</p> <p>⚡ ⚡ CE</p>
<p>STARRY - 6521</p> 	 4X60W E27  4X24W E27	<p>Applique/Plafoniera Struttura: laccato bianco Diffusore: cristallo satinato bianco - particolari cristallo.</p> <p>Wall lamp/Ceiling lamp Structure: enamelled white. Diffuser: crystal satined white - details crystal.</p> <p>⚡ ⚡ CE</p>
<p>STARRY - 6522</p> 	 4X75W E27  4X24W E27	<p>Applique/Plafoniera Struttura: laccato bianco Diffusore: cristallo satinato bianco - particolari cristallo.</p> <p>Wall lamp/Ceiling lamp Structure: enamelled white. Diffuser: crystal satined white - details crystal.</p> <p>⚡ ⚡ CE</p>

<p>SHINY - 6620</p> 	 3X75W E27  3X24W E27	<p>Plafoniera Struttura: cromo lucido. Diffusore: cristallo bianco sabbiato inciso - particolari cristallo.</p> <p>Ceiling lamp Structure: polished chrome. Diffuser: sandblasted white crystal engraved - details crystal.</p> <p>⊕ ⚡ CE</p>
<p>SHINY - 6610</p> 	 3X75W E27  3X24W E27	<p>Sospensione Struttura: cromo lucido. Diffusore: cristallo bianco sabbiato inciso - particolari cristallo.</p> <p>Hanging lamp Structure: polished chrome. Diffuser: sandblasted white crystal engraved - details crystal.</p> <p>⊕ ⚡ CE</p>
<p>SHINY - 6601</p> 	 1X75W E27  1X24W E27	<p>Applique Struttura: cromo lucido. Diffusore: cristallo bianco sabbiato inciso - particolari cristallo.</p> <p>Wall lamp Structure: polished chrome. Diffuser: sandblasted white crystal engraved - details crystal.</p> <p>⊕ ⚡ CE</p>
<p>SQUARE - 6701</p> 	 4X40W E14  4X24W E27	<p style="text-align: center;">ELECTRO</p> <p>Applique/Plafoniera Struttura: laccato bianco Diffusore: cristallo satinato bianco.</p> <p>Wall lamp/Ceiling lamp Structure: enamelled white. Diffuser: crystal satined white.</p> <p>⊕ ⚡ CE</p>
<p>SHINY - 6702</p> 	 4X60W E14  4X24W E27	<p>Applique/Plafoniera Struttura: laccato bianco Diffusore: cristallo satinato bianco.</p> <p>Wall lamp/Ceiling lamp Structure: enamelled white. Diffuser: crystal satined white.</p> <p>⊕ ⚡ CE</p>
<p>SHINY - 6703</p> 	 4X60W E14  4X24W E27	<p>Applique/Plafoniera Struttura: laccato bianco Diffusore: cristallo satinato bianco.</p> <p>Wall lamp/Ceiling lamp Structure: enamelled white. Diffuser: crystal satined white.</p> <p>⊕ ⚡ CE</p>



MODUL
ELECTRO
www.modulelectro.ru



wallwing
design SANDI RENKO

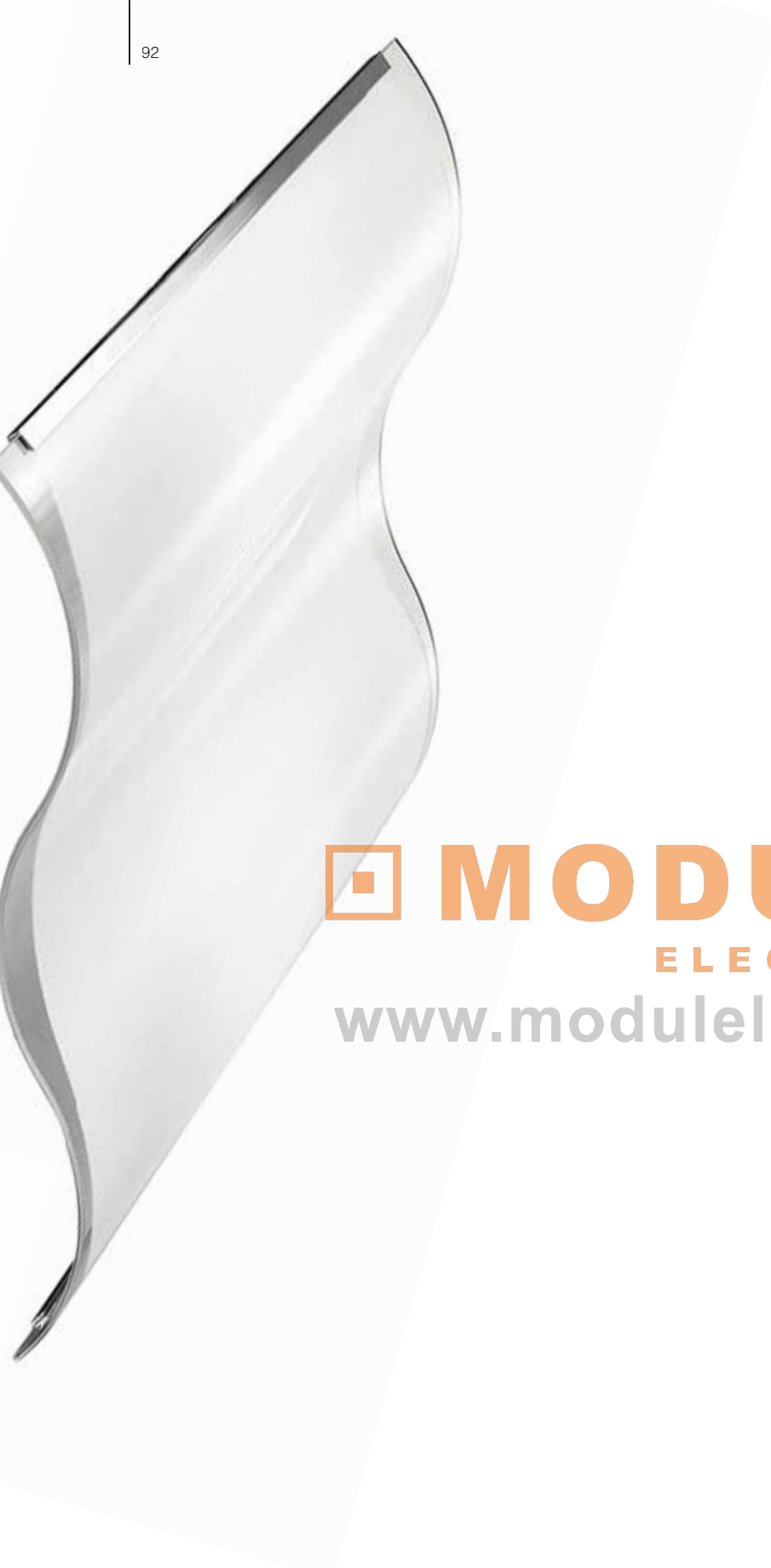

MODUL
ELECTRO
www.modulelectro.ru

2373
L67 P67 H5
4X55W 2G11



 **MODUL** 
ELECTRO
www.modulelectro.ru

wallwing



2371
L67 P37 H5
4X18W 2G11

MODUL
ELECTRO



www.modulelectro.ru



2370
L37 P34 H5
2X18W 2G11





 **MODUL** 
ELECTRO
www.modulelectro.ru

wallwing



MODUL
ELECTRO
www.modulelectro.ru

2361







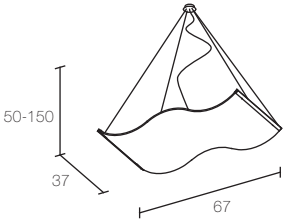
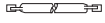
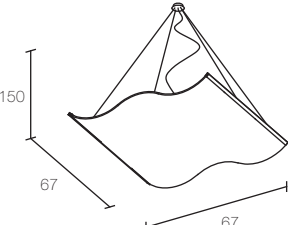
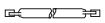
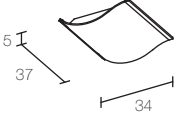

L67 P67 H50-150
2X200W R7s

walkwing

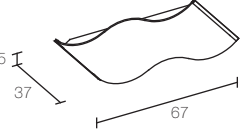
 **MODUL** 
ELECTRO

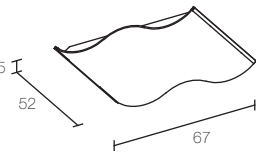
www.modulelectro.ru

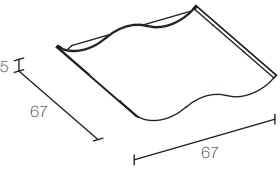

<p>WALLWING - 2360</p> 	 2X150W R7s	<p>Sospensione Struttura: cromo lucido - laccato bianco. Diffusore: cristallo bianco sabbato.</p> <p>Hanging lamp Structure: polished chrome - enamelled white. Diffuser: sandblasted white crystal.</p> <p>⚡ ⚡ CE</p>
<p>WALLWING - 2361</p> 	 2X200W R7s	<p>Sospensione Struttura: cromo lucido - laccato bianco. Diffusore: cristallo bianco sabbato.</p> <p>Hanging lamp Structure: polished chrome - enamelled white. Diffuser: sandblasted white crystal.</p> <p>⚡ ⚡ CE</p>
<p>WALLWING - 2370</p> 	 2X18W 2G11	<p>Applique/Plafoniera Struttura: cromo lucido - laccato bianco. Diffusore: cristallo bianco sabbato.</p> <p>Wall lamp/Ceiling lamp Structure: polished chrome - enamelled white. Diffuser: sandblasted white crystal.</p> <p>⚡ ⚡ CE</p>
<p>WALLWING - 2371</p> 	 2X18W 2G11	<p>Applique/Plafoniera Struttura: cromo lucido - laccato bianco. Diffusore: cristallo bianco sabbato.</p> <p>Wall lamp/Ceiling lamp Structure: polished chrome - enamelled white. Diffuser: sandblasted white crystal.</p> <p>⚡ ⚡ CE</p>
<p>WALLWING - 2372</p> 	 4X24W 2G11	<p>Applique/Plafoniera Struttura: cromo lucido - laccato bianco. Diffusore: cristallo bianco sabbato.</p> <p>Wall lamp/Ceiling lamp Structure: polished chrome - enamelled white. Diffuser: sandblasted white crystal.</p> <p>⚡ ⚡ CE</p>
<p>WALLWING - 2373</p> 	 4X55W 2G11	<p>Applique/Plafoniera Struttura: cromo lucido - laccato bianco. Diffusore: cristallo bianco sabbato.</p> <p>Wall lamp/Ceiling lamp Structure: polished chrome - enamelled white. Diffuser: sandblasted white crystal.</p> <p>⚡ ⚡ CE</p>

MODULO
ELECTRO
www.moduloelectro.ru



MODUL
ELECTRO
www.modulelectro.ru

8917
L160 P32 H40-150
3X150W R7s



nalowinġ

design SANDI RENKO

 **MODUL** 
ELECTRO

www.modulelectro.ru



MODUL
ELECTRO

www.modulelectro.ru

8916
L100 P32 H40-150
2X150W R7s



malowing

MODULO
ELECTRO

www.modulelectro.ru





MODUL
ELECTRO
www.modulelectro.ru

8903
L32 P20 H160
3X150W R7s





MODUL
ELECTRO
www.modulelectro.ru

8901
L32 P20 H50
1X150W R7s

halowing

9303
L32 P20 H160
2X49W G5 FLUOR



 **MODUL** 
ELECTRO
www.modulelectro.ru

9317

L160 P32 H40-150
2X49W G5 FLUOR

9302

L100 P20 H32
2X39W G5 FLUORThe logo for MODUL ELECTRO features the word "MODUL" in a bold, orange, sans-serif font, with "ELECTRO" in a smaller, orange, sans-serif font below it. The text is flanked by two orange squares, each containing a smaller orange square in the center.

MODUL
ELECTRO

www.modulelectro.ru

fluorwing



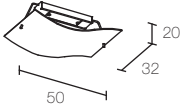
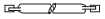
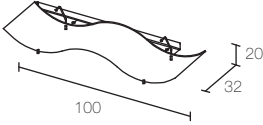
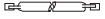
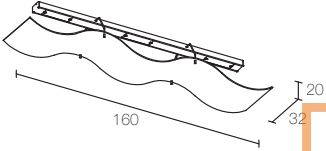
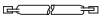
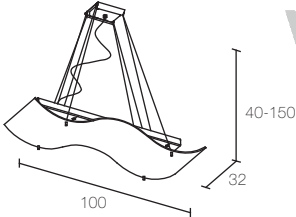
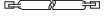
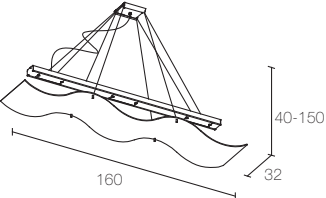
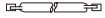



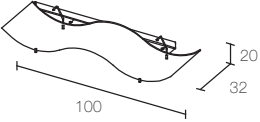

design SANDI RENKO

<p>HALOWING - 8901</p> 	 <p>1X150W R7s</p>	<p>Applique/Plafoniera Struttura: profilo in alluminio estruso laccato alluminio opaco con particolari in cromo lucido. Diffusore: cristallo sabbato.</p> <p>Wall lamp/Ceiling lamp Structure: extruded aluminium in matt enamelled aluminium and polished chrome details. Diffuser: sandblasted crystal.</p> <p>⊥ ⚡ CE</p>
<p>HALOWING - 8902</p> 	 <p>2X150W R7s</p>	<p>Applique/Plafoniera Struttura: profilo in alluminio estruso laccato alluminio opaco con particolari in cromo lucido. Diffusore: cristallo sabbato.</p> <p>Wall lamp/Ceiling lamp Structure: extruded aluminium in matt enamelled aluminium and polished chrome details. Diffuser: sandblasted crystal.</p> <p>⊥ ⚡ CE</p>
<p>HALOWING - 8903</p> 	 <p>3X150W R7s</p>	<p>Applique/Plafoniera Struttura: profilo in alluminio estruso laccato alluminio opaco con particolari in cromo lucido. Diffusore: cristallo sabbato.</p> <p>Wall lamp/Ceiling lamp Structure: extruded aluminium in matt enamelled aluminium and polished chrome details. Diffuser: sandblasted crystal.</p> <p>⊥ ⚡ CE</p>
<p>HALOWING - 8916</p> 	 <p>2X150W R7s</p>	<p>Sospensione Struttura: profilo in alluminio estruso laccato alluminio opaco con particolari in cromo lucido. Diffusore: cristallo sabbato.</p> <p>Hanging lamp Structure: extruded aluminium in matt enamelled aluminium and polished chrome details. Diffuser: sandblasted crystal.</p> <p>⊥ ⚡ CE</p>
<p>HALOWING - 8917</p> 	 <p>3X150W R7s</p>	<p>Sospensione Struttura: profilo in alluminio estruso laccato alluminio opaco con particolari in cromo lucido. Diffusore: cristallo sabbato.</p> <p>Hanging lamp Structure: extruded aluminium in matt enamelled aluminium and polished chrome details. Diffuser: sandblasted crystal.</p> <p>⊥ ⚡ CE</p>

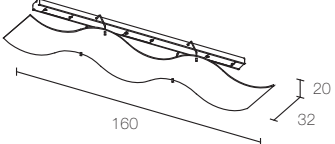

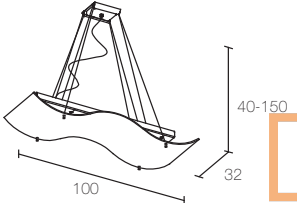
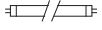
ELECTRO

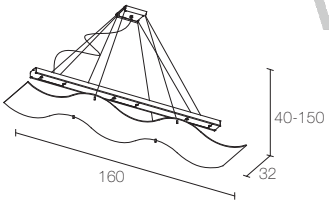

www.moduloelectro.ru

<p>FLUORWING - 9302</p> 	 2X39W G5	<p>Applique/Plafoniera Struttura: profilo in alluminio estruso laccato alluminio opaco con particolari in cromo lucido. Diffusore: cristallo sabbiato.</p> <p>Wall lamp/Ceiling lamp Structure: extruded aluminium in matt enamelled aluminium and polished chrome details. Diffuser: sandblasted crystal.</p> 
<p>FLUORWING - 9303</p> 	 2X49W G5	<p>Applique/Plafoniera Struttura: profilo in alluminio estruso laccato alluminio opaco con particolari in cromo lucido. Diffusore: cristallo sabbiato.</p> <p>Wall lamp/Ceiling lamp Structure: extruded aluminium in matt enamelled aluminium and polished chrome details. Diffuser: sandblasted crystal.</p> 
<p>FLUORWING - 9316</p> 	 2X39W G5	<p>Sospensione Struttura: profilo in alluminio estruso laccato alluminio opaco con particolari in cromo lucido Diffusore: cristallo sabbiato.</p> <p>Hanging lamp Structure: extruded aluminium in matt enamelled aluminium and polished chrome details. Diffuser: sandblasted crystal.</p> 
<p>FLUORWING - 9317</p> 	 2X49W G5	<p>Sospensione Struttura: profilo in alluminio estruso laccato alluminio opaco con particolari in cromo lucido Diffusore: cristallo sabbiato.</p> <p>Hanging lamp Structure: extruded aluminium in matt enamelled aluminium and polished chrome details. Diffuser: sandblasted crystal.</p> 

MODULO

ELECTRO

www.modulelectro.ru

 **MODUL** 
ELECTRO
www.modulelectro.ru

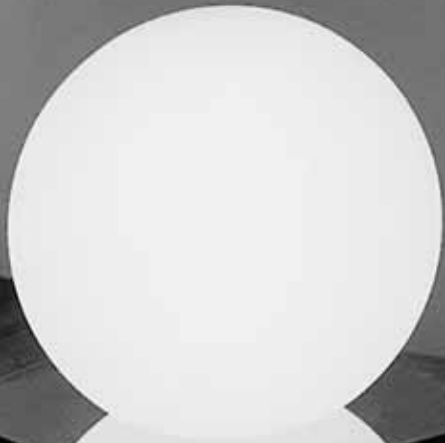

9292
L40 P40 H42
1X75W E27

ELECTRO
www.modulelectro.ru

micol
design SERGIO MAZZA
GIULIANA GRAMIGNA

micoi

 **MODUL** 
ELECTRO

www.modulelectro.ru

9292
L40 P40 H42
1X75W E27

9293
L45 P45 H48
1X75W E27

MICOL - 9292

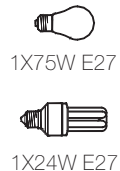
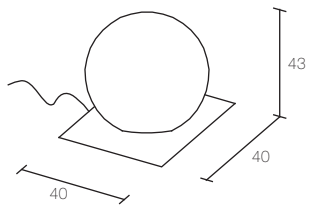

Lampada tavolo
Struttura: acciaio inox lucido.
Diffusore: sfera in vetro soffiato opale bianco satinato.

Table lamp
Structure: polished stainless steel.
Diffuser: sphere in satin-finished white opal blown glass.



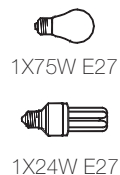
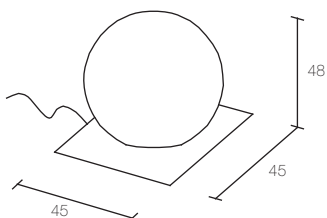

MICOL - 9293



Lampada tavolo
Struttura: acciaio inox lucido.
Diffusore: sfera in vetro soffiato opale bianco satinato.

Table lamp
Structure: polished stainless steel.
Diffuser: sphere in satin-finished white opal blown glass.



 **MODULO** 
ELECTRO
www.modulelectro.ru



GAMMADELTAGROUP

air

design THOMAS BALLARINI



MODUL
ELECTRO
www.modulelectro.ru

6140
D20 H60
1X20W G4



MODUL
ELECTRO
www.modulelectro.ru

6130
D20 H185
1X20W G4

6131
D30 H185
2X20W G4

MODUL
ELECTRO
www.modulelectro.ru



6130
D20 H185
1X20W G4



6140
D20 H60
1X20W G4





MODUL
ELECTRO

www.modulelectro.ru

air



MODUL
ELECTRO
www.modulelectro.ru

air





MODUL
ELECTRO
www.modulelectro.ru

6111

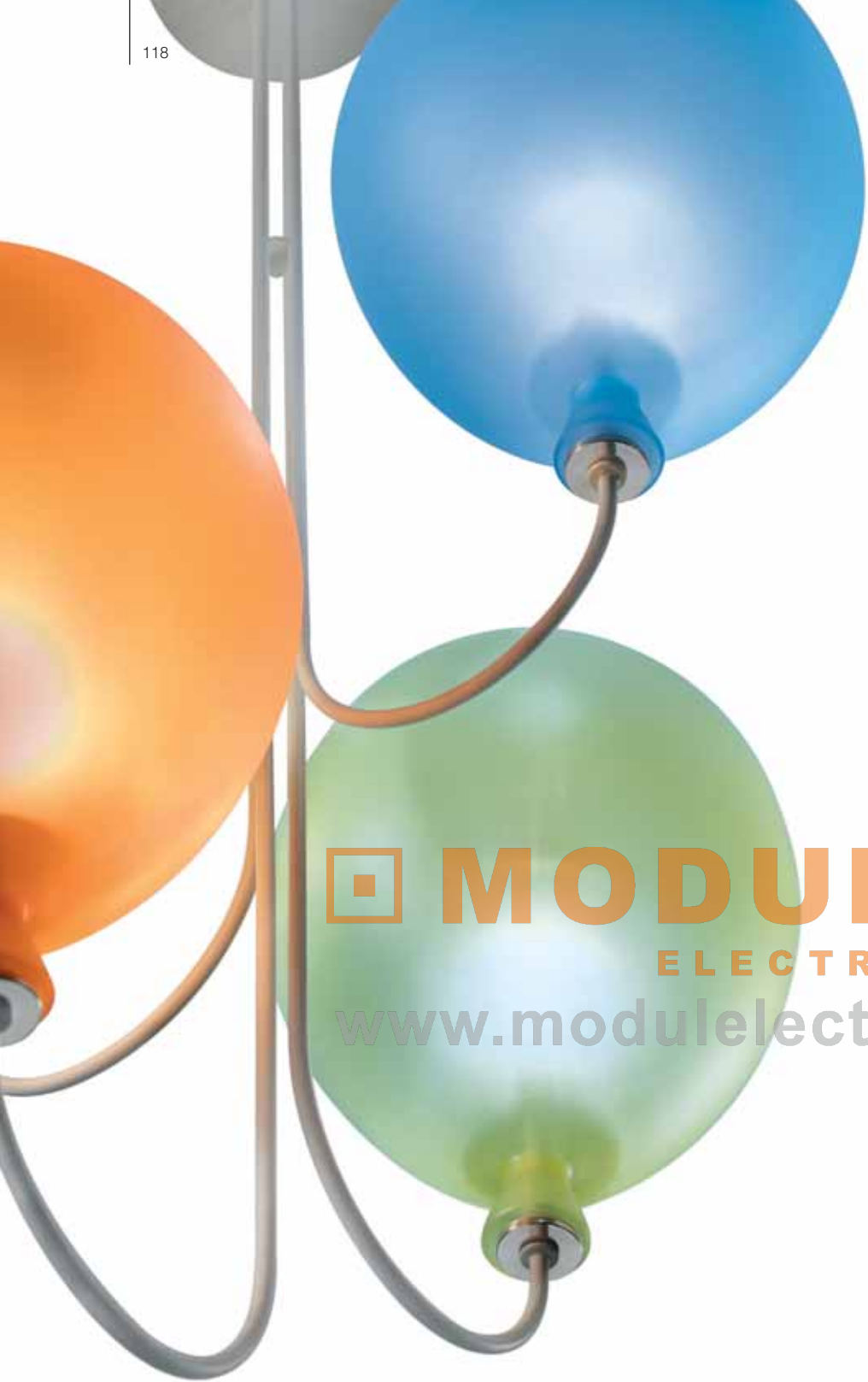
D20 H50-150
1X60W G9



 **MODUL** 
ELECTRO
www.modulelectro.ru

air



MODUL
ELECTRO

www.modulelectro.ru

6101
L20 P22 H30
1X20W G4

6120
D50 H85
4X20W G4











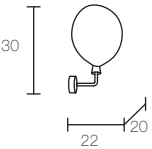

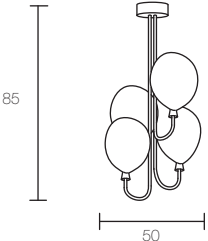

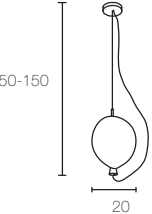
MODUL
ELECTRO
www.modulelectro.ru

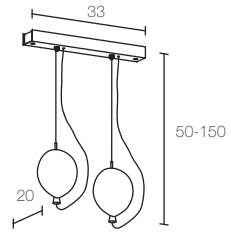
air

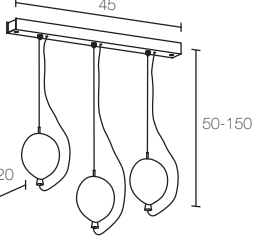
MODUL
ELECTRO
www.modulelectro.ru

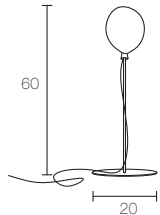
6113
L45 P20 H50-150
3X60W G9

<p>AIR - 6101</p> 	 <p>1X20W G4</p>	<p>Applique Struttura: laccato bianco o nero. Diffusore: cristallo pirex satinato nei colori arancio, verde, blu, giallo e bianco.</p> <p>Wall lamp Structure: enamelled white or black. Diffuser: satin-finished pyrex crystal available in the following colours orange, green, blue, yellow and white.</p> <p>⚡ ⚡ CE</p>
<p>AIR - 6120</p> 	 <p>4X20W G4</p>	<p>Plafoniera Struttura: laccato bianco o nero. Diffusore: cristallo pirex satinato nei colori arancio, verde, blu, giallo e bianco.</p> <p>Wall lamp Structure: enamelled white or black. Diffuser: satin-finished pyrex crystal available in the following colours orange, green, blue, yellow and white.</p> <p>⚡ ⚡ CE</p>
<p>AIR - 6111</p> 	 <p>1X60W G9</p>	<p>Sospensione Struttura: laccato bianco o nero. Diffusore: cristallo pirex satinato nei colori arancio, verde, blu, giallo e bianco.</p> <p>Hanging lamp Structure: enamelled white or black. Diffuser: satin-finished pyrex crystal available in the following colours orange, green, blue, yellow and white.</p> <p>⚡ ⚡ CE</p>
<p>AIR - 6112</p> 	 <p>2X60W G9</p>	<p>Sospensione Struttura: laccato bianco o nero - particolari cromo lucido. Diffusore: cristallo pirex satinato nei colori arancio, verde, blu, giallo e bianco.</p> <p>Hanging lamp Structure: enamelled white or black - polished chrome details. Diffuser: satin-finished pyrex crystal available in the following colours orange, green, blue, yellow and white.</p> <p>⚡ ⚡ CE</p>
<p>AIR - 6113</p> 	 <p>3X60W G9</p>	<p>Sospensione Struttura: laccato bianco o nero - particolari cromo lucido. Diffusore: cristallo pirex satinato nei colori arancio, verde, blu, giallo e bianco.</p> <p>Hanging lamp Structure: enamelled white or black - polished chrome details. Diffuser: satin-finished pyrex crystal available in the following colours orange, green, blue, yellow and white.</p> <p>⚡ ⚡ CE</p>
<p>AIR - 6140</p> 	 <p>1X20W G4</p>	<p>Lampada tavolo Struttura: laccato nero. Diffusore: cristallo pirex satinato nei colori arancio, verde, blu, giallo e bianco.</p> <p>Table lamp Structure: enamelled black. Diffuser: satin-finished pyrex crystal available in the following colours orange, green, blue, yellow and white.</p> <p>⚡ ⚡ CE</p>

AIR - 6130

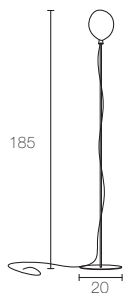

1X20W G4

Lampada terra

Struttura: laccato nero.

Diffusore: cristallo pirex satinato nei colori arancio, verde, blu, giallo e bianco.

Floor lamp

Structure: enamelled black.

Diffuser: satin-finished pyrex crystal available in the following colours orange, green, blue, yellow and white.



AIR - 6131

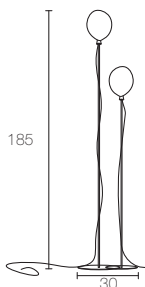

2X20W G4

Lampada terra

Struttura: laccato nero.



Diffusore: cristallo pirex satinato nei colori arancio, verde, blu, giallo e bianco.

Floor lamp

Structure: enamelled black.

Diffuser: satin-finished pyrex crystal available in the following colours orange, green, blue, yellow and white.



 **MODULO** 
ELECTRO
www.modulelectro.ru

 **MODUL** 
ELECTRO

www.modulelectro.ru

helix

design SANDI RENKO

5501
L14 P8 H40
1X8W G5





MODUL
ELECTRO
www.modulelectro.ru

5511
L150 P31 H30-150
2X80W 2G11

MODUL
ELECTRO
www.modulelectro.ru

helix



MODULO
ELECTRO

www.modulelectro.ru

5521
L150 P31 H15
2X80W 2G11

MODUL
ELECTRO

www.modulelectro.ru

5511

L150 P31 H30-150
2X80W 2G11













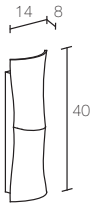

MODUL
ELECTRO
www.modulelectro.ru

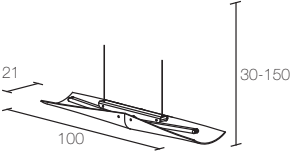
helix

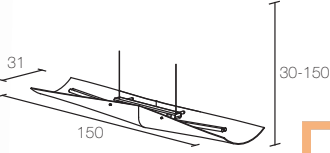

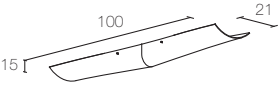
helix

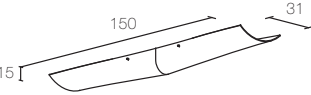

 **MODUL** 
ELECTRO
www.modulelectro.ru

<p>HELIX - 5501</p> 	 1X8W G5	<p>Applique Struttura: laccato bianco. Diffusore: cristallo satinato bianco.</p> <p>Wall lamp Structure: enamelled white. Diffuser: crystal satined white.</p> 
<p>HELIX - 5510</p> 	 2X36W 2G11	<p>Sospensione Struttura: laccato bianco. Diffusore: cristallo satinato bianco.</p> <p>Hanging lamp Structure: enamelled white. Diffuser: crystal satined white.</p> 
<p>HELIX - 5511</p> 	 2X80W 2G11	<p>Sospensione Struttura: laccato bianco. Diffusore: cristallo satinato bianco.</p> <p>Hanging lamp Structure: enamelled white. Diffuser: crystal satined white.</p> 
<p>HELIX - 5520</p> 	 2X36W 2G11	<p>Plafoniera Struttura: laccato bianco. Diffusore: cristallo satinato bianco.</p> <p>Ceiling lamp Structure: enamelled white. Diffuser: crystal satined white.</p> 
<p>HELIX - 5521</p> 	 2X80W 2G11	<p>Plafoniera Struttura: laccato bianco. Diffusore: cristallo satinato bianco.</p> <p>Ceiling lamp Structure: enamelled white. Diffuser: crystal satined white.</p> 

MODULO
ELECTRO
www.modulelectro.ru

 **MODUL** 
ELECTRO
www.modulelectro.ru



5551
L180 P10 H185
1X49W G5

 **MODUL** 
ELECTRO

www.modulelectro.ru

speed





MODUL
ELECTRO
www.modulelectro.ru

SPEED - 5551

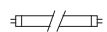

1X49W G5



Applique

Struttura: laccato bianco - particolare cromo lucido
Diffusore: cristallo satinato bianco.

Wall lamp

Structure: enamelled white - details polished chrome.
Diffuser: crystal satined white.



 **MODULO** 
ELECTRO
www.modulelectro.ru

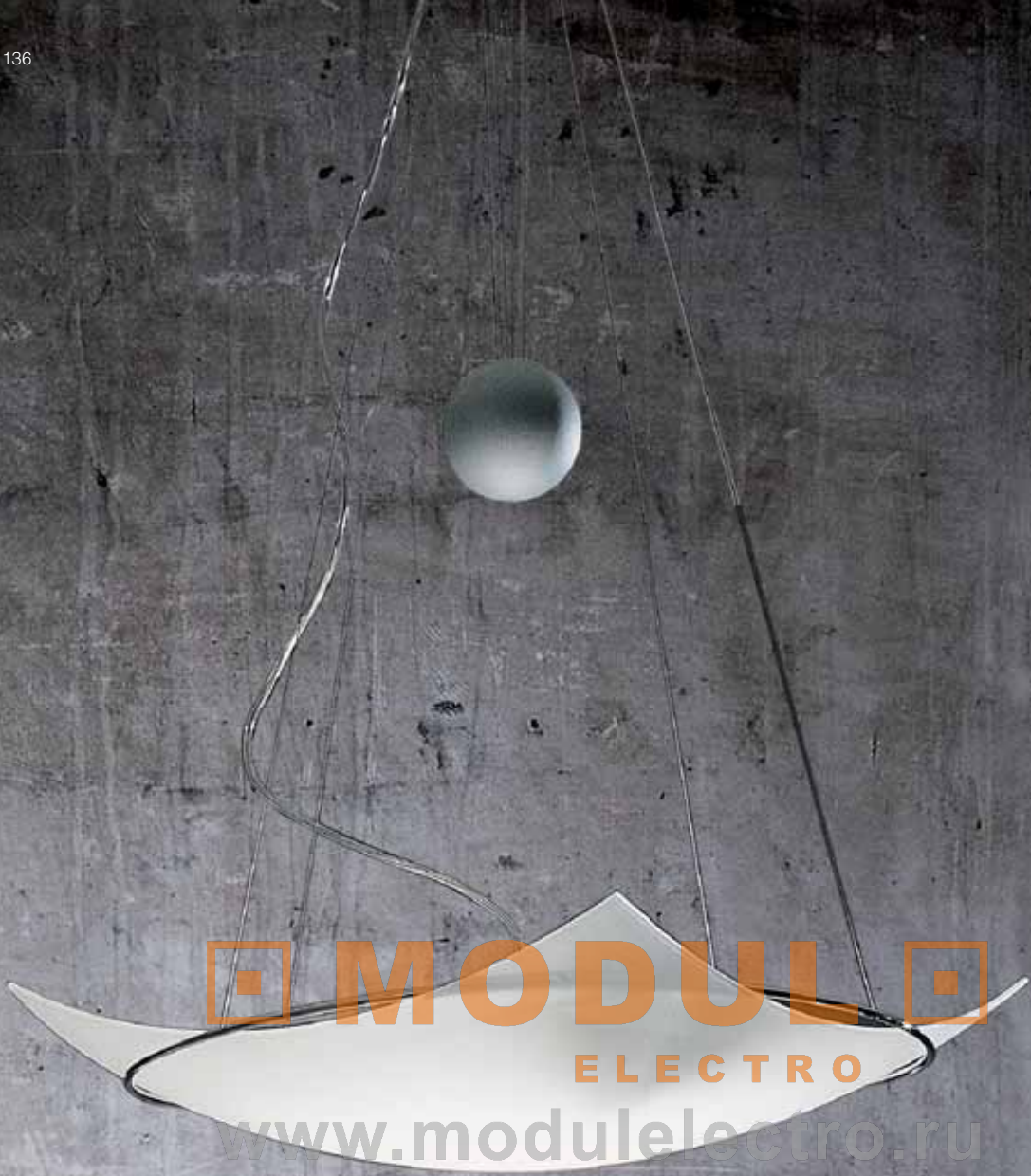

MODUL
ELECTRO
www.modulelectro.ru

tenso

design ORIANO FAVARETTO

 **MODUL** 
ELECTRO

www.modulelectro.ru





 **MODUL** 
ELECTRO

www.modulelectro.ru

4804

L35 P35 H15
1X100W R7s

4805

L43 P43 H15
1X150W R7s

4806

L52 P52 H16
1X200W R7s

MODUL
ELECTRO
www.modulelectro.ru











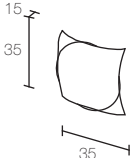
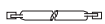



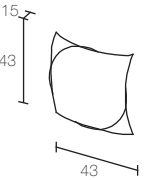
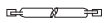



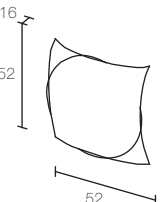
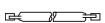

tenso

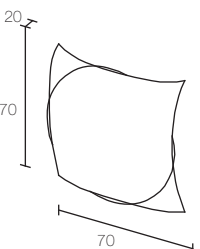
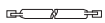
4841
L47 P23 H11
1X150W R7s

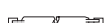

MODUL
ELECTRO
www.modulelectro.ru

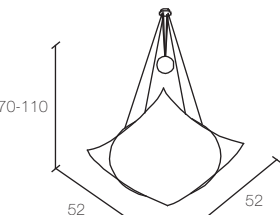
4806
L52 P52 H16
1X200W R7s

<p>TENSO - 4804 - *4804-C E27</p> 	 1X100W R7s  *1X75W E27  *1X24W E27	<p>Applique/Plafoniera Struttura: laccato alluminio opaco - cromo lucido. Diffusore: cristallo bianco sabbato o colore ambrato sabbato.</p> <p>Wall lamp/Ceiling lamp Structure: matt enamelled aluminium - polished chrome. Diffuser: sandblasted white or sandblasted amber crystal.</p> 
<p>TENSO - 4805 - *4805-C E27</p> 	 1X100W R7s  *2X75W E27  *2X24W E27	<p>Applique/Plafoniera Struttura: laccato alluminio opaco - cromo lucido. Diffusore: cristallo bianco sabbato o colore ambrato sabbato.</p> <p>Wall lamp/Ceiling lamp Structure: matt enamelled aluminium - polished chrome. Diffuser: sandblasted white or sandblasted amber crystal.</p> 
<p>TENSO - 4806 - *4806-C E27</p> 	 1X200W R7s  *2X75W E27  *2X24W E27	<p>Applique/Plafoniera Struttura: laccato alluminio opaco - cromo lucido. Diffusore: cristallo bianco sabbato o colore ambrato sabbato.</p> <p>Wall lamp/Ceiling lamp Structure: matt enamelled aluminium - polished chrome. Diffuser: sandblasted white or sandblasted amber crystal.</p> 
<p>TENSO - 4814 - *4814-C E27</p> 	 1X300W R7s  *3X75W E27  *3X24W E27	<p>Applique/Plafoniera Struttura: laccato alluminio opaco - cromo lucido. Diffusore: cristallo bianco sabbato o colore ambrato sabbato.</p> <p>Wall lamp/Ceiling lamp Structure: matt enamelled aluminium - polished chrome. Diffuser: sandblasted white or sandblasted amber crystal.</p> 
<p>TENSO - 4841</p> 	 1X150W R7s	<p>Applique Struttura: laccato alluminio opaco - cromo lucido. Diffusore: cristallo bianco sabbato o colore ambrato sabbato.</p> <p>Wall lamp Structure: matt enamelled aluminium - polished chrome. Diffuser: sandblasted white or sandblasted amber crystal.</p> 
<p>TENSO - 4842</p> 	 1X200W R7s	<p>Saliscendi Struttura: laccato alluminio opaco - cromo lucido. Diffusore: cristallo bianco sabbato o colore ambrato sabbato.</p> <p>Up & Down lamp Structure: matt enamelled aluminium - polished chrome. Diffuser: sandblasted white or sandblasted amber crystal.</p> 



MODULO
ELECTRO
www.moduloelectro.ru



MODUL
ELECTRO
www.modulelectro.ru

tensosystem

design ORIANO FAVARETTO

 **MODUL** 
ELECTRO
www.modulelectro.ru

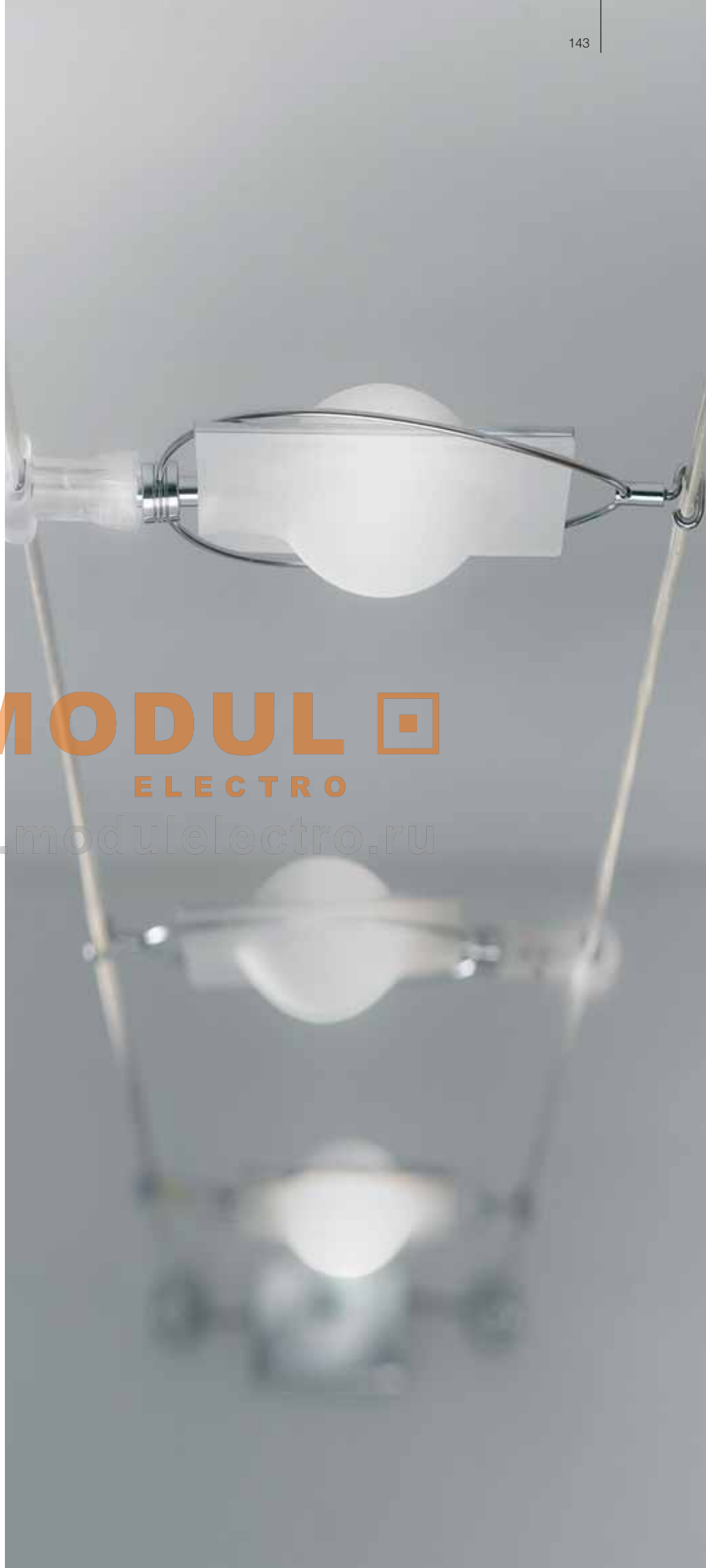

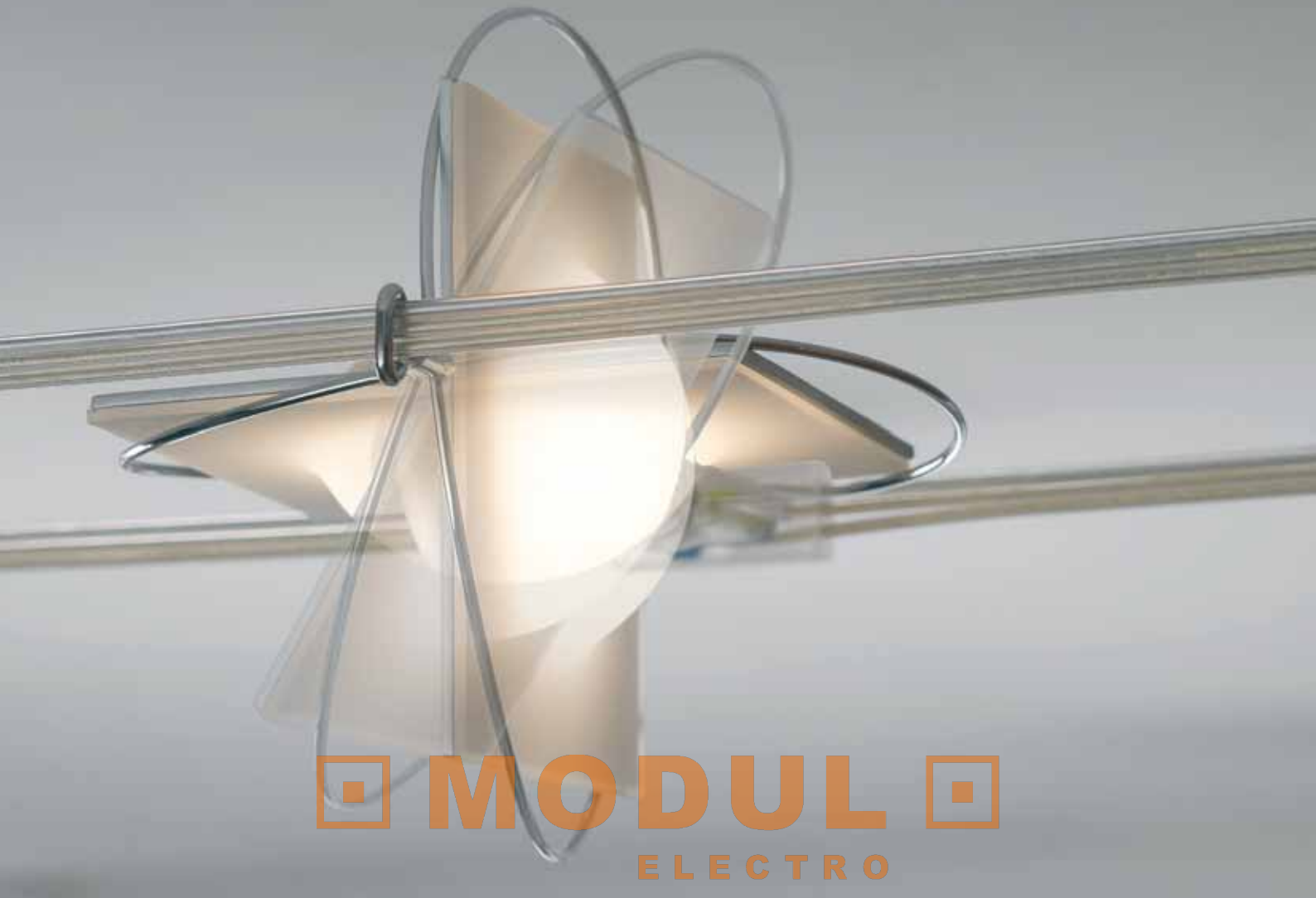

MODUL
ELECTRO

www.modulelectro.ru

tensoystem

TENSOSYSTEM - 2264

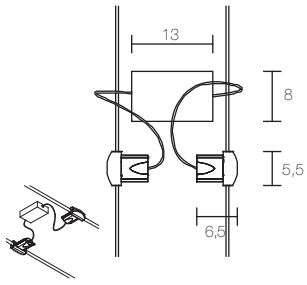

Alimentazione centrale.

Central feed.

TENSOSYSTEM - 2265

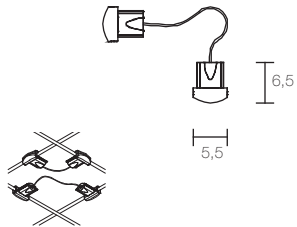

Connettore incrociato.

Crossed connector.

TENSOSYSTEM - 2266

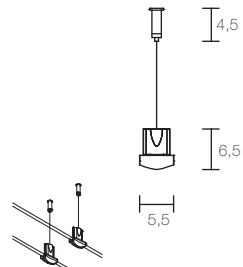

Sostegno per campate superiori a mt.10

Load bearing fitting for cable spans over 10 mt in length

TENSOSYSTEM - 2267

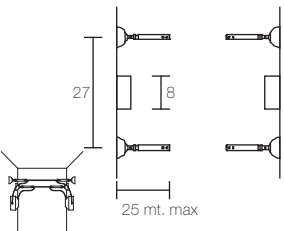

Kit di fissaggio parete-parete con scatola di alimentazione

Wall-to-wall fastening kit with on-off box

TENSOSYSTEM - 2263



Cavo di sostegno e alimentazione
2 conduttori + 1 sostegno.

Load bearing and power cable
2 wires + 1 support.

CE

TENSOSYSTEM - 2261

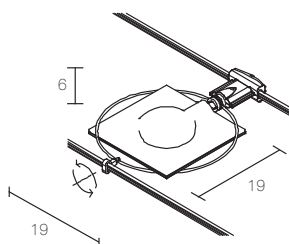

1X75W G9

Apparecchio orientabile
Struttura: cromo lucido.
Diffusore: pirex sabbato.

Adjustable fixture
Structure: polished chrome.
Diffuser: sandblasted pyrex.



 

MODULO
ELECTRO
www.modulelectro.ru

MODUL
ELECTRO
www.modulelectro.ru

1764
L50 P9 H50
1X150W R7s

1766
L50 P50 H60-140
1X200W R7s

 **MODUL** 
ELECTRO
www.modulelectro.ru



ring

MODUL
ELECTRO
www.modulelectro.ru

1762
L30 P9 H30
1X100W R7s

1763
L30 P9 H30
1X100W R7s

1764
L50 P9 H50
1X150W R7s

 **MODUL** 
ELECTRO
www.modulelectro.ru

ring





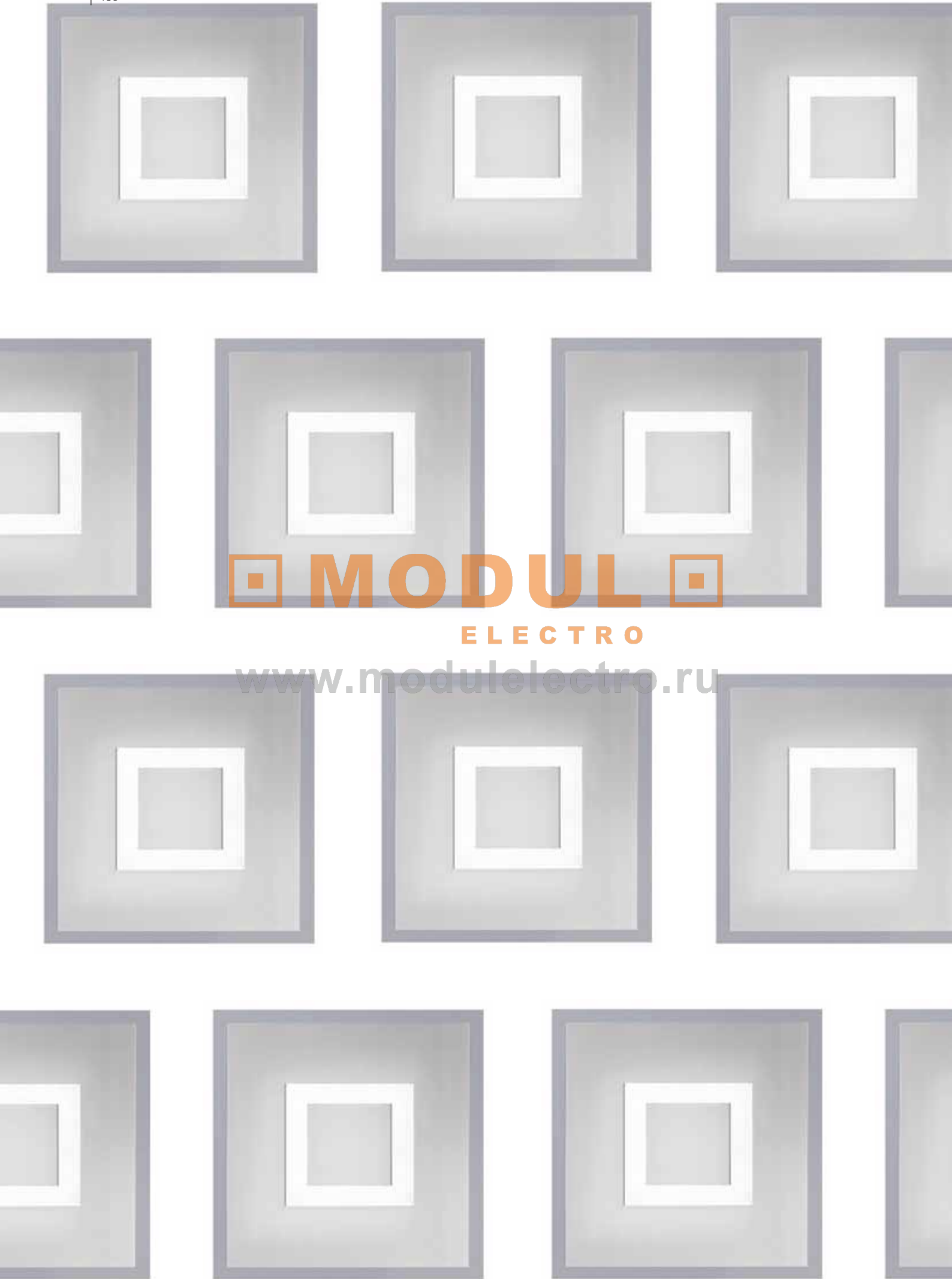





1763
L40 P9 H40
1X100W R7s

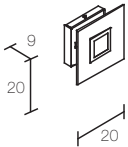
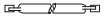
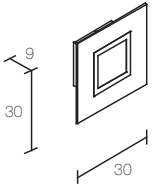
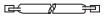

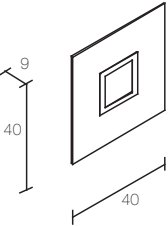
 **MODUL** 

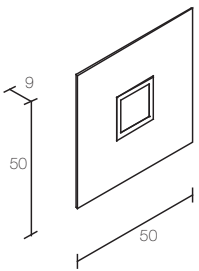
ELECTRO

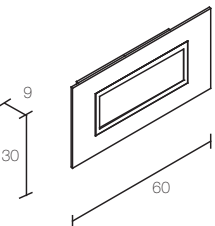
www.modulelectro.ru

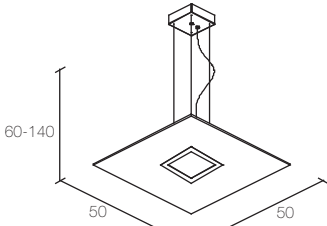
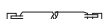
<p>RING - 1761</p> 	 <p>1X60W R7s</p>	<p>Applique/Plafoniera Struttura: laccato alluminio opaco. Diffusore: cristallo satinato bianco.</p> <p>Wall lamp/Ceiling lamp Structure: matt-enamelled aluminium. Diffuser: crystal satined white.</p> <p>⊥ ⚡ CE</p>
<p>RING - 1762 - *1762-B E14</p> 	 <p>1X100W R7s</p>  <p>*1X12W E14</p>	<p>Applique/Plafoniera Struttura: laccato alluminio opaco. Diffusore: cristallo satinato bianco.</p> <p>Wall lamp/Ceiling lamp Structure: matt-enamelled aluminium. Diffuser: crystal satined white.</p> <p>⊥ ⚡ CE</p>
<p>RING - 1763 - *1763-B E14</p> 	 <p>1X100W R7s</p>  <p>*2X12W E14</p>	<p>Applique/Plafoniera Struttura: laccato alluminio opaco. Diffusore: cristallo satinato bianco.</p> <p>Wall lamp/Ceiling lamp Structure: matt-enamelled aluminium. Diffuser: crystal satined white.</p> <p>⊥ ⚡ CE</p>
<p>RING - 1764 - *1763-B E14</p> 	 <p>1X150W R7s</p>  <p>*2X12W E14</p>	<p>Applique/Plafoniera Struttura: laccato alluminio opaco. Diffusore: cristallo satinato bianco.</p> <p>Wall lamp/Ceiling lamp Structure: matt-enamelled aluminium. Diffuser: crystal satined white.</p> <p>⊥ ⚡ CE</p>
<p>RING - 1765</p> 	 <p>2X100W R7s</p>	<p>Applique/Plafoniera Struttura: laccato alluminio opaco. Diffusore: cristallo satinato bianco.</p> <p>Wall lamp/Ceiling lamp Structure: matt-enamelled aluminium. Diffuser: crystal satined white.</p> <p>⊥ ⚡ CE</p>
<p>RING - 1766</p> 	 <p>1X200W R7s</p>	<p>Sospensione Struttura: laccato alluminio opaco. Diffusore: cristallo satinato bianco.</p> <p>Hanging lamp Structure: matt-enamelled aluminium. Diffuser: crystal satined white.</p> <p>⊥ ⚡ CE</p>

MODULO
ELECTRO
www.moduloelectro.ru

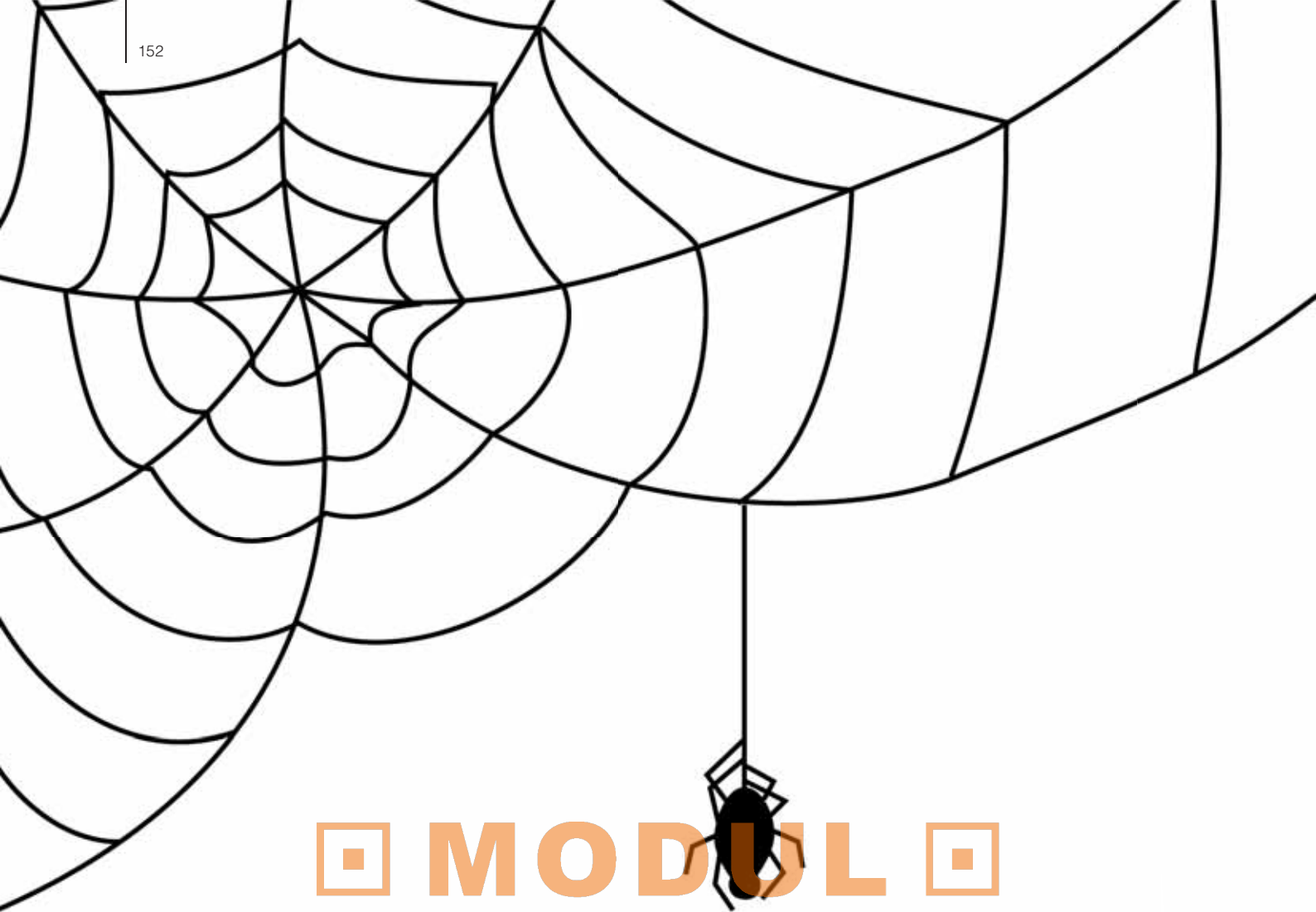



ELECTRO

www.modulelectro.ru

net



 **MODUL** 
ELECTRO
www.modulelectro.ru



MODULO
ELECTRO

www.modulelectro.ru

1821
L40 P10 H40
4X40W E14

1822
L52 P10 H52
4X60W E14

net





 **MODULO** 
ELECTRO

www.modulelectro.ru



2020
L30 P10 H30
2X60W E14



 **MODUL** 
ELECTRO
www.modulelectro.ru

1827
L52 P10 H52
4X60W E14

1826
L40 P10 H40
4X40W E14

net



MODULO
ELECTRO

www.modulelectro.ru

2026
L40 P10 H40
4X60W E14

2027
L52 P10 H52
4X60W E14



 **MODUL** 
ELECTRO

www.modulelectro.ru

1827
L52 P10 H52
4X60W E14











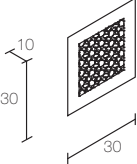

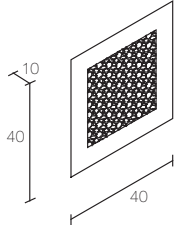

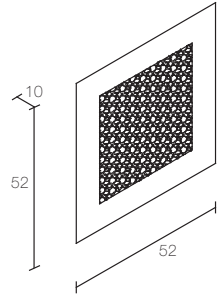

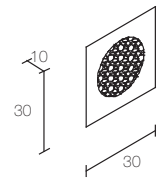

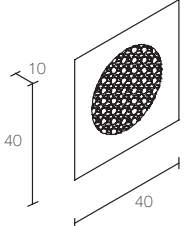

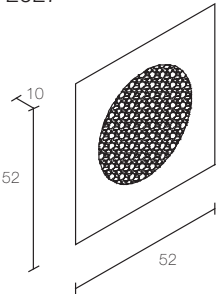



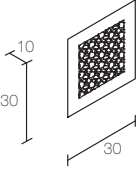

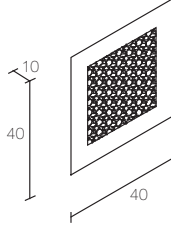
2022
L52 P10 H52
4X60W E14

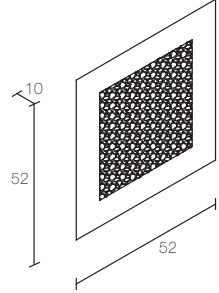
 **MODULO** 
ELECTRO

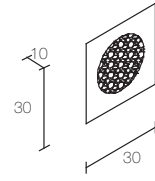
www.modulelectro.ru

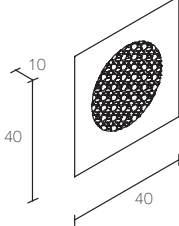
net

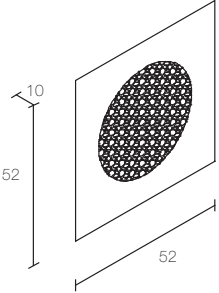
<p>NET - 2020</p> 	 2X60W E14  2X12W E14	<p>Applique/Plafoniera Struttura: acciaio inox satinato -laccato alluminio opaco Diffusore: cristallo trasparente.</p> <p>Wall lamp/Celing lamp Structure: satined stainless steel - matt-enamelled aluminium. Diffuser: crystal transparent.</p> <p>± ⚡ CE</p>
<p>NET - 2021</p> 	 4X40W E14  4X12W E14	<p>Applique/Plafoniera Struttura: acciaio inox satinato -laccato alluminio opaco Diffusore: cristallo trasparente.</p> <p>Wall lamp/Celing lamp Structure: satined stainless steel - matt-enamelled aluminium. Diffuser: crystal transparent.</p> <p>± ⚡ CE</p>
<p>NET - 2022</p> 	 4X60W E14  4X12W E14	<p>Applique/Plafoniera Struttura: acciaio inox satinato -laccato alluminio opaco Diffusore: cristallo trasparente.</p> <p>Wall lamp/Celing lamp Structure: satined stainless steel - matt-enamelled aluminium. Diffuser: crystal transparent.</p> <p>± ⚡ CE</p>
<p>NET - 2025</p> 	 2X60W E14  2X12W E14	<p style="text-align: center;">ELECTRO</p> <p>Applique/Plafoniera Struttura: acciaio inox satinato -laccato alluminio opaco Diffusore: cristallo trasparente.</p> <p>Wall lamp/Celing lamp Structure: satined stainless steel - matt-enamelled aluminium. Diffuser: crystal transparent.</p> <p>± ⚡ CE</p>
<p>NET - 2026</p> 	 4X40W E14  4X12W E14	<p>Applique/Plafoniera Struttura: acciaio inox satinato -laccato alluminio opaco Diffusore: cristallo trasparente.</p> <p>Wall lamp/Celing lamp Structure: satined stainless steel - matt-enamelled aluminium. Diffuser: crystal transparent.</p> <p>± ⚡ CE</p>
<p>NET - 2027</p> 	 4X60W E14  4X12W E14	<p>Applique/Plafoniera Struttura: acciaio inox satinato -laccato alluminio opaco Diffusore: cristallo trasparente.</p> <p>Wall lamp/Celing lamp Structure: satined stainless steel - matt-enamelled aluminium. Diffuser: crystal transparent.</p> <p>± ⚡ CE</p>

<p>NET - 1820</p> 	 2X60W E14  2X12W E14	<p>Applique/Plafoniera Struttura: foglia oro o foglia argento - base laccato bianco. Diffusore: cristallo trasparente.</p> <p>Wall lamp/Celing lamp Structure: gold or silver leaf - base enamelled white. Diffuser: crystal transparent.</p> <p>⚡ ⚡ CE</p>
<p>NET - 1821</p> 	 4X40W E14  4X12W E14	<p>Applique/Plafoniera Struttura: foglia oro o foglia argento - base laccato bianco. Diffusore: cristallo trasparente.</p> <p>Wall lamp/Celing lamp Structure: gold or silver leaf - base enamelled white. Diffuser: crystal transparent.</p> <p>⚡ ⚡ CE</p>
<p>NET - 1822</p> 	 4X60W E14  4X12W E14	<p>Applique/Plafoniera Struttura: foglia oro o foglia argento - base laccato bianco. Diffusore: cristallo trasparente.</p> <p>Wall lamp/Celing lamp Structure: gold or silver leaf - base enamelled white. Diffuser: crystal transparent.</p> <p>⚡ ⚡ CE</p>
<p>NET - 1825</p> 	 2X60W E14  2X12W E14	<p>Applique/Plafoniera Struttura: foglia oro o foglia argento - base laccato bianco. Diffusore: cristallo trasparente.</p> <p>Wall lamp/Celing lamp Structure: gold or silver leaf - base enamelled white. Diffuser: crystal transparent.</p> <p>⚡ ⚡ CE</p>
<p>NET - 1826</p> 	 4X40W E14  4X12W E14	<p>Applique/Plafoniera Struttura: foglia oro o foglia argento - base laccato bianco. Diffusore: cristallo trasparente.</p> <p>Wall lamp/Celing lamp Structure: gold or silver leaf - base enamelled white. Diffuser: crystal transparent.</p> <p>⚡ ⚡ CE</p>
<p>NET - 1827</p> 	 4X60W E14  4X12W E14	<p>Applique/Plafoniera Struttura: foglia oro o foglia argento - base laccato bianco. Diffusore: cristallo trasparente.</p> <p>Wall lamp/Celing lamp Structure: gold or silver leaf - base enamelled white. Diffuser: crystal transparent.</p> <p>⚡ ⚡ CE</p>

MODULO
ELECTRO
www.moduloelectro.ru

MODUL
ELECTRO
www.modulelectro.ru

honey



6040
L30 P9 H30
1X60W R7s

6041
L40 P9 H40
1X100W R7s

6042
L50 P9 H50
1X150W R7s

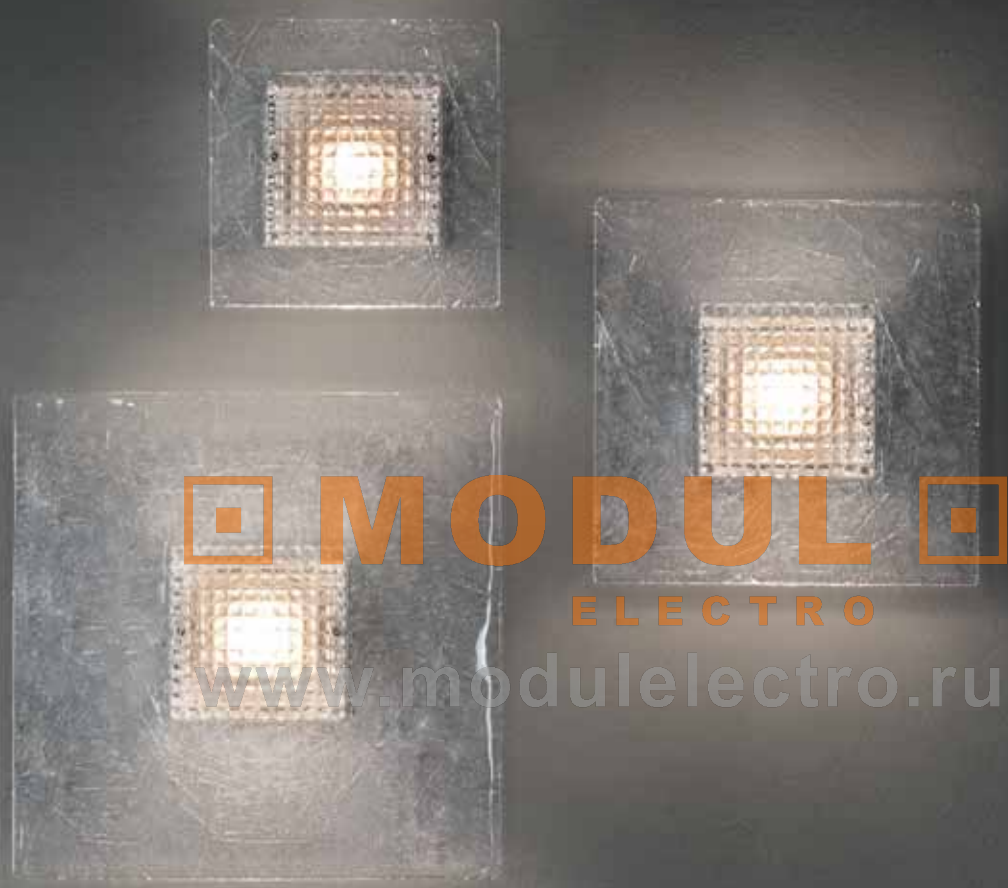

MODUL
ELECTRO

www.modulelectro.ru



6042
L50 P9 H50
1X150W R7s



 **MODUL** 
ELECTRO

www.modulelectro.ru





MODUL
ELECTRO
www.modulelectro.ru

honey

MODUL
ELECTRO
www.modulelectro.ru



honey

6045
L30 P9 H30
1X60W R7s

6046
L40 P9 H40
1X100W R7s



MODUL
ELECTRO











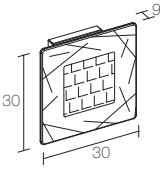
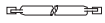

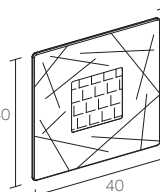
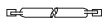
www.modulelectro.ru

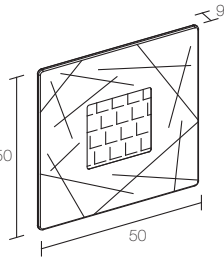
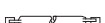
6047

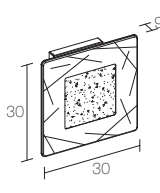
L50 P9 H50
1X150W R7s

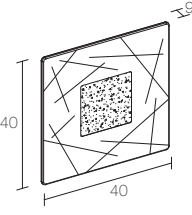

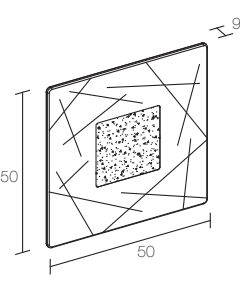
MODUL
ELECTRO
www.modulelectro.ru

<p>HONEY - 6040 - *6040-B GR8</p> 	 <p>1X60W R7s</p>  <p>*1X16W 2pin</p>	<p>Applique/Plafoniera Struttura: verniciato bianco. Diffusore: cristallo trasparente.</p> <p>Wall lamp/Ceiling lamp Structure: white enamelled. Diffuser: crystal transparent.</p> <p>⚡ ⚡ CE</p>
<p>HONEY - 6041 - *6041-B GR8</p> 	 <p>1X100W R7s</p>  <p>*1X16W 2pin</p>	<p>Applique/Plafoniera Struttura: verniciato bianco. Diffusore: cristallo trasparente.</p> <p>Wall lamp/Ceiling lamp Structure: white enamelled. Diffuser: crystal transparent.</p> <p>⚡ ⚡ CE</p>
<p>HONEY - 6042 - *6042-B GR8</p> 	 <p>1X150W R7s</p>  <p>*1X28W 2pin</p>	<p>Applique/Plafoniera Struttura: verniciato bianco. Diffusore: cristallo trasparente.</p> <p>Wall lamp/Ceiling lamp Structure: white enamelled. Diffuser: crystal transparent.</p> <p>⚡ ⚡ CE</p>
<p>HONEY - 6045 - *6045-B GR8</p> 	 <p>1X60W R7s</p>  <p>*1X16W 2pin</p>	<p>Applique/Plafoniera Struttura: verniciato bianco. Diffusore: cristallo trasparente e cristallo trasparente con ambra.</p> <p>Wall lamp/Ceiling lamp Structure: white enamelled. Diffuser: crystal transparent and crystal transparent whit amber glass</p> <p>⚡ ⚡ CE</p>
<p>HONEY - 6046 - *6046-B GR8</p> 	 <p>1X100W R7s</p>  <p>*1X16W 2pin</p>	<p>Applique/Plafoniera Struttura: verniciato bianco. Diffusore: cristallo trasparente e cristallo trasparente con ambra.</p> <p>Wall lamp/Ceiling lamp Structure: white enamelled. Diffuser: crystal transparent and crystal transparent whit amber glass</p> <p>⚡ ⚡ CE</p>
<p>HONEY - 6047 - *6047-B GR8</p> 	 <p>1X150W R7s</p>  <p>*1X28W 2pin</p>	<p>Applique/Plafoniera Struttura: verniciato bianco. Diffusore: cristallo trasparente e cristallo trasparente con ambra.</p> <p>Wall lamp/Ceiling lamp Structure: white enamelled. Diffuser: crystal transparent and crystal transparent whit amber glass</p> <p>⚡ ⚡ CE</p>

MODULO

ELECTRO

www.modulselectro.ru

MODUL
ELECTRO
www.modulelectro.ru

6470
D44 H10
1X200W R7s



round

 **MODUL** 
ELECTRO

www.modulelectro.ru

ROUND - 6470

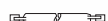
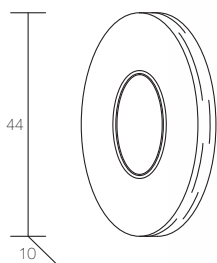

1X200W R7s

Applique/Plafoniera
Struttura: cromo lucido.
Diffusore: cristallo satinato bianco.



Ceiling/Wall lamp
Structure: polished chrome.
Diffuser: crystal satined white.

MODULO
ELECTRO
www.modulelectro.ru



motion
design SANDI RENKO



 **MODUL** 
ELECTRO
www.modulelectro.ru







 **MODUL** 
ELECTRO
www.modulelectro.ru

1463
L37 P8 H30-150
3X50W GU10



1451
L12 P8 H15
1X50W GU10



 **MODUL** 
ELECTRO
www.modulelectro.ru

motion



MODUL
ELECTRO
www.modulelectro.ru

1461
L12 P8 H30-150
1X50W GU10











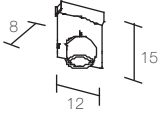

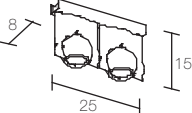

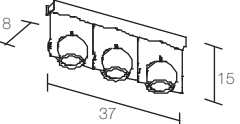
1452
L25 P8 H15
2X50W GU10

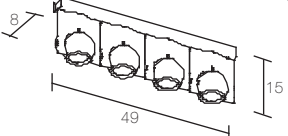

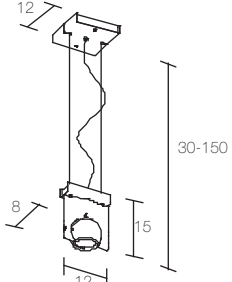
1462
L25 P8 H30-150
2X50W GU10

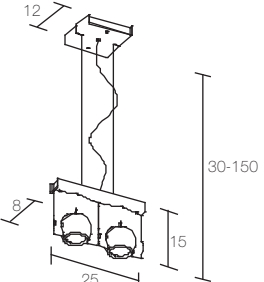
motion

<p>MOTION - 1451</p> 	 1X50W GU10  1X3W LED GU10	<p>Applique/Plafoniera Struttura: cromo lucido - policarbonato trasparente.</p> <p>Wall lamp/Ceiling lamp Structure: polished chrome - polycarbonate transparent.</p> <p>± ⚡ CE</p>
<p>MOTION - 1452</p> 	 2X50W GU10  2X3W LED GU10	<p>Applique/Plafoniera Struttura: cromo lucido - policarbonato trasparente.</p> <p>Wall lamp/Ceiling lamp Structure: polished chrome - polycarbonate transparent.</p> <p>± ⚡ CE</p>
<p>MOTION - 1453</p> 	 3X50W GU10  3X3W LED GU10	<p>Applique/Plafoniera Struttura: cromo lucido - policarbonato trasparente.</p> <p>Wall lamp/Ceiling lamp Structure: polished chrome - polycarbonate transparent.</p> <p>± ⚡ CE</p>
<p>MOTION - 1454</p> 	 4X50W GU10  4X3W LED GU10	<p>Applique/Plafoniera Struttura: cromo lucido - policarbonato trasparente.</p> <p>Wall lamp/Ceiling lamp Structure: polished chrome - polycarbonate transparent.</p> <p>± ⚡ CE</p>
<p>MOTION - 1461</p> 	 1X50W GU10  1X3W LED GU10	<p>Sospensione Struttura: cromo lucido - policarbonato trasparente.</p> <p>Hanging lamp Structure: polished chrome - polycarbonate transparent.</p> <p>± ⚡ CE</p>
<p>MOTION - 1462</p> 	 2X50W GU10  2X3W LED GU10	<p>Sospensione Struttura: cromo lucido - policarbonato trasparente.</p> <p>Hanging lamp Structure: polished chrome - polycarbonate transparent.</p> <p>± ⚡ CE</p>

MODULO
ELECTRO
www.modulelectro.ru

MOTION - 1463

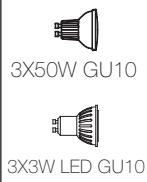
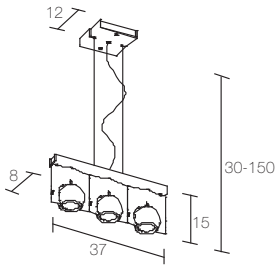

Sospensione
Struttura: cromo lucido - policarbonato trasparente.

Hanging lamp
Structure: polished chrome - polycarbonate transparent.



MOTION - 1464

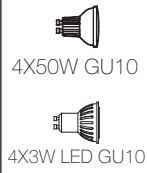
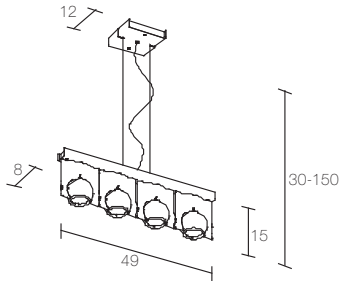

Sospensione
Struttura: cromo lucido - policarbonato trasparente.

Hanging lamp
Structure: polished chrome - polycarbonate transparent.

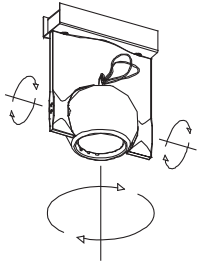

Nella collezione MOTION non si è voluto rinunciare alla maggiore efficienza della luce alogena evitando, con i nuovi spots GU10 a 220 volts l'utilizzo della bassissima tensione (12 volts). I vantaggi di tale soluzione sono principalmente: corrente a basso numero di amperes, quindi un minore stress dei componenti elettrici e ingombri più contenuti, venendo a mancare il trasformatore di corrente.

The MOTION collection has chosen not to renounce the greater efficiency of halogen light, and the use of the new 220-volt GU10 spots has given the opportunity of avoiding the use of very low voltage (12 volts). The main advantage provided by this solution is low-amperage power supply and, consequently, lower voltage of the electrical components and smaller overall dimensions, since the current transformer is no longer necessary.

MODULE

ELECTRO

www.modulelectro.ru

MODUL
ELECTRO
www.modulelectro.ru

stilo



MODUL
ELECTRO

www.modulelectro.ru





MODUL
ELECTRO
www.modulelectro.ru



MODULO
ELECTRO
www.modulelectro.ru

8376
D60 H60-140
6X100W E14

stilo

MODUL
ELECTRO
www.modulelectro.ru

8370
D9 H60-140
1X100W E14



8371
D9 H60-140
1X100W E14



8370
D9 H60-140
1X100W E14

MODULO
ELECTRO
www.modulelectro.ru

stilo



MODUL
ELECTRO
www.modulselectro.ru











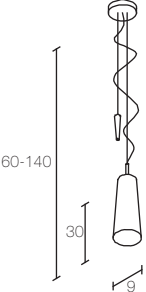



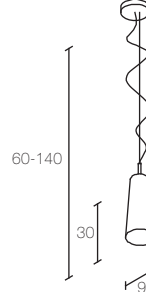



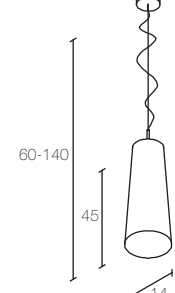



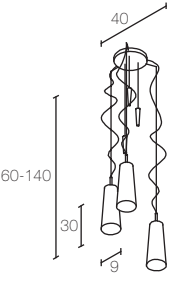

8376
D60 H60-140
6X100W E14

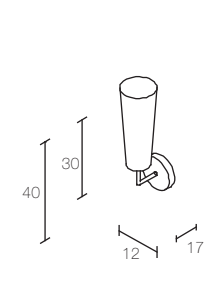

MODULO
ELECTRO
www.modulelectro.ru

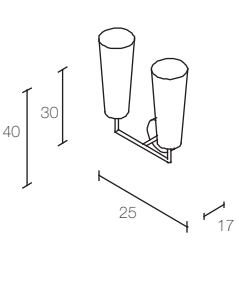
8374
L13 P17 H40
1X100W E14

stilo

<p>STILO - 8370</p> 	 1X100W E14  1X12W E14  1X40W E14*	<p>Saliscendi Struttura: cromo lucido. Diffusore: cristallo pirex satinato nei colori blu, verde, rosso, ambra, giallo, bianco e trasparente. * Con vetro trasparente è consigliata lampada "Spotline" E14.</p> <p>Up & down lamp Structure: polished chrome. Diffuser: satin-finished pyrex crystal available in the following colours: blue, green, red, amber, yellow, white and transparent. * "Spotline" E14 is recommended with the transparent glass.</p> <p>⊕ ⚡ CE</p>
<p>STILO - 8371</p> 	 1X100W E14  1X12W E14  1X40W E14*	<p>Sospensione Struttura: cromo lucido. Diffusore: cristallo pirex satinato nei colori blu, verde, rosso, ambra, giallo, bianco e trasparente. * Con vetro trasparente è consigliata lampada "Spotline" E14.</p> <p>Hanging lamp Structure: polished chrome. Diffuser: satin-finished pyrex crystal available in the following colours: blue, green, red, amber, yellow, white and transparent. * "Spotline" E14 is recommended with the transparent glass.</p> <p>⊕ ⚡ CE</p>
<p>STILO - 8372</p> 	 1X150W E27  1X24W E27  1X100W E27*	<p>Sospensione Struttura: cromo lucido. Diffusore: cristallo pirex satinato nei colori blu, verde, rosso, ambra, giallo, bianco e trasparente. * Con vetro trasparente è consigliata lampada "Spotline" E14.</p> <p>Hanging lamp Structure: polished chrome. Diffuser: satin-finished pyrex crystal available in the following colours: blue, green, red, amber, yellow, white and transparent. * "Spotline" E27 is recommended with the transparent glass.</p> <p>⊕ ⚡ CE</p>
<p>STILO - 8373</p> 	 3X100W E14  3X12W E14  3X40W E14*	<p>Saliscendi Struttura: cromo lucido. Diffusore: cristallo pirex satinato nei colori blu, verde, rosso, ambra, giallo, bianco e trasparente. * Con vetro trasparente è consigliata lampada "Spotline" E14.</p> <p>Up & down lamp Structure: polished chrome. Diffuser: satin-finished pyrex crystal available in the following colours: blue, green, red, amber, yellow, white and transparent.* "Spotline" E14 is recommended with the transparent glass.</p> <p>⊕ ⚡ CE</p>
<p>STILO - 8374</p> 	 1X100W E14  1X12W E14  1X40W E14*	<p>Applique Struttura: cromo lucido. Diffusore: cristallo pirex satinato nei colori blu, verde, rosso, ambra, giallo, bianco e trasparente. * Con vetro trasparente è consigliata lampada "Spotline" E14.</p> <p>Wall lamp Structure: polished chrome. Diffuser: satin-finished pyrex crystal available in the following colours: blue, green, red, amber, yellow, white and transparent. * "Spotline" E14 is recommended with the transparent glass.</p> <p>⊕ ⚡ CE</p>
<p>STILO - 8375</p> 	 2X100W E14  2X12W E14  2X40W E14*	<p>Applique Struttura: cromo lucido. Diffusore: cristallo pirex satinato nei colori blu, verde, rosso, ambra, giallo, bianco e trasparente. * Con vetro trasparente è consigliata lampada "Spotline" E14.</p> <p>Wall lamp Structure: polished chrome. Diffuser: satin-finished pyrex crystal available in the following colours: blue, green, red, amber, yellow, white and transparent. * "Spotline" E14 is recommended with the transparent glass.</p> <p>⊕ ⚡ CE</p>

STILO - 8376

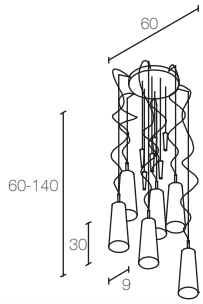

6X100W E14



6X12W E14



1X40W E14*

Saliscendi

Struttura: cromo lucido.

Diffusore: cristallo pirex satinato nei colori blu, verde, rosso, ambra, giallo, bianco e trasparente.

* Con vetro trasparente è consigliata lampada "Spotline" E14.

Up & down lamp

Structure: polished chrome.

Diffuser: satin-finished pyrex crystal available in the following colours: blue, green, red, amber, yellow, white and transparent.

* "Spotline" E14 is recommended with the transparent glass.



STILO - 8381

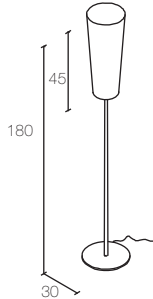

1X150W E27



1X24W E27

Lampada terra

Struttura: cromo lucido.



Diffusore: cristallo pirex satinato nei colori blu, verde, rosso, ambra, giallo, bianco e trasparente.

Floor lamp

Structure: polished chrome.

Diffuser: satin-finished pyrex crystal available in the following colours: blue, green, red, amber, yellow, white and transparent



 **MODULO** 
ELECTRO
www.modulelectro.ru



MODUL
ELECTRO
www.modulectro.ru

2673
D40 H60-140
3X60W E14



 **MODUL** 
ELECTRO
www.modulelectro.ru

cromostio

2681
D32.H180
1X100W E27



MODUL
ELECTRO
www.modulelectro.ru

crommostilo

2676
D60 H60-140
6X60W E14











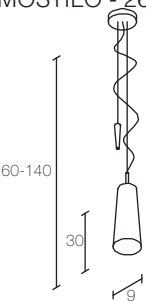

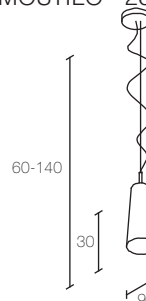
ELECTRO
www.modulelectro.ru

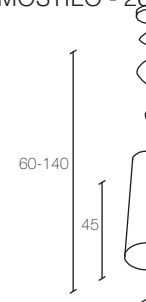

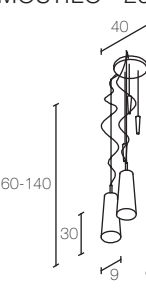
2674
L12 P17 H40
1X60W E14

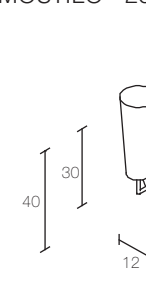

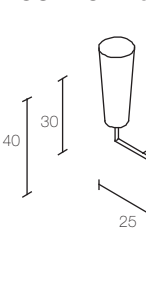
2675
L25 P17 H40
2X60W E14

<p>CROMOSTILO - 2670</p> 	 <p>1X60W E14 1X12W E14</p>	<p>Saliscendi Struttura: cromo lucido. Diffusore: cristallo pirex satinato nei colori blu, verde, rosso, ambra, giallo, bianco e trasparente.</p> <p>Up & down lamp Structure: polished chrome. Diffuser: satin-finished pyrex crystal available in the following colours: blue, green, red, amber, yellow, white and transparent.</p> <p>± ⚡ CE</p>
<p>CROMOSTILO - 2671</p> 	 <p>1X60W E14 1X12W E14</p>	<p>Sospensione Struttura: cromo lucido. Diffusore: cristallo pirex satinato nei colori blu, verde, rosso, ambra, giallo, bianco e trasparente.</p> <p>Hanging lamp Structure: polished chrome. Diffuser: satin-finished pyrex crystal available in the following colours: blue, green, red, amber, yellow, white and transparent.</p> <p>± ⚡ CE</p>
<p>CROMOSTILO - 2672</p> 	 <p>1X100W E27 1X24W E27</p>	<p>Sospensione Struttura: cromo lucido. Diffusore: cristallo pirex satinato nei colori blu, verde, rosso, ambra, giallo, bianco e trasparente.</p> <p>Hanging lamp Structure: polished chrome. Diffuser: satin-finished pyrex crystal available in the following colours: blue, green, red, amber, yellow, white and transparent.</p> <p>± ⚡ CE</p>
<p>CROMOSTILO - 2673</p> 	 <p>3X60W E14 3X12W E14</p>	<p>Saliscendi Struttura: cromo lucido. Diffusore: cristallo pirex satinato nei colori blu, verde, rosso, ambra, giallo, bianco e trasparente.</p> <p>Up & down lamp Structure: polished chrome. Diffuser: satin-finished pyrex crystal available in the following colours: blue, green, red, amber, yellow, white and transparent.*</p> <p>± ⚡ CE</p>
<p>CROMOSTILO - 2674</p> 	 <p>1X160W E14 1X12W E14</p>	<p>Applique Struttura: cromo lucido. Diffusore: cristallo pirex satinato nei colori blu, verde, rosso, ambra, giallo, bianco e trasparente.</p> <p>Wall lamp Structure: polished chrome. Diffuser: satin-finished pyrex crystal available in the following colours: blue, green, red, amber, yellow, white and transparent.</p> <p>± ⚡ CE</p>
<p>CROMOSTILO - 2675</p> 	 <p>2X60W E14 2X12W E14</p>	<p>Applique Struttura: cromo lucido. Diffusore: cristallo pirex satinato nei colori blu, verde, rosso, ambra, giallo, bianco e trasparente. * Con vetro trasparente è consigliata lampada "Spotline" E14.</p> <p>Wall lamp Structure: polished chrome. Diffuser: satin-finished pyrex crystal available in the following colours: blue, green, red, amber, yellow, white and transparent. * "Spotline" E14 is recommended with the transparent glass.</p> <p>± ⚡ CE</p>

MODULO
ELECTRO
www.modulelectro.ru

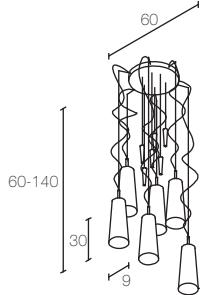
CROMOSTILO - 2676

6X60W E14



6X12W E14

Saliscendi

Struttura: cromo lucido.

Diffusore: cristallo pirex satinato nei colori blu, verde, rosso, ambra, giallo, bianco e trasparente.

Up & down lamp

Structure: polished chrome.

Diffuser: satin-finished pyrex crystal available in the following colours: blue, green, red, amber, yellow, white and transparent.

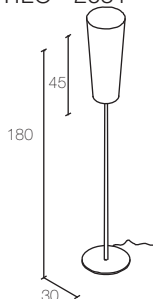
**CROMOSTILO - 2681**

1X100W E27



1X24W E27

Lampada terra

Struttura: cromo lucido.

Diffusore: cristallo pirex satinato nei colori blu, verde, rosso, ambra, giallo, bianco e trasparente.

Floor lamp

Structure: polished chrome.



Diffuser: satin-finished pyrex crystal available in the following colours: blue, green, red, amber, yellow, white and transparent.



MODULO
ELECTRO
www.modulelectro.ru

brick



 **MODUL** 
ELECTRO
www.modulelectro.ru

 **MODUL** 
ELECTRO
www.modulelectro.ru

6551
L12 P23 H14
1X60W G9





MODUL
ELECTRO
www.modulelectro.ru

bulb



MODUL
ELECTRO
www.modulelectro.ru

6550
L33 P11 H22
1X60W G9

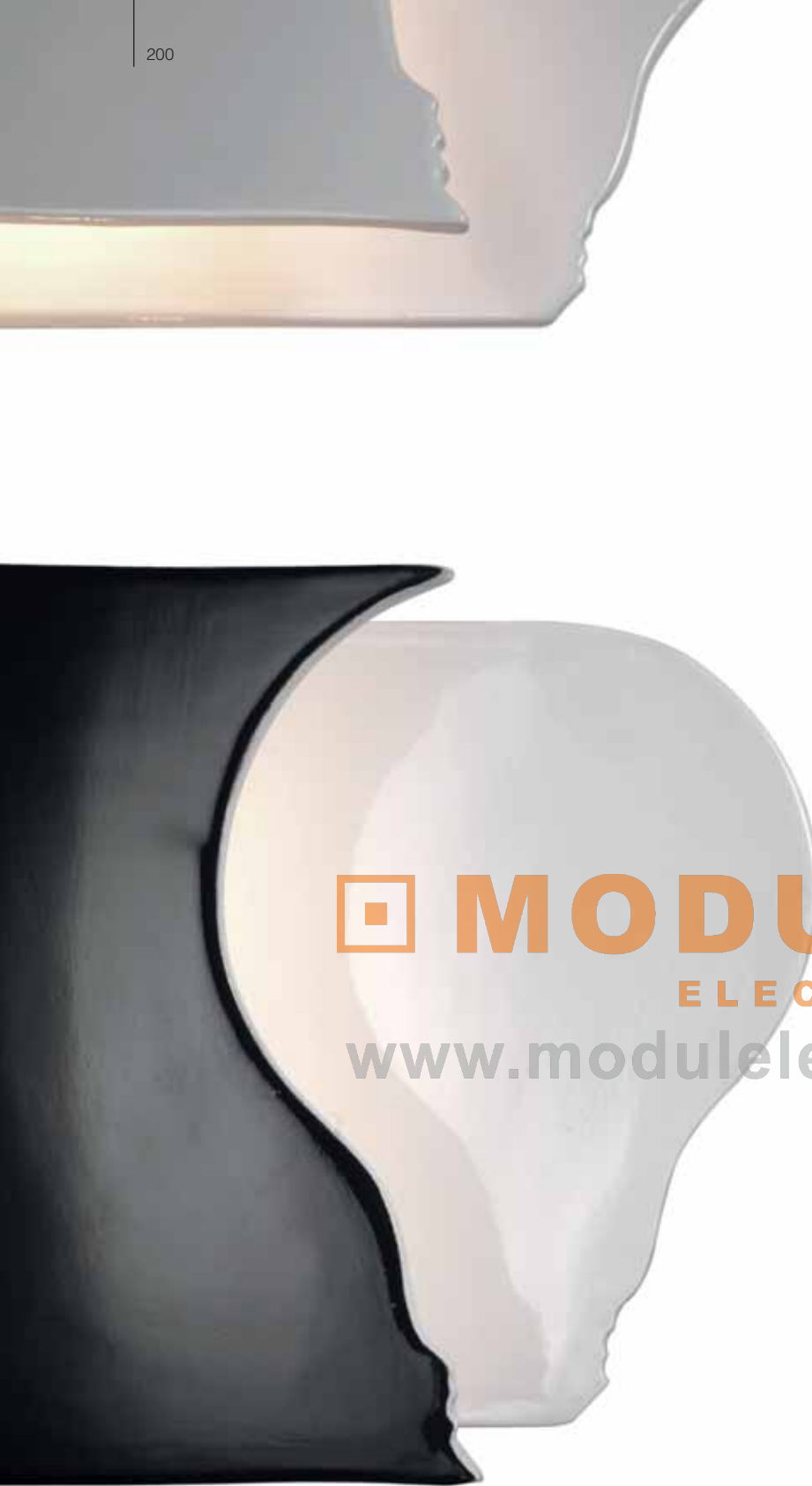

MODULO
ELECTRO
www.modulelectro.ru

bulb





MODUL

ELECTRO

www.modulelectro.ru



bulb

 **MODUL** 
ELECTRO
www.modulelectro.ru



BULB - 6550

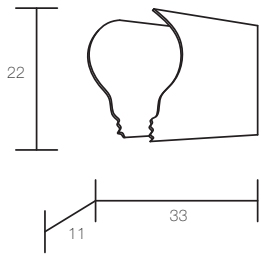

1X60W G9

Applique

Struttura: cromo lucido.

Ceramica colorata: bianco - bianco/nero - bianco/arancio - arancio/bianco.

Wall lamp

Structure: polished chrome.

Colored ceramic: white - white/black - white/orange - orange/white.



BRICK - 6551

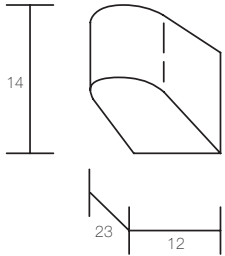

1X60W G9

Applique

Struttura: cromo lucido.

Ceramica colorata: bianco - nero - rosso.

Wall lamp

Structure: polished chrome.

Colored ceramic: white - black - red.





 **MODULO** 
ELECTRO

www.modulelectro.ru





GAMMADELTA GROUP

light tower

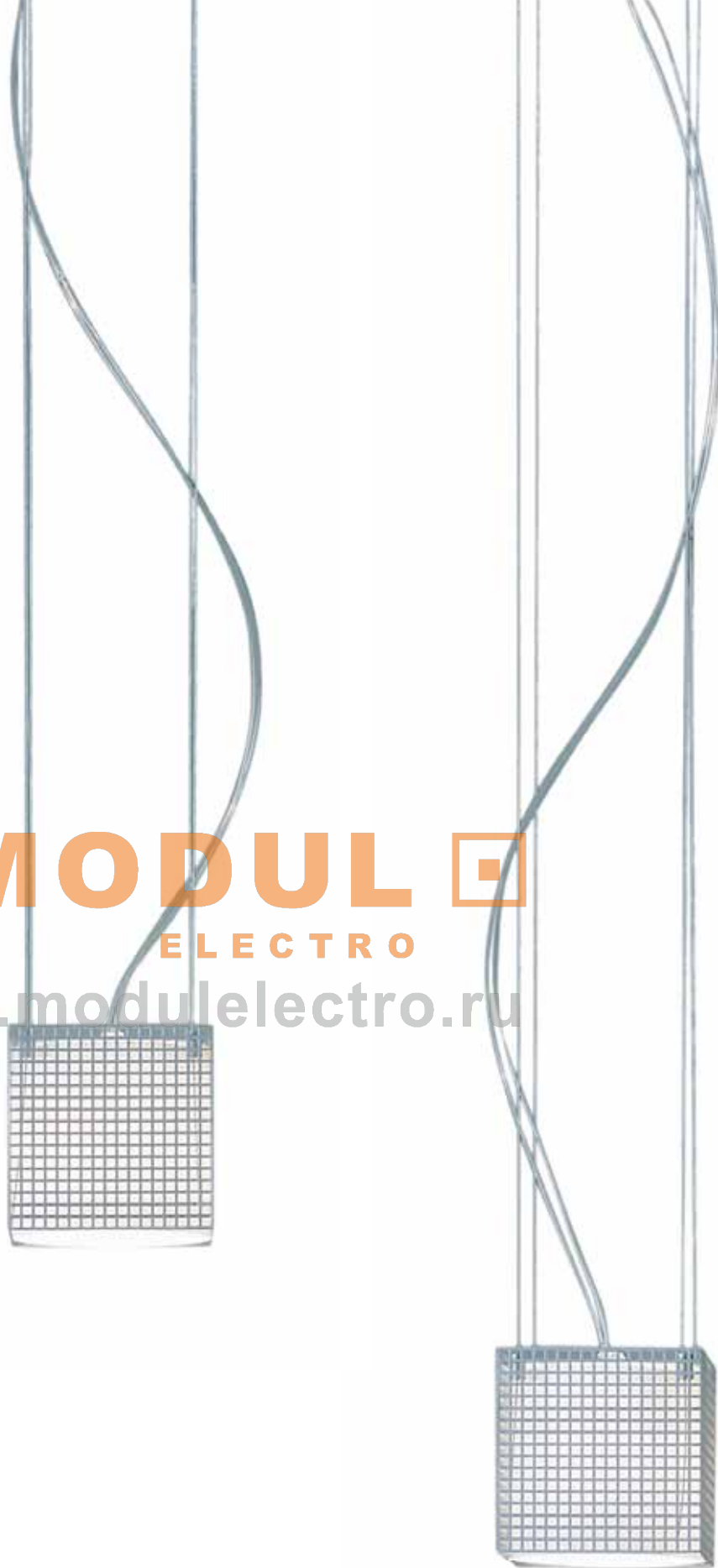
 **MODUL** 
ELECTRO
www.modulelectro.ru



 **MODUL** 
ELECTRO
www.modulelectro.ru



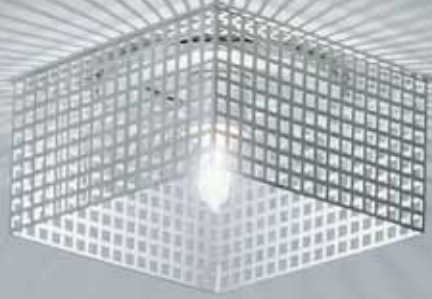

8761
L13 P13 H27-160
1X60W E14



8776
D12 H6
1X60W E14

8775
L13 P13 H6
1X60W E14



 **MODULO** 
ELECTRO
www.modulelectro.ru



8771
D12 H12
1X60W E14





8770
L13 P13 H12
1X60W E14

 **MODUL** 
ELECTRO
www.modulelectro.ru

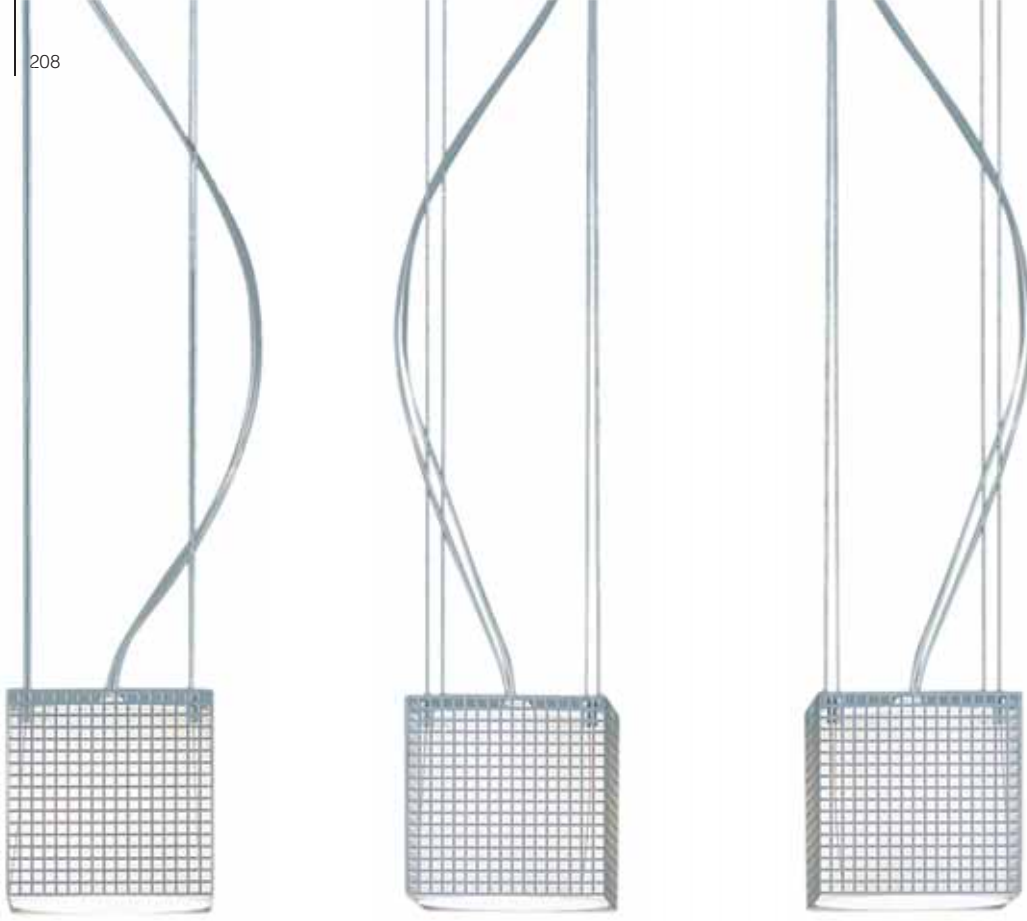









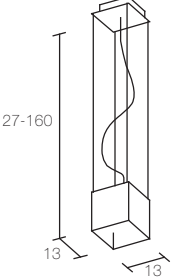



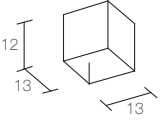







light tower

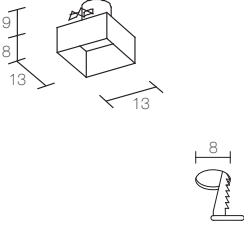

 **MODUL** 
ELECTRO
www.modulelectro.ru

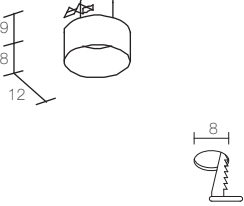
light tower



<p>LIGHT TOWER - 8761 (*G)</p> 	 1X60W E14  1X12W E14  *1X75W G9	<p>Sospensione Struttura: lamiera traforata laccata alluminio opaco con particolari in cromo lucido - schermo in policarbonato tubolare estruso opale.</p> <p>Hanging lamp Structure: perforated sheetmetal in matt enamelled aluminium with polished chrome details - extruded tubular polycarbonate opal.</p> 
<p>LIGHT TOWER - 8770 (*G)</p> 	 1X60W E14  1X12W E14  *1X75W G9	<p>Faretto Struttura: laccato alluminio opaco - particolari cromo lucido.</p> <p>Spot light Structure: matt enamelled aluminium - polished chrome details.</p> 
<p>LIGHT TOWER - 8771 (*G)</p> 	 1X60W E14  1X12W E14  *1X75W G9	<p>Faretto Struttura: laccato alluminio opaco - particolari cromo lucido.</p> <p>Spot light Structure: matt enamelled aluminium - polished chrome details.</p> 
<p>LIGHT TOWER - 8775 (*G)</p> 	 1X60W E14  1X12W E14  *1X75W G9	<p>Faretto incasso Struttura: laccato alluminio opaco - particolari cromo lucido.</p> <p>Recessed spot light Structure: matt enamelled aluminium - polished chrome details.</p> 
<p>LIGHT TOWER - 8776 (*G)</p> 	 1X60W E14  1X12W E14  *1X75W G9	<p>Faretto incasso Struttura: laccato alluminio opaco - particolari cromo lucido.</p> <p>Recessed spot light Structure: matt enamelled aluminium - polished chrome details.</p> 

MODULO
ELECTRO
www.modulelectro.ru

MODUL
ELECTRO
www.modulelectro.ru

marbole



MODUL
ELECTRO
www.modulelectro.ru





MODUL

ELECTRO



www.modulelectro.ru



2411
L12 P12 H50-150
1X50W GU10

2415
L23 P23 H50-150
4X50W GU10





 **MODULO** 
ELECTRO
www.modulelectro.ru

2412
L12 P23 H50-150
2X50W GU10





marble



 **MODUL** 
ELECTRO
www.modulelectro.ru

marbole

 **MODUL** 
ELECTRO
www.modulelectro.ru



1385
L10 P10 H36
2X60W E14



MODUL
ELECTRO
www.modulelectro.ru

1320
L28 P10 H10
1X60W E14

1322
L42 P10 H10
2X60W E14



1335
L40 P10 H10
1X60W E14

1336
L55 P13 H10
2X60W E14

marble



MODUL
ELECTRO
www.modulelectro.ru

1350
L9 P9 H8
1X50W GU5,3 12V



1359
L8 P8 H8
1X50W GU5,3 12V

MODUL
ELECTRO
www.modulelectro.ru



1358
D7 H8
1X50W GU5,3 12V

marble



MODUL
ELECTRO
www.modulelectro.ru



1354
D10 H8
1X50W GU5,3 12V













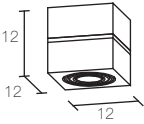

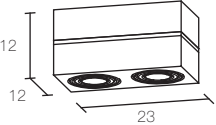
1353
D13 H8
1X50W GU5,3 12V

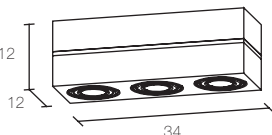
MODUL
ELECTRO
www.modulelectro.ru

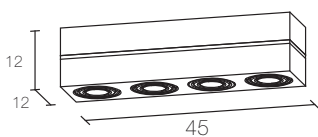

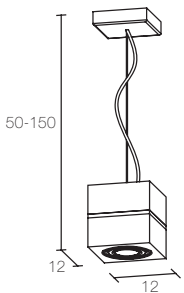
1356
D13 H8
1X50W GU5,3 12V

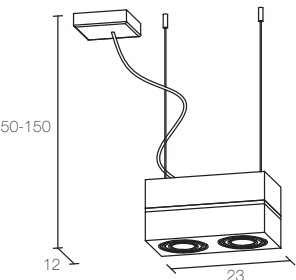
marble











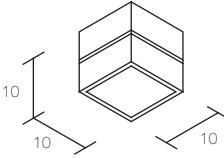

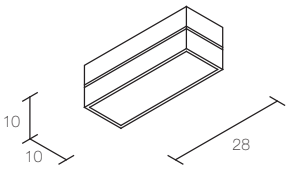

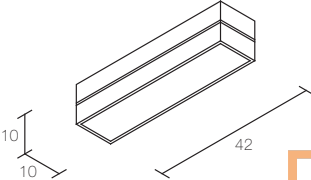

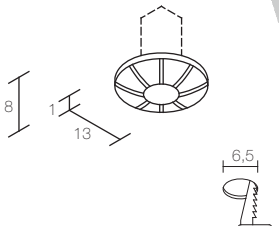

<p>MARBLE - 2401</p> 	 1X50W GU10  1X7W LED GU10	<p>Applique Struttura: metallo laccato bianco con intarsi in marmo e madreperla. Marmo: colore bianco, beige, grigio.</p> <p>Ceiling Structure: white enamelled metal with marble and mother-of-pearl inlays. Marble: white, grey or beige.</p> <p>⚡ ⚡ ⚡ CE</p>
<p>MARBLE - 2402</p> 	 2X50W GU10  2X7W LED GU10	<p>Applique Struttura: metallo laccato bianco con intarsi in marmo e madreperla. Marmo: colore bianco, beige, grigio.</p> <p>Ceiling Structure: white enamelled metal with marble and mother-of-pearl inlays. Marble: white, grey or beige.</p> <p>⚡ ⚡ ⚡ CE</p>
<p>MARBLE - 2403</p> 	 3X50W GU10  3X7W LED GU10	<p>Applique Struttura: metallo laccato bianco con intarsi in marmo e madreperla. Marmo: colore bianco, beige, grigio.</p> <p>Ceiling Structure: white enamelled metal with marble and mother-of-pearl inlays. Marble: white, grey or beige.</p> <p>⚡ ⚡ ⚡ CE</p>
<p>MARBLE - 2404</p> 	 4X50W GU10  4X7W LED GU10	<p>Applique Struttura: metallo laccato bianco con intarsi in marmo e madreperla. Marmo: colore bianco, beige, grigio.</p> <p>Ceiling Structure: white enamelled metal with marble and mother-of-pearl inlays. Marble: white, grey or beige.</p> <p>⚡ ⚡ ⚡ CE</p>
<p>MARBLE - 2411</p> 	 1X50W GU10  1X7W LED GU10	<p>Sospensione Struttura: metallo laccato bianco con intarsi in marmo e madreperla; particolari in cromo lucido. Marmo: colore bianco, beige, grigio.</p> <p>Hanging lamp Structure: white enamelled metal with marble and mother-of-pearl inlays; polished chrome details Marble: white, grey or beige.</p> <p>⚡ ⚡ ⚡ CE</p>
<p>MARBLE - 2412</p> 	 2X50W GU10  2X7W LED GU10	<p>Sospensione Struttura: metallo laccato bianco con intarsi in marmo e madreperla; particolari in cromo lucido. Marmo: colore bianco, beige, grigio.</p> <p>Hanging lamp Structure: white enamelled metal with marble and mother-of-pearl inlays; polished chrome details Marble: white, grey or beige.</p> <p>⚡ ⚡ ⚡ CE</p>

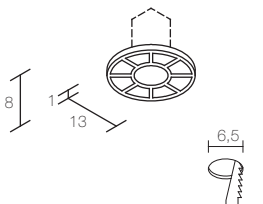



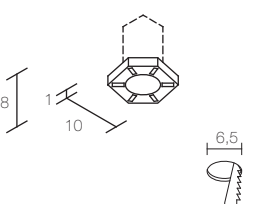

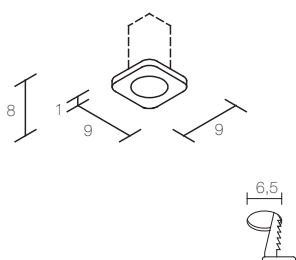

ELECTRO

www.moduloelectro.ru

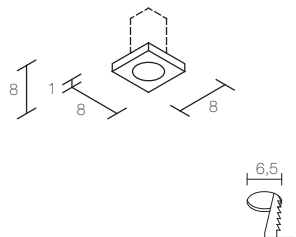
<p>MARBLE - 2413</p>	<p>3X50W GU10 3X7W LED GU10</p>	<p>Sospensione Struttura: metallo laccato bianco con intarsi in marmo e madreperla; particolari in cromo lucido. Marmo: colore bianco, beige, grigio.</p> <p>Hanging lamp Structure: white enamelled metal with marble and mother-of-pearl inlays: polished chrome details. Marble: white, grey or beige.</p> <p>⚡ ⚡ ⚡ CE</p>
<p>MARBLE - 2414</p>	<p>4X50W GU10 3X7W LED GU10</p>	<p>Sospensione Struttura: metallo laccato bianco con intarsi in marmo e madreperla; particolari in cromo lucido. Marmo: colore bianco, beige, grigio.</p> <p>Hanging lamp Structure: white enamelled metal with marble and mother-of-pearl inlays: polished chrome details. Marble: white, grey or beige.</p> <p>⚡ ⚡ ⚡ CE</p>
<p>MARBLE - 2415</p>	<p>4X50W GU10 4X7W LED GU10</p>	<p>Sospensione Struttura: metallo laccato bianco con intarsi in marmo e madreperla; particolari in cromo lucido. Marmo: colore bianco, beige, grigio.</p> <p>Hanging lamp Structure: white enamelled metal with marble and mother-of-pearl inlays: polished chrome details. Marble: white, grey or beige.</p> <p>⚡ ⚡ ⚡ CE</p>
<p>MARBLE - 1335</p>	<p>1X60W E14 1X12W E14</p>	<p style="text-align: center;">ELECTRO</p> <p>Applique Struttura: metallo laccato bianco con intarsi in marmo e madreperla. Vetro diffusore: cristallo bianco sabbaiato. Marmo: colore bianco, beige, grigio.</p> <p>Ceiling Structure: white enamelled metal with marble and mother-of-pearl inlays. Diffuser glass: sandblasted white crystal. Marble: white, grey or beige.</p> <p>⚡ ⚡ ⚡ CE</p>
<p>MARBLE - 1336</p>	<p>2X60W E14 1X12W E14</p>	<p>Applique Struttura: metallo laccato bianco con intarsi in marmo e madreperla. Vetro diffusore: cristallo bianco sabbaiato. Marmo: colore bianco, beige, grigio.</p> <p>Ceiling Structure: white enamelled metal with marble and mother-of-pearl inlays. Diffuser glass: sandblasted white crystal. Marble: white, grey or beige.</p> <p>⚡ ⚡ ⚡ CE</p>
<p>MARBLE - 1385</p>	<p>2X60W E14 1X12W E14</p>	<p>Applique Struttura: metallo laccato bianco con intarsi in marmo e madreperla. Vetro diffusore: cristallo bianco sabbaiato. Marmo: colore bianco, beige, grigio.</p> <p>Ceiling Structure: white enamelled metal with marble and mother-of-pearl inlays. Diffuser glass: sandblasted white crystal. Marble: white, grey or beige.</p> <p>⚡ ⚡ ⚡ CE</p>

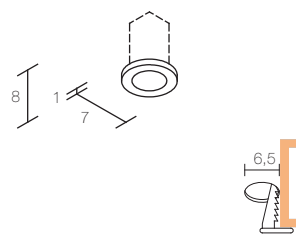
<p>MARBLE - 1382</p> 	 <p>1X60W G9</p>	<p>Applique Struttura: metallo laccato bianco con intarsi in marmo e madreperla. Vetro diffusore: cristallo bianco sabbato. Marmo: colore bianco, beige, grigio.</p> <p>Ceiling Structure: white enamelled metal with marble and mother-of-pearl inlays. Diffuser glass: sandblasted white crystal. Marble: white, grey or beige.</p> <p>± ⚡ CE</p>
<p>MARBLE - 1320</p> 	 <p>1X60W E14</p>  <p>1X12W E14</p>	<p>Applique Struttura: metallo laccato bianco con intarsi in marmo e madreperla. Vetro diffusore: cristallo bianco sabbato. Marmo: colore bianco, beige, grigio.</p> <p>Ceiling Structure: white enamelled metal with marble and mother-of-pearl inlays. Diffuser glass: sandblasted white crystal. Marble: white, grey or beige.</p> <p>± ⚡ CE</p>
<p>MARBLE - 1322</p> 	 <p>2X60W E14</p>  <p>1X12W E14</p>	<p>Applique Struttura: metallo laccato bianco con intarsi in marmo e madreperla. Vetro diffusore: cristallo bianco sabbato. Marmo: colore bianco, beige, grigio.</p> <p>Ceiling Structure: white enamelled metal with marble and mother-of-pearl inlays. Diffuser glass: sandblasted white crystal. Marble: white, grey or beige.</p> <p>± ⚡ CE</p>
<p>MARBLE - 1353 - *1353-L GU10</p> 	 <p>1X50W GU 5.3 12V</p>  <p>*1X50W GU10</p>  <p>*1X3W LED GU10</p>	<p style="text-align: center;">ELECTRO</p> <p>Faretto incasso Struttura: metallo laccato bianco con intarsi in marmo e madreperla. Marmo: colore bianco, beige, grigio.</p> <p>Recessed spot light Structure: white enamelled metal with marble and mother-of-pearl inlays. Marble: white, grey or beige.</p> <p>± ⚡ CE</p>
<p>MARBLE - 1356 - *1356-L GU10</p> 	 <p>1X50W GU 5.3 12V</p>  <p>*1X50W GU10</p>  <p>*1X3W LED GU10</p>	<p>Faretto incasso Struttura: metallo laccato bianco con intarsi in marmo e madreperla. Marmo: colore bianco, beige, grigio.</p> <p>Recessed spot light Structure: white enamelled metal with marble and mother-of-pearl inlays. Marble: white, grey or beige.</p> <p>± ⚡ CE</p>
<p>MARBLE - 1354 - *1354-L GU10</p> 	 <p>1X50W GU 5.3 12V</p>  <p>*1X50W GU10</p>  <p>*1X3W LED GU10</p>	<p>Faretto incasso Struttura: metallo laccato bianco con intarsi in marmo e madreperla. Marmo: colore bianco, beige, grigio.</p> <p>Recessed spot light Structure: white enamelled metal with marble and mother-of-pearl inlays. Marble: white, grey or beige.</p> <p>± ⚡ CE</p>

<p>MARBLE - 1350 - *1350-L GU10</p> 	 <p>1X50W GU 5.3 12V *1X50W GU10 *1X3W LED GU10</p>	<p>Faretto incasso Struttura: metallo laccato bianco con intarsi in marmo. Marmo: colore bianco, beige, grigio.</p> <p>Recessed spot light Structure: white enamelled metal with marble inlays. Marble: white, grey or beige.</p> <p>⚡ ⚡ CE</p>
<p>MARBLE - 1359 - *1359-L GU10</p> 	 <p>1X50W GU 5.3 12V *1X50W GU10 *1X3W LED GU10</p>	<p>Faretto incasso Struttura: metallo laccato bianco con intarsi in madreperla.</p> <p>Recessed spot light Structure: white enamelled metal with mother-of-pearl inlays.</p> <p>⚡ ⚡ CE</p>
<p>MARBLE - 1358 - *1358-L GU10</p> 	 <p>1X50W GU 5.3 12V *1X50W GU10 *1X3W LED GU10</p>	<p>Faretto incasso Struttura: metallo laccato bianco con intarsi in madreperla.</p> <p>Recessed spot light Structure: white enamelled metal with mother-of-pearl inlays.</p> <p>⚡ ⚡ CE</p>

MODUL

CW

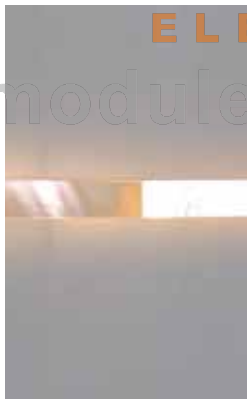

color

CS



BS



www.modulelectro.ru

index

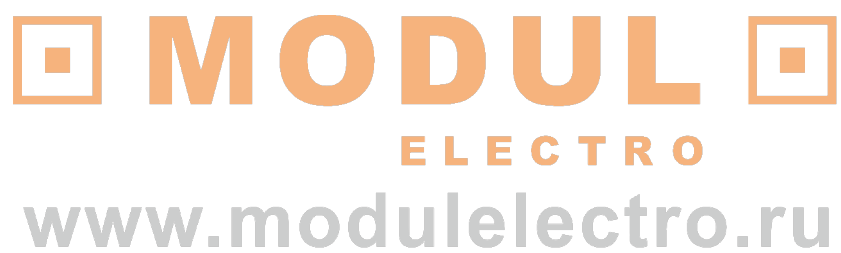

index



wing 2 p.2



soleil p.38



rosa p.18



sirius p.52

MODUL
ELECTRO

www.modulelectro.ru



freesby p.24



stars p.60



egg p.34



ice p.70

index



square

p.78



wallwing

p.90



starry

p.80



halowing

p.98



shiny

p.82



fluorwing

p.104



pierrot

p.86



micol

p.108

MOD
ELECTRO
www.modulelectro.ru

index



air

p.112



tensosystem p.142



helix

p.124



ring

p.146

MODULO
ELECTRO

www.modulelectro.ru



speed

p.132



net

p.152



tenso

p.136



honey

p.162

index



round

p.170



brick

p.196



motion

p.172

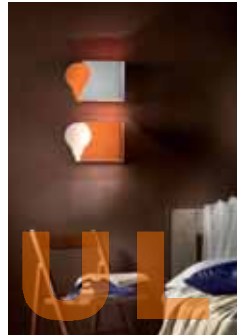

bulb

p.198

MODULI
ELECTRO

www.modulelectro.ru



stilo

p.180



light tower p.204



cromostilo

p.190



marble

p.210

Simboli - Symbols

 - Dichiarazione di conformità
- Declaration of conformity

 - Montaggio su superfici normalmente infiammabili
- Mounting inflammable surfaces normaly

 - Terra
- Earth



 - Classe II
- Class II

 - Regolatore di tensione
- Dimmer

ELECTRO

www.modulelectro.ru

Graphics design

Carlotta Mescalchin

Photos

Digital movie

www.digitalmovie.it

Photodesign

www.photo-design.it

Print

Grafiche Quattro (VE)

www.grafichequattro.com

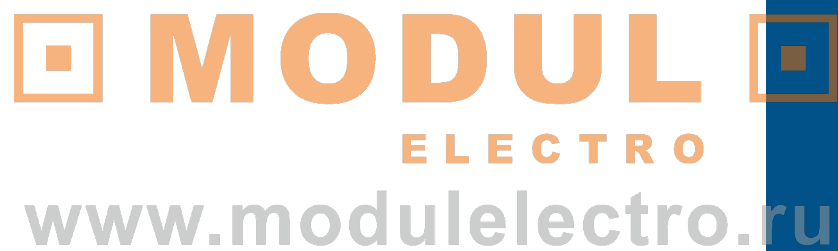
The logo for MODUL ELECTRO features the word "MODUL" in a large, bold, orange sans-serif font. The letter "O" is stylized with a square cutout in the center. To the left and right of "MODUL" are square icons: the left one is orange with a white square inside, and the right one is white with an orange square inside. Below "MODUL" is the word "ELECTRO" in a smaller, orange, spaced-out sans-serif font. At the bottom of the logo is the website address "www.modulelectro.ru" in a grey sans-serif font.

MODUL
ELECTRO
www.modulelectro.ru

The logo for GAMMADELTAGROUP consists of three stacked blue squares of varying sizes, with the largest square at the bottom.

GAMMADELTAGROUP s.r.l.

Statale Adriatica Km10,2 - 35020 Due Carrare - Padova Italy
Tel. (+39) 049 9125155 - Fax (+39) 049 9125542
info@gammadeltagroup.com - www.gammadeltagroup.com