

la murrina
M U R A N O

Lighting
Disegno
New Classic
Contemporaneo

Pura magia



Indice Index

Disegno

Astra	
Cross+	
Delfi	
Gaia	
Huevo	
Lara	
Lollipop	
Mariposa	
Oyster	
Phoenix	
Seaflower	
Shanghai	
Sike	
Tattoo	
Tetris	
Tocada	
Zelig	
Zoe	

New Classic

Ca' d'Oro	
Coronella	
Formichiere	
Glamour	
Medusa	
Medusa Swarovski	
Planet	
Vanity	
Veneziano	

Contemporaneo

101	
102	
602	
629	
681	
684	
688	
697	
702	
737	
738	

739	
825	
Airone	
Albatros	
Apache	
Aquilone	
Atmosphere	
Balloon	
Bandolero	
Bora Bora	
Cometa	
Cormorano	
Dolly	
Dolly Maxi	
Egeo	
Excalibur	
File	
Formelle	
Galaxy	
Genius	
Genius Tecno	
Gheisa	
Intrigo	
Lolita	
Mambo	
Marilyn	
Mediterraneo	
Misses	
Nadir	
Obelisco	
Orione	
Perla	
Pulsar	
Queen	
Rumba	
Saros	
Sintesi	
Specchi Burano	
Squared	
Stilo	
Thaiti	



Disegno

L'obiettivo della divisione Disegno è la lettura in chiave contemporanea dell'arte millenaria della soffiatura del vetro.

Le collezioni di luci nascono dalla collaborazione dell'azienda con importanti e selezionati progettisti italiani e stranieri, che propongono la loro interpretazione di questa materia capace di suscitare emozione e di stimolare creatività, al fine di raggiungere un risultato estetico e formale, ma allo stesso tempo funzionale alle diverse esigenze illuminotecniche.

The Disegno collection was created for the purpose of illustrating the many ways that the ancient art of glass blowing can be utilized in truly modern ways. Each piece is the result of a successful collaboration with a very selected group of important Italian and international designers. Each artist uniquely expresses their own ideas and skills and thus, an eclectic and varied collection of light pieces is born.

The beauty of glass inspires genuine creativity for our designers and awakens their emotions, enabling them to arrive at innovative yet purposeful art pieces, which accommodate a myriad of commercial and residential projects.



Lara

Paolo Deganello



Astra
Huevo
Phoenix
Zelig

Denis Santachiara



Sike

Karim Rashid



Gaia

Massimo Iosa Ghini



Oyster
Zoe

Sandro Santantonio



Delfi
Tocada

Oscar Tusquets



Mariposa
Tattoo

Marco Piva



Lollipop

Sottsass Associati



Shanghai

Luca Scacchetti



Tetris

Matteo Nunziati



Seaflower

Marcello Albini



Cross+

Simone Micheli

ASTRA design
Denis Santachiara

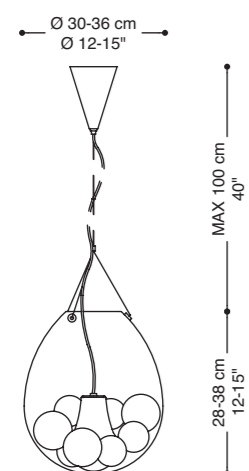

S/ piccola 1 x MAX 100W AL E27
grande 1 x MAX 150W AL E27

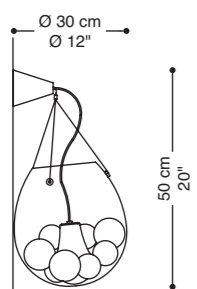

A 1 x MAX 100W E27 alog

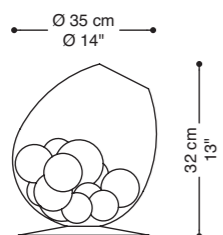

P 1 x MAX 100W E27



Vetro/Glass



EE

Struttura/Metalwork

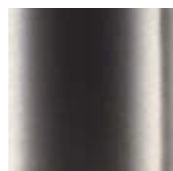

9



Astra S



AstrA A



AstrA P



AstrA S

SHANGHAI

design
Luca Scacchetti

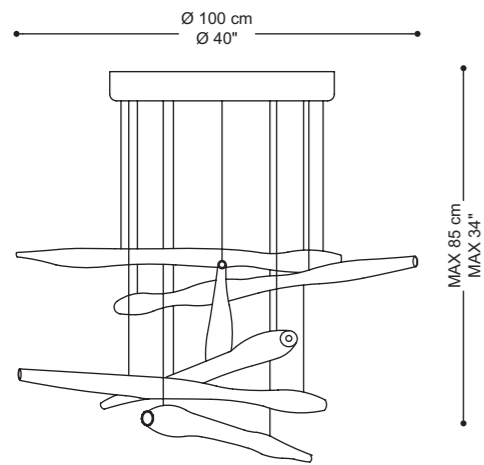

S | 5 x MAX 35W GU10 - 230V | CE

Prodotto realizzabile su disegno e misura / Custom made product

Vetro/Glass

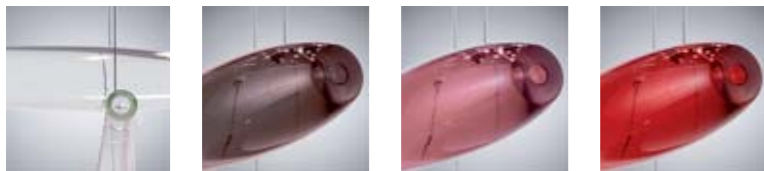

AA

FF

VV

YY

Struttura/Metalwork

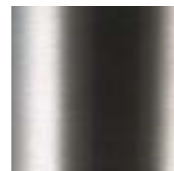

3S



Shanghai

[Torna all'indice](#)
[Back to index](#)

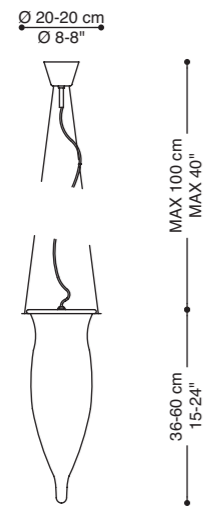

S/piccola | 1 x MAX 100W E27 | CE
grande | 1 x MAX 100W E27 | CE

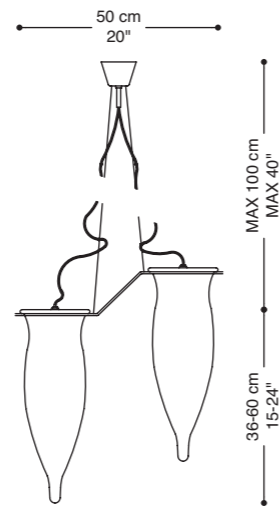

S/piccola doppia | 2 x MAX 100W E27 | CE
grande doppia | 2 x MAX 100W E27 | CE

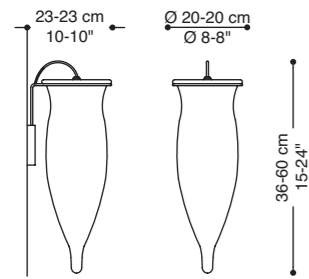

A/piccola | 1 x MAX 100W E27 | CE
grande | 1 x MAX 100W E27 | CE

Vetro/Glass



AD

Struttura/Metalwork

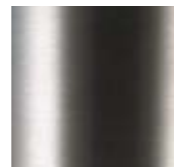

3S



Delfi S2



Delfi S1



Delfi A



Delfi S2

TATTOO

design
Marco Piva

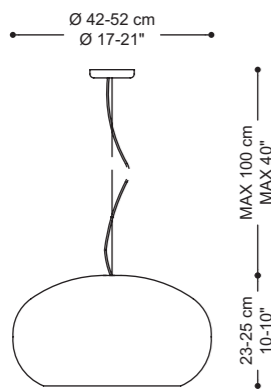

- S/ 42 | 1 x MAX 100W E27 GLOBOLUX \varnothing 80mm
52 | 1 x MAX 100W E27 GLOBOLUX \varnothing 100mm



Vetro/Glass

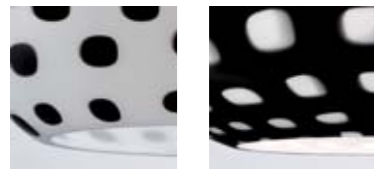

DP

PD

Struttura/Metalwork

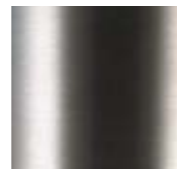

3S

Tattoo S



Tattoo S

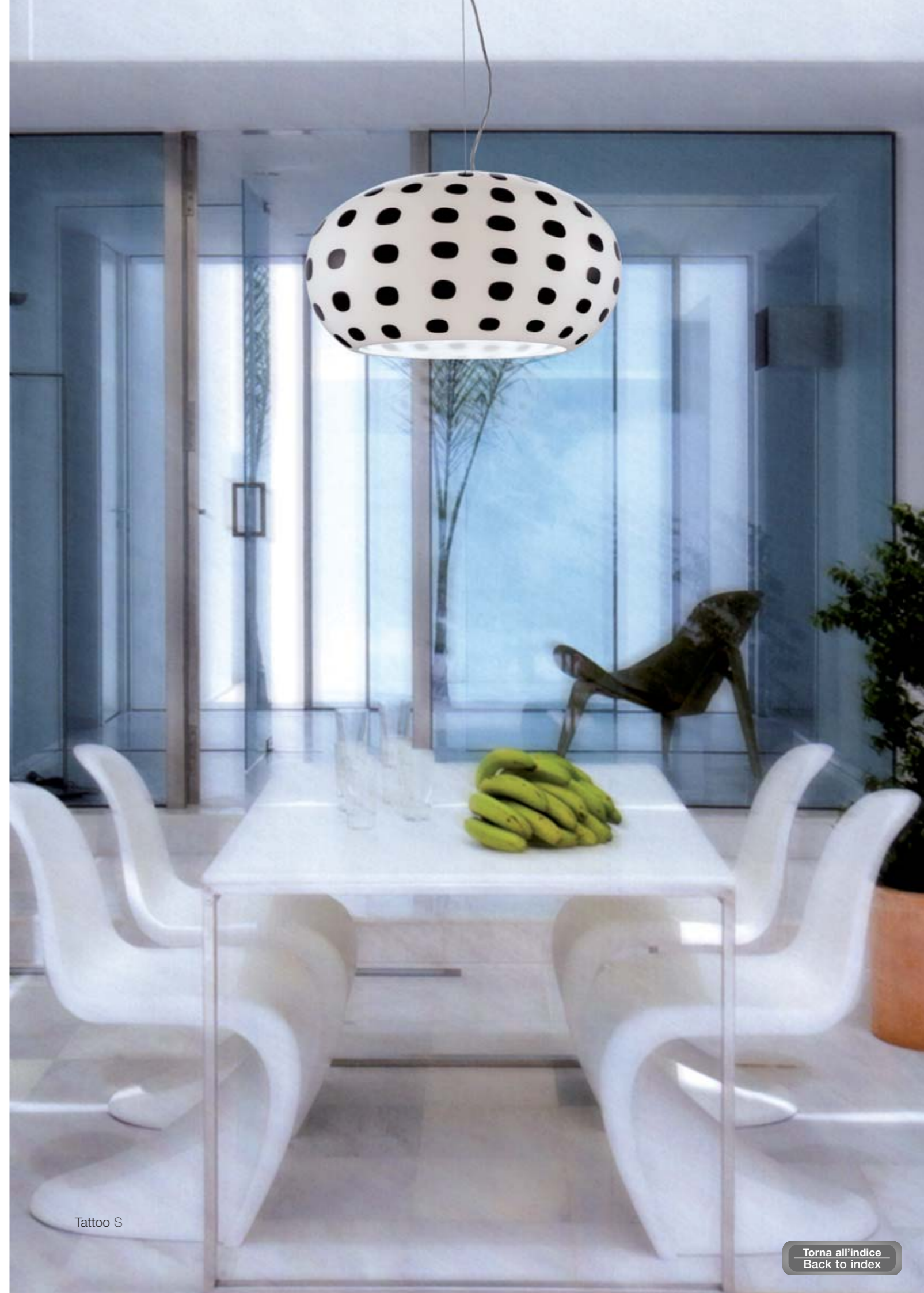

Tattoo S

LOLLIPOP

design
Sottsass Associati

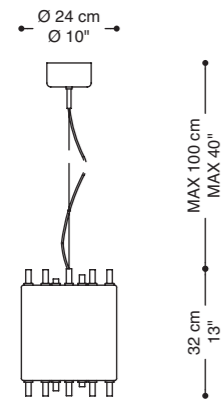

S |  1 x MAX 150W AL E27 | CE 

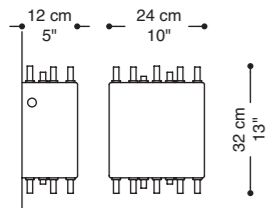

A |  1 x MAX 150W AL R7S | CE 

Vetro/Glass



EE

Struttura/Metalwork

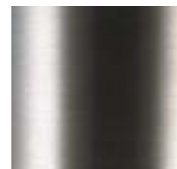

3S



Lollipop S



Lollipop A

ZOE design
Sandro Santantonio

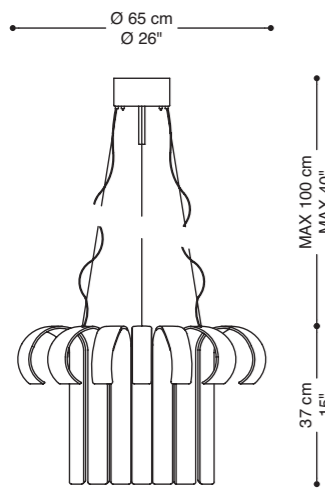

S/ Ø 65 | 2 x MAX 200W AL R7S | CE

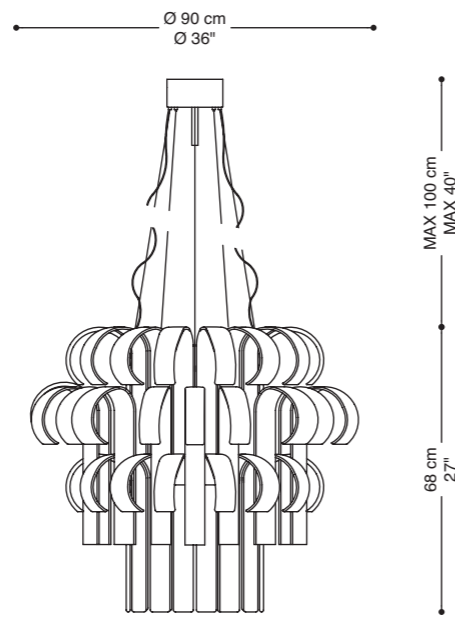

S/ Ø 90 | 3 x MAX 200W AL R7S | CE



Vetro/Glass



DD

PP

YY

Struttura/Metalwork

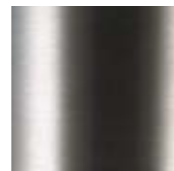

3S

Zoe S

[Torna all'indice](#)
[Back to index](#)



Zoe S



Zoe S

PHOENIX design
Denis Santachiara

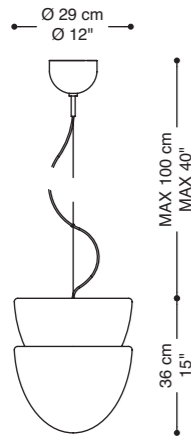

S | 1 x MAX 150W AL E27 | CE

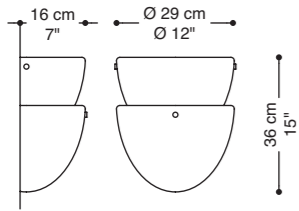

A | 1 x MAX 200W AL R7S | CE

Vetro/Glass



DB

DN

DY

Struttura/Metalwork

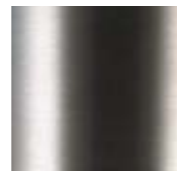

3S



Phoenix S



Phoenix S



Phoenix S





Phoenix A

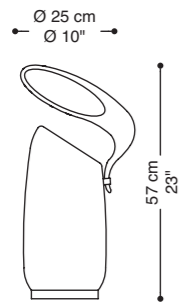

Phoenix S

LARA design
Paolo Deganello



P 1 x MAX 60W E27 spot R63 30°  

Vetro/Glass



DD

Struttura/Metalwork

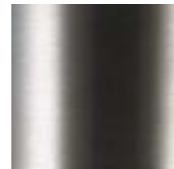

3S

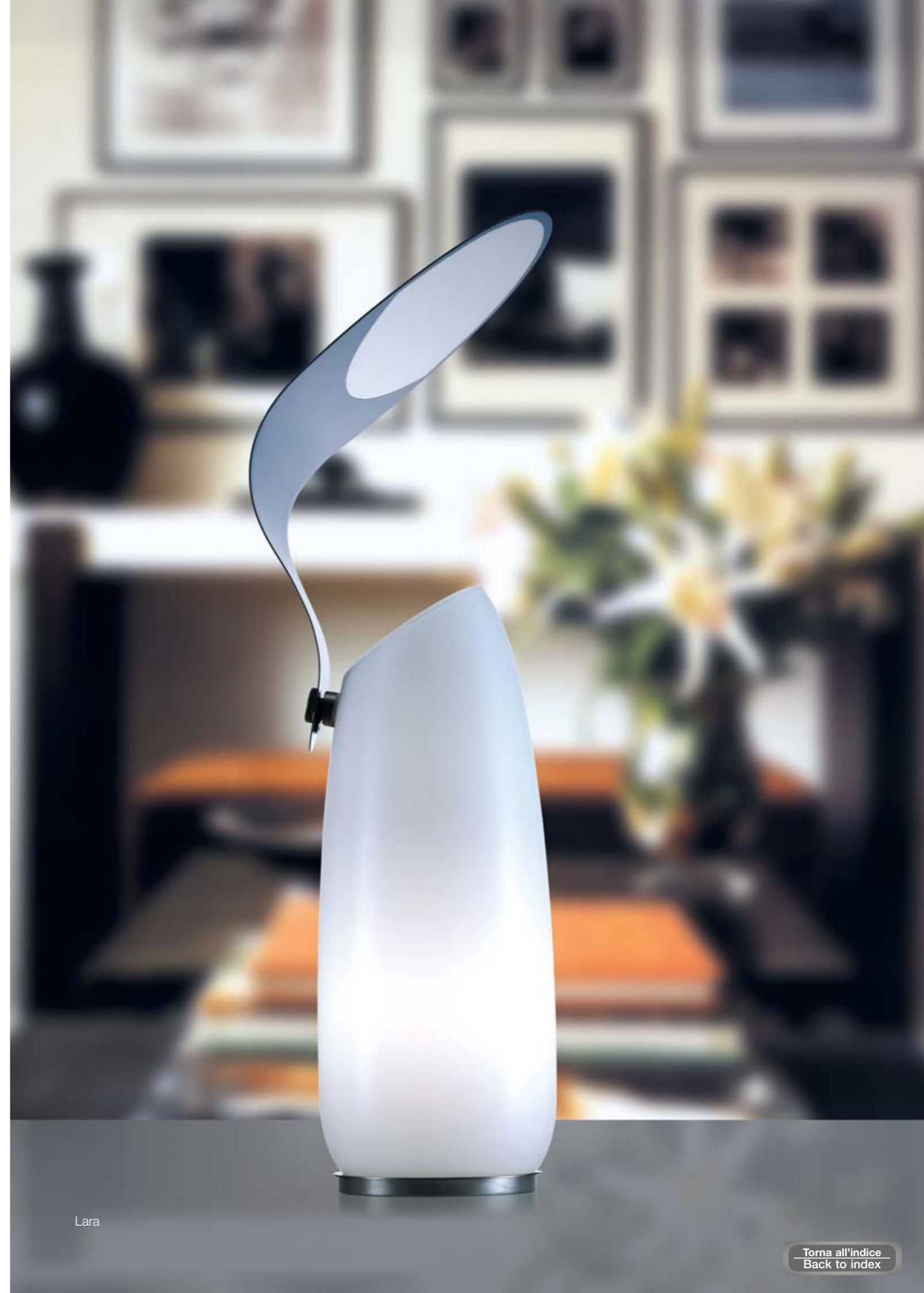

Lara

TOCADA

design
Oscar Tusquets

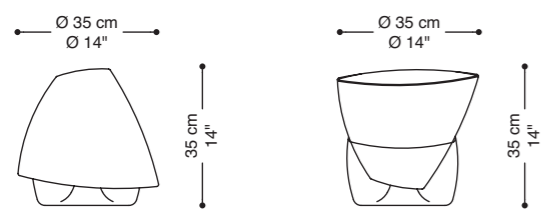

P | 1 x MAX 100W E27 |



Tocada

Vetro/Glass



DA

NA

Struttura/Metalwork

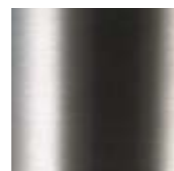

3S



Tocada

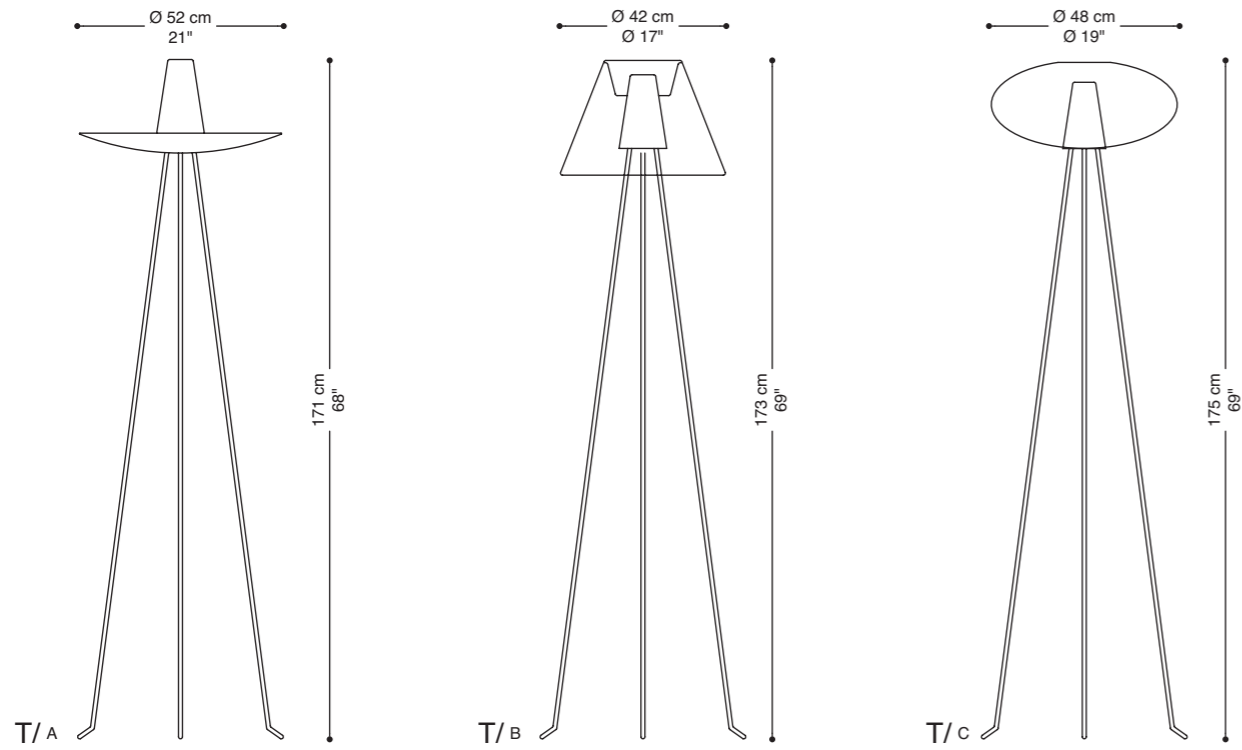

1 x MAX 20W E27 risparmio energetico | CE

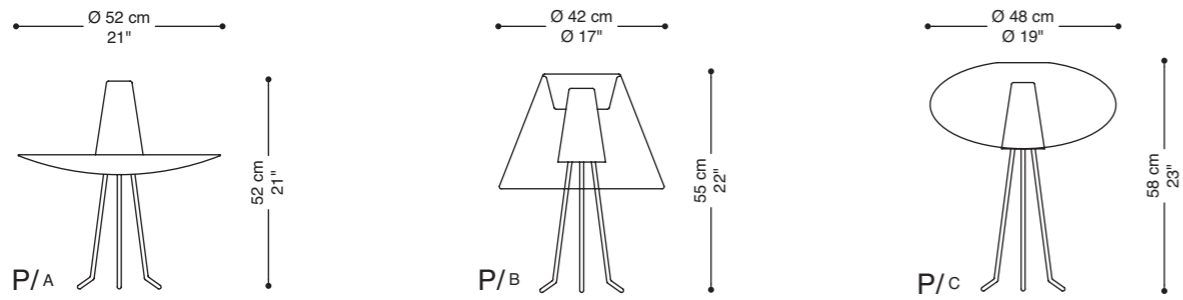

1 x MAX 20W E27 risparmio energetico | CE

Vetro/Glass

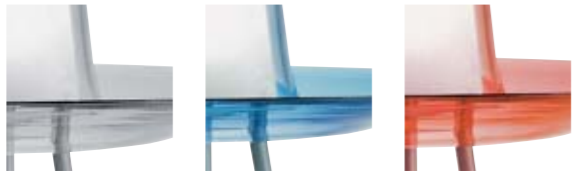

AA

AN

AY

Struttura/Metalwork



9



Zelig P a



Zelig P b



Zelig P c



Zelig T c





Zelig T a

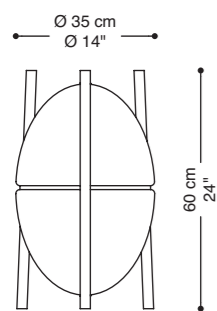

Zelig T b

HUEVO design
Denis Santachiara



P |  2 x MAX 60W E27 | 

Vetro/Glass



DD



YY

Struttura/Metalwork



3S



Huevo

TETRIS design
Mitteo Nunziati

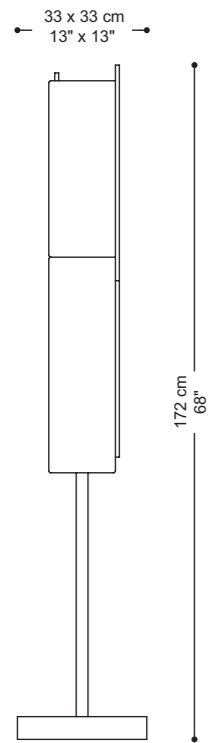

T 1 x MAX 75W E27 PAR 30 SPOT
2 x MAX 2W LED RGB

CE V

Vetro/Glass Colori Led/Led colours

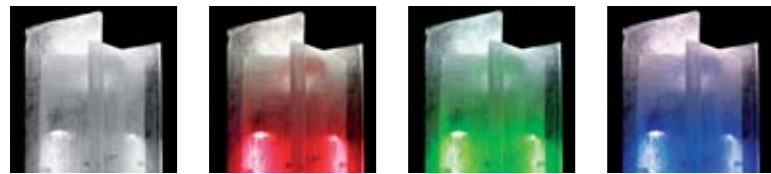

AA Red Green Blue

Struttura/Metalwork





3S



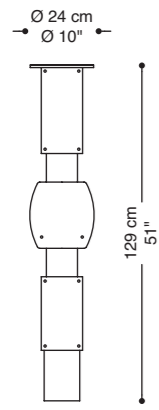

Tetris

GAIA design
Massimo Iosa Ghini

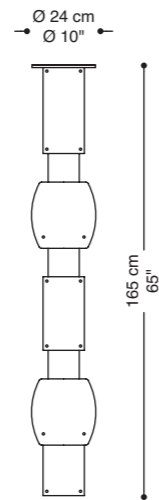

S/B |  2 x MAX 21W E27 | CE 
risparmio energetico



S/A |  3 x MAX 21W E27 | CE 
risparmio energetico

Prodotto realizzabile su disegno e misura / Custom made product

Vetro/Glass



DB

DY

Struttura/Metalwork

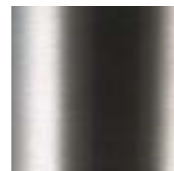

3S

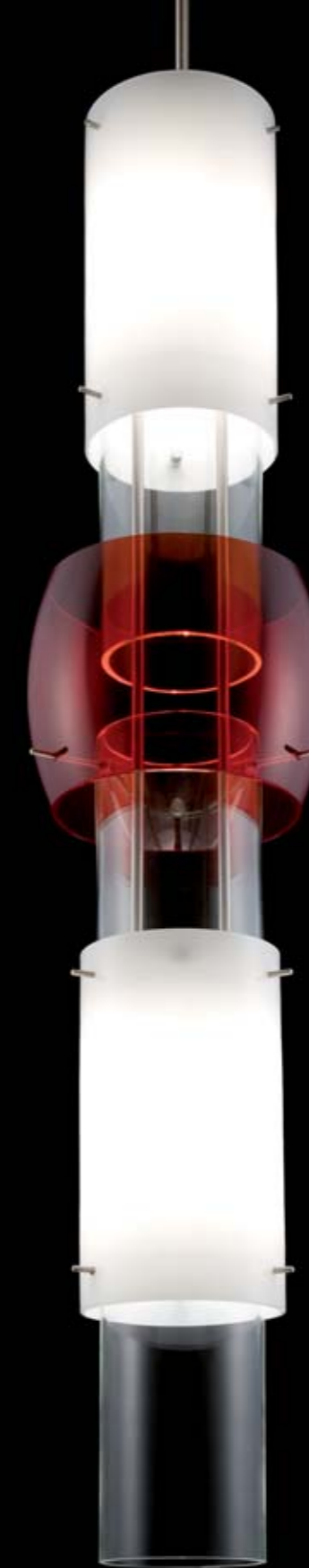

Gaia

OYSTER design Sandro Santantonio

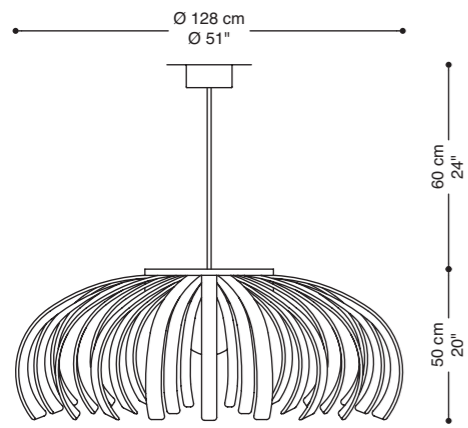

S | 1 x MAX 150W AL E27 | CE

Vetro/Glass



DD

PP

YY

Struttura/Metalwork



3S



Oyster

CROSS+ design
Simone Micheli

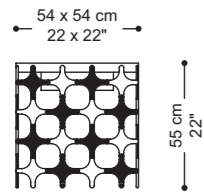

S/LATO/SIDE 54 x 54 H 55 cm

4 x MAX 75W E27 PAR 30 SPOT | CE

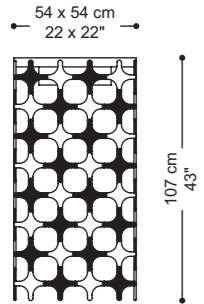

S/LATO/SIDE 54 x 54 H 107 cm

4 x MAX 75W E27 PAR 30 SPOT | CE

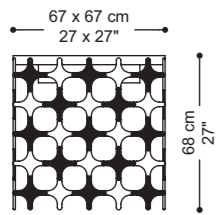

S/LATO/SIDE 67 x 67 H 68 cm

4 x MAX 75W E27 PAR 30 SPOT | CE

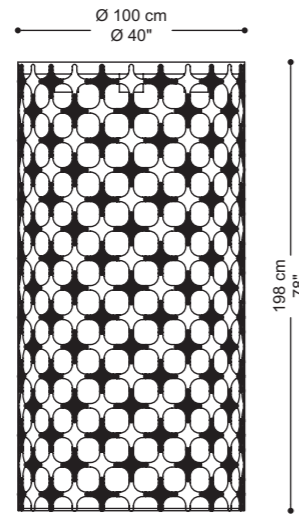

S/ Ø 100 H 198 cm

5 x MAX 75W E27 PAR 30 SPOT | CE

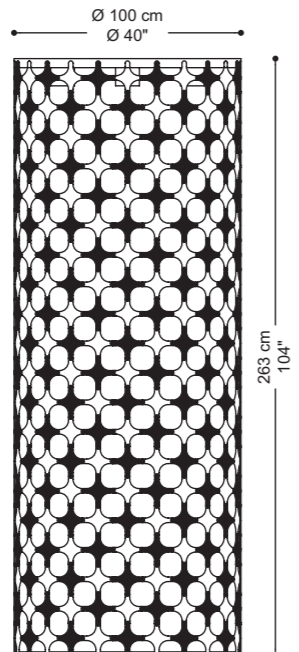

S/ Ø 100 H 263 cm

5 x MAX 75W E27 PAR 30 SPOT | CE

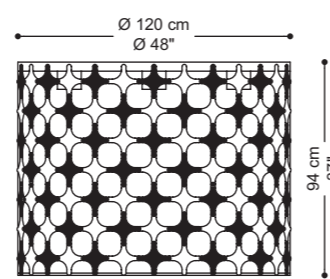

S/ Ø 120 H 94 cm

6 x MAX 75W E27 PAR 30 SPOT | CE

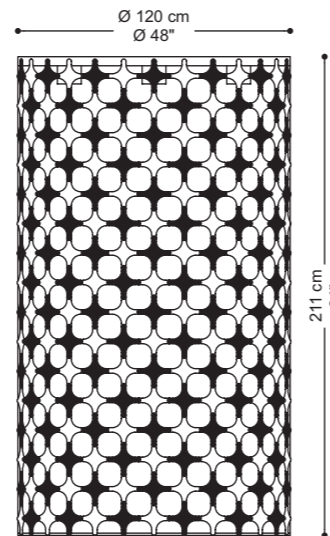

S/ Ø 120 H 211 cm

6 x MAX 75W E27 PAR 30 SPOT | CE

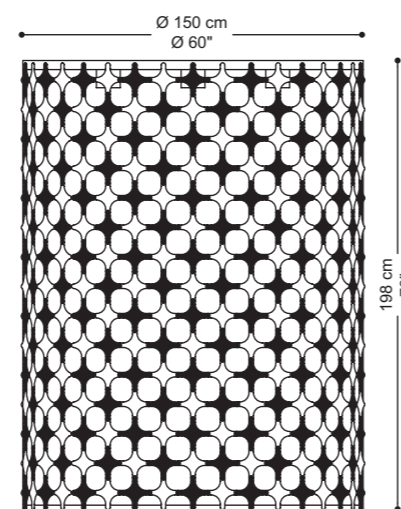

S/ Ø 150 H 198 cm

7 x MAX 75W E27 PAR 30 SPOT | CE

Prodotto realizzabile su disegno e misura / Custom made product

Vetro/Glass



AA



YY

Struttura/Metalwork

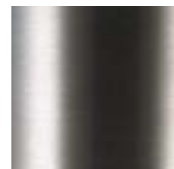

3S

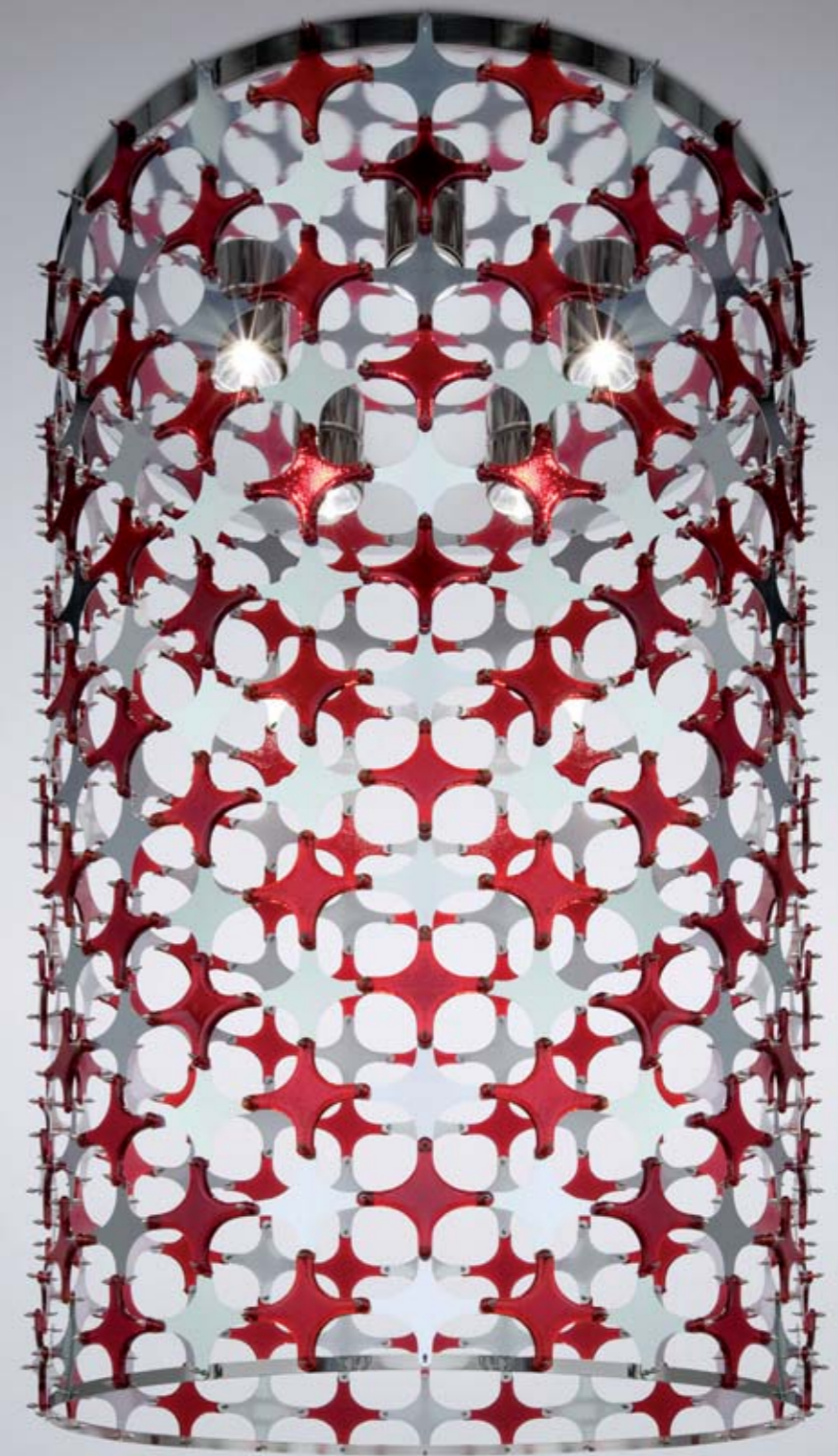

Cross+

Torna all'indice
Back to index



Cross+

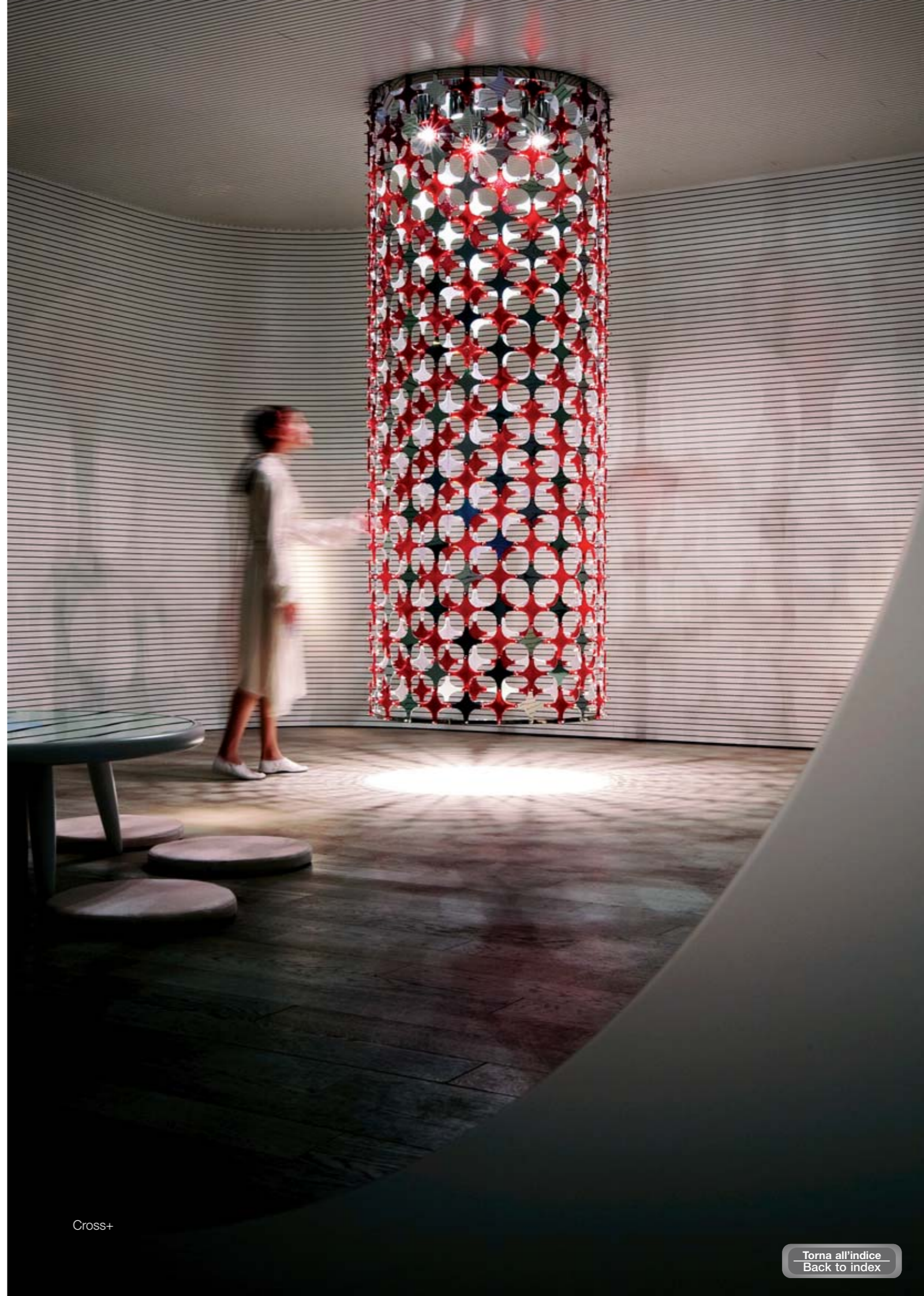

Cross+

MARIPOSA

design
Marco Piva

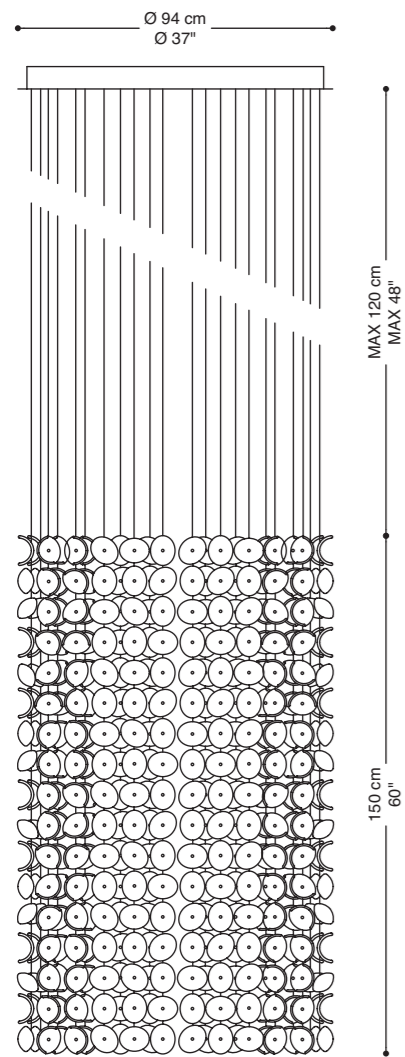

S/Ø 94 | 10 x MAX 150W E27 alog | CE

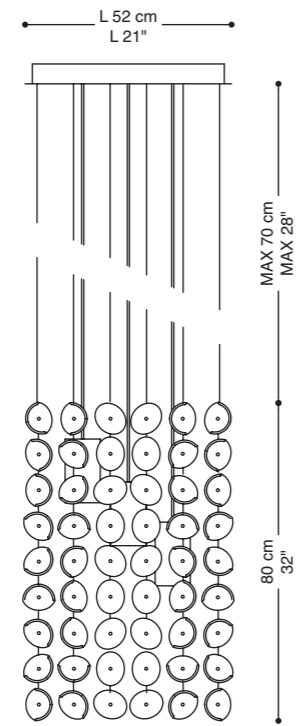

S/L 52 | 3 x MAX 150W E27 alog | CE

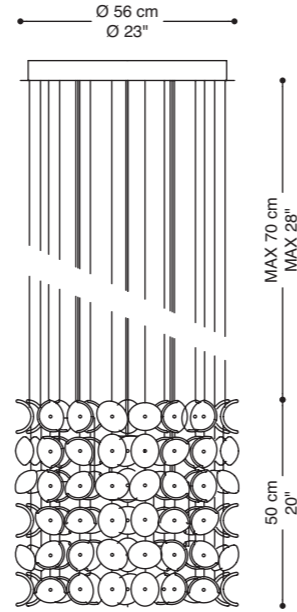

S/Ø 56 | 3 x MAX 150W E27 alog | CE

Prodotto realizzabile su disegno e misura / Custom made product

Vetro/Glass



AA

DD

PP

YY

Struttura/Metalwork

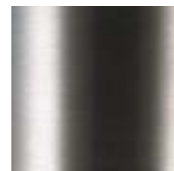

3S



Mariposa

Torna all'indice
Back to index

SEAFLOWER design Marcello Albini

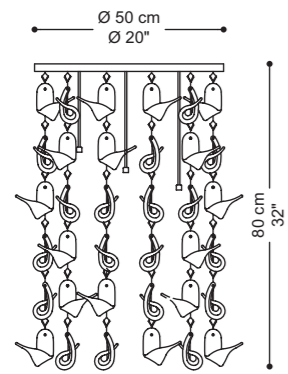

S/ 50 | 5 x MAX 40W G9 | CE 0.3 m

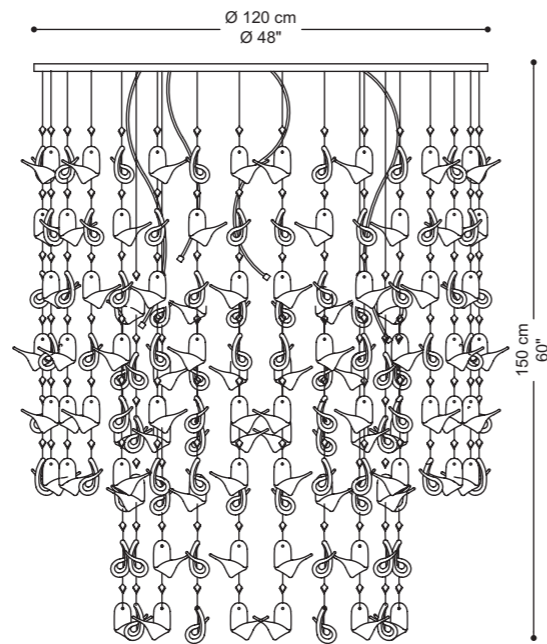

S/ 120 | 6 x MAX 40W G9 | CE 0.3 m

Prodotto realizzabile su disegno e misura / Custom made product

Vetro/Glass



AA

Struttura/Metalwork



3S



Seaflower

SIKE design
Karim Rashid

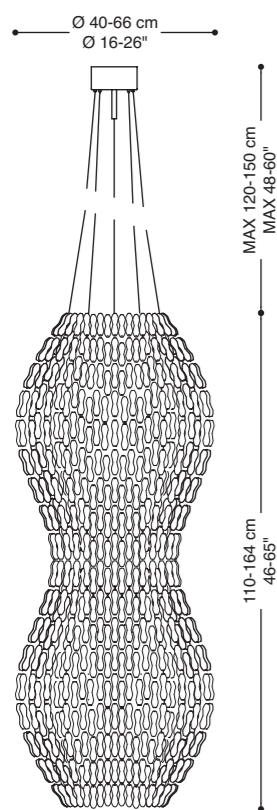

S/Ø 40 | 4 x MAX 150W E27 alog
Ø 66 | 7 x MAX 150W E27 alog

CE

Vetro/Glass



AB

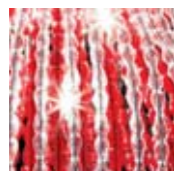

AY

Struttura/Metalwork



3S

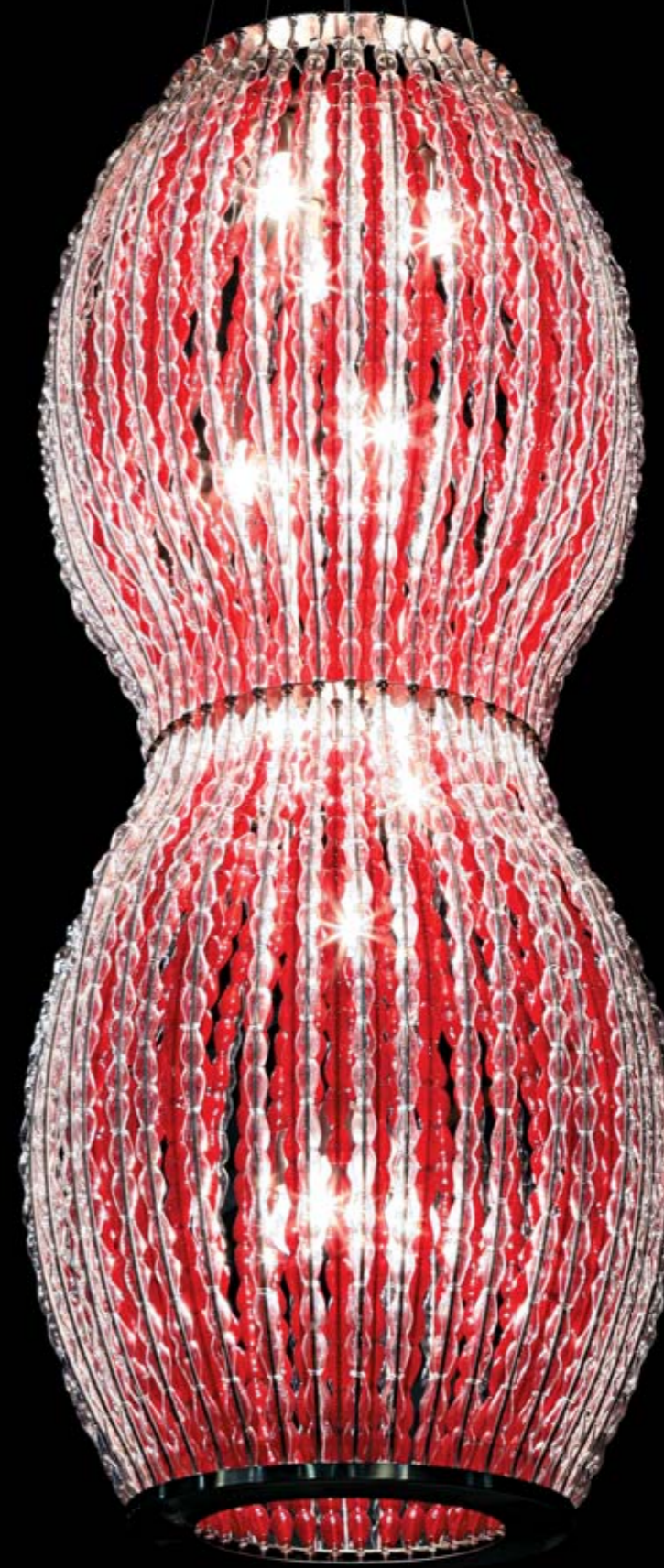

SIKE



New Classic

Un nuovo modo di interpretare forme del passato, attraverso colori decisamente inusuali, per lo stile veneziano: lampadari interamente neri rossi o bianco latte, o ancora di altri colori, con forti motivi decorativi.

Sono pezzi che trovano la loro ideale collocazione in spazi arredati in stile contemporaneo, dove il rigore del design viene "spezzato" dall'introduzione di un elemento dirompente, che da solo diventa il protagonista di tutto l'ambiente.

Realizzati in varie dimensioni e principalmente su misura, a seconda dell'esigenza del designer o architetto, trovano riscontro positivo in tutto il mondo, sia per residenze private che per locali pubblici.

La luce si diffonde attraverso il decoro facendosi portavoce delle più innovative tendenze del design.

Our New Classic collection brings a contemporary flair to the classic shapes of the past through the use of bold coloring and updated styling.

These are pieces intended for modern interior spaces where streamlined design is enhanced with the presence of a bold light piece. Our master glass blowers create these works of art in single or multiple tiers and in sizes to accommodate every project.

Light, transformed through the use of decoration and transparency, becomes a statement in innovation and contemporary design.

VENEZIANO

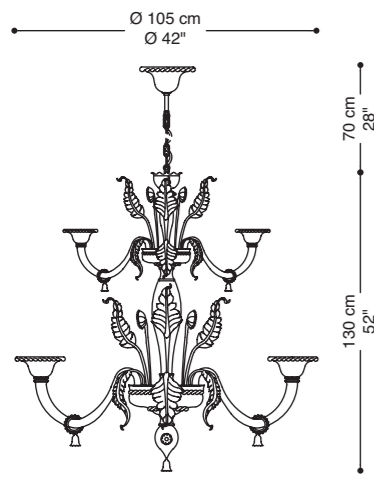

S/ 8+4 | 12 x MAX 40W E14 | CE

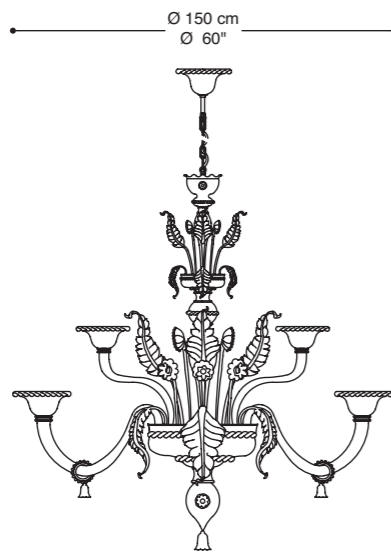

S/ 18 | 18 x MAX 40W E14 | CE

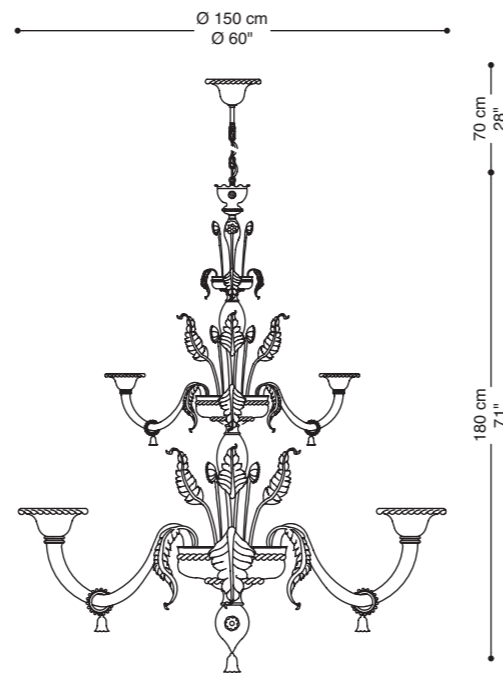

S/ 12+6 | 18 x MAX 40W E14 | CE

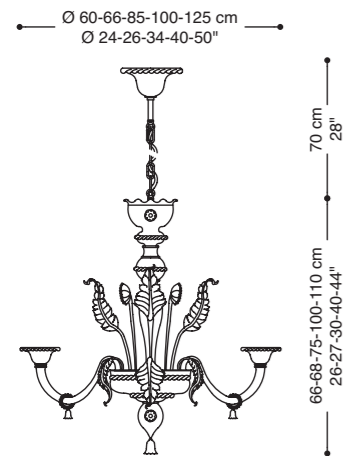

S/ 3-5-6-8-12 | n° x MAX 40W E14 | CE

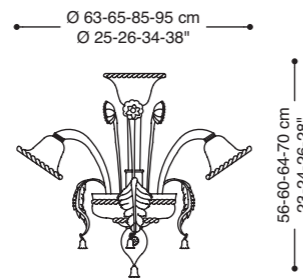

R/ 3-5-6-8 | n° x MAX 40W E14 | CE

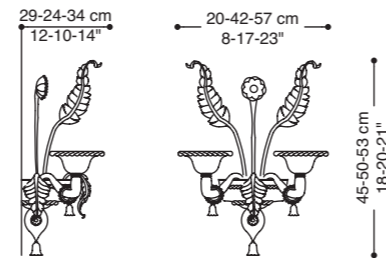

A/ 1-2-3 | n° x MAX 40W E14 | CE

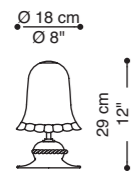

P/ 1 | 1 x MAX 40W E14 | CE

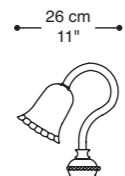

P/ 1L | 1 x MAX 40W E14 | CE

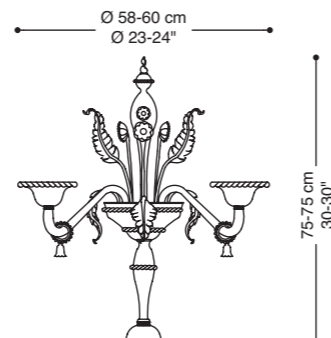

P/ 3-5 | n° x MAX 40W E14 | CE

Vetro/Glass



DA DD PA PP YY

Struttura/Metalwork



3S



Veneziano S18



Veneziano S6



Veneziano R6



Veneziano A2



Veneziano A3



Veneziano S8

GLAMOUR

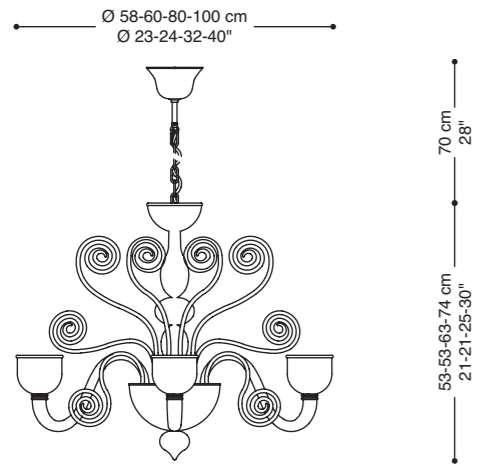

S/ 3-5-6-8 | n° x MAX 40W E14 | CE

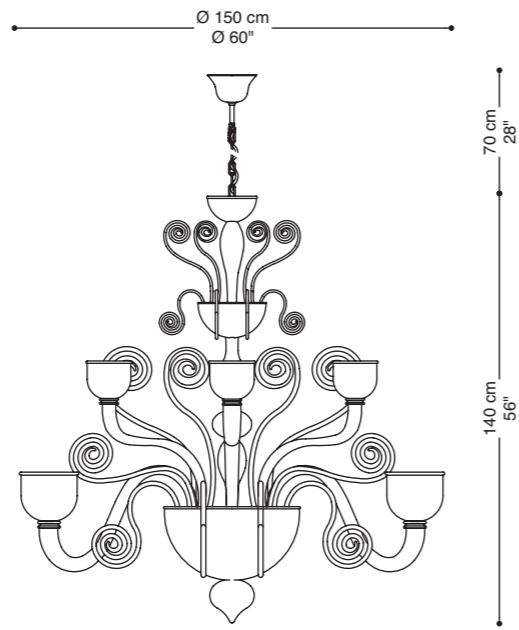

S/18 | 18 x MAX 40W E14 | CE

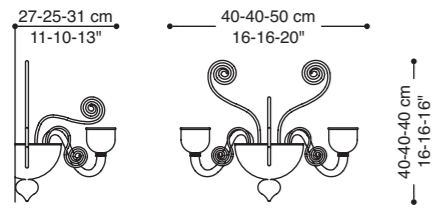

A/ 1-2-3 | n° x MAX 40W E14 | CE

Vetro/Glass



AA

CC

JJ

Struttura/Metalwork



3S



Glamour S18



Glamour S6



Glamour S6



Glamour A2



Glamour S6

VANITY

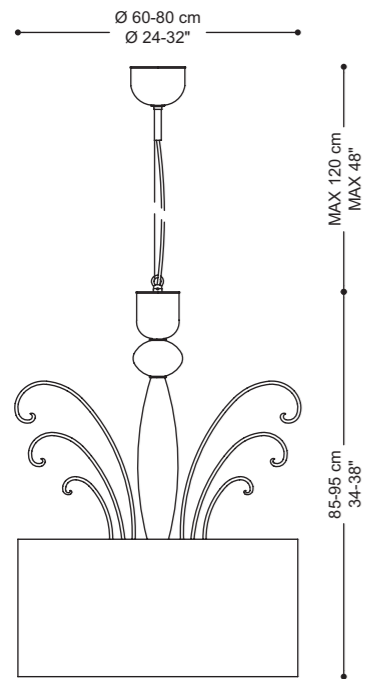

S/ 60 | 4 x MAX 60W E27 | CE ∇

80 | 6 x MAX 60W E27

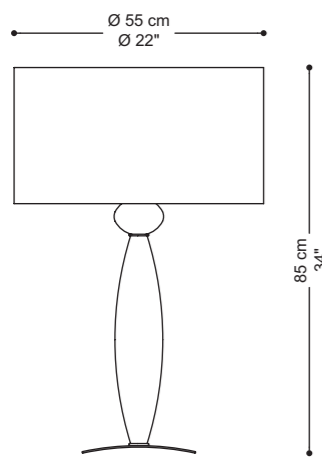

P/ 55 | 1 x MAX 100W E27 | CE ∇ \square

Vetro/Glass



DA

PA

Struttura/Metalwork

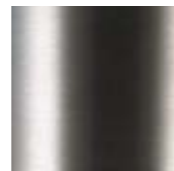

3S



Vanity S



Vanity P



Vanity S

CA' D'ORO

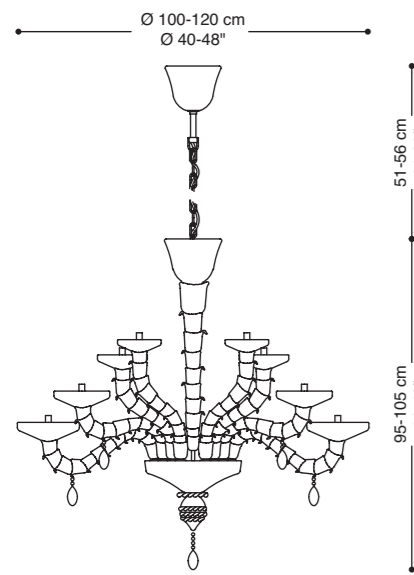

S/12-18 | n° x MAX 40W E14 |

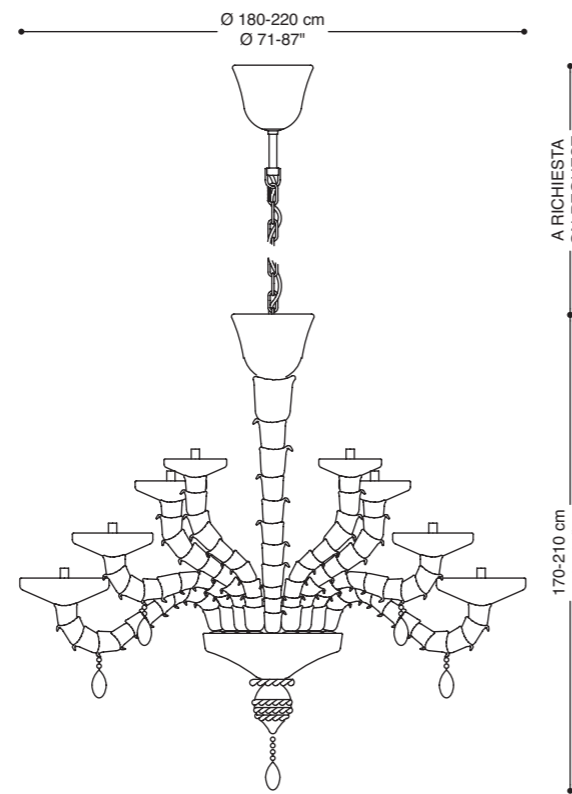

S/30-40 | n° x MAX 40W E14 |

CA' D'ORO Led RGB

S/12 | 12 x MAX 40W E14 |
 3 x MAX 2W LED RGB

S/18 | 18 x MAX 40W E14 |
 6 x MAX 2W LED RGB

Controller e centralina
NON INTEGRATI nell'apparecchio
 Controlling device and gearcase
NOT INTEGRATED in the light fitting

S/30 | 30 x MAX 40W E14 |
 18 x MAX 2W LED RGB

S/40 | 40 x MAX 40W E14 |
 18 x MAX 2W LED RGB

Controller e centralina
INTEGRATI nell'apparecchio
 Controlling device and gearcase
INTEGRATED in the light fitting

Vetro/Glass



QD

QO

PP

YY

Struttura/Metalwork



2S

3S



Ca' d'Oro S18



Ca' d'Oro S12



Ca' d'Oro S12



Ca' d'Oro Led RGB

CORONELLA FORMICHIERE

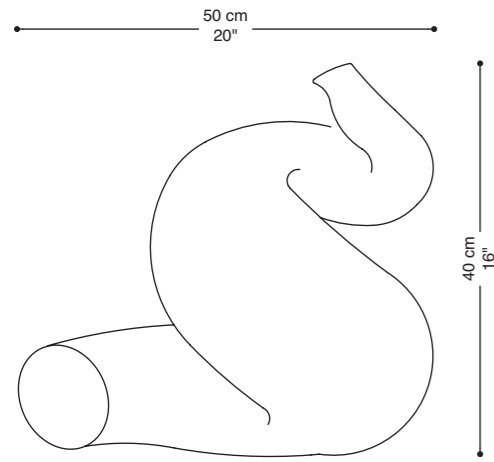

P | 1 x MAX 60W E27 | CE

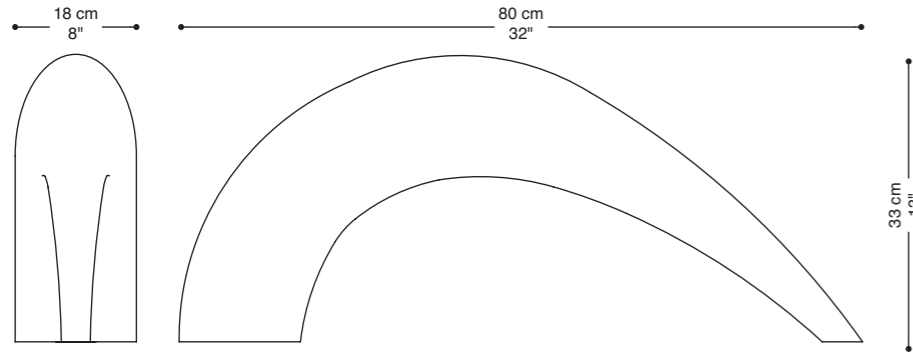

P | 1 x MAX 60W E27 | CE

Vetro/Glass
CORONELLA



DD

Struttura/Metalwork

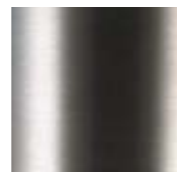

3S

FORMICHIERE



DD

PP

YY

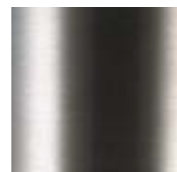

3S



Coronella



Formichiere



Formichiere

MEDUSA

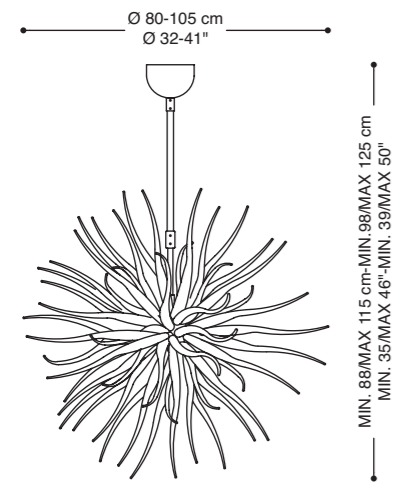

Ø 80-105 cm
Ø 32-41"

MIN. 88/MAX 115 cm-MIN. 98/MAX 125 cm
MIN. 35/MAX 46"-MIN. 39/MAX 50"

S/ 80 | 10 x MAX 25W G9
105 | 10 x MAX 25W G9

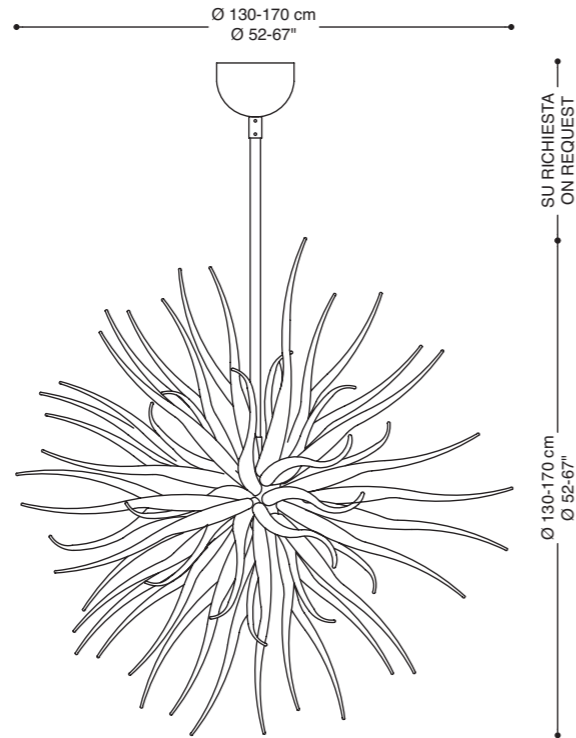

Ø 130-170 cm
Ø 52-67"

SU RICHIESTA
ON REQUEST

Ø 130-170 cm
Ø 52-67"

S/130 | 32 x MAX 25W G9
170 | 32 x MAX 25W G9

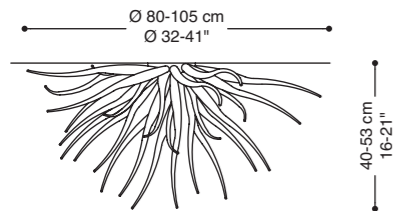

Ø 80-105 cm
Ø 32-41"

40-53 cm
16-21"

R/A 80 | 6 x MAX 25W G9
105 | 6 x MAX 25W G9

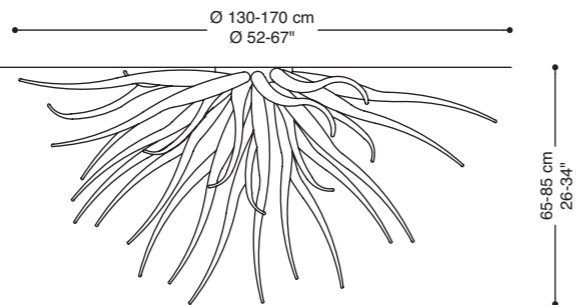

Ø 130-170 cm
Ø 52-67"

65-85 cm
26-34"

R/A 130 | 16 x MAX 25W G9
170 | 16 x MAX 25W G9



Vetro/Glass

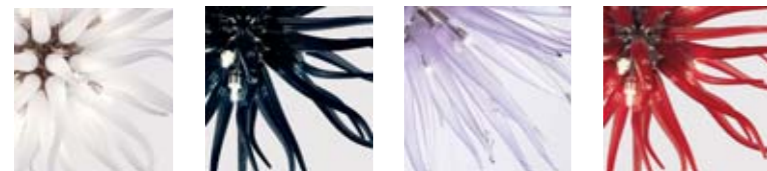

DD

PP

VV

YY

Struttura/Metalwork



3S



Medusa S



Medusa R/A



Medusa R/A



MEDUSA Swarovski

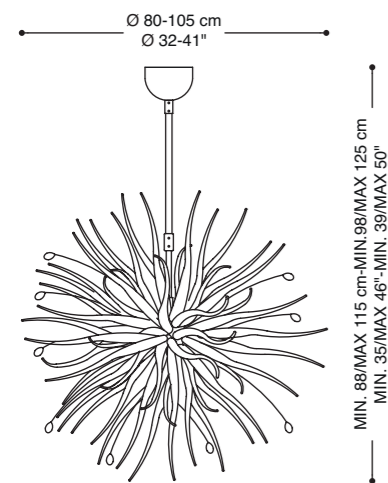

S/ 80 10 x MAX 25W G9
 105 10 x MAX 25W G9
 CE

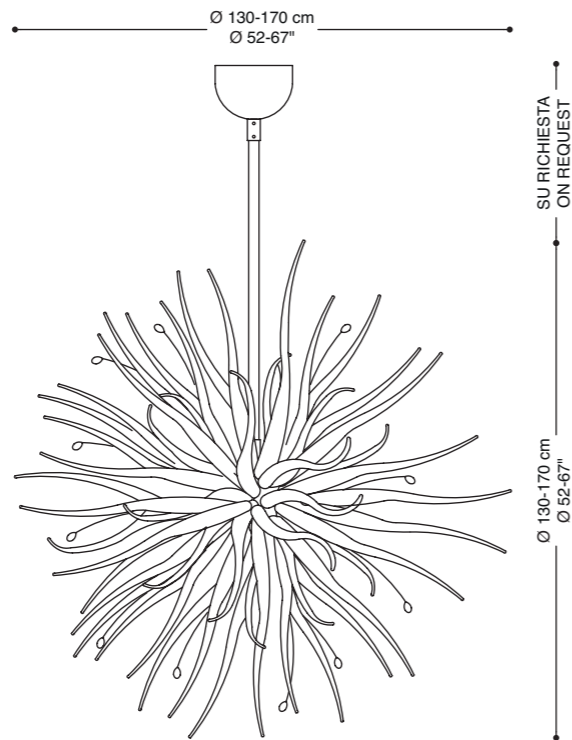

S/130 32 x MAX 25W G9
 170 32 x MAX 25W G9
 CE

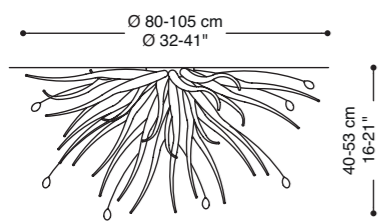

R/A 80 6 x MAX 25W G9
 105 6 x MAX 25W G9
 CE

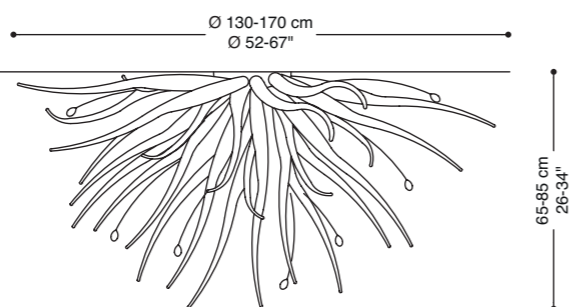

R/A 130 16 x MAX 25W G9
 170 16 x MAX 25W G9
 CE

Vetro/Glass

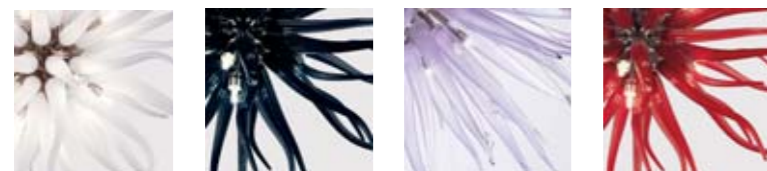

DD PP VV YY

Struttura/Metalwork



3S



Medusa S
 \varnothing 130 cm / \varnothing 52"

PLANET

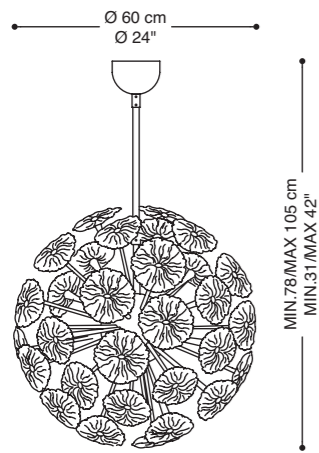

S/60 | 10 x MAX 25W G9 | CE

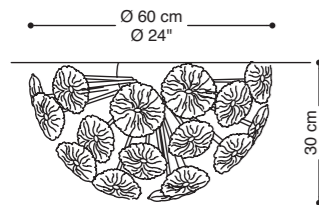

R/A 60 | 6 x MAX 25W G9 | CE

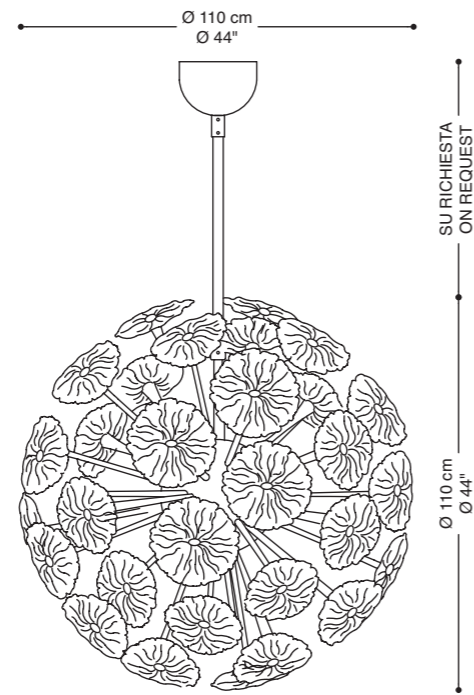

S/110 | 32 x MAX 25W G9 | CE

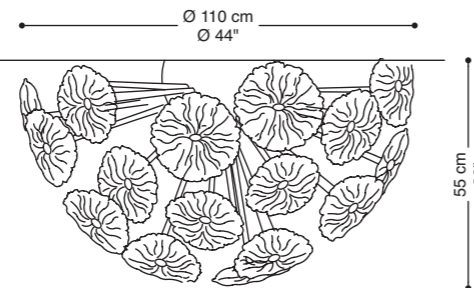

R/A 110 | 16 x MAX 25W G9 | CE

Vetro/Glass



AA



AB



AD



PA



YY



3S

Struttura/Metalwork



Planet S



Planet A/R



Planet A/R



Planet A/R



Planet A/R



Planet S



Contemporaneo

Una selezione di lampade e sculture luminose dedicate all'abitare contemporaneo, dove predominano linee sobrie e pulite. Varie soluzioni di illuminazione per ambienti domestici e destinati alla collettività, il cui ruolo è quello di decorare e personalizzare gli spazi attraverso effetti di trasparenze e colori.

Our Contemporary Design collection contains a selection of chandeliers, sconces, lamps and lighted sculptures that have been designed with today's sleek, modern environments top of mind. Whether for commercial or residential interior spaces, this collection offers an expansive selection of works, which will personalize any space with color, shape and texture.

DOLLY

DOLLY MAXI

OBELISCO

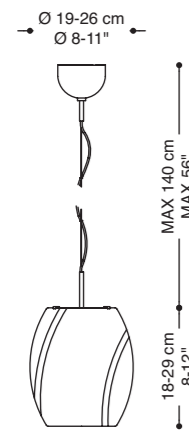

S/ piccola | 1 x MAX 60W E14 | CE
 grande | 1 x MAX 100W E27

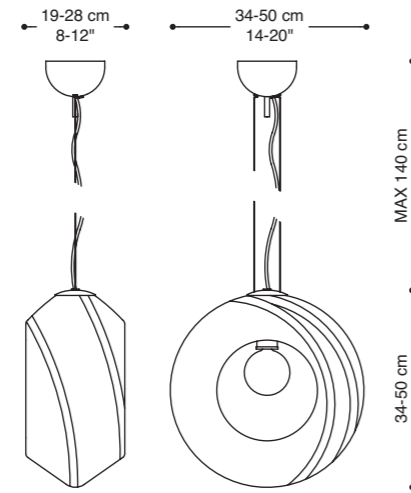

S MAXI / piccola | 1 x MAX 60W E27 | CE
 grande | 1 x MAX 150W E27

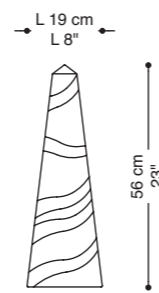

P | 1 x MAX 60W E14 | CE

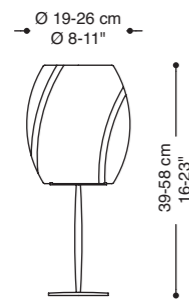

P/ piccola | 1 x MAX 40W E14 | CE
 grande | 1 x MAX 100W E27

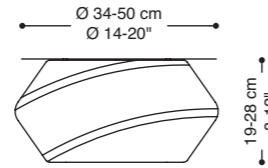

R MAXI / 34 | 1 x MAX 100W E27 | CE
 50 | 1 x MAX 150W E27

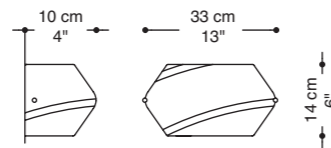

A MAXI / AL | 1 x MAX 100W AL R7S | CE



Dolly S



Dolly P AB

Vetro/Glass
DOLLY

Vetro/Glass
DOLLY MAXI / OBELISCO

Struttura/
Metalwork



AN AY AB AB AN AY 3S



Dolly Maxi R



Dolly Maxi A



Obelisco



Dolly Maxi S

MISSES

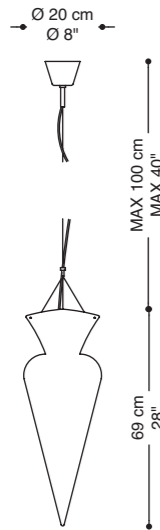

S | 1 x MAX 100W E27 alog | CE

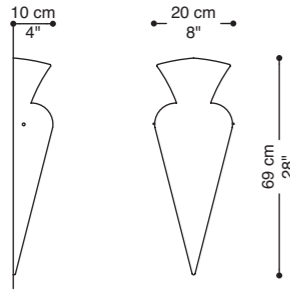

A | 1 x MAX 100W AL R7S | CE

Vetro/Glass



DD

Struttura/Metalwork

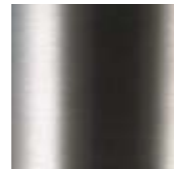

3S



Misses S



Misses A

GHEISA

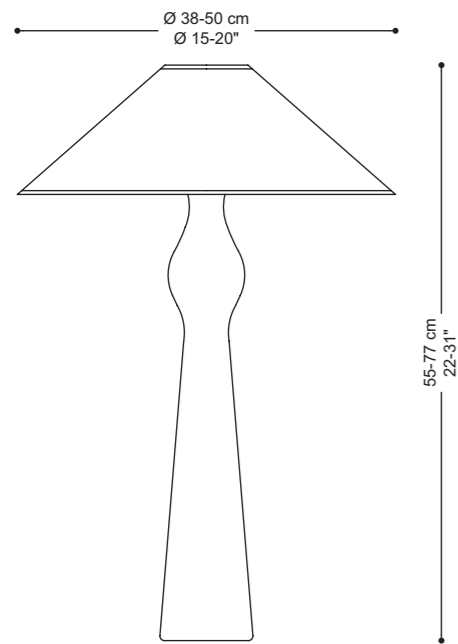

L / Ø 38 | 1 x MAX 60W E27
L / Ø 50 | 1 x MAX 100W E27

CE

Vetro/Glass



YY

Struttura/Metalwork

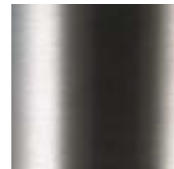

3S



Gheisa

LOLITA

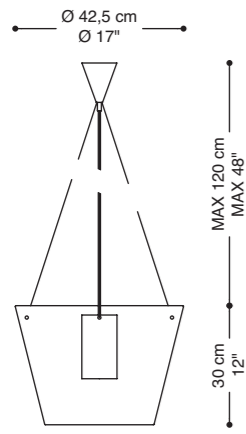

S | 1 x MAX 150W E27 alog | CE

Vetro/Glass



AB

AY

Struttura/Metalwork

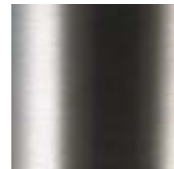





3S

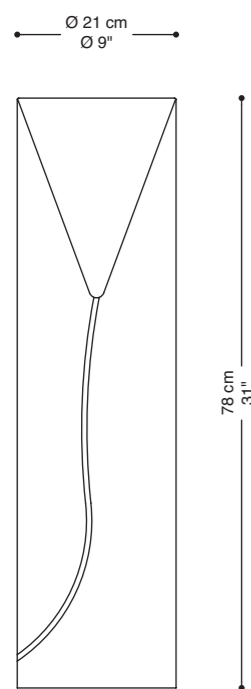

Lolita S

STILO



P |  1 x MAX 100W E27 |  

Vetro/Glass



AB



AY

Struttura/Metalwork

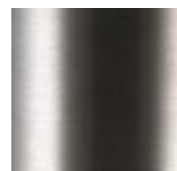

3S

Stilo P



BALLOON

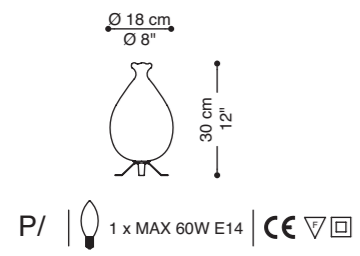
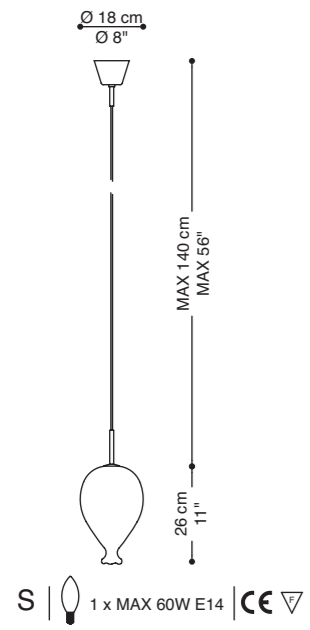

Vetro/Glass



AB

AD

AY

Struttura/Metalwork

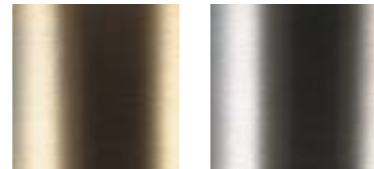

2S

3S

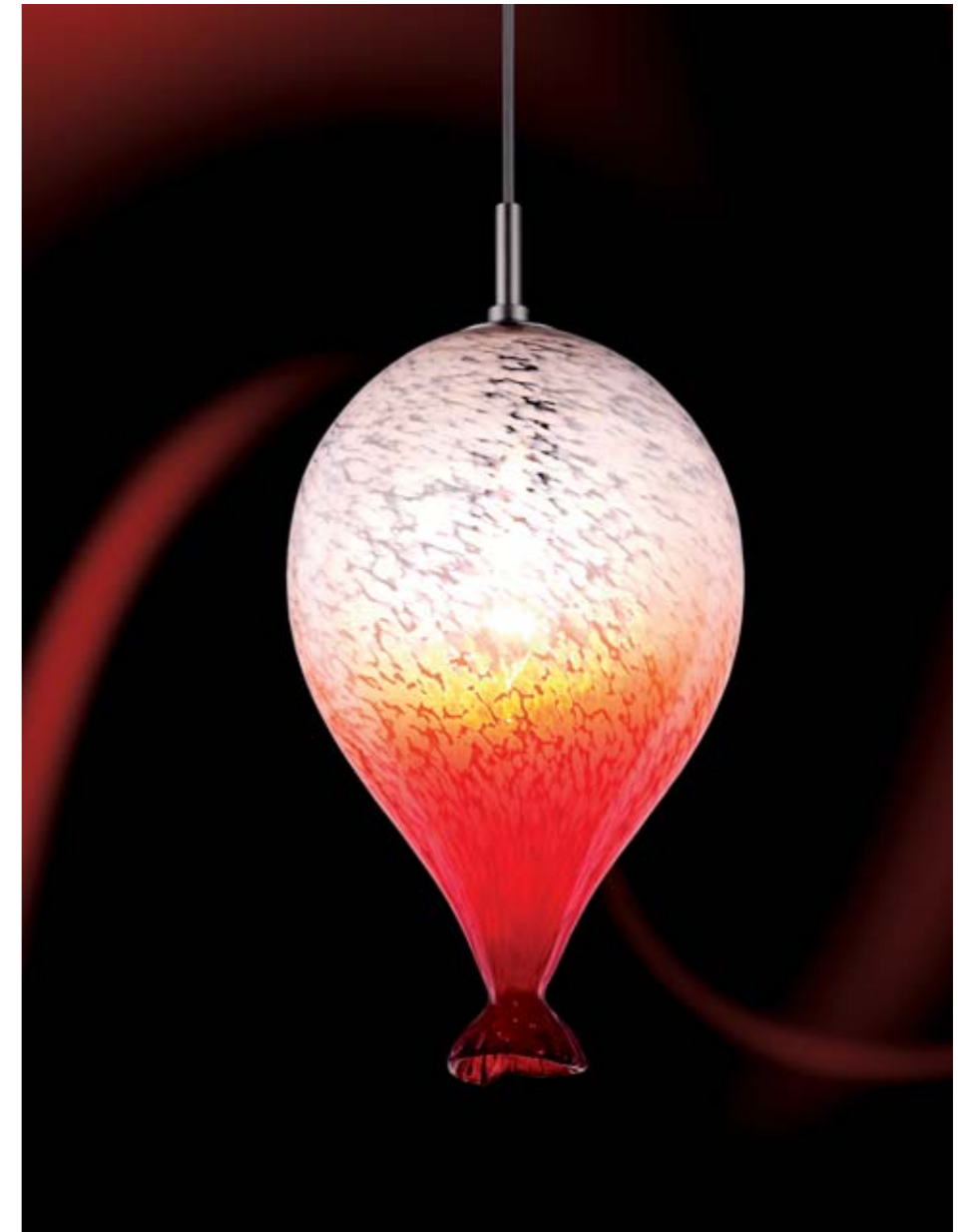

Balloon S



Balloon P

PERLA

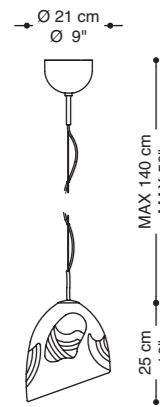

S | 1 x MAX 100W E27 | CE

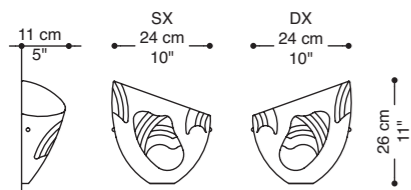

A/AL | 1 x MAX 100W AL R7S | CE (0.3m)

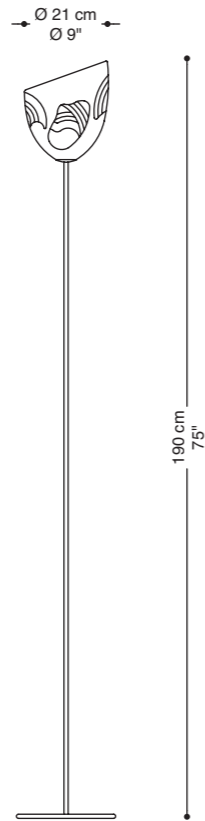

T | 1 x MAX 150W E27 alog | CE

Vetro/Glass



EE

Struttura/Metalwork

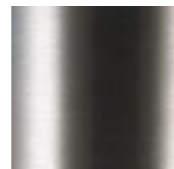

3S



Perla S



Perla A



Perla T

MAMBO

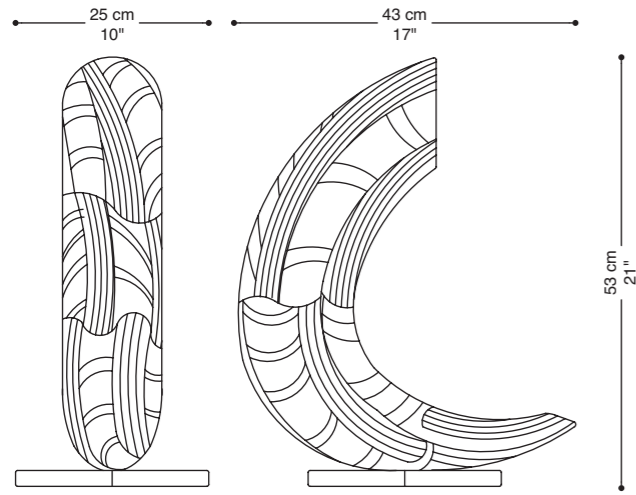

P/A | 1 x MAX 40W E14 | CE

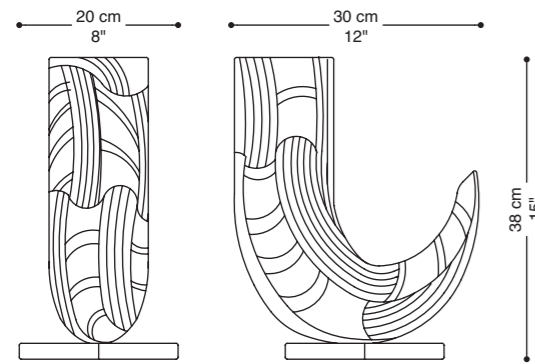

P/B | 1 x MAX 40W E14 | CE

Vetro/Glass



EE

BANDOLERO

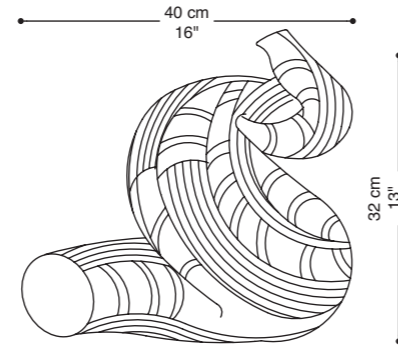

P | 1 x MAX 40W E14 | CE

Struttura/Metalwork



3L

Mambo



Bandolero



QUEEN

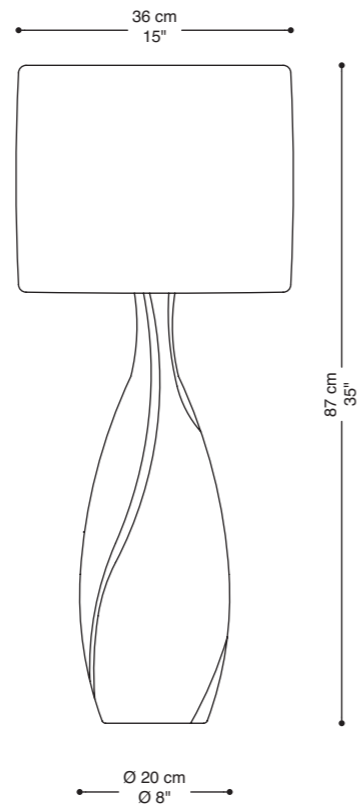
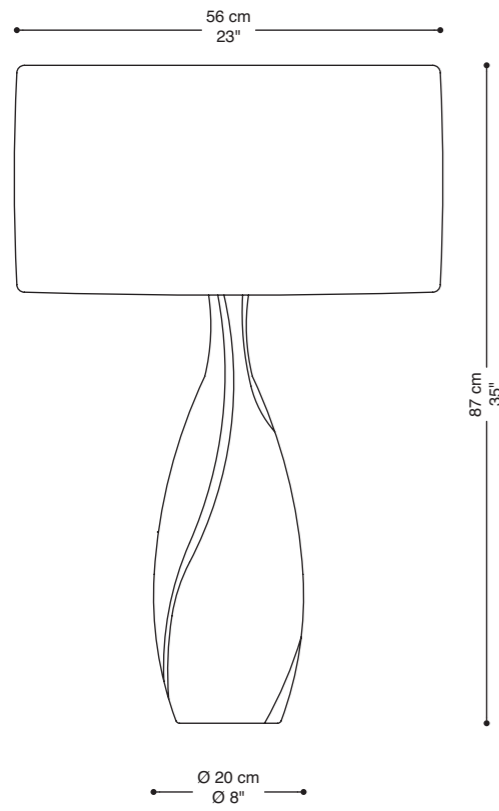

P | 1 x MAX 100W E27 | CE

Vetro/Glass



YP

Struttura/Metalwork

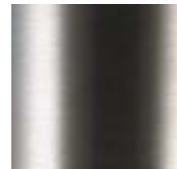

3S



Queen P

SINTESI

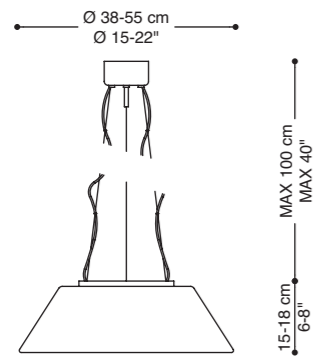

S/ AL Ø 38 | 1 x MAX 200W AL R7S | CE
 AL Ø 55 | 1 x MAX 300W AL R7S

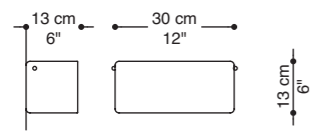

A/ AL | 1 x MAX 100W AL R7S | Ø 0.3 m | CE



Sintesi S



Sintesi A

Vetro/Glass

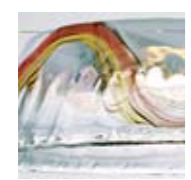

EE

Struttura/Metalwork

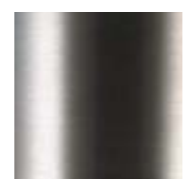

3S

GENIUS

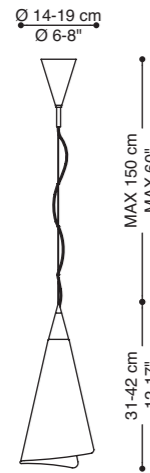

S/ Ø 14 | 1 x MAX 60W E14
 Ø 19 | 1 x MAX 100W E27

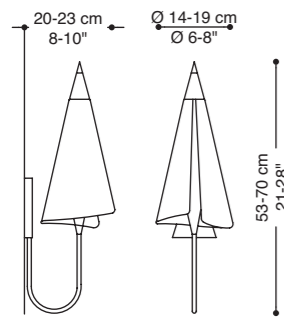

A/ Ø 14 | 1 x MAX 60W E14
 Ø 19 | 1 x MAX 100W E27

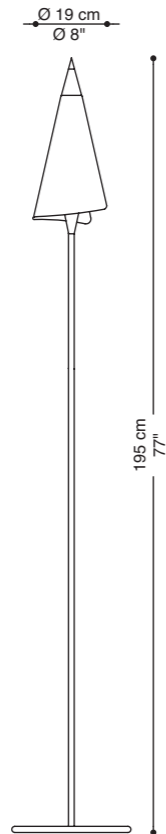

T | 1 x MAX 100W E27

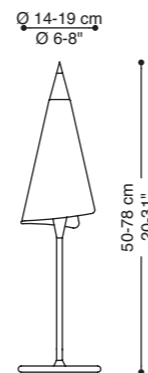

P/ Ø 14 | 1 x MAX 60W E14
 Ø 19 | 1 x MAX 100W E27



Vetro/Glass



AB

AD

ND

Struttura/Metalwork

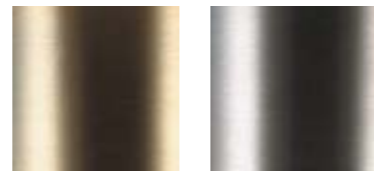

2S

3S



Genius T



Genius S



Genius A



Genius P



Genius S

GENIUS TECNO

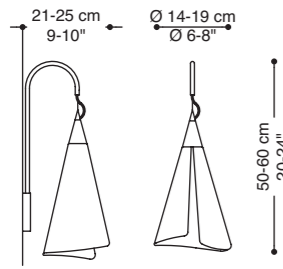

A/ Ø 14 | 1 x MAX 60W E14
 Ø 19 | 1 x MAX 100W E27

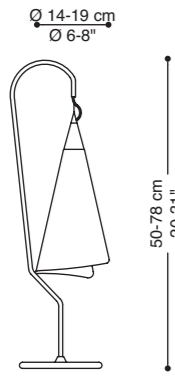

P/ Ø 14 | 1 x MAX 60W E14
 Ø 19 | 1 x MAX 100W E27

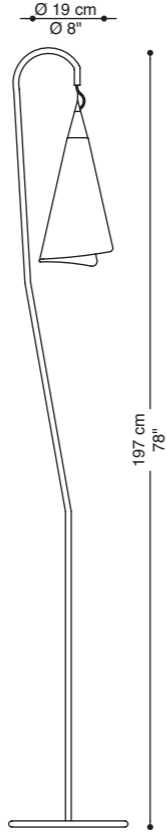

T | 1 x MAX 100W E27



Vetro/Glass



AB

AD

ND

Struttura/Metalwork

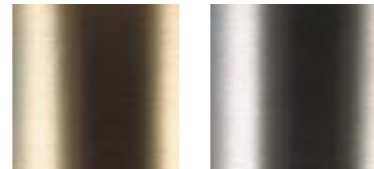

2S

3S



Genius Tecno A



Genius Tecno P



Genius Tecno T

ALBATROS

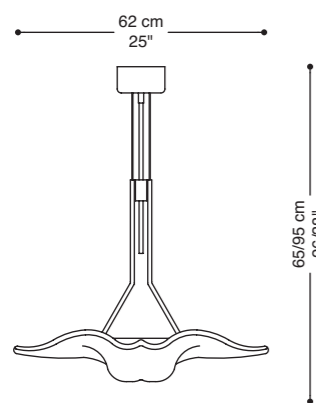

S/ AL | 1 x MAX 300W AL R7S | $\phi_{0.3m}$ | CE

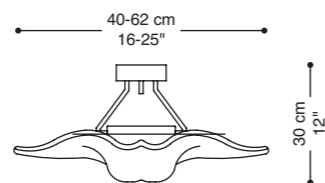

R/ AL 40 | 1 x MAX 300W AL R7S | $\phi_{0.3m}$ | CE
 AL 62 | 1 x MAX 300W AL R7S | $\phi_{0.3m}$ | CE

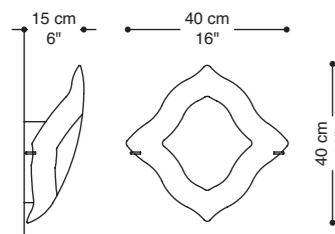

A/ AL | 1 x MAX 200W AL R7S | $\phi_{0.5m}$ | CE

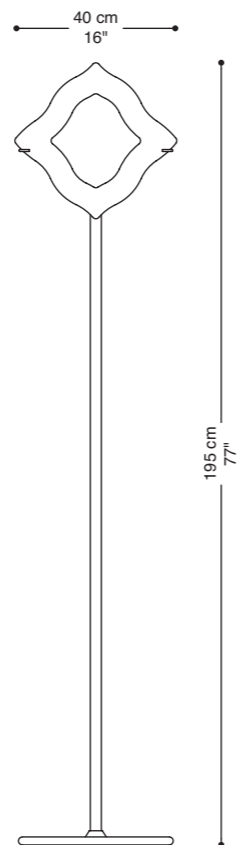

T/ AL | 1 x MAX 200W AL R7S | $\phi_{0.5m}$ | CE

Vetro/Glass



DA

DB

DN

Struttura/Metalwork



2S

3S

9



Albatros S



Albatros R



Albatros T



Albatros A



Albatros S

AQUILONE

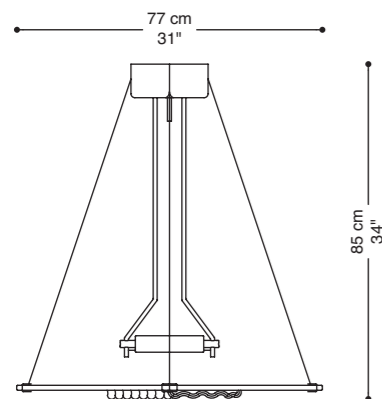

S/ AL | 1 x MAX 300W AL R7S | $\text{C}_{0.3\text{m}}$ | CE

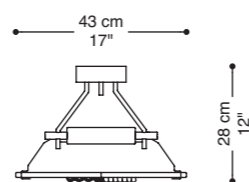

R/ AL 43 | 1 x MAX 300W AL R7S | $\text{C}_{0.3\text{m}}$ | CE

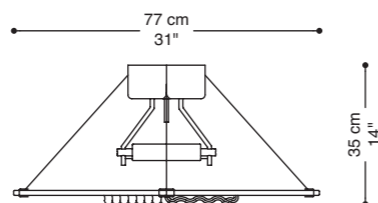

R/ AL 77 | 1 x MAX 300W AL R7S | $\text{C}_{0.3\text{m}}$ | CE

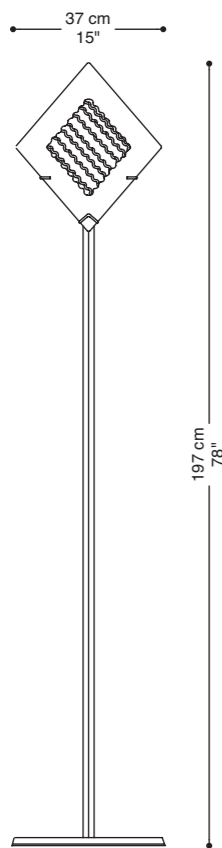

T/ AL | 1 x MAX 300W AL R7S | $\text{C}_{0.3\text{m}}$ | CE

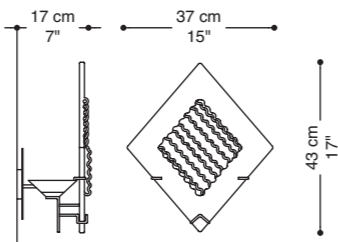

A/ AL | 1 x MAX 300W AL R7S | $\text{C}_{0.3\text{m}}$ | CE



Vetro/Glass

Struttura/Metalwork

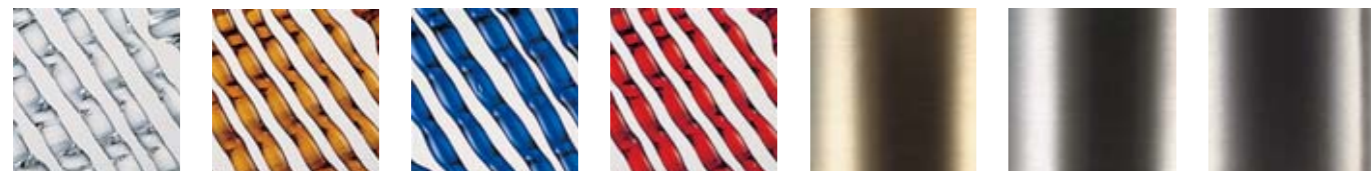

DA DB DN DY 2S 3S 9

Aquilone S



Aquilone R A



Aquilone R B



Aquilone A

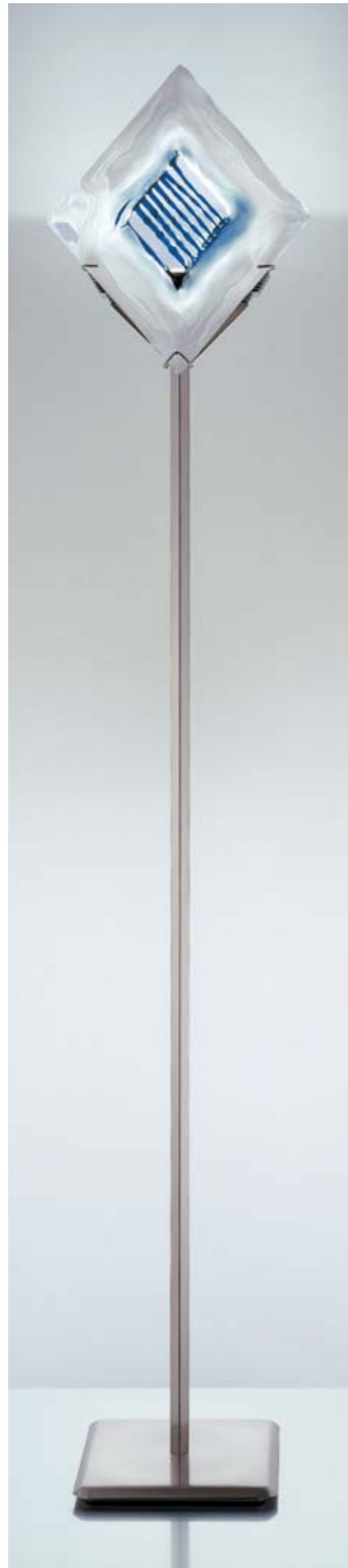

Aquilone T



Aquilone S

COMETA

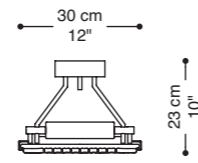
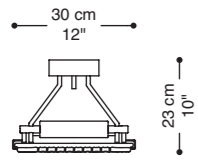

R/AL | 1 x MAX 300W AL R7S | $\varnothing_{0.3m}$ | CE

R/AL | 1 x MAX 200W AL R7S | $\varnothing_{0.3m}$ | CE

Vetro/Glass COMETA



AA AD AY



AN

RUMBA

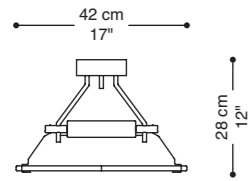

R/AL | 1 x MAX 150W AL R7S | $\varnothing_{0.3m}$ | CE

Vetro/Glass RUMBA



AB AE DD

Struttura/Metalwork



2L 2S 3L 3S







Cometa R

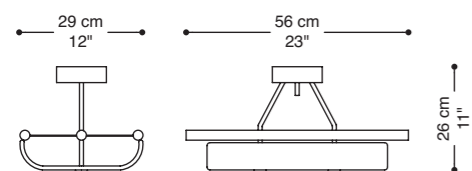

Rumba R

ORIONE



R/AL |  1 x MAX 300W AL R7S |  



Orione R

Vetro/Glass



DD

Struttura/Metalwork

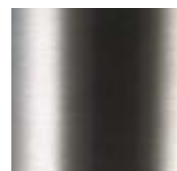

3S

SQUARED

L 50x50 cm
L 20x20"

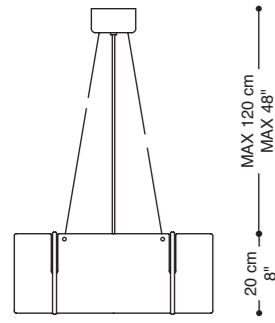

S | 1 x MAX 150W E27 alog | CE

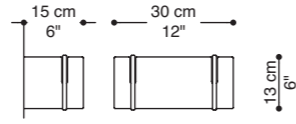

A/ AL | 1 x MAX 100W AL R7S | CE



Squared S

Vetro/Glass



DA

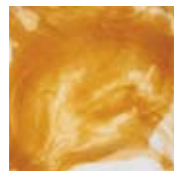

DB

Struttura/Metalwork

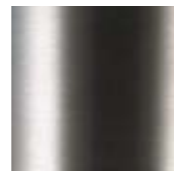

3S



Squared A

GALAXY

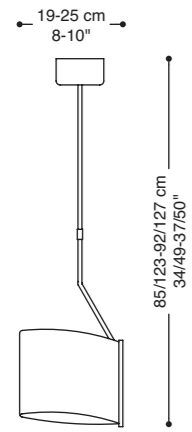

S/ Ø 19 | 1 x MAX 150W E27 alog
 Ø 25 | 1 x MAX 250W E27 alog

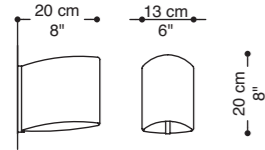

A | 1 x MAX 100W E14 alog

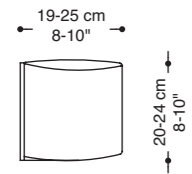

P/ Ø 19 | 1 x MAX 100W E27
 Ø 25 | 1 x MAX 100W E27

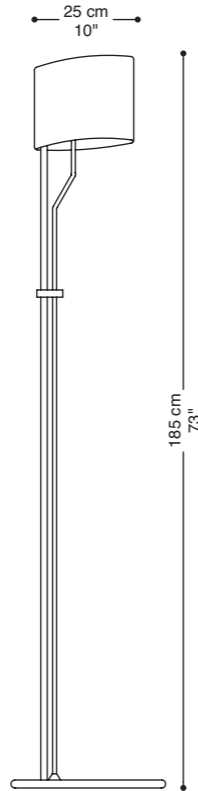

T/ AL | 1 x MAX 250W E27 alog



Vetro/Glass



DD

Struttura/Metalwork



3S



Galaxy T



Galaxy S



Galaxy A



Galaxy P



Galaxy S

PULSAR

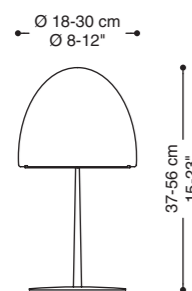

P/ Ø 18 | 1 x MAX 40W E14
Ø 30 | 1 x MAX 100W E27



SAROS

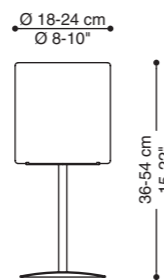

P/ Ø 18 | 1 x MAX 40W E14
Ø 24 | 1 x MAX 100W E27



Vetro/Glass



DD

Struttura/Metalwork

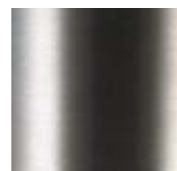

3S



Pulsar P



Saros P

AIRONE

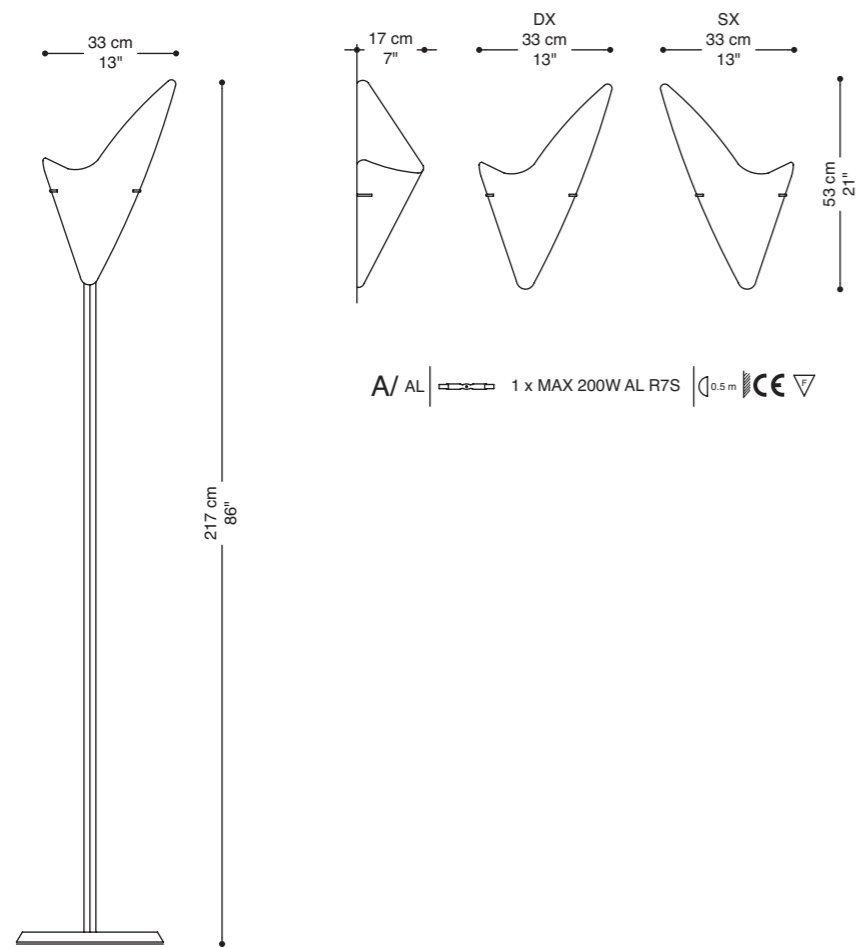

A/ AL | 1 x MAX 200W AL R7S | ϕ 0.5 m | CE

T/ AL | 1 x MAX 200W AL R7S | ϕ 0.3 m | CE



Airone A



Airone T

Vetro/Glass



DD

Struttura/Metalwork

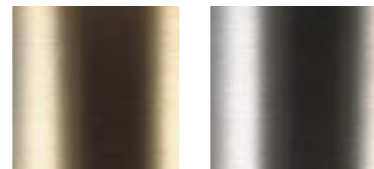

2S

3S

CORMORANO

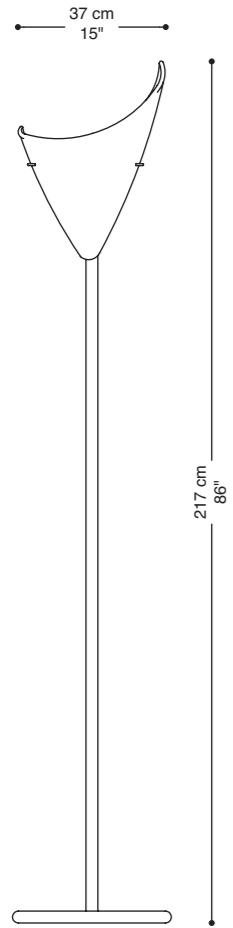

T/ AL |  1 x MAX 200W AL R7S | ϕ 0.3m | CE

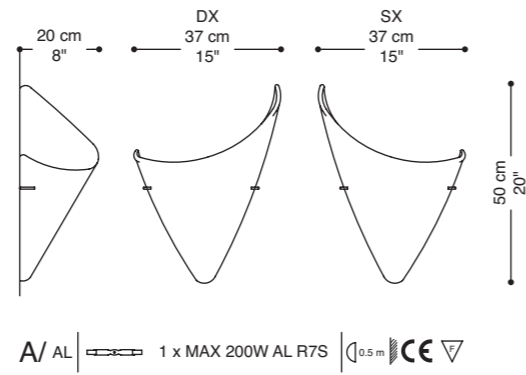

A/ AL |  1 x MAX 200W AL R7S | ϕ 0.5m | CE



Cormorano A



Cormorano T

Vetro/Glass



DD

Struttura/Metalwork

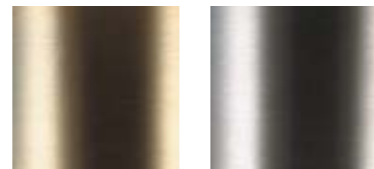

2S

3S

APACHE

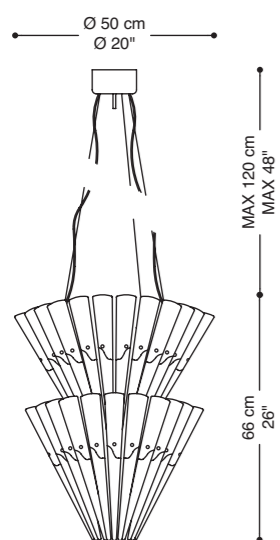

S/ Ø 50 | 2 x MAX 300W AL R7S | CE

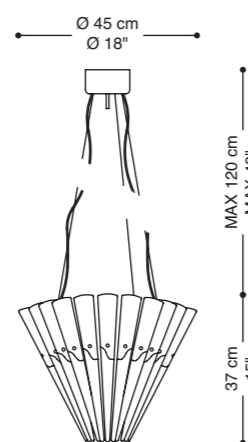

S/ Ø 45 | 1 x MAX 300W AL R7S | CE

Vetro/Glass

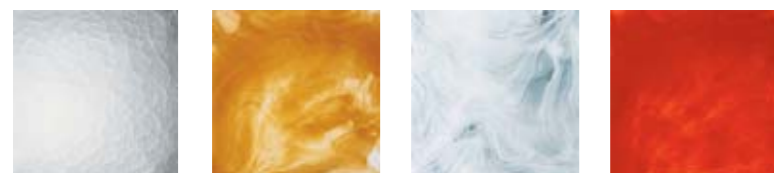

AA

AB

AD

YY

Struttura/Metalwork



3S



Apache S

NADIR

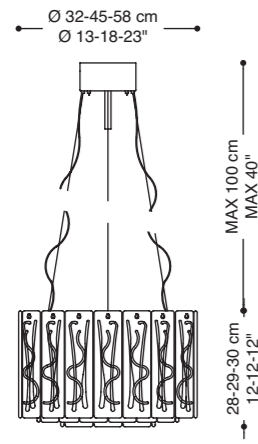

S/ 32-45-58 | 1 x MAX 300W AL R7S | CE

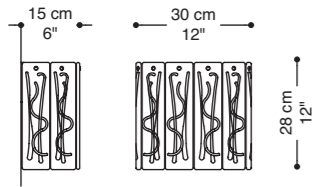

A/ 30 | 1 x MAX 100W AL R7S | CE

Vetro/Glass



AB

AD

AN

Struttura/Metalwork



2L

3L





Nadir S

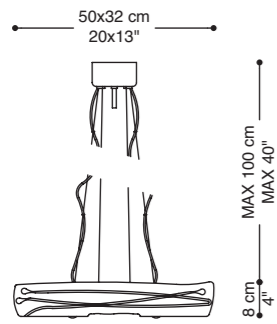

Nadir A

INTRIGO



S/AL  1 x MAX 300W AL R7S 

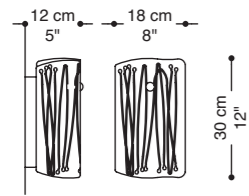

A/AL  1 x MAX 100W AL R7S 

Vetro/Glass



DB

DN

Struttura/Metalwork

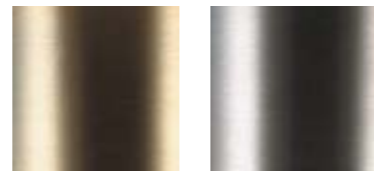

2S

3S







Intrigo S



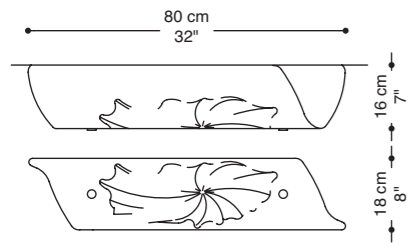



Intrigo A

ATMOSPHERE

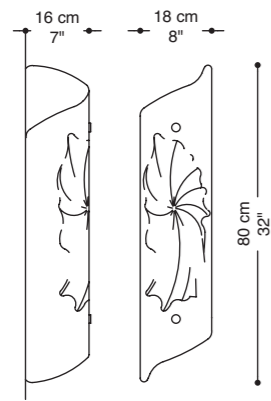

R/AL |  2 x MAX 100W AL R7S |  



A/AL |  2 x MAX 150W AL R7S |  

Vetro/Glass



QB

QD

Struttura/Metalwork

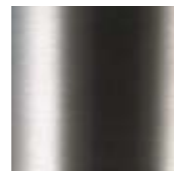

3S



Atmosphere R



Atmosphere A

MARILYN

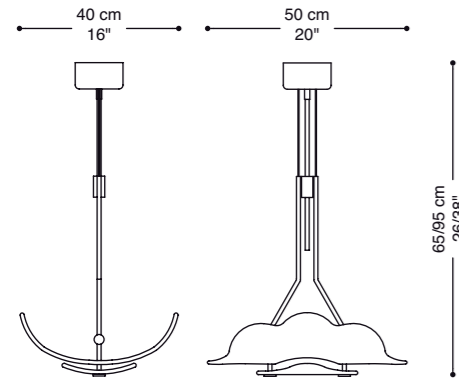

S/ AL | 1 x MAX 300W AL R7S | CE

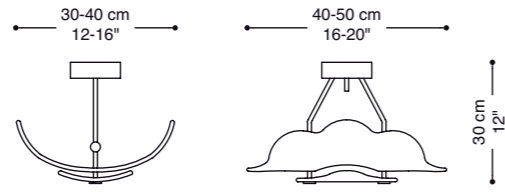

R/ AL 40-50 | 1 x MAX 300W AL R7S | CE

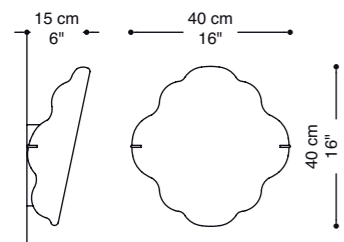

A/ AL | 1 x MAX 200W AL R7S | CE

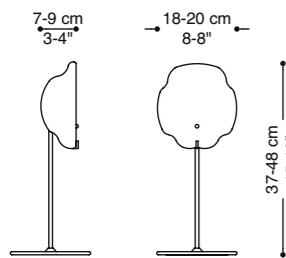

P/ 18 | 1 x MAX 40W E14 | CE
20 | 1 x MAX 60W E27 | CE

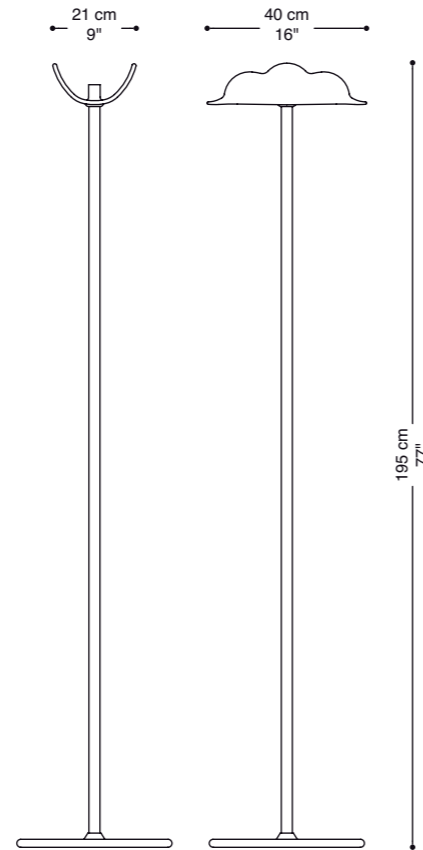

T | 1 x MAX 250W E27 alog | CE

Vetro/Glass



DD

Struttura/Metalwork

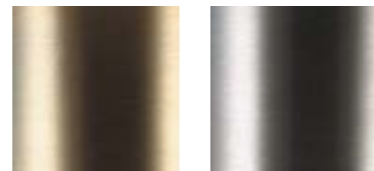

2S

3S



Marilyn S



Marilyn T



Marilyn R



Marilyn A



Marilyn P



Marilyn S

THAITI

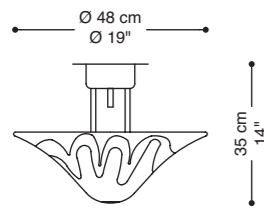

R | 5 x MAX 60W E14 | CE

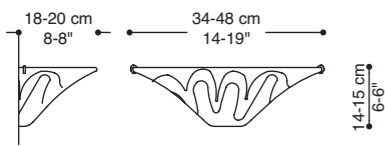

A/ AL 34 | 1 x MAX 100W AL R7S | CE
AL 48 | 1 x MAX 200W AL R7S

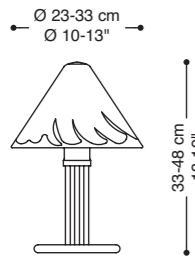

P/ 23 | 1 x MAX 40W E14 | CE
33 | 1 x MAX 100W E27

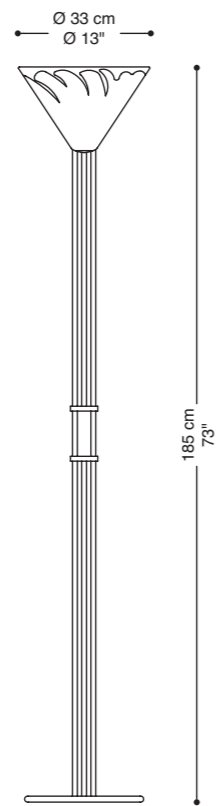

T/AL | 1 x MAX 250W E27 alog | CE

Vetro/Glass

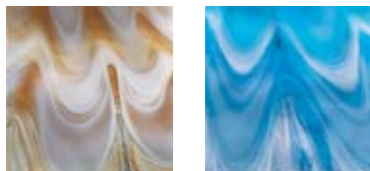

BD

ND

Struttura/Metalwork

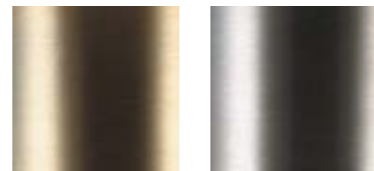

2S

3S



Thaiti R



Thaiti A



Thaiti P



Marilyn T

FILE

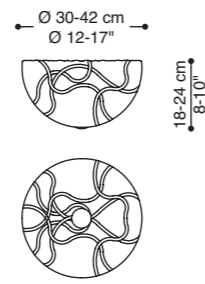
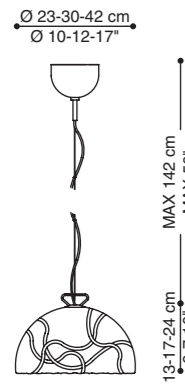

R/ Ø 30-42 | 3 x MAX 40W E14 | CE

S/ Ø 23 | 1 x MAX 100W E27 | CE
 Ø 30-42 | 1 x MAX 100W E27

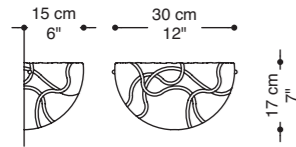

A/ AL 30 | 1 x MAX 100W AL R7S | CE

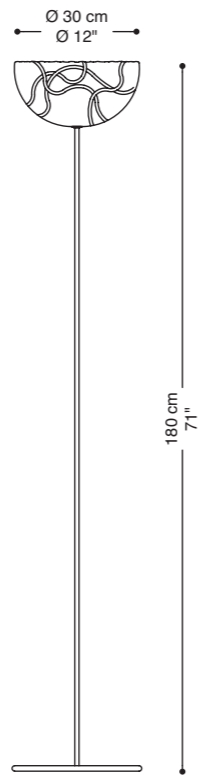

T/ AL | 1 x MAX 250W E27 alog | CE



Filè S



Filè R



Filè A



Filè T

Vetro/Glass



AD

Struttura/Metalwork

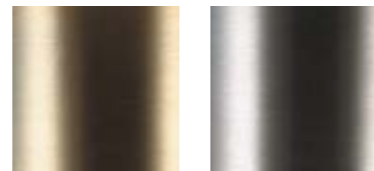

2S

3S

BORA BORA

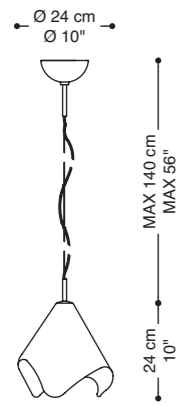

S | 1 x MAX 100W E27 | CE

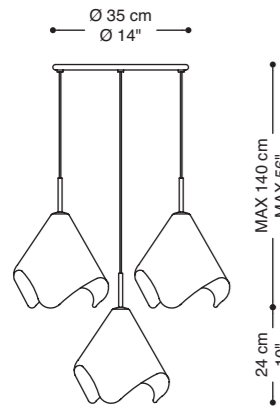

S/3 | 3 x MAX 100W E27 | CE

Vetro/Glass



AD

Struttura/Metalwork

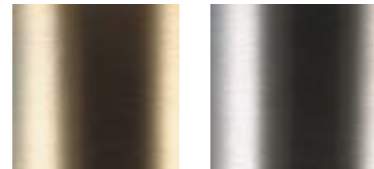

2S

3S



Bora Bora S

697

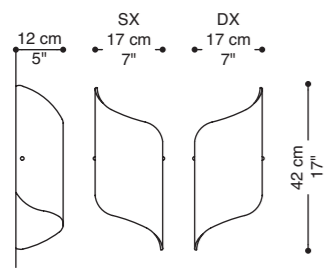

A/AL | 1 x MAX 250W E27 alog | CE

Vetro/Glass



AD

Struttura/Metalwork



2L

3L

697 A

[Torna all'indice](#)
[Back to index](#)

688

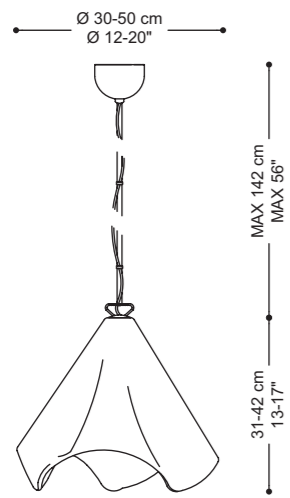

S/ \varnothing 30 | 1 x MAX 100W E27
 \varnothing 50 | 1 x MAX 100W E27

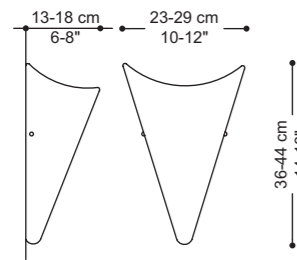

A/ AL 23 | 1 x MAX 100W AL R7S
 AL 29 | 1 x MAX 100W AL R7S



Vetro/Glass

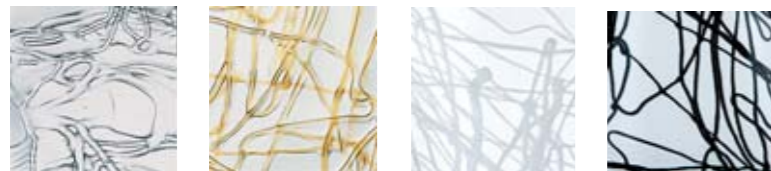

HA

HB

HD

HP

Struttura/Metalwork



2L

3L



688 S



688 A

681

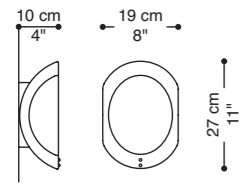

A | 2 x MAX 40W E14 | CE

702

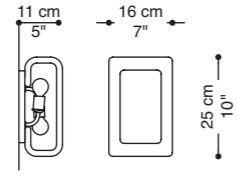

A | 2 x MAX 40W E14 | CE

825

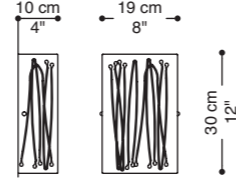

A | 2 x MAX 60W E14 | CE



681 A



702 A

Vetro/Glass
681



AB AD

Vetro/Glass
702

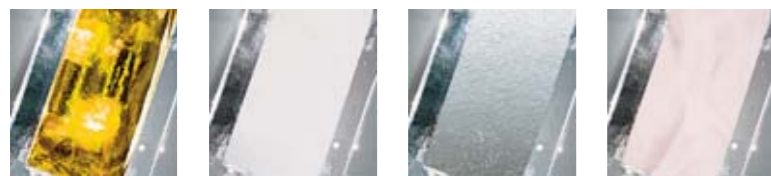

AB AD AF AX

Vetro/Glass
825



HA HB

Struttura/Metalwork

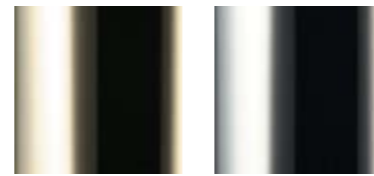

2L 3L

Struttura/Metalwork



2L 3L

Struttura/Metalwork



2L 3L



825 A

629

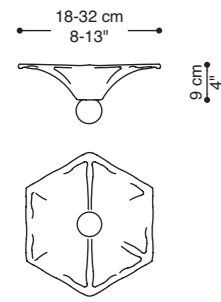

R/ 18 | 1 x MAX 60W E14
 32 | 1 x MAX 100W E27



684

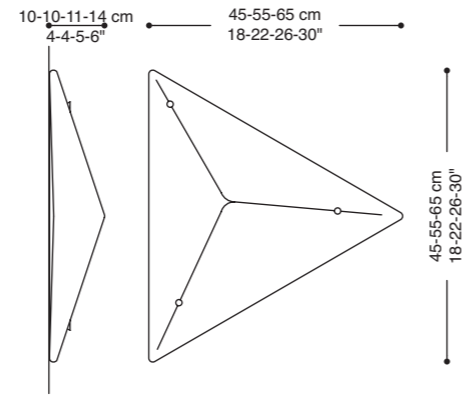

A/ 45-55 | 3 x MAX 40W E14
 65-75 | 3 x MAX 100W E27



629 R

Vetro/Glass
629



AB

AD

Struttura/Metalwork



2L

3L

Vetro/Glass
684



KB

KD

Struttura/Metalwork



2L

3L



684 A

602

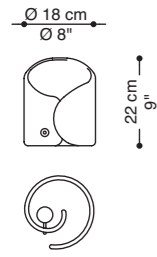

P | 1 x MAX 40W E14 | CE

Vetro/Glass



AB

AD

AE

AX

Vetro/Glass



HA

HB

HD

HP

Struttura/Metalwork



RR

2L

3L



602

EGEO

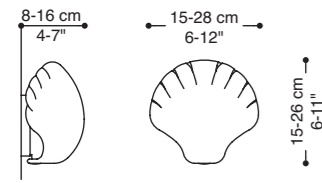

A/ 15 | 1 x MAX 60W E14
28 | 1 x MAX 60W E27 | CE

MEDITERRANEO

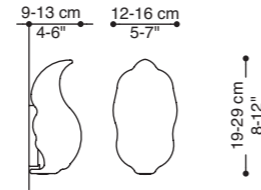

A/ 12 | 1 x MAX 60W E14
16 | 1 x MAX 60W E27 | CE



Egeo A



Mediterraneo A

Vetro/Glass



DD

XX

Struttura/Metalwork



2L

3L

737

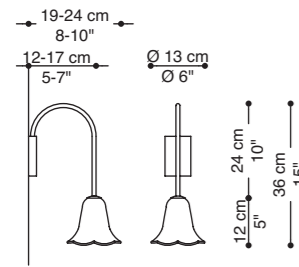

A/ braccio | 1 x MAX 60W E14 | CE

738

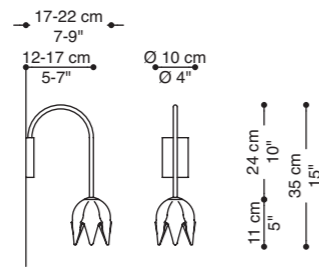

A/ braccio | 1 x MAX 60W E14 | CE

739

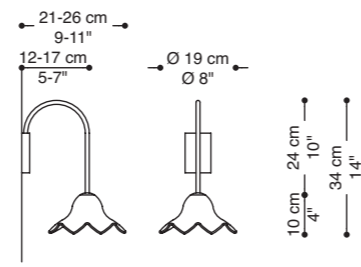

A/ braccio | 1 x MAX 60W E14 | CE

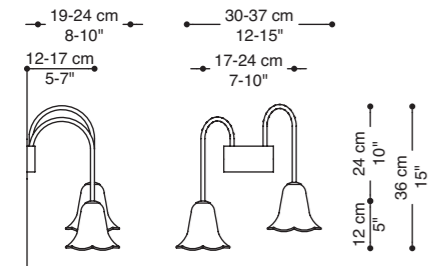

A/ doppio braccio DX | 2 x MAX 60W E14 | CE

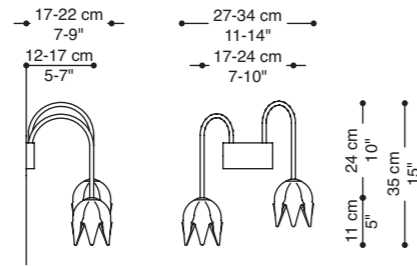

A/ doppio braccio DX | 2 x MAX 60W E14 | CE

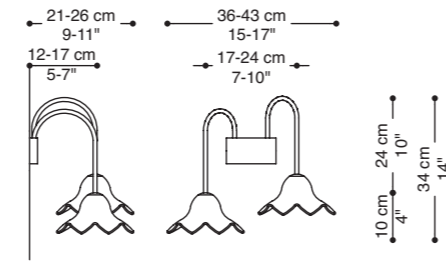

A/ doppio braccio DX | 2 x MAX 60W E14 | CE

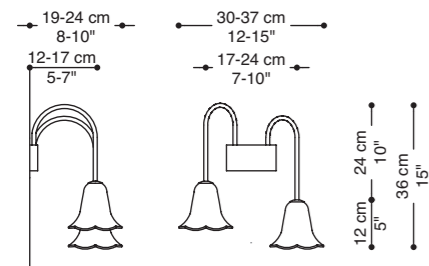

A/ doppio braccio SX | 2 x MAX 60W E14 | CE

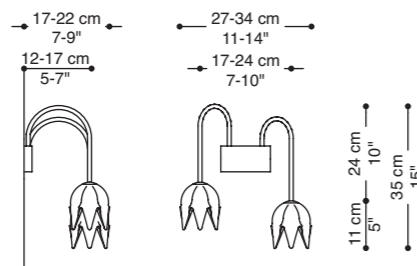

A/ doppio braccio SX | 2 x MAX 60W E14 | CE

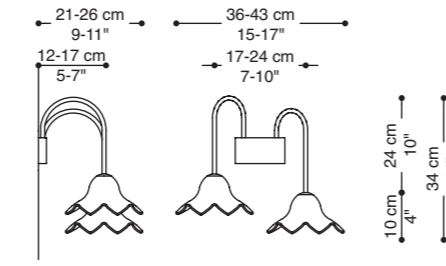

A/ doppio braccio SX | 2 x MAX 60W E14 | CE



737 A



737 A



738 A



739 A

Vetro/Glass



AB



AD



AE



AX



KD



2L



3L

Struttura/Metalwork

EXCALIBUR

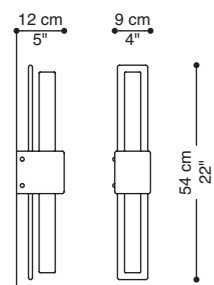

A |  1 x MAX 60W S14d | **CE** ▽

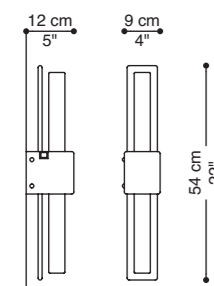

A/c/tasto |  1 x MAX 60W S14d | **CE** ▽

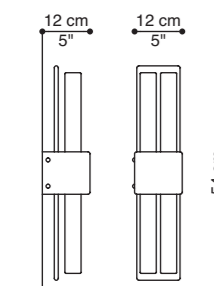

A/doppio |  2 x MAX 60W S14d | **CE** ▽

Vetro/Glass



BB



DD



NN



XX



YY



3L

Struttura/Metalwork



Excalibur

101

102

10 cm
4"



10 cm
4"



12 cm
5"



101/ FARETTO |  1 x MAX 35W GU10 - 230V
 foro incasso Ø 72-75 mm.
 spessore soffitto MIN. 10 mm. - MAX 25 mm.
 profondità incasso 100 mm.



17 cm
7"

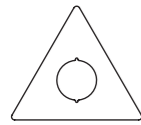

102/ FARETTO |  1 x MAX 35W GU10 - 230V
 foro incasso Ø 72-75 mm.
 spessore soffitto MIN. 10 mm. - MAX 25 mm.
 profondità incasso 100 mm.

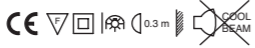

Vetro/Glass



AE



BB



DD



KD



NN



RR



XX

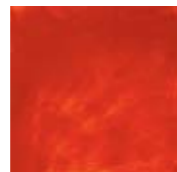

YY

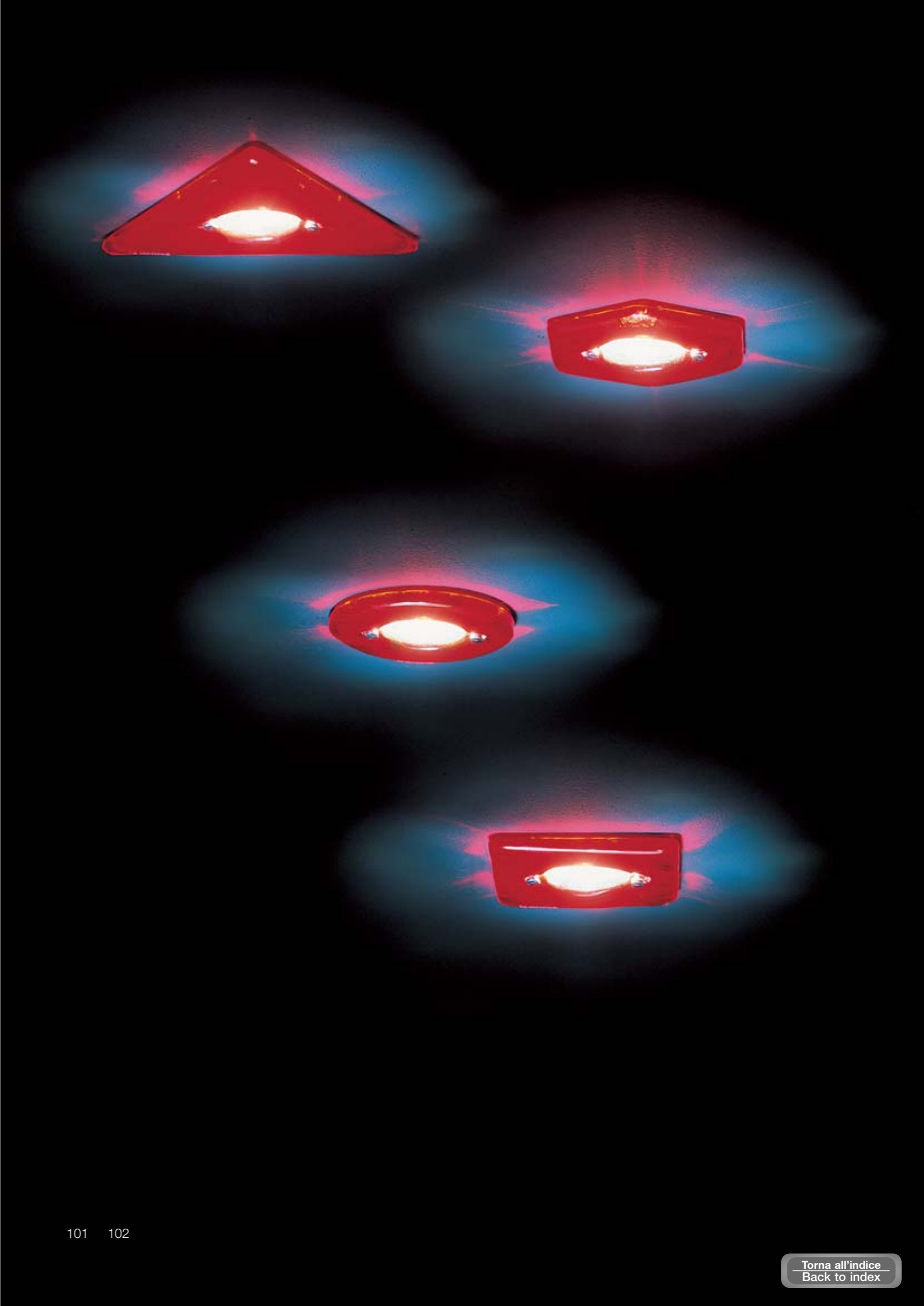

SPECCHI BURANO

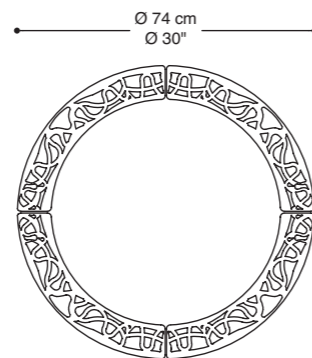
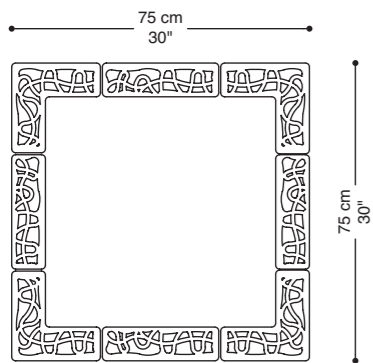
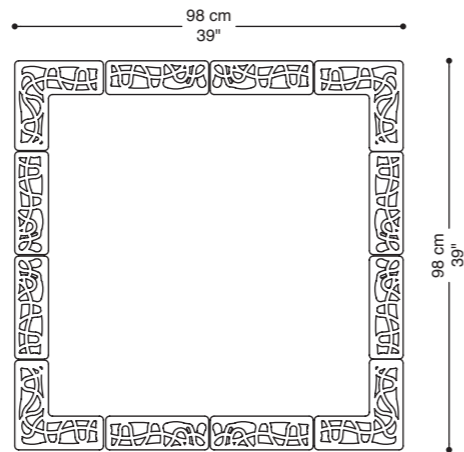
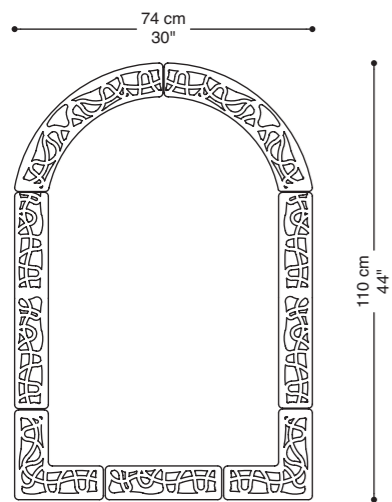
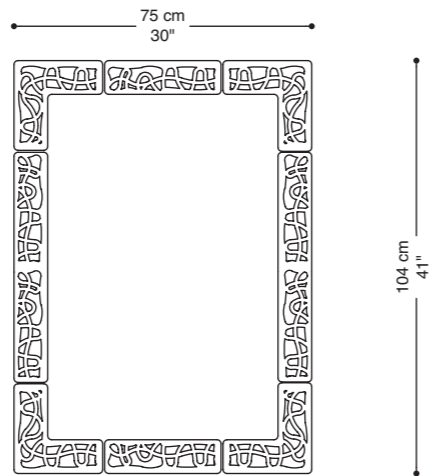
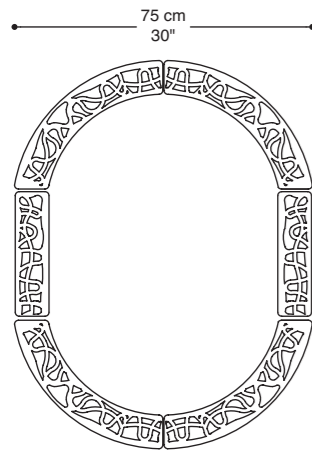

Vetro/Glass



AA AB AD PP BO NN YY RR



Burano rettangolare



Burano ovale



Burano arco



Burano quadrato



Burano rotondo



FORMELLE

INTERA

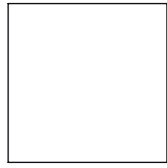

FASCIA

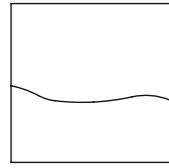

ANGOLO

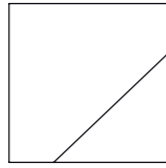

BOLLO

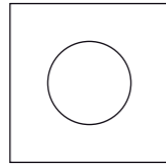

Dimensioni

20 x 20 cm - 8 x 8"
25 x 25 cm - 10 x 10"
30 x 30 cm - 12 x 12"
35 x 35 cm - 14 x 14"
40 x 40 cm - 16 x 16"
45 x 45 cm - 18 x 18"
50 x 50 cm - 20 x 20"

Vetro/Glass



AA



AB



AD



AE



KD



KN

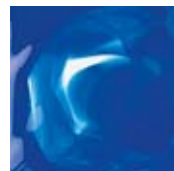

NN



RR



XX



Intera



Fascia



Angolo



Bollo



Formelle



Formelle

La riproduzione in qualsiasi formato di questo catalogo o di parte di esso è assolutamente proibita senza la previa autorizzazione scritta di **la murrina**® S.p.A.
Il logo **la murrina**® è di esclusiva titolarità e proprietà di **la murrina**® S.p.A.
Non può essere riprodotto né usato per scopi commerciali, senza il consenso scritto di **la murrina**® S.p.A.
L'azienda si riserva di modificare, in qualsiasi momento e senza nessun preavviso, le caratteristiche tecniche dei prodotti illustrati in questo catalogo.
la murrina® declina ogni responsabilità per eventuali errori di stampa presenti nel catalogo.
la murrina® lavora scrupolosamente con i designer e lo staff tecnico e ingegneristico per garantire sempre un elevato standard qualitativo per ogni singolo pezzo della propria produzione.
I materiali scelti e la componentistica elettrica sono di prima qualità. L'assemblaggio e il controllo viene eseguito in maniera rigorosa da manodopera specializzata.
La produzione del vetro soffiato può presentare alcune minime differenze di peso, colore o spessore, dovute alla elaborazione artigianale dei pezzi. Le eventuali bolle e irregolarità presenti nell'impasto non sono difetti ma caratteristiche preziose ed uniche del vetro soffiato e lavorato a mano artigianalmente.
Ogni corpo illuminante è corredato con una busta contenente un foglio di istruzioni e modalità di assemblaggio.
Modifiche e/o riparazioni di qualsiasi natura apportate al prodotto non autorizzate dopo l'acquisto o il mancato rispetto delle istruzioni di montaggio, possono compromettere la sicurezza del prodotto stesso e provocare situazioni di pericolosità per l'utente.
Pertanto **la murrina**® ne declina ogni responsabilità.
Le dimensioni riportate nei disegni tecnici dei prodotti sono espressi in centimetri e pollici.
Gli apparecchi sono forniti con lampadine.



