



ALABASTER

 **MODUL**   
ELECTRO  
[www.modulelectro.ru](http://www.modulelectro.ru)

ALABASTER

 **LEDS-C4**



## LA PIEDRA NATURAL COMO DIFUSOR DE LA LUZ

LEDS-C4 fusiona la innovación tecnológica con el arte de la escultura.

Reforzada, pulida y barnizada, la piedra de alabastro combinada con una cálida iluminación interior, ofrece unas posibilidades de aplicación infinitas. Las particulares características translúcidas de este material tamizan y difuminan la luz para eliminar el efecto duro y a veces frío de la luz directa. Las vetas y las aguas de cada piedra convierten a cada pieza en única proporcionando un aspecto de lujo, noble y cálido.

El riguroso proceso desarrollado por LEDS-C4 para la elaboración de la piedra de alabastro permite disponer de un material de excepcional calidad y gran distinción. Pues la extracción se hace, en general, a cielo abierto, con sistemas no agresivos para proteger la integridad del material.

Los productos de este catálogo, como todos los productos de LEDS-C4, siguen un estricto control de calidad avalado por la certificación **ISO 9001** y por la **ISO 14001**, que ratifica la garantía del sistema de gestión ambiental de LEDS-C4.

## NATURAL STONE AS A DIFFUSER OF LIGHT

LEDS-C4 blends technological innovation with the art of sculpture.

Reinforced, polished and varnished, alabaster combined with warm interior lighting offer infinite applications.

This material's special translucent characteristics filter and diffuse light to eliminate the harsh and sometimes cold effect of direct light. Each stone's streaks and ripples make each piece unique by giving it a luxurious, noble and warm appearance.

The rigorous process developed by LEDS-C4 for working alabaster means that we have a material of exceptional quality and distinction. This is because the alabaster is mined from an open pit with non-aggressive systems in order to protect the material's integrity.

The products in this catalog, like all LEDS-C4 products, follow a strict quality control backed by **ISO 9001** and **ISO 14001** certification. These standards affirm LEDS-C4's environmental management system.

## LA PIERRE NATURELLE COMME DIFUSSEUR DE LUMIÈRE

LEDS-C4 fusionne l'innovation technologique avec l'art de la sculpture.

Renforcée, polie et vernie, la pierre d'Albâtre se combine parfaitement avec une illumination d'intérieur qui se veut chaude et accueillante, tout en offrant une multitude de possibilités d'application. Les caractéristiques translucides et particulières de ce matériau tamisent et estompent la lumière afin d'éviter l'effet parfois sec et froid de la lumière directe. Les veines et les eaux de chacune des pierres transforment chaque pièce en un objet unique tout en lui apportant une aspect luxueux, noble et chaleureux.

Le rigoureux processus développé par LEDS-C4 en vue de l'élaboration de la pierre d'Albâtre permet de disposer d'un matériau d'une qualité exceptionnelle et d'une grande noblesse. L'extraction se fait, en général, à ciel ouvert, à l'aide de systèmes non agressifs afin de protéger l'intégrité du matériau.

Les produits de ce catalogue, à l'instar de tous les produits de LEDS-C4, sont soumis à un rigoureux contrôle de qualité avalisé par les certifications **ISO 9001** et **ISO 14001**.

## NATURSTEIN ALS LICHTDIFFUSOR

LEDS-C4 vereint die technologische Innovation mit der Bildhauerkunst.

Der verstärkte, geschliffene und lackierte Alabasterstein, ausgestattet mit einem warmen Licht im Inneren, bietet zahlreiche Verwendungsmöglichkeiten. Die einzigartige charakteristische Transparenz von diesem Material mildert und verteilt das Licht, wodurch der Effekt von Härte und Kälte, die das direkte Licht austrahlt, eliminiert wird. Die Adern und Schattierungen von diesem Stein verwandeln jedes Stück in einzigartig und verleihen ihm ein prachtvolles, edles und warmes Aussehen.

Der von LEDS-C4 entwickelte, rigoreuse Verarbeitungsprozess des Alabastersteins verleiht diesem Material eine außerordentliche Qualität und Erlesenheit. Die Extraktion des Natursteins wird im Allgemeinen unter freiem Himmel, mit nicht aggressiven Systemen zum Schutz und zur Unversehrtheit des Materials, vorgenommen.

Die Produkte dieses Katalogs, wie alle Produkte von LEDS-C4, werden einer äußerst strengen Qualitätskontrolle unterworfen, garantiert durch das **ISO 9001** Zertifikat und die Sicherheit des Betriebssystems von LEDS-C4 wird durch das **ISO 14001** Zertifikat als umweltgeeignet bestätigt.

## LA PIETRA NATURALE COME DIFFUSORE DI LUCE

LEDS-C4 abbina l'innovazione tecnologica all'arte della scultura.

Rinforzata, pulita e verniciata, la pietra d'alabastro abbinata a una calda illuminazione interna, offre infinite possibilità d'applicazione. Le particolari caratteristiche translucide di questo materiale filtrano e sfumano la luce per eliminare l'effetto rigido e a volte freddo della luce diretta. Le venature e le filigrane rendono ogni pietra unica, con un aspetto di lusso, nobiltà e calore.

Il rigoroso processo adottato da LEDS-C4 per il trattamento della pietra d'alabastro consente di disporre di un materiale di qualità e peculiarità eccezionali. Pertanto, l'estrazione di effettua, in linea generale, a cielo aperto, con sistemi non aggressivi, in modo tale da proteggere l'integrità del materiale.

Il prodotti inclusi nel presente catalogo, così come tutti i prodotti di LEDS-C4, sono soggetti a un rigoroso controllo della qualità, avallato dalla certificazione **ISO 9001** e **ISO 14001**, che ratifica la garanzia del sistema di salvaguardia ambientale di LEDS-C4.





Shanghai ..... 12



Philadelphia...24



Austria ..... 32



Tears..... 35



Bohemia ..38



Tora .....42



Muse ..... 46

**MODULO**  
**ELECTRO**

[www.modulelectro.ru](http://www.modulelectro.ru)



Calix.....51



Evergreen...55



Niagara ...60



Pavillion ...63



Venecia...66



Pag..... 70



Montserrat .... 71



Sir Davenport...76



Atlas ..... 81



Margaritaville...88



Hiedra .....91



Ala.....94



Cobra .....97



Emporium ... 102



De las rosas...106



Umbrella...111



Nilo.....114



Blanes ....118



Serie A ...121

**MODULO**  
**ELECTRO**

[www.modulelectro.ru](http://www.modulelectro.ru)



Julio Ferrer...127



Lazo.....128



Axe.....132



Agbar.....134



Trompeta...135



Pag.....138



Pag.....140



Pag.....190



Pag.....192



Pag.....196



Pag.....197



Pag.....204

Apliques · Wall fixtures · Appliques · Wandeleuchten · Applique

4



Shanghai...13 Philadelphia...226 Austria.....31 Tears.....37 Bohemia...38 Tora .....42 Muse .....45



Calix.....53 Evergreen ..... 56 Niagara ...60 Pavillion ...63 Venecia...67 Pag.....70 Montserrat .... 71



Sir Davenport...75 Atlas.....82 Margaritaville...87 Hiedra .....91 Ala.....94 Cobra.....97

**MODUL**  
**ELECTRO**

www.modulelectro.ru



Emporium....103 De las rosas...107 Umbrella...111 Nilo ..... 113 Blanes .... 119 Torch ..... 125



Serie A ... 121 Julio Ferrer...127 Lazo..... 128 Axe..... 132 Agbar..... 134 Trompeta...135



Pag..... 146 Pag..... 147 Pag..... 148 Pag..... 149

Apliques · Wall fixtures · Appliques · Wandeleuchten · Applique



Pag..... 150



Pag..... 151



Pag..... 152



Pag..... 153



Pag..... 154



Pag..... 155



Pag..... 190



Pag..... 193



Pag..... 200



Pag..... 214



Pag..... 215



Pag..... 216



Pag..... 217



Pag..... 218



Pag..... 219

**MODUL**

Espejos · Mirrors · Miroirs · Spiegeln · Spechi

**ELECTRO**

[www.modulelectro.ru](http://www.modulelectro.ru)



Pag..... 171



Pag..... 173

Cornisas · Cornices · Corniches · Kranzgesims · Cornichione



Pag..... 164



Pag..... 165



Pag..... 169

Paneles de alabastro · Alabaster panels · Panneaux d'albâtre · Panelli di alabastro



Pag..... 176



Pag..... 177



Lámparas de mesa · Table lamps · Lampes de table · Tischleuchten · Lampade da tavolo

6



Emporium ... 101 De las rosas....107 Patsi..... 110 Nilo..... 115 Pag..... 158 Pag..... 158



Pag..... 159 Pag.....205 Pag.....207

Plafones · Ceiling fixtures · Plafoniers · Deckenleuchten · Plafoniere



Shanghai.....13 Imperi.....18 Magnolia.....19 Roma.....21 Philadelphia...27 Austria..... 30 Tears.....37 Bohemia ..38

**MODUL**  
ELECTRO  
[www.modulelectro.ru](http://www.modulelectro.ru)



Muse .....45 Evergreen...56 Venecia...67 Montserrat .... 72 Sir Davenport...76 Atlas ..... 83 Margaritaville88



Ala..... 94 Cobra..... 99 Emporium...102 Nilo ..... 113 Blanes .... 119 Serie A ... 121 Axe..... 133



Pag..... 142 Pag..... 143 Pag..... 190 Pag.....201 Pag.....210



Sir Davenport...75



Emporium ... 101



Umbrella...110



Blanes ....119



Lazo..... 128



Axe..... 133



pag..... 159

**MODUL**  
ELECTRO

[www.modulelectro.ru](http://www.modulelectro.ru)

Columnas · Columns · Colonne · Säules · Colonne



Pag..... 159

Piedra de alabastro · Alabaster rock · Albâtre brut · Roh-Alabaster · Pietra di alabastro



Pag..... 125





**MODUL**  
ELECTRO  
[www.modulelectro.ru](http://www.modulelectro.ru)



**MODUL**  
ELECTRO  
[www.modulelectro.ru](http://www.modulelectro.ru)

*Neo-Classical  
Style*

**MODUL**  
ELECTRO  
[www.modulelectro.ru](http://www.modulelectro.ru)

Acabados  
Finishes  
Finitions  
Ausführungen  
Rifiniture

G8 55

Patiné rojizo  
Red patine  
Patiné rouge  
Rot Alt Messing  
Patine rosso

Alabastro blanco  
White alabaster  
Albâtre blanc  
Weisser Alabaster  
Alabastro bianco

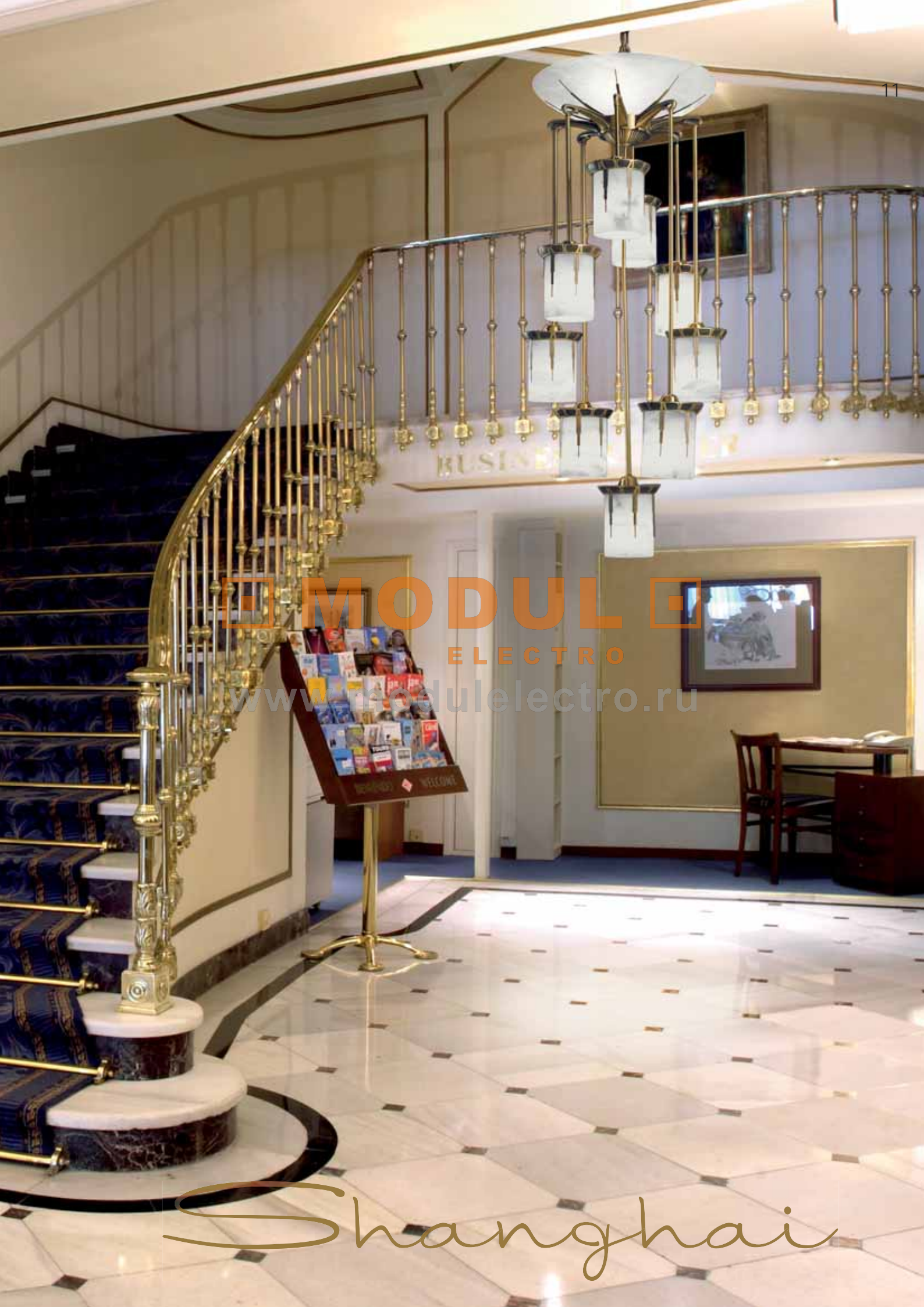

**MODUL**  
ELECTRO  
[www.modulelectro.ru](http://www.modulelectro.ru)

Shanghai



**MODULE**  
ELECTRO  
[www.modulelectro.es](http://www.modulelectro.es)

### 20-2723-G8-55

9 + 3 E-27 Fluorescentes  
compactas Osram Dulux EL 23W 2700 K

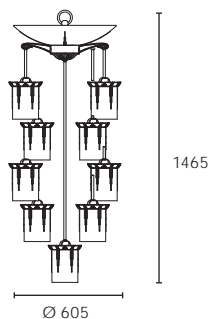

### 00-2723-G8-55

3 E-14 60W vela +  
2 E-14 15W pebetero

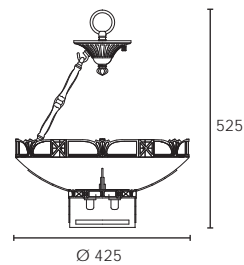

Opción aplafonado  
Flush mounted option/version  
Option fixation direct au plafond  
auch möglich als Deckenleuchte  
Opzione plafoniera



**MODUL**  
ELECTRO  
[www.modulelectro.ru](http://www.modulelectro.ru)

05-2723-G8-55

1 E-27 Fluorescentes  
compactas Osram Dulux EL 23W 2700 K

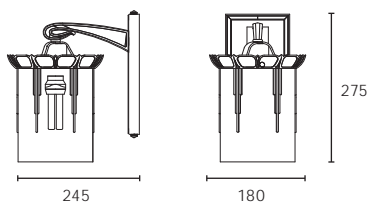

15-2723-G8-55

3 E-14 60W vela +  
2 E-14 15W pebetero

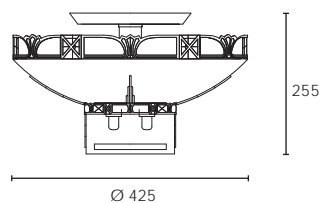



**MODUL**  
ELECTRO  
[www.modulelectro.ru](http://www.modulelectro.ru)

### 20-2724-G8-55

6 E-27 Fluorescentes compactas Osram Dulux EL 20W 2700 K +  
3 E-14 60W vela + 2 E-14 15W pebetero

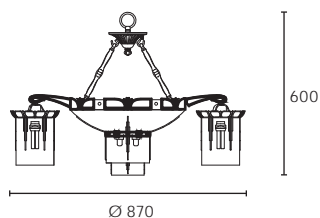

Opción aplafonado  
Flush mounted option/version  
Option fixation direct au plafond  
auch möglich als Deckenleuchte  
Opzione plafoniera



**MODUL**  
ELECTRO  
[www.modulelectro.ru](http://www.modulelectro.ru)

### 00-2724-G8-55

3 E-14 60W vela +  
2 E-14 15W pebetero

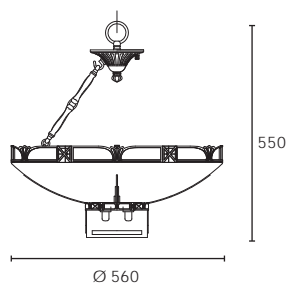

Opción aplafonado  
Flush mounted option/version  
Option fixation direct au plafond  
auch möglich als Deckenleuchte  
Opzione plafoniera

### 15-2724-G8-55

3 E-14 60W vela +  
2 E-14 15W pebetero

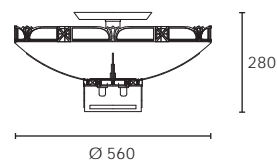





**MODUL**  
ELECTRO  
[www.modulelectro.ru](http://www.modulelectro.ru)

Acabados  
Finishes  
Finitions  
Ausführungen  
Rifiniture

G8 55

Patiné rojizo  
Red patine  
Patiné rouge  
Rot Alt Messing  
Patine rosso

Alabastro blanco  
White alabaster  
Albâtre blanc  
Weisser Alabaster  
Alabastro bianco



**MODUL**  
ELECTRO  
[www.modulelectro.ru](http://www.modulelectro.ru)





**MODUL**  
ELECTRO  
[www.modulelectro.ru](http://www.modulelectro.ru)

### 15-2721-G8-55

3 E-27 Fluorescentes compactas Osram Dulux EL 20W 2700 K

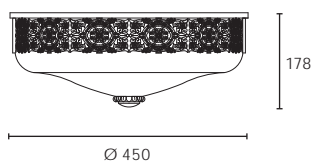

### 15-2722-G8-55

4 E-27 Fluorescentes compactas Osram Dulux EL 23W 2700 K

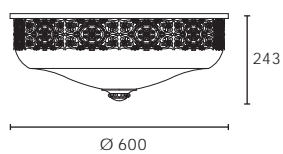



**MODUL**  
ELECTRO  
[www.modulelectro.ru](http://www.modulelectro.ru)

### 15-2720-G8-55

3 E-27 Fluorescentes compactas twisted Osram Dulux EL 20W 2700 K

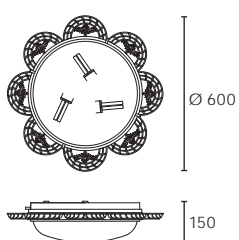

### 15-2719-G8-55

3 E-27 Fluorescentes compactas twisted 18W

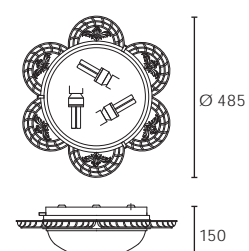

**MODUL**  
ELECTRO  
[www.modulelectro.ru](http://www.modulelectro.ru)

Acabados  
Finishes  
Finitions  
Ausführungen  
Rifiniture

G8 55

Patiné rojizo  
Red patine  
Patiné rouge  
Rot Alt Messing  
Patine rosso

Alabastro blanco  
White alabaster  
Albâtre blanc  
Weisser Alabaster  
Alabastro bianco

*Roma*



15-2715-G8-55

2 E-27 Fluorescentes compactas Osram Dulux EL 20W 2700 KW

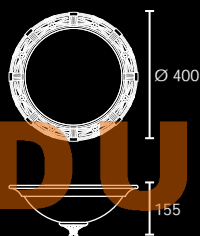

**MODUL**  
ELECTRO

[www.modulelectro.ru](http://www.modulelectro.ru)



15-2716-G8-55

4 E-27 Fluorescentes compactas Osram Dulux EL 23W 2700 K



**MODUL**  
ELECTRO  
[www.modulelectro.ru](http://www.modulelectro.ru)

Acabados  
Finishes  
Finitions  
Ausführungen  
Rifiniture

G8 55

Patiné rojizo  
Red patine  
Patiné rouge  
Rot-Alt Messing  
Patine rosso

Alabastro blanco  
White alabaster  
Albâtre blanc  
Weisser Alabaster  
Alabastro bianco

**MODUL**  
ELECTRO  
[www.modulelectro.ru](http://www.modulelectro.ru)

*Philadelphia*





**MODUL**  
ELECTRO  
[www.modulelectro.ru](http://www.modulelectro.ru)



### 20-2528-G8-55

6 + 3 x E-14 esf. ø45 max. 60W +  
3 + 3 x E-14 esf. ø45 max. 60W

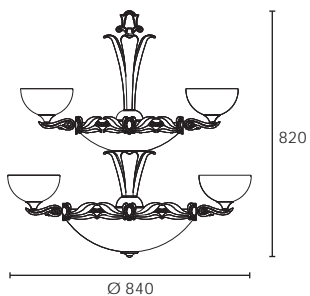

### 20-2529-G8-55

3 + 3 x E-14 esf. ø45 max. 60W +  
6 + 3 x E-14 esf. ø45 max. 60W +  
9 + 3 x E-14 esf. ø45 max. 60W

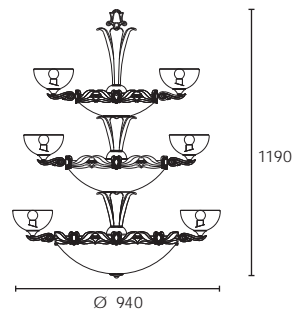



**MODUL**  
ELECTRO  
[www.modulelectro.ru](http://www.modulelectro.ru)



20-2526-G8-55

3 + 3 x E-14 esf. ø45 max. 60W

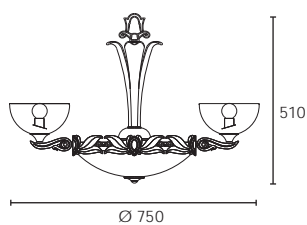

20-2527-G8-55

6 + 3 x E-14 esf. ø45 max. 60W

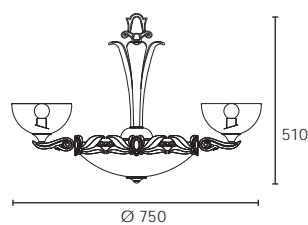



**MODUL**  
ELECTRO

[www.modulelectro.ru](http://www.modulelectro.ru)



00-2526-G8-55  
3 x E-14 esf. ø45 max. 60W

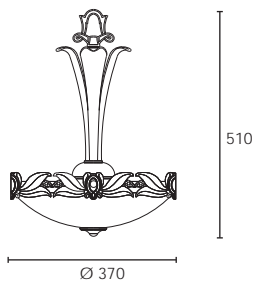

05-2526-G8-55  
1 x E-27 max. 60W

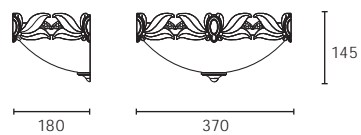



**MODUL**  
ELECTRO  
[www.modulelectro.ru](http://www.modulelectro.ru)

15-2526-G8-55  
3 x E-14 esf.  $\varnothing$ 45 max. 60W

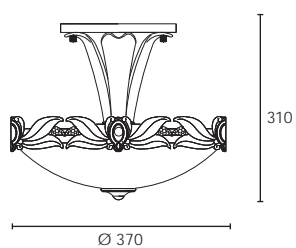

15-2527-G8-55  
3 x E-14 esf.  $\varnothing$ 45 max. 60W

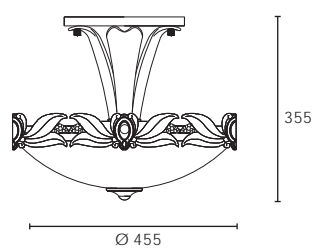

**MODULO**  
ELECTRO  
[www.modulelectro.ru](http://www.modulelectro.ru)

Acabados  
Finishes  
Finitions  
Ausführungen  
Rifiniture

G8 87

Patiné rojizo  
Red patine  
Patiné rouge  
Rot Alt Messing  
Patine rosso

Alabastro color champán  
Champagne colour alabaster  
Albâtre couleur champagne  
Champagner färbig Alabaster  
Alabastro colore espumoso



**MODUL**  
ELECTRO  
[www.modulelectro.ru](http://www.modulelectro.ru)

*Austria*

15-0383-G8-87

3 E-27 max. 60W esf. ø45

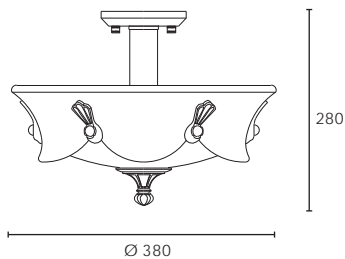

**MODUL**  
ELECTRO

[www.modulelectro.ru](http://www.modulelectro.ru)

15-0384-G8-87

4 E-27 max. 60W esf. ø45

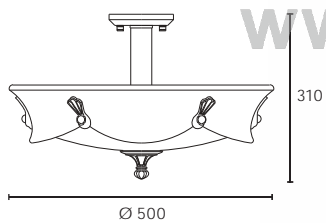

15-0385-G8-87

6 E-27 max. 60W esf. ø45

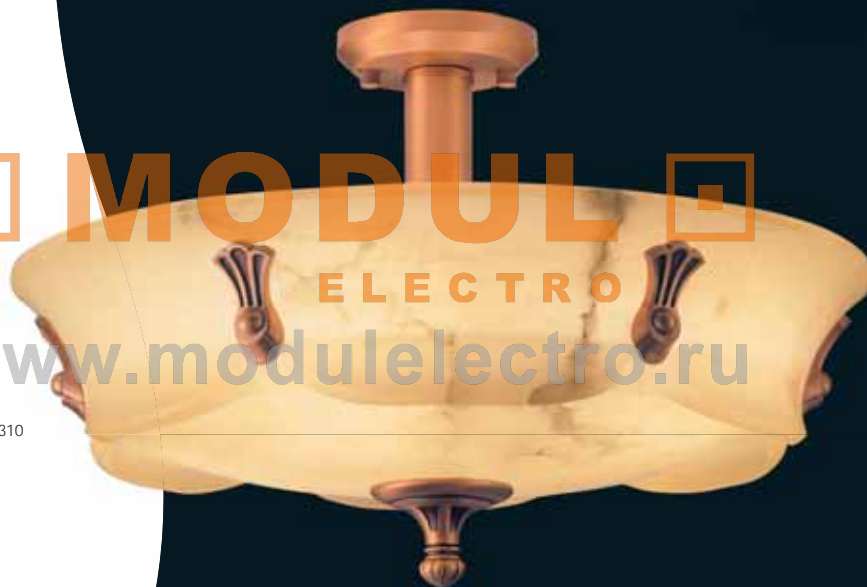
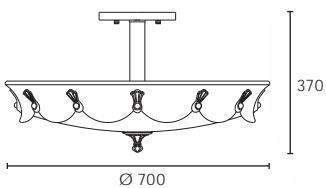

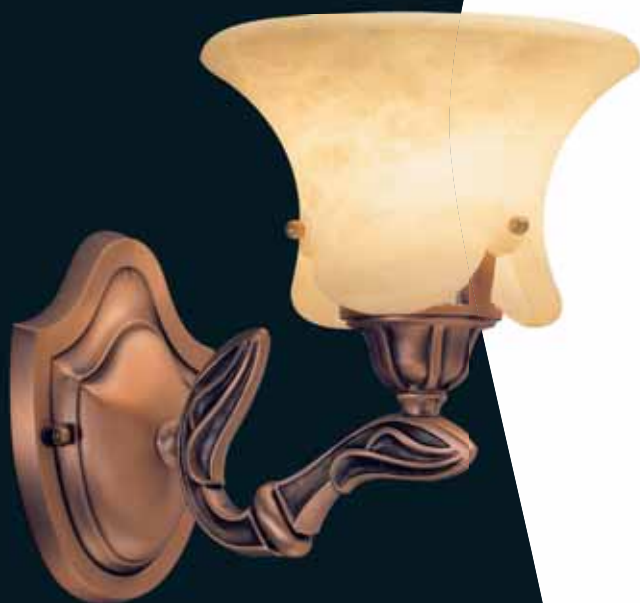

05-0383-G8-87

E-14 max. 60W

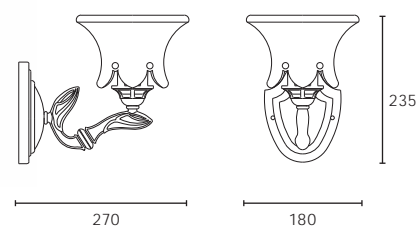

**MODULO**  
ELECTRO  
[www.modulelectro.ru](http://www.modulelectro.ru)

05-0384-G8-87

1 E-27 max. 60W esf. ø45

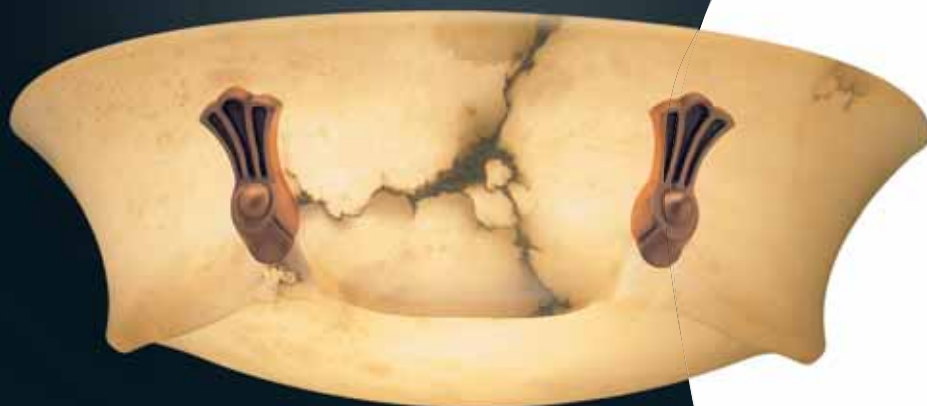
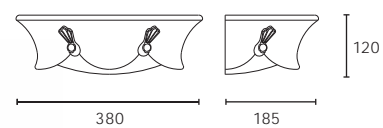





20-0383-G8-87

3 E-27 max. 60W esf. ø45 +  
3 E-14 max. 60W

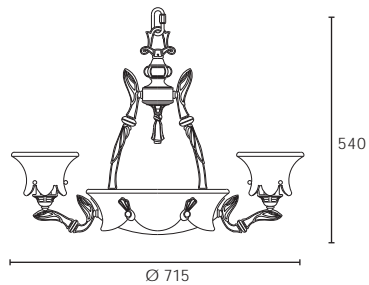



**MODUL**  
ELECTRO  
[www.modulelectro.ro](http://www.modulelectro.ro)



20-0384-G8-87

3 E-27 max. 60W esf. ø45 +  
6 E-14 max. 60W

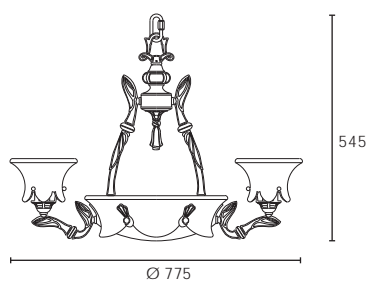

00-0383-G8-87

3 E-27 max. 60W esf. ø45

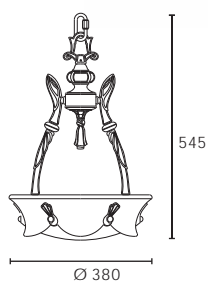



**MODUL**

**ELECTRO**

[www.modulelectro.ru](http://www.modulelectro.ru)

*Years*

Acabados  
Finishes  
Finitions  
Ausführungen  
Rifiniture

G8 55

Patiné rojizo  
Red patine  
Patiné rouge  
Rot Alt Messing  
Patine rosso

Alabastro blanco  
White alabaster  
Albâtre blanc  
Weisser Alabaster  
Alabastro bianco



**MODULO**  
ELECTRO

[www.modulelectro.ru](http://www.modulelectro.ru)

20-0329-G8-55

3 E-14 max. 60W

6 E-14 max. 60W + 2 E-14 max. 60W

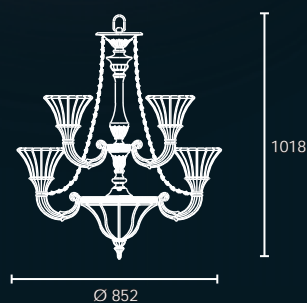

71-0365-01-35

Cadenas de cristal: Crystal chains

Chaines en cristal: Kristallketten

Catene di cristallo

Para conjunto completo solicite referencias de luminaria y cadenas de cristal / For complete set please order by separate fixture and crystal chains references / Demandez le code de luminaire et chaines en cristal en cas de complete / Für komplette Leuchte, bestellen Sie bitte Lampe und Kristallketten getrennt / Ordinare il codice dell'apparecchio e le catene di cristallo per il congiunto completo



20-0328-G8-55

6 E-14 max. 60W + 2 E-14 max. 60W

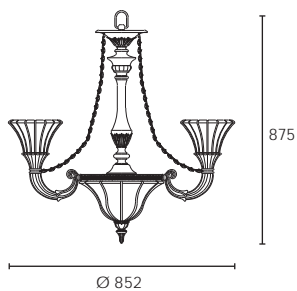

71-0364-01-35

Cadenas de cristal- Crystal chains  
Chânes en cristal- Kristallketten  
Catene di cristallo

20-0330-G8-55

3 E-14 max. 60W

6 E-14 max. 60W + 2 E-14 max. 60W

12 E-14 max. 60W + 6 E-14 max. 60W

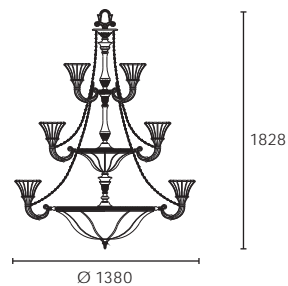

71-0366-01-35

Cadenas de cristal- Crystal chains  
Chânes en cristal- Kristallketten  
Catene di cristallo



**MODUL**

**ELECTRO**

[www.modul-electro.ru](http://www.modul-electro.ru)



00-0328-G8-55

6 E-14 max. 60W

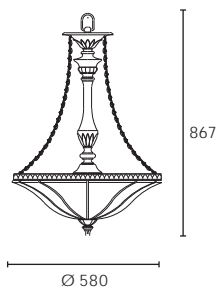

71-0361-01-35

Cadenas de cristal- Crystal chains  
Chaines en cristal- Kristallketten  
Catene di cristallo

05-0328-G8-55

1 E-14 max. 60W

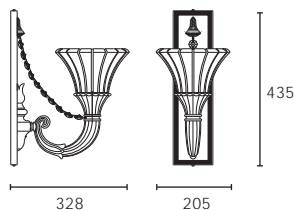

71-0362-01-35

Cadenas de cristal- Crystal chains  
Chaines en cristal- Kristallketten

15-0328-G8-55

3 E-14 max. 60W

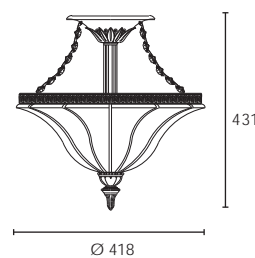

71-0363-01-35

Cadenas de cristal- Crystal chains  
Chaines en cristal- Kristallketten  
Catene di cristallo

15-0389-G8-87

3 E-14 max. 60W

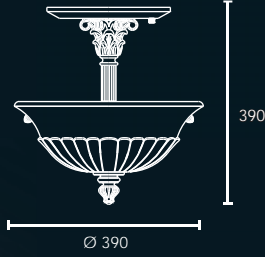

05-0389-G8-87

2 E-14 max. 60W vela

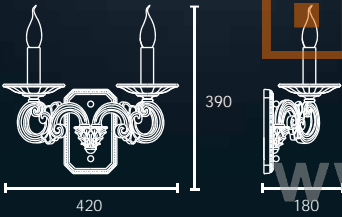

20-0389-G8-87

6 E-14 max. 60W vela + 2 E-14 max. 60W

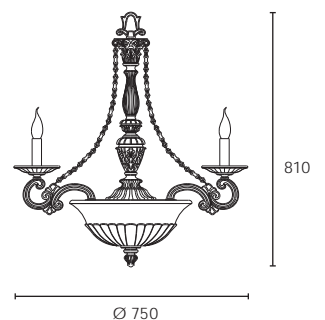

# Bohemia

## G8 87

Acabados  
Finishes  
Finitions  
Ausführungen  
Rifiniture

Patiné rojizo  
Red patine  
Patiné rouge  
Rot Alt Messing  
Patine rosso

Alabastro color champán  
Champagne colour alabaster  
Albâtre couleur champagne  
Champagner färbig Alabaster  
Alabastro colore espumoso

MODULO  
ELECTRO  
www.modulelectro.ru



**MODULO**  
ELECTRO  
[www.modulelectro.com](http://www.modulelectro.com)



20-0390-G8-87

3 E-14 max. 60W vela +  
6 E-14 max. 60W vela + 2 E-14 max. 60W

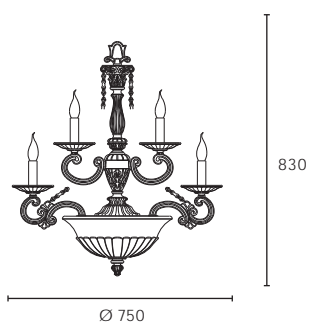

20-0391-G8-87

3 E-14 max. 60W vela +  
6 E-14 max. 60W vela +  
12 E-14 max. 60W vela + 3 E-14 max. 60W

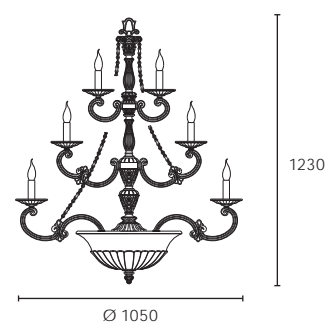





**MODUL**  
ELECTRO  
[www.modulelectro.ru](http://www.modulelectro.ru)

Acabados  
Finishes  
Finitions  
Ausführungen  
Rifiniture

G8 87

Patiné rojizo  
Red patine  
Patiné rouge  
Rot Alt Messing  
Patine rosso

Alabastro color champán  
Champagne colour alabaster  
Albâtre couleur champagne  
Champagner färbig Alabaster  
Alabastro colore espumoso

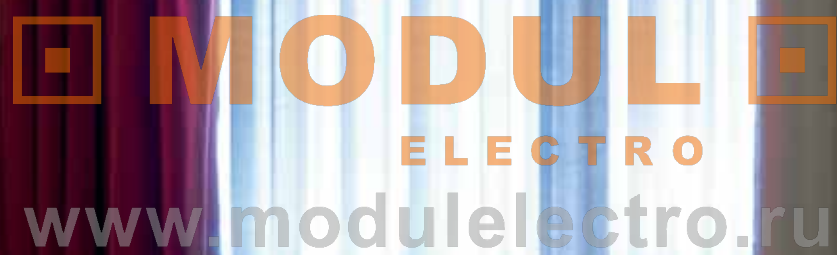

**MODUL**  
ELECTRO  
[www.modulelectro.ru](http://www.modulelectro.ru)



Tona



**MODUL**  
ELECTRO

[www.modulelectro.ru](http://www.modulelectro.ru)



00-0375-G8-87

3 E-14 max. 60W esf. ø45

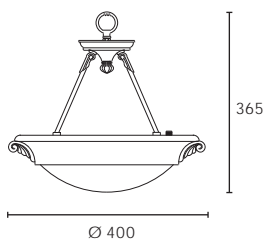

05-0375-G8-87

1 E-14 max. 60W esf. ø45

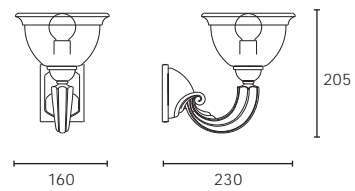

**MODUL**  
ELECTRO  
[www.modulelectro.ru](http://www.modulelectro.ru)

20-0376-G8-87

6 E-14 max. 60W esf.  $\varnothing 45$  + 2 E-14 max. 60W esf.  $\varnothing 45$

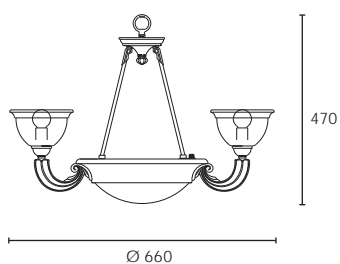

20-0375-G8-87

3 E-14 max. 60W esf.  $\varnothing 45$  + 2 E-14 max. 60W esf.  $\varnothing 45$

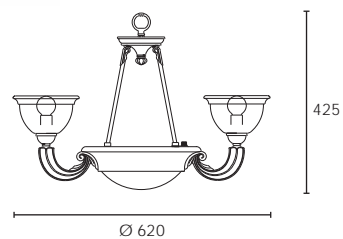

**MODUL**  
ELECTRO  
[www.modulelectro.ru](http://www.modulelectro.ru)

Muse

Acabados  
Finishes  
Finitions  
Ausführungen  
Rifiniture

G8 U9

Patiné rojizo  
Red patine  
Patiné rouge  
Rot Alt Messing  
Patine rosso

Alabastro blanco con talla color beige  
White colour alabaster with beige carvin  
Albâtre blanc avec taille beige  
Weisser Alabaster mit Ivory Rand  
Alabastro bianco con intaglio colore beige



05-0260-G8-U9

1 E-14 max. 60W

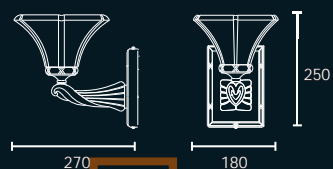

**MODUL**  
ELECTRO

[www.modulelectro.ru](http://www.modulelectro.ru)



15-0262-G8-U9

8 E-14 max. 60W

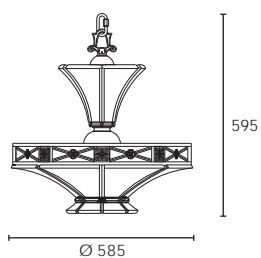

00-0260-G8-U9

2 E-14 max. 15W +  
6 E-14 max. 60W

**MODUL**  
ELECTRO  
[www.modulelectro.ru](http://www.modulelectro.ru)

15-0260-G8-U9

3 E-14 max. 60W

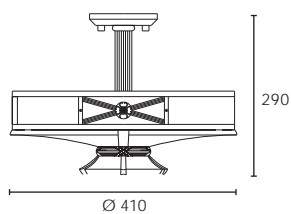



15-0261-G8-U9

6 E-14 max. 60W

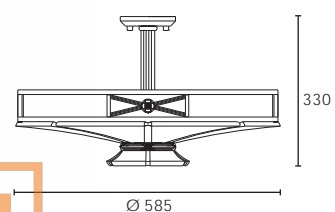

**MODUL**  
ELECTRO

[www.modulelectro.ru](http://www.modulelectro.ru)



05-0261-G8-U9

2 E-14 max. 60W

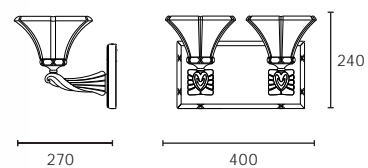





**MODUL**  
ELECTRO  
[www.modulelectro.ru](http://www.modulelectro.ru)



20-0260-G8-U9

2 E-14 max. 15W +  
6 E-14 max. 60W + 3 E-14 max. 40W

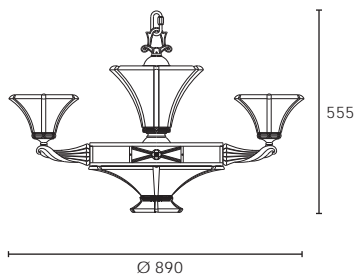

20-0261-G8-U9

2 E-14 max. 15W +  
8 E-14 max. 60W + 4 E-14 max. 40W

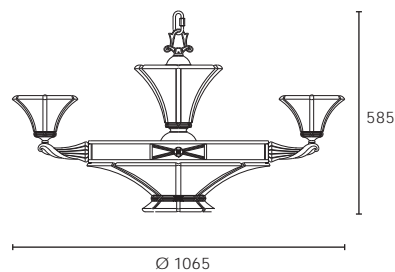



**MODUL**  
ELECTRO  
[www.modulselectro.com](http://www.modulselectro.com)

### 20-0262-G8-U9

2 E-14 max. 15W +  
4 E-14 max. 60W + 2 E-14 max. 40W +  
8 E-14 max. 60W + 4 E-14 max. 40W

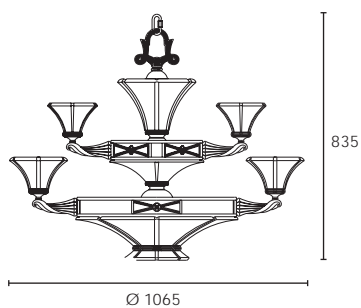

### 20-0263-G8-U9

2 E-14 max. 15W +  
4 E-14 max. 60W + 2 E-14 max. 40W +  
8 E-14 max. 60W + 4 E-14 max. 40W +  
12 E-14 max. 60W + 6 E-14 max. 40W

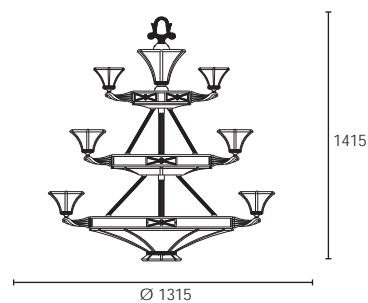

# MODUL

## ELECTRO

[www.modulelectro.ru](http://www.modulelectro.ru)

Acabados  
Finishes  
Finitions  
Ausführungen  
Rifiniture

G8 55

Patiné rojizo  
Red patine  
Patiné rouge  
Rot Alt Messing  
Patiné rosso

Alabastro blanco  
White alabaster  
Albâtre blanc  
Weisser Alabaster  
Alabastro bianco



**MODUL**

**ELECTRO**

[www.modulelectro.ru](http://www.modulelectro.ru)

20-0169-G8-55

6 E-27 max. 60W +

1 E-27 max. 100W + 1 E-14 max. 15W



*Calix*



20-0168-G8-55

3 E-27 max. 60W +

1 E-27 max. 100W + 1 E-14 max. 15W



**MODUL**  
ELECTRO  
[www.modulelectro.ru](http://www.modulelectro.ru)

20-0209-G8-55

3 E-27 max. 60W + 1 E-27 max. 100W + 1 E-14 max. 15W +

1 E-14 max. 15W + 6 E-27 max. 60W + 3 E-27 max. 60W +

12 E-27 max. 60W + 6 E-27 max. 60W

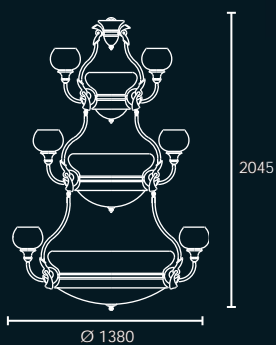



**MODUL**  
ELECTRO

20-0170-G8-55

4 E-27 max. 60W + 1 E-27 max. 100W + 1 E-14 max. 15W +  
8 E-27 max. 60W + 4 E-27 max. 60W

00-0168-G8-55

1 E-27 max. 100W + 1 E-14 max. 15W

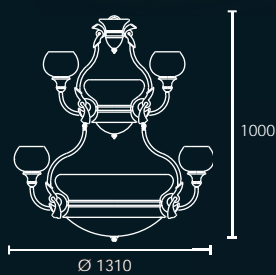

05-0168-G8-55

1 E-27 max. 60W

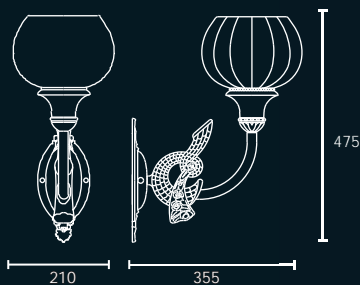



**MODUL**  
ELECTRO

[www.modulelectro.ru](http://www.modulelectro.ru)

*Evergreen*

Acabados  
Finishes  
Finitions  
Ausführungen  
Rifiniture

11

Oro/Patiné rojizo  
Gold/Red patine  
Or/Patiné rouge  
Vergoldet/Rot Alt Messing  
Oro/Patine rosso

55

Alabastro blanco  
White alabaster  
Albâtre blanc  
Weisser Alabaster  
Alabastro bianco



**MODULO**  
ELECTRO  
[www.modulelectro.ru](http://www.modulelectro.ru)

20-2280-11-55

3 E-27 max. 60W esf.  $\varnothing 45$  + 3 E-14 max. 60W

9 E-27 max. 60W esf.  $\varnothing 45$  + 6 E-14 max. 60W

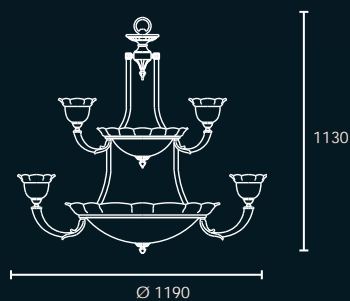



05-2280-11-55

1 E-27 max. 60W

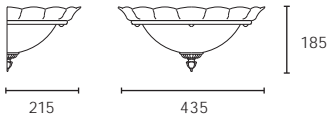

20-2282-11-55

6 E-27 max. 60W esf. ø45

3 E-14 max. 60W

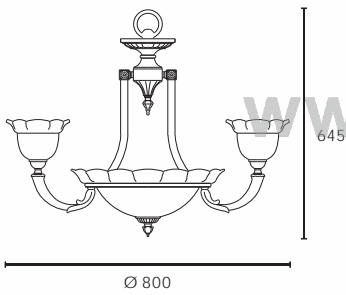

**MODUL**  
ELECTRO  
[www.modul-electro.ru](http://www.modul-electro.ru)





20-2281-I1-55

8 E-27 max. 60W esf.  $\varnothing 45$  +

4 E-14 max. 60W

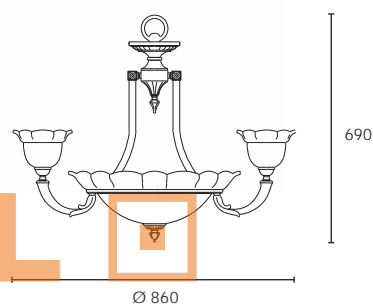

**MODULO**  
ELECTRO

[www.modulelectro.ru](http://www.modulelectro.ru)



15-2280-I1-55

3 E-14 max. 60W

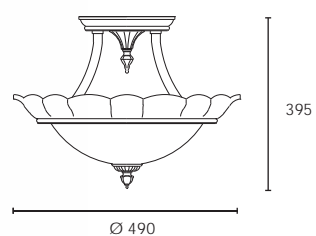

**MODUL**  
ELECTRO  
[www.modulelectro.ru](http://www.modulelectro.ru)

Acabados  
Finishes  
Finitions  
Ausführungen  
Rifiniture

G8 55

Patiné rojizo  
Red patine  
Patiné rouge  
Rot Alt Messing  
Patine rosso

Alabastro blanco  
White alabaster  
Albâtre blanc  
Weisser Alabaster  
Alabastro bianco



**MODUL**

ELECTRO

[www.modulelectro.ru](http://www.modulelectro.ru)

*Niagara*



**MODUL**  
ELECTRO

[www.modulelectro.ru](http://www.modulelectro.ru)



20-0226-G8-55

6 E-14 max. 60W +1 E-14 max. 25W

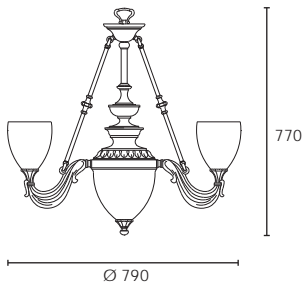

05-0226-G8-55

1 E-14 max. 60W

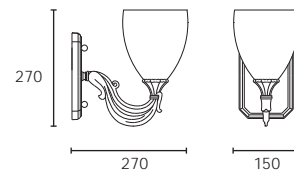



**MODUL**  
ELECTRO

[www.modulelectro.ru](http://www.modulelectro.ru)



20-0227-G8-55

3 E-14 max. 60W +

6 E-14 max. 60W + 1 E-14 max. 25W

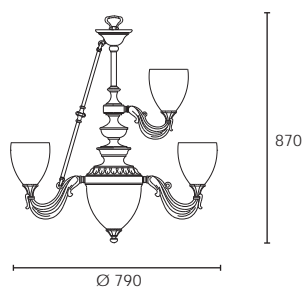

05-0227-G8-55

2 E-14 max. 60W

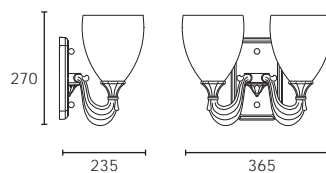

**MODUL**
  
*Pavillion*  
**ELECTRO**  
[www.modulelectro.ru](http://www.modulelectro.ru)

Acabados  
 Finishes  
 Finitions  
 Ausführungen  
 Rifiniture

G8 55

Patiné rojizo  
 Red patine  
 Patiné rouge  
 Rot Alt Messing  
 Patine rosso

Alabastro blanco  
 White alabaster  
 Albâtre blanc  
 Weisser Alabaster  
 Alabastro bianco



**MODUL**  
ELECTRO  
[www.modulelectro.ru](http://www.modulelectro.ru)

00-0216-G8-55

3 E-14 max. 60W

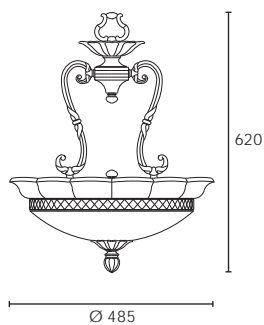

20-0217-G8-55

6 E-14 max. 60W + 3 E-14 max. 60W esf. Ø45

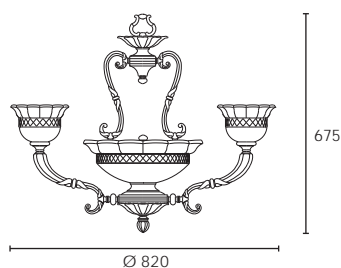

05-0216-G8-55

1 E-14 max. 60W

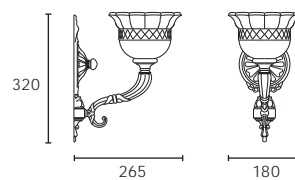



**MODUL**  
ELECTRO  
[www.modulelectro.ru](http://www.modulelectro.ru)

Acabados  
Finishes  
Finitions  
Ausführungen  
Rifiniture

G8

Patiné rojizo  
Red patine  
Patiné rouge  
Rot Alt Messing  
Patine rosso

55

Alabastro blanco  
White alabaster  
Albâtre blanc  
Weisser Alabaster  
Alabastro bianco



MODUL

ELECTRO

[www.modulelectro.ru](http://www.modulelectro.ru)

Venecia





**MODUL**  
ELECTRO

[www.modulelectro.ru](http://www.modulelectro.ru)



20-0193-G8-55

6 E-14 max. 60W +  
2 E-14 max. 40W esf. ø45

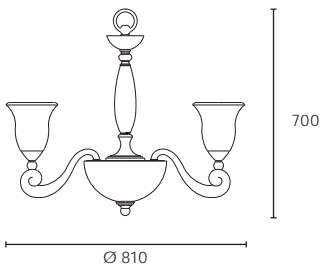

20-0194-G8-55

3 E-14 max. 60W +  
6 E-14 max. 60W + 2 E-14 max. 40W esf. ø45

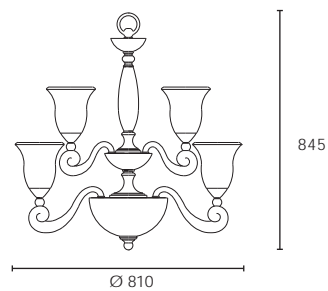



**MODUL**  
ELECTRO  
[www.modulelectro.ru](http://www.modulelectro.ru)



00-0193-G8-55  
3 E-14 max. 60W

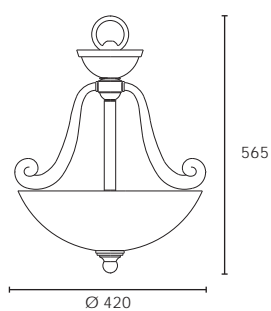

05-0193-G8-55  
1 E-14 max. 60W

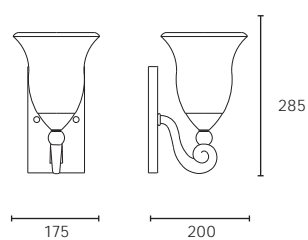

15-0193-G8-55  
3 E-14 max. 60W

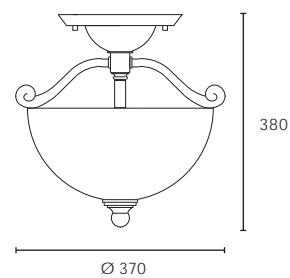



**MODUL**  
ELECTRO  
[www.modulelectro.ru](http://www.modulelectro.ru)

Acabados  
Finishes  
Finitions  
Ausführungen  
Rifiniture

G8

Patiné rojizo  
Red patine  
Patiné rouge  
Rot Alt Messing  
Patine rosso

55

Alabastro blanco  
White alabaster  
Albâtre blanc  
Weisser Alabaster  
Alabastro bianco

S6

Alabastro blanco con talla patinada  
White with patine colour carving alabaster  
Albâtre blanc avec taille patiné  
Weisser mit patina Rand Alabaster  
Alabastro bianco con intaglio patinato



**MODUL**

**ELECTRO**

[www.modulelectro.ru](http://www.modulelectro.ru)

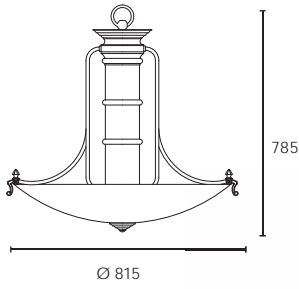

00-2262-G8-55

6 E-27 max. 60W +  
2 E-14 max. 25W

20-2261-G8-55

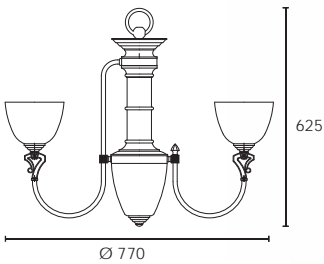
6 E-27 max. 60W +  
1 E-14 max. 15W +  
1 E-14 max. 25W

05-2261-G8-55

1 E-27 max. 60W

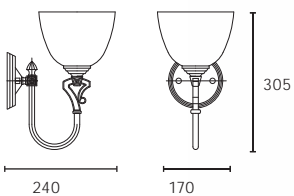



05-2257-G8-S6

1 E-27 max. 60W esf. ø45

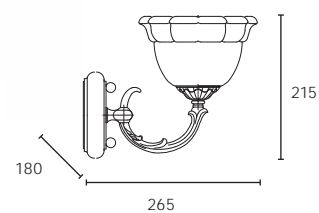

05-2258-G8-S6

1 E-27 max. 60W

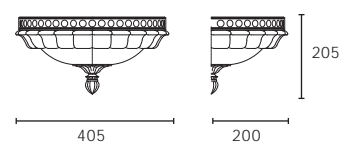

00-2258-G8-S6

6 E-14 max. 60W

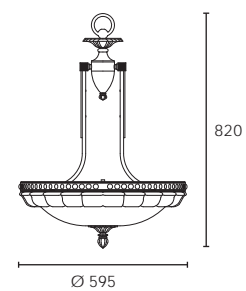





**MODUL**  
ELECTRO

[www.modulelectro.ru](http://www.modulelectro.ru)



15-2257-G8-S6

3 E-14 max. 60W

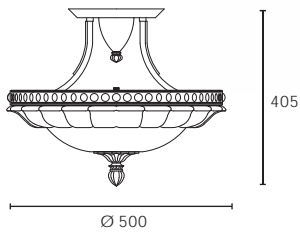

20-2258-G8-S6

6 E-27 max. 60W esf. ø45 + 3 E-14 max. 60W +  
12 E-27 max. 60W esf. ø45 + 6 E-14 max. 60W

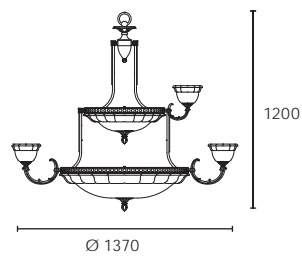



**MODULO**  
ELECTRO  
[www.modulelectro.ru](http://www.modulelectro.ru)

### 20-2257-G8-S6

6 E-27 max. 60W esf.  $\varnothing 45$  +  
3 E-14 max. 60W

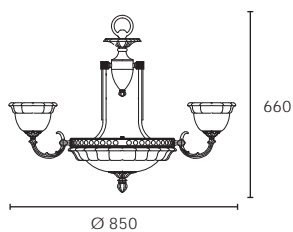

### 20-2259-G8-S6

3 E-27 max. 60W esf.  $\varnothing 45$  + 3 E-14 max. 60W +  
9 E-27 max. 60W esf.  $\varnothing 45$  + 6 E-14 max. 60W +  
12 E-27 max. 60W esf.  $\varnothing 45$  + 6 E-14 max. 60W

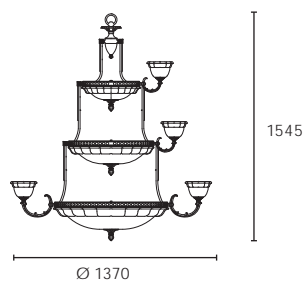

**MODUL**  
ELECTRO

[www.modulelectro.ru](http://www.modulelectro.ru)

Sim  
Davenport

Acabados  
Finishes  
Finitions  
Ausführungen  
Rifiniture

G8 55

Patiné rojizo  
Red patine  
Patiné rouge  
Rot Alt Messing  
Patine rosso

Alabastro blanco  
White alabaster  
Albâtre blanc  
Weisser Alabaster  
Alabastro bianco



05-2161-G8-55

1 E-27 max. 60W

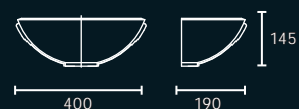

**MODUL**  
ELECTRO  
[www.modulelectro.ru](http://www.modulelectro.ru)

25-2161-G8-55

1 E-27 max. 100W



15-2161-G8-55  
3 E-14 max. 60W esf. ø45

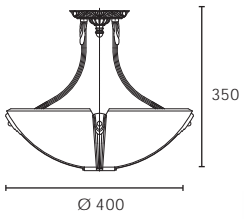

15-2162-G8-55  
6 E-27 max. 60W

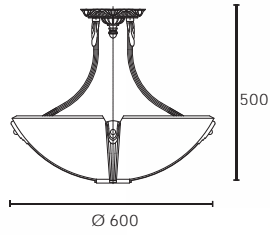

00-2161-G8-55  
3 E-14 max. 60W

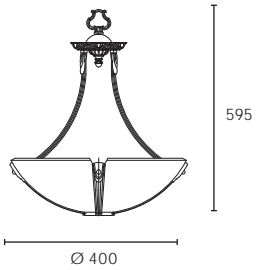

**MODULO**  
ELECTRO  
[www.modulelectro.ru](http://www.modulelectro.ru)

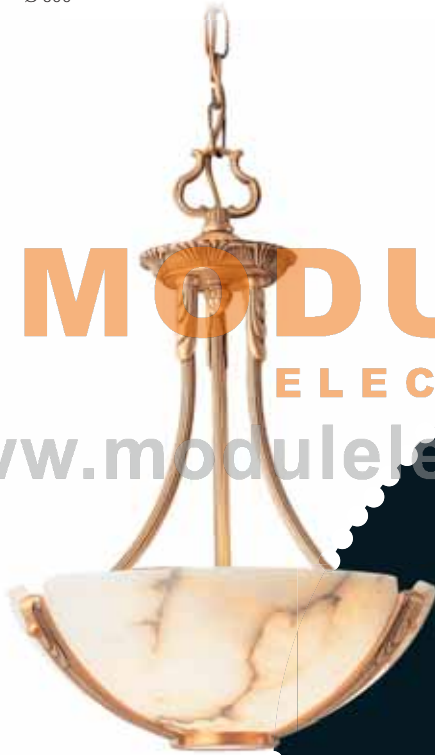

00-2162-G8-55  
6 E-27 max. 60W

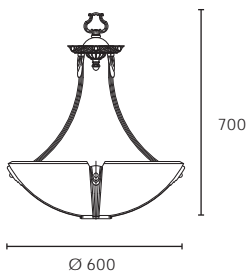

20-2161-G8-55

6 E-27 max. 60W + 3 E-14 max. 60W

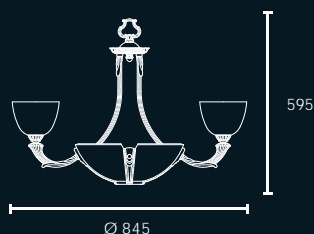

**MODUL**  
ELECTRO

[www.modulelectro.ru](http://www.modulelectro.ru)

20-2163-G8-55

4 E-27 max. 60W +

8 E-27 max. 60W + 6 E-27 max. 60W

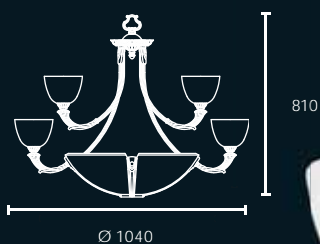



**MODUL**  
ELECTRO  
[www.modulelectro.ru](http://www.modulelectro.ru)



20-2162-G8-55

8 E-27 max. 60W +  
6 E-27 max. 60W

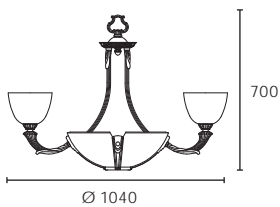

00-2163-G8-55

8 E-14 max. 60W esf. ø45

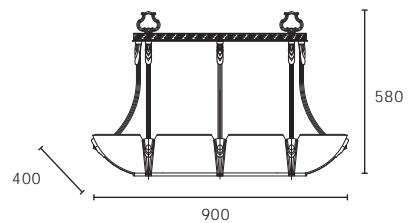



20-2164-G8-55

12 E-27 max. 60W +

8 E-14 max. 60W esf. ø45

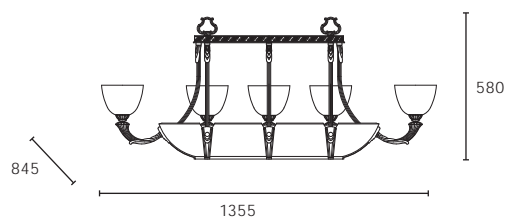



**MODUL**  
ELECTRO  
[www.modulelectro.ru](http://www.modulelectro.ru)

Acabados  
Finishes  
Finitions  
Ausführungen  
Rifiniture

S4

Ámbar dorado  
Golden amber  
Ambré doré  
Vergoldet Bernstein  
Ambrá dorato

55

Alabastro blanco  
White alabaster  
Albâtre blanc  
Weisser Alabaster  
Alabastro bianco

Atlas



**MODULE**  
ELECTRO  
[www.modulelectro.ru](http://www.modulelectro.ru)

20-2239-S4-55

6 E-27 max. 60W +

12 E-27 max. 60W + 3 E-27 max. 60W +

18 E-27 max. 60W + 6 E-27 max. 60W

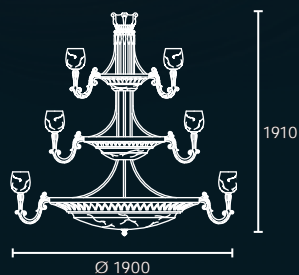



**MODUL**  
ELECTRO  
[www.modulelectro.ru](http://www.modulelectro.ru)



20-2235-S4-55  
3 E-27 max. 60W + 1 E-27 max. 60W

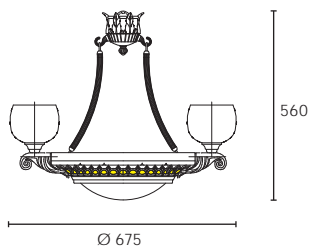

05-2237-S4-55  
2 E-27 max. 60W

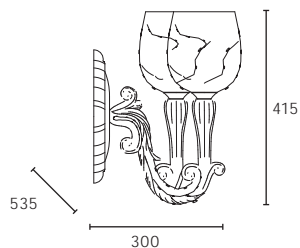



**MODUL**  
ELECTRO  
[www.modulelectro.ru](http://www.modulelectro.ru)

15-2237-S4-55  
3 E-14 max. 60W esf. ø45

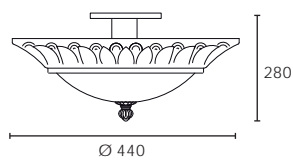

15-2239-S4-55  
6 E-27 max. 60W

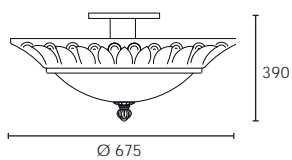

00-2236-S4-55  
3 E-27 max. 60W

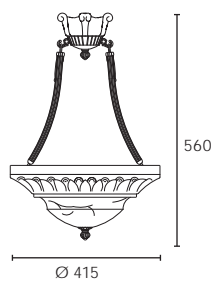

05-2236-S4-55  
1 E-27 max. 60W

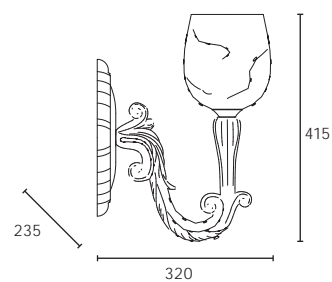



**MODUL**  
ELECTRO  
[www.modulelectro.ru](http://www.modulelectro.ru)



20-2237-S4-55

12 E-27 max. 60W + 3 E-27 max. 60W

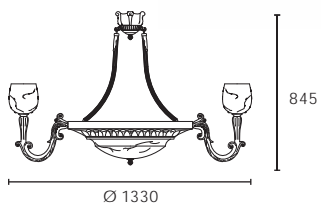

20-2236-S4-55

6 E-27 max. 60W + 1 E-27 max. 60W

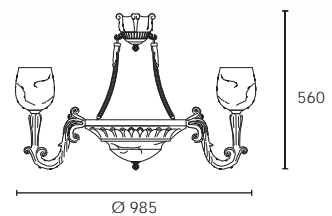



20-2238-S4-55

6 E-27 max. 60W +

12 E-27 max. 60W + 3 E-27 max. 60W

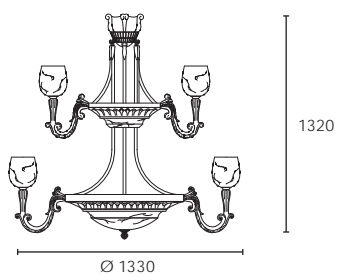

05-2235-S4-55

1 E-27 max. 60W

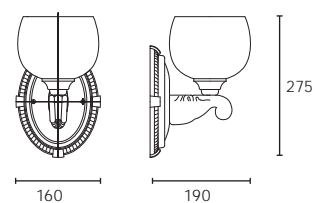



**MODUL**

*Margaritaville*

[www.modulelectro.ru](http://www.modulelectro.ru)

Acabados  
Finishes  
Finitions  
Ausführungen  
Rifiniture

T1 55

Níquel satylite  
Satylite nickel  
Nickel satylite  
Satylite Nickel  
Níquel satylite

Alabastro blanco  
White alabaster  
Albâtre blanc  
Weisser Alabaster  
Alabastro bianco

 **MODULO**   
ELECTRO  
[www.modulelectro.ru](http://www.modulelectro.ru)



05-2222-T1-55  
1 E-14 max. 60W

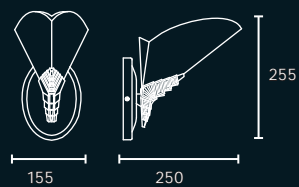



**MODUL**  
ELECTRO  
[www.modulelectro.ru](http://www.modulelectro.ru)

20-2225-T1-55

3 E-27 max. 60W + 3 E-14 max. 60W +  
3 E-14 max. 60W

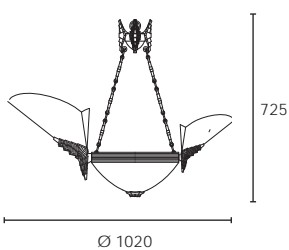

05-2224-T1-55

2 E-14 max. 60W

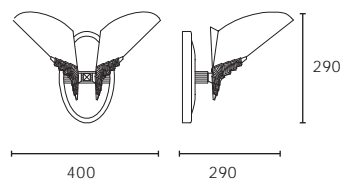

15-2222-T1-55

3 E-14 max. 60W

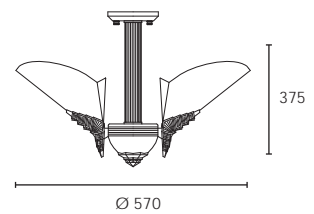



**MODUL**  
ELECTRO  
[www.modulelectro.ru](http://www.modulelectro.ru)

20-2222-T1-55

3 E-14 max. 60W + 3 E-14 max. 60W

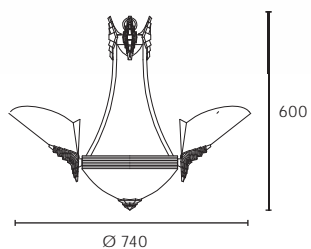

20-2226-T1-55

6 E-27 max. 60W +  
6 E-14 max. 60W + 3 E-14 max. 60W

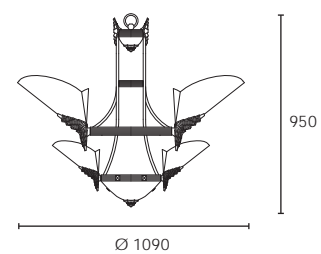

**MODUL**  
ELECTRO  
[www.modulelectro.ru](http://www.modulelectro.ru)

Acabados  
Finishes  
Finitions  
Ausführungen  
Rifiniture

D5 55

Oro viejo/oro  
Old gold/gold  
Or vieil/or  
Antik gold/Vergoldet  
Oro vecchio/oro

Alabastro blanco  
White alabaster  
Albâtre blanc  
Weisser Alabaster  
Alabastro bianco

*hiedra*

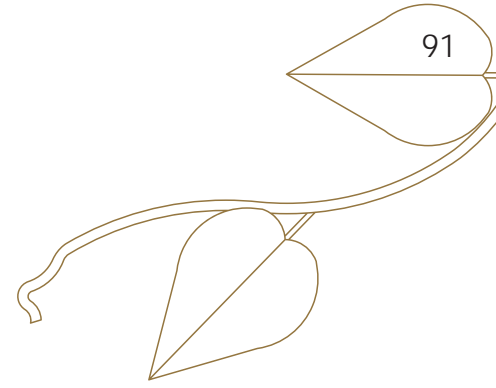

**MODULO**  
ELECTRO  
[www.modulelectro.ru](http://www.modulelectro.ru)



20-2061-D5-55  
3 E-27 max. 60W + 1 E-27 max. 60W

00-2061-D5-55  
1 E-27 max. 100W

05-2061-D5-55  
1 E-27 max. 60W

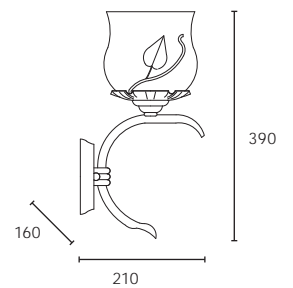
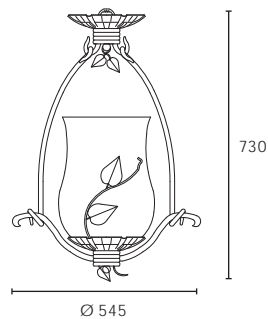
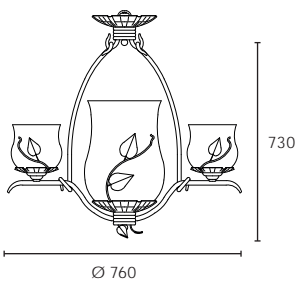

**MODUL**  
ELECTRO  
[www.modulelectro.ru](http://www.modulelectro.ru)

Acabados  
Finishes  
Finitions  
Ausführungen  
Rifiniture

G8 55

Patiné rojizo  
Red patine  
Patiné rouge  
Rot Alt Messing  
Patine rosso

Alabastro blanco  
White alabaster  
Albâtre blanc  
Weisser Alabaster  
Alabastro bianco

*Ala*



**MODUL**  
ELECTRO  
[www.modulelectro.ru](http://www.modulelectro.ru)





**MODUL**  
ELECTRO

[www.modulelectro.ru](http://www.modulelectro.ru)



15-2213-G8-55

3 E-14 max. 60W esf. ø45

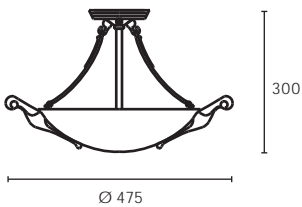

05-2213-G8-55

1 E-27 max. 60W

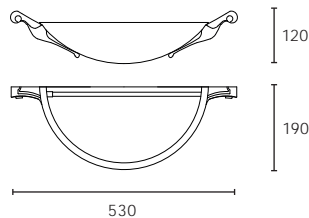

00-2213-G8-55

3 E-27 max. 60W esf. ø45

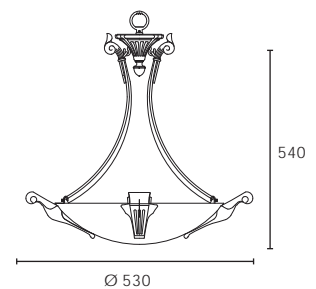



20-2214-G8-55

6 E-27 max. 60W esf.  $\varnothing 45$  +  
3 E-14 max. 60W esf.  $\varnothing 45$

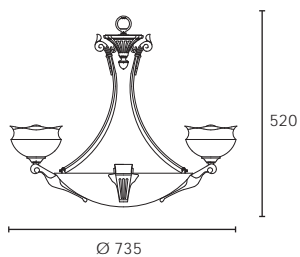





MODUL  
ELECTRO

[www.modulelectro.ru](http://www.modulelectro.ru)

Cobra

Acabados  
Finishes  
Finitions  
Ausführungen  
Rifiniture

P6

Oro brillante y arenado  
Shiny sandblasted gold  
Or brillant sablé  
Gold glänzend/sandig  
Oro lucido brillante

G8

Patiné rojizo  
Red patine  
Patiné rouge  
Rot Alt Messing  
Patine rosso

55

Alabastro blanco  
White alabaster  
Albâtre blanc  
Weisser Alabaster  
Alabastro bianco



20-1761-P6-55

20-1761-G8-55

6 E-27 max. 60W esf.  $\varnothing 45$  + 3 E-14 max. 60W

**MODUL**  
ELECTRO

[www.modulelectro.ru](http://www.modulelectro.ru)

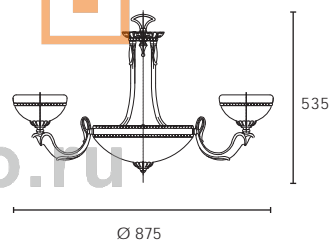

05-1763-P6-55

05-1763-G8-55

1 E-27 max. 60W

05-1764-P6-55

05-1764-G8-55

1 E-27 max. 60W

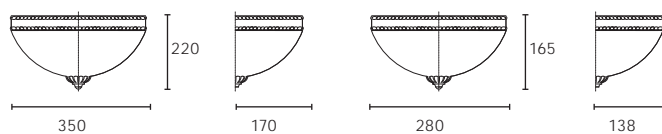

20-1763-P6-55

20-1763-G8-55

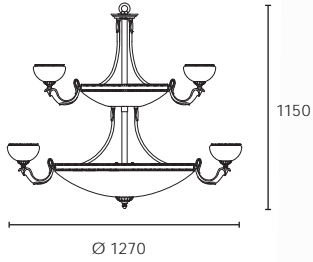
4 E-27 max. 60W esf.  $\varnothing 45$  + 4 E-27 max. 60W +8 E-27 max. 60W esf.  $\varnothing 45$  + 4 E-27 max. 60W

20-1764-P6-55

20-1764-G8-55

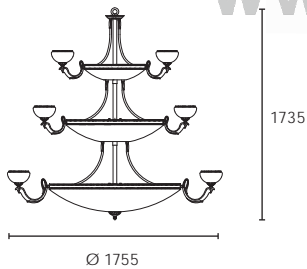
4 E-27 max. 60W esf.  $\varnothing 45$  + 4 E-27 max. 60W +8 E-27 max. 60W esf.  $\varnothing 45$  + 4 E-27 max. 60W +12 E-27 max. 60W esf.  $\varnothing 45$  + 8 E-27 max. 60W

**MODULO**  
ELECTRO  
[www.modulelectro.ru](http://www.modulelectro.ru)

00-1761-P6-55

00-1761-G8-55

3 E-14 max. 60W

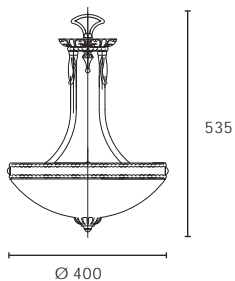



05-1761-P6-55  
05-1761-G8-55  
1 E-27 max. 60W esf. ø45

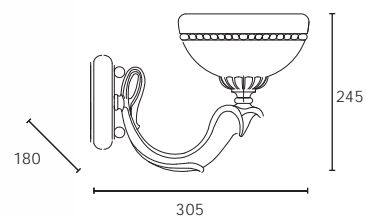

20-1762-P6-55  
20-1762-G8-55  
3 E-27 max. 60W esf. ø45 + 3 E-14 max. 60W

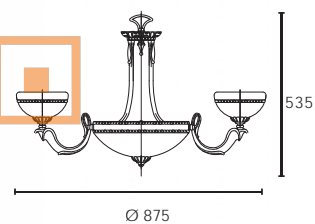

15-1761-P6-55  
15-1761-G8-55  
3 E-14 max. 60W

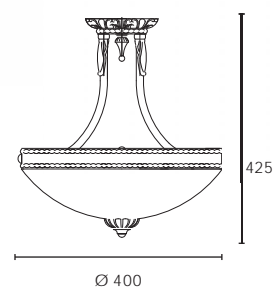

15-1762-P6-55  
15-1762-G8-55  
3 E-27 max. 60W

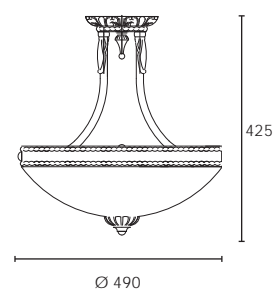

**MODULO**  
ELECTRO  
www.moduloelectro.ru

# MODUL

ELECTRO

[www.modulelectro.ru](http://www.modulelectro.ru)

Emporium

Acabados  
Finishes  
Finitions  
Ausführungen  
Rifiniture

I1

Oro/patiné rojizo  
Gold/red patiné  
Or/patiné rouge  
Vergoldet/rot Alt Messing  
Oro/patinato rosso

55

Alabastro blanco  
White alabaster  
Albâtre blanc  
Weisser Alabaster  
Alabastro bianco

Q7

Alabastro blanco sin pantalla de tela  
White alabaster without fabric shade  
Albâtre blanc sans abat-jour in tissu  
Alabastro bianco senza schermo di tela  
Weisser Alabaster ohne Stoffschirm



10-1858-I1-Q7

1 E-27 max. 60W + 1 E-14 max. 40W

Sin pantalla de tela · Without fabric shade  
 Sans abat-jour en tissu · Ohne Stoffschirm  
 Enza schermo di tela

Pantalla / shade /abat-jour  
 Stoffschirm / schermo

Ref. Pan-076-20

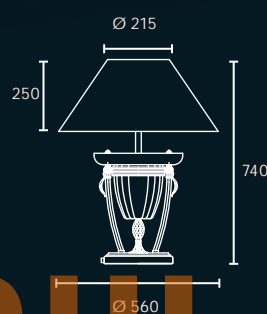

**MODUL**  
**ELECTRO**

[www.modulelectro.ru](http://www.modulelectro.ru)



25-1858-I1-55

1 E-27 max. 150W





**MODUL**  
ELECTRO  
[www.modulelectro.ru](http://www.modulelectro.ru)



20-1858-11-55

3 E-14 max. 60W esf. ø45 + 3 E-27 max. 60W esf. ø45

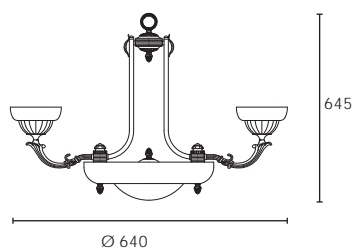

15-1858-11-55

3 E-27 max. 60W esf. ø45

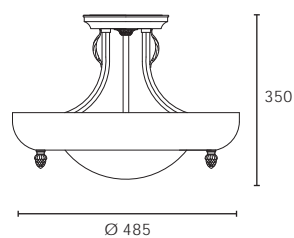



**MODUL**

ELECTRO

[www.modulelectro.ru](http://www.modulelectro.ru)



05-1858-11-55

1 E-14 max. 60W esf. ø45

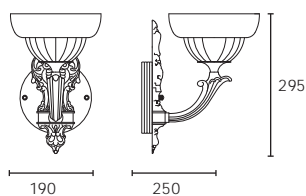

05-1859-11-55

2 E-14 max. 60W esf. ø45

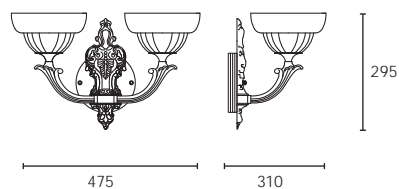



# MODUL

ELECTRO

[www.modulelectro.ru](http://www.modulelectro.ru)

Acabados  
Finishes  
Finitions  
Ausführungen  
Rifiniture

11

Oro/patiné rojizo  
Gold/red patiné  
Or/patiné rouge  
Vergoldet/rot Alt Messing  
Oro/patinato rosso

55

Alabastro blanco  
White alabaster  
Albâtre blanc  
Weisser Alabaster  
Alabastro bianco

82

Sin pantalla de tela  
Without fabric shade  
Sans abat-jour en tissu  
Ohne Stoffschirm  
Enza schermo di tela



**MODUL**  
ELECTRO

[www.modulelectro.ru](http://www.modulelectro.ru)

*De las rosas*



20-1384-I1-55  
6 E-14 max. 60W

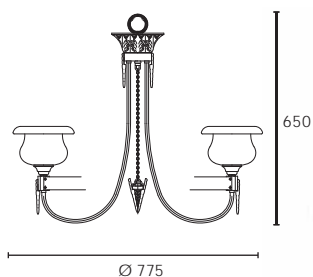

**MODUL**  
ELECTRO  
[www.modulelectro.ru](http://www.modulelectro.ru)

20-1385-I1-55  
3 E-14 max. 60W +  
6 E-14 max. 60W

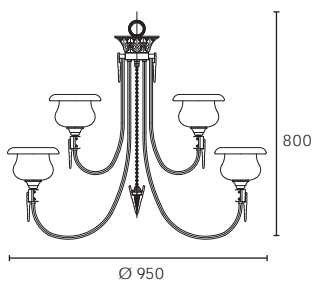



10-1384-I1-82

1 E-27 max. 60W + 1 E-14 max. 15W

Sin pantalla de tela · Without fabric shade ·  
Sans abat-jour en tissu. Ohne Stoffschirm ·  
Enza schermo di tela

Pantalla / shade /abat-jour  
Stoffschirm / schermo

Ref. Pan-076-20

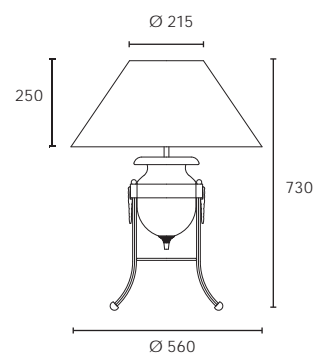

**MODULO**  
ELECTRO  
[www.modulelectro.ru](http://www.modulelectro.ru)

05-1385-I1-55

2 E-14 max. 60W

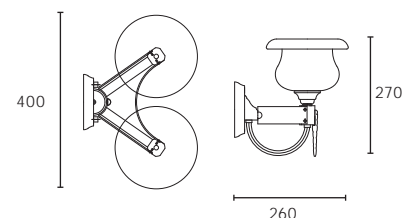

05-1384-I1-55

1 E-14 max. 60W

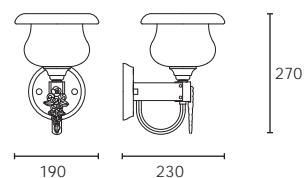

**MODUL**  
ELECTRO  
[www.modulelectro.ru](http://www.modulelectro.ru)

Acabados  
Finishes  
Finitions  
Ausführungen  
Rifiniture

88

Níquel satinado/oro  
Satin nickel/gold  
Nickel satiné/or  
Satiniertes Nickel/Vergoldet  
Nichel satinato/oro

55

Alabastro blanco  
White alabaster  
Albâtre blanc  
Weisser Alabaster  
Alabastro bianco

82

Sin pantalla de tela  
Without fabric shade  
Sans abat-jour en tissu  
Ohne Stoffschirm  
Enza schermo di tela

**MODUL**  
ELECTRO  
[www.modulelectro.ru](http://www.modulelectro.ru)

*Umbrella*





**MODUL**  
ELECTRO  
[www.modulelectro.ru](http://www.modulelectro.ru)

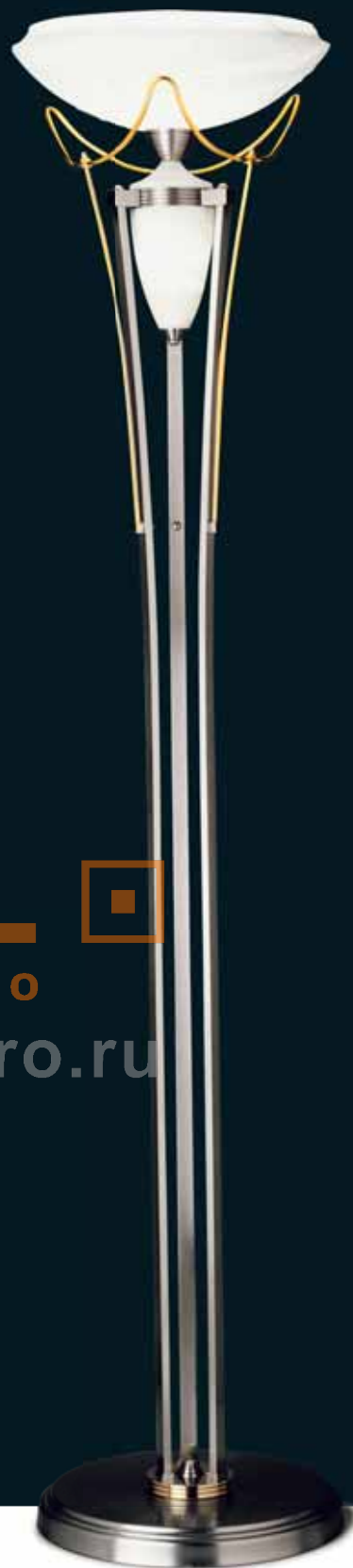

### 10-1387-88-82

1 E-27 max. 60W  
1 E-14 max. 15W

Sin pantalla de tela · Without fabric shade ·  
Sans abat-jour en tissu. Ohne Stoffschirm ·  
Enza schermo di tela

Pantalla / shade / abat-jour  
Stoffschirm / schermo

Ref. Pan-077-20

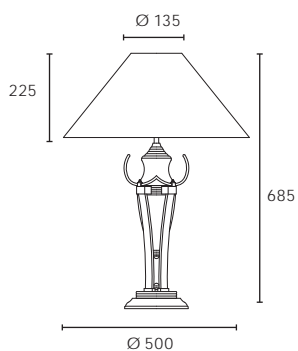

### 25-1387-88-55

1 E-27 max. 150W +  
1 E-14 max. 15W

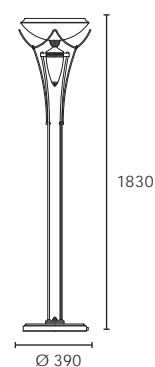



**MODUL**  
ELECTRO  
[www.modulelectro.ru](http://www.modulelectro.ru)



20-1388-88-55

5 E-27 max. 60W +  
1 E-14 max. 15W

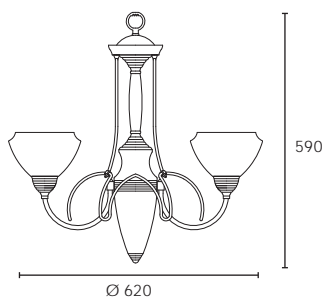

05-1387-88-55

1 E-27 max. 60W

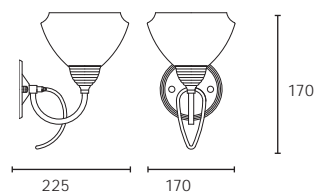



Acabados  
Finishes  
Finitions  
Ausführungen  
Rifiniture

11

Oro/patiné rojizo  
Gold/red patiné  
Or/patiné rouge  
Vergoldet/rot Alt Messing  
Oro/patinato rosso

55

Alabastro blanco  
White alabaster  
Albâtre blanc  
Weisser Alabaster  
Alabastro bianco

82

Sin pantalla de tela  
Without fabric shade  
Sans abat-jour en tissu  
Ohne Stoffschirm  
Enza schermo di tela

88

Níquel satinado/oro  
Satin nickel/gold  
Nickel satiné/or  
Satiniertes Nickel/Vergoldet  
Nichel satinato/oro

**MODUL**  
ELECTRO  
[www.modulelectro.ru](http://www.modulelectro.ru)



15-1635-11-55  
 15-1635-88-55  
 3 E-27 max. 60W esf. ø45

15-1636-11-55  
 15-1636-88-55  
 6 E-27 max. 60W esf. ø45

**MODULO**  
 ELECTRO

[www.modulelectro.ru](http://www.modulelectro.ru)

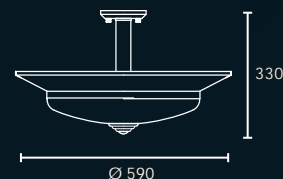
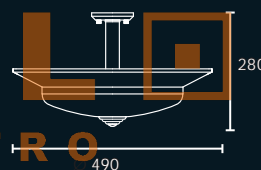

05-1635-11-55  
 05-1635-88-55  
 1 E-27 max. 60W



*Nilo*



**MODUL**  
ELECTRO  
[www.modulelectro.ru](http://www.modulelectro.ru)



20-1636-11-55

20-1636-88-55

6 E-27 max. 60W esf. ø45 +

3 E-27 max. 60W esf. ø45

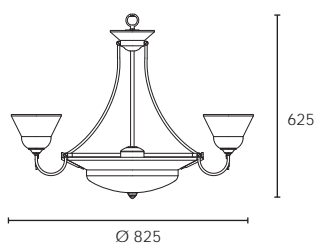

20-1635-11-55

20-1635-88-55

3 E-27 max. 60W esf. ø45 +

3 E-27 max. 60W esf. ø45

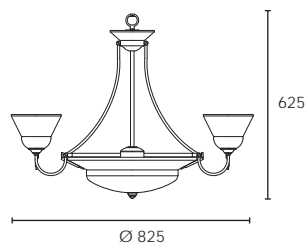



**MODUL**  
ELECTRO  
[www.modulelectro.ru](http://www.modulelectro.ru)



00-1635-I1-55  
00-1635-88-55

3 E-27 max. 60W esf. ø45

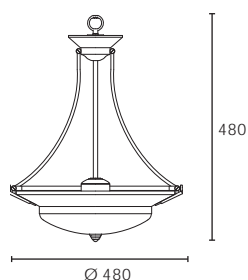

05-1637-I1-55  
05-1637-88-55

1 E-27 max. 60W esf. ø45

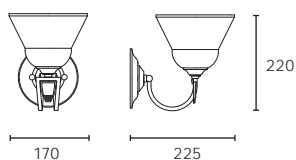

10-1635-I1-82  
10-1635-88-82

1 E-27 max. 60W

Sin pantalla de tela · Without fabric shade ·  
Sans abat-jour en tissu. Ohne Stoffschirm ·  
Enza schermo di tela

Pantalla / shade / abat-jour  
Stoffschirm / schermo

Ref. Pan-078-20

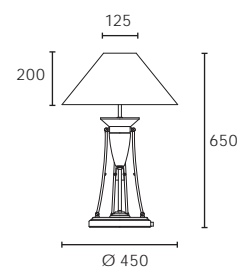



**MODUL**  
ELECTRO  
[www.modulelectro.ru](http://www.modulelectro.ru)

Acabados  
Finishes  
Finitions  
Ausführungen  
Rifiniture

G8 55

Patiné rojizo  
Red patine  
Patiné rouge  
Rot Alt Messing  
Patine rosso

Alabastro blanco  
White alabaster  
Albâtre blanc  
Weisser Alabaster  
Alabastro bianco

**MODUL**  
ELECTRO  
[www.modulelectro.ru](http://www.modulelectro.ru)

*Blanes*



00-1765-G8-55

3 E-14 max. 60W

00-1766-G8-55

3 E-27 max. 60W esf. ø45

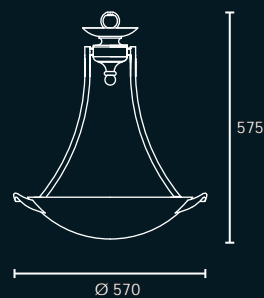
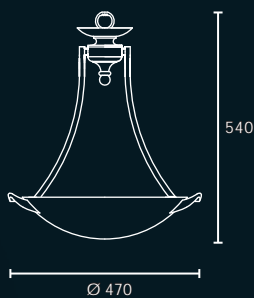

20-1765-G8-55

3 E-27 max. 60W esf. ø45 +

3 E-14 max. 60W

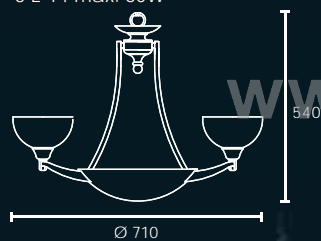

**MODUL**  
ELECTRO  
[www.modulelectro.ru](http://www.modulelectro.ru)



20-1766-G8-55

6 E-27 max. 60W esf. ø45 +

3 E-14 max. 60W

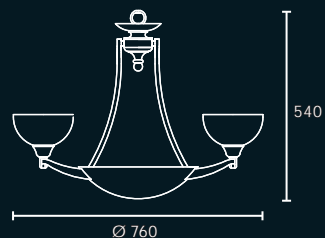



15-1765-G8-55

3 E-14 max. 60W

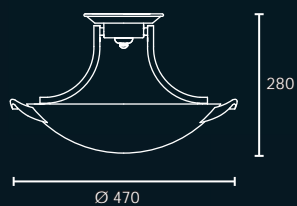

15-1766-G8-55

3 E-27 max. 60W esf. ø45

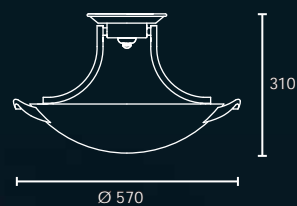

**MODUL**  
ELECTRO  
[www.modulelectro.ru](http://www.modulelectro.ru)

05-1765-G8-55

1 E-27 max. 60W esf. ø45

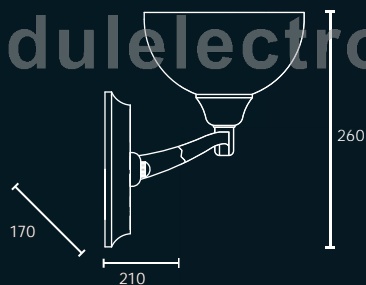

25-1765-G8-55

1 E-27 max. 150W







**MODUL**  
ELECTRO  
[www.modulelectro.ru](http://www.modulelectro.ru)

Acabados  
Finishes  
Finitions  
Ausführungen  
Rifiniture

G1 55

Aluminio pintado  
Aluminium colour  
Couleur aluminium  
Aluminium Farbe  
Alluminio pintato

Alabastro blanco  
White alabaster  
Albâtre blanc  
Weisser Alabaster  
Alabastro bianco

00-0718-G1-55

5 E-27 max. 60W esf. ø45

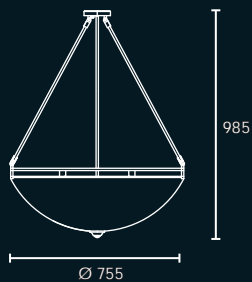

00-0719-G1-55

5 E-27 max. 60W esf. ø45



**MODUL**  
ELECTRO

[www.modulelectro.ru](http://www.modulelectro.ru)



15-0718-G1-55

3 E-27 max. 60W



05-0718-G1-55

1 E-27 max. 60W

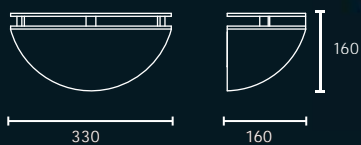

*Serie A*



20-1900-G8-55  
6 E-27 max. 60W + 6 E-27 max. 60W

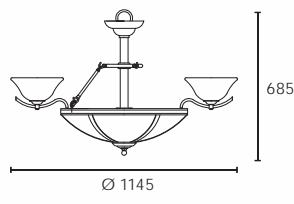

**MODUL**  
ELECTRO

[www.modulelectro.ru](http://www.modulelectro.ru)

20-1899-G8-55  
9 E-27 max. 60W + 6 E-27 max. 60W

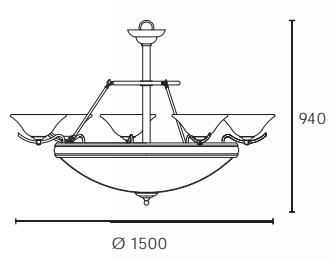

G8 55

**Acabados**  
**Finishes**  
**Finitions**  
**Ausführungen**  
**Rifiniture**

Patiné rojizo  
Red patine  
Patiné rouge  
Rot Alt Messing  
Patine rosso

Alabastro blanco  
White alabaster  
Albâtre blanc  
Weisser Alabaster  
Alabastro bianco



05-0659-95-98

1 E-27 max. 60W

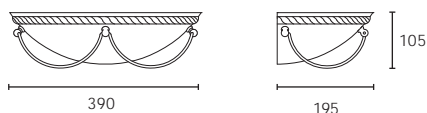

390

195

105

ELECTRO

[www.modulelectro.ru](http://www.modulelectro.ru)

20-6264-50-C1

5 E-27 max. 60W esf. ø45 + 2 E-14 max.15W

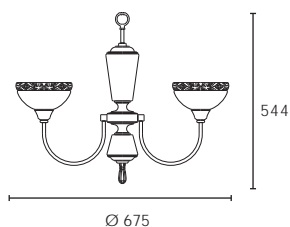

Ø 675

544

20-0728-50-C1

8 E-27 max. 60W esf. ø45 + 2 E-14 max.15W

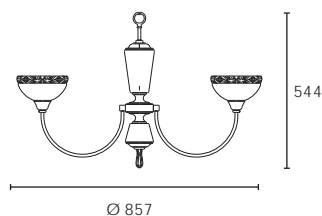

Ø 857

544

95

Patiné/cobre  
Antique brass/copper  
Patiné/cuivre  
Alt Messing/Kupfer  
Patinato/ottone

98

Alabastro blanco/talla marrón  
White alabaster/rust carving  
Albâtre blanc/taille marron  
Weisser Alabaster/brauner Rand  
Alabastro bianco

50

Patiné  
Antique brass  
Patiné  
Alt Messing  
Patine

C1

Alabastro ivory/talla marrón  
Ivory alabaster/rust carving  
Albâtre ivory/taille marron  
Ivory Alabaster/brauner Rand  
Alabastro ivory/intaglio marrone

20-6241-01-55

6 E-27 max. 60W esf. ø45 + 2 E-14 max.15W

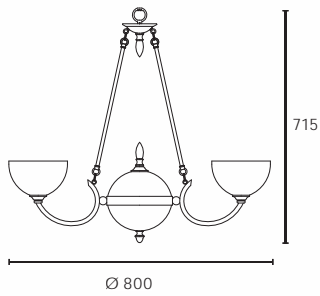

Acabados  
Finishes  
Finitions  
Ausführungen  
Rifiniture

01

Oro  
Gold  
Or  
Vergoldet  
Oro

**MODUL**  
ELECTRO

[www.modulelectro.ru](http://www.modulelectro.ru)

55

Alabastro blanco  
White alabaster  
Albâtre blanc  
Weisser Alabaster  
Alabastro bianco

14

Blanco  
White  
Blanc  
Weiss  
Bianco

05-6241-01-55

1 E-27 max. 60W esf. ø45

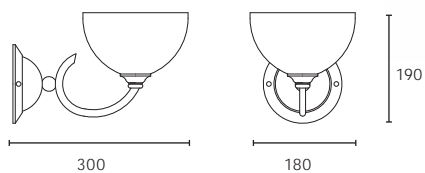

# Torch



05-1894-G8-55  
2 E-27 max. 40W esf. ø45

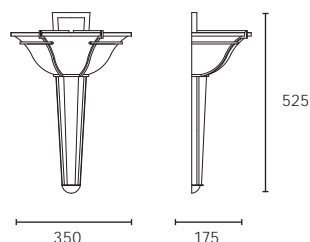

Acabados  
Finishes  
Finitions  
Ausführungen  
Rifiniture

## G8

Patiné rojizo  
Red patine  
Patiné rouge  
Rot Alt Messing  
Patine rosso

## 55

Alabastro blanco  
White alabaster  
Albâtre blanc  
Weisser Alabaster  
Alabastro bianco

**MODUL**  
**ELECTRO**

[www.modulelectro.ru](http://www.modulelectro.ru)



91-0483-14-55

1 E-14 max. 60W

Piedra de alabastro iluminada. Formas y medidas varian.  
Medidas aproximadas: Ø=380, H=455. Peso aproximado: 22 Kg.  
Puede adaptarse para uso exterior.

Alabaster rock lamp. Sizes and shapes vary.  
Average size: Ø=380, H=455. Average weight: 22 Kg.  
May be adapted for outdoor use.

Albâtre brut éclairée. Différents formes et dimensions.  
Dimensions aproximatives: Ø=380, H=455. Poids approximative: 22 Kg.  
Peut être adaptée à l'usage extérieur.

Roh-Alabaster beleuchtet. Verschiedene Formen und Abmessungen.  
Ca.-Abmessungen: Ø=380, H=455. Ca.-Gewicht: 22 Kg.  
man kan diese Leuchte als Ausseleuchte verwenden.

La pietra di alabastro illuminata. Le forme e mesuri sono variabili.  
Misure approssimate: Ø=380, H=455. Peso approssimato: 22 Kg.  
Si può adattare per l'esterno.

**MODUL**  
ELECTRO  
[www.modulelectro.ru](http://www.modulelectro.ru)

Acabados  
Finishes  
Finitions  
Ausführungen  
Rifiniture

G8

55

Patiné rojizo  
Red patiné  
Patiné rouge  
Rot Alt Messing  
Patiné rosso

Alabastro blanco  
White alabaster  
Albâtre blanc  
Weisser Alabaster  
Alabastro bianco



20-1310-G8-55  
6 E-14 max. 60W +  
3 E-14 max. 60W

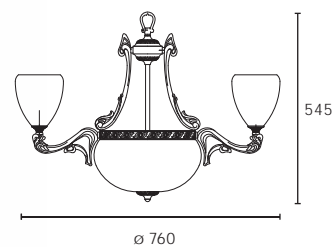

00-1308-G8-55  
3 E-14 max. 60W

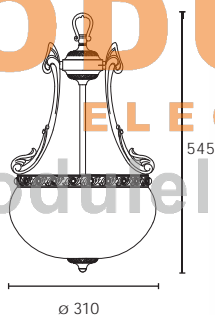
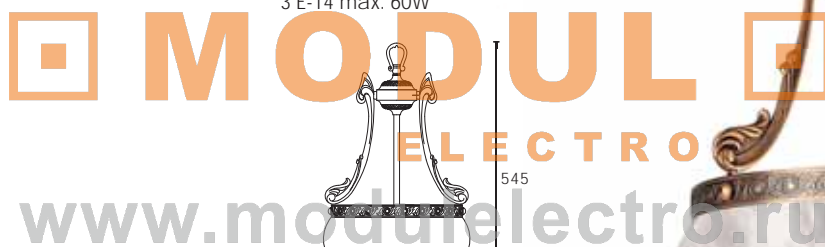

**MODULO**  
ELECTRO  
[www.modulelectro.ru](http://www.modulelectro.ru)

*Julio Ferrer*



05-1308-G8-55  
1 E-14 max. 60W

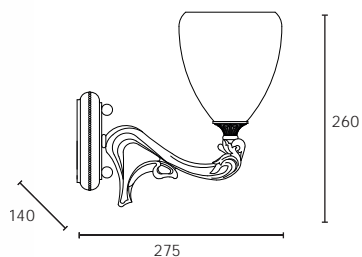





**MODUL**  
ELECTRO  
[www.modulelectro.ru](http://www.modulelectro.ru)



25-1304-G8-55

1 E-27 max. 150W

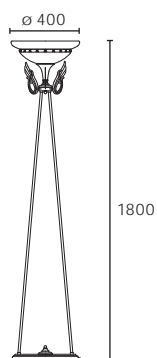

00-1304-G8-55

3 E-27 max. 60W esf. ø45

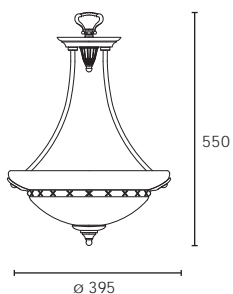

05-1304-G8-55

1 E-27 max. 60W

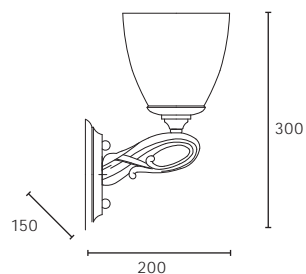



**MODUL**  
ELECTRO  
[www.modulelectro.ru](http://www.modulelectro.ru)



20-1304-G8-55

3 E-27 max. 60W +  
3 E-27 max. 60W esf. ø45

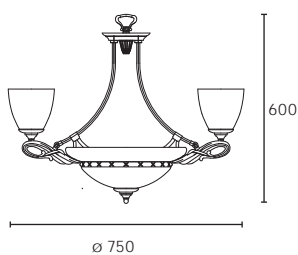

20-1306-G8-55

6 E-27 max. 60W +  
3 E-27 max. 60W esf. ø45

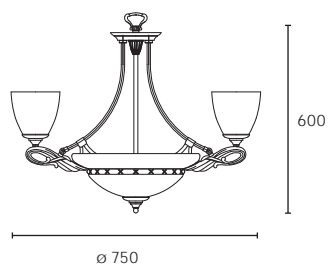

**MODUL**  
ELECTRO  
[www.modulelectro.ru](http://www.modulelectro.ru)

Acabados  
Finishes  
Finitions  
Ausführungen  
Rifiniture

B2

Marrón/patiné  
Brown/antique brass  
Marron/patiné  
Braun/Alt Messing  
Marrone/patinato

98

Alabastro blanco/talla marrón  
White alabaster/rust carvin  
Albâtre blanc/taille marron  
Weisser Alabaster/brauner Rand  
Alabastro bianco

18

Marrón  
Brown  
Marron  
Braun  
Marrone

64

Marrón/oro  
Brown/gold  
Marron/or  
Braun/Vergoldet  
Marrone/oro



**MODUL**  
ELECTRO  
[www.modulelectro.ru](http://www.modulelectro.ru)

*Axe*



**MODUL**  
ELECTRO  
[www.modulelectro.ru](http://www.modulelectro.ru)



00-5812-B2-98  
00-5812-64-98  
3 E-27 max. 60W esf. ø45

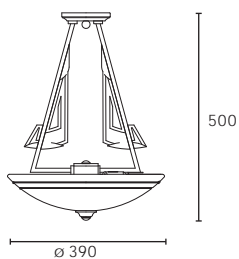

20-5812-B2-98  
20-5812-64-98  
3 E-27 max. 60W esf. ø45 +  
3 E-27 max. 40W esf. ø45

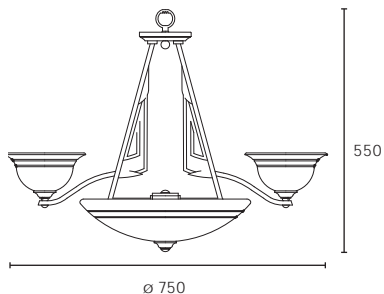

05-5812-18-98  
1 E-27 max. 60W

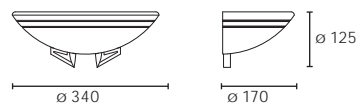



**MODUL**  
ELECTRO  
[www.modulelectro.ru](http://www.modulelectro.ru)

15-2246-B2-98  
15-2246-64-98  
3 E-27 max. 60W esf. ø45

15-2247-B2-98  
15-2247-64-98  
3 E-27 max. 60W esf. ø45

25-5812-B2-98  
25-5812-64-98  
1 E-27 max. 100W

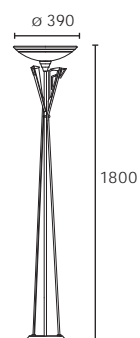
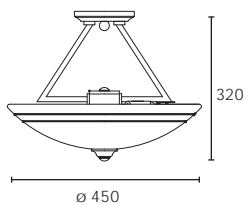
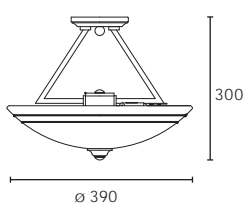



**MODULO**  
ELECTRO  
[www.modulelectro.ru](http://www.modulelectro.ru)

20-0809-50-55

6 E-27 max. 60W +  
6 E-27 max. 60W + 2 E-14 max. 40W

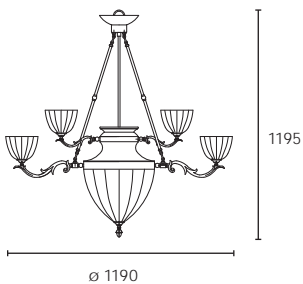

05-0805-50-55

2 E-27 max. 60W

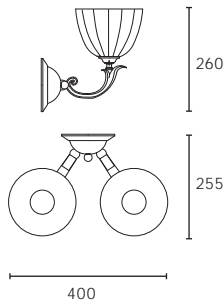

20-0803-50-55

6 E-27 max. 60W +  
2 E-14 max. 15W

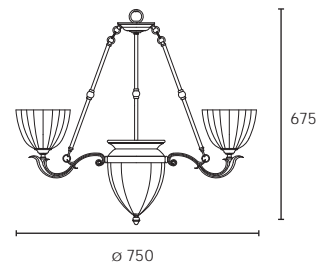

01

55

50

**Acabados**  
**Finishes**  
**Finitions**  
**Ausführungen**  
**Rifiniture**

Oro  
Gold  
Or  
Vergoldet  
Oro

Alabastro blanco  
White alabaster  
Albâtre blanc  
Weisser Alabaster  
Alabastro bianco

Patiné  
Antique brass  
Patiné  
Alt Messing  
Patinato

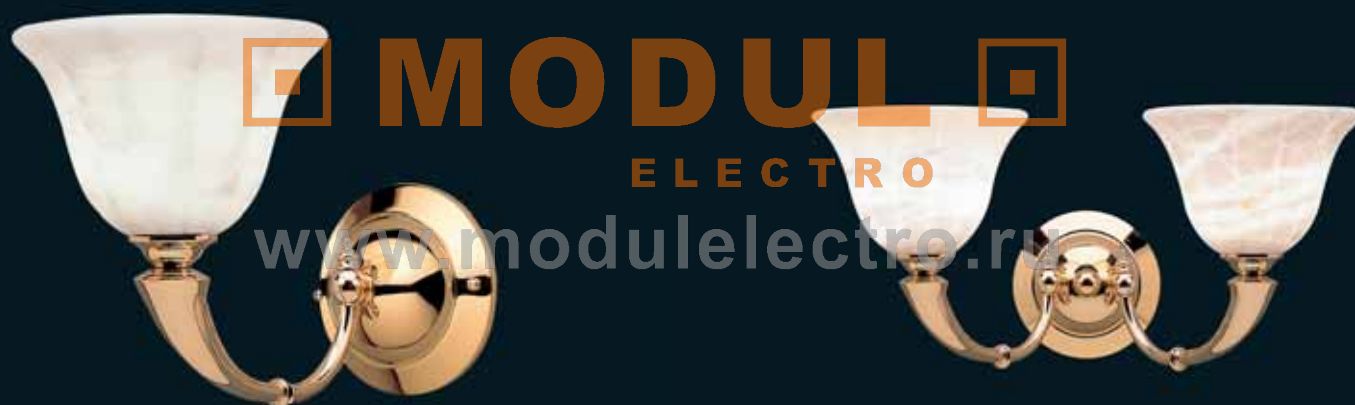

**MODULO**  
ELECTRO  
[www.modulelectro.ru](http://www.modulelectro.ru)

05-0652-01-55

1 E-27 max. 60W esf. ø45

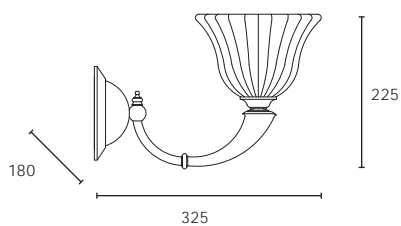

20-0652-01-55

6 E-27 max. 60W esf. ø45 +  
3 E-14 max. 15W

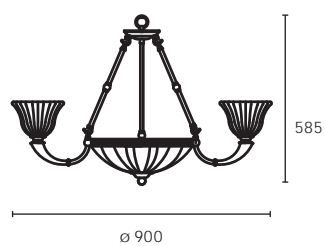

05-0663-01-55

2 E-27 max. 60W esf. ø45

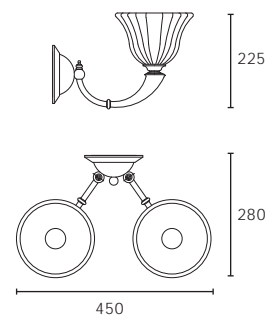





Colgantes  
Pendants  
Suspensions  
Pendelleuchten  
Pendenti

**MODULO**  
ELECTRO

[www.modulelectro.ru](http://www.modulelectro.ru)

Plafones  
Ceiling fixtures  
Plafoniers  
Deckenleuchten  
Plafoniere



 **MODUL**   
ELECTRO  
[www.modulelectro.ru](http://www.modulelectro.ru)





00-0439-01-55

3 E-27 max. 60W esf. ø45  
Ø=480 H=510

00-0440-01-55

3 E-27 max. 60W esf. ø45  
Ø=585 H=660

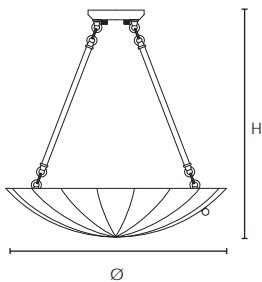

00-6259-01-55

5 E-27 max. 60W

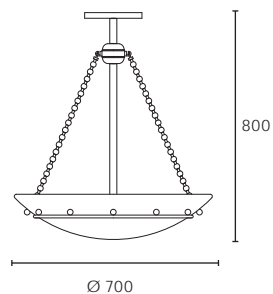

01

55

50

87

G8

**Acabados**  
**Finishes**  
**Finitions**  
**Ausführungen**  
**Rifiniture**

Oro  
Gold  
Or  
Vergoldet  
Oro

Alabastro blanco  
White alabaster  
Albâtre blanc  
Weisser Alabaster  
Alabastro bianco

Patiné  
Patiné  
Patiné  
Alt Messing  
Patinato

Alabastro ivory  
Ivory alabaster  
Alvâtre ivory  
Ivory alabaster  
Alabastro ivory

Patiné rojizo  
Red patine  
Patiné rouge  
Rot Alt Messing  
Patine rosso



00-6258-01-55

3 E-27 max. 60W

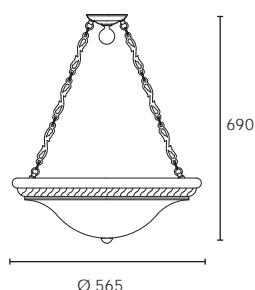

98

Alabastro blanco/talla marrón  
White alabaster/rust carving  
Âlbatre blanc/taille marron  
Weiss alabaster/brauner Rand  
Alabastro bianco/intaglio marrone

00-0419-01-55

3 E-14 max. 60W

Ø=480 H=295

00-0420-01-55

3 E-27 max. 60W esf. ø45

Ø=585 H=375

00-0421-01-55

6 E-27 max. 60W

Ø=760 H=555

64

Marrón/oro  
Brown/gold  
Marron/or  
Braun/Vergoldet  
Marrone/oro

00-0422-01-55

6 E-27 max. 60W

Ø=915 H=665

00-0423-01-55

9 E-27 max. 60W

Ø=1145 H=745

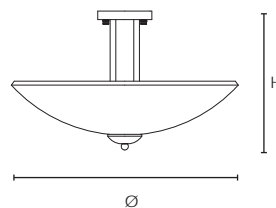

00-0692-50-87

6 E-14 max. 60W esf. ø45

Ø=480 H=560

00-0693-50-87

6 E-14 max. 60W esf. ø45

Ø=585 H=660

00-0694-50-87

6 E-14 max. 60W esf. ø45

Ø=760 H=800

00-0695-50-87

6 E-27 max. 60W

Ø=910 H=950

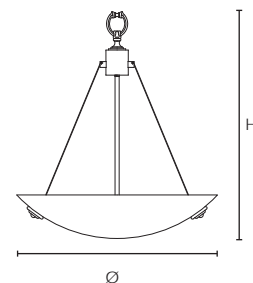



00-2154-G8-55

4 E-14 max. 60W

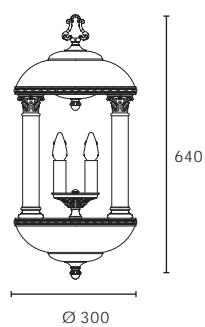

00-6228-64-55

6 E-27 max. 60W esf. Ø45

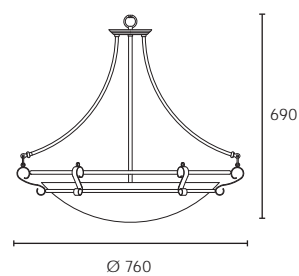



**MODUL**  
ELECTRO  
[www.modulelectro.ru](http://www.modulelectro.ru)



00-0715-01-55

3 E-27 max. 60W

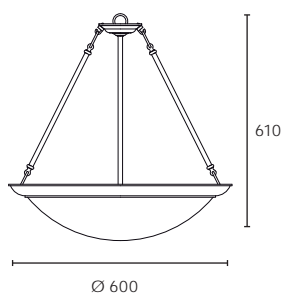

00-0434-01-98

3 E-27 max. 60W esf. ø45  
Ø=480 H=510

00-0435-01-98

3 E-27 max. 60W esf. ø45  
Ø=585 H=630

00-0436-01-98

6 E-27 max. 60W esf. ø45  
Ø=760 H=725

00-0437-01-98

6 E-27 max. 60W  
Ø=915 H=895

00-0438-01-98

9 E-27 max. 60W  
Ø=1145 H=1290

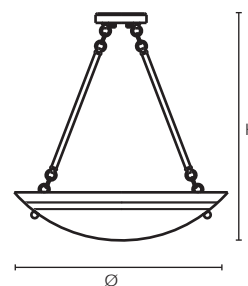



**MODUL**  
ELECTRO  
[www.modulelectro.ru](http://www.modulelectro.ru)

15-6258-01-55

3 E-27 max. 60W

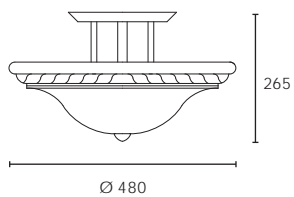

15-0651-50-87

3 E-27 max. 60W esf. ø45  
Ø=605 H=285

15-0653-50-87

6 E-27 max. 60W  
Ø=900 H=410

15-5828-50-87

3 E-27 max. 40W esf. ø45  
Ø=395 H=175

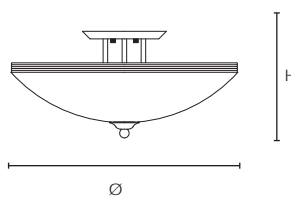

15-0721-01-55

16 E-27 max. 60W

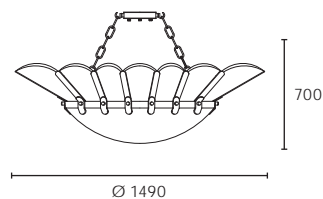



**MODULO**  
ELECTRO  
[www.modulelectro.ru](http://www.modulelectro.ru)



15-0426-01-55  
3 E-27 max. 60W. esf. ø45

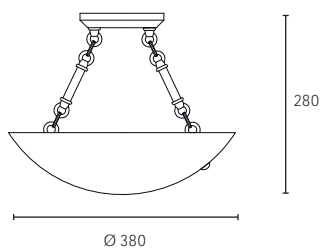

15-0415-01-55  
3 E-27 max. 60W. ø45  
Ø=585 H=330

15-0416-01-55  
6 E-27 max. 60W. ø45  
Ø=760 H=370

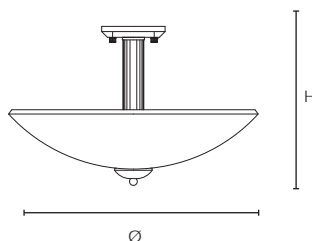

15-0443-01-55  
3 E-14 max. 60W

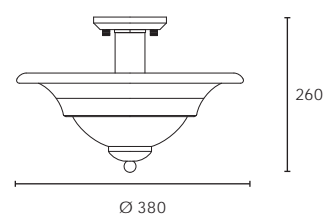





**MODUL**  
ELECTRO  
[www.modulelectro.ru](http://www.modulelectro.ru)

Apliques  
Wall fixtures  
Appliques  
Wandeleuchten  
Aplique

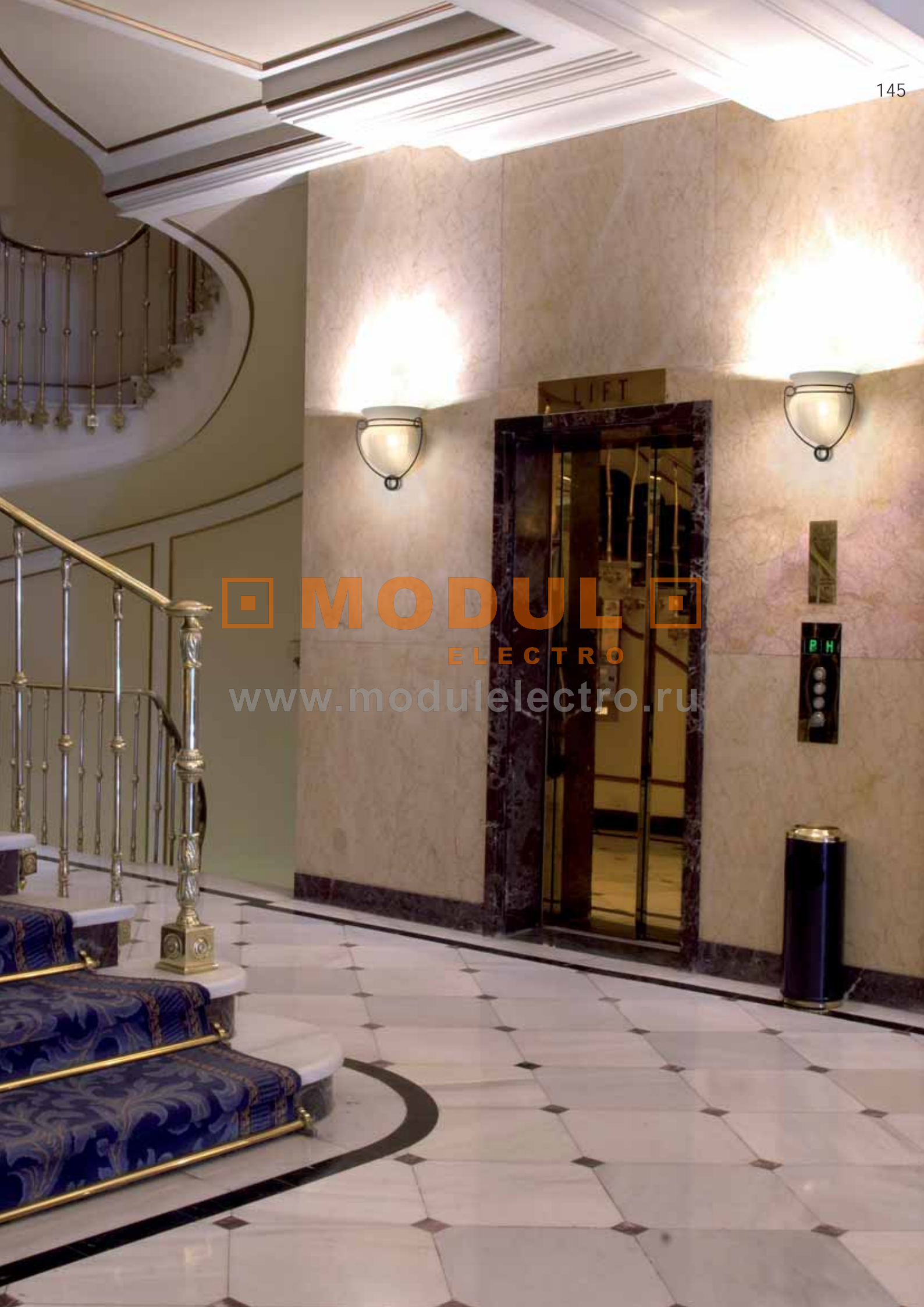

**MODUL**  
ELECTRO  
[www.modulelectro.ru](http://www.modulelectro.ru)



**MODUL**  
ELECTRO  
[www.modulelectro.ru](http://www.modulelectro.ru)



05-2114-E2-55

1 E-27 max. 60W

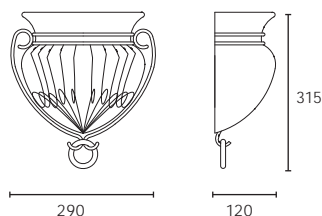

05-2128-E4-55

1 E-27 max. 60W

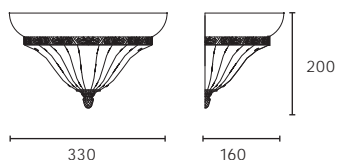

05-2110-G8-55

1 E-27 max. 60W

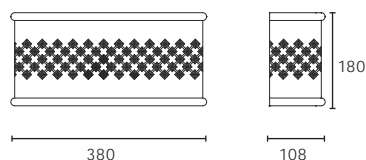

05-2132-G8-55

1 E-27 max. 60W

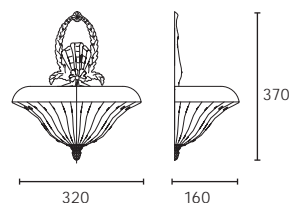

E2

55

G8

E4

**Acabados**  
**Finishes**  
**Finitions**  
**Ausführungen**  
**Rifiniture**

Oro viejo  
Old gold  
Or vieil  
Antik Gold  
Oro vecchio

Alabastro blanco  
White alabaster  
Albâtre blanc  
Weisser Alabaster  
Alabastro bianco

Patiné rojizo  
Red patine  
Patiné rouge  
Rot Alt Messing  
Patine rosso

Patiné oscuro  
Dark antique brass  
Patiné obscur  
Dunkel Alt Messing  
Patinato oscuro

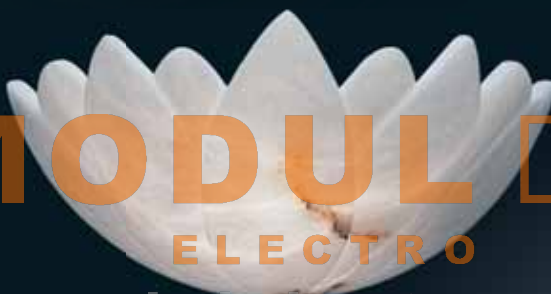

**MODUL**  
ELECTRO

[www.modulelectro.ru](http://www.modulelectro.ru)



05-1673-14-55

1 E-27 max. 60W

05-1675-14-55

1 E-27 max. 60W

05-2106-14-55

1 E-27 max. 60W

05-1679-14-87

1 E-27 max. 60W

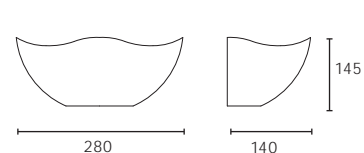
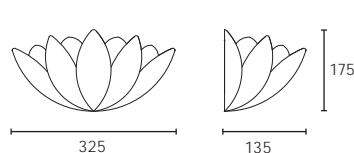
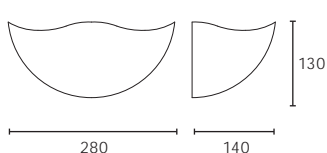
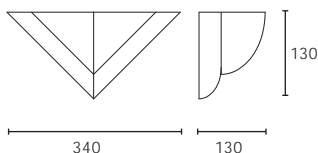

14

Blanco  
White  
Blanc  
Weiss  
Bianco

87

Alabastro ivory  
Ivory alabaster  
Alvâtre ivory  
Ivory Alabaster  
Alabastro ivory

05-1667-M9-55

1 E-14 max. 60W + 1 E-14 max. 15W

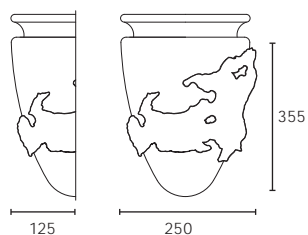

05-1664-M9-55

1 R7s max.150W L=80,5 Hal

05-1665-M9-55

1 E-14 max. 60W + 1 E-14 max. 15W

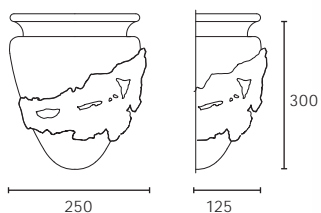

05-1654-M9-55

1 R7s max.150W L=80,5 Hal

05-1655-M9-55

1 E-27 max. 60W

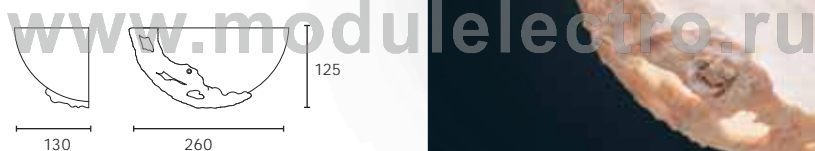

05-1656-M9-55

1 R7s max.150W L=80,5 Hal

05-1657-M9-55

1 E-14 max. 60W

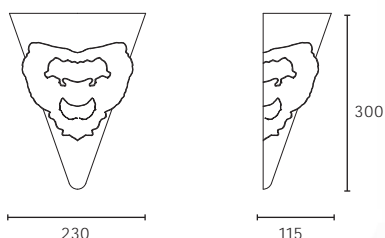

05-1662-M9-55

1 R7s max.150W L=80,5 Hal

05-1663-M9-55

1 E-27 max. 60W

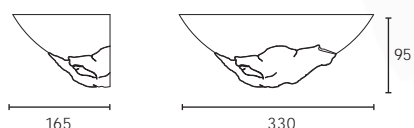

MODULO ELECTRO  
www.modulelectro.ru

Acabados  
Finishes  
Finitions  
Ausführungen  
Rifiniture

M9

Color stone  
Stone colour  
Couleur Roche  
Stein Färbig  
Colore stone

55

Alabastro blanco  
White alabaster  
Albâtre blanc  
Weisser Alabaster  
Alabastro bianco

G8

Patiné rojizo  
Red patine  
Patiné rouge  
Rot Alt Messing  
Patine rosso



05-0608-14-98

1 E-27 max. 60W

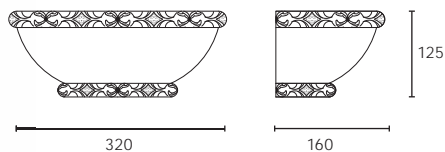

05-0818-14-98

1 E-27 max. 60W

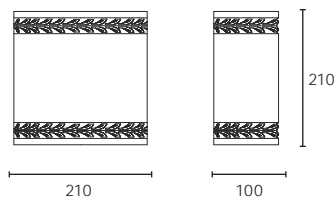

**MODULO**  
**ELECTRO**

[www.modulelectro.ru](http://www.modulelectro.ru)



05-3726-01-55

1 E-27 max. 60W

05-3727-01-55

1 R7s max.150W L=80,5 Hal

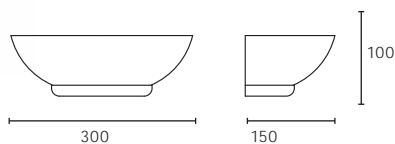

14

Blanco  
White  
Blanc  
Weiss  
Bianco

98

Alabastro blanco/  
talla marrón  
White alabaster/  
rust carvin  
Albâtre blanc/  
taille marron  
Weisser Alabaster/  
brauner Rand  
Alabastro bianco/  
intaglio marrone

01

Patiné rojizo  
Red patine  
Patiné rouge  
Rot Alt Messing  
Patine rosso



05-2104-G8-N2

1 E-27 max. 60W

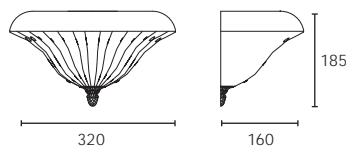

N2

Alabastro peach  
Peach alabaster  
Albâtre peach  
Peach Alabaster  
Alabastro peché



05-2134-14-H1

1 E-27 max. 60W

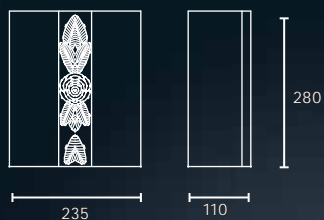

05-0468-14-55  
2 E-14 max. 60W

# MODUL

ELECTRO

[www.modulelectro.ru](http://www.modulelectro.ru)

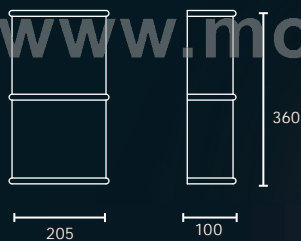
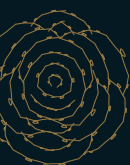

05-0470-14-87

1 E-14 max. 60W

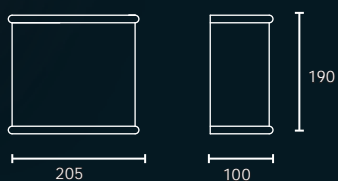



05-0836-14-55

2 E-14 max. 60W

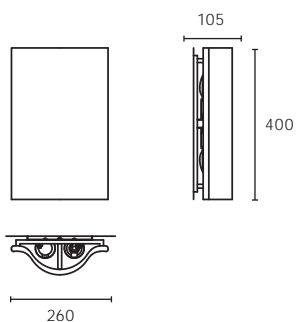

Acabados  
Finishes  
Finitions  
Ausführungen  
Rifiniture

14

Blanco  
White  
Blanc  
Weiss  
Bianco

H1

Alabastro blanco/  
talla naranja  
White alabaster/  
orange carvin  
Albâtre blanc/  
taille orange  
Weisser Alabaster/  
orange Rand  
Alabastro bianco/  
intaglio arancio

87

Alabastro ivory  
Ivory alabaster  
Alvâtre ivory  
Ivory alabaster  
Alabastro ivory

55

Alabastro blanco  
White alabaster  
Albâtre blanc  
Weisser Alabaster  
Alabastro bianco



05-0842-14-55

2 E-14 max. 60W

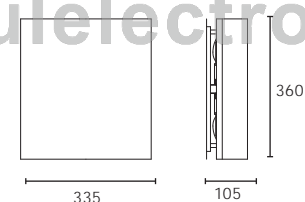

**MODULO**  
**ELECTRO**  
[www.modulelectro.ru](http://www.modulelectro.ru)



05-0839-14-55

2 E-14 max. 60W

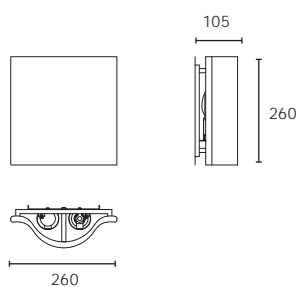





**MODUL**

**ELECTRO**

[www.modulelectro.ru](http://www.modulelectro.ru)



05-3650-14-55

1 E-27 max. 60W

05-3651-14-55

1 R7s max. 150W L=80,5 Hal

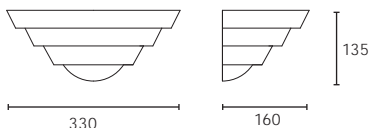

05-3730-14-55

1 E-27 max. 60W

05-3731-14-55

1 R7s max. 150W L=80,5 Hal

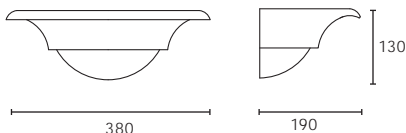

05-0439-14-55

1 R7s max. 150W L=80,5 Hal  
A=280 S=140 H=135

05-0441-14-55

1 R7s max. 150W L=80,5 Hal  
A=330 S=160 H=165

05-0442-14-55

1 E-27 max. 60W  
A=330 S=160 H=165

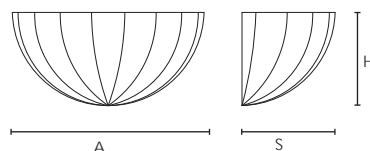

14

55

**Acabados**  
**Finishes**  
**Finitions**  
**Ausführungen**  
**Rifiniture**

Blanco  
White  
Blanc  
Weiss  
Bianco

Alabastro blanco  
White alabaster  
Albâtre blanc  
Weisser Alabaster  
Alabastro bianco



**MODUL**  
ELECTRO  
[www.modulelectro.ru](http://www.modulelectro.ru)

05-3656-14-55

1 E-27 max. 60W  
A=330 S=160 H=165

05-3657-14-55

1 R7s max. 150W L=80,5 Hal  
A=330 S=160 H=165

05-3658-14-55

1 E-27 max. 60W  
A=280 S=140 H=135

05-3659-14-55

1 R7s max. 150W L=80,5 Hal  
A=280 S=140 H=135

05-0833-14-55

1 E-27 max. 60W

05-0834-14-55

1 R7s max. 150W L=80,5 Hal

05-3722-14-55

1 E-27 max. 60W

05-3723-14-55

1 R7s max. 150W L=80,5 Hal

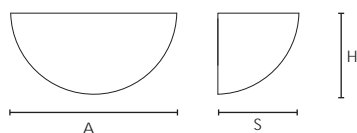
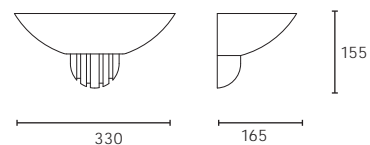
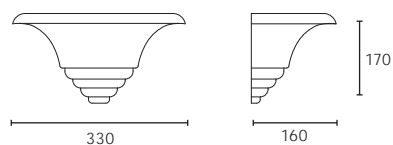

05-3664-14-87

1 E-27 max. 60W

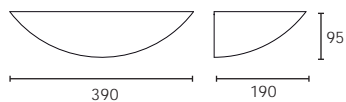

05-3666-14-87

1 E-27 max. 60W



05-3667-14-87

1 R7s max. 150W L=80,5 Hal

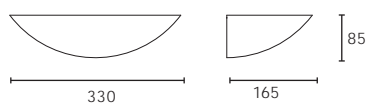

05-0462-14-87

1 E-27 max. 60W

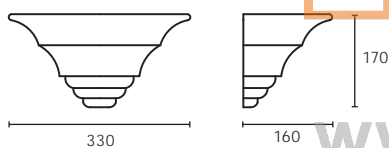

**MODUL**  
ELECTRO  
[www.modulelectro.ru](http://www.modulelectro.ru)

05-0448-14-87

1 E-27 max. 60W

05-0449-14-87

1 R7s max. 150W L=80,5 Hal

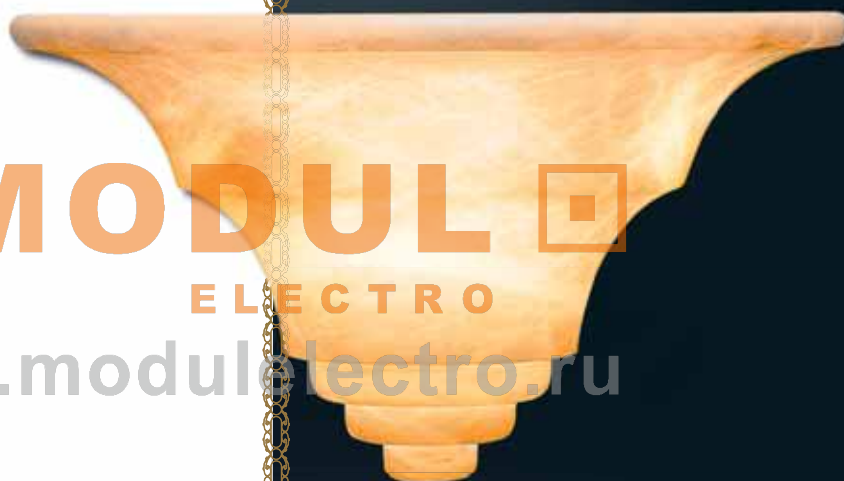
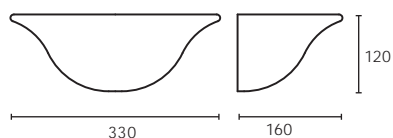

14 87

**Acabados**  
**Finishes**  
**Finitions**  
**Ausführungen**  
**Rifiniture**

Blanco  
White  
Blanc  
Weiss  
Bianco

Alabastro ivory  
Ivory alabaster  
Alvâtre ivory  
Ivory alabaster  
Alabastro ivory



05-0273-G8-55

1 E-14 max. 60W

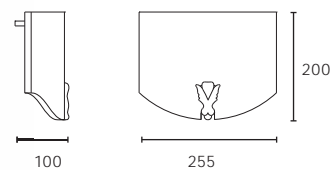

**MODUL**  
ELECTRO  
[www.modulelectro.ru](http://www.modulelectro.ru)

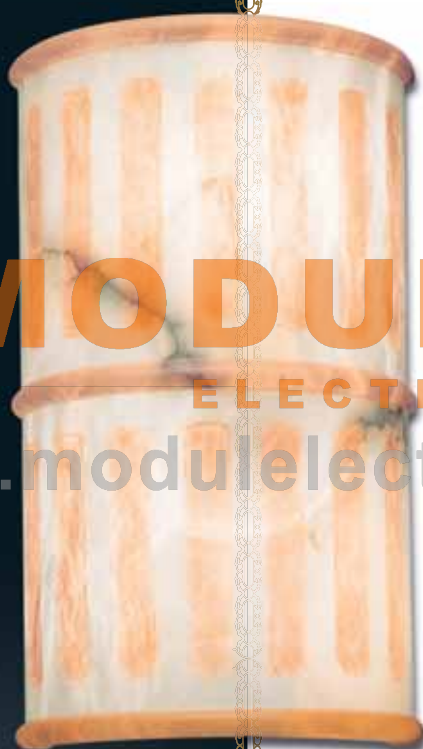

05-0277-14-U9

2 E-14 max. 60W

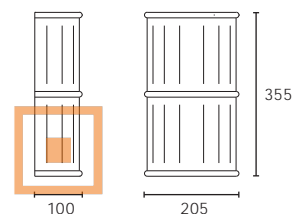

05-0276-14-U9

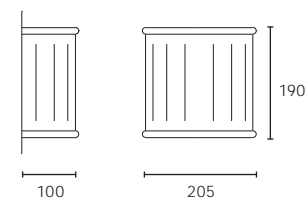

1 E-14 max. 60W



## U9

Alabastro blanco con talla color beige  
White alabaster with beige carvin  
Albâtre blanc avec taille beige  
Weisser Alabaster mit Beige Rand  
Alabastro bianco con intanglio colore beige

Lámparas de mesa  
Table lamps  
Lampes de table  
Tischleuchten  
Lampade da tavolo

 **MODUL**   
ELECTRO  
[www.modulelectro.ru](http://www.modulelectro.ru)



 **MODUL**   
ELECTRO

[www.modulelectro.ru](http://www.modulelectro.ru)





10-1409-01-82

1 E-27 max. 60W + 1 E-14 max. 40W

Pantalla / shade / abat-jour  
Stoffschirm / schermo

Ref. Pan-077-20

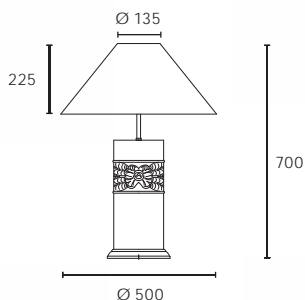

10-1402-01-82

1 E-27 max. 60W + 1 E-14 max. 40W

Pantalla / shade / abat-jour  
Stoffschirm / schermo

Ref. Pan-068-20

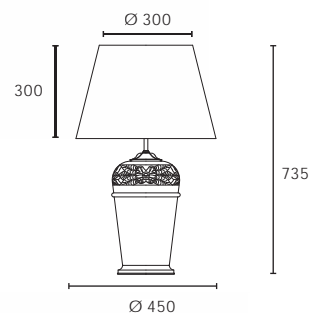

**MODUL**  
ELECTRO  
www.modulelectro.ru

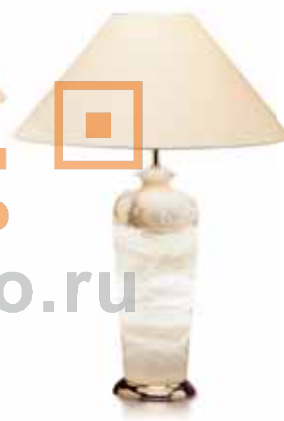
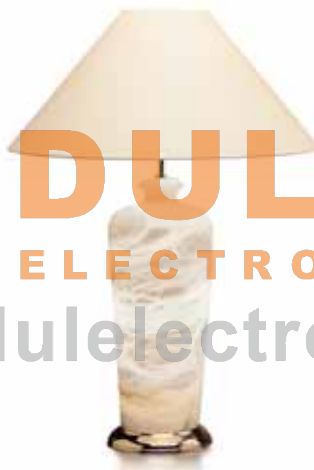

10-1404-01-82

1 E-27 max. 60W + 1 E-14 max. 40W

Pantalla / shade / abat-jour  
Stoffschirm / schermo

Ref. Pan-077-20

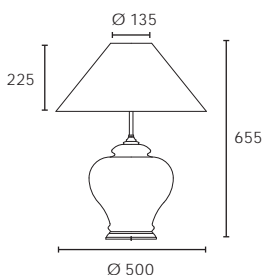

10-1399-01-82

1 E-27 max. 60W + 1 E-14 max. 40W

Pantalla / shade / abat-jour  
Stoffschirm / schermo

Ref. Pan-077-20

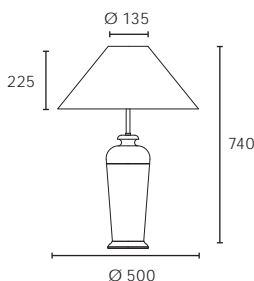

10-1398-01-82

1 E-27 max. 60W + 1 E-14 max. 40W

Pantalla / shade / abat-jour  
Stoffschirm / schermo

Ref. Pan-078-20

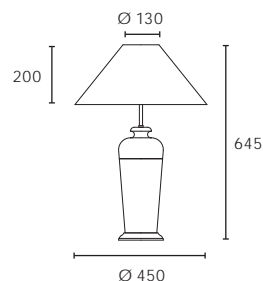

01 82 X3

Acabados  
Finishes  
Finitions  
Ausführungen  
Rifiniture

Patiné rojizo  
Red patine  
Finitions  
Ausführungen  
Rifiniture

Sin pantalla de tela  
Without fabric shade  
Sans abat-jour en tissu  
Ohne Stoffschirm  
Enza schermo di tela

Sin pantalla/alabastro ivory con talla marrón  
Without fabric shade/ivory alabaster with rust carvin  
Sans abat-jour/albâtre ivory avec taille marron  
Ohne Stoffschirm/Weisser Alabaster mit brauner Rand  
Senza schermo di tela/alabastro ivory con intaglio marrone



10-0287-G8-55

1 G9 max. 75W + 1 E-14 max. 15W

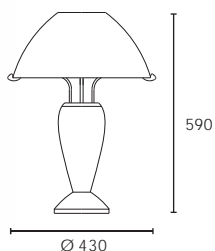

25-0290-G8-55

1 E-27 max. 150W + 1G13 fluor. 58W

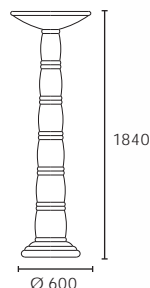

**MODULO**  
ELECTRO  
[www.modulelectro.ru](http://www.modulelectro.ru)

71-0161-14-C1

1G13 fluor. 16W

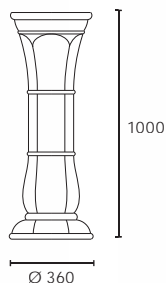

10-0161-01-X3

1 E-27 max. 150W + 1G13 fluor. 18W

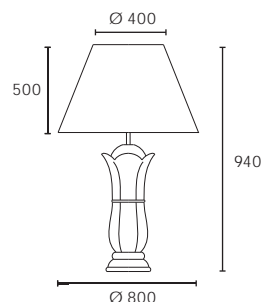

Sin pantalla de charol negro / Without black patent leather shade / Sans abat-jour en vernis noire / Ohne schwarzen chintzschirm

Pantalla / shade / abat-jour / Stoffschirm / schermo

Ref. Pan-112-X4

G8

Patiné rojizo  
Red patine  
Patiné rouge  
Rot Alt Messing  
Patine rosso

55

Alabastro blanco  
White alabaster  
Albâtre blanc  
Weisser Alabaster  
Alabastro bianco

14

Blanco  
White  
Blanc  
Weiss  
Bianco

C1

Alabastro ivory/talla marrón  
Ivory alabaster/rust carvin  
Albâtre ivory/taille marron  
ivory Alabaster/brauner Rand  
Alabastro ivory/intaglio marrone

Para conjunto completo solicite referencias de luminaria y pantalla / For complete set please order by separate fixture and shade references / Demandez le code de luminaire et abat-jour en cas de set complete / Für komplette Leuchte, bestellen Sie bitte Lampe und Schirm getrennt / Per il set completo, chiedere la referenza dell'apparecchio ed il paralume.





160

**MODUL**

**ELECTRO**

[www.modulelectro.ru](http://www.modulelectro.ru)

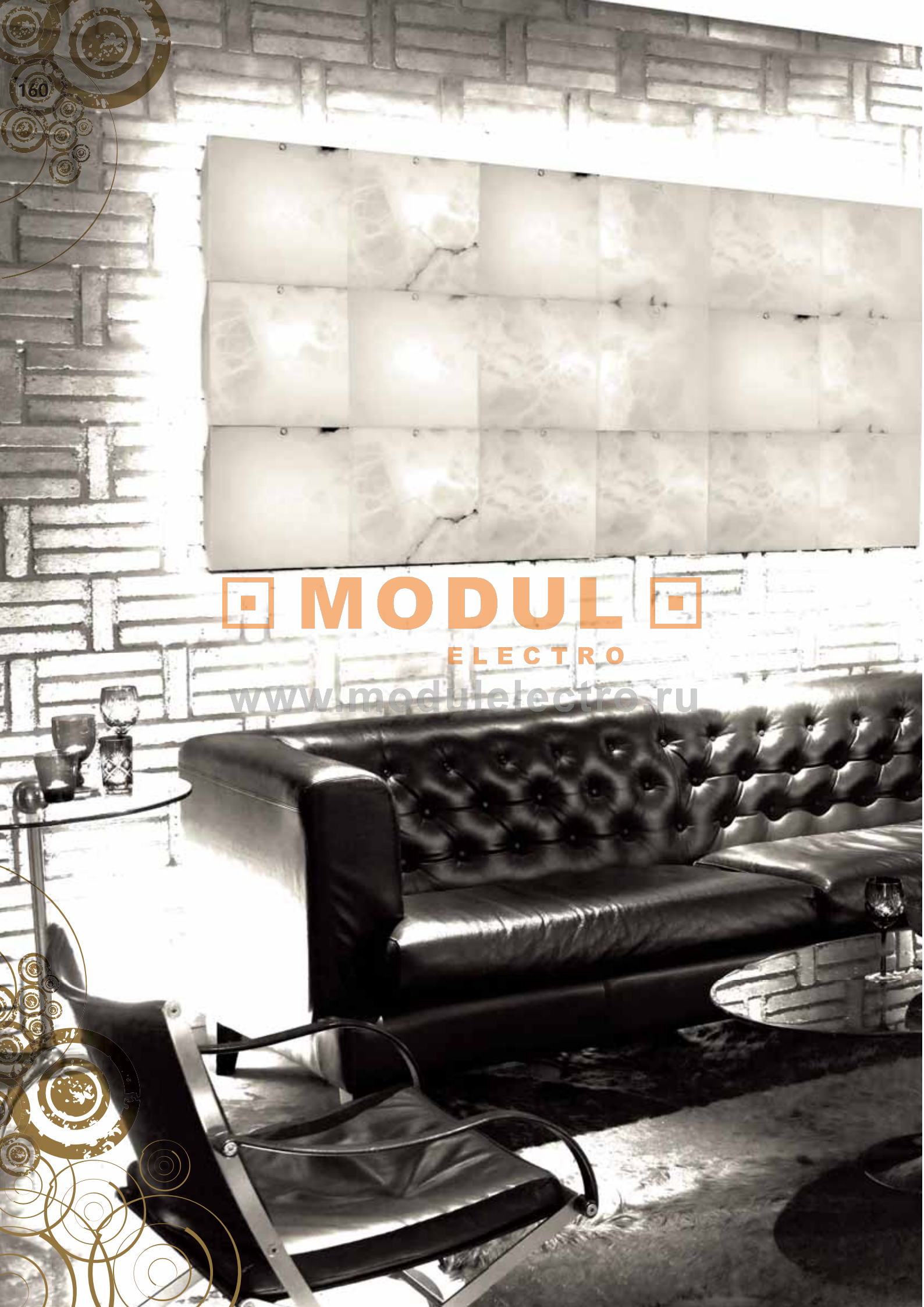

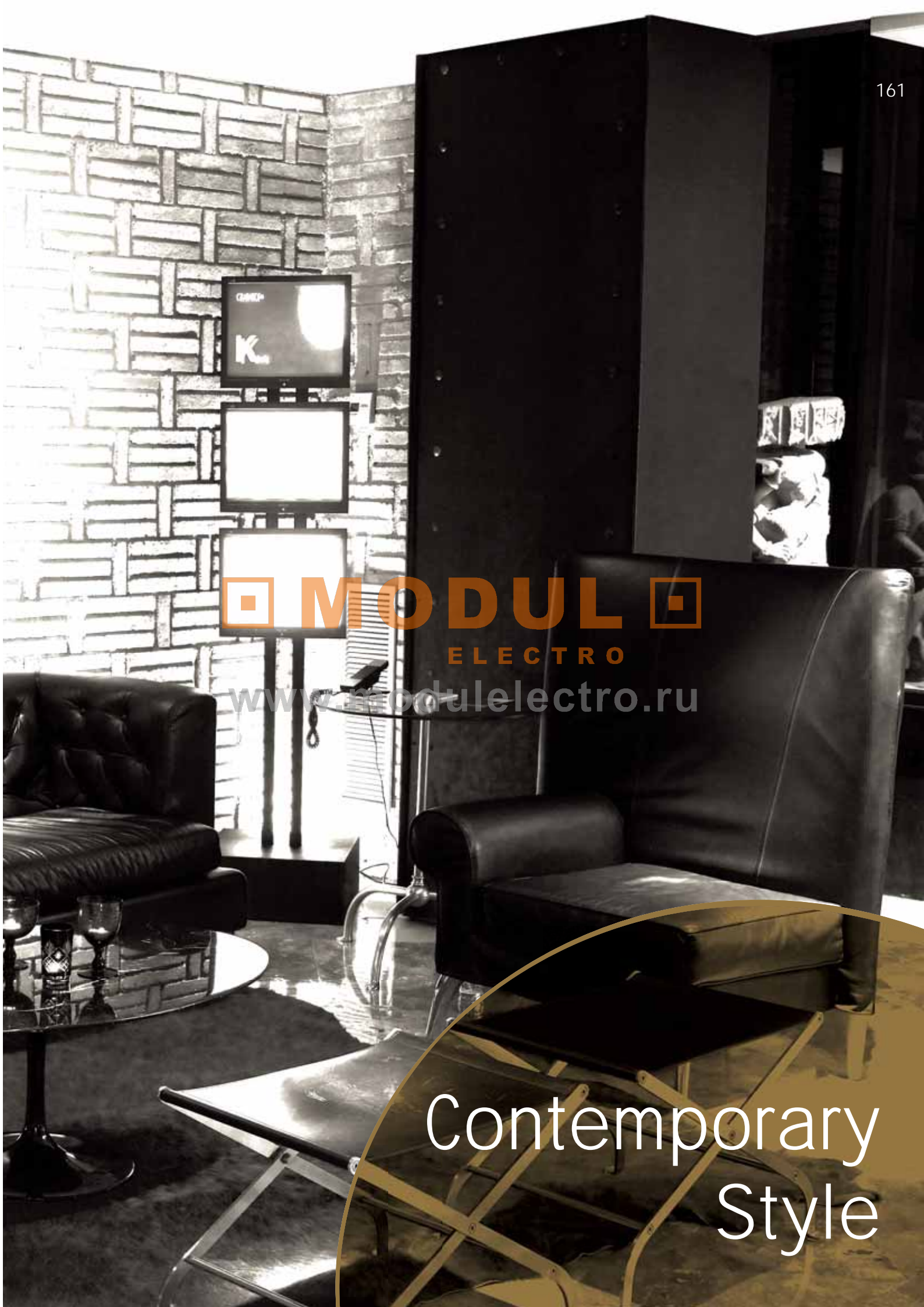

**MODUL**  
ELECTRO  
[www.modulelectro.ru](http://www.modulelectro.ru)

Contemporary  
Style

# MODUL

ELECTRO

[www.modulelectro.ru](http://www.modulelectro.ru)



Acabados  
Finishes  
Finitions  
Ausführungen  
Rifiniture

81

Niquel satinado  
Satin nickel  
Nickel satiné  
Satiniertes Nickel  
Nichel satinato

55

Alabastro blanco  
White alabaster  
Albâtre blanc  
Weisser Alabaster  
Alabastro bianco

 **MODUL**   
ELECTRO  
[www.modulelectro.ru](http://www.modulelectro.ru)





**MODUL**  
ELECTRO  
[www.modulelectro.ru](http://www.modulelectro.ru)

05-2737-81-55

1 x T5 14W HE **INCLUDED**  
1 CE Electronic Ballast **INCLUDED**

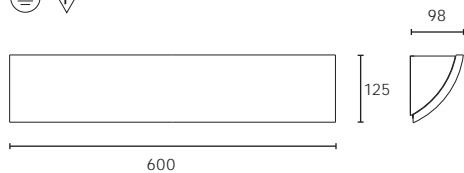

05-2738-81-55

1 x T5 28W HE **INCLUDED**  
1 CE Electronic Ballast **INCLUDED**

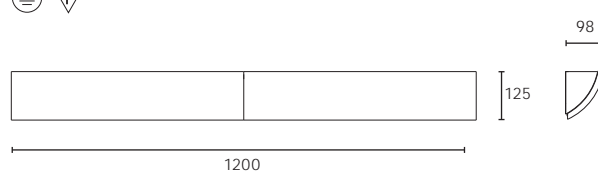



**MODUL**  
ELECTRO  
[www.modulelectro.ru](http://www.modulelectro.ru)

05-2743-81-55

1 x T5 14W HE **INCLUDED**  
1 CE Electronic Ballast **INCLUDED**

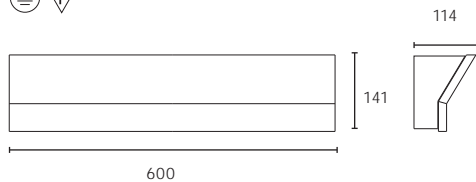

05-2744-81-55

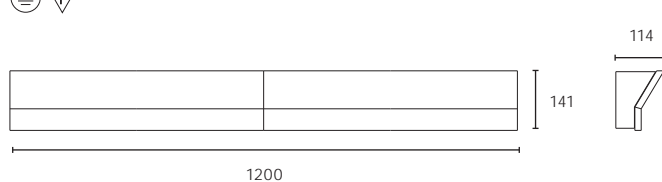

1 x T5 28W HE **INCLUDED**  
1 CE Electronic Ballast **INCLUDED**





**MODUL**  
ELECTRO  
[www.modulelectro.ru](http://www.modulelectro.ru)



 **MODUL**   
ELECTRO  
[www.modulelectro.ru](http://www.modulelectro.ru)







**MODUL**  
ELECTRO  
[www.modulelectro.ru](http://www.modulelectro.ru)



**MODUL**  
ELECTRO  
[www.modulelectro.ru](http://www.modulelectro.ru)

05-2739-81-55

1 x T5 14W HE **INCLUDED**  
1 CE Electronic Ballast **INCLUDED**

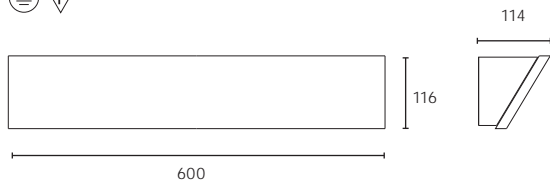

05-2740-81-55

1 x T5 28W HE **INCLUDED**  
1 CE Electronic Ballast **INCLUDED**

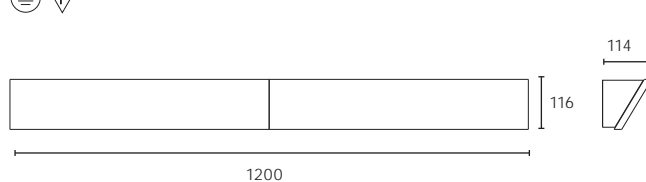



**MODUL**  
ELECTRO  
[www.modulelectro.ru](http://www.modulelectro.ru)

Acabados  
Finishes  
Finitions  
Ausführungen  
Rifiniture

14

Blanco  
White  
Blanc  
Weiss  
Bianco

55

Alabastro blanco  
White alabaster  
Albâtre blanc  
Weisser Alabaster  
Alabastro bianco



05-2748-14-55

6 x GX24q-4 42W INCLUDED

3 CE Electronic Ballast INCLUDED

IP 21

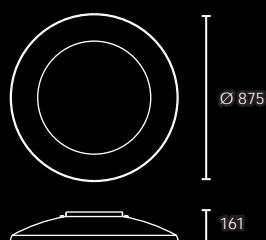

**MODUL**  
ELECTRO

[www.modulelectro.ru](http://www.modulelectro.ru)

05-2747-14-55

1 x T5 tubular 55W INCLUDED

1 CE Electronic Ballast INCLUDED

IP 21

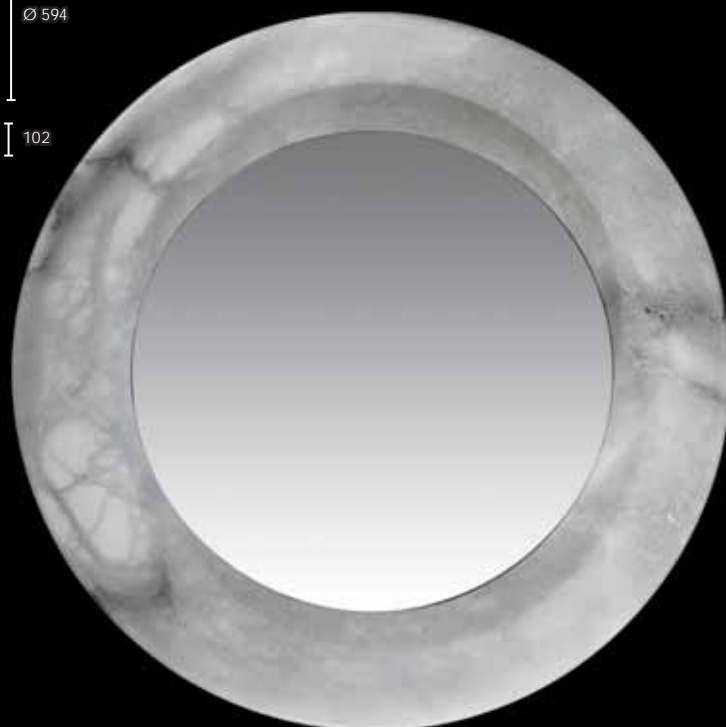
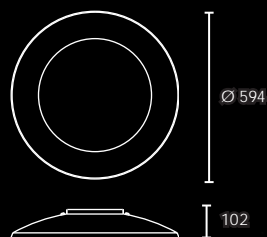

**MODUL**  
 ELECTRO  
[www.modulectro.ru](http://www.modulectro.ru)

Acabados  
 Finishes  
 Finitions  
 Ausführungen  
 Rifiniture

21

Cromo  
 Chrome  
 Chrome  
 Chrom  
 Cromo

55

Alabastro blanco  
 White alabaster  
 Albâtre blanc  
 Weisser Alabaster  
 Alabastro bianco



05-2745-21-55

2 x T5 28W HE +

2 x T5 14W HE **INCLUDED**2 CE Electronic Ballast **INCLUDED**

IP 44

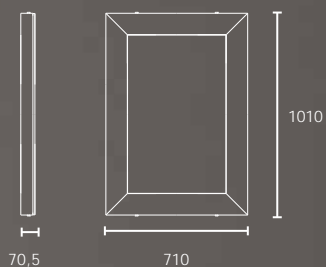

**MODUL**  
ELECTRO

[www.modulelectro.ru](http://www.modulelectro.ru)

05-2746-21-55

4 x T5 28W HE **INCLUDED**2 CE Electronic Ballast **INCLUDED**

IP 44

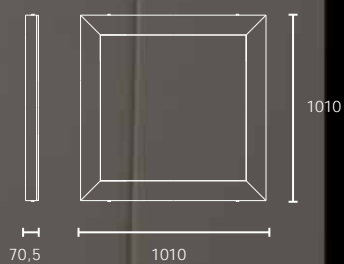



**MODUL**  
ELECTRO  
[www.modulelectro.ru](http://www.modulelectro.ru)



Acabados  
Finishes  
Finitions  
Ausführungen  
Rifiniture

21 55

Cromo  
Chrome  
Chrome  
Chrom  
Cromo

Alabastro blanco  
White alabaster  
Albâtre blanc  
Weisser Alabaster  
Alabastro bianco



# MODUL

ELECTRO

[www.modulelectro.ru](http://www.modulelectro.ru)







# MODUL

## ELECTRO

[www.modulelectro.ru](http://www.modulelectro.ru)



05-2733-21-55

1 x T5 14W HE INCLUDED  
1 CE Electronic Ballast INCLUDED

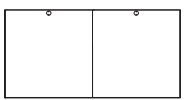

603

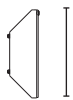

105

302

05-2734-21-55

1 x T5 21W HE INCLUDED  
1 CE Electronic Ballast INCLUDED

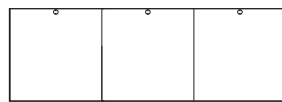

903

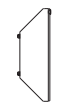

105

302



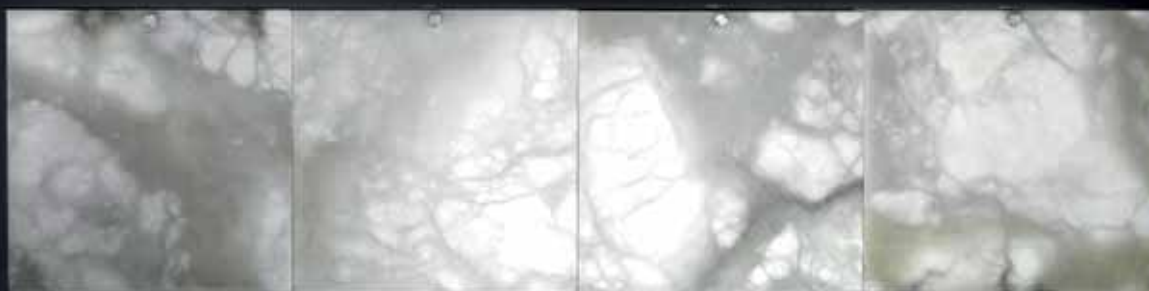

# MODUL

ELECTRO

[www.modulelectro.ru](http://www.modulelectro.ru)

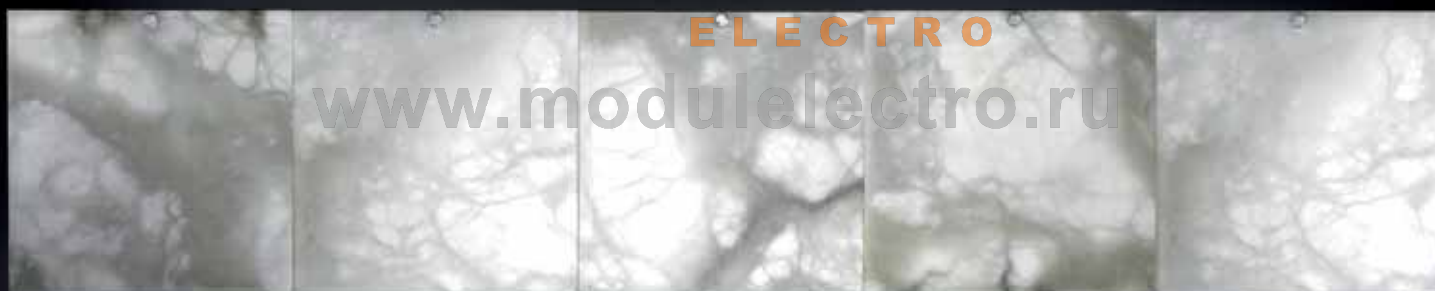

05-2735-21-55

1 x T5 28W HE INCLUDED

1 CE Electronic Ballast INCLUDED

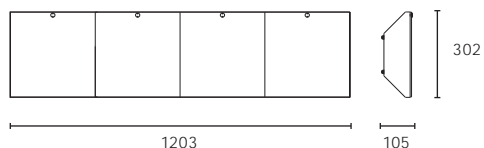

05-2736-21-55

1 x T5 35W HE INCLUDED

1 CE Electronic Ballast INCLUDED

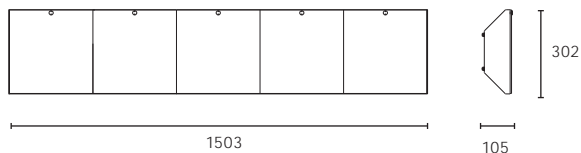

  
**MODUL**  
ELECTRO  
[www.modulelectro.ru](http://www.modulelectro.ru)



**MODULO**  
ELECTRO  
[www.modulelectro.ru](http://www.modulelectro.ru)



**MODUL**  
ELECTRO  
[www.modulelectro.ru](http://www.modulelectro.ru)





Les presentamos algunas de las posibles composiciones decorativas que ustedes podrán conseguir combinando nuestros paneles modulares de alabastro.

We are pleased to introduce you some of the possible decorative compositions that you will be able to obtain combining our modular alabaster panels.

Nous vous présentons quelques unes des possibilités de compositions décoratives que vous pourrez obtenir en combinant nos panneaux modulables en Albâtre.

Wir stellen Ihnen einige dekorative Kompositionen vor. Diese Kompositionen sind mit die Zusammenstellung unser modulare Alabasterpaneelen erreichbar.

Vi presentiamo alcune delle composizione decorative che potranno ottenere combinando i nostri pannelli di alabastro.

**MODULO**  
**ELECTRO**

[www.modulelectro.ru](http://www.modulelectro.ru)

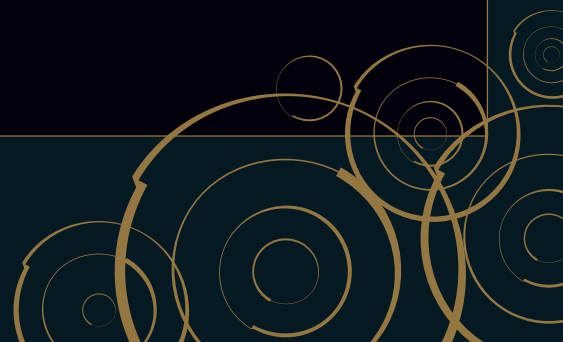
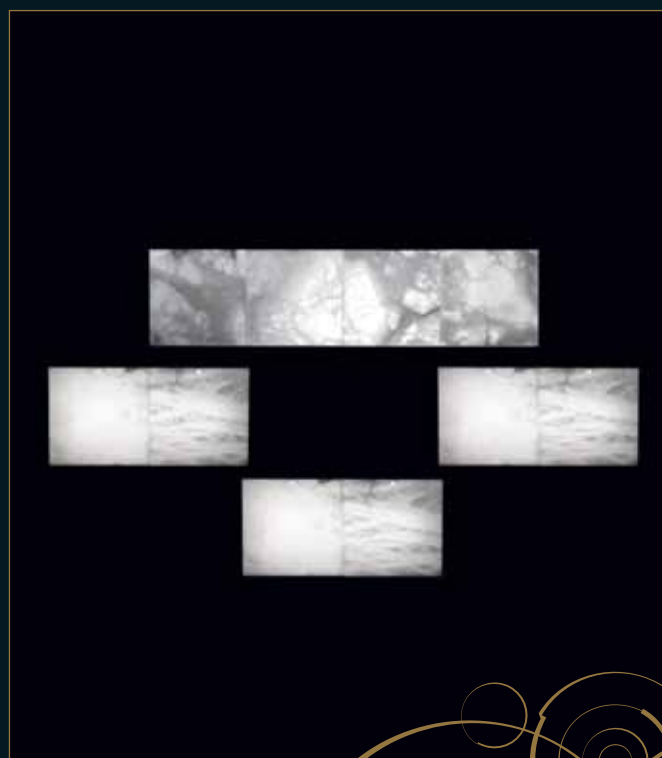
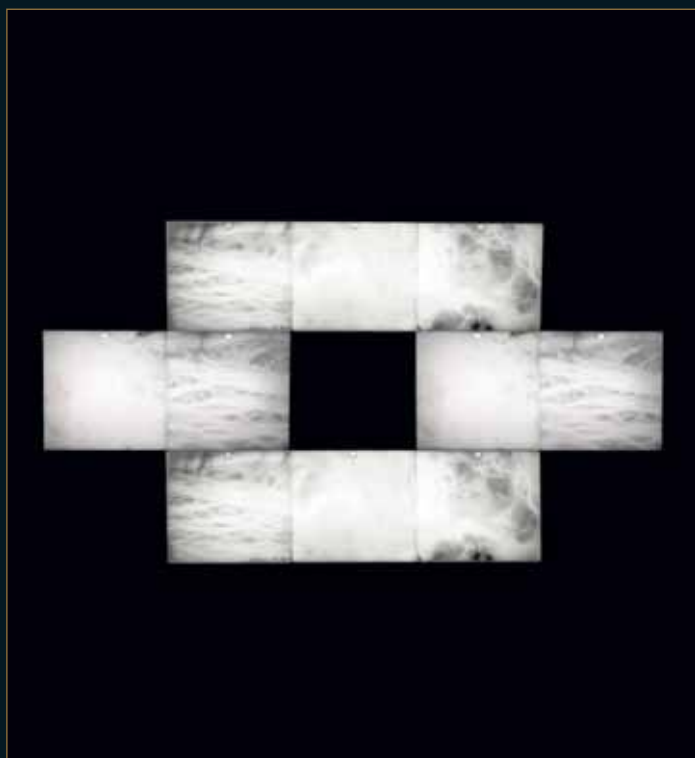

## Paneles de alabastro · Albaster panels · Panneaux d'albâtre Alabasterplatten · Panelli di alabastro

LEDS-C4 empresa líder en la transformación del alabastro, nos ofrece la nobleza de este material en la decoración de espacios mediante paneles iluminados. LEDS-C4 cuenta con los recursos humanos y técnicos necesarios para ofrecer la mejor solución a cada proyecto personalizado y hacer realidad las más exigentes y creativas ideas.

LEDS-C4, world leader in manufacturing alabaster products, offers the use of alabaster in illuminated panels for decorating space, amongst the wide range of applications that this noble material possesses. LEDS-C4 has sufficient human and technical resources to achieve the best solution to each personalised project, and make the most demanding and creative ideas possible.

LEDS-C4, entreprise leader dans la transformation de l'albâtre, parmi le grand éventail de possibilités qu'offre la noblesse de ce matériel, réside dans la décoration des espaces avec des panneaux illuminés. LEDS-C4 dispose des ressources humains et techniques nécessaires pour offrir la meilleure solution à chaque projet personnalisé et transformer en réalités des idées les plus exigeantes et les plus créatives.

Ejemplo de panel iluminado con leds RGB.  
Example of illuminated panel with RGB leds.

LEDS-C4, als führenden alabasterverarbeitenden Unternehmen, bietet dieses noble Material, die Raumdekoration mit beleuchteten Platten den wichtigsten Platz einnimmt. LEDS-C4 hat Das Know-How unseres Mitarbeiteres sowie unsere technische Möglichkeiten, die unseren Kunden die beste Lösung für jedes konkrete Objekt garantieren, damit auch die anspruchsvollsten und kreativsten Ideen ihre Umsetzung finden.

LEDS-C4 impresa leader nella trasformazione dell'alabastro, ci offre la nobiltà di questo materiale nel campo della decorazione di spazi con pannelli illuminati. LEDS-C4 può contare sulle risorse umane e tecniche necessarie per fornire la migliore soluzione a ogni progetto personalizzato e per rendere realtà le idee più esigenti e creative.

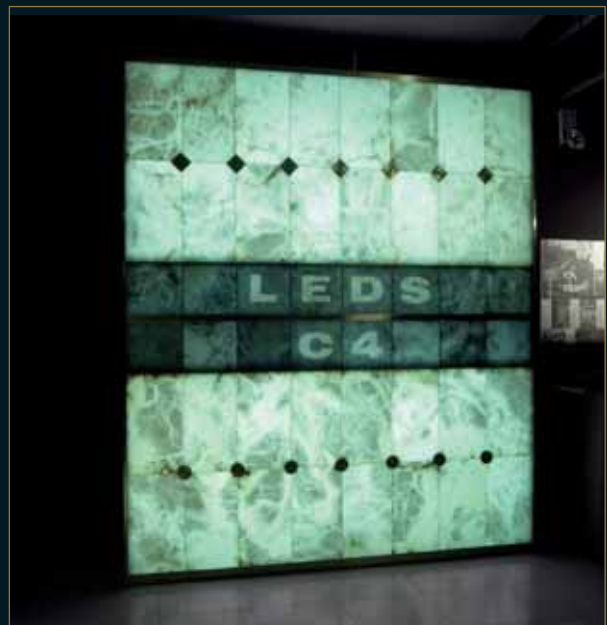



# MODUL

## ELECTRO

[www.modulelectro.ru](http://www.modulelectro.ru)

EASY PANEL es un nuevo sistema especialmente ideado para decorar paredes o techos mediante paneles de alabastro iluminados.

EASY PANEL es un sistema abierto que se caracteriza por su facilidad de montaje e instalación y por su versatilidad en cuanto a dimensiones que facilitan su adaptación a cualquier espacio u obra.

LEDS-C4 has designed a new system called "EASY PANEL" specially to decorate walls or ceilings by means of illuminated alabaster panels.

"EASY PANEL" is an open system which is characterised by its ease of assembly and installation, as well as its versatility of size which facilitate its adaptation to any space or works.

"EASY PANEL" est un nouveau système spécialement conçu pour la décoration de murs et plafonds à l'aide de panneaux d'albâtre illuminés.

"EASY PANEL" est un système ouvert, caractérisé par sa simplicité de montage et installation ainsi que par sa gamme de dimensions, qui facilitent son adaptation à tout type d'espace.

"EASY PANEL" ist ein neues System, welches speziell für die Dekoration von Wänden und Decken mit beleuchteten Alabasterplatten entwickelt wurde.

"EASY PANEL" wurde als offenes System konzipiert. Er zeichnet sich durch seine einfache Montage bzw. Installation sowie durch seine vielfältigen Massgestaltungsmöglichkeiten aus. Ein System für jeden Platz.

EASY PANEL è un nuovo sistema appositamente progettato per decorare pareti o soffitti con pannelli illuminati di alabastro.

EASY PANEL è un sistema aperto che si caratterizza per la sua facilità di montaggio e di installazione e per la sua versatilità in fatto di dimensioni che facilitano il suo adattamento a qualsiasi spazio o struttura.





La placa de alabastro se desliza.

The alabaster panel can slide.

Le panneau d'albâtre glisse sur son rail

Gleitende Alabasterplatten

La lastra di alabastro è scorrevole.

COMPOSICIÓN HORIZONTAL  
COMPOSITION HORIZONTALE  
COMPOSIZIONE ORIZZONTALE

HORIZONTAL COMPOSITION  
HORIZONTALER AUF BRAU

COMPOSICIÓN VERTICAL  
COMPOSITION VERTICALE  
COMPOSIZIONE VERTICALE

VERTICAL COMPOSITION  
VERTIKALER AUF BRAU

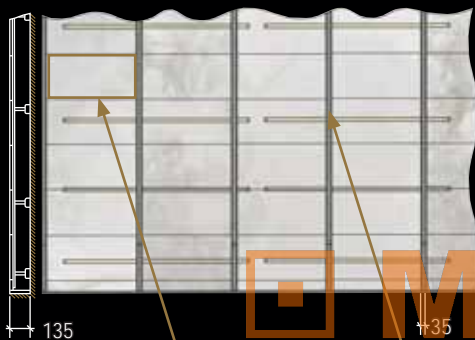

Paneles de alabastro de 600x300x15 mm  
Alabaster panels 600x300x15mm  
Le panneau d'albâtre glisse sur son rail  
Alabasterplatten 600x300x15mm  
Pannelli di alabastro di 600x300x15mm

Carriles de 35 mm  
Runners 35 mm  
Ralls 35 mm  
Schienen 35 mm  
Rotale di 35mm

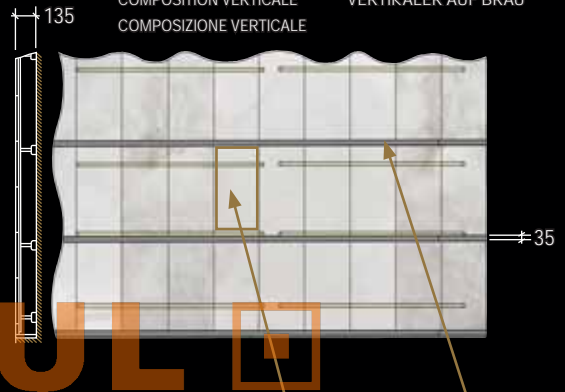

Paneles de alabastro de 600x300x15 mm  
Alabaster panels 600x300x15mm  
Le panneau d'albâtre glisse sur son rail  
Alabasterplatten 600x300x15mm  
Pannelli di alabastro di 600x300x15mm

Carriles de 35 mm  
Runners 35 mm  
Ralls 35 mm  
Schienen 35 mm  
Rotale di 35mm

**MODUL**  
ELECTRO  
www.modulelectro.ru

#### ESTRUCTURA

El sistema está basado en una estructura metálica fijada al techo o pared, incorporando una serie de carriles por los que se deslizan las placas de alabastro. Medidas standard recomendads: 600x300x15mm.

#### STRUCTURE

The system is based on a metal structure fixed to the ceiling or wall, incorporating a series of runners through which the alabaster panels can slide. (Standard recommended measurements: 600x300x15mm).

#### STRUCTURE

Le système est basé sur une structure métallique fixée au plafond ou au mur, qui incorpore une série de rails sur lesquels les plaques d'albâtre glissent. (Dimensions standard recommandées: 600x300x15mm).

#### STRUKTUR

An einer Wand oder Decke eingelassenen Metallstruktur werden mehrere Schienen angebracht, an welchen die Alabasterplatten entlang gleiten. (Empfohlene Standardmasse: 600x300x15mm.)

#### STRUTTURA

Il sistema si basa su di una struttura metallica fissata al soffitto o alla parete e incorpora una serie di rotaie sulle quali scorrono le lastre di alabastro. Misure standard raccomandate: 600x300x15mm.

#### ILUMINACIÓN

La iluminación standard de los paneles está formada por componentes convencionales de fluorescencia. (Reactancias electromagnéticas y tubos de 26mm. de diámetro).

#### LIGHTING

The standard illumination of the panels is formed through conventional fluorescent components. (Electromagnetic ballast and tubes with 26 mm. Diameter).

#### ÉCLAIRAGE

L'éclairage standard des panneaux est fourni par des composants fluorescents conventionnels. (Réactances électromagnétiques et tubes de diamètre 26mm).

#### BELEUCHTUNG

Die Standardausführung integriert konventionelle Leuchstoffelemente (Elektromagnetischer Blindwiderstand und Röhren mit 26mm Durchmesser).

#### ILLUMINAZIONE

L'illuminazione standard dei pannelli è formata da componenti di fluorescenza convenzionali (Reattanze elettromagnetiche e tubi di 26mm di diametro).

#### ACABADOS

Disponemos de una amplia gama de acabados en pintura y electrolíticos para los carriles que forman la estructura (consultélenos).

#### FINISHES

We offer a wide range of paint and electrolytic finishes for the runners which make up the structure. (Please contact us).

#### FINITIONS

Nous disposons d'une gamme étendue de finitions en peinture et revêtements électrolytiques destinés aux rails qui forment la structure (consultez-nous).

#### OBERFLÄCHENVEREDELUNG

Wir bieten Ihnen eine breite Palette an Finish-Möglichkeiten, vom Farbanstrich bis zur Elektrolytpolitur für die Schienen. Bitte setzen Sie sich zwecks Anfrage mit uns in Verbindung.

#### FINITURE

Disponiamo di un'ampia gamma di finiture in vernice e in elettrolitici per le rotaie che formano la struttura (chiedeteci un consulto).

#### IMPORTANTE:

Consultar para medidas especiales de placas de alabastro u otros tipos de iluminación.

#### IMPORTANT:

Please consult us for special measurements of alabaster panels and other types of lighting.

#### FINITIONS

Veuillez nous consulter pour toute information sur des dimensions spéciales de panneaux et d'autres types d'éclairage.

#### OBERFLÄCHENVEREDELUNG

Kontaktieren Sie uns, wenn Sie an Sonderbestellungen mit abweichenden Plattenmassen und anderen Beleuchtungsvarianten interessiert sind.

#### IMPORTANTE:

Consultatevi con noi per quanto riguarda le misure speciali delle lastre di alabastro o per altri tipi di illuminazione.



**MODUL**  
ELECTRO  
[www.modulelectro.ru](http://www.modulelectro.ru)



GRANADO 83  
HOTEL \*\*\*\*\*



GRANADO 83  
HOTEL \*\*\*\*\*

Nuestro interés es conseguir que sus ideas se conviertan en realidad, adaptándonos siempre a sus necesidades y ofreciéndole nuestro asesoramiento y nuestra colaboración para lograr la mejor solución personalizada para cada proyecto en concreto.

Our goal is to transform your ideas into reality, adapting our products to your needs, and offering our advice and collaboration to achieve the best personalised solution for each specific project.

Notre objectif es transformer vos idées en réalités en nous adaptant sans cesse à vos exigences et en vous offrant nous conseils et notre collaboration afin d'obtenir la meilleure solution personnalisé pour chaque projet concret.

Unser wichtigstes Anliegen ist die Umsetzung Ihrer Ideen. Hierbei stellen wir uns auf sämtliche Erfordernisse und Zwänge ein. Unsere Beratung und unsere Kooperationsbereitschaft ist unseren Kunden jederzeit sicher, damit für jedes konkrete Objekt die beste massgeschneiderte Lösung gefunden werden kann.

Il nostro interesse è di ottenere che le vostre idee diventino realtà, adattandoci sempre alle vostre necessità e offrendovi la nostra assistenza e tutta la nostra collaborazione per raggiungere la soluzione migliore e personalizzata per ogni progetto in concreto.



**MODULO**  
ELECTRO  
[www.modulelectro.ru](http://www.modulelectro.ru)



HOTEL  
\*\*\*\*\*GL  
ابان

Innumerables soluciones adaptadas a todo tipo de espacios y formas, así como a una extensa variedad de estilos arquitectónicos y decorativos avalan la larga experiencia de LEDS-C4 en la realización de proyectos mediante paneles de alabastro iluminados.

Can offer countless solutions adapted to all types of spaces and shapes, as well as a variety of architectural and decorative styles. This is shown by the extensive experience in undertaking projects in using illuminated alabaster panels.

D'innombrables solutions adaptées à tout type d'espace et de forme ainsi qu'un large variété de styles architectoniques et décoratifs témoignent de la grande expérience de LEDS-C4 dans la réalisation de projets faisant appel aux panneaux d'albâtre illuminés

Die langjährige Erfahrung des Unternehmens bei der Konzipierung von massgeschneiderten Lösungen im Bereich der Installation von beleuchteten Alabasterplatten sowie die breite Palette architektonischer und dekorativer Stile bürgen für LEDS-C4.

Le innumerevoli soluzioni adattate a ogni tipo di spazio e di forma, così come a una notevole varietà di stili architettonici e decorativi, consolidano la grande esperienza di LEDS-C4 nella realizzazione di progetti con pannelli di alabastro illuminati.



# MODUL

ELECTRO

[www.modulelectro.ru](http://www.modulelectro.ru)

Acabados  
Finishes  
Finitions  
Ausführungen  
Rifiniture

21

N4



55

Cromo  
Chrome  
Chrome  
Chrom  
Cromo

Gris textura con cromo  
Grey texture with chrome  
Gris à affect de texture avec chrome  
Grau rauh-matt mit Chrom  
Grigio texture con cromo

Alabastro blanco  
White alabaster  
Albâtre blanc  
Weisser Alabaster  
Alabastro bianco



 **MODUL**   
ELECTRO  
[www.modulelectro.ru](http://www.modulelectro.ru)

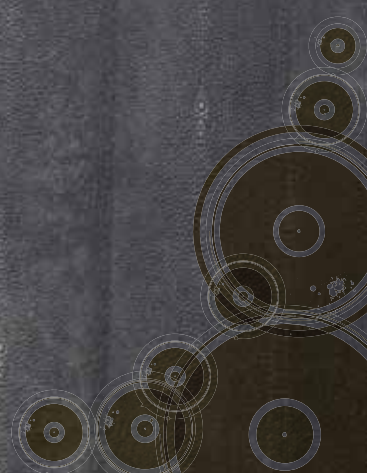



**MODUL**  
ELECTRO  
www.modulelectro.ru

**00-2349-21-55**

1 x T5 2GX13 55W **INCLUDED**  
1 CE Electronic ballast **INCLUDED**

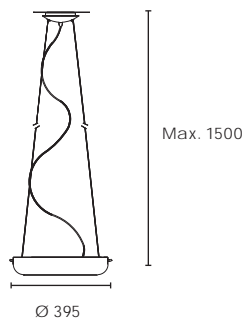

**05-2349-21-55**

1 x T5 2GX13 22W **INCLUDED**  
1 CE Electronic ballast **INCLUDED**

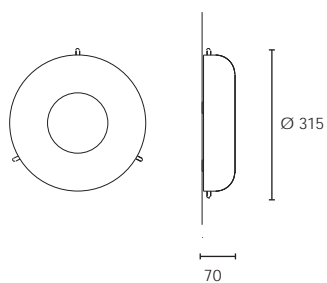

**15-2349-21-55**

1 x T5 2GX13 40W **INCLUDED**  
1 CE Electronic ballast **INCLUDED**

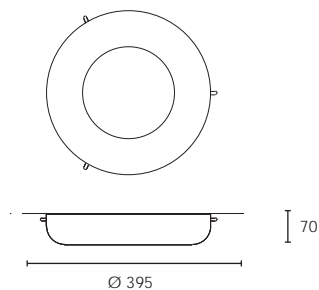

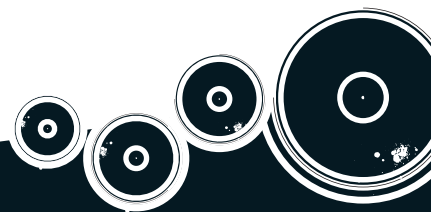

**MODULO**  
ELECTRO  
[www.modulelectro.ru](http://www.modulelectro.ru)



**00-2348-21-55**

2 x 2G11 24W + 2 x 2G11 55W  
2 CE Electronic ballast **INCLUDED**

**INCLUDED**

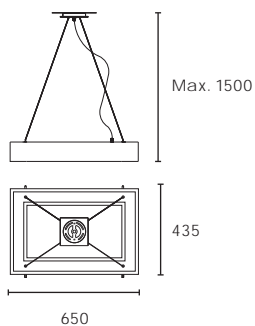

**05-2348-21-55**

4 x 2G11 18W **INCLUDED**  
2 CE Electronic ballast **INCLUDED**

**INCLUDED**

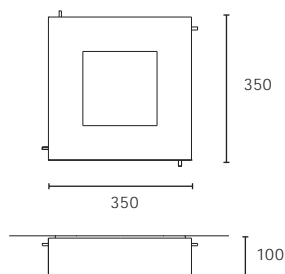

**15-2348-21-55**

4 x 2G11 24W **INCLUDED**  
2 CE Electronic ballast **INCLUDED**

**INCLUDED**

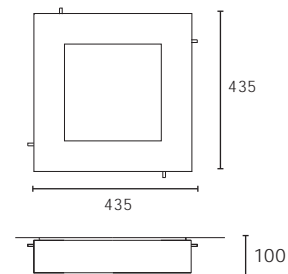





**MODUL**  
ELECTRO  
[www.modulelectro.ru](http://www.modulelectro.ru)

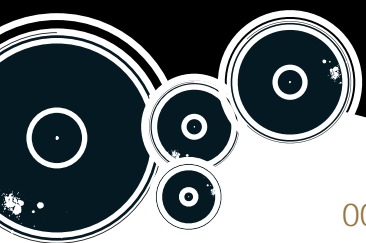

00-2557-N4-55

1 x T5 39W **INCLUDED**

1 CE Electronic ballast **INCLUDED**

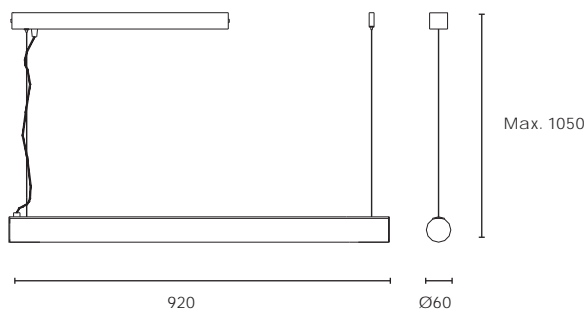

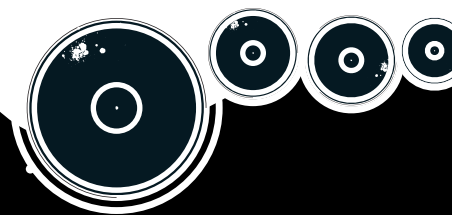

**MODUL**  
ELECTRO

[www.modulelectro.ru](http://www.modulelectro.ru)



05-2557-N4-55

1 x T5 24W **INCLUDED**  
1 CE Electronic ballast **INCLUDED**

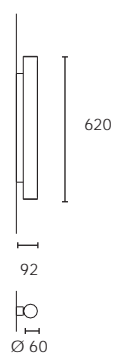

**MODUL**  
ELECTRO  
[www.modulelectro.ru](http://www.modulelectro.ru)

Acabados  
Finishes  
Finitions  
Ausführungen  
Rifiniture

81

Niquel satinado  
Satin nickel  
Nickel satiné  
Satiniertes Nickel  
Nichel satinato

55

Alabastro blanco  
White alabaster  
Albâtre blanc  
Weisser Alabaster  
Alabastro bianco



**MODUL**

**ELECTRO**

[www.modulelectro.ru](http://www.modulelectro.ru)





**MODUL**  
ELECTRO  
[www.modulelectro.ru](http://www.modulelectro.ru)

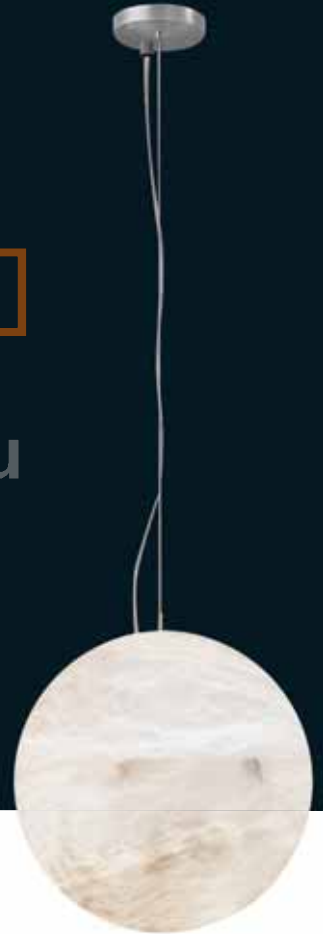

00-0367-81-55

2 x E-27 PL elec. 20W

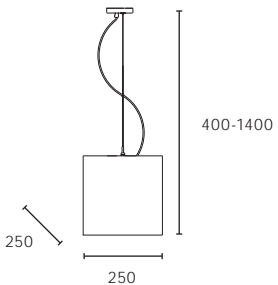

00-0137-81-55

1 x E-27 max. 60W

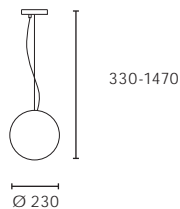

00-0138-81-55

1 x E-27 max. 60W  
1 x E-27 PL elec. 11W

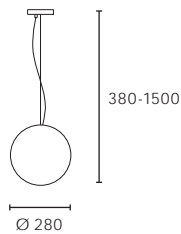

00-0139-81-55

1 x E-27 max. 60W  
1 x E-27 PL elec. 11W

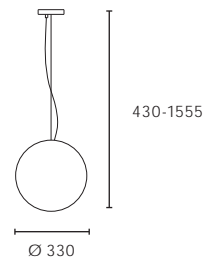

00-0140-81-55

1 x E-27 max. 60W  
1 x E-27 PL elec. 11W

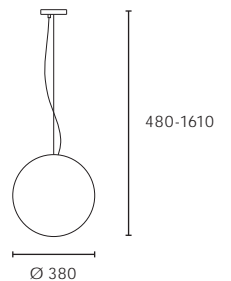



**MODUL**  
ELECTRO  
[www.modulelectro.ru](http://www.modulelectro.ru)

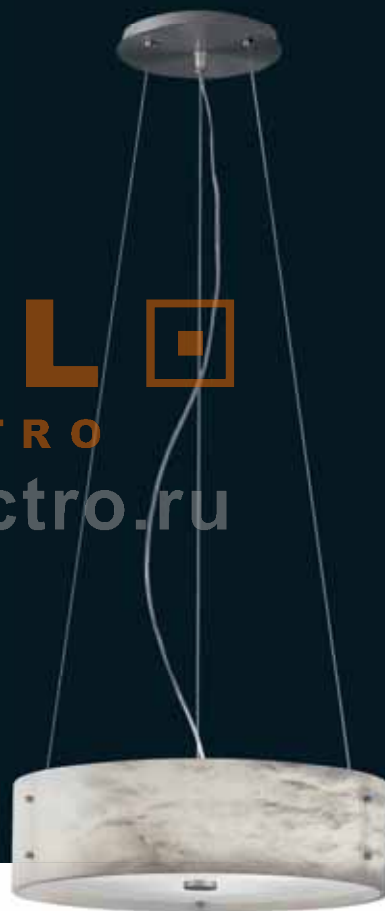

00-0339-81-55

4 x E-27 max. 60W  
4 x E-27 PL elec. 18W

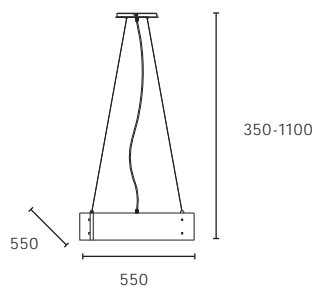

00-0340-81-55

3 x E-27 max. 60W  
3 x E-27 PL elec. 18W

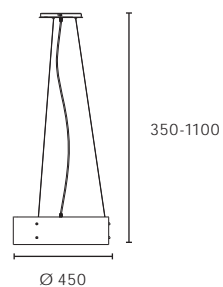

**MODUL**
  
 ELECTRO  
[www.modulelectro.ru](http://www.modulelectro.ru)

Acabados  
 Finishes  
 Finitions  
 Ausführungen  
 Rifiniture

21

Cromo  
 Chrome  
 Chrome  
 Chrom  
 Cromo



55

Alabastro blanco  
 White alabaster  
 Albâtre blanc  
 Weisser Alabaster  
 Alabastro bianco

S2

Aluminio pulido y satinado  
 Polished and satin aluminium  
 Aluminium poli et satiné  
 Aluminium poliert und mattglänzend  
 Aluminio pulito satinato



 **MODUL**   
ELECTRO  
[www.modulelectro.ru](http://www.modulelectro.ru)



05-2346-21-55

2 x 2G11 18W INCLUDED  
1 CE Electronic ballast INCLUDED

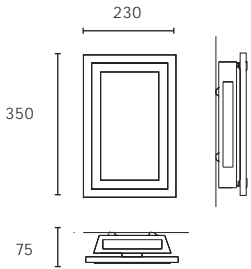

**MODUL**  
ELECTRO

[www.modulelectro.ru](http://www.modulelectro.ru)

05-2347-21-55

2 x 2G11 18W INCLUDED  
1 CE Electronic ballast INCLUDED

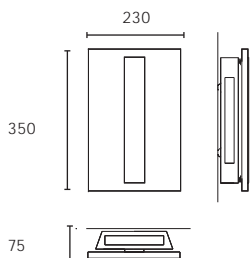



15-2345-S2-55

4 x 2G11 18W **INCLUDED**2 CE Electronic ballast **INCLUDED**

**MODUL**  
ELECTRO

[www.modulelectro.ru](http://www.modulelectro.ru)

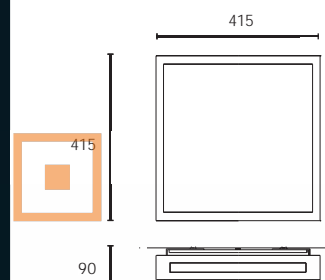

15-2350-21-55

1 x T5 2GX13 22W + **INCLUDED**

1 x T5 2GX13 40W

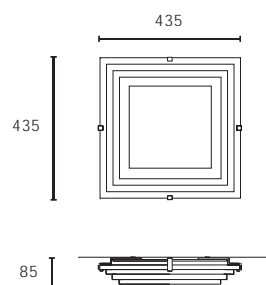
1 CE Electronic ballast **INCLUDED**

# MODUL

ELECTRO

[www.modulelectro.ru](http://www.modulelectro.ru)

Acabados  
Finishes  
Finitions  
Ausführungen  
Rifiniture

81

Níquel satinado  
Satin nickel  
Nickel satiné  
Satiniertes Nickel  
Nichel satinato

55

Alabastro blanco  
White alabaster  
Albâtre blanc  
Weisser Alabaster  
Alabastro bianco



**MODUL**  
ELECTRO  
[www.modulelectro.ru](http://www.modulelectro.ru)



20-0393-81-55

3 x G24d-2 18W

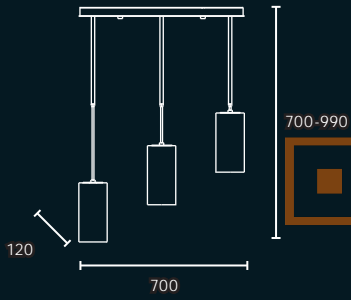

**MODUL**  
ELECTRO

[www.modulelectro.ru](http://www.modulelectro.ru)

20-0394-81-55

3 x G24d-2 18W

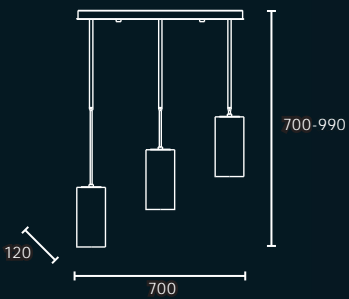



10-0393-81-55

1 x G24d-1 13W

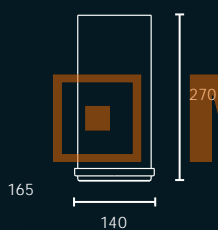

**MODULO**  
ELECTRO

[www.modulelectro.ru](http://www.modulelectro.ru)



00-0393-81-55

1 x G24d-2 18W

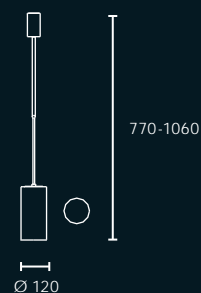

10-0394-81-55

1 x G24d-1 13W

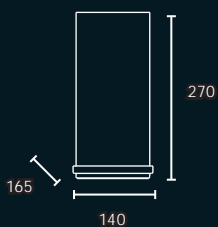

00-0394-81-55

1 x G24d-2 18W

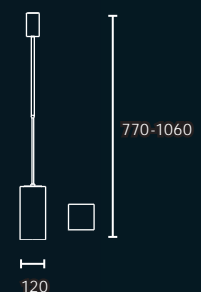



**MODUL**  
ELECTRO  
[www.modulelectro.ru](http://www.modulelectro.ru)

Acabados  
Finishes  
Finitions  
Ausführungen  
Rifiniture

81

Níquel satinado  
Satin nickel  
Nickel satiné  
Satiniertes Nickel  
Nickel satinato

Q7

Alabastro blanco sin pantalla de tela  
White alabaster without fabric shade  
Albâtre blanc sans abat-jour in tissu  
Weisser Alabaster ohne Stoffschirm  
Alabastro bianco senza schermo di tela

U4

Pintura imitación níquel satinado  
Satin nickel paint  
Peinture imitation nickel satiné  
Nickel-Optik matt lackiert  
Vernice imitazione níquel satinato



10-0281-U4-Q7

1 x E-27 max. 60W +  
2 x E-14 max. 15W

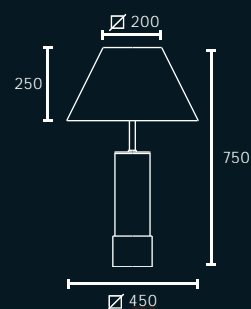

Pantalla / shade / abat-jour  
Stoffschild / schermo

Ref. Pan-122-14

**MODUL**  
ELECTRO  
[www.modulelectro.ru](http://www.modulelectro.ru)



10-0282-81-Q7

1 x E-27 max. 60W + 1 x  
E-14 max. 40W

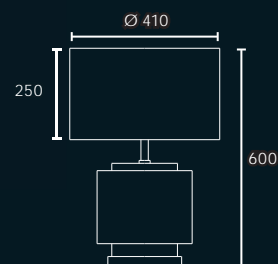

Pantalla / shade / abat-jour  
Stoffschild / schermo

Ref. Pan-123-14

Sin pantalla de tela · Without fabric shade · Sans abat-jour en tissu.  
Ohne Stoffschild · Enza schermo di tela

Para conjunto completo solicite referencias de luminaria y pantalla.  
For complete set please order by separate fixture and shade references.  
Demandez le code de luminaire et abat-jour en cas de set complete.  
Für komplette Leuchte, bestellen Sie bitte Lampe und Schild getrennt.  
Per il set completo, chiedere la referenza dell'apparecchio ed il paralume.



**MODUL**  
ELECTRO

[www.modulelectro.ru](http://www.modulelectro.ru)

Finishes  
Acabados  
Finitions  
Ausführungen  
Rifiniture

81

Niquel satinado  
Satin nickel  
Nickel satiné  
Safiniertes Nickel  
Nichel satinato

55

Alabastro blanco  
White alabaster  
Albâtre blanc  
Weisser Alabaster  
Alabastro bianco





**MODUL**  
ELECTRO  
[www.modulelectro.ru](http://www.modulelectro.ru)



15-0343-81-55

2 x G24d-2 18W

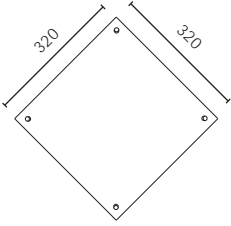

15-0344-81-55

3 x G24d-2 18W

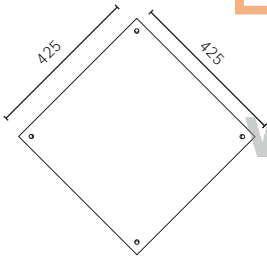

**MODUL**  
ELECTRO

[www.modulelectro.ru](http://www.modulelectro.ru)

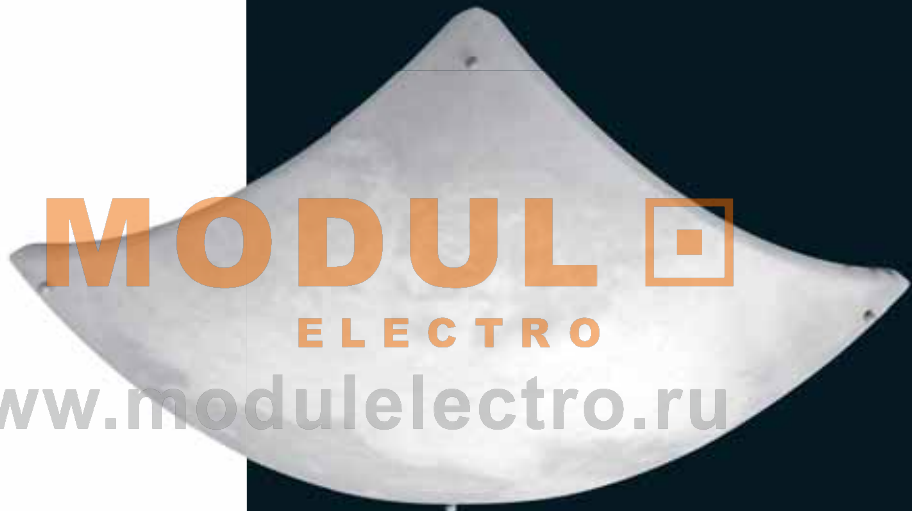

15-0345-81-55

4 x G24d-2 18W

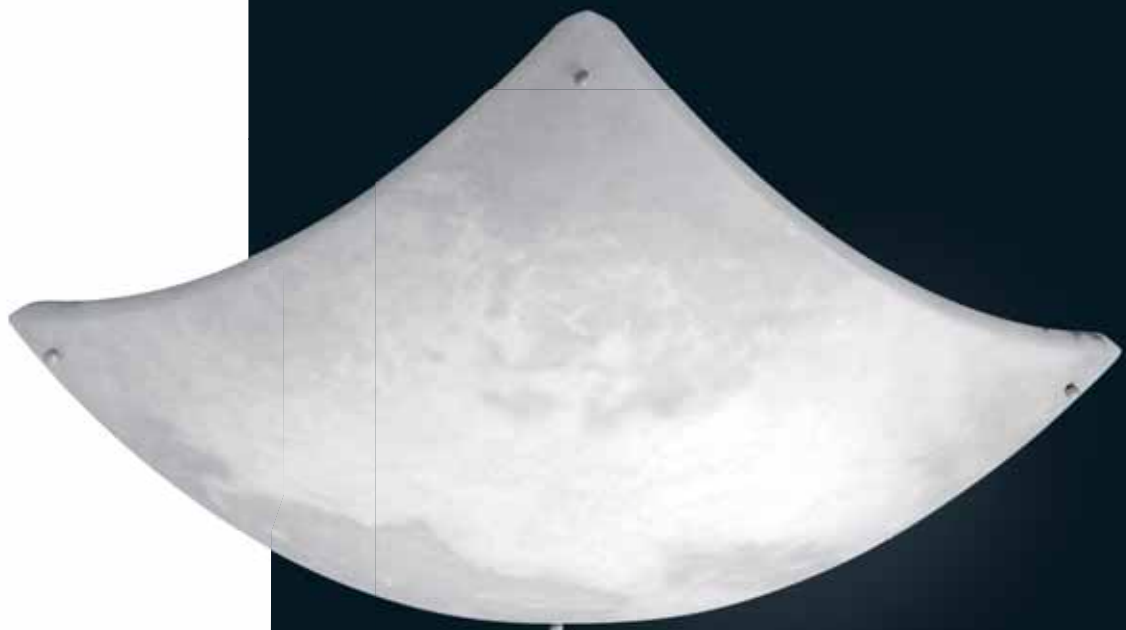
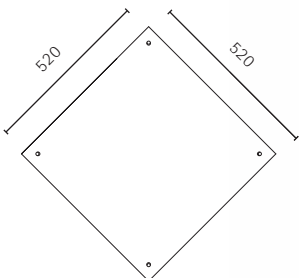

15-0346-81-55

2 x G24d-1 13W

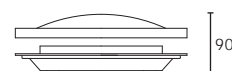
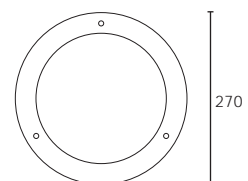
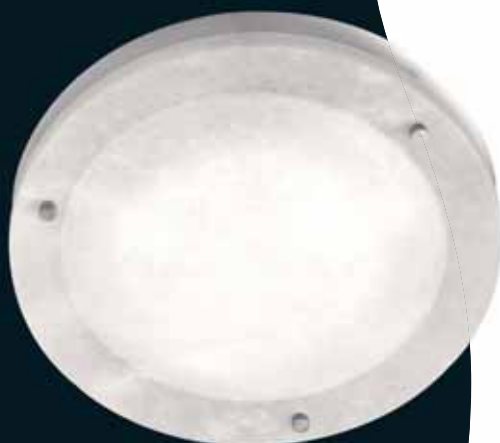

15-0347-81-55

3 x G24d-1 13W



**MODUL**  
ELECTRO  
[www.modulelectro.ru](http://www.modulelectro.ru)

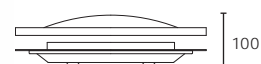
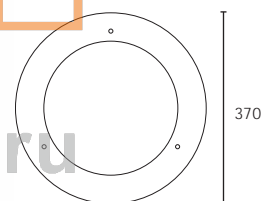

15-0348-81-55

4 x G24d-1 13W

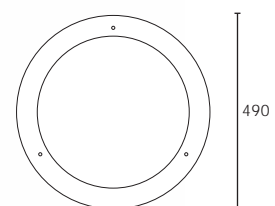



**MODUL**  
ELECTRO

[www.modulelectro.ru](http://www.modulelectro.ru)

Acabados  
Finishes  
Finitions  
Ausführungen  
Rifiniture

81 55 14

Níquel satinado  
Satin nickel  
Nickel satiné  
Satinierter Nickel  
Nichel satinato

Alabastro blanco  
White alabaster  
Albâtre blanc  
Weisser Alabaster  
Alabastro bianco

Blanco  
White  
Blanc  
Weiss  
Bianco





B

**MODUL**  
ELECTRO  
[www.modulelectro.ru](http://www.modulelectro.ru)





05-0358-81-55  
1 x G24d-2 18W

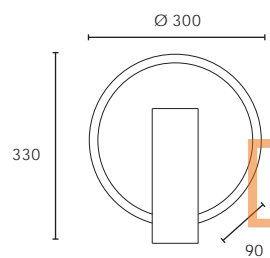

**MODUL**  
ELECTRO  
[www.modulelectro.ru](http://www.modulelectro.ru)



05-0359-81-55  
1 x G24d-2 18W

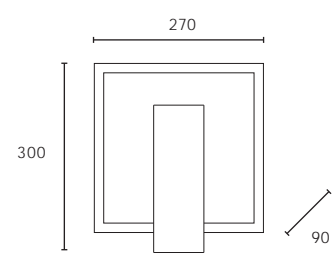



05-0271-14-55

1 x E-27 max. 60W + 1 x E-14 max. 15W

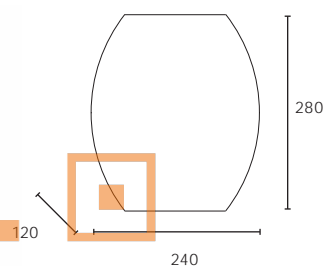

**MODULO**  
ELECTRO

[www.modulelectro.ru](http://www.modulelectro.ru)



05-0274-14-55

1 x E-27 max. 60W

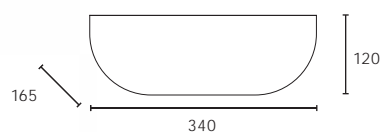

05-0275-14-55

1 x E-27 max. 60W

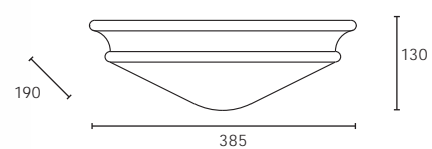



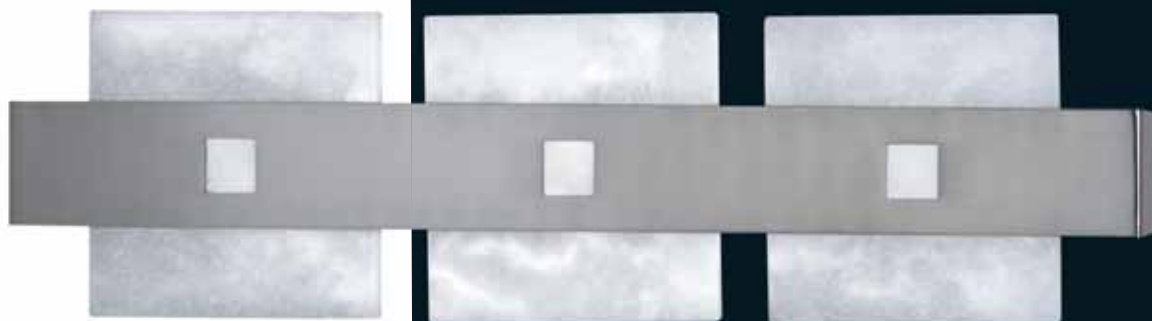

05-0352-81-55

1 x G13 18W (T8 Ø26 mm)

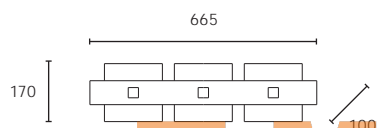

**MODUL**  
ELECTRO

[www.modulelectro.ru](http://www.modulelectro.ru)

05-0353-81-55

1 x G24d-2 18W

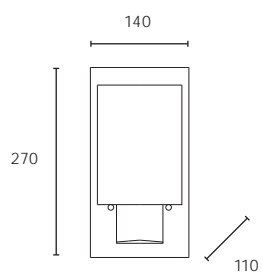

05-5826-14-55

1 x E-27 max. 60W

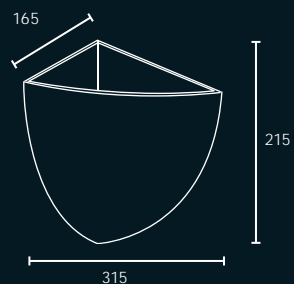

Applique de esquina.  
 Corner wall bracket.  
 Applique angle.  
 Ecke Wandleuchte.  
 Applique d'angolo.

**MODUL**  
**ELECTRO**

[www.modulelectro.ru](http://www.modulelectro.ru)



05-0354-81-55

1 x G24d-2 18W

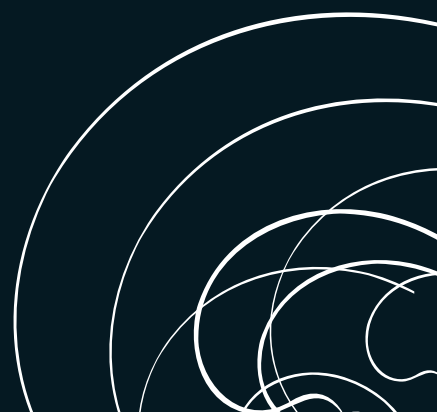



**MODUL**  
ELECTRO

[www.modulelectro.ru](http://www.modulelectro.ru)



05-3662-14-55

1 x E-27 max.60W

05-3663-14-55

1 x R7s - L 80,5 Hal. max. 150W

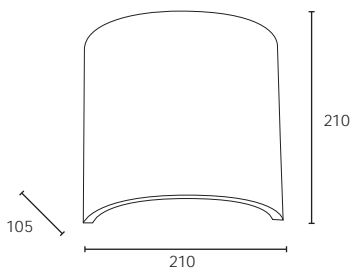

05-0355-14-55

1 x G24d-2 18W

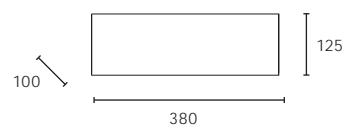

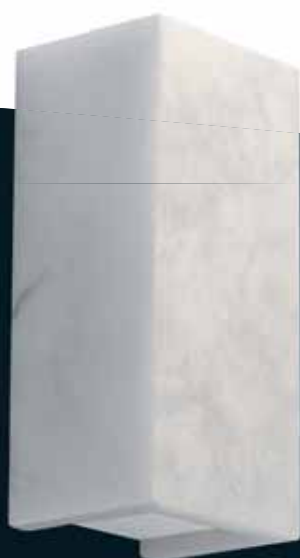

**MODUL**  
ELECTRO

[www.modulelectro.ru](http://www.modulelectro.ru)



05-0356-14-55

1 x G24d-2 18W

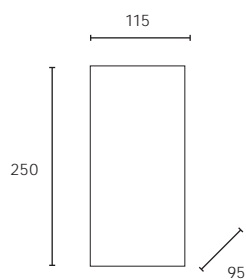

05-0357-14-55

2 x G24d-2 18W

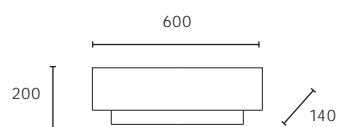

**COLGANTES  
PENDANTS  
SUSPENSIONS  
PENDELLEUCHTEN  
PENDENTI**

00-0137-81-55.....	196
00-0138-81-55.....	196
00-0139-81-55.....	196
00-0140-81-55.....	196
00-0168-G8-55.....	53
00-0193-G8-55.....	67
00-0216-G8-55.....	63
00-0260-G8-U9.....	46
00-0328-G8-55.....	37
00-0339-81-55.....	197
00-0340-81-55.....	197
00-0367-81-55.....	196
00-0375-G8-87.....	42
00-0383-G8-87.....	33
00-0393-81-55.....	205
00-0394-81-55.....	205
00-0419-01-55.....	139
00-0420-01-55.....	139
00-0421-01-55.....	139
00-0422-01-55.....	139
00-0423-01-55.....	139
00-0434-01-98.....	141
00-0435-01-98.....	141
00-0436-01-98.....	141
00-0437-01-98.....	141
00-0438-01-98.....	141
00-0439-01-55.....	138
00-0440-01-55.....	138
00-0692-50-87.....	139
00-0693-50-87.....	139
00-0694-50-87.....	139
00-0695-50-87.....	139
00-0715-01-55.....	141
00-0718-G1-55.....	121
00-0719-G1-55.....	121
00-1304-G8-55.....	128
00-1308-G8-55.....	127
00-1635-I1-55.....	115
00-1635-88-55.....	115
00-1761-P6-55.....	98
00-1761-G8-55.....	98
00-1765-G8-55.....	118
00-1766-G8-55.....	118
00-2061-D5-55.....	91
00-2154-G8-55.....	140
00-2161-G8-55.....	76
00-2162-G8-55.....	76
00-2163-G8-55.....	78
00-2213-G8-55.....	94
00-2236-S4-55.....	83
00-2258-G8-S6.....	71
00-2262-G8-55.....	70
00-2348-21-55.....	191
00-2349-21-55.....	190
00-2526-G8-55.....	26
00-2557-N4-55.....	192
00-2723-G8-55.....	12
00-2724-G8-55.....	15
00-5812-B2-98.....	132
00-5812-64-98.....	132
00-6228-64-55.....	140
00-6258-01-55.....	139
00-6259-01-55.....	138
20-0168-G8-55.....	52
20-0169-G8-55.....	51
20-0170-G8-55.....	53
20-0193-G8-55.....	66
20-0194-G8-55.....	66
20-0209-G8-55.....	52
20-0217-G8-55.....	63
20-0226-G8-55.....	60

20-0227-G8-55.....	61
20-0260-G8-U9.....	48
20-0261-G8-U9.....	48
20-0262-G8-U9.....	49
20-0263-G8-U9.....	49
20-0328-G8-55.....	36
20-0329-G8-55.....	35
20-0330-G8-55.....	36
20-0375-G8-87.....	43
20-0376-G8-87.....	43
20-0383-G8-87.....	32
20-0384-G8-87.....	33
20-0389-G8-87.....	38
20-0390-G8-87.....	39
20-0391-G8-87.....	39
20-0393-81-55.....	204
20-0394-81-55.....	204
20-0652-01-55.....	135
20-0728-50-C1.....	123
20-0803-50-55.....	134
20-0809-50-55.....	134
20-1304-G8-55.....	129
20-1306-G8-55.....	129
20-1310-G8-55.....	127
20-1384-I1-55.....	106
20-1385-I1-55.....	106
20-1388-88-55.....	111
20-1635-I1-55.....	114
20-1635-88-55.....	114
20-1636-I1-55.....	114
20-1636-88-55.....	114
20-1761-P6-55.....	97
20-1761-G8-55.....	97
20-1762-P6-55.....	99
20-1762-G8-55.....	99
20-1763-P6-55.....	98
20-1763-G8-55.....	98
20-1764-P6-55.....	98
20-1764-G8-55.....	98
20-1765-G8-55.....	118
20-1766-G8-55.....	118
20-1858-I1-55.....	102
20-1899-G8-55.....	122
20-1900-G8-55.....	122
20-2061-D5-55.....	91
20-2161-G8-55.....	77
20-2162-G8-55.....	78
20-2163-G8-55.....	77
20-2164-G8-55.....	79
20-2214-G8-55.....	95
20-2222-T1-55.....	89
20-2225-T1-55.....	88
20-2226-T1-55.....	89
20-2235-S4-55.....	82
20-2236-S4-55.....	84
20-2237-S4-55.....	84
20-2238-S4-55.....	85
20-2239-S4-55.....	81
20-2257-G8-S6.....	73
20-2258-G8-S6.....	72
20-2259-G8-S6.....	73
20-2261-G8-55.....	70
20-2280-I1-55.....	55
20-2281-I1-55.....	57
20-2282-I1-55.....	56
20-2526-G8-55.....	25
20-2527-G8-55.....	25
20-2528-G8-55.....	24
20-2529-G8-55.....	24
20-2723-G8-55.....	12
20-2724-G8-55.....	14
20-5812-B2-98.....	132
20-5812-64-98.....	132
20-6241-01-55.....	124
20-6264-50-C1.....	123

**APLIQUES  
WALL FIXTURES  
APPLIQUES  
WANDLEUCHTEN  
APLIQUES**

05-0168-G8-55.....	53
05-0193-G8-55.....	67
05-0216-G8-55.....	63
05-0226-G8-55.....	60
05-0227-G8-55.....	61
05-0260-G8-U9.....	45
05-0261-G8-U9.....	47
05-0271-14-55.....	215
05-0273-G8-55.....	155
05-0274-14-55.....	215
05-0275-14-55.....	215
05-0276-14-U9.....	155
05-0277-14-U9.....	155
05-0328-G8-55.....	37
05-0352-81-55.....	216
05-0353-81-55.....	216
05-0354-81-55.....	217
05-0355-14-55.....	218
05-0356-14-55.....	219
05-0357-14-55.....	219
05-0358-81-55.....	214
05-0359-81-55.....	214
05-0375-G8-87.....	42
05-0383-G8-87.....	31
05-0384-G8-87.....	31
05-0389-G8-87.....	38
05-0439-14-55.....	152
05-0441-14-55.....	152
05-0442-14-55.....	152
05-0448-14-87.....	154
05-0449-14-87.....	154
05-0462-14-87.....	154
05-0468-14-55.....	150
05-0470-14-87.....	150
05-0608-14-98.....	149
05-0652-01-55.....	135
05-0659-95-98.....	123
05-0663-01-55.....	135
05-0718-G1-55.....	121
05-0805-50-55.....	134
05-0818-14-98.....	149
05-0833-14-55.....	153
05-0834-14-55.....	153
05-0836-14-55.....	151
05-0839-14-55.....	151
05-0842-14-55.....	151
05-1304-G8-55.....	128
05-1308-G8-55.....	127
05-1384-I1-55.....	107
05-1385-I1-55.....	107
05-1387-88-55.....	111
05-1635-I1-55.....	113
05-1635-88-55.....	113
05-1637-I1-55.....	115
05-1637-88-55.....	115
05-1654-M9-55.....	148
05-1655-M9-55.....	148
05-1656-M9-55.....	148
05-1657-M9-55.....	148
05-1662-M9-55.....	148
05-1663-M9-55.....	148
05-1664-M9-55.....	148
05-1665-M9-55.....	148
05-1667-M9-55.....	148
05-1673-14-55.....	147
05-1675-14-55.....	147
05-1679-14-87.....	147
05-1761-P6-55.....	99
05-1761-G8-55.....	99
05-1763-P6-55.....	97

05-1763-G8-55.....	97
05-1764-P6-55.....	97
05-1764-G8-55.....	97
05-1765-G8-55.....	119
05-1858-I1-55.....	103
05-1859-I1-55.....	103
05-1894-G8-55.....	125
05-2061-D5-55.....	91
05-2104-G8-N2.....	149
05-2106-14-55.....	147
05-2110-G8-55.....	146
05-2114-E2-55.....	146
05-2128-E4-55.....	146
05-2132-G8-55.....	146
05-2134-14-H1.....	150
05-2161-G8-55.....	75
05-2213-G8-55.....	94
05-2222-T1-55.....	87
05-2224-T1-55.....	88
05-2235-S4-55.....	85
05-2236-S4-55.....	83
05-2237-S4-55.....	82
05-2257-G8-S6.....	71
05-2258-G8-S6.....	71
05-2261-G8-55.....	70
05-2280-I1-55.....	56
05-2346-21-55.....	200
05-2347-21-55.....	200
05-2348-21-55.....	191
05-2349-21-55.....	190
05-2526-G8-55.....	26
05-2557-N4-55.....	193
05-2723-G8-55.....	13
05-3650-14-55.....	152
05-3651-14-55.....	152
05-3656-14-55.....	153
05-3657-14-55.....	153
05-3658-14-55.....	153
05-3659-14-55.....	153
05-3662-14-55.....	218
05-3663-14-55.....	218
05-3664-14-87.....	154
05-3666-14-87.....	154
05-3667-14-87.....	154
05-3722-14-55.....	153
05-3723-14-55.....	153
05-3726-01-55.....	149
05-3727-01-55.....	149
05-3730-14-55.....	152
05-3731-14-55.....	152
05-5812-18-98.....	132
05-5826-14-55.....	217
05-6241-01-55.....	124

**PANELES DE ALABASTRO**  
**ALABASTER PANELS**  
**PANNEAUX D'ALBÂTRE**  
**ALABASTERPLATTEN**  
**PANELLI DI ALABASTRO**

05-2733-21-55.....	176
05-2734-21-55.....	176
05-2735-21-55.....	177
05-2736-21-55.....	177

**CORNISAS**  
**CORNICES**  
**CORNICHES**  
**KRANZGESIMS**  
**CORNICHIONE**

05-2737-81-55.....	164
05-2738-81-55.....	164
05-2739-81-55.....	169
05-2740-81-55.....	169
05-2743-81-55.....	165
05-2744-81-55.....	165

**ESPEJOS**  
**MIRRORS**  
**MIROIRS**  
**SPIEGELN**  
**SPECHI**

05-2745-21-55.....	173
05-2746-21-55.....	173
05-2747-14-55.....	171
05-2748-14-55.....	171

**LAMPARAS DE MESA**  
**TABLE LAMPS**  
**LAMPES DE TABLE**  
**TISCHLEUCHTEN**  
**LAMPADE DA TAVOLO**

10-0161-01-X3.....	159
10-0281-U4-Q7.....	207
10-0282-81-Q7.....	207
10-0287-G8-55.....	159
10-0393-81-55.....	205
10-0394-81-55.....	205
10-1384-I1-82.....	107
10-1387-88-82.....	110
10-1398-01-82.....	158
10-1399-01-82.....	158
10-1402-01-82.....	158
10-1404-01-82.....	158
10-1409-01-82.....	158
10-1635-I1-82.....	115
10-1635-88-82.....	115
10-1858-I1-Q7.....	101

**PLAFONES**  
**CEILING FIXTURES**  
**PLAFONNIERS**  
**DECKENLEUCHTEN**  
**PLAFONIERE**

15-0193-G8-55.....	67
15-0260-G8-U9.....	46
15-0261-G8-U9.....	47
15-0262-G8-U9.....	45
15-0328-G8-55.....	37
15-0343-81-55.....	210
15-0344-81-55.....	210
15-0345-81-55.....	210
15-0346-81-55.....	211
15-0347-81-55.....	211
15-0348-81-55.....	211
15-0383-G8-87.....	30
15-0384-G8-87.....	30
15-0385-G8-87.....	30
15-0389-G8-87.....	38
15-0415-01-55.....	143
15-0416-01-55.....	143
15-0426-01-55.....	143
15-0443-01-55.....	143
15-0651-50-87.....	142
15-0653-50-87.....	142
15-0718-G1-55.....	121
15-0721-01-55.....	142
15-1635-I1-55.....	113
15-1635-88-55.....	113
15-1636-I1-55.....	113
15-1636-88-55.....	113
15-1761-P6-55.....	99
15-1761-G8-55.....	99
15-1762-P6-55.....	99
15-1762-G8-55.....	99
15-1765-G8-55.....	119
15-1766-G8-55.....	119
15-1858-I1-55.....	102
15-2161-G8-55.....	76
15-2162-G8-55.....	76
15-2213-G8-55.....	94

15-2222-T1-55.....	88
15-2237-S4-55.....	83
15-2239-S4-55.....	83
15-2246-B2-98.....	133
15-2246-64-98.....	133
15-2247-B2-98.....	133
15-2247-64-98.....	133
15-2257-G8-S6.....	72
15-2280-I1-55.....	56
15-2345-S2-55.....	201
15-2348-21-55.....	191
15-2349-21-55.....	190
15-2350-21-55.....	201
15-2526-G8-55.....	27
15-2527-G8-55.....	27
15-2715-G8-55.....	21
15-2716-G8-55.....	21
15-2719-G8-55.....	19
15-2720-G8-55.....	19
15-2721-G8-55.....	18
15-2722-G8-55.....	18
15-2723-G8-55.....	13
15-2724-G8-55.....	15
15-5828-50-87.....	142
15-6258-01-55.....	142

**LÁMPARAS DE PIE**  
**FLOOR LAMPS**  
**LAMPADAIRES**  
**STEHLEUCHTEN**  
**PIEDISTALLO DI SALONE**

25-0290-G8-55.....	159
25-1304-G8-55.....	128
25-1387-88-55.....	110
25-1765-G8-55.....	119
25-1858-I1-55.....	101
25-2161-G8-55.....	75
25-5812-B2-98.....	133
25-5812-64-98.....	133
71-0161-14-C1.....	159

**ACCESORIOS**  
**ACCESSORIES**  
**ACCESSOIRES**  
**ZUBEHÖR**  
**ACCESSORI**

71-0361-01-35.....	37
71-0362-01-35.....	37
71-0363-01-35.....	37
71-0364-01-35.....	36
71-0365-01-35.....	35
71-0366-01-35.....	36

**PANTALLAS**  
**SHADES**  
**ABAT-JOUR**  
**SCHIRM**  
**SCHERMOS**

Pan-068-20.....	158
Pan-076-20.....	101
Pan-076-20.....	107
Pan-077-20.....	158
Pan-077-20.....	110
Pan-078-20.....	158
Pan-078-20.....	115
Pan-112-X4.....	159
Pan-122-14.....	207
Pan-123-14.....	207

**PIEDRA DE ALABASTRO**  
**ALABASTER ROCK**  
**ALBÂTRE BRUT**  
**ROH-ALABASTER**  
**PIETRA DI ALABASTRO**

91-0483-14-55.....	125
--------------------	-----

## Acabados · finishing · finitions · ausföhrungen · rifiniture

01	Oro Gold Or Vergoldet Oro	98	Alabastro blanco/talla marrón White alabaster/rust carvin Albâtre blanc/taille marron Weisser Alabaster/brauner Rand Alabastro bianco con intaglio marrone	N2	Alabastro peach Peach alabaster Albâtre peach Peach Alabaster Alabastro peché
14	Blanco White Blanc Bianco Weiss	B2	Marrón/patiné Brown/antique brass Marron/patiné Braun/Alt Messing Marrone/patinato	N4	Gris textura con cromo Grey texture with chrome Gris à affect de texture avec chrome Grigio texture con cromo Grau rauh-matt mit Chrom
18	Marrón Brown Marron Braun Marrone	C1	Alabastro color champán/talla marrón Champagne colour alabaster/rust carvin Albâtre couleur champagne/taille marron Champagner färbig Alabaster/brauner Rand Alabastro colore espumoso/intaglio marrone	P6	Oro brillante y arenado Shiny/sandblasted gold Or brillant sablé Gold glänzend/sandig Oro lucido brillante
21	Cromo Chrome Chrome Cromo Chrom	D5	Oro viejo/oro Old gold/gold Or vieil/or Antik gold/Vergoldet Oro vecchio/oro	Q7	Alabastro blanco sin pantalla de tela White alabaster without fabric shade Albâtre blanc sans abat-jour in tissu Weisser Alabaster ohne Stoffchirm Alabastro bianco senza schermo di tela
50	Patiné Antique brass Patiné Alt Messing Patinato	E2	Oro viejo Old gold Or vieil Antik Gold Oro vecchio	S2	Aluminio pulido y satinado Polished and satin aluminium Aluminium poli et satiné Aluminium poliert und mattglänzend Aluminio pulito satinato
55	Alabastro blanco White alabaster Albâtre blanc Weisser Alabaster Alabastro bianco	G1	Aluminio pintado Aluminium colour Couleur aluminium Aluminium Farbe Alluminio pintato	S4	Ámbar dorado Golden amber Ambré doré Vergoldet Bernstein Ambradorato
64	Marrón/oro Brown/gold Marron/or Braun/Vergoldet Marrone/oro	G8	Patiné rojizo Red patine Patiné rouge Rot Alt Messing Patine rosso	S6	Alabastro blanco con talla patinada White with patine colour carving alabaster Albâtre blanc avec taille patiné Weisser mit patina Rand Alabaster Alabastro bianco
81	Níquel satinado Satin nickel Nickel satiné Satinierter Nickel Nickel satinato	H1	Alabastro blanco/talla naranja White alabaster/orange carvin Albâtre blanc/taille orange Weisser Alabaster/orange Rand Alabastro bianco/intaglio arancio	T1	Níquel satylite Satylite nickel Nickel satylite Satylite Nickel Níquel satylite
82	Sin pantalla de tela Without fabric shade Sans abat-jour en tissu Ohne Stoffschirm Enza schermo di tela	I1	Oro/Patiné rojizo Gold/Red patine Or/Patiné rouge Vergoldet/Rot Alt Messing Oro/Patine rosso	U4	Pintura imitación níquel satinado Satin nickel paint Peinture imitation nickel satiné Nickel-Optik matt lackiert Vernice imitazione níquel satinato
87	Alabastro color champán Champagne colour alabaster Albâtre couleur champagne Champagner färbig Alabaster Alabastro colore espumoso	M9	Color stone Stone colour Couleur Roche Stein Färbig Colore stone	U9	Alabastro blanco con talla color beige White colour alabaster with beige carvin Albâtre blanc avec taille beige Weisser Alabaster mit Ivory Rand Alabastro bianco con intaglio colore beige
88	Níquel satinado/oro Satin nickel/gold Nickel satiné/or Satinierter Nickel/Vergoldet Nickel satinato/oro			X3	Sin pantalla/alabastro ivory con talla marrón Without fabric shade/ivory alabaster with rust carvin Sans abat-jour/albâtre ivory avec taillé marron Ohne Stoffchirm/Weisser Alabaster mit brauner Rand Senza schermo di tela /alabastro ivory con intaglio marrone

## Simbología · simbols · symboles · symbole · simbologia



Instalable sobre una superficie normalmente inflamable.  
Suitable for installation on normally inflammable surfaces.  
Convient aux installations sur des surfaces normalement inflammables.  
Kann auf brennbare Oberflächen installiert werden.  
Possibilità d'installazione sopra una superficie normalmente infiammabile.



Clase I  
Class I  
Classe I  
Klasse I  
Classe I

Para realizar el pedido de un artículo es necesario colocar después de la referencia del modelo los dos números que identifican el acabado seguidos de los dos números que corresponden al código suplementario.

When placing an order for an item, please quote after the model reference number, the two numbers indicating the required finish and the two supplementary code numbers.

Pour passer commande d'un article il faut indiquer après la référence du modèle, les deux numéros identifiant la finition, suivis de deux numéros correspondants au code supplémentaire.

Bei der Bestellung eines Artikels müssen hinter der Modell-Nr. die zwei Ziffern für die Ausführung und die zwei Ziffern des Zusatzcodes angegeben werden.

Per ordinare un articolo, si deve inserire, dopo la referenza, i 2 numeri per la finitura ed anche i 2 numeri per il codice supplementario.

## Informacion general · general information · information generale allgemeine informationen · informazione generale

Las descripciones y medidas de los aparatos del presente catálogo son orientativas, pudiendo por tanto ser modificadas, a fin de mejorar las características técnicas o de diseño / La empresa se reserva el derecho de anular o modificar cualquier modelo sin previo aviso / Todos los modelos presentados cumplen las normas exigidas por la C.E. para aparatos de iluminación de uso doméstico y sus características vienen determinadas por las clases I y II / Los acabados y las especificaciones técnicas corresponden a los productos que se suministran en Europa, pudiendo estos variar en otros mercados / Para una buena conservación de las lámparas, no usar bombillas de potencia superior a las recomendadas y limpiar simplemente con un paño seco. No usar limpia metales, ya que dañan los barnices protectores que garantizan la duración del acabado.

The descriptions and dimensions of the items in this catalogue are indicative and may be modified for the purpose of technical or design improvements / We reserve the right to cancel or change all models without prior notice / All items meet the E.C. Class I and Class II safety regulations for home lighting appliances / The finishes and technical specifications listed here are for the European market and may vary elsewhere / Do not use stronger bulbs than recommended, and always clean lamps with a soft dry cloth alone since metal polish will damage the protective finish.

Les descriptions et mesures des appareils de ce catalogue sont données à titre d'orientation, pouvant être modifiées dans le but d'améliorer les caractéristiques techniques ou de design / L'usine se réserve le droit d'annuler ou modifier l'un ou l'autre de ses modèles sans avis préalable / Tous les modèles présentés sont conformes aux normes exigées par la C.E. pour les appareils d'éclairage domestique et leurs caractéristiques sont déterminées par la classe I et II / Les finitions et spécifications techniques correspondent à la demande du marché européen. Elles peuvent être modifiées par d'autres pays / Ne pas utiliser d'ampoules d'une puissance supérieure à celle recommandée. Pour un bon entretien, utiliser simplement un chiffon sec. N'utilisez aucun produit pur métaux, ils abiment le vernis protecteur.

Die Beschreibung und Maße der in diesem Katalog aufgeführten Modelle dienen zur Orientierung und können zur Verbesserung der technischen Eigenschaften oder des Designs geändert werden / Der Hersteller behält sich das Recht vor, Modelle zu ändern oder aus dem Programm wegzunehmen / Die geeigneten Modelle erfüllen alle die innerhalb der EU geforderten Normen und Richtlinien für Leuchten für allgemeine Beleuchtungszwecke der Schutzklassen I und II / Die Ausführungen und technischen Daten gelten für den europäischen Markt und können in anderen Ländern abweichen / Für eine gute Erhaltung der Leuchten bitten wir immer den empfohlene Leuchtmittel zu benutzen (keine höhere Leistung). Zur Reinigung benutzen Sie einfach ein trockenes Tuch, da Metallputzmitteln die Schutzlackierung angreifen können.

Le descrizione e le dimensioni degli articoli del presente catalogo vengono fornite a mero titolo orientativo e possono pertanto essere modificate al fine di migliorarne le caratteristiche tecniche o di design. / La Casa si riserva il diritto di cessare la produzione o di modificare qualsiasi modello senza preavviso. / Tutti i modelli presentati sono conformi alle normative C.E. per gli articoli da illuminazione per uso domestico di classe I e II. / Le rifiniture e le specifiche tecniche corrispondono ai prodotti venduti in Europa; tali dati possono pertanto variare su altri mercati. / Per una buona conservazione delle lampade, non utilizzare lampadine di potenza superiore a quella consigliata e pulirle semplicemente con un panno asciutto. Non utilizzare prodotti per la pulizia del metallo che potrebbero rovinare le vernici di protezione che garantiscono la vita della rifinitura.

Todos los derechos reservados. Ninguna parte de este libro puede ser reproducida en ningún formato de papel o electrónico, sin el consentimiento previo del editor o de los propietarios de los derechos.

All rights reserved. No part of this publication may be reproduced or transmitted in any form or by any means, electronic storage and retrieval system, without permission in writing from the copyright owner (s).

Tous droits réservés. Aucune partie de ce livre ne pourra être reproduite en format papier ou électronique sans l'autorisation préalable de l'éditeur ou du propriétaire des droits.

Sämtliche Rechte vorbehalten. Kein Teil dieses Buches darf in keinem Papier- oder elektronischem Format ohne ausdrückliche Zustimmung des Herausgebers oder der Inhaber der Urheberrechte wiedergegeben oder vervielfältigt werden.

Tutti i diritti riservati. Nessuna parte di questo libro può essere riprodotta in nessun formato cartaceo o elettronico, senza la previa autorizzazione dell'editore o dei proprietari dei diritti.





**LED S-C4**

**LED S-C4, S.A.**

Afuera s/n, - 25750 - TORA (Lleida) SPAIN

[www.leds-c4.com](http://www.leds-c4.com)

**España**

Tel.: 973 46 81 01

Fax.: 973 46 81 29

[info@leds-c4.com](mailto:info@leds-c4.com)

**Europe**

Tel.: + 34 973 46 81 02

Fax.: + 34 973 46 81 06

[europe@leds-c4.com](mailto:europe@leds-c4.com)

**France - Portugal**

Tel.: + 34 973 46 81 30

Fax.: + 34 973 46 81 29

[france@leds-c4.com](mailto:france@leds-c4.com)

[portugal@leds-c4.com](mailto:portugal@leds-c4.com)

**Asia - Pacific and Africa**

Tel.: + 34 973 46 81 16

Fax.: + 34 973 46 81 06

[export@leds-c4.com](mailto:export@leds-c4.com)

**USA - Canada - Ireland**

Tel.: +34 973 46 81 09

Fax: +34 973 46 81 06

[lighting@leds-c4.com](mailto:lighting@leds-c4.com)

**América Latina**

Tel.: + 34 973 46 81 15

Fax.: + 34 973 46 81 06

[sudamerica@leds-c4.com](mailto:sudamerica@leds-c4.com)

**Middle East Countries**

Tel.: + 34 973 46 81 08

Fax.: + 34 973 46 81 06

[dep-export@leds-c4.com](mailto:dep-export@leds-c4.com)

ISO 9001

**BUREAU VERITAS**  
Certification



Certificate N°: 7000085