

# ARCHITECTURAL

CATÁLOGO GENERAL 2010  
GENERAL CATALOGUE 2010

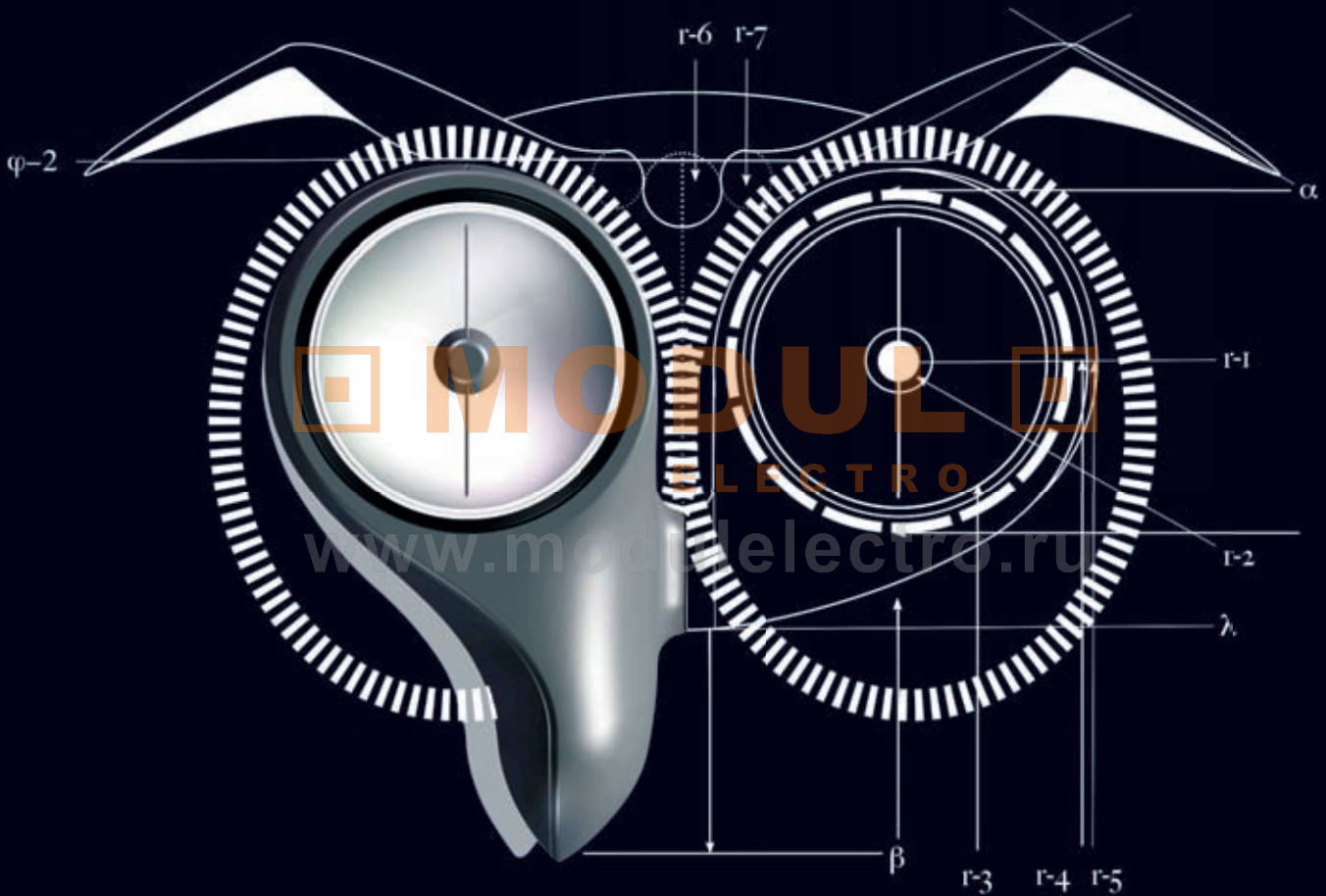

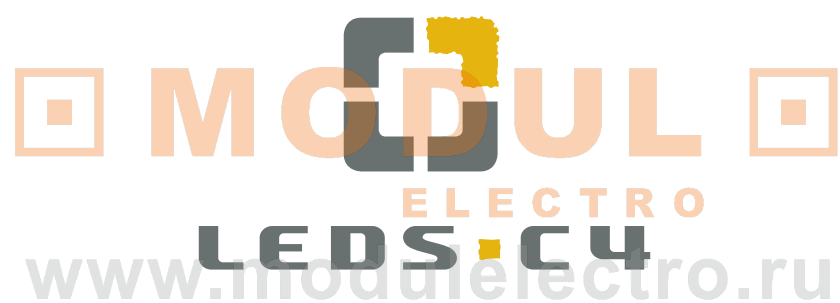

CATÁLOGO GENERAL 2010  
*GENERAL CATALOGUE 2010*

## PROYECTORES Y CARRILES / SPOTLIGHTS AND TRACKS



BUBO 10-17



CARRILES 26-29



DUPL0 22-25



MACH 1 18-21

## EMPOTRABLES DE TECHO / CEILING RECESSED



BORBOLETA 32-39



CAMALEON 40-47



CARDEX C 86



CARDEX CM 88-89



CARDEX E 84-85



CUADRO 76-81



ECO 72-75



EXTRA 94-97

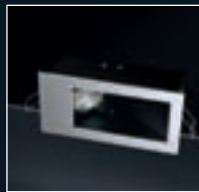

MINI 114-117



MULTIDIR 106-113



SATIN 98-101



SATIN EVOLUTION 102-105



TIMIUM 48-55



TRIMIUM E 56-59



TRIMIUM MINI 68-71



TRIMIUM S100 64-67



TRIMIUM S130 60-63



VITRO 90-93

## SISTEMAS DE FLUORESCENCIA LINEAL SUSPENDIDA / FLUORESCENT LINEAL LIGHTING SYSTEMS/



LOMA 120-131

## SUSPENDIDOS / SUSPENDED



BACO 180-189



FILIPA 138-141



LEDIO 144-149



MULTIDIR 112-113

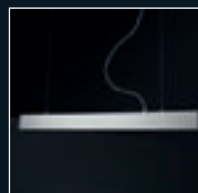

RECTA 134-137

## LED



BIT 150-152



DELTA 154-156



LEDIO 144-149



PETIT 150-153



SOUND 154-157

## EMPOTRABLES DE PARED / WALL RECESSED



CLAM 160-169

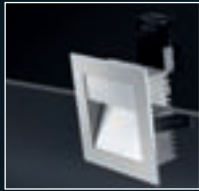

SIGN 174-177



WALL 170-173

## ADOSABLES / SURFACE MOUNTED



BACO 180-189

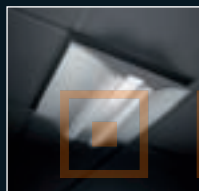

BORBOLETA 32-39



RAPID C 190-193



RECTA 134-137

## UNIDADES ELÉCTRICAS Y LÁMPARAS / ELECTRICAL UNITS AND LAMPS



Transformadores electrónicos 194  
Electronic transformers 194



Drivers 194  
Drivers 194



Reactancias electrónicas para HIT 195  
Electronic gear for HIT 195



Equipos magnéticos para HIT 195  
Magnetic gear for HIT 195

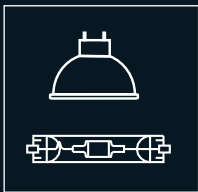

Lámparas 196-197  
Lamps 196-197

## OTRAS LUMINARIAS / OTHER LUMINAIRE



AFRODITA 206



COSMOS 207



GEA 208-212



GEA 208-212



GEA 209



GEA 208-212

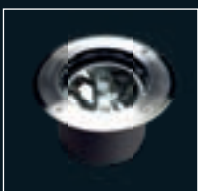

GEA 208-212



GEA 208-212



LINEAR 202



MICENAS 205



ONA 203



POMPEYA 205

## CONCEPTOS BÁSICOS DE LA ILUMINACIÓN

### Flujo luminoso $\phi$

Es la potencia luminosa de una lámpara o cantidad de luz emitida por la misma. Se mide en lumen (lm)

### Intensidad luminosa $I$

Es el flujo emitido por unidad de ángulo sólido en una dirección determinada. Se expresa en candela (cd)

### Iluminancia $E$

Es la relación entre el flujo luminoso y el área de la superficie a la que llega la luz. La unidad de medida es el lux ( $lx = lm/m^2$ )

### Luminancia $L$

Es la intensidad luminosa por unidad de superficie emitida o reflejada por dicha superficie en la dirección del ojo. Se mide en candela por unidad de superficie ( $cd/m^2$ ).

La luminancia es el concepto más cercano a la percepción visual.

### Eficacia luminosa $E_n$

También llamado rendimiento, se define como la relación entre el flujo luminoso emitido por la lámpara y la potencia consumida por la misma y se mide en lumen por vatio (lm/W)

### Factor de reflexión $\rho$

Define el porcentaje del flujo luminoso que incide en una superficie y es reflejado por la misma.

El valor de la luminancia (L) se obtiene al multiplicar la iluminancia (E) por el factor (o grado) de reflexión ( $\rho$ ) de las superficies iluminadas. En el caso de superficies perfectamente difusas:  $L = \rho \cdot E / \pi$ .

Por tanto, los colores más oscuros obligan a una superior iluminancia para obtener la misma luminancia y ello supone un mayor consumo eléctrico, es decir, una eficiencia energética (VEE) inferior.

### NIVEL DE ILUMINACIÓN

Algunos ejemplos de los niveles de iluminación (lx) recomendados para la correcta ejecución de las tareas a desarrollar en cada local:

## BASIC LIGHTING CONCEPTS

### Luminous flux $\phi$

Indicates the quantity of light the lamp emits in all directions. It's measured in lumen (lm)

### Luminous intensity $I$

Indicates the amount of luminous flux emitted per angle unit in to a certain direction. It's measured in candela (cd).

### Iluminance $E$

Indicates the ratio between the luminous flux and the surface area where the light arrives. It's measured in lux ( $lx = lm/m^2$ ).

### Luminance $L$

Indicates the luminous intensity, emitted or reflected in to the eye direction, per surface unit ( $cd/m^2$ ).

Luminance is closest concept of visual perception.

### Luminous efficacy $E_n$

Indicates the lamp performance or the amount of flux emitted per electrical power consumption on the lamp circuit (lm/W).

The higher this index, the better the lamp transforms electrical power into light flux emission.

### Reflection factor $\rho$

Indicates the ratio (%) between the total luminous flux falling on a certain surface and the amount reflected by the same surface.

The darker surfaces have much lower reflection factors which demands higher illuminances to obtain the same luminance or, in other words, to obtain the same luminance on a dark surface a higher power consumption is needed.

### LIGHTING LEVEL

Some examples of recommended levels (lx) for the adequate execution of certain tasks in different environments:

### NIVELES DE ILUMINANCIA RECOMENDADOS (lx) / RECOMMENDED ILLUMINANCE LEVELS (lx)

Industrias / Industries		Hoteles / Hotels		Oficinas / Offices	
Zonas generales / General zones	300	Vestíbulos de entrada / Entrance halls	300	Despachos / Cell office	500
Procesos automatizados / Automated processes	200	Comedores / Restaurants	200	Oficinas generales / Open space	750
Laboratorios / Laboratories	500	Dormitorios, baños / Rooms	150	Salas de delineación / Drawing room	750
Manufacturas / Assembly-shops	500	General / Corridors	100	Salas de reunión / Meeting room	500
Inspección / Inspection areas	750	Local / Reception area	300		
Comprobación de colores / Colour inspection	1000				
Escuelas / Schools		Tiendas / Shops			
Salas de clase / Classroom	300	Tiendas tradicionales / Traditional shops	300		
Laboratorios / Laboratory	500	Supermercados / Supermarkets	500		
Bibliotecas / Library	500	Hipermercados / Hypermarkets	750		
		Salones de muestras / Show-rooms	500		

## LUMINARIAS

Las luminarias son aparatos que sirven para la distribución, el filtrado o la transformación de la luz emitida por las lámparas, incluidos los componentes necesarios para la fijación, la protección y el funcionamiento de dichas lámparas.

Para la descripción de una luminaria se utilizan frecuentemente los lugares de montaje o de ubicación – empotrables, adosables, suspendidas, apliques de pared, etc. – o el tipo de distribución del haz de luz – downlights, asimétricos, orientables, etc.

En este catálogo, encontraremos ambas descripciones para subdividir las familias de productos.

### Clase de distribución luminosa

El tipo de luminaria viene determinado por su clase fotométrica o distribución espacial de la intensidad luminosa.

Para la iluminación general se consideran convenientes las distribuciones de luz extensivas y/o difusas, mientras que para la iluminación de acento se estiman adecuadas las distribuciones intensivas orientables. Para la iluminación perimetral de estanterías y de expositores se sopesa recomendable las distribuciones asimétricas tipo bañadores de pared.

En función del tipo de distribución luminosa del haz con que se ilumina el objeto, se obtienen resultados muy diferentes.

### Rendimiento

El rendimiento de una luminaria ( $\eta$ ) se define como la relación entre el flujo luminoso total emitido por la luminaria y la suma de los flujos luminosos de las lámparas individuales instaladas en su interior.

El rendimiento de una luminaria depende fundamentalmente del tipo de fuente de luz, del tipo y calidad del sistema óptico y de la calidad de los materiales utilizados en su construcción.

### Factor de utilización

Se define el factor de utilización ( $F_u$ ) como la relación entre el flujo útil que incide sobre el plano de trabajo y el flujo emitido por la totalidad de las lámparas instaladas en la luminaria.

El factor de utilización es función de los siguientes parámetros:

- Características geométricas del local (K)
- Rendimiento de la luminaria ( $\eta$ )
- Clase fotométrica de la luminaria
- Modo de instalación de las luminarias en el local (implatación)
- Factores de reflexión de las paredes, techo, suelo y plano útil iluminado

### Criterios de selección

La calidad luminotécnica y de los materiales, la rentabilidad, la seguridad y la comodidad del montaje (facilidad de instalación) son aspectos fundamentales para el diseño y fabricación de luminarias. En nuestra empresa damos especial atención a todos estos factores a la hora de desarrollar los productos que componen este catálogo.

Por otro lado, la estética de la luminaria y su aspecto deberán ir en armonía con los aspectos funcionales de la misma. Por esta razón, trabajamos con los mejores diseñadores para ofrecer productos que puedan ser integrados en los proyectos de más prestigio no sólo por sus calidades funcionales sino también por su cuidado aspecto y diseño innovador.

La marca CE documenta la seguridad en el funcionamiento y la conformidad con las normas de las luminarias de calidad.

## LUMINAIRES

*Luminaires are apparatus used for distributing, filtering or transforming the light given by the lamps and which include the components needed to fix, protect and connect the lamps to the supply circuit.*

*To describe or define the type of luminaire we can use either its way of mounting – recessed mounted, surface mounted, pendant, wall mounted, etc. – or the type of beam distribution – downlight, uplight, asymmetric, directional, etc.*

*In this catalogue, both descriptions are used to classify the product families/ranges.*

### Luminous intensity distribution

*The type of luminaire can be determined by its photometric class or spatial distribution of the luminous intensity.*

*Extensive and/or diffuse light distributions are convenient for general lighting, while directional intensive distributions are adequate for accent lighting. For perimeter lighting of shelves and expositors, asymmetrical distributions like wall-washers are recommended.*

*According to the beam used to light the object, different results are achieved.*

### Light output ratio

*The luminaire efficiency ( $\eta$ ) is defined as the relation between the total luminous flux emitted by the luminaire and the sum of light fluxes from individual lamps installed inside. Light output ratio mainly depends on the light source, the optical system of the luminaire and the quality of the materials used to manufacture it.*

### Utilisation factor

*The utilisation factor ( $F_u$ ) is defined as the relation between the utilised flux on the working surface, and the flux emitted by lamps installed in the luminaire.*

*The utilisation factor is a function of the following parameters:*

- Room index K (geometrical characteristics of the room)
- Light output ratio ( $\eta$ )
- Light distribution of the luminaire (photometrical class)
- Arrangement of the luminaires in the room
- Reflectance of walls, ceiling, floor and working plane

### Selection criteria

*Light-technical and material quality, profitability, safety and ease of installation are key factors for the design and manufacturing of luminaires. Within our Company, special attention is paid to all the above-mentioned factors to develop the products included in this catalogue.*

*On the other hand, aesthetics and aspect finishings must be in harmony with the functional features. For this reason, we work with the best designers to offer products which can be integrated in the most prestigious projects, not only for their functional qualities but also for their careful look and innovative design.*

*CE mark assures the electrical safety and the conformity with the European luminaire's quality norms.*

Otras clasificaciones importantes para la correcta selección de las luminarias y su aplicación son:  
Other classifications for the correct selection of luminaires and their application are the following:

### CLASIFICACIÓN IP / IP CLASSIFICATION

1ª cifra <i>1ª figure</i>	Grado de protección contra la penetración de partículas sólidas <i>Protection degree against the ingress of solids and dust</i>
IP 0X	Ninguna protección <i>No protection</i>
IP 1X	Sólidos de tamaño superior a 50 mm <i>Solids over 50 mm</i>
IP 2X	Sólidos de tamaño superior a 12 mm <i>Solids over 12 mm</i>
IP 3X	Sólidos de tamaño superior a 2,5 mm <i>Solids over 2.5 mm</i>
IP 4X	Sólidos de tamaño superior a 1 mm <i>Solids over 1 mm</i>
IP 5X	Protección contra el polvo <i>Protection against dust</i>
IP 6X	Estanca al polvo <i>Dust-tight</i>

2ª cifra <i>2ª figure</i>	Grado de protección contra la penetración de líquidos <i>Protection degree of sealing against the penetration of water</i>
IP X0	Ninguna protección <i>No protection</i>
IP X1	Caída de agua vertical <i>Dripping water</i>
IP X2	Caída de agua con inclinación máx. 15° <i>Dripping water when tilted up to 15°</i>
IP X3	Protegida contra lluvia (inclinación máx. 60°) <i>Spraying water</i>
IP X4	Salpicaduras de agua <i>Water splashing</i>
IP X5	Chorros de agua <i>Water jets</i>
IP X6	Chorros fuertes de agua <i>Heavy seas</i>
IP X7	Estanca a la inmersión <i>Effects of immersion</i>
IP X8	Estanca a la inmersión con presión <i>Submersion</i>

## CLASIFICACIÓN SEGÚN LA PROTECCIÓN CONTRA CHOQUES ELÉCTRICOS / CLASSIFICATION ACCORDING TO THE TYPE OF ELECTRICAL PROTECTION

Clase I 

Clase II 

Clase III 

La protección contra choques eléctricos incluye medidas de seguridad basadas en la conexión de las partes conductoras accesibles a un conductor de seguridad puesto a tierra.

*Protection against electrical shocks includes other measures based on the connection of accessible conductive parts to an earthing conductor.*

La protección contra choques eléctricos incluye medidas de seguridad basadas en el doble aislamiento o el aislamiento reforzado. Excluye toma de tierra.

*Protection against electrical shocks includes other measures based on the double reinforced insulation. Excludes earthing.*

La protección contra choques eléctricos se basa en una alimentación de muy baja tensión, a través de un transformador de seguridad, sin generarse tensiones superiores a ésta.

*Protection against electrical shocks includes other measures based on a very low voltage through a security transformer, without generating higher voltages.*

### CURVA DE DISTRIBUCIÓN LUMINOSA

Este diagrama (generalmente polar) representa las direcciones en las que emite una luminaria y con qué intensidad. Se toma como referencia un flujo de 1000 lumen por lo que los valores de la gráfica se facilitan en cd/Klm.

En este catálogo, facilitamos las curvas de las versiones más significativas de cada gama donde sólo se representa la curva del plano longitudinal (C0°-180°).

En nuestro software de cálculo se podrán consultar también los planos transversal (C90°-270°) y los intermedios (C45°-225° y C135°-315°).

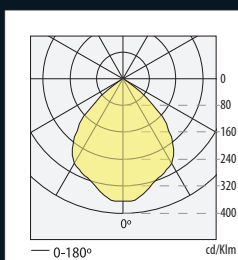

### LUMINOUS DISTRIBUTION CURVES

*This diagram (generally polar) represents the directions in which a luminaire emits, and its intensity.*

*A 1000-lumen flux is taken as reference, so the values on the graphic are given in cd/Klm.*

*In this catalogue, we show the curves for the most representative versions of each range, in which only the longitudinal plan (C0°-180°) is represented.*

*The transversal (C90°-270°) and intermediate (C45°-225° and C135°-315°) plans can be consulted in our calculation software.*

### DIAGRAMA DE FLUJO LUMINOSO

Este diagrama indica la iluminancia media (E<sub>av</sub>) medida en lux, a diferentes alturas respecto a la luminaria y el diámetro aproximado que dicho haz de luz proyecta a estas distancias.

### LUMINOUS FLUX DIAGRAM

*This diagram indicates the average (E<sub>av</sub>) illuminance, measured in lux, at different heights from the luminaire and the approximate diameter of the beam projected at those distances.*

H (m)	E <sub>med</sub> (lux)	D (m)
1	156.07	3.01
2	39.02	6.02
3	17.34	9.04
4	9.75	12.05



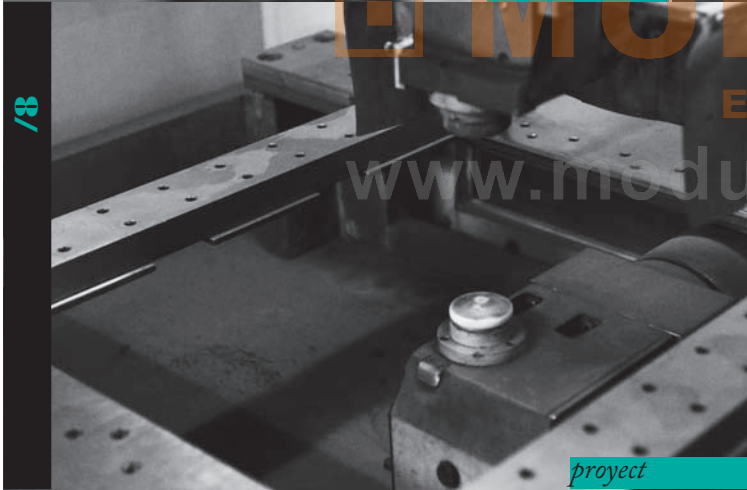
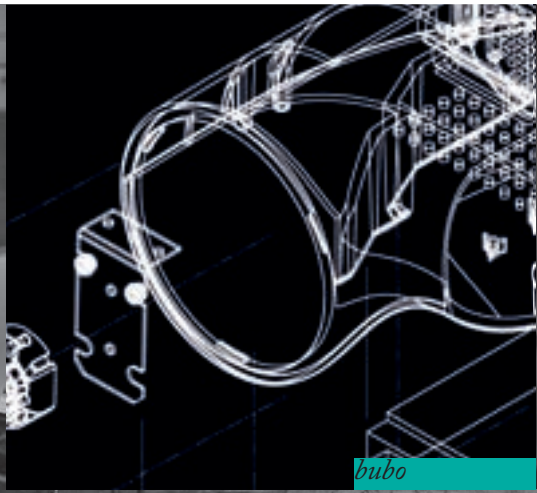

**MODUL**  
ELECTRO  
[www.modulelectro.ru](http://www.modulelectro.ru)

/8

# / PROYECTORES Y CARRILES



**MODUL**  
ELECTRO  
[www.modulelectro.ru](http://www.modulelectro.ru)

# */spotlights and tracks*

A man with short, light-colored hair is standing in a dark, industrial-style setting. He is wearing a white button-down shirt under a dark jacket. A single spotlight is directed at him from above, creating a dramatic effect. The background consists of dark, textured walls and a brick pillar on the right.

**MODUL**  
ELECTRO  
[www.modulselectro.ru](http://www.modulselectro.ru)

# /BUBO/

Design by:  
RAMON BENEDITO



proyectors / spotlights

arquitectural

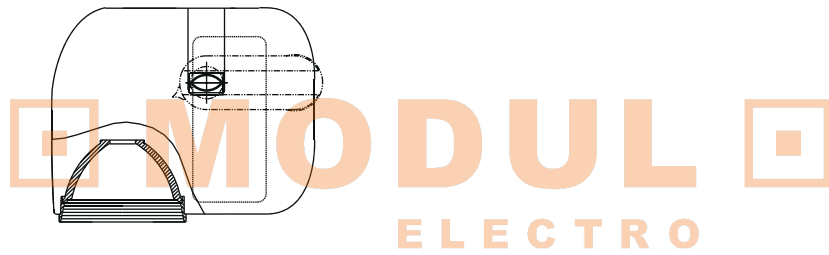
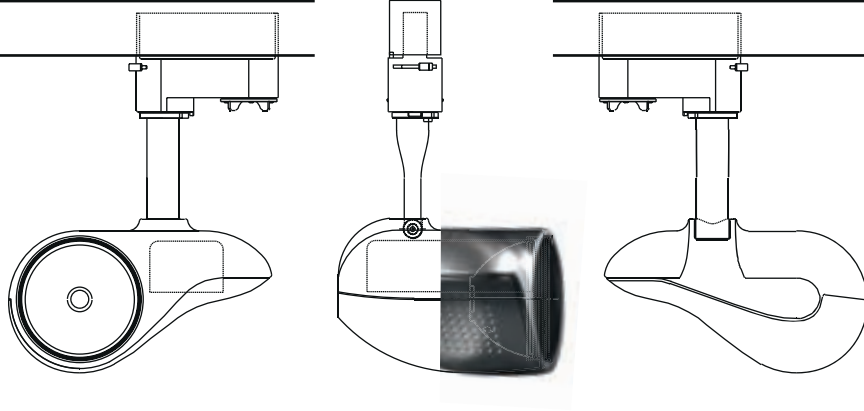

[www.modulelectro.ru](http://www.modulelectro.ru)

11

**Bubo es nuestra nueva gama de proyectores técnicos para escenificación. Muy apta para cualquier entorno que requiera iluminaciones dirigidas y flexibles. La posibilidad de incorporar un amplio surtido de lámparas lo convierten en una herramienta ideal para el escaparatismo. Sus distintos haces de luz son ideales para el realce y la iluminación de acento y su suave línea lo convierte en una pieza fácil de integrar en cualquier entorno.**

*Bubo is our brand new collection of technical spotlights for staging and shop windows.*

*Suitable for any space where directional and flexible lighting is required.*

*Bubo can take a wide range of lamps which makes the collection an ideal tool for shop windows.*

*Its different beam angles are ideal to bring out accent lighting and its soft shapes make its integration in any environment just effortless.*



El proyector permite una gran flexibilidad de movimientos y de distintas orientaciones para conseguir diferentes efectos escenográficos.

*The spotlight allows different orientations to facilitate the creation of different scenographic effects.*



**MODUL**  
ELECTRO

[www.modulelectro.ru](http://www.modulelectro.ru)

/12



La rotación del proyector en el eje horizontal es de 355° y en el eje vertical de 112°.

*The orientation system allows different adjustments: 355° rotation and 112° tilt.*



El proyector dispone de orificios dispuestos estratégicamente para garantizar el correcto flujo de ventilación por convección. El equipo de funcionamiento está alojado en una cavidad independiente para asegurar el aislamiento térmico apropiado de éste y el correcto funcionamiento de la lámpara.

Fácil reposición de la lámpara mediante el simple giro y extracción del elemento frontal de cierre. No requiere herramientas.

*The spotlight holds strategically located cavities to guarantee the correct flow of ventilation. The control gear is allocated in a separated space to ensure its thermal isolation and the correct ventilation inside the spotlight. The lamp can easily be replaced without tools by turning and extracting the front closure.*

**MODUL**  
ELECTRO

[www.modulelectro.ru](http://www.modulelectro.ru)





Blanco / White

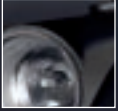

Negro / Black

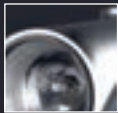

Gris / Grey



Proyector orientable compacto con adaptador para instalación en rail trifásico.  
Adjustable compact Spotlight for 3 phase track mounting.



QR-111 G53



CDM-R111 GX8.5

HIT-T G12

CÓDIGO CODE	COLOR COLOUR	LÁMPARA LAMP	W W	HAZ BEAM	EQUIPO GEAR	INSTALACIÓN INSTALLATION	
PR-0906-14-00	○	QR-111 G53	max. 100W	—			09-14
PR-0906-60-00	●	QR-111 G53	max. 100W	—			09-14
PR-0906-N3-00	●	QR-111 G53	max. 100W	—			09-14
PR-0907-14-00	○	CDM-R111 GX8.5	35W	—			15-17
PR-0907-60-00	●	CDM-R111 GX8.5	35W	—			15-17
PR-0907-N3-00	●	CDM-R111 GX8.5	35W	—			15-17
PR-0908-14-00	○	CDM-R111 GX8.5	70W	—			15-17
PR-0908-60-00	●	CDM-R111 GX8.5	70W	—			15-17
PR-0908-N3-00	●	CDM-R111 GX8.5	70W	—			15-17
PR-0909-14-00	○	HIT-T G12	35W	10°			87
PR-0909-60-00	●	HIT-T G12	35W	10°			87
PR-0909-N3-00	●	HIT-T G12	35W	10°			87
PR-0910-14-00	○	HIT-T G12	35W	45°			88
PR-0910-60-00	●	HIT-T G12	35W	45°	Elect. info		88
PR-0910-N3-00	●	HIT-T G12	35W	45°			88
PR-0911-14-00	○	HIT-T G12	70W	10°			89
PR-0911-60-00	●	HIT-T G12	70W	10°			89
PR-0911-N3-00	●	HIT-T G12	70W	10°			89
PR-0912-14-00	○	HIT-T G12	70W	45°			90
PR-0912-60-00	●	HIT-T G12	70W	45°			90
PR-0912-N3-00	●	HIT-T G12	70W	45°			90
PR-0913-14-00	○	HIT-T G12	150W	10°			91
PR-0913-60-00	●	HIT-T G12	150W	10°			91
PR-0913-N3-00	●	HIT-T G12	150W	10°			91
PR-0914-14-00	○	HIT-T G12	150W	45°			92
PR-0914-60-00	●	HIT-T G12	150W	45°			92
PR-0914-N3-00	●	HIT-T G12	150W	45°			92

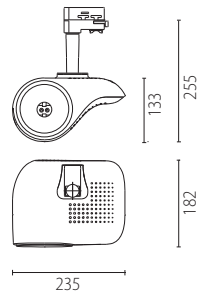

## ACCESORIOS ACCESSORIES

Base para montaje en superficie.  
Base for surface mounting.

CÓDIGO CODE	COLOR COLOUR
ACT-9105-14-00	○
ACT-9105-60-00	●
ACT-9105-N3-00	●



Caja para empotrar.  
Recessed box.

CÓDIGO CODE	COLOR COLOUR
ACT-9106-14-00	○
ACT-9106-60-00	●
ACT-9106-N3-00	●





**MODULO**  
ELECTRO  
www.moduloelectro.ru



Proyector orientable compacto con adaptador para instalación en raíl trifásico.  
Adjustable compact Spotlight for 3 phase track mounting.

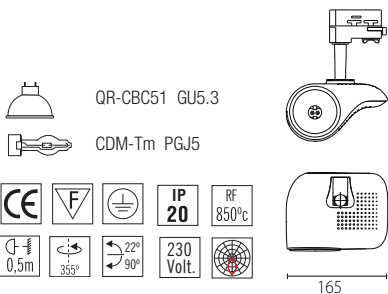

CÓDIGO CODE	COLOR COLOUR	LÁMPARA LAMP	W W	HAZ BEAM	EQUIPO GEAR	INSTALACIÓN INSTALLATION	
PR-0901-14-00	○	QR-CBC51 GU5.3	max. 50W	—	Elect. inc		*
PR-0901-60-00	●	QR-CBC51 GU5.3	max. 50W	—			*
PR-0901-N3-00	●	QR-CBC51 GU5.3	max. 50W	—			*
PR-0902-14-00	○	CDM-Tm PGJ5	20W	10°			*
PR-0902-60-00	●	CDM-Tm PGJ5	20W	10°			*
PR-0902-N3-00	●	CDM-Tm PGJ5	20W	10°			*
PR-0903-14-00	○	CDM-Tm PGJ5	20W	45°			*
PR-0903-60-00	●	CDM-Tm PGJ5	20W	45°			*
PR-0903-N3-00	●	CDM-Tm PGJ5	20W	45°			*

(\*) Consultar  
(\*) Consult





**MODULO**  
ELECTRO  
[www.modulelectro.ru](http://www.modulelectro.ru)

El cuervo quisiera que todo fuese negro; el búho, que todo fuese blanco.  
Proverbios del infierno, de William Blake

*The crow wish'd every thing was black, the owl that every thing was white.  
Proverbs of hell, William Blake*



**MODUL**  
ELECTRO  
[www.modulelectro.ru](http://www.modulelectro.ru)



MODULO ELECTRO

www.moduloelectro.com

# MACH1/

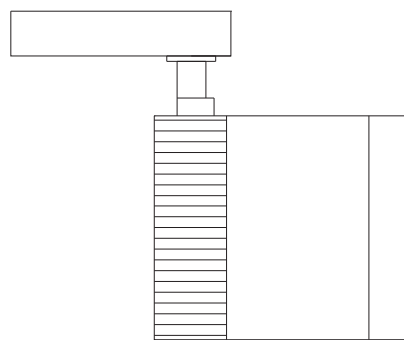

## DESCRIPCIÓN / DESCRIPTION

Cuerpo en aluminio extruido, acabado en color gris/plata. Disipador trasero y aro frontal en aluminio inyectado acabado en negro.

Versión para lámpara de baja tensión con transformador electrónico incorporado en el cuerpo del proyector.

Versión para lámpara HIT-T con el equipo de funcionamiento electrónico integrado en caja que actúa, también, como elemento de fijación. Estas versiones incluyen un reflector en aluminio anodizado de alta pureza disponible en dos versiones: óptica intensiva (10°) o semi-extensiva (45°).

Apto para instalación en carril trifásico o montaje superficial.

*Extruded aluminium body powder painted in silver grey.*

*Back heat sink and front ring in die-cast aluminium, black finish.*

*Versions for low voltage lamp with integrated electronic transformer in the spotlight body.*

*Versions for HIT-T lamps with electronic gear integrated in box which also works as spotlight fixation element. These versions include a reflector available in two versions: spot (10°) or flood (45°).*

*Versions available for three phase track or surface mounting*

## APLICACIÓN / APPLICATIONS

Gama especialmente diseñada para la integración y la polivalencia de aplicaciones como detalles arquitectónicos, escaparatismo, realce de objetos y creación de escenas de iluminación.

*Specially designed for the integration and the variety of applications such as architectural highlighting, shop window lighting, objects highlighting and creation of lighting scenes.*



# MACH1/

Ver fotometrías en página 214 y tabla de equivalencias de lámparas en página 223.

See Photometric data on page 214 and equivalent lamps table on page 223.



●  
Gris / Grey



Proyector orientable para QR-111 y HIT-T  
Adjustable spotlight for QR-111 or HIT -T



CÓDIGO CODE	COLOR COLOUR	LÁMPARA LAMP	VOLT. VOLT	W W	HAZ BEAM	EQUIPO GEAR	INSTALACIÓN INSTALLATION	
PR-0020-N3-00	●	QR-111 G53	230	max.1x65W	-	Elect. inc	3C	09-11

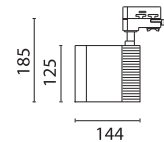

CÓDIGO CODE	COLOR COLOUR	LÁMPARA LAMP	VOLT. VOLT	W W	HAZ BEAM	EQUIPO GEAR	INSTALACIÓN INSTALLATION	
PR-0019-N3-00	●	QR-111 G53	230	max.1x65W	-	Elect. inc		09-11

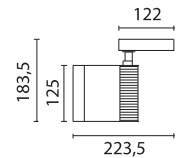

CÓDIGO CODE	COLOR COLOUR	LÁMPARA LAMP	VOLT. VOLT	W W	HAZ BEAM	EQUIPO GEAR	INSTALACIÓN INSTALLATION	
PR-0383-N3-00	●	HIT-T G12	230	1x70W	45°	Elect. inc	3C	82
PR-0385-N3-00	●	HIT-T G12	230	1x150W	45°			22

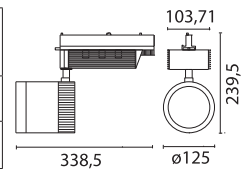



projectors / spot lights

architectural

**MODUL**  
ELECTRO  
[www.modulelectro.ru](http://www.modulelectro.ru)



**MODUL**

ELECTRO

[www.modul.electro.ru](http://www.modul.electro.ru)

122



# /DUPLO/

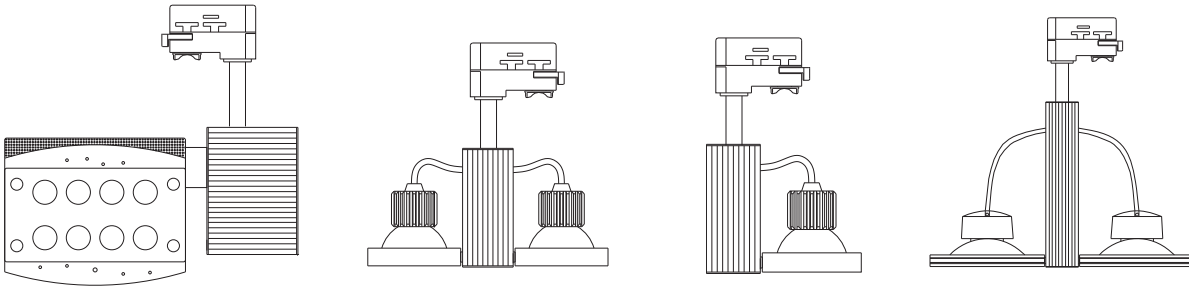

## DESCRIPCIÓN / DESCRIPTION

El cuerpo principal del proyector, en aluminio extruido pintado en color gris/plata, incorpora el equipo de funcionamiento (electrónico), el adaptador para el carril trifásico y el sistema multidireccional para fijación y conexión de la(s) lámpara(s).

Las versiones para HIT-TC y QT-TC incorporan un reflector en aluminio anodizado alojado en el interior de un compartimento óptico en aluminio inyectado.

En las versiones para lámpara(s) QR (-111 o -CB51) el alojamiento porta-lámpara(s), además de su función altamente estética, funciona como disipador de calor.

*The main body of the spotlight, made of extruded aluminium finished with silver/grey painting, incorporates the electronic gear, the track adaptor and the multidirectional system for fixation and connection of the lamp(s).*

*Versions for HIT-TC and QT-TC include an aluminium anodised reflector integrated in a die-cast aluminium optical compartment.*

*In the versions for QR (-111 or -CB51) lamp(s) the lampholder compartment, on top of its highly esthetical function, works as a heat dissipator.*

## APLICACIÓN / APPLICATIONS

Toda la gama DUPLO es para instalación en carril trifásico o superficie e incorpora equipos electrónicos para un perfecto funcionamiento de las lámparas y ahorro de energía.

Las versiones de doble lámpara proporcionan importantes ahorros en la inversión inicial y en la instalación.

Esta gama es ideal para el alumbrado de acentuación como escaparatismo y realce de objetos y estanterías.

*All versions are available for installation in 3-circuit track or surface mounting and have integrated the electronic gear for perfect functioning of the lamps and energy savings.*

*Furthermore, the double-lamp versions provide important savings in the initial investment and installation labour.*

*Ideal for accent lighting, namely for shop-windows and highlighting of objects and shelves.*

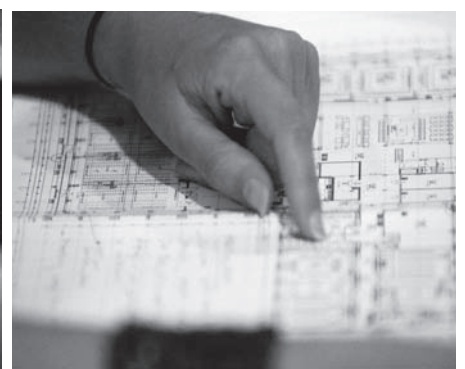



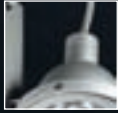

Gris / Grey



Proyector orientable para HIT-TC o QT-TC  
Adjustable spotlight for HIT-TC or QT-TC

CÓDIGO CODE	COLOR COLOUR	LÁMPARA LAMP	VOLT. VOLT	W W	HAZ BEAM	EQUIPO GEAR	INSTALACIÓN INSTALLATION	
PR-0009-N3-00	●	HIT-TC G8.5	230	70W	20°	Elect. inc	3C	23
PR-0010-N3-00	●	QT-TC G8.5	230	max.70W	20°			24

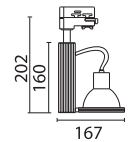

PR-0009-N3-00

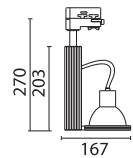

PR-0010-N3-00

Proyector orientable para QT-TC  
Adjustable spotlight for QT-TC

CÓDIGO CODE	COLOR COLOUR	LÁMPARA LAMP	VOLT. VOLT	W W	HAZ BEAM	EQUIPO GEAR	INSTALACIÓN INSTALLATION	
PR-0011-N3-00	●	QT-TC G8.5	230	max.2x60W	20°	Elect. inc	3C	24

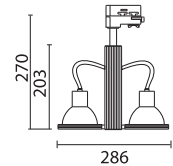

Proyector orientable para QR-111  
Adjustable spotlight for QR-111

CÓDIGO CODE	COLOR COLOUR	LÁMPARA LAMP	VOLT. VOLT	W W	HAZ BEAM	EQUIPO GEAR	INSTALACIÓN INSTALLATION	
PR-0012-N3-00	●	QR-111 G53	230	max.100W	-	Elect. inc	3C	09-14

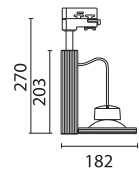

Proyector orientable para 2 x QR-111  
Adjustable spotlight for 2 x QR-111

CÓDIGO CODE	COLOR COLOUR	LÁMPARA LAMP	VOLT. VOLT	W W	HAZ BEAM	EQUIPO GEAR	INSTALACIÓN INSTALLATION	
PR-0013-N3-00	●	QR-111 G53	230	max.2x65W	-	Elect. inc	3C	09-14

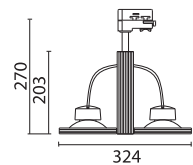

## ACCESORIOS. ACCESSORIES

Base para montaje en superficie.  
Base for surface mounting.

CÓDIGO CODE	COLOR COLOUR
ACT-9105-60-00	●
ACT-9105-N3-00	●



Caja para empotrar.  
Recessed box.

CÓDIGO CODE	COLOR COLOUR
ACT-9106-60-00	●
ACT-9106-N3-00	●



# MODULO ELECTRO

www.modulelectro.ru



## Proyector orientable para QR-CB51 Adjustable spotlight for QR-CB51

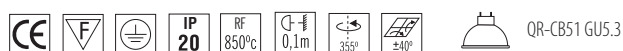

CÓDIGO CODE	COLOR COLOUR	LÁMPARA LAMP	VOLT. VOLT	W W	HAZ BEAM	EQUIPO GEAR	INSTALACIÓN INSTALLATION	
PR-0014-N3-00	●	QR-CB51 GU5.3	230	max.50W	-	Elect. inc	3C	01-08

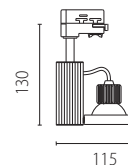

## Proyector orientable para 2 x QR-CB51 Adjustable spotlight for 2 x QR-CB51

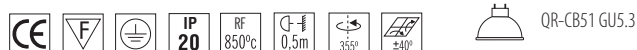

CÓDIGO CODE	COLOR COLOUR	LÁMPARA LAMP	VOLT. VOLT	W W	HAZ BEAM	EQUIPO GEAR	INSTALACIÓN INSTALLATION	
PR-0015-N3-00	●	QR-CB51 GU5.3	230	max.2x35W	-	Elect. inc	3C	01-08

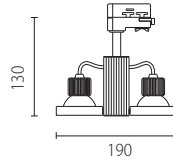

## Proyector orientable para 8xPowerLeds Luxeon Star Adjustable spotlight for 8xPowerLeds Luxeon Star

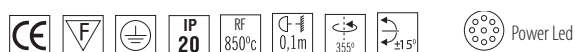

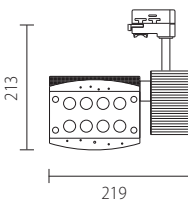

CÓDIGO CODE	COLOR COLOUR	LÁMPARA (2) LAMP	VOLT. VOLT	W W	HAZ BEAM	EQUIPO GEAR	INSTALACIÓN INSTALLATION	
PR-0016-N3-00	●	Power Led	230	8W	15°	Elect. inc	3C	25



(2) LED suministrado con el aparato  
(2) LED included with the luminaire



 **MODUL**   
ELECTRO  
[www.modulelectro.ru](http://www.modulelectro.ru)

# /CARRILES TRACKS/

## MODULO ELECTRO

### DESCRIPCIÓN / DESCRIPTION

Carril electrificado trifásico para montaje en superficie o suspendido.  
Construido en aluminio extruido acabado con pintura epoxi de color gris,  
negro o blanco.  
Conductores eléctricos de cobre de 2,5 mm<sup>2</sup> de sección, aislados mediante  
PVC extruido.  
El programa se completa con todos los accesorios de alimentación,  
interconexión, derivación, etc., necesarios para la correcta instalación del  
sistema. Dichos elementos se suministran en color negro o blanco.

*Three-circuit track for surface or pendant mounting.  
Extruded steel in grey, black or white powder painting finishing.  
Electrical copper conductors with a 2.5 mm<sup>2</sup> section, isolated by extruded PVC.  
The program is completed with all feeding, interconnection and derivation  
accessories, needed to properly install the system. Those elements are supplied in black  
or white colour.*



# /CARRILES / TRACKS/



Gris / Grey    Blanco / White    Negro / Black

**Carril trifásico.**  
Three-circuit track.

CÓDIGO CODE	COLOR COLOUR	L (MM)
CR-0323-N3-00	●	1000
CR-0323-14-00	○	1000
CR-0323-60-00	●	1000
CR-0324-N3-00	●	2000
CR-0324-14-00	○	2000
CR-0324-60-00	●	2000

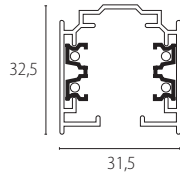

**ESQUEMA DE CONEXIÓN**  
CONNECTION SCHEMES

**CORTE DE LOS CARRILES.**  
TRACK CUTTING.

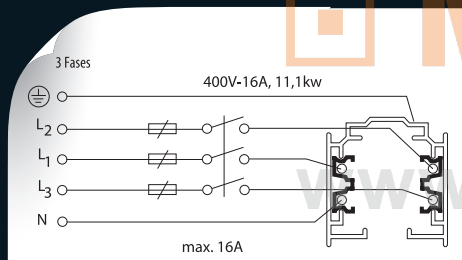
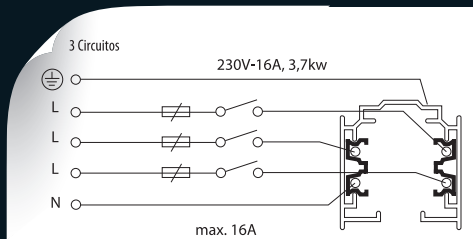
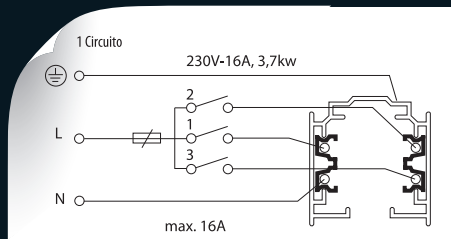

28

**MODULO ELECTRO**  
www.modulelectro.com

**ELEMENTOS DE FIJACIÓN Y ACCESORIOS**  
INSTALLATIONS ACCESSORIES



**TECHO**

**FALSE CEILING**

Para piezas de fijación directa a falsos techos.  
For direct mounting on false ceilings.

CÓDIGO CODE	COLOR COLOUR
CR-0333-N3-00	●
CR-0333-14-00	○

**SUSPENSIÓN CON TOMA DE CORRIENTE**  
SUSPENSION WITH MAINS SUPPLY

Florón para cable  
Canopy for cable  
(1.300mm)

CÓDIGO CODE	COLOR COLOUR
CR-0334-N3-00	●
CR-0334-14-00	○

**DOBLADO**

**CONDUCTOR BENDING**

Herramienta de doblado  
Ending tool needed after cutting the track

CÓDIGO CODE	COLOR COLOUR
CR-0335-00-00	-

**SUSPENSIÓN**

**SUSPENSION**  
Sirga de acero  
Steel cable  
(1.300mm)

CÓDIGO CODE	COLOR COLOUR
CR-0336-N3-00	●
CR-0336-14-00	○

**DISTANCIA RECOMENDADA ENTRE FIJACIONES**  
ADVISED DISTANCE FOR FIXATIONS

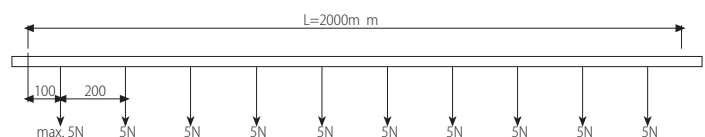
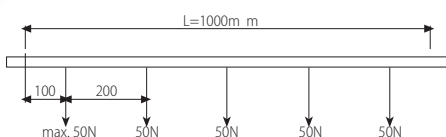

ACCESORIOS DE CONEXIÓN  
CONNECTION ACCESSORIES

Acometida izquierda  
Mains connector (left)

CÓDIGO CODE	COLOR COLOUR
CR-0325-14-00	○
CR-0325-60-00	●



Acometida derecha  
Mains connector (right)

CÓDIGO CODE	COLOR COLOUR
CR-0326-14-00	○
CR-0326-60-00	●



Tapa final  
End cap

CÓDIGO CODE	COLOR COLOUR
CR-0327-14-00	○
CR-0327-60-00	●



Conector continuidad  
Straight connector

CÓDIGO CODE	COLOR COLOUR
CR-0328-14-00	○
CR-0328-60-00	●

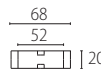

Conector ajustable  
Adjustable connector

CÓDIGO CODE	COLOR COLOUR
CR-0329-14-00	○
CR-0329-60-00	●

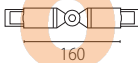

Conector "T" izquierdo  
"T" connector left

CÓDIGO CODE	COLOR COLOUR
CR-0331-14-00	○
CR-0331-60-00	●

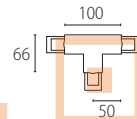

Conector "T" derecho  
"T" connector right

CÓDIGO CODE	COLOR COLOUR
CR-0332-14-00	○
CR-0332-60-00	●

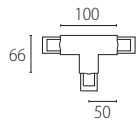

www.modulelectro.ru

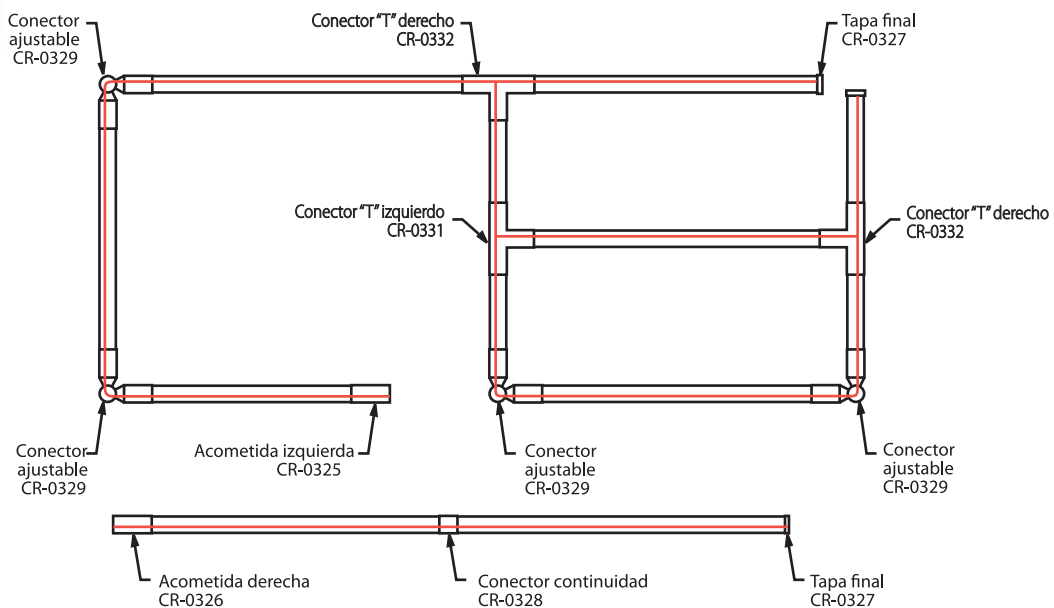

EJEMPLOS DE MONTAJE

Los carriles están provistos de un nervio, en su parte inferior, que condiciona la posición de los elementos de conexión. A fin de garantizar la necesaria continuidad del conductor de tierra, algunos de estos elementos de conexión – acometida y "T" – deben ser seleccionados teniendo en cuenta este aspecto.

MOUNTING EXAMPLES

Tracks have a nerve on their upper part, conditioning the position for earth connection. Some of the connections elements – live connections and "T" – must be selected to guarantee the necessary continuity of the earth conductor.

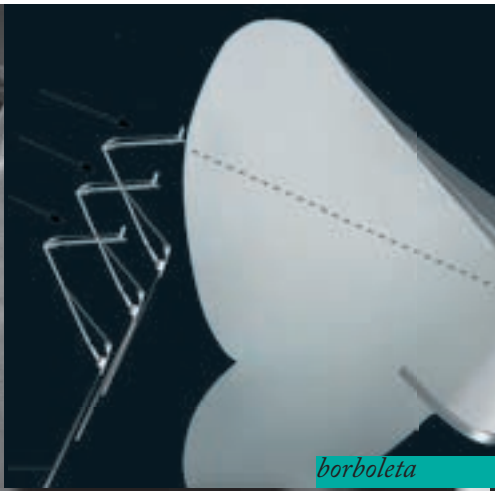
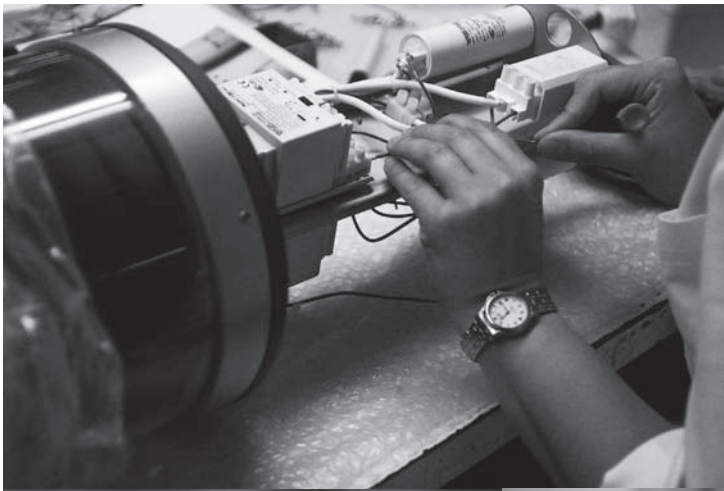

borboleta



MODUL  
ELECTR  
www.modulelectro.ru



/30

# /EMPOTRABLES DE TECHO



empotrables de techo / ceiling recessed

arquitectural

**MODUL**  
ELECTRO

camaleon

www.modul.es

/31

*/ceiling recessed*





**MODUL**  
ELECTRO  
[www.modulelectro.ru](http://www.modulelectro.ru)

732

# /BORBOLETA/

Design by:  
RAMON BENEDITO

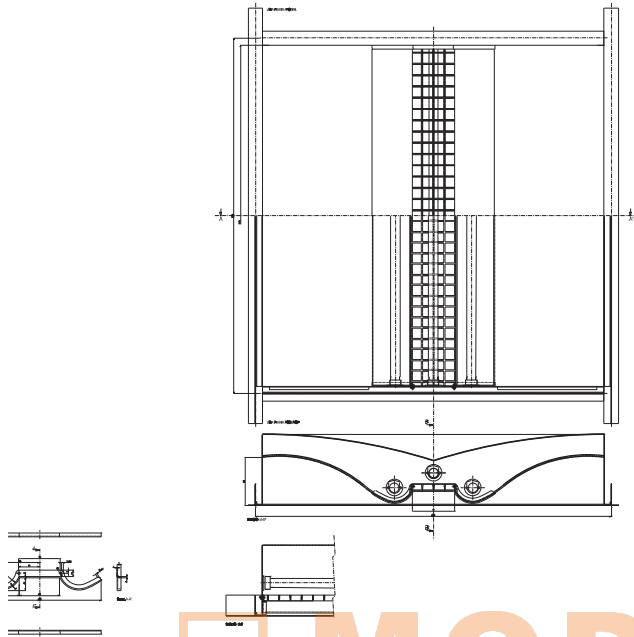

**MODUL**  
ELECTRO

[www.modulelectro.ru](http://www.modulelectro.ru)

**Gama de luminarias fluorescentes para iluminación general.  
Innovación, excelente diseño, alto rendimiento lumínico, confort y suavidad de la luz emitida y variedad de aplicaciones convierten esta gama en la solución para los proyectos de iluminación con elevados requerimientos de calidad (tanto a nivel lumínico como a nivel de integración arquitectónica y decorativa).**

*Fluorescent luminaires range for general lighting.  
Innovation, excellent design and finishings, quality of all materials used, high efficiency, comfort and variety of applications, convert this range into the ideal solution for all projects with high quality requirements, both on a lighting level and a decorative and architectonic integration level.*

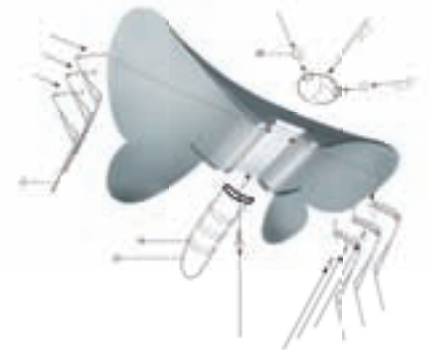



# MODULO

www.moduloelectro.ru

Luminaria para empotrar en falsos techos de perfil vistos , montaje en superficie o de suspensión regulable en altura. También disponible en versión regulable 1...10V y DALI/ PUSH-PULL, con la posibilidad de incluir en las versiones empotrables un KIT para ALUMBRADO DE EMERGENCIA. Cuerpo en chapa metálica pintada en blanco con pintura epoxi resistente a la corrosión.

Sistema óptico desarrollado para proporcionar una iluminación suave y un alto rendimiento:

- la versión de 2 lámparas tiene, en la parte central, un difusor translúcido
- la versión de 3 lámparas tiene, en la parte central, una óptica de baja luminancia en aluminio anodizado de muy alta pureza para una adecuada iluminación directa.

Disponible para 2 ó 3 lámparas fluorescentes TL5 de 14 ó 24W y suministradas completas con equipo de funcionamiento electrónico y lámparas de color 840 (para otros colores consultar).

*Luminaire for recessed mounting on visible profile false ceilings, surface mounting or suspended. Dimmable 1...10V and DALI/ PUSH-PULL versions also available. The recessed versions offer the possibility to include an emergency lighting kit.*

*Housing made of steel sheet finished with white epoxi painting. Optical system developed to provide a soft and high efficiency lighting: - two lamps version has, in the central part, one translucent diffuser - three lamps version has, in the central part, one anodised aluminium low luminance optic for an adequate direct lighting of the third lamp. Available for 2 or 3 TL5 14W or 24W fluorescent lamps and delivered complete with electronic gear and lamps (840 colour - for other colours please consult).*



**MODUL**  
ELECTRO  
[www.modulelectro.ru](http://www.modulelectro.ru)

Luminarias especialmente diseñadas para proporcionar una luz suave y un alto rendimiento libre de deslumbramientos. Especialmente indicadas para ser utilizadas en cualquier proyecto de iluminación general – tiendas, centros comerciales, oficinas, despachos, hoteles - donde el confort visual y la excelente calidad de los productos sean los principales requerimientos.

*Luminaires specially designed to provide a soft light and a high efficiency without disturbing glare. Specially indicated to be used in any general lighting project – shops, commercial centres, office buildings, office cells, hotels – where visual comfort and excellent quality and design of the products are the main requirements.*

# /BORBOLETA

Ver fotometrías en página 214 y tabla de equivalencias de lámparas en página 223.

See Photometric data on page 214 and equivalent lamps table on page 223.



Luminaria empotrable para iluminación general en falsos techos de perfil visto.  
Recessed luminaire for general lighting on false ceiling with visible profile.



Lámpara color 840 incluida.  
840 colour lamp included.

CÓDIGO CODE	COLOR COLOUR	LÁMPARA LAMP	W W	HAZ BEAM	EQUIPO GEAR	INSTALACIÓN INSTALLATION		VERSIÓN VERSION
EP-0612-14-B9	○	TL5 G5	3x14W	—	Elect. inc.			97 standard
EP-0614-14-B9	○	TL5 G5	3x24W	—				99 standard
EP-0620-14-B9	○	TL5 G5	3x14W	—				97 regul./dimm. 1...10V
EP-0622-14-B9	○	TL5 G5	3x24W	—				99 regul./dimm. 1...10V
EP-0628-14-B9	○	TL5 G5	3x14W	—				97 DALI/ PUSH PULL
EP-0630-14-B9	○	TL5 G5	3x24W	—				99 DALI/ PUSH PULL
EP-0636-14-B9	○	TL5 G5	3x14W	—				97 emergency 1H
EP-0640-14-B9	○	TL5 G5	3x24W	—				99 emergency 1H

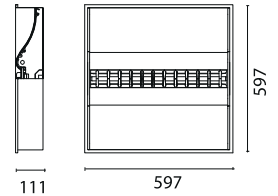

EP-0613-14-B9	○	TL5 G5	2x14W	—	Elect. inc.			98 standard
EP-0615-14-B9	○	TL5 G5	2x24W	—				100 standard
EP-0621-14-B9	○	TL5 G5	2x14W	—				98 regul./dimm. 1...10V
EP-0623-14-B9	○	TL5 G5	2x24W	—				100 regul./dimm. 1...10V
EP-0629-14-B9	○	TL5 G5	2x14W	—				98 DALI/ PUSH PULL
EP-0631-14-B9	○	TL5 G5	2x24W	—				100 DALI/ PUSH PULL
EP-0637-14-B9	○	TL5 G5	2x14W	—				98 emergency 1H
EP-0641-14-B9	○	TL5 G5	2x24W	—				100 emergency 1H

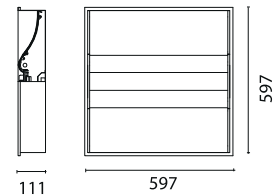

Luminaria adosable para iluminación general.  
Surface luminaire for general lighting.



Lámpara color 840 incluida.  
840 colour lamp included.

CÓDIGO CODE	COLOR COLOUR	LÁMPARA LAMP	W W	HAZ BEAM	EQUIPO GEAR	INSTALACIÓN INSTALLATION		VERSIÓN VERSION
AD-0616-N3-00	●	TL5 G5	3x14W	—	Elect. inc.			93 standard
AD-0618-N3-00	●	TL5 G5	3x24W	—				95 standard
AD-0624-N3-00	●	TL5 G5	3x14W	—				93 regul./dimm. 1...10V
AD-0626-N3-00	●	TL5 G5	3x24W	—				95 regul./dimm. 1...10V
AD-0632-N3-00	●	TL5 G5	3x14W	—				93 DALI/ PUSH PULL
AD-0634-N3-00	●	TL5 G5	3x24W	—				95 DALI/ PUSH PULL

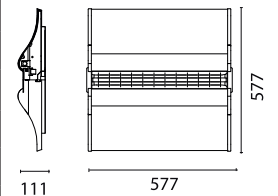

AD-0617-N3-00	●	TL5 G5	2x14W	—	Elect. inc.			94 standard
AD-0619-N3-00	●	TL5 G5	2x24W	—				96 standard
AD-0625-N3-00	●	TL5 G5	2x14W	—				94 regul./dimm. 1...10V
AD-0627-N3-00	●	TL5 G5	2x24W	—				96 regul./dimm. 1...10V
AD-0633-N3-00	●	TL5 G5	2x14W	—				94 DALI/ PUSH PULL
AD-0635-N3-00	●	TL5 G5	2x24W	—				96 DALI/ PUSH PULL

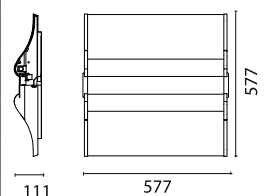

/36



●  
Blanco / White

●  
Gris / Grey

empotrables de techo / ceiling recessed

arquitectural

**MODULO**  
ELECTRO

[www.modulelectro.ru](http://www.modulelectro.ru)

137

Kit suspensión.  
Suspension kit.



CÓDIGO CODE	COLOR COLOUR	DESCRIPCIÓN DESCRIPTION
ACT-9046-N3-00	●	Kit suspensión + 4 sirgas / Suspension Kit + 4 steel cables

Para versión suspendida solicitar luminaria + kit suspensión.  
For suspended version, order luminaire + suspension kit.

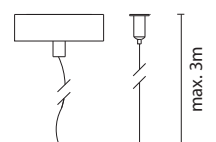



/38

# /BORBOLETA

## MODULETA

ELECTRO

[www.modulelectro.ru](http://www.modulelectro.ru)



empotrables de techo / ceiling recessed

arquitectural

**MODUL**  
ELECTRO  
[www.modulelectro.ru](http://www.modulelectro.ru)



**MODUL**  
ELECTRO  
[www.modulelectro.ru](http://www.modulelectro.ru)

# /CAMALEÓN/

Design by:  
ESTUDI RIBAUDI

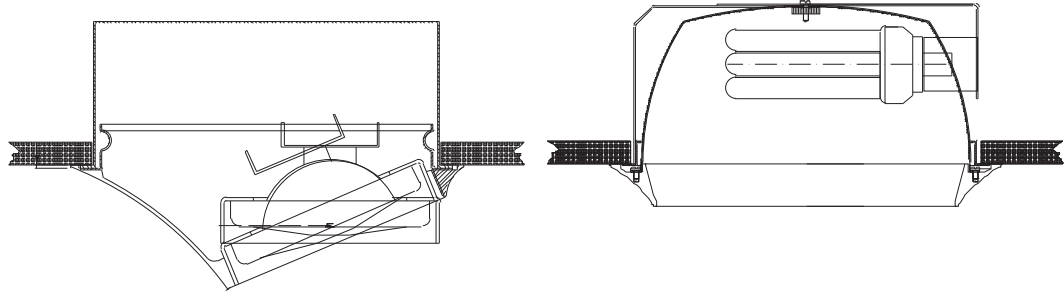

empotrables de techo / ceiling recessed

arquitectural

**MODUL**  
ELECTRO  
[www.modulelectro.ru](http://www.modulelectro.ru)

/41

**Camaleón es una serie de apliques empotrables multifunción. Ha sido concebida para adaptarse perfectamente a su entorno. Camaleón, en su acabado blanco mate, se ha desarrollado para integrarse cromáticamente en la superficie de instalación. La luminaria permite ser pintada con la misma pintura que usted usaría para colorear su pared o techo camuflándose así de forma perfecta en el ambiente. Una nueva forma de concebir la iluminación.**

*Designed to achieve a perfect integration with the environment, a new range of recessed multifunction fittings is born under the name of Camaleón. The matt white version has been developed to match chromatically with the mounting surface. Its external housing can be coloured with the same paint used on walls or ceilings matching perfectly with different atmospheres. A new lighting concept is born.*





La versión asimétrica, mediante un sistema de doble chasis interior, permite orientar la luminaria en un ángulo de 355°.

*The asymmetric version, thanks to its internal double body, permits the orientation of the luminaire in 355° angle*



**MODUL**  
ELECTRO  
[www.modulelectro.ru](http://www.modulelectro.ru)

142

Sobre el acabado blanco mate se ha aplicado un tratamiento específico que ofrece la posibilidad de emplear sobre el cuerpo de la luminaria la misma pintura plástica aplicada en el techo, de manera que quede perfectamente integrada en éste.

*A specific treatment has been given to the matt white version offering the possibility of using on the luminaire the same plastic paint used on the ceiling in order to achieve a perfect integration among both.*



**MODUL**  
ELECTRO  
[www.modulelectro.ru](http://www.modulelectro.ru)



El sistema basculante interior de la lámpara (60°) ofrece múltiples posibilidades de orientación y dota de gran versatilidad a la luminaria.

*The internal adjustment system of the lamp (60°) offers multiple directional combinations and makes the luminary extremely versatile.*

# /CAMALEON/



Blanco / White



Anodizado plata/  
Anodized silver



Luminaria empotrable asimétrica para iluminación de ambiente y/o acento.  
Recessed asymmetric luminaire for ambient and/or accent lighting.



CÓDIGO CODE	COLOR COLOUR	LÁMPARA LAMP	VOLT. VOLT	W W	HAZ BEAM	CLASE CLASS	EQUIPO GEAR	INSTALACIÓN INSTALLATION	
DN-1302-14-00	○	QR-111 G53	12	max. 100W	-	III			09-14
DN-1302-J2-00	◐	QR-111 G53	12	max. 100W	-	III			09-14
DN-1305-14-00	○	CDM-R111 GX8.5	230	max. 70W	-	II	Not inc		15-20
DN-1305-J2-00	◐	CDM-R111 GX8.5	230	max. 70W	-	II			15-20

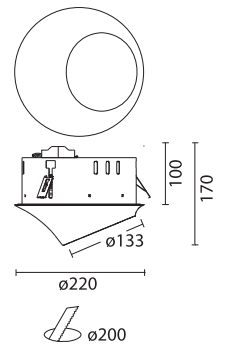

Luminaria empotrable asimétrica para iluminación general.  
Recessed asymmetric luminaire for general lighting.



CÓDIGO CODE	COLOR COLOUR	LÁMPARA LAMP	VOLT. VOLT	W W	HAZ BEAM	EQUIPO GEAR	INSTALACIÓN INSTALLATION	
DN-1301-14-00	○	TC-TEL GX24q-3	230	2x26/32W	-	Elect. inc		109
DN-1301-J2-00	◐	TC-TEL GX24q-3	230	22x26/32W	-			109

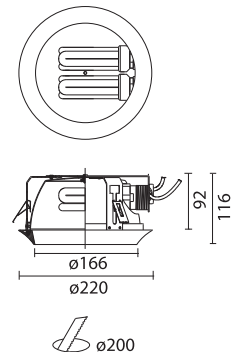

Equipo no incluido, a pedir separadamente, ver pág. 194  
Gear not included, to be ordered separately, see page 194

Disponible como accesorio una cruz anti-deslumbrante para DN-1301.  
A low luminance cross louvre is available as an accessory for DN-1301.

CÓDIGO  
CODE

ACT-9061-00-00



Ver fotometrías en página 214 y tabla de equivalencias de lámparas en página 223.

See Photometric data on page 214 and equivalent lamps table on page 223.



# MODUL

## ELECTRO

www.modulelectro.ru

empotrables de techo / ceiling recessed

arquitectural

/45



Luminaria empotrable asimétrica para iluminación de ambiente y/o acento.  
Recessed asymmetric luminaire for ambient and/or accent lighting.

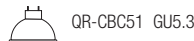

CÓDIGO CODE	COLOR COLOUR	LÁMPARA LAMP	VOLT. VOLT	W W	HAZ BEAM	EQUIPO GEAR	INSTALACIÓN INSTALLATION	
DN-1304-14-00	○	QR-CBC51 GU5.3	12	max. 50W	—	Not inc		01-08
DN-1304-J2-00	◐	QR-CBC51 GU5.3	12	max. 50W	—			01-08

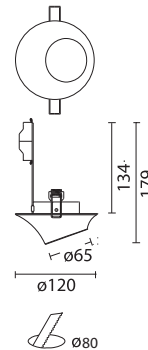

Luminaria empotrable asimétrica para iluminación general.  
Recessed asymmetric luminaire for general lighting.



CÓDIGO CODE	COLOR COLOUR	LÁMPARA LAMP	VOLT. VOLT	W W	HAZ BEAM	EQUIPO GEAR	INSTALACIÓN INSTALLATION	
DN-1303-14-00	○	QR-CBC51 GU5.3	12	max. 50W	—	Not inc		01-08
DN-1303-J2-00	◐	QR-CBC51 GU5.3	12	max. 50W	—			01-08

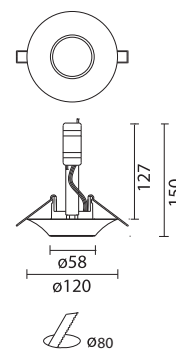

Equipo no incluido, a pedir separadamente, ver pág. 194  
Gear not included, to be ordered separately, see page 194



**MODUL**

**ELECTRO**

[www.modulelectro.ru](http://www.modulelectro.ru)





**MODUL**  
ELECTRO  
[www.modulelectro.ru](http://www.modulelectro.ru)

La realidad es la misma tan sólo porque puede ser diferente.  
Igual que el camaleón, se mimetiza en y desde nuestros ojos.

José Martín Hurtado Gálvez

*Reality is the same only because it can be different.  
Just like the chameleon: it blends into the background -  
in and from our eyes.*

José Martín Hurtado Gálvez



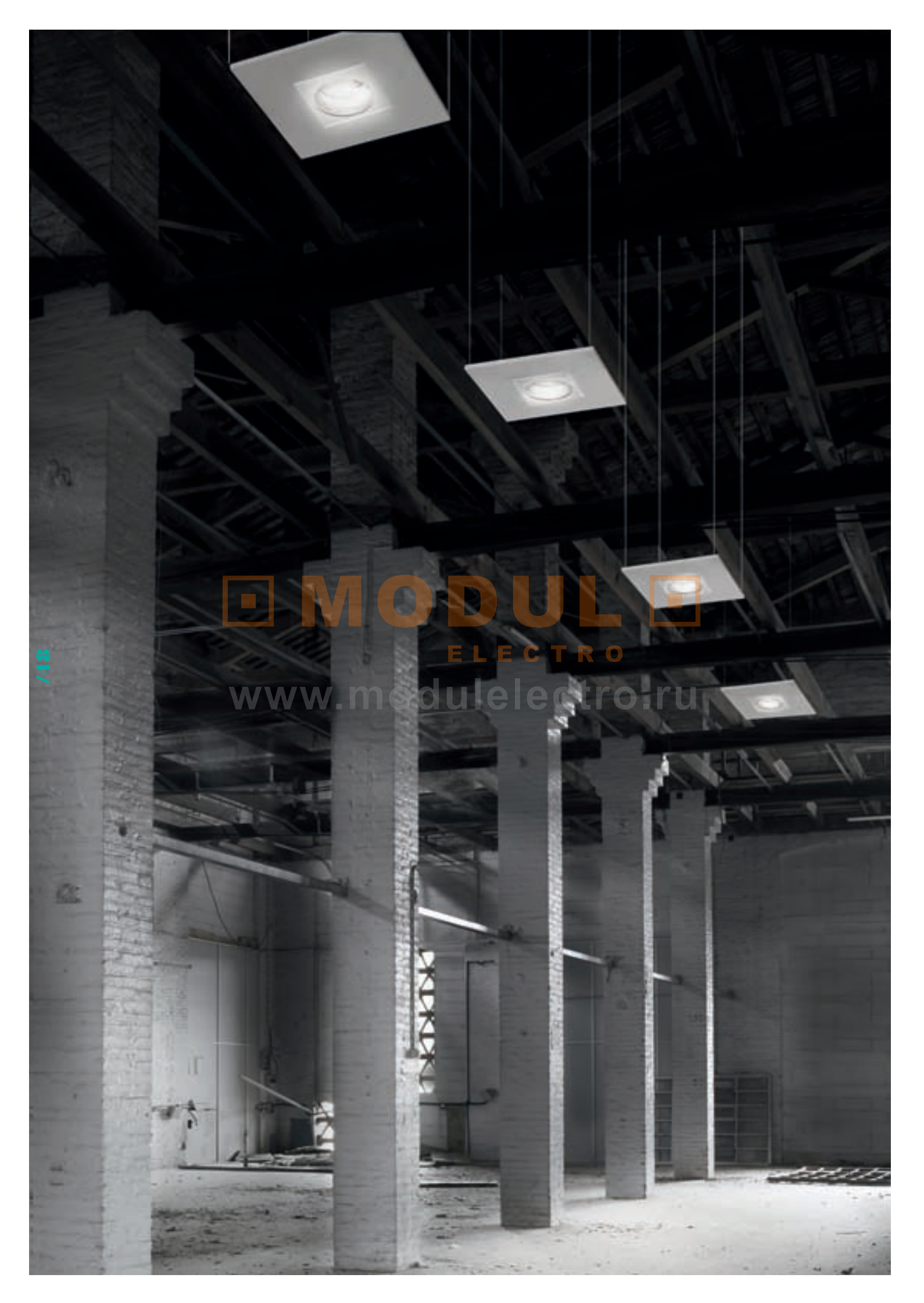

**MODUL**  
ELECTRO  
[www.modulelectro.ru](http://www.modulelectro.ru)

# TRIMIUM

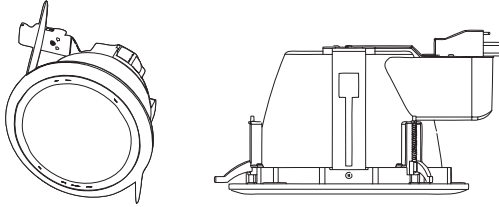

## DESCRIPCIÓN / DESCRIPTION

**Cuerpo en fundición de aluminio.**

**Reflector en aluminio anodizado de muy alta pureza (99,98%) con acabado facetado que proporciona un elevado rendimiento con un efectivo confort. Disponible para lámparas fluorescentes compactas desde 1x26W hasta 2x42W, en versiones magnéticas (230 V) o electrónicas (220-240 V), y para lámparas de descarga de halogenuros metálicos HIT-DE (equipo de funcionamiento a pedir separadamente).**

**Anclajes incorporados en el cuerpo, ajustables con destornillador, que garantizan una perfecta fijación del aparato a cualquier tipo de superficie. Los accesorios opcionales se colocan sin necesidad de herramientas.**

*Aluminium cast housing.*

*High purity (99.98%) anodised aluminium reflector with faceted finish which gives a high efficiency with an effective comfort.*

*Available for compact fluorescent from 1x26W till 2x42W, with magnetic (230 V) or electronic (220-240 V) gear, and for compact discharge lamp HIT-DE (gear to be ordered separately).*

*Brackets included in the housing and adjustable with a screwdriver. These brackets guarantee a perfect fixation of the luminaire to any type of ceiling.*

*No tools needed to place the optional accessories.*

## APLICACIÓN / APPLICATION

**Luminarias para ser utilizadas en cualquier proyecto de iluminación general – tiendas, oficinas, despachos, hoteles - donde el confort visual y la excelente calidad de los productos sean los principales requerimientos.**

*Luminaires to be used in any general lighting project – shops, offices, office cells, hotels – where visual comfort and excellent quality of the products are the main requirements.*



# /TRIMIUM/

Ver fotometrías en página 214 y tabla de equivalencias de lámparas en página 223.

See Photometric data on page 214 and equivalent lamps table on page 223.



Gris / Grey

Blanco / White



Downlights para lámparas fluorescentes compactas.  
Downlight for compact fluorescents lamps.

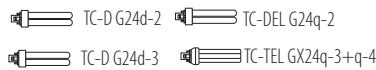

CÓDIGO CODE	COLOR COLOUR	LÁMPARA LAMP	VOLT. VOLT	W W	HAZ BEAM	EQUIPO GEAR	INSTALACIÓN INSTALLATION	VERSIÓN VERSION
DN-0951-14-B9	○	TC-D G24d-2	230	2x18W	-		27	standard
DN-0951-N3-B9	●	TC-D G24d-2	230	2x18W	-	Mag. inc.	27	
DN-0952-14-B9	○	TC-D G24d-3	230	2x26W	-		55	
DN-0952-N3-B9	●	TC-D G24d-3	230	2x26W	-		55	
DN-0950-14-B9	○	TC-TEL GX24q-3+q-4	230	1x26/32/42W	-		56	
DN-0950-N3-B9	●	TC-TEL GX24q-3+q-4	230	1x26/32/42W	-		56	
DN-0953-14-B9	○	TC-DEL G24q-2	230	2x18W	-	Elect. inc.	27	
DN-0953-N3-B9	●	TC-DEL G24q-2	230	2x18W	-		27	
DN-0954-14-B9	○	TC-TEL GX24q-3+q-4	230	2x26/32/42W	-		57	
DN-0954-N3-B9	●	TC-TEL GX24q-3+q-4	230	2x26/32/42W	-		57	
DN-0970-14-B9	○	TC-TEL GX24q-3+q-4	230	1x26/32/42W	-		56	regul./dimm. 1...10V
DN-0970-N3-B9	●	TC-TEL GX24q-3+q-4	230	1x26/32/42W	-		56	
DN-0971-14-B9	○	TC-DEL G24q-2	230	2x18W	-	Elect. inc.	27	
DN-0971-N3-B9	●	TC-DEL G24q-2	230	2x18W	-		27	
DN-0972-14-B9	○	TC-TEL GX24q-3+q-4	230	2x26/32/42W	-		57	
DN-0972-N3-B9	●	TC-TEL GX24q-3+q-4	230	2x26/32/42W	-		57	
DN-0980-14-B9	○	TC-TEL GX24q-3+q-4	230	1x26/32/42W	-		56	DALI/ PUSH PULL
DN-0980-N3-B9	●	TC-TEL GX24q-3+q-4	230	1x26/32/42W	-		56	
DN-0981-14-B9	○	TC-DEL G24q-2	230	2x18W	-	Elect. inc.	27	
DN-0981-N3-B9	●	TC-DEL G24q-2	230	2x18W	-		27	
DN-0982-14-B9	○	TC-TEL GX24q-3+q-4	230	2x26/32/42W	-		57	
DN-0982-N3-B9	●	TC-TEL GX24q-3+q-4	230	2x26/32/42W	-		57	
DN-0990-14-B9	○	TC-DEL G24q-3	230	1x26W	-		56	emergency 1H
DN-0990-N3-B9	●	TC-DEL G24q-3	230	1x26W	-		56	
DN-0991-14-B9	○	TC-DEL G24q-2	230	2x18W	-	Elect. inc.	27	
DN-0991-N3-B9	●	TC-DEL G24q-2	230	2x18W	-		27	
DN-0992-14-B9	○	TC-DEL G24q-3	230	2x26W	-		57	
DN-0992-N3-B9	●	TC-DEL G24q-3	230	2x26W	-		57	

/50

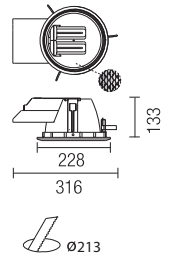



# MODUL

## ELECTRO

www.modulelectro.ru



Downlights para lámparas HIT-DE.  
Downlight for HIT-DE lamps.



CÓDIGO CODE	COLOR COLOUR	LÁMPARA LAMP	VOLT. VOLT	W W	HAZ BEAM	EQUIPO GEAR	INSTALACIÓN INSTALLATION	
DN-0955-14-00	○	HIT-DE RX7s	230	70W	-	Not inc		26
DN-0955-N3-00	●	HIT-DE RX7s	230	70W	-			26
* DN-0956-14-00	○	HIT-DE RX7s	230	150W	-			54
* DN-0956-N3-00	●	HIT-DE RX7s	230	150W	-			54

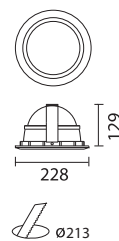

DN-0965-14-00	○	HIT-DE RX7s	230	70W	-	Not inc		26
DN-0965-N3-00	●	HIT-DE RX7s	230	70W	-			26
* DN-0966-14-00	○	HIT-DE RX7s	230	150W	-			54
* DN-0966-N3-00	●	HIT-DE RX7s	230	150W	-			54

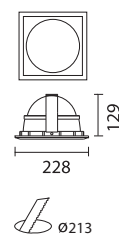

Equipo no incluido, a pedir separadamente, ver pág. 194  
Gear not included, to be ordered separately, see page 194



# /TRIMIUM/

Ver fotometrías en página 214 y tabla de equivalencias de lámparas en página 223.

See Photometric data on page 214 and equivalent lamps table on page 223.

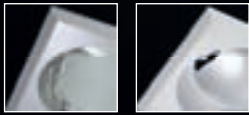

● Gris / Grey

● Blanco / White



Downlights para lámparas fluorescentes compactas.  
Downlight for compact fluorescents lamps.



TC-D G24d-2 TC-DEL G24q-2

TC-D G24d-3 TC-TEL GX24q-3+q-4

CÓDIGO CODE	COLOR COLOUR	LÁMPARA LAMP	VOLT. VOLT	W W	HAZ BEAM	EQUIPO GEAR	INSTALACIÓN INSTALLATION	VERSIÓN VERSION
DN-0961-14-B9	○	TC-D G24d-2	230	2x18W	-		27	standard
DN-0961-N3-B9	●	TC-D G24d-2	230	2x18W	-	Mag. inc	27	
DN-0962-14-B9	○	TC-D G24d-3	230	2x26W	-		55	
DN-0962-N3-B9	●	TC-D G24d-3	230	2x26W	-		55	
DN-0960-14-B9	○	TC-TEL GX24q-3+q-4	230	1x26/32/42W	-		56	
DN-0960-N3-B9	●	TC-TEL GX24q-3+q-4	230	1x26/32/42W	-		56	
DN-0963-14-B9	○	TC-DEL G24q-2	230	2x18W	-	Elect. inc	27	
DN-0963-N3-B9	●	TC-DEL G24q-2	230	2x18W	-		27	
DN-0964-14-B9	○	TC-TEL GX24q-3+q-4	230	2x26/32/42W	-		57	
DN-0964-N3-B9	●	TC-TEL GX24q-3+q-4	230	2x26/32/42W	-		57	
DN-0975-14-B9	○	TC-TEL GX24q-3+q-4	230	1x26/32/42W	-		56	regul./dim. 1...10V
DN-0975-N3-B9	●	TC-TEL GX24q-3+q-4	230	1x26/32/42W	-		56	
DN-0976-14-B9	○	TC-DEL G24q-2	230	2x18W	-	Elect. inc	27	
DN-0976-N3-B9	●	TC-DEL G24q-2	230	2x18W	-		27	
DN-0977-14-B9	○	TC-TEL GX24q-3+q-4	230	2x26/32/42W	-		57	
DN-0977-N3-B9	●	TC-TEL GX24q-3+q-4	230	2x26/32/42W	-		57	
DN-0985-14-B9	○	TC-TEL GX24q-3+q-4	230	1x26/32/42W	-		56	DALI/ PUSH PULL
DN-0985-N3-B9	●	TC-TEL GX24q-3+q-4	230	1x26/32/42W	-		56	
DN-0986-14-B9	○	TC-DEL G24q-2	230	2x18W	-	Elect. inc	27	
DN-0986-N3-B9	●	TC-DEL G24q-2	230	2x18W	-		27	
DN-0987-14-B9	○	TC-TEL GX24q-3+q-4	230	2x26/32/42W	-		57	
DN-0987-N3-B9	●	TC-TEL GX24q-3+q-4	230	2x26/32/42W	-		57	
DN-0995-14-B9	○	TC-DEL G24q-3	230	1x26W	-		56	
DN-0995-N3-B9	●	TC-DEL G24q-3	230	1x26W	-		56	emergency 1H
DN-0996-14-B9	○	TC-DEL G24q-2	230	2x18W	-	Elect. inc	27	
DN-0996-N3-B9	●	TC-DEL G24q-2	230	2x18W	-		27	
DN-0997-14-B9	○	TC-DEL G24q-3	230	2x26W	-		57	
DN-0997-N3-B9	●	TC-DEL G24q-3	230	2x26W	-		57	

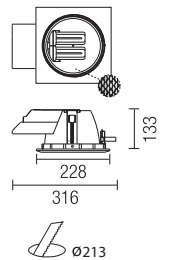

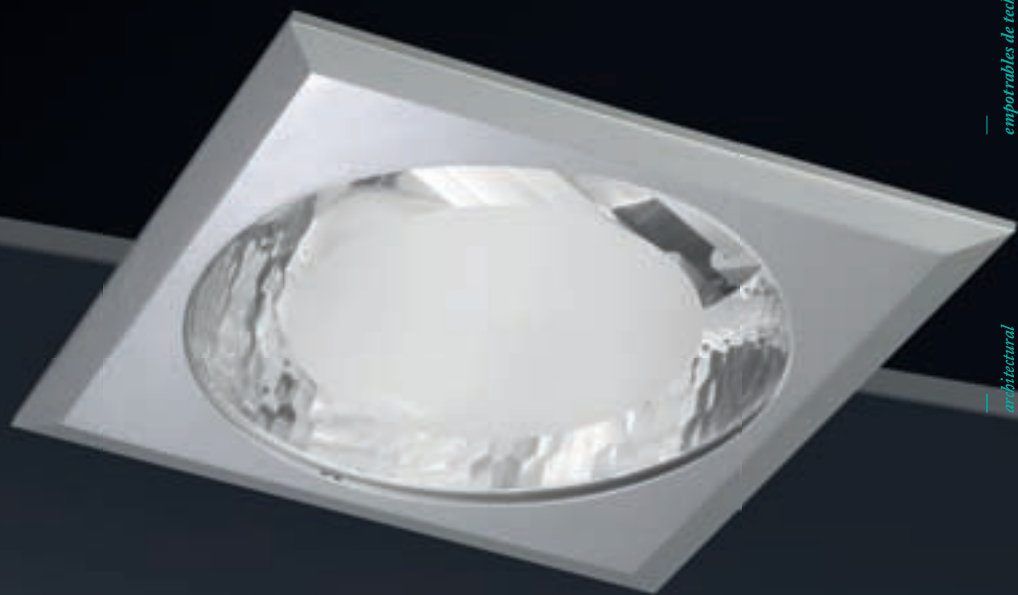

# MODUL

ELECTRO

[www.modulelectro.ru](http://www.modulelectro.ru)



Los anclajes se ajustan con un destornillador, sin necesidad de desmontar el reflector, y garantizan una enorme fiabilidad de la fijación de la luminaria a cualquier tipo de superficie.

*The ceiling brackets are adjusted with a screwdriver and without need to remove the reflector. These brackets offer a very high reliability to the fixation on any type of ceiling surface.*



Cruz baja luminancia.  
Low luminance cross louvre.

CÓDIGO CODE
ACT-0233-00-00

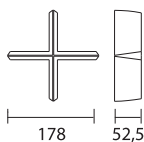

No válida para versiones HIT-DE.  
Not valid for HIT-DE versions.



**MODUL**  
ELECTRO

[www.modulelectro.ru](http://www.modulelectro.ru)



empotrables de techo / ceiling recessed

arquitectural

**MODUL**  
ELECTRO  
[www.modulelectro.ru](http://www.modulelectro.ru)



**MODUL**  
ELECTRO  
[www.modulelectro.ru](http://www.modulelectro.ru)



# TRIMIUM E/

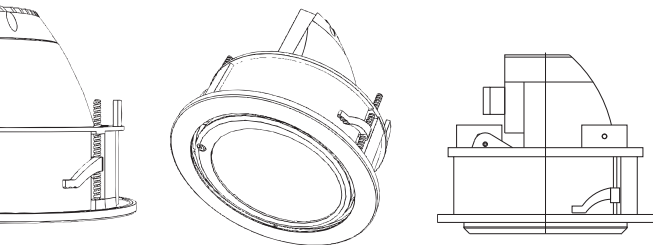

## DESCRIPCIÓN / DESCRIPTION

Cuerpo en policarbonato inyectado y marco exterior en aluminio inyectado. Reflectores en aluminio anodizado de muy alta pureza (99,98%) para diferentes aperturas del haz de luz.

Anclajes incorporados en el cuerpo, ajustables con destornillador, que garantizan una perfecta fijación del aparato a cualquier tipo de superficie.

El sistema de orientación permite 2 tipos de ajuste:

- Extracción y fijación del cuerpo en la posición deseada (hasta 40°) a través de un tornillo.
- Giro de 355° en el eje vertical sin necesidad de herramientas.

*Injected polycarbonate housing frame and die-cast aluminium outer trim.*

*High purity (99.98%) anodised aluminium reflectors for different beam angles.*

*Brackets included in the housing and adjustable with a screwdriver. These brackets guarantee a perfect fixation of the luminaire to any type of ceiling.*

*Adjustable system allows different adjustments:*

- *Pull out and fixation of the optical compartment into the desired angle (until 40°) via a screw.*
- *355° turn without any tool to direct the light where is needed.*

## APLICACIÓN / APPLICATION

Luminarias para ser utilizadas en cualquier proyecto de iluminación que necesite un perfecto direccionamiento del haz de luz para crear efectos de bañador de pared o acentuación de las mercancías expuestas.

*Luminaires to be used in any project needing the right light in the right direction to create wall-washing effects and highlights of the exposed goods.*



# /TRIMIUM E/

Ver fotometrías en página 214 y tabla de equivalencias de lámparas en página 223.

See Photometric data on page 214 and equivalent lamps table on page 223.



●  
Gris / Grey

●  
Blanco / White

/58

## MODULO ELECTRO

www.modulelectro.ru



Downlights orientables extraíbles para lámparas HIT-T.  
Adjustable downlight for HIT-T lamps.



Para HIT-T < 70W



HIT-T G12

CÓDIGO CODE	COLOR COLOUR	LÁMPARA LAMP	VOLT. VOLT	W W	HAZ BEAM	EQUIPO GEAR	INSTALACIÓN INSTALLATION	
* DN-0236-14-37	○	HIT-T G12	230	max.150W	12°	Not inc		28
* DN-0236-N3-37	●	HIT-T G12	230	max.150W	12°			28
* DN-0238-14-37	○	HIT-T G12	230	max.150W	40°			29
* DN-0238-N3-37	●	HIT-T G12	230	max.150W	40°			29



191



160



Ø173

Equipo no incluido, a pedir separadamente, ver pág. 194  
Gear not included, to be ordered separately, see page 194



Los anclajes se ajustan con un destornillador, sin necesidad de desmontar el reflector, y garantizan una enorme fiabilidad de la fijación de la luminaria a cualquier tipo de superficie.

The ceiling brackets are adjusted with a screwdriver and without need to remove the reflector. These brackets offer a very high reliability to the fixation on any type of ceiling surface

empotrables de techo / ceiling recessed

arquitectural

**MODUL**  
ELECTRO  
[www.modulelectro.ru](http://www.modulelectro.ru)

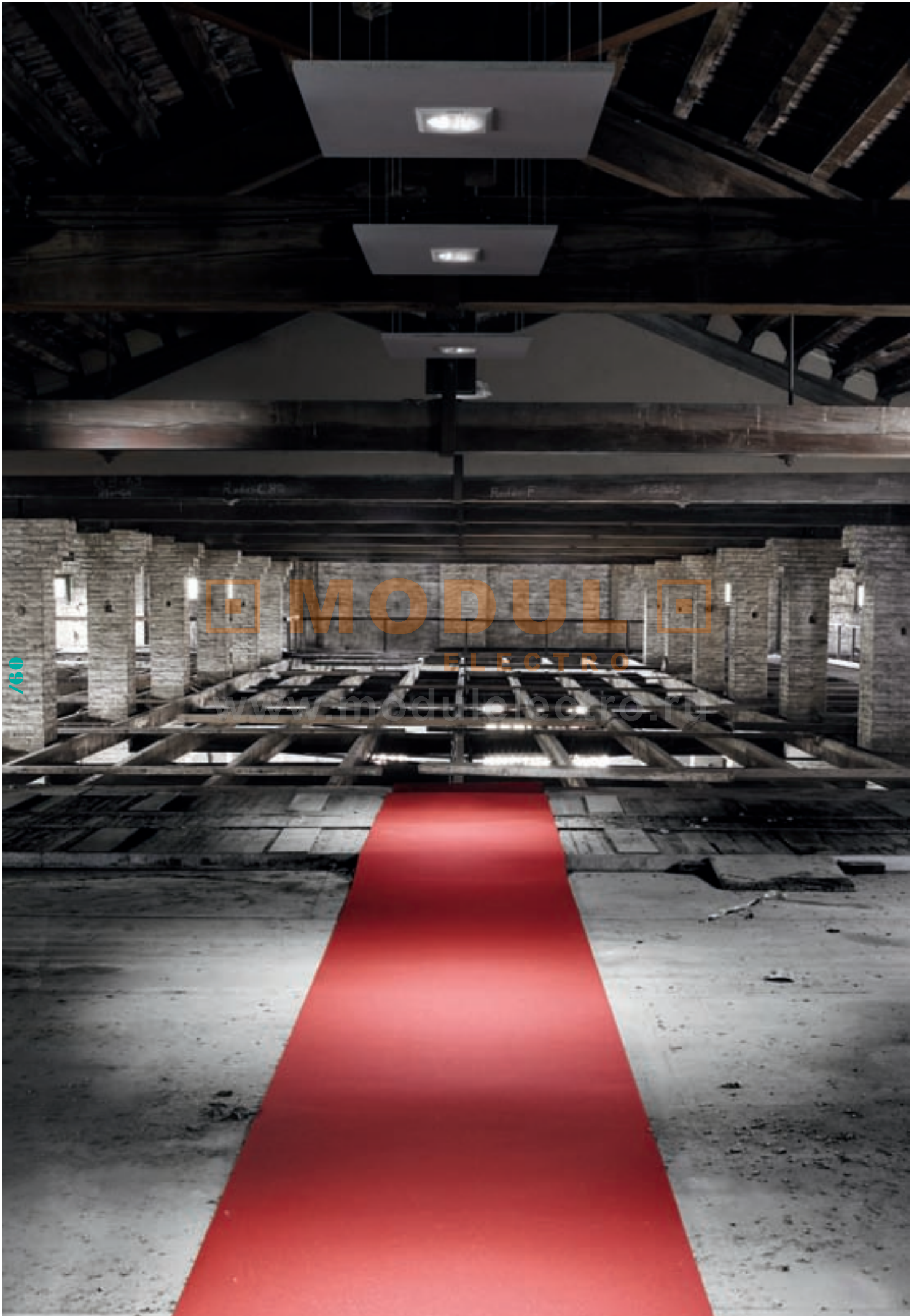

# TRIMIUM S130/

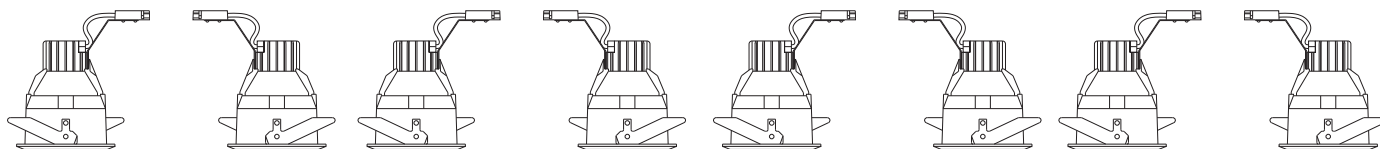

## DESCRIPCIÓN / DESCRIPTION

Cuerpo totalmente fabricado en fundición de aluminio.  
Reflector en aluminio anodizado de muy alta pureza (99,98%) con acabado mate.  
Disponible para lámparas de descarga (HIT-TC), halógenas (MASTERline-TC) o TC-TEL. Todas las versiones se suministran con cristal de protección IP54.  
Anclajes incorporados en el cuerpo y ajustables sin necesidad de herramientas para una total facilidad de instalación.

*Aluminium cast housing.  
High purity anodised aluminium reflector with matt finishing.  
Available for compact discharge lamp HIT-TC, halogen MASTERline-TC or TC-TEL. Any of these is supplied with protection glass IP54.  
Brackets included in the housing and adjustable without the need of any tool for a total ease of installation.*

## APLICACIÓN / APPLICATION

Luminarias para ser utilizadas en cualquier proyecto de iluminación ambiental – tiendas, oficinas, despachos, hoteles - donde el confort visual y la excelente calidad de los productos sean los principales requerimientos.

*Luminaires to be used in any environmental lighting project – shops, offices, office cells, hotels – where visual comfort and excellent quality of the products are the main requirements.*



# /TRIMIUM S130/

Ver fotometrías en página 214 y tabla de equivalencias de lámparas en página 223.

See Photometric data on page 214 and equivalent lamps table on page 223.



Gris / Grey



Negro / Black



Blanco / White



Aluminio cepillado /  
Polished aluminium

## MODUL

### ELECTRO

www.modulelectro.ru



Downlight para lámpara HIT-TC, QT-TC o TC-TEL.  
Fixed downlight for HIT-TC, QT-TC or TC-TEL lamps.

DN-1000-XX-XX				
DN-1001-XX-XX				
DN-1002-XX-XX				



CÓDIGO CODE	COLOR COLOUR	LÁMPARA LAMP	VOLT. VOLT	W W	HAZ BEAM	EQUIPO GEAR	INSTALACIÓN INSTALLATION	
DN-1000-14-B9	○	TC-TEL GX24q-3	230	1x26W	95°	Elect. inc.		117
DN-1000-N3-B9	●	TC-TEL GX24q-3	230	1x26W	95°			117
DN-1000-60-B9	●	TC-TEL GX24q-3	230	1x26W	95°			117
DN-1000-S2-B9	◐	TC-TEL GX24q-3	230	1x26W	95°			117
DN-1001-14-B9	○	HIT-TC G8.5	230	max.70W	60°	Not inc. (1)		30
DN-1001-N3-B9	●	HIT-TC G8.5	230	max.70W	60°			30
DN-1001-60-B9	●	HIT-TC G8.5	230	max.70W	60°			30
DN-1001-S2-B9	◐	HIT-TC G8.5	230	max.70W	60°			30
DN-1002-14-B9	○	QT-TC G8.5	12	max.60W	60°	Not inc. (1)		31
DN-1002-N3-B9	●	QT-TC G8.5	12	max.60W	60°			31
DN-1002-60-B9	●	QT-TC G8.5	12	max.60W	60°			31
DN-1002-S2-B9	◐	QT-TC G8.5	12	max.60W	60°			31

DN-1000

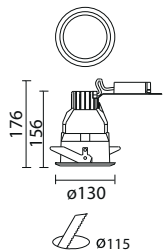

DN-1001 / DN-1002

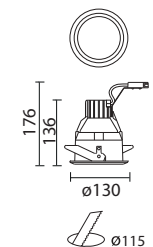

(\*) Consultar  
(\*) Consult

(1) Equipo no incluido, a pedir separadamente, ver pág. 194  
(1) Gear not included, to be ordered separately, see page 194

# MODUL



## ELECTRO

www.modulelectro.ru

Downlight para lámpara HIT-TC, QT-TC o TC-TEL.  
Fixed downlight for HIT-TC, QT-TC or TC-TEL lamps.

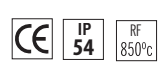

- DN-1006-XX-XX TC-TEL GX24q-3
- DN-1007-XX-XX HIT-TC G8.5
- DN-1008-XX-XX QT-TC G8.5



CÓDIGO CODE	COLOR COLOUR	LÁMPARA LAMP	VOLT. VOLT	W W	HAZ BEAM	EQUIPO GEAR	INSTALACIÓN INSTALLATION	
DN-1006-14-B9	○	TC-TEL GX24q-3	230	1x26W	95°	Elect. inc		117
DN-1006-N3-B9	●	TC-TEL GX24q-3	230	1x26W	95°			117
DN-1006-60-B9	●	TC-TEL GX24q-3	230	1x26W	95°			117
DN-1006-S2-B9	◐	TC-TEL GX24q-3	230	1x26W	95°			117
DN-1007-14-B9	○	HIT-TC G8.5	230	max.70W	60°	Not inc (1)		30
DN-1007-N3-B9	●	HIT-TC G8.5	230	max.70W	60°			30
DN-1007-60-B9	●	HIT-TC G8.5	230	max.70W	60°			30
DN-1007-S2-B9	◐	HIT-TC G8.5	230	max.70W	60°			30
DN-1008-14-B9	○	QT-TC G8.5	12	max.60W	60°	Not inc (1)		31
DN-1008-N3-B9	●	QT-TC G8.5	12	max.60W	60°			31
DN-1008-60-B9	●	QT-TC G8.5	12	max.60W	60°			31
DN-1008-S2-B9	◐	QT-TC G8.5	12	max.60W	60°			31

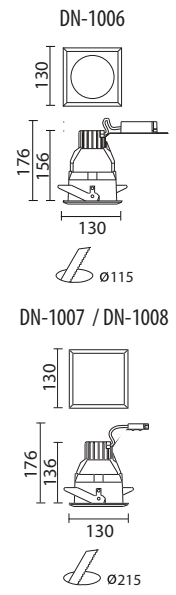

(\*) Consultar  
(\*) Consult

(1) Equipo no incluido, a pedir separadamente, ver pág. 194  
(1) Gear not included, to be ordered separately, see page 194



**MODUL**  
ELECTRO  
[www.modulelectro.ru](http://www.modulelectro.ru)



# TRIMIUM S100/

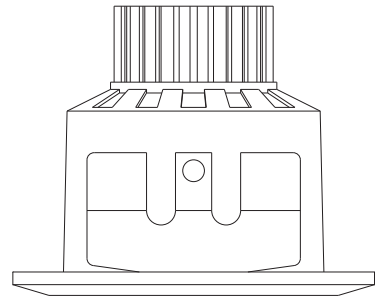

empotrables de techo / ceiling recessed

arquitectural

## DESCRIPCIÓN / DESCRIPTION

Cuerpo totalmente fabricado en fundición de aluminio.  
Reflector en aluminio anodizado de muy alta pureza (99,98%) con acabado brillo para las versiones con lámpara QT-12 y CDM-Tm. Se suministran con cristal de protección (IP54).  
Anclajes incorporados en el cuerpo y ajustables sin necesidad de herramientas para una total facilidad de instalación.

*Aluminium cast housing.*

*High purity anodised aluminium reflector with high-gloss finishing in the QT-12 and CDM-Tm versions.*

*All versions are supplied with IP54 protection glass.*

*Brackets included in the housing and adjustable without the need of any tool for a total ease of installation.*

## APLICACIÓN / APPLICATION

Luminarias para ser utilizadas en cualquier proyecto de iluminación ambiental y/o acentuación – tiendas, oficinas, despachos, hoteles - donde la excelente calidad de los productos sean los principales requerimientos.

*Luminaires to be used in any environmental and/or accent lighting project – shops, offices, office cells, hotels – where the excellent quality of the products is the main requirement.*



# /TRIMIUM S100/

Ver fotometrías en página 214 y tabla de equivalencias de lámparas en página 223.

See Photometric data on page 214 and equivalent lamps table on page 223.



Gris / Grey



Negro / Black



Blanco / White



Aluminio cepillado /  
Polished aluminium

Cruz baja luminancia  
Low luminance cross louvre.

CÓDIGO CODE
ACT-0294-00-00

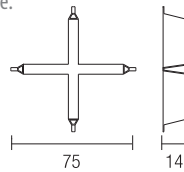

No válida para versiones CDM-Tm  
Not valid for CDM-Tm versions.



## MODULO ELECTRO

Downlight para lámpara CDM-Tm, QT-12 o QR-CB51.  
Fixed downlight for CDM-Tm, QT-12 or QR-CB51 lamps.



DN-1003-XX-XX  
DN-1004-XX-XX



(\*) Para QR-CB51 <math>\leq 35W</math>



QR-CB51 GU5.3



QT-12 GY6.35

DN-1005-XX-XX



CDM-Tm PGJ5 (1)

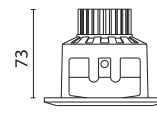

Ø85

CÓDIGO CODE	COLOR COLOUR	LÁMPARA LAMP	VOLT. VOLT	W W	HAZ BEAM	EQUIPO GEAR	INSTALACIÓN INSTALLATION	
DN-1003-14-B9	○	QR-CB51 GU5.3	12	max 50W	-	Not inc (2)		01-08
DN-1003-N3-B9	●	QR-CB51 GU5.3	12	max 50W	-			01-08
DN-1003-60-B9	●	QR-CB51 GU5.3	12	max 50W	-			01-08
DN-1003-52-B9	◐	QR-CB51 GU5.3	12	max 50W	-			01-08
DN-1004-14-B9	○	QT-12 GY6.35	12	max 100W	55°	Elect. inc		32
DN-1004-N3-B9	●	QT-12 GY6.35	12	max 100W	55°			32
DN-1004-60-B9	●	QT-12 GY6.35	12	max 100W	55°			32
DN-1004-52-B9	◐	QT-12 GY6.35	12	max 100W	55°			32
DN-1005-14-B9	○	CDM-Tm PGJ5 (1)	230	20W	55°	Elect. inc	33	
DN-1005-N3-B9	●	CDM-Tm PGJ5 (1)	230	20W	55°		33	
DN-1005-60-B9	●	CDM-Tm PGJ5 (1)	230	20W	55°		33	
DN-1005-52-B9	◐	CDM-Tm PGJ5 (1)	230	20W	55°		33	

(1) Lámpara suministrada con el aparato  
(1) Lamp included with the luminaire

(2) Equipo no incluido, a pedir separadamente, ver pág. 194  
(2) Gear not included, to be ordered separately, see page 194





# MODULO ELECTRO

Downlight para lámpara CDM-Tm, QT-12 o QR-CB51.  
Fixed downlight for CDM-Tm, QT-12 or QR-CB51 lamps.

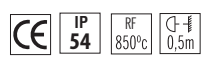

DN-1009-XX-XX  
DN-1010-XX-XX



(\*) Para QR-CB51 ≤ 35W

DN-1011-XX-XX



QR-CB51 GU5.3

QT-12 GY6.35

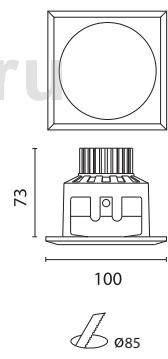

CDM-Tm PGJ5 (1)



CÓDIGO CODE	COLOR COLOUR	LÁMPARA LAMP	VOLT. VOLT	W W	HAZ BEAM	EQUIPO GEAR	INSTALACIÓN INSTALLATION	
DN-1009-14-B9	○	QR-CB51 GU5.3	12	max 50W	-			05-08
DN-1009-N3-B9	●	QR-CB51 GU5.3	12	max 50W	-			05-08
DN-1009-60-B9	●	QR-CB51 GU5.3	12	max 50W	-			05-08
DN-1009-S2-B9	◐	QR-CB51 GU5.3	12	max 50W	-			05-08
DN-1010-14-B9	○	QT-12 GY6.35	12	max 100W	55°	Not inc (2)		32
DN-1010-N3-B9	●	QT-12 GY6.35	12	max 100W	55°			32
DN-1010-60-B9	●	QT-12 GY6.35	12	max 100W	55°			32
DN-1010-S2-B9	◐	QT-12 GY6.35	12	max 100W	55°			32
DN-1011-14-B9	○	CDM-Tm PGJ5 (1)	230	20W	55°	Elect. inc		33
DN-1011-N3-B9	●	CDM-Tm PGJ5 (1)	230	20W	55°			33
DN-1011-60-B9	●	CDM-Tm PGJ5 (1)	230	20W	55°			33
DN-1011-S2-B9	◐	CDM-Tm PGJ5 (1)	230	20W	55°			33

(1) Lámpara suministrada con el aparato  
(1) Lamp included with the luminaire

(2) Equipo no incluido, a pedir separadamente, ver pág. 194  
(2) Gear not included, to be ordered separately, see page 194

 **MODUL**   
ELECTRO  
[www.modulelectro.ru](http://www.modulelectro.ru)



# TRIMIUM MINI

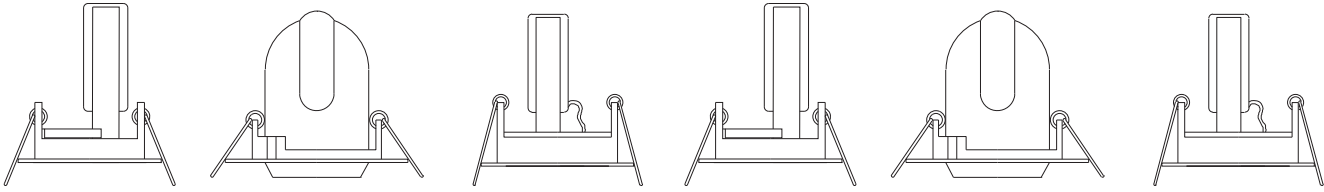

## DESCRIPCIÓN / DESCRIPTION

Pequeños downlights para lámpara QR-CB51.  
Cuerpo totalmente fabricado en fundición de aluminio. Pintura con elevada resistencia a la corrosión y a la oxidación.  
Anclajes incorporados en el cuerpo y ajustables sin necesidad de herramientas para una total facilidad de instalación.

*Small downlights for QR-CB51 lamp.  
Totally manufactured with die-cast aluminium. Painting with high resistance to corrosion and oxidation.  
Brackets included in the housing and adjustable without the need of any tool for a total ease of installation.*

## APLICACIÓN / APPLICATION

Diferentes configuraciones – fijos, orientables, extraíbles, basculantes - y colores permiten su perfecta integración tanto en ambientes domésticos como en proyectos con exigentes requerimientos lumínicos.

*Different configurations – fixed, adjustable, pull-out – and colours allow the perfect integration in domestic environments as well as in projects with high quality requirements.*



# TRIMIUM MINI

Ver fotometrías en página 214 y tabla de equivalencias de lámparas en página 223.

See Photometric data on page 214 and equivalent lamps table on page 223.



Gris / Grey



Negro / Black



Blanco / White



Aluminio cepillado /  
Polished aluminium



Downlight para lámpara QR-CB51.  
Fixed downlight for QR-CB51 lamps.

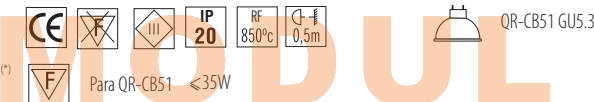

Para QR-CB51 <35W

CÓDIGO CODE	COLOR COLOUR	LÁMPARA LAMP	VOLT. VOLT	W W	HAZ BEAM	EQUIPO GEAR	INSTALACIÓN INSTALLATION
* DN-0522-14-00	○	QR-CB51 GU5.3	12	max.50W	-	Not inc	01-08
* DN-0522-S2-00	◐	QR-CB51 GU5.3	12	max.50W	-		01-08
* DN-0522-N3-00	◑	QR-CB51 GU5.3	12	max.50W	-		01-08
* DN-0522-60-00	●	QR-CB51 GU5.3	12	max.50W	-		01-08

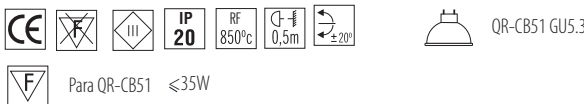
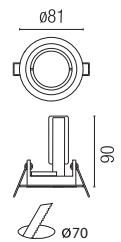

Para QR-CB51 <35W

CÓDIGO CODE	COLOR COLOUR	LÁMPARA LAMP	VOLT. VOLT	W W	HAZ BEAM	EQUIPO GEAR	INSTALACIÓN INSTALLATION
* DN-0521-14-00	○	QR-CB51 GU5.3	12	max.50W	-	Not inc	01-08
* DN-0521-S2-00	◐	QR-CB51 GU5.3	12	max.50W	-		01-08
* DN-0521-N3-00	◑	QR-CB51 GU5.3	12	max.50W	-		01-08
* DN-0521-60-00	●	QR-CB51 GU5.3	12	max.50W	-		01-08

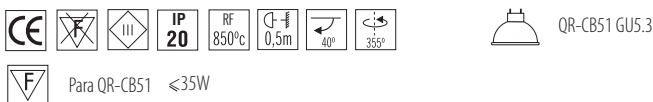
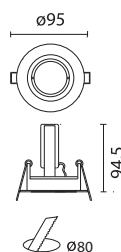

Para QR-CB51 <35W

CÓDIGO CODE	COLOR COLOUR	LÁMPARA LAMP	VOLT. VOLT	W W	HAZ BEAM	EQUIPO GEAR	INSTALACIÓN INSTALLATION
* DN-0520-14-00	○	QR-CB51 GU5.3	12	max.50W	-	Not inc	01-08
* DN-0520-S2-00	◐	QR-CB51 GU5.3	12	max.50W	-		01-08
* DN-0520-N3-00	◑	QR-CB51 GU5.3	12	max.50W	-		01-08
* DN-0520-60-00	●	QR-CB51 GU5.3	12	max.50W	-		01-08

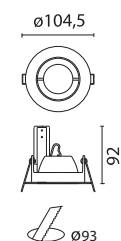

Equipo no incluido, a pedir separadamente, ver pág. 194  
Gear not included, to be ordered separately, see page 194



# MODUL



ELECTRO

www.modulelectro.ru

Downlight para lámpara QR-CB51.  
Fixed downlight for QR-CB51 lamps.

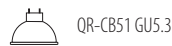

Para QR-CB51 <35W

CÓDIGO CODE	COLOR COLOUR	LÁMPARA LAMP	VOLT. VOLT	W W	HAZ BEAM	EQUIPO GEAR	INSTALACIÓN INSTALLATION	
* DN-0524-14-00	○	QR-CB51 GU5.3	12	max.50W	-	Not inc		01-08
* DN-0524-S2-00	◐	QR-CB51 GU5.3	12	max.50W	-			01-08
* DN-0524-N3-00	◑	QR-CB51 GU5.3	12	max.50W	-			01-08
* DN-0524-60-00	●	QR-CB51 GU5.3	12	max.50W	-			01-08

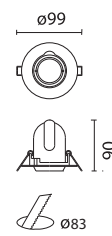

Para QR-CB51 <35W

CÓDIGO CODE	COLOR COLOUR	LÁMPARA LAMP	VOLT. VOLT	W W	HAZ BEAM	EQUIPO GEAR	INSTALACIÓN INSTALLATION	
* DN-0610-14-00	○	QR-CB51 GU5.3	12	max.50W	-	Not inc		01-08
* DN-0610-S2-00	◐	QR-CB51 GU5.3	12	max.50W	-			01-08
* DN-0610-N3-00	◑	QR-CB51 GU5.3	12	max.50W	-			01-08
* DN-0610-60-00	●	QR-CB51 GU5.3	12	max.50W	-			01-08

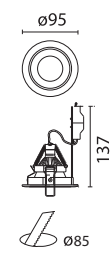

Equipo no incluido, a pedir separadamente, ver pág. 194  
Gear not included, to be ordered separately, see page 194





**MODUL**  
ELECTRO  
[www.modulelectro.ru](http://www.modulelectro.ru)

# /ECO/

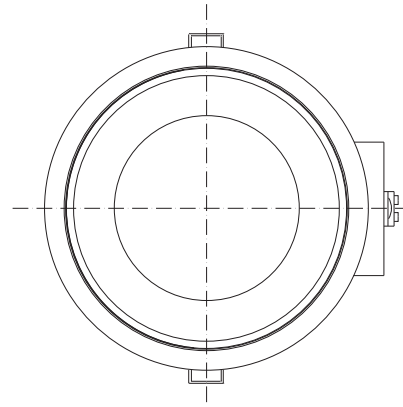
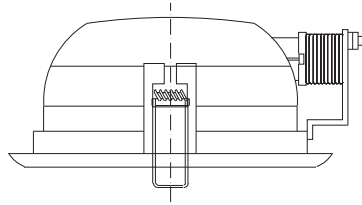

**Gama de downlights económicos para la iluminación general. La perfecta conjugación entre las necesidades de iluminación y precio sin renunciar al uso de componentes de gama alta.**

*Range of fluorescent downlights for general lighting.  
The perfect match between lighting needs and price without renouncing high-end components.*

## DESCRIPCIÓN / DESCRIPTION

**Cuerpo en chapa de acero protegida contra la corrosión.  
Reflector facetado en aluminio anodizado de muy alta pureza.  
Disponibles en versiones de 1 y 2 lámparas fluorescentes compactas en potencias de 18W y 26W. Tanto en versiones magnéticas como electrónicas.  
También versiones con equipos de emergencia.  
Todas las versiones incorporan cristal antideslumbrante.  
Anclajes incorporados en el cuerpo y fácilmente ajustables (sin herramientas).  
Acabados en blanco y gris metalizado.**

*Body in steel protected against corrosion.  
High purity anodised aluminium reflector.  
Available for 1 or 2 compact fluorescent lamps 18W or 26W. Both with electronic or magnetic ballast.  
Versions with emergency kit also available.  
Tempered matt glass included for all versions.  
Fixing brackets included in the housing and easily adjustable (without tools).  
Available in white or grey finish.*

## APLICACIÓN / APPLICATION

**Luminarias fijas para ser utilizadas en cualquier proyecto de iluminación general: tiendas, oficinas, despachos, hoteles.**

*Fluorescent range of luminaires for any kind of general lighting project such as retail shops, offices or hotels.*





Gris / Grey



Blanco / White



Downlight para lámparas fluorescentes compactas.  
Fixed downlight for compact fluorescent lamps.



CÓDIGO CODE	COLOR COLOUR	LÁMPARA LAMP	VOLT. VOLT	W W	HAZ BEAM	EQUIPO GEAR	INSTALACIÓN INSTALLATION	VERSIÓN VERSION
DN-1400-14-00	○	TC-D G24d-2	230	18W	-	Mag. inc		118
DN-1400-N3-00	●	TC-D G24d-2	230	18W	-			118
DN-1401-14-00	○	TC-D G24d-2	230	2x18W	-			119
DN-1401-N3-00	●	TC-D G24d-2	230	2x18W	-			119
DN-1402-14-00	○	TC-D G24d-3	230	26W	-			120
DN-1402-N3-00	●	TC-D G24d-3	230	26W	-			120
DN-1403-14-00	○	TC-D G24d-3	230	2x26W	-			121
DN-1403-N3-00	●	TC-D G24d-3	230	2x26W	-			121
DN-1405-14-00	○	TC-DEL G24q-2	230	18W	-	Elect. inc	standard	118
DN-1405-N3-00	●	TC-DEL G24q-2	230	18W	-			118
DN-1406-14-00	○	TC-DEL G24q-2	230	2x18W	-			122
DN-1406-N3-00	●	TC-DEL G24q-2	230	2x18W	-			122
DN-1407-14-00	○	TC-DEL G24q-3	230	26W	-			123
DN-1407-N3-00	●	TC-DEL G24q-3	230	26W	-			123
DN-1408-14-00	○	TC-DEL G24q-3	230	2x26W	-			124
DN-1408-N3-00	●	TC-DEL G24q-3	230	2x26W	-			124
DN-1409-14-00	○	TC-DEL G24q-2	230	2x18W	-	Elect. inc	emergency 1H	122
DN-1409-N3-00	●	TC-DEL G24q-2	230	2x18W	-			122
DN-1410-14-00	○	TC-DEL G24q-3	230	2x26W	-			124
DN-1410-N3-00	●	TC-DEL G24q-3	230	2x26W	-			124

(\*) Consultar

(\*) Consult

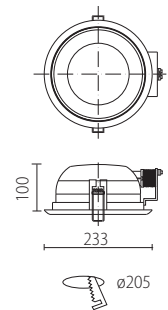



**MODUL**  
ELECTRO

[www.modulelectro.ru](http://www.modulelectro.ru)

empotrables de techo / ceiling recessed

arquitectural

175

 **MODUL**   
ELECTRO  
[www.modulselectro.ru](http://www.modulselectro.ru)

# /CUADRO/

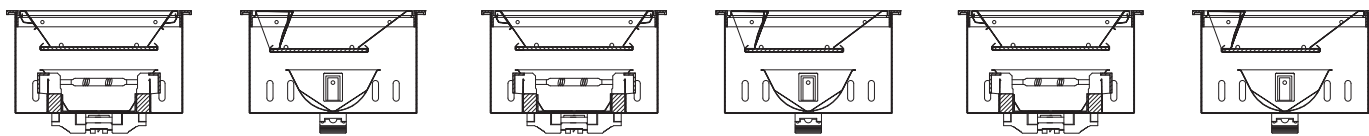

empotrables de techo / ceiling recessed

arquitectural

## DESCRIPCIÓN / DESCRIPTION

Cuerpo en policarbonato resistente a altas temperaturas y tratado contra la acción de los rayos UV. La versión cuadrada de 200x200 está fabricada con chapa de acero lacada en blanco.

Reflector en aluminio anodizado mate de muy alta pureza (99,98%).

Disponible para lámparas fluorescentes compactas, también en versiones regulables 1-10 V, DALI/PUSH- PULL o con equipos de emergencia.

También con lámparas de descarga para la versión WALL-WASHER.

Anclajes incorporados en el cuerpo, fácilmente ajustables sin herramientas.

*Polycarbonate housing resistant to very high temperatures and treated against UV. The 200x200 mm version is manufactured with white lacquered steel.*

*Anodised aluminium reflector with matt finish.*

*Available for compact fluorescent lamps (electronic gear included), dimmable 1-10V, DALI / PUSH- PULL or with emergency kit.*

*Also available with metal halide lamps for the WALL-WASHER version.*

*Brackets included in the housing and adjustable without any tool.*

## APLICACIÓN / APPLICATION

Luminarias para ser utilizadas en cualquier proyecto de iluminación general – tiendas, oficinas, despachos, hoteles - donde el confort visual, la estética y la funcionalidad de los productos sean los principales requerimientos.

*Luminaires to be used in any general lighting project – shops, offices, office cells, hotels – where aesthetics and functionality of the products are the main requirements.*

## ACCESORIOS / ACCESSORIES

Los marcos embellecedores están fabricados en fundición de aluminio y acabados con pintura epoxi de color blanco o gris/plata. Todas las versiones incorporan cristal de protección de vidrio templado mate o transparente.

*Aluminium cast decorative trim with white or grey/silver epoxy painting finish. All versions include a tempered protection glass, matt or transparent.*

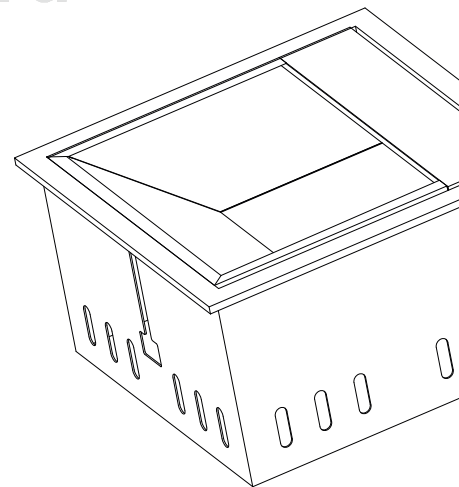

121



# /CUADRO/

Ver fotometrías en página 214 y tabla de equivalencias de lámparas en página 223.

See Photometric data on page 214 and equivalent lamps table on page 223.



Blanco / White

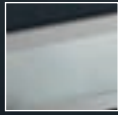

Gris / Grey

**H6:** Cristal claro con serigrafía.  
H6: Clear glass with serigraphy.  
**B9:** Cristal mate.  
B9: Matt glass.



La cabeza portalámparas basculante ofrece una gran facilidad para la instalación y la reposición de las lámparas.

The tilting lampholder box assures easy installation and lamp replacement operation.

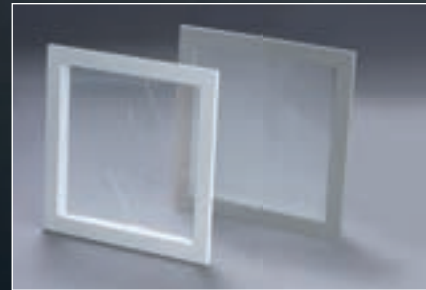

Marcos embellecedores en dos versiones y dos colores diferentes para DN-0250, DN-0252, DN-0373.

Decorative trims available in two different versions and two colours for DN-0250, DN-0252, DN-0373.



www.modulelectro.ru

Downlight rectangular para lámpara TC-DEL.  
Rectangular downlight for TC-DEL lamp.

**H6:** Cristal claro con serigrafía.  
H6: Clear glass with serigraphy.  
**B9:** Cristal mate.  
B9: Matt glass.



TC-DEL G24q-2

CÓDIGO CODE	COLOR COLOUR	LÁMPARA LAMP	VOLT. VOLT	W	HAZ BEAM	EQUIPO GEAR	INSTALACIÓN INSTALLATION	VERSIÓN VERSION
DN-0250-14-B9	○	TC-DEL G24q-2	230	18W	-	Elect. inc		35
DN-0250-N3-B9	●	TC-DEL G24q-2	230	18W	-			35
DN-0250-14-H6	○	TC-DEL G24q-2	230	18W	-			36
DN-0250-N3-H6	●	TC-DEL G24q-2	230	18W	-			36
DN-1500-14-B9	○	TC-DEL G24q-2	230	18W	-	Elect. inc		35
DN-1500-N3-B9	●	TC-DEL G24q-2	230	18W	-			35
DN-1500-14-H6	○	TC-DEL G24q-2	230	18W	-			36
DN-1500-N3-H6	●	TC-DEL G24q-2	230	18W	-			36
DN-1510-14-B9	○	TC-DEL G24q-2	230	18W	-	Elect. inc		35
DN-1510-N3-B9	●	TC-DEL G24q-2	230	18W	-			35
DN-1510-14-H6	○	TC-DEL G24q-2	230	18W	-			36
DN-1510-N3-H6	●	TC-DEL G24q-2	230	18W	-			36
DN-1520-14-H6	○	TC-DEL G24q-2	230	18W	-	Elect. inc		36
DN-1520-N3-H6	●	TC-DEL G24q-2	230	18W	-			36

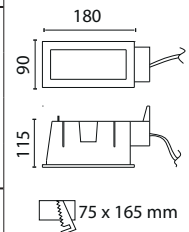



# MODUL

## ELECTRO

[www.modulelectro.ru](http://www.modulelectro.ru)



Downlight cuadrado para lámpara TC-DEL.  
Square downlight for TC-DEL lamp.



Código CODE	COLOR COLOUR	LAMPARA LAMP	VOLT. VOLT	W W	HAZ BEAM	EQUIPO GEAR	INSTALACIÓN INSTALLATION	VERSIÓN VERSION
DN-0252-14-B9	○	TC-DEL G24q-3	230	2x26W	-	Elect. inc		37
DN-0252-N3-B9	●	TC-DEL G24q-3	230	2x26W	-			37
DN-0252-14-H6	○	TC-DEL G24q-3	230	2x26W	-			38
DN-0252-N3-H6	●	TC-DEL G24q-3	230	2x26W	-			38
DN-1501-14-B9	○	TC-DEL G24q-3	230	2x26W	-	Elect. inc		37
DN-1501-N3-B9	●	TC-DEL G24q-3	230	2x26W	-			37
DN-1501-14-H6	○	TC-DEL G24q-3	230	2x26W	-			38
DN-1501-N3-H6	●	TC-DEL G24q-3	230	2x26W	-			38
DN-1511-14-B9	○	TC-DEL G24q-3	230	2x26W	-	Elect. inc		37
DN-1511-N3-B9	●	TC-DEL G24q-3	230	2x26W	-			37
DN-1511-14-H6	○	TC-DEL G24q-3	230	2x26W	-			38
DN-1511-N3-H6	●	TC-DEL G24q-3	230	2x26W	-			38
DN-1521-14-H6	○	TC-DEL G24q-3	230	2x26W	-	Elect. inc		38
DN-1521-N3-H6	●	TC-DEL G24q-3	230	2x26W	-			38

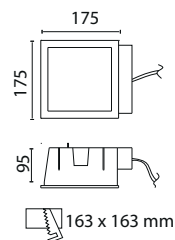



# /CUADRO/

Ver fotometrías en página 214 y tabla de equivalencias de lámparas en página 223.

See Photometric data on page 214 and equivalent lamps table on page 223.

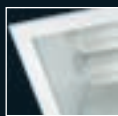

Blanco / White

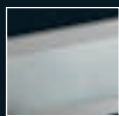

Gris / Grey

**H6:** Cristal claro con serigrafía.  
**H6:** Clear glass with serigraphy.  
**B9:** Cristal mate.  
**B9:** Matt glass.



Downlight rectangular para lámpara TC-TEL.  
 Rectangular downlight for TC-TEL lamp .

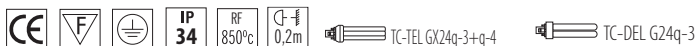

CÓDIGO CODE	COLOR COLOUR	LÁMPARA LAMP	VOLT. VOLT	W W	HAZ BEAM	EQUIPO GEAR	INSTALACIÓN INSTALLATION	59	60	60	60	59	59	60	60	60	60	60	60
DN-0373-14-B9	○	TC-TEL GX24q-3+q-4	230	2x26/32/42W	-														
DN-0373-N3-B9	●	TC-TEL GX24q-3+q-4	230	2x26/32/42W	-														
DN-0373-14-H6	○	TC-TEL GX24q-3+q-4	230	2x26/32/42W	-	Elect. inc													
DN-0373-N3-H6	●	TC-TEL GX24q-3+q-4	230	2x26/32/42W	-														
DN-1502-14-B9	○	TC-TEL GX24q-3+q-4	230	2x26/32/42W	-														
DN-1502-N3-B9	●	TC-TEL GX24q-3+q-4	230	2x26/32/42W	-	Elect. inc													
DN-1502-14-H6	○	TC-TEL GX24q-3+q-4	230	2x26/32/42W	-														
DN-1502-N3-H6	●	TC-TEL GX24q-3+q-4	230	2x26/32/42W	-														
DN-1512-14-B9	○	TC-TEL GX24q-3+q-4	230	2x26/32/42W	-														
DN-1512-N3-B9	●	TC-TEL GX24q-3+q-4	230	2x26/32/42W	-	Elect. inc													
DN-1512-14-H6	○	TC-TEL GX24q-3+q-4	230	2x26/32/42W	-														
DN-1512-N3-H6	●	TC-TEL GX24q-3+q-4	230	2x26/32/42W	-														
DN-1522-14-H6	○	TC-DEL G24q-3	230	2x26W	-	Elect. inc													
DN-1522-N3-H6	●	TC-DEL G24q-3	230	2x26W	-														

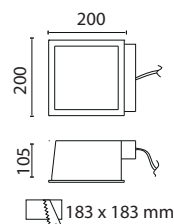

Downlight cuadrado para lámpara HIT-DE con casquillo RX7s.  
 Óptica asimétrica **BAÑADORA DE PAREDES** de alto rendimiento.  
 Square downlight for metal halide lamp HIT-DE.  
 High efficiency asymmetric reflector for wall washer.



CÓDIGO CODE	COLOR COLOUR	LÁMPARA LAMP	VOLT. VOLT	W W	HAZ BEAM	EQUIPO GEAR	INSTALACIÓN INSTALLATION	102	102
EP-0343-14-00	○	HIT-DE Rx7s	230	70W	-	Not inc			
EP-0343-N3-00	●	HIT-DE Rx7s	230	70W	-				

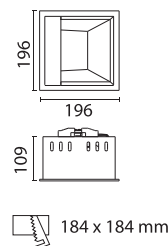

Equipo no incluido, a pedir separadamente, ver pág. 194  
 Gear not included, to be ordered separately, see page 194



**MODUL**  
ELECTRO  
[www.modulelectro.ru](http://www.modulelectro.ru)



**EXIT**

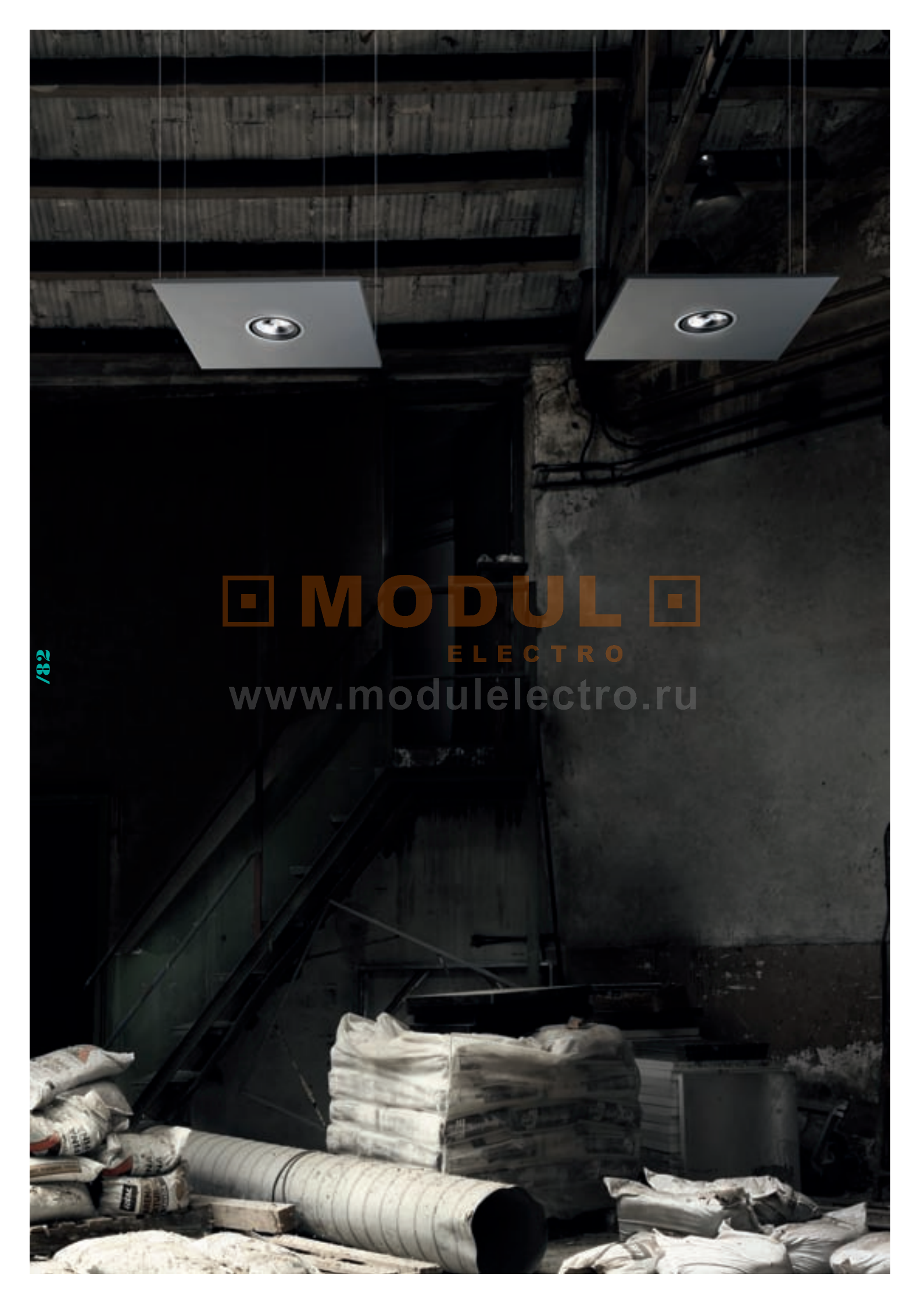

**MODUL**  
ELECTRO  
[www.modulelectro.ru](http://www.modulelectro.ru)

# /CARDEX/

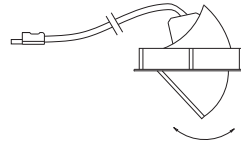
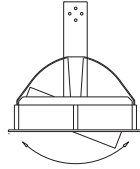
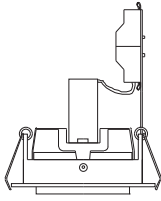

## Gama de downlights orientables para iluminación ambiental o de acentuación.

*Adjustable downlights range for environmental or accent lighting.*

### DESCRIPCIÓN / DESCRIPTION

#### Cuerpo y marco exterior fabricados en fundición de aluminio acabado con pintura epoxi.

*Aluminium cast housing with white or grey/silver epoxy painting finish.*

#### • CARDEX E

Disponibles para lámpara halógena (QT-12) o de halogenuros metálicos (HIT-TC G8.5)

El sistema de orientación permite la extracción  $\pm 40^\circ$  y el giro de  $355^\circ$  en el eje vertical.

*Available for halogen lamps (QT-12) or compact discharge lamps (HIT-TC G8.5).*

*The orientation system allows 2 kinds of adjustments:  $\pm 40^\circ$  pull and  $355^\circ$  turn.*

#### • CARDEX C

Disponibles para lámpara halógena (QR-111) y para halogenuros metálicos HIT-T o CDM-R111.

Las luminarias para lámpara de descarga compacta (HIT-T) incorporan un reflector en aluminio anodizado de muy alta pureza, disponible en dos versiones: óptica intensiva ( $10^\circ$ ) o semi-extensiva ( $45^\circ$ ).

*Available for the halogen lamp QR-111 and for discharge lamps HIT-T or CDM-R111.*

*Versions for discharge lamps (HIT-T) include a high purity anodised aluminium reflector available in two versions: intensive ( $10^\circ$ ) or semi-flood ( $45^\circ$ ).*

#### • CARDEX CM

Disponibles para lámpara halógenas (QR-70) y para lámpara compactas de halogenuros metálicos CDM-Tm.

Las luminarias para lámpara de descarga compacta (CDM-Tm) incorporan un reflector disponible en dos versiones: en vidrio dicróico para una distribución intensiva ( $12^\circ$ ) o en aluminio anodizado para una distribución semi-extensiva ( $36^\circ$ ).

Éstas se suministran completas con equipo de funcionamiento electrónico y lámpara incorporada.

*Available for halogen QR-70 and for compact discharge lamp CDM-Tm 20W.*

*Versions for compact discharge lamp (CDM-Tm) include a reflector available in two versions:*

*dichroic glass reflector for intensive distribution ( $12^\circ$ ) or anodised aluminium reflector for semi-flood distribution ( $36^\circ$ ).*

*They are supplied complete with protection glass, lamp and electronic gear.*

### APLICACIÓN / APPLICATION

Luminarias especialmente indicadas para iluminar espacios comerciales y espacios dedicados a la restauración (bares, cafeterías, restaurantes, etc.).

*Luminaires to be used in any environmental and/or accent lighting project, specially in large commercial areas, restaurants, coffee shops, hotels, etc.*

### ACCESSORIOS / ACCESSORIES

Disponibilidad de placas de montaje rectangulares para las versiones CARDEX E y C (no válidas para CARDEX CM), para la instalación de 1, 2, 3 o 4 luminarias.

*Availability of mounting plates for 1, 2, 3 or 4 luminaires. Only available for versions CARDEX E and C, not for CM.*



# /CARDEX E/

Ver fotometrías en página 214 y tabla de equivalencias de lámparas en página 223.

See Photometric data on page 214 and equivalent lamps table on page 223.



Blanco / White

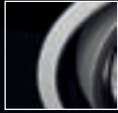

Gris / Grey



Posibilidad de extraer o recoger la cabeza del downlight y permitiendo, a la vez, la rotación de 355° en el plano vertical.

The orientation system allows 2 kinds of adjustments:  $\pm 40^\circ$  pull (out or in) and 355° turn around the vertical axis.

**MODULO ELECTRO**  
www.modulelectro.ru

184



Downlight orientable para lámpara HIT-TC o QT-12.  
Adjustable downlight for HIT-TC or MasterLine-TC lamps.

DN-0268								
DN-0269								

QT-12 GY6.35

HIT-TC G8.5

CÓDIGO CODE	COLOR COLOUR	LÁMPARA LAMP	VOLT. VOLT	W W	HAZ BEAM	EQUIPO GEAR	INSTALACIÓN INSTALLATION	
DN-0268-14-00		QT-12 GY6.35	12	max. 100W	85°			39
DN-0268-N3-00		QT-12 GY6.35	12	max. 100W	85°			39
DN-0269-14-00		HIT-TC G8.5	230	max. 70W	85°			40
DN-0269-N3-00		HIT-TC G8.5	230	max. 70W	85°			40

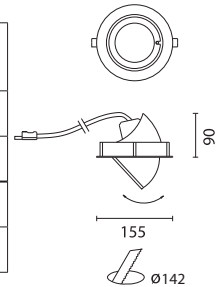

Equipo no incluido, a pedir separadamente, ver pág. 194  
Gear not included, to be ordered separately, see page 194



**MODUL**  
ELECTRO  
[www.modulelectro.ru](http://www.modulelectro.ru)

empotrables de techo / ceiling recessed

arquitectural

# /CARDEX C/

Ver fotometrías en página 214 y tabla de equivalencias de lámparas en página 223.

See Photometric data on page 214 and equivalent lamps table on page 223.

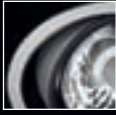

Blanco / White

Gris / Grey

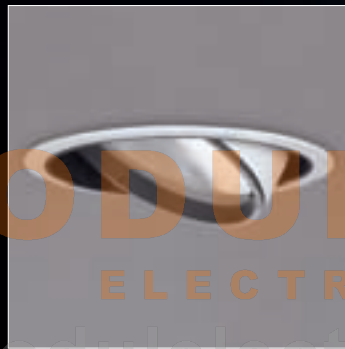

Gran versatilidad para dirigir el haz de luz gracias al sistema de orientación tipo cardan que permite una orientación en cualquier dirección.

Great versatility for adjusting the direction of the light beam thanks to the cardan type orientation system.

186



Downlight orientable para lámpara QR-111, CDM-R111, HIT-T.  
Adjustable downlight for QR-111, CDM-R111, HIT-T. lamps.



	C6D160 CODE	COLOR COLOUR	LÁMPARA LAMP	VOLT. VOLT	W W	HAZ BEAM	EQUIPO GEAR	INSTALACIÓN INSTALLATION	
(*)	DN-0270-14-00	○	QR-111 G53	12	max.100W	-	Not inc		
(*)	DN-0270-N3-00	●	QR-111 G53	12	max.100W	-			
	DN-0275-14-00	○	CDM-R111 GX8.5	230	max.70W	-			
	DN-0275-N3-00	●	CDM-R111 GX8.5	230	max.70W	-			
(**)	DN-0274-14-00	○	HIT-T G12	230	max.150W	10°			
(**)	DN-0274-N3-00	●	HIT-T G12	230	max.150W	10°			
(**)	DN-0273-14-00	○	HIT-T G12	230	max.150W	45°			
(**)	DN-0273-N3-00	●	HIT-T G12	230	max.150W	45°			

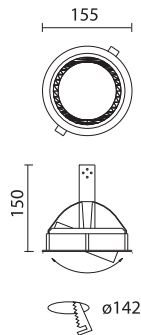

Equipo no incluido, a pedir separadamente, ver pág. 194  
Gear not included, to be ordered separately, see page 194





**MODULO ELECTRO**

Placa decorativa de montaje (No válida para Cardex CM).  
 Decorative mounting plate (Not valid for Cardex CM).

CÓDIGO CODE	COLOR COLOUR
ACT-0065-14-00	○
ACT-0065-N3-00	●

187  
187  
170 x 170 mm

CÓDIGO CODE	COLOR COLOUR
ACT-0066-14-00	○
ACT-0066-N3-00	●

187  
353  
170 x 337 mm

CÓDIGO CODE	COLOR COLOUR
ACT-0067-14-00	○
ACT-0067-N3-00	●

187  
520  
170 x 503 mm

CÓDIGO CODE	COLOR COLOUR
ACT-0068-14-00	○
ACT-0068-N3-00	●

353  
353  
337 x 337 mm





# /CARDEX CM/

Ver fotometrías en página 214 y tabla de equivalencias de lámparas en página 223.

See Photometric data on page 214 and equivalent lamps table on page 223.

788

## MODULO ELECTRO

www.modulelectro.ru



Downlight orientable para lámpara QR-70 o CDM-Tm.  
Adjustable downlight for QR-70 or CDM-Tm lamp.

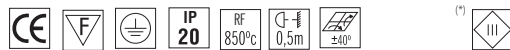

CÓDIGO CODE	COLOR COLOUR	LÁMPARA LAMP	VOLT. VOLT	W W	HAZ BEAM	EQUIPO GEAR	INSTALACIÓN INSTALLATION	
(*) DN-0278-14-00	○	QR-70 BA15d	12	max.50W	-	Not inc <sup>(2)</sup>	43-44	
(*) DN-0278-N3-00	●	QR-70 BA15d	12	max.50W	-	Not inc		
DN-0279-14-00	○	CDM-Tm PGJ5 <sup>(1)</sup>	230	20W	12°	Elect. inc	45	
DN-0279-N3-00	●	CDM-Tm PGJ5 <sup>(1)</sup>	230	20W	12°		45	
DN-0280-14-00	○	CDM-Tm PGJ5 <sup>(1)</sup>	230	20W	36°		46	
DN-0280-N3-00	●	CDM-Tm PGJ5 <sup>(1)</sup>	230	20W	36°		46	

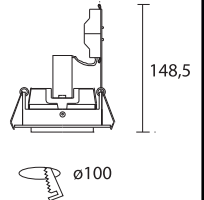
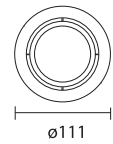

(1) Lámpara suministrada con el aparato  
(1) Lamp included with the luminaire

(2) Equipo no incluido, a pedir separadamente, ver pág. 194  
(2) Gear not included, to be ordered separately, see page 194



MODUL

ELECTRO

[www.modulelectro.ru](http://www.modulelectro.ru)

empotrables de techo / ceiling recessed

arquitectural

/89

**MODUL**  
ELECTRO  
[www.modul-electro.ru](http://www.modul-electro.ru)



# / VITRO /

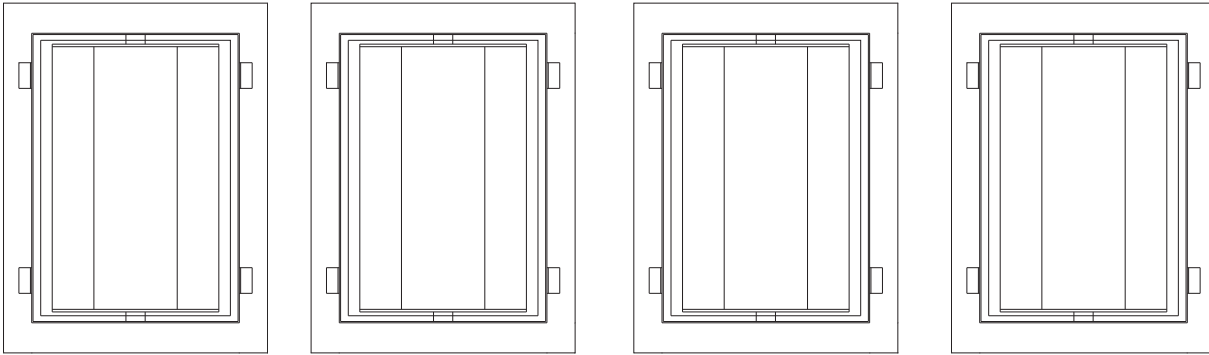

## DESCRIPCIÓN / DESCRIPTION

**Downlight orientable para iluminación tipo bañador de pared o para iluminación general.**

**Cuerpo fabricado en chapa de acero lacada en negro.**

**Marco exterior en aluminio acabado con pintura epoxi de color gris-plata.**

**Compartimiento óptico en aluminio extruido y orientable  $\pm 40^\circ$  en el eje horizontal. Incluye un reflector fabricado en aluminio anodizado brillo y está protegido por un cristal templado arenado para un mejor confort visual.**

**Disponible para lámparas halógenas QT-DE o para descarga de halogenuros metálicos HIT-DE.**

*Adjustable downlight for wall-washing or general lighting.*

*Housing made of black lacquered steel.*

*Outer trim in die-cast aluminium finished in grey-silver epoxy painting.*

*Extruded aluminium orientable optic compartment with  $\pm 40^\circ$  rotation on the horizontal axis. This compartment includes a reflector made of high-gloss anodised aluminium. Lamp-holders and components are protected with a tempered sand-blasted glass.*

*Available for QT-DE halogen lamps or for HIT-DE discharge lamps.*

## APLICACIÓN / APPLICATIONS

**Luminarias para ser usadas, sobre todo, en la iluminación vertical de paredes y estanterías. El novedoso sistema de orientación del haz de luz permite obtener un bañador de pared sin la obstrucción de los sistemas convencionales.**

*Luminaires to be used, mainly, for the vertical lighting of walls and shelves. The innovative adjustment system provides a wall-washer without the obstruction of the conventional systems.*



# MITRO/

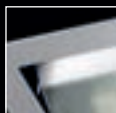

Gris / Grey

Ver fotometrías en página 214 y tabla de equivalencias de lámparas en página 223.

See Photometric data on page 214 and equivalent lamps table on page 223.



## MODUL

### ELECTRO

[www.modulelectro.ru](http://www.modulelectro.ru)

192





Downlight orientable para lámpara HIT-DE o QT-DE.  
Adjustable downlight for HIT-DE or QT-DE lamps.



 HIT-DE Rx7s

 QT-DE R7s

CÓDIGO CODE	COLOR COLOUR	LÁMPARA LAMP	VOLT. VOLT	W W	HAZ BEAM	EQUIPO GEAR	INSTALACIÓN INSTALLATION	
(*) DN-0276-N3-B9	●	HIT-DE Rx7s	230	70W	-	Not inc		47
(*) DN-0750-N3-B9	●	HIT-DE Rx7s	230	150W	-			61
DN-0277-N3-B9	●	QT-DE R7s	230	max.150W	-	-	62	

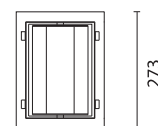

206

 172 x 236 mm

(1) Equipo no incluido, a pedir separadamente, ver pág. 194  
(1) Gear not included, to be ordered separately, see page 194

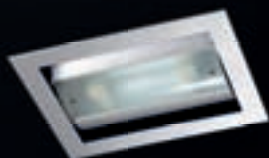



**MODUL**  
ELECTRO  
[www.modulelectro.ru](http://www.modulelectro.ru)



Novedoso sistema de orientación del haz de luz que permite obtener un bañador de pared sin la obstrucción de los sistemas convencionales.

Innovative adjustment system provides a wall-washer without the obstruction of the conventional systems.

 **MODUL**   
ELECTRO  
[www.modul-electro.ru](http://www.modul-electro.ru)



# /EXTRA/

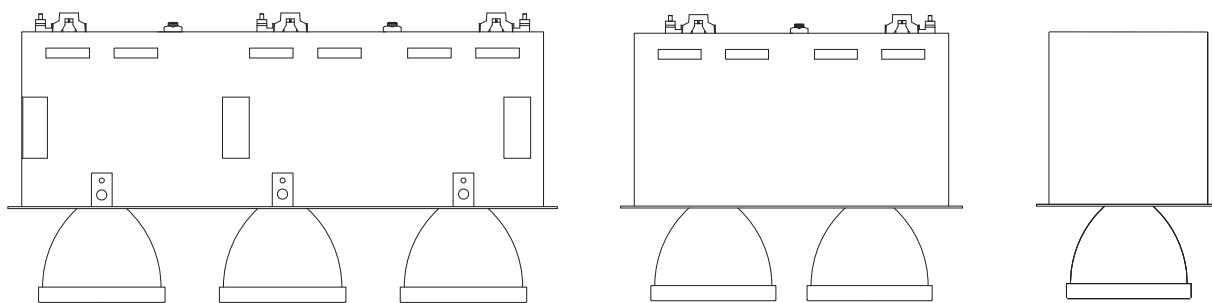

## DESCRIPCIÓN / DESCRIPTION

Luminaria que combina las funcionalidades de los downlights y de los spotlights.

Cuerpo fabricado en chapa de acero lacada en negro.

Marco exterior en aluminio de fundición.

El compartimiento óptico dispone de un sistema de extracción (total o parcial) y de rotación de 360° para la total libertad de direccionamiento de las fuentes de luz.

La versión de 1 lámpara tiene el cuerpo redondo para una mayor facilidad de instalación.

Disponible para lámparas halógenas (QT-TC) y de descarga compactas (HIT-TC).

Anclajes incorporados en el cuerpo y ajustables fácilmente con un destornillador.

*Luminaire combining the functionalities of a downlight and a spotlight.*

*Housing made of black lacquered steel.*

*Outer trim in die-cast aluminium finished in grey-silver epoxy painting.*

*The optical compartment can be completely or partly pulled out and then rotated 360° for a total freedom on the adjustment of the light direction.*

*One lamp version has a round housing for higher ease of installation.*

*Available for halogen lamps (QT-TC) and compact discharge lamps (HIT-TC).*

*Brackets integrated in the luminary housing and easy to adjust with a screwdriver.*

## APLICACIÓN / APPLICATIONS

Luminarias para ser utilizadas en cualquier proyecto donde se quiera combinar iluminación general y de acentuación con un producto innovador y con un excelente diseño y acabados.

*Luminaires to be used in any general and/or accent lighting project with a very innovative product with excellent design and finishes.*

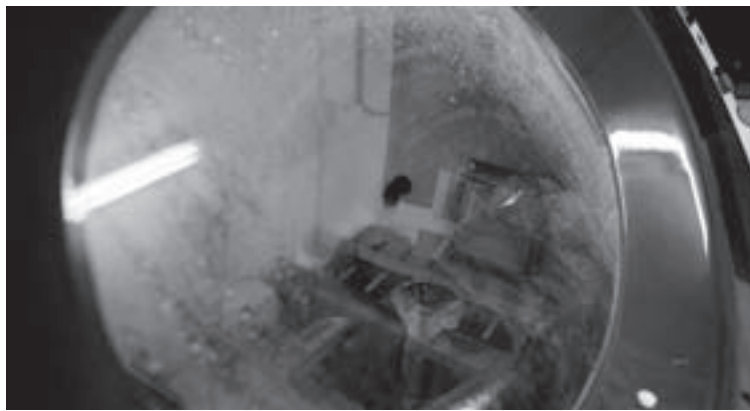



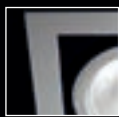

Gris / Grey



### Downlight cuadrado para lámparas QT-TC o HIT-TC.

Square downlight for QT-TC or HIT-TC lamps.

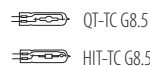
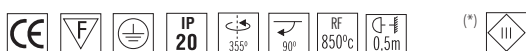

CÓDIGO CODE	COLOR COLOUR	LÁMPARA LAMP	VOLT. VOLT	W W	HAZ BEAM	EQUIPO GEAR	INSTALACIÓN INSTALLATION	
DM-0073-N3-00	●	HIT-TC G8.5	230	70W	30°	Not inc		63
DM-0074-N3-00	●	QT-TC G8.5	12	60W	20°	Not inc		64

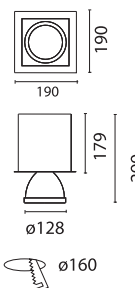

www.modulelectro.ru

### Downlight rectangular para lámparas 2xQT-TC o 2xHIT-TC.

Rectangular downlight for 2xQT-TC or 2xHIT-TC lamps.

CÓDIGO CODE	COLOR COLOUR	LÁMPARA LAMP	VOLT. VOLT	W W	HAZ BEAM	EQUIPO GEAR	INSTALACIÓN INSTALLATION	
DM-0075-N3-00	●	HIT-TC G8.5	230	2x70W	30°	Not inc		63
DM-0076-N3-00	●	QT-TC G8.5	12	2x60W	20°	Not inc		64

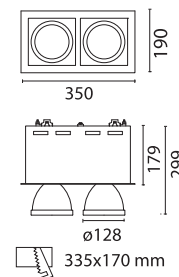

### Downlight rectangular para lámparas 3xQT-TC o 3xHIT-TC.

Rectangular downlight for 3xQT-TC or 3xHIT-TC lamps.

CÓDIGO CODE	COLOR COLOUR	LÁMPARA LAMP	VOLT. VOLT	W W	HAZ BEAM	EQUIPO GEAR	INSTALACIÓN INSTALLATION	
DM-0077-N3-00	●	HIT-TC G8.5	230	3x70W	30°	Not inc		63
DM-0078-N3-00	●	QT-TC G8.5	12	3x60W	20°	Not inc		64

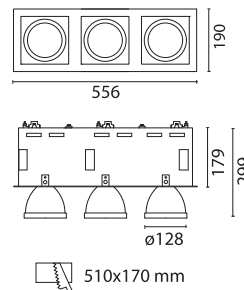

(1) Equipo no incluido, a pedir separadamente, ver pág. 194

(1) Gear not included, to be ordered separately, see page 194



**MODULO**  
ELECTRO

[www.modulelectro.ru](http://www.modulelectro.ru)

empotrables de techo / ceiling recessed

arquitectural

197



Sistema de orientación tipo "extracción-rotación" en toda la gama que permite obtener, en un mismo aparato, las funcionalidades combinadas de un downlight y de un spotlight (proyector).

*Orientation system type "pull-out and turn" allowing to have, in the same luminaire, the functionalities of a downlight and a spotlight.*



Posibilidad de combinaciones (QT-TC+HIT-TC) bajo pedido  
Different lamp combinations (QT-TC+HIT-TC) available upon request



**MODUL**  
ELECTRO  
[www.modulelectro.ru](http://www.modulelectro.ru)

86/

# /SATIN/

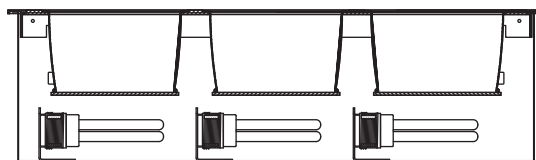
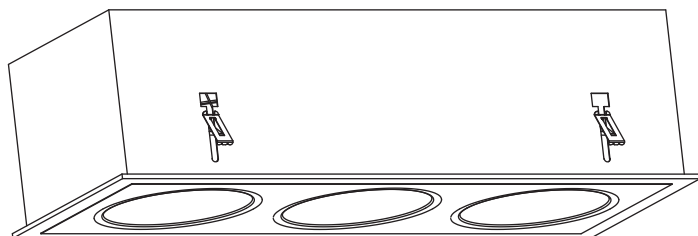

## DESCRIPCIÓN / DESCRIPTION

Cuerpo fabricado en chapa de acero lacada en blanco.

Marco exterior de aluminio acabado con pintura epoxi de color blanco.

Reflectores fabricados en aluminio anodizado brillante montados en una placa de acrílico opal. Este conjunto va directamente acoplado al marco exterior.

Disponible para 1, 2, 3 ó 4 lámparas de fluorescencia compacta TC-TEL, alimentadas por equipo electrónico multi-wattage (26-42W) incluido en la luminaria.

Luminarias para empotrar en falsos techos. Los anclajes son ajustables sin necesidad de herramientas.

El marco exterior se sujeta al cuerpo de la luminaria a través de muelles V-clip para su fácil instalación y mantenimiento.

Se incluye como accesorio un difusor en policarbonato opal para evitar el deslumbramiento.

*Housing made of white lacquered steel.*

*Aluminium outer trim finished with white epoxy painting.*

*High-glass anodised aluminium reflectors mounted on opal acrylic diffuser. This set is directly assembled on the aluminium trim.*

*Available for 1, 2, 3 or 4 compact fluorescent lamps TC-TEL. The multi-wattage (26-42W) gear is included with the luminaire.*

*Luminaires for recessed mounting. The ceiling brackets are adjustable without tools.*

*The outer trim remains hanged via the V-clips making the installation and maintenance operations much easier.*

*An anti-glare diffuser made in opal acrylic is included as an accessory.*

## APLICACIÓN / APPLICATIONS

Luminarias para ser utilizadas en cualquier proyecto de iluminación general - tiendas, oficinas, despachos, hoteles - donde el confort visual y la excelente calidad y diferenciación de los productos sean los principales requerimientos.

*Luminaires to be used in any general lighting project - shops, offices, hotels - where visual comfort and excellent quality and differentiation of the products are the main requirements.*





Blanco / White

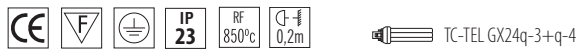

Downlight cuadrado con óptica fija para TC-TEL.  
Square downlight for TC-TEL lamps.

CÓDIGO CODE	COLOR COLOUR	LÁMPARA LAMP	VOLT. VOLT	W W	HAZ BEAM	EQUIPO GEAR	INSTALACIÓN INSTALLATION	
DM-0044-14-00	○	TC-TEL GX24q-3+q-4	230	26/32/42W	-	Elect. inc		110

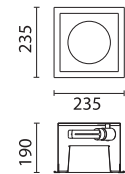

217 x 217 mm

Downlight cuadrado con ópticas fijas para 2 TC-TEL.  
Square downlight for 2xTC-TEL lamps.

CÓDIGO CODE	COLOR COLOUR	LÁMPARA LAMP	VOLT. VOLT	W W	HAZ BEAM	EQUIPO GEAR	INSTALACIÓN INSTALLATION	
DM-0045-14-00	○	TC-TEL GX24q-3+q-4	230	2x26/32/42W	-	Elect. inc		111

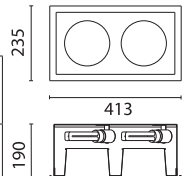

395 x 217 mm

Downlight rectangular con ópticas fijas para 3 TC-TEL.  
Rectangular downlight for 3xTC-TEL lamps.

CÓDIGO CODE	COLOR COLOUR	LÁMPARA LAMP	VOLT. VOLT	W W	HAZ BEAM	EQUIPO GEAR	INSTALACIÓN INSTALLATION	
DM-0046-14-00	○	TC-TEL GX24q-3+q-4	230	3x26/32/42W	-	Elect. inc		112

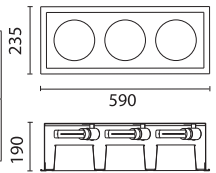

572 x 217 mm

Downlight cuadrado con ópticas fijas para 4 TC-TEL.  
Square downlight for 4xTC-TEL lamps.

CÓDIGO CODE	COLOR COLOUR	LÁMPARA LAMP	VOLT. VOLT	W W	HAZ BEAM	EQUIPO GEAR	INSTALACIÓN INSTALLATION	
DM-0047-14-00	○	TC-TEL GX24q-3+q-4	230	4x26/32/42W	-	Elect. inc		113

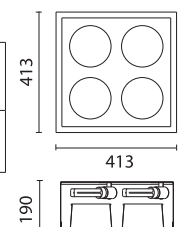

395 x 395 mm

(\*) Consultar  
(\*) Consult



# MODUL

ELECTRO

[www.modulelectro.ru](http://www.modulelectro.ru)



El reflector de aluminio anodizado conjuntamente con el difusor en acrílico opal, nos ofrece un buen rendimiento y un excelente confort visual (luz suave). Incorpora difusor de metacrilato para evitar visión directa de las lámparas.

*The anodised aluminium reflector together with the opal acrylic diffuser give a good efficiency and an excellent visual comfort (soft light). Acrylic diffuser included to avoid direct vision of the lamps.*



El marco exterior se puede fijar a uno de los lados, facilitando las operaciones de instalación y mantenimiento.

*Outer trim can be hinged from one side making the installation and maintenance operations easier.*

# /SATIN EVOLUTION/

Ver fotometrías en página 214 y tabla de equivalencias de lámparas en página 223.

See Photometric data on page 214 and equivalent lamps table on page 223.



Blanco / White



Downlight para iluminación combinada general y/o de acentuación para TC-DEL y QR-70.  
Square downlight for combined general and/or accent lighting with TC-DEL and QR-70 lamps.

CÓDIGO CODE	COLOR COLOUR	LÁMPARA LAMP	VOLT. VOLT	W W	HAZ BEAM	EQUIPO GEAR	INSTALACIÓN INSTALLATION	
DM-0058-14-00	○	TC-DEL G24q-2	230	2x18W	-	Elect. inc.		114
		QR-70 BA15 d	230	max.50W	-			

TC-DEL G24q-2

QR-70 BA15 d

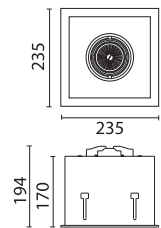

217 x 217 mm

Downlight para iluminación combinada general y/o de acentuación para TC-L y QR-70.  
Rectangular downlight for combined general and/or accent lighting with TC-L and QR-70 lamps.

CÓDIGO CODE	COLOR COLOUR	LÁMPARA LAMP	VOLT. VOLT	W W	HAZ BEAM	EQUIPO GEAR	INSTALACIÓN INSTALLATION	
DM-0059-14-00	○	TC-L 2G11	230	2x24W	-	Elect. inc.		115
		QR-70 BA15 d	230	max.2x50W	-			

TC-L 2G11

QR-70 BA15 d

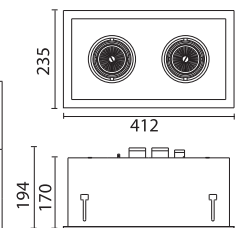

395 x 217 mm

Downlight para iluminación combinada general y/o de acentuación para T5c y QR-111.  
Square downlight for combined general and/or accent lighting with T5c y QR-111 lamps.

CÓDIGO CODE	COLOR COLOUR	LÁMPARA LAMP	VOLT. VOLT	W W	HAZ BEAM	EQUIPO GEAR	INSTALACIÓN INSTALLATION	
DM-0060-14-00	○	T5C-2GX13	230	(22+40) W	-	Elect. inc.		116
		QR-111 G53	230	max.65W	-			

T5C-2GX13

QR-111 G53

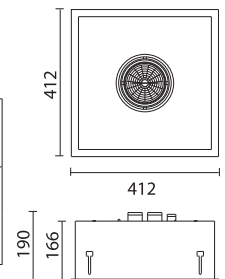

395 x 395 mm

(\*) Consultar

(\*) Consult



empotrables de techo / ceiling recessed

arquitectural

**MODUL**  
ELECTRO  
[www.modulelectro.ru](http://www.modulelectro.ru)

/103



Utilización de las innovadoras y eficientes lámparas TSC para un buen rendimiento y una distribución homogénea de la luz sobre el difusor opal.

*Use of the innovative TSC lamps for a good efficiency and a homogeneous light distribution on the opal diffuser.*



**MODUL**

ELECTRO

[www.modulelectro.ru](http://www.modulelectro.ru)





**MODUL**  
ELECTRO  
[www.modulelectro.ru](http://www.modulelectro.ru)

empotrado de techo / ceiling recessed mounted

arquitecto

/105

**MODUL**  
ELECTRO  
[www.modulelectro.ru](http://www.modulelectro.ru)



# MULTIDIR/

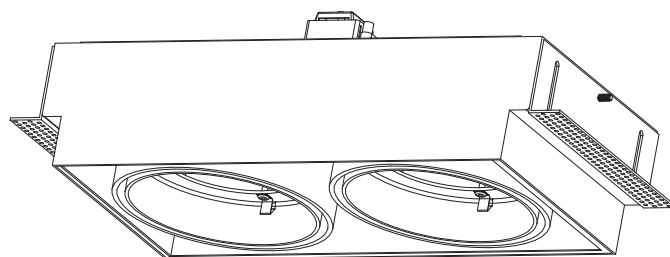
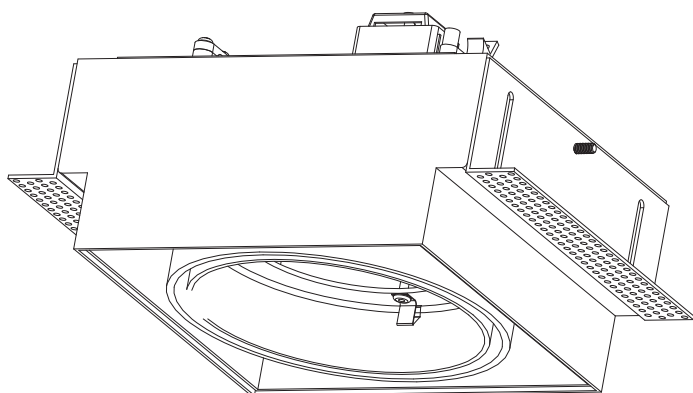

## DESCRIPCIÓN / DESCRIPTION

Cuerpo fabricado en chapa de acero lacada en negro.  
Marco exterior en fundición de aluminio acabado en color gris/plata.  
Sistema cardan para total libertad de direccionamiento de los haces de luz.  
Disponible para lámparas halógenas (QR-111, QR-CB51).  
Anclajes incorporados en el cuerpo y ajustables sin necesidad de herramientas para una total facilidad de instalación.

*Housing made of black lacquered steel.  
Outer trim in die-cast aluminium finished in grey-silver epoxy painting.  
Cardan type orientation system for total freedom to adjust the light direction.  
Available for halogen lamps (QR-111, QR-CB51).  
Brackets integrated in the luminary housing and adjustable without tools.*

## APLICACIÓN / APPLICATIONS

Luminarias para ser utilizadas en cualquier proyecto de iluminación general, ambiental y/o acentuación - tiendas, oficinas, hoteles, - donde la excelente calidad de los productos sean los principales requerimientos.

*Luminaires to be used in any general, environmental or accent lighting project - shops, offices hotels - where the excellent quality of the products are the main requirements.*





Blanco / White

Gris / Grey



Posibilidad de combinaciones (QR-111+CDM-R111) bajo pedido  
Different lamp combinations (QR-111+CDM-R111) available upon request



Downlight cuadrado para QR-111.  
Square downlight for QR-111 lamp.



CÓDIGO CODE	COLOR COLOUR	LÁMPARA LAMP	VOLT. VOLT	W W	HAZ BEAM	EQUIPO GEAR	INSTALACIÓN INSTALLATION	
DM-0061-N3-00	●	QR-111 G53	12	max.100W	-	Not inc		09-14
DM-0061-14-00	○	QR-111 G53	12	max.100W	-	Not inc		09-14

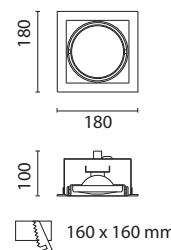

Downlight rectangular para 2xQR-111.  
Rectangular downlight for 2xQR-111 lamps.

CÓDIGO CODE	COLOR COLOUR	LÁMPARA LAMP	VOLT. VOLT	W W	HAZ BEAM	EQUIPO GEAR	INSTALACIÓN INSTALLATION	
DM-0062-N3-00	●	QR-111 G53	12	max. 2x100W	-	Not inc		09-14
DM-0062-14-00	○	QR-111 G53	12	max. 2x100W	-	Not inc		09-14

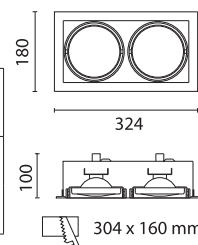

Downlight rectangular para 3xQR-111.  
Rectangular downlight for 3xQR-111 lamps.

CÓDIGO CODE	COLOR COLOUR	LÁMPARA LAMP	VOLT. VOLT	W W	HAZ BEAM	EQUIPO GEAR	INSTALACIÓN INSTALLATION	
DM-0063-N3-00	●	QR-111 G53	12	max. 3x100W	-	Not inc		09-14
DM-0063-14-00	○	QR-111 G53	12	max. 3x100W	-	Not inc		09-14

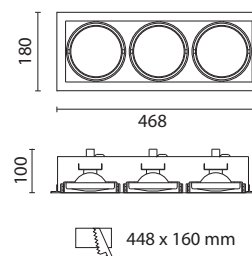

Downlight cuadrado para 4xQR-111.  
Square downlight for 4xQR-111 lamps.

CÓDIGO CODE	COLOR COLOUR	LÁMPARA LAMP	VOLT. VOLT	W W	HAZ BEAM	EQUIPO GEAR	INSTALACIÓN INSTALLATION	
DM-0064-N3-00	●	QR-111 G53	12	max. 4x100W	-	Not inc		09-14
DM-0064-14-00	○	QR-111 G53	12	max. 4x100W	-	Not inc		09-14

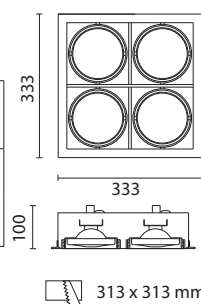

Equipo no incluido, a pedir separadamente, ver pág. 199  
Gear not included, to be ordered separately, see page 199



empotrables de techo / ceiling recessed

arquitectural

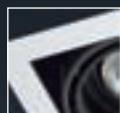

Blanco / White

Gris / Grey

Downlight cuadrado para QR-CB51.  
Square downlight for QR-CB51 lamp.

CÓDIGO CODE	COLOR COLOUR	LÁMPARA LAMP	VOLT. VOLT	W W	HAZ BEAM	EQUIPO GEAR	INSTALACIÓN INSTALLATION	
DM-0053-N3-00	●	QR-CB51 GU5.3	12	max.50W	-	Not inc		01-08
DM-0053-14-00	○	QR-CB51 GU5.3	12	max.50W	-	Not inc		01-08

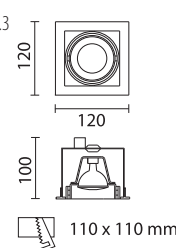

Downlight rectangular para 2xQR-CB51.  
Rectangular downlight for 2x QR-CB51 lamps.

CÓDIGO CODE	COLOR COLOUR	LÁMPARA LAMP	VOLT. VOLT	W W	HAZ BEAM	EQUIPO GEAR	INSTALACIÓN INSTALLATION	
DM-0054-N3-00	●	QR-CB51 GU5.3	12	max. 2x50W	-	Not inc		01-08
DM-0054-14-00	○	QR-CB51 GU5.3	12	max. 2x50W	-			

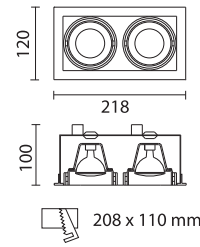

Downlight rectangular para 3xQR-CB51.  
Rectangular downlight for 3x QR-CB51 lamps.

CÓDIGO CODE	COLOR COLOUR	LÁMPARA LAMP	VOLT. VOLT	W W	HAZ BEAM	EQUIPO GEAR	INSTALACIÓN INSTALLATION	
DM-0055-N3-00	●	QR-CB51 GU5.3	12	max. 3x50W	-	Not inc		01-08
DM-0055-14-00	○	QR-CB51 GU5.3	12	max. 3x50W	-			

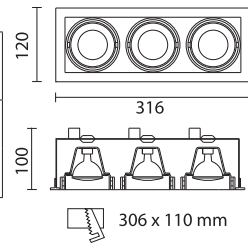

Downlight cuadrado para 4xQR-CB51.  
Square downlight for 4x QR-CB51 lamps.

CÓDIGO CODE	COLOR COLOUR	LÁMPARA LAMP	VOLT. VOLT	W W	HAZ BEAM	EQUIPO GEAR	INSTALACIÓN INSTALLATION	
DM-0056-N3-00	●	QR-CB51 GU5.3	12	max. 4x50W	-	Not inc		01-08
DM-0056-14-00	○	QR-CB51 GU5.3	12	max. 4x50W	-			

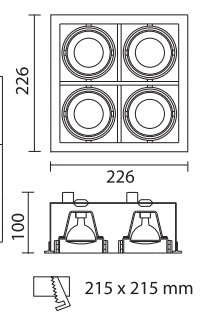

Equipo no incluido, a pedir separadamente, ver pág. 199  
Gear not included, to be ordered separately, see page 199

# MULTIDIR TRIMLESS /

Ver fotometrías en página 214 y tabla de equivalencias de lámparas en página 223.

See Photometric data on page 214 and equivalent lamps table on page 223.



Posibilidad de combinaciones (QR-111+CDM-R111) bajo pedido  
Different lamp combinations (QR-111+CDM-R111) available upon request



Downlight cuadrado para QR-111.  
Square downlight for QR-111 lamp.

Kit de montaje incluido.  
Ver instrucciones de montaje en pág. 199  
Mounting kit included.  
See mounting instructions on pag. 199

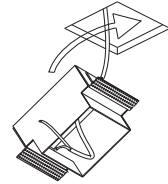

CÓDIGO CODE	COLOR COLOUR	LÁMPARA LAMP	VOLT. VOLT	W W	HAZ BEAM	EQUIPO GEAR	INSTALACIÓN INSTALLATION	
DM-0081-14-00	○	QR-111 G53	12	max.100W	-	Not inc		09-14
DM-0081-60-00	●	QR-111 G53	12	max.100W	-	Not inc		09-14

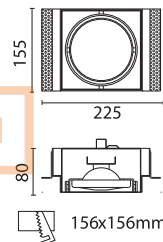

Downlight rectangular para 2xQR-111.  
Rectangular downlight for 2xQR-111 lamps.

CÓDIGO CODE	COLOR COLOUR	LÁMPARA LAMP	VOLT. VOLT	W W	HAZ BEAM	EQUIPO GEAR	INSTALACIÓN INSTALLATION	
DM-0082-14-00	○	QR-111 G53	12	max. 2X100W	-	Not inc		09-14
DM-0082-60-00	●	QR-111 G53	12	max. 2X100W	-	Not inc		09-14

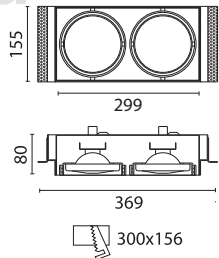

Downlight rectangular para 3xQR-111.  
Rectangular downlight for 3xQR-111 lamps.

CÓDIGO CODE	COLOR COLOUR	LÁMPARA LAMP	VOLT. VOLT	W W	HAZ BEAM	EQUIPO GEAR	INSTALACIÓN INSTALLATION	
DM-0083-14-00	○	QR-111 G53	12	max. 3X100W	-	Not inc		09-14
DM-0083-60-00	●	QR-111 G53	12	max. 3X100W	-	Not inc		09-14

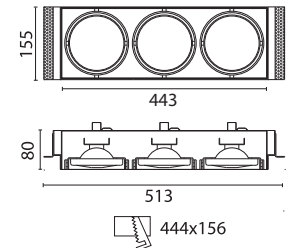

Downlight cuadrado para 4xQR-111.  
Square downlight for 4xQR-111 lamps.

CÓDIGO CODE	COLOR COLOUR	LÁMPARA LAMP	VOLT. VOLT	W W	HAZ BEAM	EQUIPO GEAR	INSTALACIÓN INSTALLATION	
DM-0084-14-00	○	QR-111 G53	12	max. 4X100W	-	Not inc		09-14
DM-0084-60-00	●	QR-111 G53	12	max. 4X100W	-	Not inc		09-14

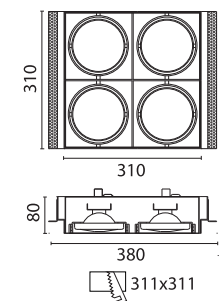

Equipo no incluido, a pedir separadamente, ver pág. 199  
Gear not included, to be ordered separately, see page 199

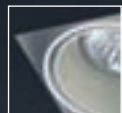

Blanco / White

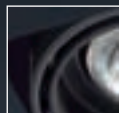

Negro / Black



Downlight cuadrado para QR-CB51.  
Square downlight for QR-CB51 lamp.

Kit de montaje incluido. Ver instrucciones de montaje en pág. 199  
Mounting kit included. See mounting instructions on pag. 199

para QR-CB51 < 35W
 QR-CB51 GU5.3

CÓDIGO CODE	COLOR COLOUR	LÁMPARA LAMP	VOLT. VOLT	W W	HAZ BEAM	EQUIPO GEAR	INSTALACIÓN INSTALLATION	
DM-0093-14-00	○	QR-CB51 GU5.3	12	max.50W	-	Not inc		01-08
DM-0093-60-00	●	QR-CB51 GU5.3	12	max.50W	-	Not inc		01-08

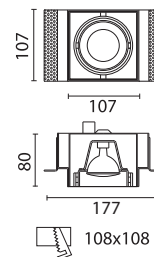

Downlight rectangular para 2xQR-CB51.  
Rectangular downlight for 2xQR-CB51 lamps.

CÓDIGO CODE	COLOR COLOUR	LÁMPARA LAMP	VOLT. VOLT	W W	HAZ BEAM	EQUIPO GEAR	INSTALACIÓN INSTALLATION	
DM-0094-14-00	○	QR-CB51 GU5.3	12	max. 2X50W	-	Not inc		01-08
DM-0094-60-00	●	QR-CB51 GU5.3	12	max. 2X50W	-	Not inc		01-08

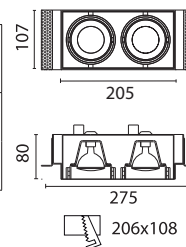

Downlight rectangular para 3xQR-CB51.  
Rectangular downlight for 3xQR-CB51 lamps.

CÓDIGO CODE	COLOR COLOUR	LÁMPARA LAMP	VOLT. VOLT	W W	HAZ BEAM	EQUIPO GEAR	INSTALACIÓN INSTALLATION	
DM-0095-14-00	○	QR-CB51 GU5.3	12	max. 3X50W	-	Not inc		01-08
DM-0095-60-00	●	QR-CB51 GU5.3	12	max. 3X50W	-	Not inc		01-08

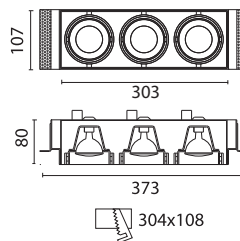

Downlight cuadrado para 4xQR-CB51  
Square downlight for 4xQR-CB51 lamps.

CÓDIGO CODE	COLOR COLOUR	LÁMPARA LAMP	VOLT. VOLT	W W	HAZ BEAM	EQUIPO GEAR	INSTALACIÓN INSTALLATION	
DM-0096-14-00	○	QR-CB51 GU5.3	12	max. 4X50W	-	Not inc		01-08
DM-0096-60-00	●	QR-CB51 GU5.3	12	max. 4X50W	-	Not inc		01-08

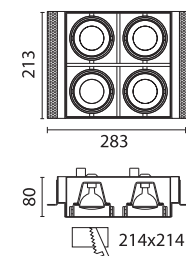

Equipo no incluido, a pedir separadamente, ver pág. 199  
Gear not included, to be ordered separately, see page 199

www.modulelectro.ru





**MODUL**  
ELECTRO  
[www.modulelectro.ru](http://www.modulelectro.ru)



# /MULTIDIR/

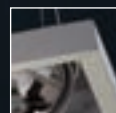

Gris / Grey

suspendidos / suspended

arquitectural



## MODUL

ELECTRO

www.modulelectro.ru

/113



Posibilidad de combinaciones  
(QR-111+CDM-R111) bajo pedido



Different lamp combinations  
(QR-111+CDM-R111) available



upon request



Luminaria decorativa para 4xQR-111  
Decorative suspended luminaire for QR-111 lamp.

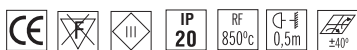

QR-111 G53

CÓDIGO CODE	COLOR COLOUR	LAMPARA LAMP	VOLT. VOLT	W W	HAZ BEAM	EQUIPO GEAR	INSTALACIÓN INSTALLATION	
SP-0105-N3-00	●	QR-111 G53	230	max.4x65W	-	Elect. inc		09-11

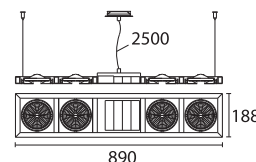

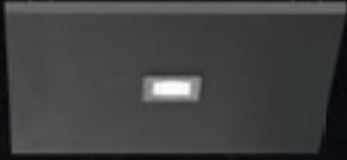

**MODUL**  
ELECTRO

[www.modulelectro.ru](http://www.modulelectro.ru)



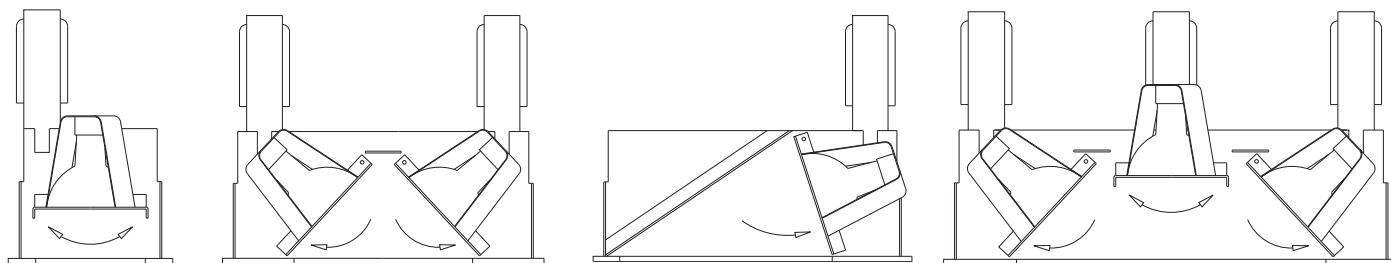

## DESCRIPCIÓN / DESCRIPTION

Pequeños downlights para lámpara(s) QR-CB51.

Cuerpo en chapa de acero lacada en negro, marco exterior de aluminio acabado en color gris/plata.

Muelle de fijación de la lámpara en acero inoxidable con gran resistencia a la deformación mecánica.

Anclajes incorporados en el cuerpo y ajustables sin necesidad de herramientas.

*Small recessed luminaires for QR-CB51.*

*Housing made of black lacquered steel.*

*Outer trim in die-cast aluminium finished in grey-silver epoxy painting.*

*Inox lamp fixation spring with great resistance to deformations.*

*Brackets integrated in the housing and adjustable without tools.*

## APLICACIÓN / APPLICATIONS

Diferentes configuraciones – cuadrado, asimétrico, multilámpara - permiten su adaptación tanto en ambientes domésticos como en ambientes comerciales.

*Different configurations – square, asymmetric, multilamp – and the quality of the products make possible their integration in domestic environments as well as in any commercial or leisure project.*





Ver fotometrías en página 214 y tabla de equivalencias de lámparas en página 223.

See Photometric data on page 214 and equivalent lamps table on page 223.



Gris / Grey

/116

# MODULO

## ELECTRO

www.modulelectro.ru



Downlight cuadrado para QR-CB51.  
Square downlight for QR-CB51 lamp.



CÓDIGO CODE	COLOR COLOUR	LÁMPARA LAMP	VOLT. VOLT	W W	HAZ BEAM	EQUIPO GEAR	INSTALACIÓN INSTALLATION	
DM-0048-N3-00	●	QR-CB51 GU5.3	12	max. 50W	-	Not inc		01-08

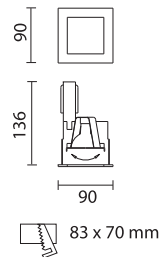

83 x 70 mm

Downlight rectangular, haz asimétrico para QR-CB51.  
Rectangular downlight for QR-CB51 lamp with asymmetric position.

CÓDIGO CODE	COLOR COLOUR	LÁMPARA LAMP	VOLT. VOLT	W W	HAZ BEAM	EQUIPO GEAR	INSTALACIÓN INSTALLATION	
DM-0049-N3-00	●	QR-CB51 GU5.3	12	max. 50W	-	Not inc		01-08

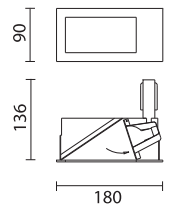

173x 70 mm

Equipo no incluido, a pedir separadamente, ver pág. 194  
Gear not included, to be ordered separately, see page 194





# MODUL

## ELECTRO

www.modulelectro.ru



Downlight rectangular para 2xQR-CB51.  
Rectangular downlight for 2x QR-CB51 lamp.

CÓDIGO CODE	COLOR COLOUR	LÁMPARA LAMP	VOLT. VOLT	W W	HAZ BEAM	EQUIPO GEAR	INSTALACIÓN INSTALLATION	
DM-0050-N3-00	●	QR-CB51 GU5.3	12	max. 2x50W	-	Not inc		01-08

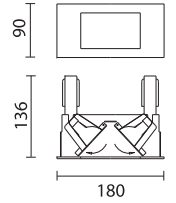

173 x 70 mm

Downlight rectangular para 3xQR-CB51.  
Rectangular downlight for 3x QR-CB51 lamp.

CÓDIGO CODE	COLOR COLOUR	LÁMPARA LAMP	VOLT. VOLT	W W	HAZ BEAM	EQUIPO GEAR	INSTALACIÓN INSTALLATION	
DM-0051-N3-00	●	QR-CB51 GU5.3	12	max. 3x50W	-	Not inc		01-08

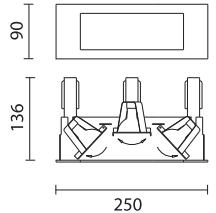

236 x 70 mm

Equipo no incluido, a pedir separadamente, ver pág. 194  
Gear not included, to be ordered separately, see page 194





loma

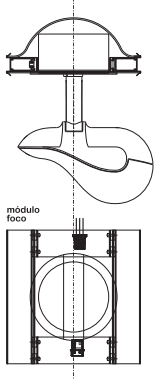

**MODULO**  
ELECTRO  
[www.modulelectro.net](http://www.modulelectro.net)

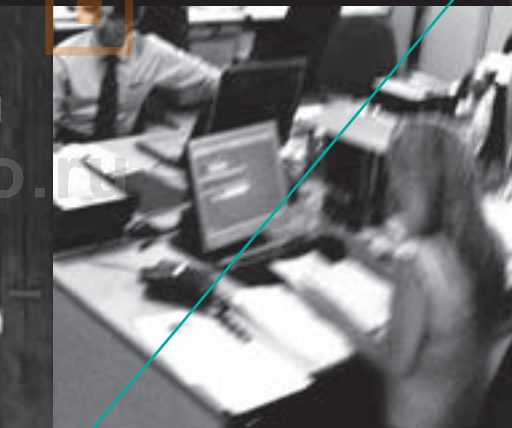

/118

# /SISTEMAS DE FLUORESCENCIA LINEAL SUSPENDIDA

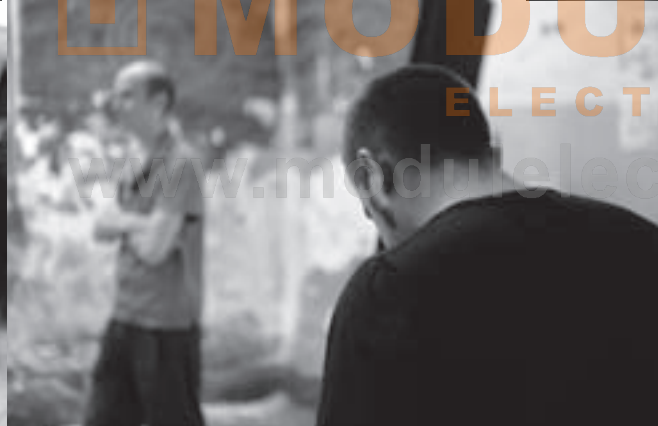
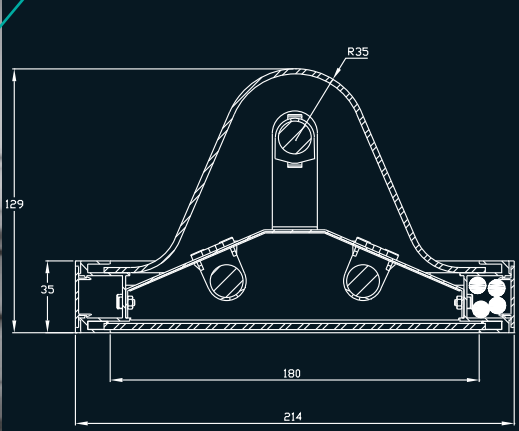

**MODUL**  
ELECTRO

[www.modul-electro.ru](http://www.modul-electro.ru)

# */fluorescent lineal lighting systems*



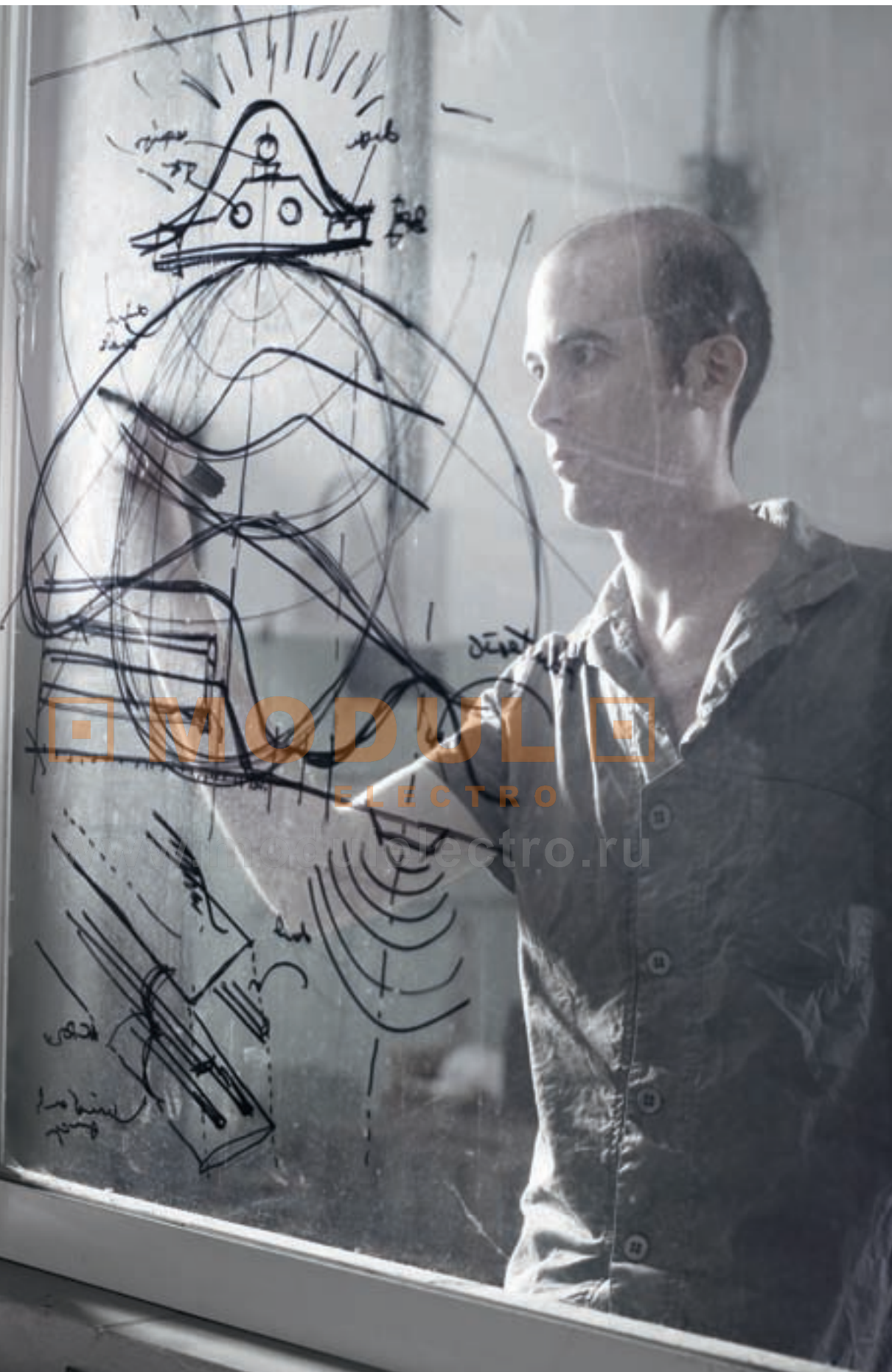

MODUL  
ELECTRO  
modul-electro.ru

# LOMA

Design by:  
PABLO MARTINEZ

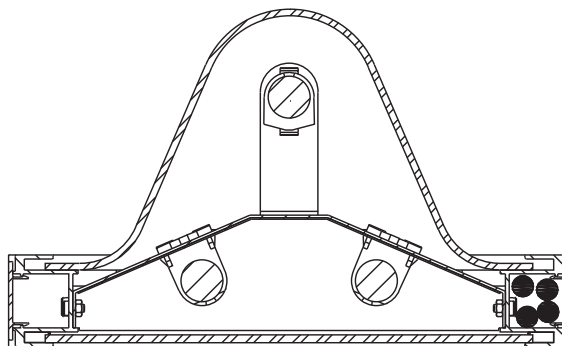
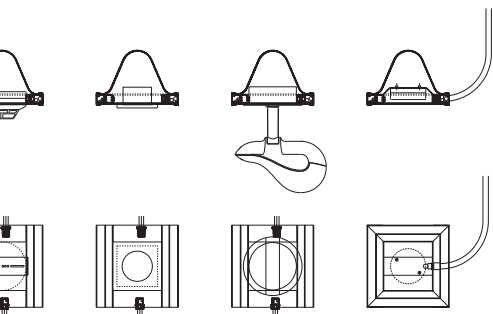

## Sistema de fluorescencia lineal preparada para conexión de dispositivos.

*Fluorescent linear lighting system suitable for optional devices.*

### DESCRIPCIÓN / DESCRIPTION

Loma es algo más que una luminaria. Su arquitectura modular y su diseño permiten la incorporación de una variada gama de dispositivos. Equipada con lámparas T5 (39W-54W-80W) que proporcionan luz directa e indirecta para lograr un mayor confort lumínico.

La capacidad de unir varias luminarias permite crear un sistema lineal para adecuarlo al entorno.

Chasis fabricado en aluminio, difusor superior de PMMA de alta resistencia, difusor inferior prismático fabricado con nanotecnología que proporciona un alto rendimiento (90%) con un índice de deslumbramiento idóneo para puestos de trabajo con VDU (Visual Display Units). Reflector de aluminio de alta pureza (99%).

*LOMA is more than a luminaire. Its modular architecture and its design give the possibility to incorporate a wide variety of devices. The modules are equipped with fluorescent tubes T5 (39-54-80W) that provide excellent luminous comfort through direct/indirect light emission.*

*The possibility to joint different luminaries provides the option of creating linear systems to adapt to the dimensions of each space.*

*Made of aluminium, upper diffuser in high resistance PMMA, lower diffuser made by nanotechnology with high efficiency (90%) suitable for environments with VDU (Visual Display Units). High purity aluminium reflector (99%).*

### APLICACIÓN / APPLICATIONS

Especialmente diseñada para crear de la nada un entorno confortable para oficinas, locales comerciales, escuelas o espacios con techos de gran altura.

Su diseño permite el paso de cables: voz, datos o señal, ofimática, detección de humos etc. evitando la necesidad de realizar la instalación de éstos a través de falsos techos o suelo técnico.

Su versatilidad convierte el espacio de trabajo en una herramienta flexible, permitiendo el cambio de ubicación de las luminarias de forma fácil. Suministrada en un solo módulo y con la posibilidad de incorporar filtros de color, Loma se convierte en una atractiva luminaria de efecto decorativo.

*Designed to create a comfortable environment for offices, retail shops, schools or spaces with high ceilings.*

*Its structure allows pass-through cables for voice, data or signal, ofimatics, smoke detection and so on, avoiding the need to install them through false ceilings or technical floors.*

*Its versatility turns the working area in a flexible tool, easily allowing the installation place change at anytime.*

*Supplied in a single module and with the possibility to incorporate colour filters, LOMA becomes an attractive fixture with a decorative touch.*

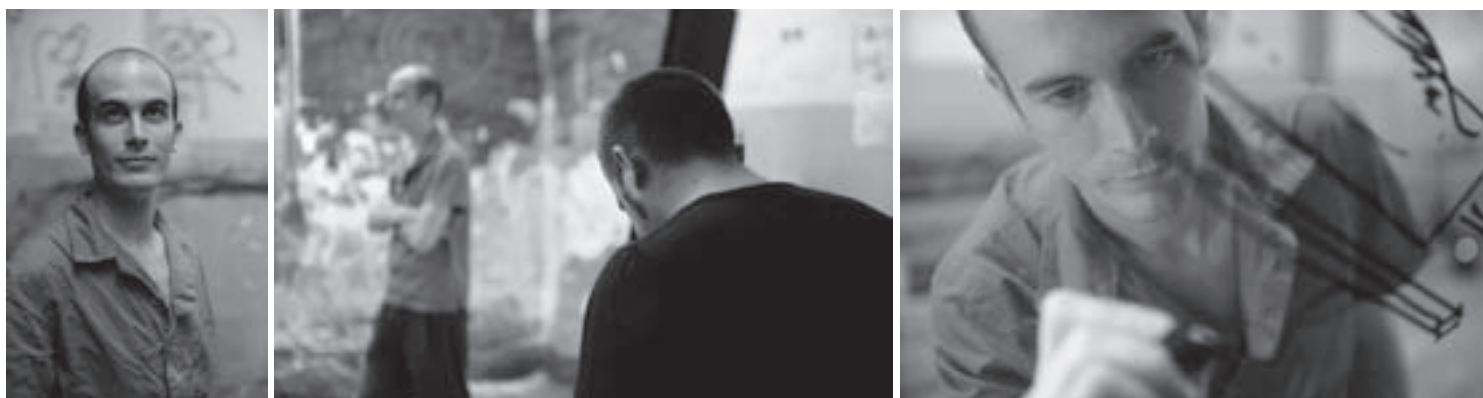

LOMA

MODUL

ELECTRO

[www.modulelectro.ru](http://www.modulelectro.ru)



**MODUL**  
ELECTRO

[www.modulselectro.ru](http://www.modulselectro.ru)

sistemas de fluorescencia lineal suspendida / fluorescent linear lighting systems

architectural

/123

## MÓDULO CENTRAL

### Mantenimiento

El Módulo principal está compuesto por una estructura en sándwich que permite una fácil apertura de la luminaria gracias a unas pestañas perfectamente integradas en la estructura de la luminaria. Esto simplifica tanto la reposición de lámparas y equipos, como la colocación de filtro cromáticos y es de gran ayuda para tareas de limpieza, manteniendo el factor de conservación.

### CENTRAL MODULE:

#### Maintenance

The main module consists of a sandwich structure allowing easy opening of the luminaire through integrated brackets. That simplifies lamp and gear replacement plus the incorporation of colour filters, as well as making it easier for maintenance and keeping the LMF (Luminaire maintenance factor).



## CANALIZACIONES PARA CABLEADO

El propio chasis de la luminaria aloja en su interior espacio para el paso de cables de comunicación, voz etc.. permitiendo el alojamiento de hasta 4 cables de 8 mm. de sección. La luminaria cuenta con dos canales para evitar, si fuera necesario, las molestias ocasionadas por incompatibilidad electromagnética.

Los cables de alimentación de red, tanto de la luminaria como de los posibles accesorios que se incorporen en los módulos, se alojan en el interior de la pieza para evitar interferencias.

La tapas laterales permiten que el cableado sea fácilmente registrable tanto para su instalación como para el diagnóstico de fallos.

La interconexión eléctrica entre los módulos se realiza mediante conectores rápidos de 5 polos.

### CABLE CONDUCTION

The structure of the luminaire holds internally a space for cable conduction of voice, data or signal, ... allowing up to 4 cables of 8 mm section each. There are two conductions to avoid, if needed, inconveniences caused by electromagnetic incompatibility.

The end caps allow the cabling to be easily installed or removed for testing or failure diagnostics.

The power supply cables, both of the luminaire and optional accessories, are allocated independently inside the fitting to avoid any electrical interferences.

The electrical interconnection of the different modules is done through 5 pole fast connectors.

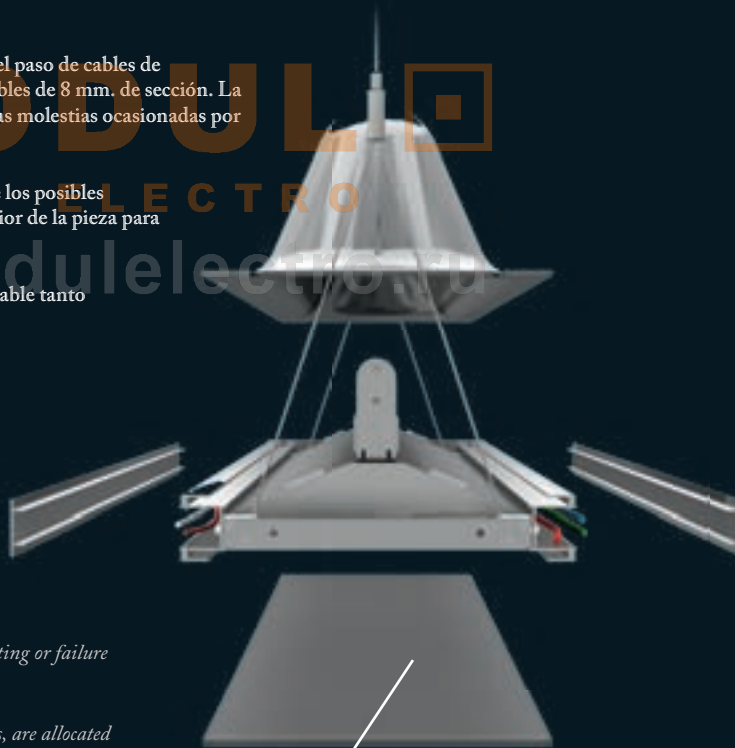

### DIFUSOR:

Su difusor prismático en PMMA fabricado con nanotecnología aporta un alto rendimiento (90%) y un excelente confort lumínico UGR (Índice de deslumbramiento unificado) de 18,5%

### DIFFUSER:

Its prismatic PMMA diffuser made by nanotechnology provides high efficiency (90%) plus and excellent luminous comfort UGR (Unified Glare Rating) 18,5%.

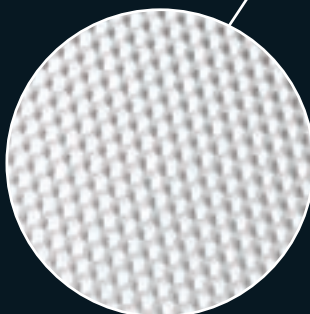

### MÓDULO PARA ACCESORIOS\*

El módulo para accesorios se suministra con una tapa ciega de fácil troquelado mediante sierra o coronas como si de un falso techo se tratara, dejando disponible en su interior un espacio para la incorporación de los dispositivos que se considere oportuno: megafonía, video, detección de humos, proyectores adicionales, downlights, ...

#### MODULE FOR ACCESSORIES\*

The module for accessories is supplied with a blank cover that can be easily cut by a saw as if it were a false ceiling, leaving an empty space for any desired device: speaker, video camera, smoke detector, spotlight, downlight, ...



altavoz, detectores de humo, ...  
speaker, smoke detector, ...

\* Para la incorporación de dispositivos consulte los requerimientos técnicos necesarios.

\* To incorporate external devices please check the technical requirements needed.



### MÓDULOS "T" Y "L"

Los módulos T y L permiten una gran versatilidad de instalación convirtiendo a LOMA en un sistema de iluminación y cableado vivo y dotándola de una infinidad de posibles configuraciones.

#### MODULES FOR T-SHAPED AND L-SHAPED CORNER JOINT

The corner joint modules confer great versatility to the LOMA lighting system and the wide range of accessories add many possible configurations for a multitude of lighting requirements.



### SISTEMA DE SUSPENSIÓN:

El sistema de suspensión mediante cables es regulable en altura (máx. 2,2m.) y permite un sencillo equilibrado de la luminaria en el espacio. Para otras longitudes consultar.

#### SUSPENSION SYSTEM:

The suspension system is adjustable in height (max. 2,2m) through cables allowing an easy adjustment and balance.

### ALIMENTACIÓN:

La acometida eléctrica se realiza mediante 1 o varias tomas de alimentación dependiendo de las características de la configuración.

#### POWER SUPPLY UNIT

The power supply connection is arranged through 1 or several units (take into account voltage drops).



### INTERCONEXIÓN MECÁNICA DE LOS MÓDULOS:

El acople entre los módulos se realiza mediante tornillería. La ejecución es sencilla y proporciona una unión firme y limpia.

#### THE MECHANICAL INTERCONNECTION OF THE MODULES:

The module coupling is easily arranged through different screws. It is trouble free and solid and reliable at the same time.



Gris / Grey



**MÓDULOS INDIVIDUALES:**  
**INDIVIDUAL MODULES:**

Módulo de suspensión. Equipado para tubos T5. Se suministra con testeros (tapas), toma de alimentación y cables de suspensión.  
Suspended module. Using T5 fluorescent lamps. Supplied with end caps and power supply unit with suspension cables.

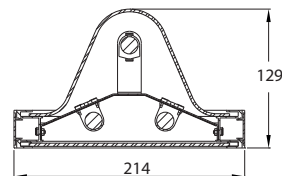

CÓDIGO CODE	COLOR COLOUR	LÁMPARA LAMP	VOLT. VOLT	W	HAZ BEAM	EQUIPO GEAR	INSTALACIÓN INSTALLATION	
SP-1801-N3-B9	●	T5 G5	230	3x39W	-			*
SP-1802-N3-B9	●	T5 G5	230	3x54W	-	Elect. Inc.		*
SP-1803-N3-B9	●	T5 G5	230	3x80W	-			*

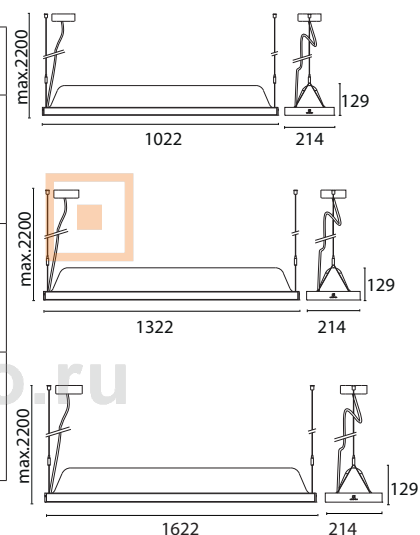

**MÓDULOS CENTRALES PARA LÍNEA CONTINUA:**  
**CENTRAL MODULES FOR LINED UP SERIES:**

Módulo de suspensión. Equipado para tubos T5. NO se incluyen los testeros (tapas), ni la toma de alimentación. A pedir separadamente.  
Suspended module. Using T5 fluorescent lamps. End caps and power supply unit NOT included (to be ordered separately).



CÓDIGO CODE	COLOR COLOUR	LÁMPARA LAMP	VOLT. VOLT	W	HAZ BEAM	EQUIPO GEAR	INSTALACIÓN INSTALLATION	
SP-1805-N3-B9	●	T5 G5	230	3x39W	-			*
SP-1806-N3-B9	●	T5 G5	230	3x54W	-	Elect. Inc.		*
SP-1807-N3-B9	●	T5 G5	230	3x80W	-			*

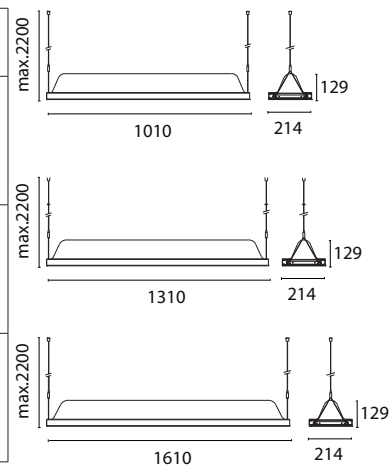

(\*). Consultar  
(\*). Consult

Para versiones con Regulación 1...10V, PUSH-PULL, DALI o con equipo de alimentación auxiliar tipo emergencia, rogamos consulten disponibilidad.

Dimmable 1...10V, Push-Pull, DALI or electronic with emergency lighting versions upon request.

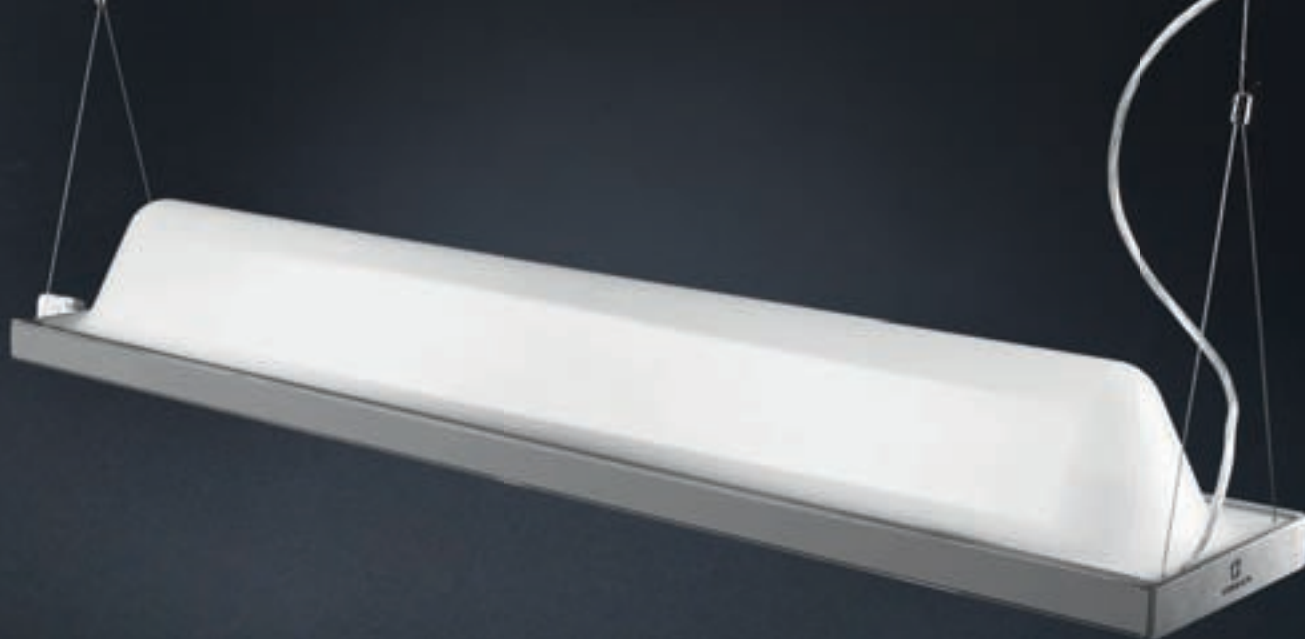

Florón  
Power supply unit

CÓDIGO CODE	COLOR COLOUR
ACT-9083-N3-00	●

Tapa final  
End cap

CÓDIGO CODE	COLOR COLOUR
ACT-9084-N3-00	●

Sirga  
Steel cable

CÓDIGO CODE	COLOR COLOUR
ACT-9085-N3-00	●

Cubrecables vertebral transparente  
Transparent vertebral cable wrap

CÓDIGO CODE
ACT-9086-00-00

L=720 mm

ACCESORIOS DE CONEXIÓN  
CONNECTING ACCESSORIES



MÓDULO DE UNIÓN Y/O INCORPORACIÓN DE DISPOSITIVOS  
MODULES TO COMBINE LUMINAIRES AND/OR INCORPORATE  
EXTERNAL DEVICES

Módulo en línea continua  
Lined up module

CÓDIGO CODE	COLOR COLOUR
ACT-9080-N3-B9	●

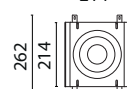

Módulo para curvado en codo forma "L" (90°)  
Module for L-shaped corner joint (90°)

CÓDIGO CODE	COLOR COLOUR
ACT-9081-N3-B9	●

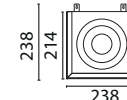
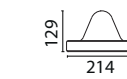

Módulo para derivación en forma de "T"  
Module for T-shaped corner joint (3 way)

CÓDIGO CODE	COLOR COLOUR
ACT-9082-N3-B9	●

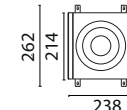
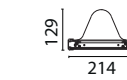

FILTROS DE COLORES  
COLOUR FILTERS

Filtro T5 color verde / Green colour T5 filter

CÓDIGO CODE	COLOR COLOUR
ACT-9087-08-00	●

Filtro T5 color azul / Blue colour T5 filter

CÓDIGO CODE	COLOR COLOUR
ACT-9087-11-00	●

Filtro T5 color amarillo / Yellow colour T5 filter

CÓDIGO CODE	COLOR COLOUR
ACT-9087-24-00	●

Filtro T5 color rojo / Red colour T5 filter

CÓDIGO CODE	COLOR COLOUR
ACT-9087-25-00	●



/LOMA/



MODUL

ELECTRO

[www.modulelectro.ru](http://www.modulelectro.ru)

/128





**MODULO**  
ELECTRO  
[www.modulelectro.ru](http://www.modulelectro.ru)



Gr. COUTAL SA  
1 5 4 5  
9 10 11 17  
16 17 18 1  
P. 252

# MODUL

ELECTRO

[www.modulselectro.ru](http://www.modulselectro.ru)

# LOMA

LOMA

Sistema Loma con filtro de color.  
Loma system with colour filter.





**MODUL**  
ELECTRO

[www.modulelectro.ru](http://www.modulelectro.ru)

sistemas de fluorescencia lineal suspendida / fluorescent linear lighting systems

arquitectural

131



/132

# /SUSPENDIDOS/



filipa



**MODULO**  
ELECTRO  
[www.modulselectro.ru](http://www.modulselectro.ru)

suspendidos / suspended

arquitectural

/133

*/suspended*

 **MODUL**   
ELECTRO  
[www.modulelectro.ru](http://www.modulelectro.ru)

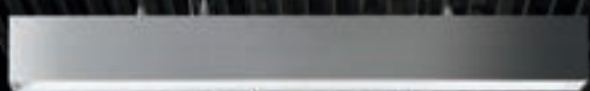

# /RECTA

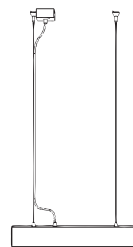
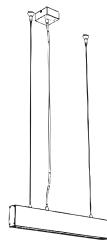

## DESCRIPCIÓN / DESCRIPTION

Tres versiones para satisfacer las más variadas aplicaciones y necesidades lumínicas:

**RECTA S**, una suspensión de perfil rectangular y cuidado diseño, fabricada en extrusión de aluminio y disponible para lámpara fluorescente tubular TL5 H.O.

**RECTA T**, es la versión para montaje adosado en techo. Misma estética y características técnicas.

**RECTA W**, es la versión aplique de pared. Cuerpo en aluminio extruido y difusores en policarbonato que proporcionan una distribución de la luz en los dos sentidos (arriba y abajo).

Todas las luminarias se suministran completas con lámpara y equipo electrónico.

*Three versions available to cover the most applications and lighting needs: RECTA S, a suspended luminaire with rectangular profile and cared design, made of extruded aluminium and available for TL5 H.O. fluorescent lamps. RECTA T is the surface mounted version. Same aesthetics and technical characteristics.*

*RECTA W, is the wall mounted version of the family. The housing is made of extruded aluminium and has 2 polycarbonate diffusers for distributing the light up and down.*

*All luminaires are delivered complete, with lamp and electronic gear integrated in the housing.*

## APLICACIÓN / APPLICATIONS

Luminarias para ser utilizadas en cualquier proyecto de iluminación general o ambiental en zonas comerciales, oficinas, hoteles, y también para ser usadas como iluminación de zonas específicas de trabajo donde se necesite un nivel lumínico superior al de la iluminación general – recepciones, mostradores, etc.

*Luminaires to be used in any general or environmental lighting project in shops, offices, hotels, etc., and also as task lighting in receptions, counters, cashiers, etc.*







Gris / Grey



Lámpara color 840 included.  
840 colour lamp included.

Suspensión decorativa para TL5 H.O. Luz directa.  
Decorative suspended luminaire for TL5 H.O. Direct light.

C6D160 CODE	COLOR COLOUR	LÁMPARA LAMP	VOLT. VOLT	W W	HAZ BEAM	EQUIPO GEAR	INSTALACIÓN INSTALLATION	
SP-0654-N3-B9	●	TL5 G5	230	24W	-			73
SP-0655-N3-B9	●	TL5 G5	230	39W	-	Elect. inc.		74
SP-0656-N3-B9	●	TL5 G5	230	54W	-			75

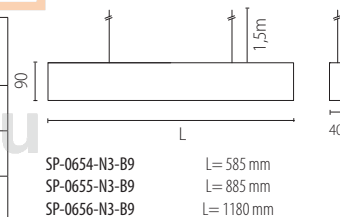

Luminaria de montaje en superficie para TL5 H.O. Luz directa.  
Surface mounted luminaire for TL5 H.O. Direct light.

C6D160 CODE	COLOR COLOUR	LÁMPARA LAMP	VOLT. VOLT	W W	HAZ BEAM	EQUIPO GEAR	INSTALACIÓN INSTALLATION	
SP-0658-N3-B9	●	TL5 G5	230	24W	-			76
SP-0659-N3-B9	●	TL5 G5	230	39W	-	Elect. inc.		77
SP-0660-N3-B9	●	TL5 G5	230	54W	-			78

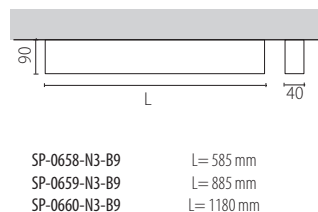

Luminaria de montaje como aplique de pared para TL5 H.O. Luz directa e indirecta.  
Wall mounted luminaire for TL5 H.O. Direct and indirect light.

C6D160 CODE	COLOR COLOUR	LÁMPARA LAMP	VOLT. VOLT	W W	HAZ BEAM	EQUIPO GEAR	INSTALACIÓN INSTALLATION	
SP-0650-N3-B9	●	TL5 G5	230	24W	-			70
SP-0651-N3-B9	●	TL5 G5	230	39W	-	Elect. inc.		*
SP-0652-N3-B9	●	TL5 G5	230	54W	-			72

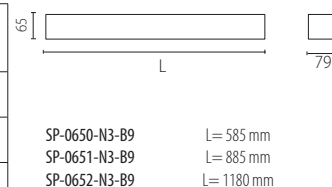

(\*) Consultar  
(\*) Consult



suspensionados / suspended

arquitectural

**MODUL**  
ELECTRO  
[www.modulelectro.ru](http://www.modulelectro.ru)

/137



La versión de pared distribuye la luz para arriba y para abajo proporcionando una perfecta iluminación ambiental.

Wall mounted versions give light up and down providing a perfect environmental lighting.



**MODUL**  
ELECTRO  
[www.modulelectro.ru](http://www.modulelectro.ru)

# /FILIPA

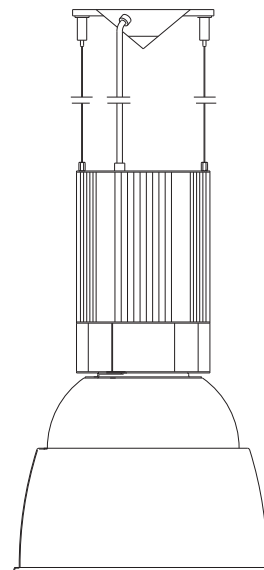
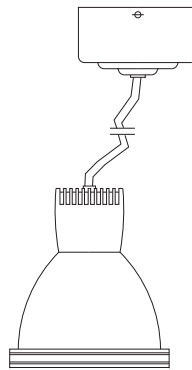

Tres versiones para satisfacer las más variadas aplicaciones y necesidades lumínicas: **FILIPA SMALL**, una suspensión de reducido tamaño y excelente diseño, disponible para lámpara halógena QT-TC con transformador incluido, totalmente fabricada en aluminio. Equipo de funcionamiento a pedir separadamente.

**FILIPA MEDIUM SEMITRANSLUCIDA**, una suspensión pequeña y armoniosa, disponible para lámpara halógena MASTERline-TC (transformador electrónico integrado en el cuerpo de la luminaria) o para lámpara fluorescente compacta E27, cuyo reflector tipo campana está compuesto por dos partes: la superior en cristal templado arenado y la inferior en aluminio anodizado con acabado facetado.

**FILIPA PROFESIONAL**, una suspensión de tamaño mediano, disponible para lámpara de halogenuros HIT-T de 70W (equipo magnético o electrónico incorporado) o para lámpara fluorescente compacta PL-H (equipo electrónico incorporado) y E-27. Reflector tipo campana en tres versiones diferentes:

- compuesto por dos partes: la superior en cristal templado mate y la inferior en aluminio anodizado con acabado facetado.
- aluminio anodizado exterior e interior lacado en blanco
- policarbonato prismático con marco inferior en aluminio inyectado color gris.

*Three versions available to cover the most applications and lighting needs:*

*FILIPA SMALL, a suspended luminaire of very reduced size, totally made of aluminium and available for halogen lamp QT-TC. Electronic transformer included.*

*FILIPA MEDIUM SEMITRANSLUCED, a small and harmonious suspended luminaire, available for MASTERline-TC halogen lamp (electronic transformer integrated in the housing) or for compact fluorescent with E27 base, which reflector is composed of two parts: top reflector made of matt glass and bottom reflector in faceted anodised aluminium.*

*FILIPA PROFESSIONAL, a medium sized suspension, available for HIT-T 70W (magnetic or electronic gear supplied in the housing) or for the fluorescent compact PL-H (electronic gear included in the housing) and E-27. Reflectors available in three different versions:*

- composed of two parts: top reflector made of white matt glass and bottom reflector in faceted anodised aluminium
- anodised aluminium in the outside and white lacquered in the inside
- prismatic polycarbonate with grey injected aluminium lower trim

## APLICACIÓN / APPLICATIONS

Luminarias para ser utilizadas en cualquier proyecto de iluminación general o ambiental en zonas comerciales, oficinas, hoteles, y también para ser usadas como iluminación de zonas específicas de trabajo donde se necesite un nivel lumínico superior al de la iluminación general – recepciones, mostradores, etc.

*Luminaires to be used in any general or environmental lighting project in shops, offices, hotels, etc., and also as task lighting in receptions, counters, cashiers, etc.*





●  
Gris / Grey



Luminaria suspendida para PL-H, HIT-T o E-27.  
Suspended luminaire for PL-H, HIT-T lamp or E-27.

Reflector aluminio facetado + cristal opal.  
Faceted aluminium reflector + opal glass.



CÓDIGO CODE	COLOR COLOUR	LÁMPARA LAMP	VOLT. VOLT	W W	HAZ BEAM	EQUIPO GEAR	INSTALACIÓN INSTALLATION	
SP-0089-N3-B9	●	HIT-T G12	230	70W	-	Mag. inc		84
SP-0090-N3-B9	●	HIT-T G12	230	70W	-	Elect. inc		84
SP-0091-N3-B9	●	PL-H 2G8	230	max. 120W	-	-		85
SP-0092-N3-B9	●	E-27	230	max. 150W	-	-		*

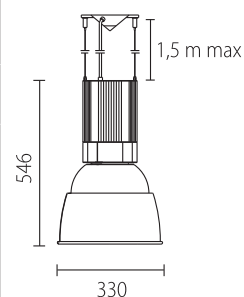

Luminaria suspendida para PL-H, HIT-T o E-27.  
Suspended luminaire for PL-H, HIT-T or E-27 lamp.

Reflector aluminio anodizado + cristal opal.  
Anodised aluminium reflector + opal glass.

CÓDIGO CODE	COLOR COLOUR	LÁMPARA LAMP	VOLT. VOLT	W W	HAZ BEAM	EQUIPO GEAR	INSTALACIÓN INSTALLATION	
SP-0089-N3-S2	●	HIT-T G12	230	70W	40°	Mag. inc		86
SP-0090-N3-S2	●	HIT-T G12	230	70W	40°	Elect. inc		86
SP-0091-N3-S2	●	PL-H 2G8	230	max. 120W	120°	-		*
SP-0092-N3-S2	●	E-27	230	max. 150W	60°	-		131

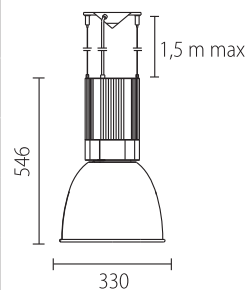

Luminaria suspendida para PL-H, HIT-T o E-27.  
Suspended luminaire for PL-H, HIT-T or E-27 lamp.

Reflector en policarbonato.  
Polycarbonate reflector.

CÓDIGO CODE	COLOR COLOUR	LÁMPARA LAMP	VOLT. VOLT	W W	HAZ BEAM	EQUIPO GEAR	INSTALACIÓN INSTALLATION	
SP-0089-N3-37	●	HIT-T G12	230	70W	80°	Mag. inc		128
SP-0090-N3-37	●	HIT-T G12	230	70W	-	Elect. inc		129
SP-0091-N3-37	●	PL-H 2G8	230	max. 120W	120°	-		130
SP-0092-N3-37	●	E-27	230	max. 150W	-	-		*

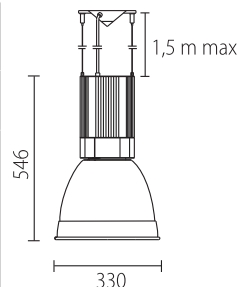

Cierre incluido en versión reflector en policarbonato.  
Luminaire cover included for the polycarbonate reflector's version.

(\*) Consultar  
(\*) Consult





**MODUL**  
ELECTRO

www.modulelectro.ru



Luminaria suspendida para QT-TC.  
Decorative suspended luminaire for QT-TC lamp.

Reflector aluminio.  
Aluminium reflector.



CÓDIGO CODE	COLOR COLOUR	LAMPARA LAMP	VOLT. VOLT	W W	HAZ BEAM	EQUIPO GEAR	INSTALACIÓN INSTALLATION	
SP-0108-N3-37	●	QT-TC G8.5	230	max. 60W	45°			132

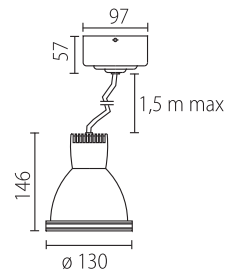

Luminaria suspendida para E-27 o QT-TC.  
Decorative suspended luminaire for E-27 or QT-TC lamp.

Reflector aluminio facetado + cristal opal.  
Faceted aluminium reflector + opal glass.



CÓDIGO CODE	COLOR COLOUR	LAMPARA LAMP	VOLT. VOLT	W W	HAZ BEAM	EQUIPO GEAR	INSTALACIÓN INSTALLATION	
SP-0087-N3-B9	●	QT-TC G8.5	12	max. 60W	80°			83
SP-0088-N3-B9	●	E-27	230	max. 60W	80°	-		*

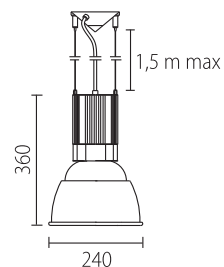

(\*) Consultar  
(\*) Consult



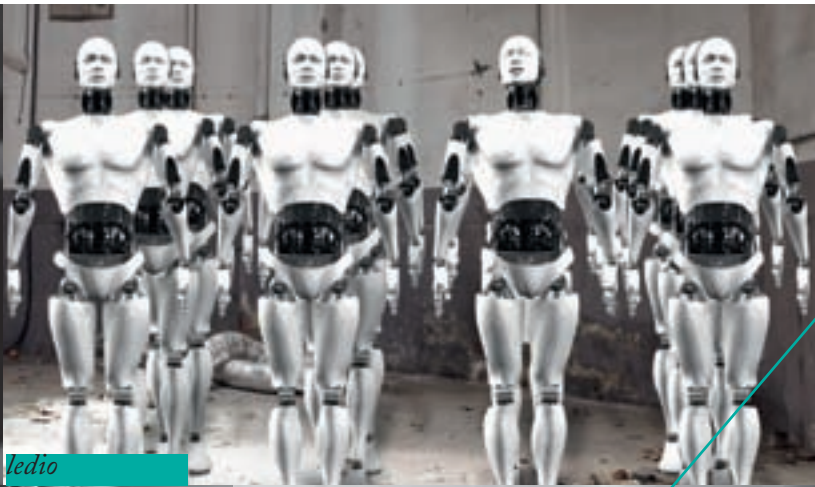
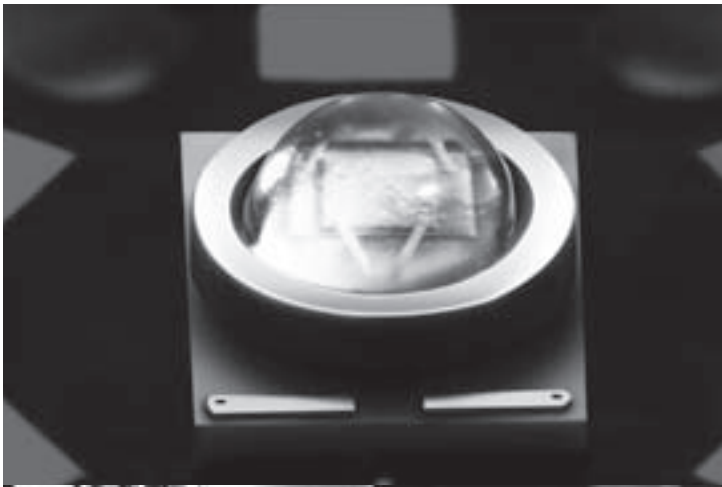

ledio



MODULO  
ELECTRO  
www.modulelectro.ru

/142



/LED

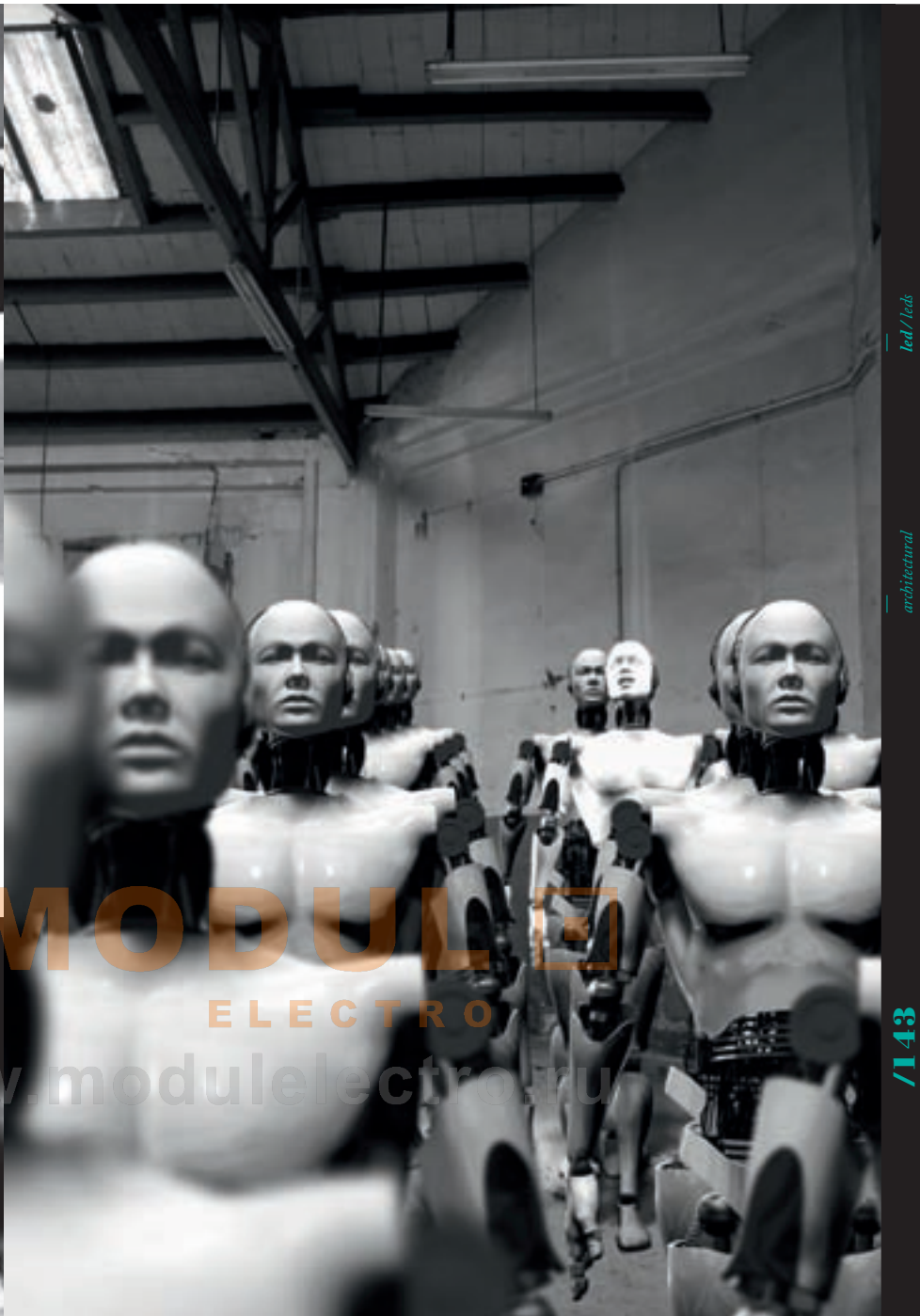

**MODUL**  
ELECTRO  
[www.modulelectro.ru](http://www.modulelectro.ru)





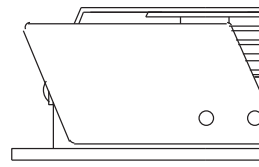
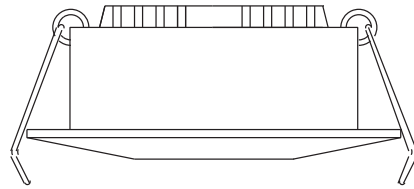

## DESCRIPCIÓN / DESCRIPTION

Las luminarias que componen esta familia están fabricadas con materiales de la más alta calidad, especificados en cada una de las descripciones de producto.

Diferentes versiones, potencias y sistemas de montaje – downlights, empotrables con elevado IP, apliques de pared, suspendidos – posibilitan la combinación de diferentes aparatos para la creación de ambientes y una perfecta integración en los mismos.

*All luminaires composing this family are manufactured with materials of the highest quality, specified in each individual product description.*

*Different versions, wattages and mounting systems – downlights, high IP grade recessed luminaires, wall mounting, suspended mounting – give the possibility to combine different fixtures to create personalised environments and the perfect integration of the luminaires.*

## APLICACIÓN / APPLICATIONS

Luminarias para ser utilizadas, aisladas o combinadas entre si, en cualquier proyecto de iluminación – tiendas de ropa, joyerías, cafeterías, hoteles – donde la creación de ambientes específicos y la señalización sean los principales requerimientos.

*Luminaires to be used alone or combined among them in any lighting project – fashion shops, jewellery shops, coffee shops, hotels – where the creation of specific environments and the adequate signalling are the main requirements.*

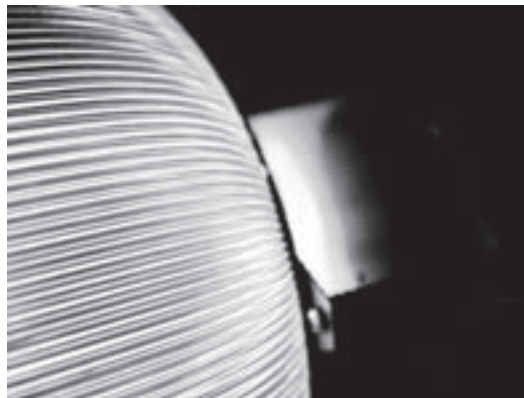

# /LEDIO/

Ver fotometrías en página 214 y tabla de equivalencias de lámparas en página 223.

See Photometric data on page 214 and equivalent lamps table on page 223.



Aluminio cepillado /  
Polished aluminium



Gris / Grey



Downlight fijo semi-empotrado para PowerLed. 350 mA  
Semi-recessed downlight for PowerLed. 350 mA



CÓDIGO CODE	COLOR COLOUR	LÁMPARA LAMP	VOLT. VOLT	W W	HAZ BEAM	EQUIPO GEAR	INSTALACIÓN INSTALLATION	
DN-0470-S2-00 (5500-6000°K)	●	POWERLED <sup>(2)</sup>	-	1W	15°	Not inc		49
DN-0510-S2-00 (3000-3500°K)	●	POWERLED <sup>(2)</sup>	-	1W	15°			49

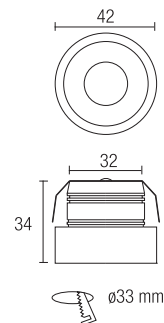

Base de montaje en superficie para dos DN-0470 o DN-0510  
Surface mounted base for 2xDN-0470 or 2xDN-0510



ELECTRO

CÓDIGO CODE	COLOR COLOUR	LÁMPARA LAMP	VOLT. VOLT	W W	HAZ BEAM	EQUIPO GEAR	INSTALACIÓN INSTALLATION	
ACT-0458-N3-00	●		-	-	-	Elect. inc		-

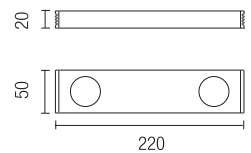

Downlight orientable para un PowerLed. 350 mA  
Adjustable downlight for PowerLed. 350 mA



CÓDIGO CODE	COLOR COLOUR	LÁMPARA LAMP	VOLT. VOLT	W W	HAZ BEAM	EQUIPO GEAR	INSTALACIÓN INSTALLATION	
DN-0472-S2-00 (5500-6000°K)	●	POWERLED <sup>(2)</sup>	-	1W	15°	Not inc		49
DN-0511-S2-00 (3000-3500°K)	●	POWERLED <sup>(2)</sup>	-	1W	15°			49

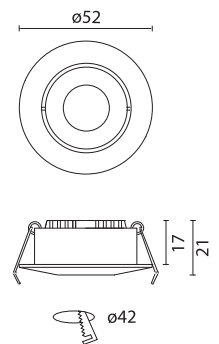

Downlight orientable para 3 PowerLed. 350 mA  
Adjustable downlight for 3 PowerLed. 350 mA



CÓDIGO CODE	COLOR COLOUR	LÁMPARA LAMP	VOLT. VOLT	W W	HAZ BEAM	EQUIPO GEAR	INSTALACIÓN INSTALLATION	
DN-0297-N3-00 (5500-6000°K)	●	POWERLED <sup>(2)</sup>	-	3x1W	15°	Not inc		49
DN-0512-N3-00 (3000-3500°K)	●	POWERLED <sup>(2)</sup>	-	3x1W	15°			49

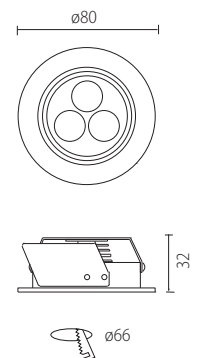

(2) LED suministrado con el aparato.  
(2) LED included with the luminaire.

Ver drivers de 350 mA en página 194  
See 350 mA drivers in page 194



Empotrable para PowerLed. 350 mA  
Recessed downlight for PowerLed. 350 mA



CÓDIGO CODE	COLOR COLOUR	LÁMPARA LAMP	VOLT. VOLT	W W	HAZ BEAM	EQUIPO GEAR	INSTALACIÓN INSTALLATION	
DN-0289-N3-00	●	POWERLED <sup>(2)</sup>	-	1W	50°	Not inc		50
DN-0290-N3-00	●	POWERLED <sup>(2)</sup>	-	1W	50°			50

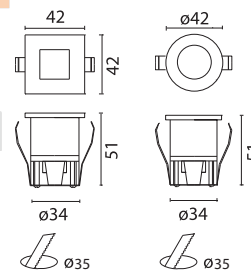

Empotrable de suelo para PowerLed.  
Floor recessed luminaire for PowerLed.



CÓDIGO CODE	COLOR COLOUR	LÁMPARA LAMP	VOLT. VOLT	W W	HAZ BEAM	EQUIPO GEAR	INSTALACIÓN INSTALLATION	
EP-0506-00-B9	-	POWERLED <sup>(2)</sup>	-	3W	50°	Elect. inc		133

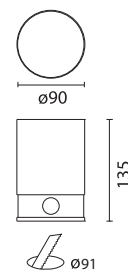

(2) LED suministrado con el aparato.  
(2) LED included with the luminaire.

Ver drivers de 350 mA en página 194  
See 350 mA drivers in page 194



Empotrable de suelo con un innovador sistema de montaje, sin marco exterior, que permite que el aparato quede perfectamente integrado en el suelo, haciéndolo ideal para la definición e indicación de rutas peatonales no sólo en interiores sino también en exteriores.

Floor recessed luminaire with an innovative mounting system, without outer obtrusive trim, which allows the luminaire to be perfectly integrated in the floor. Ideal for definition and indication of pedestrian routes either in indoor or outdoor applications.



Aluminio cepillado /  
Polished aluminium

/148

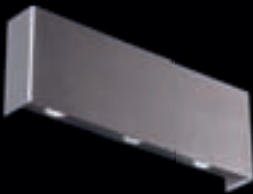

Aplique de pared para 1 PowerLed.  
Small decorative luminaire for 1 PowerLed.



CÓDIGO CODE	COLOR COLOUR	LÁMPARA LAMP	VOLT. VOLT	W W	HAZ BEAM	EQUIPO GEAR	INSTALACIÓN INSTALLATION	
AP-0501-S2-00		POWERLED (2) (5500-6000 k)	-	1W	15°	Elect. inc		49

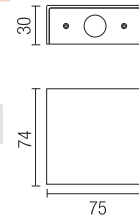

Aplique de pared para 3 PowerLed.  
Small decorative luminaire for 3 PowerLed.

CÓDIGO CODE	COLOR COLOUR	LÁMPARA LAMP	VOLT. VOLT	W W	HAZ BEAM	EQUIPO GEAR	INSTALACIÓN INSTALLATION	
AP-0503-S2-00		POWERLED (2) (5500-6000 k)	-	3x1W	15°	Elect. inc		49

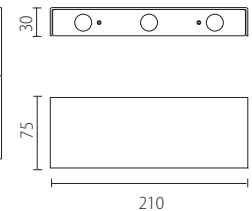

Mini suspensión para PowerLed de 3W.  
Small decorative pendant for 3W PowerLed.

CÓDIGO CODE	COLOR COLOUR	LÁMPARA LAMP	VOLT. VOLT	W W	HAZ BEAM	EQUIPO GEAR	INSTALACIÓN INSTALLATION	
SP-0100-S2-00		POWERLED (2) (5500-6000 k)	-	3W	15°	Elect. inc		51

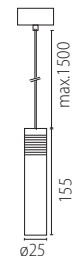

(2) LED suministrado con el aparato.  
(2) LED included with the luminaire.



**MODUL**  
ELECTRO  
[www.modulelectro.ru](http://www.modulelectro.ru)

led / leds

architectural

**MODUL**  
ELECTRO  
[www.modulelectro.ru](http://www.modulelectro.ru)

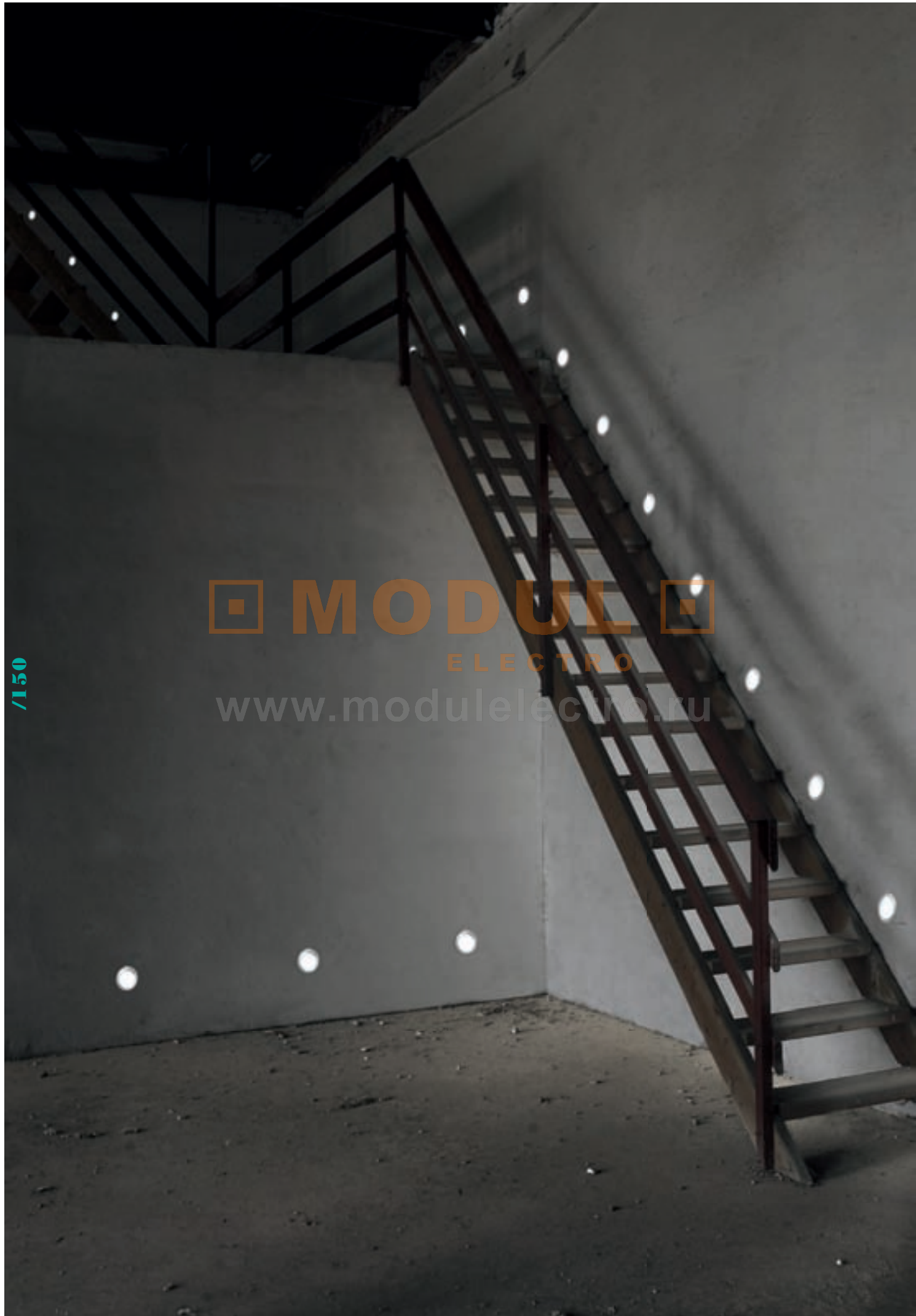

# /BIT/

# /PETIT/

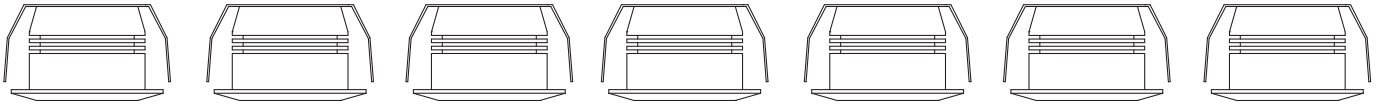

led / leds

architectural

## MODULO

ELECTRO

[www.modulelectro.ru](http://www.modulelectro.ru)

/151

### BIT

Mini downlight led con efecto de concentración lumínica de alta versatilidad. Realizado con cuerpo de aluminio mecanizado de alta pureza, incorpora un kit de 2 ópticas fácilmente intercambiables entre ellas.

**Dos colores de luz blanca para una perfecta conciliación a los diferentes ambientes.**

*A miniature led downlight featuring a highly versatile concentrated light effect. Executed with a body of very pure worked aluminium. It includes a kit of 2 easily interchangeable lenses.*

*Two white light colours for perfect adaptation to different environments.*

### PETIT

Mini punto de luz led decorativo, perfecto para la señalización arquitectural. Fabricado en policarbonato, aluminio y cristal translúcido que le proporcionan una alta estanqueidad y una protección anticorrosivo.

*A miniature decorative led light point, perfect for architectural signposting. Made of polycarbonate, aluminium and translucent glass, they provide a high level of water protection and protection against corrosion.*

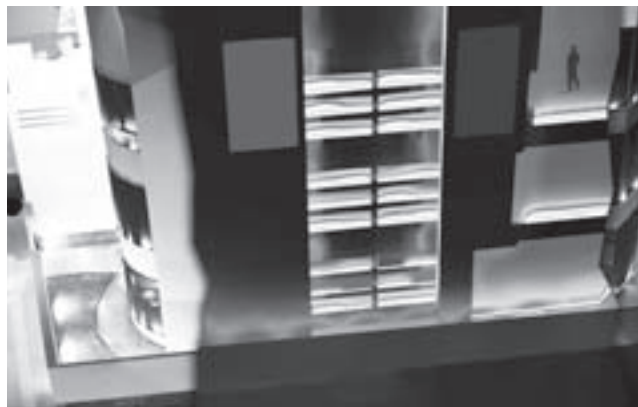





Aluminio cepillado /  
Polished aluminium



Mini downlight.  
Mini downlight.

# MODUL

## ELECTRO



CÓDIGO CODE	COLOR COLOUR	LAMPARA LAMP	VOLT. VOLT	W		HAZ BEAM	EQUIPO GEAR	INSTALACIÓN INSTALLATION	
				350 MA	700 MA				
05-3307-S2-00 Cold W / Frio 6000k		POWERLED <sup>(2)</sup>	-						
05-3308-S2-00 Warm W / Cálido 2900k		POWERLED <sup>(2)</sup>	-	1W	3W				101

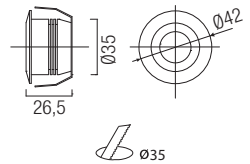

93,9  
Lm/watt

6000K

Luz fría  
Cold light

80,6  
Lm/watt

2900K

Luz cálida  
Warm light



(2) LED suministrado con el aparato.  
(2) LED included with the luminaire.

Equipo no incluido, a pedir separadamente, ver pág. 194  
Gear not included, to be ordered separately, see page 194

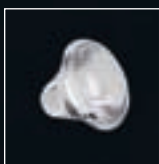

Kit de ópticas (incluidas) de diferentes ángulos de apertura para la personalización del flujo luminoso de las luminarias: 25° y 40°. Estas fabricadas en PMMA, material idóneo para el control de la luz.

A lens kit of different angles (included) for the personalisation of light flows: 25 ° and 40 °. These are made of PMMA, an ideal material for light control.

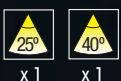

### DRIVERS

#### 350mA

ACT-0803-00-00 (1 a 3 piezas / 1 to 3 pieces)  
ACT-0804-00-00 (1 a 4 piezas / 1 to 4 pieces)  
ACT-0808-00-00 (1 a 8 piezas / 1 to 8 pieces)  
ACT-0816-00-00 (1 a 18 piezas / 1 to 18 pieces)

#### 700mA

71-3305-00-00, 71-3306-00-00 (1 pieza / 1 piece)  
71-3307-00-00 (1 a 4 piezas / 1 to 4 pieces)  
71-3308-00-00 (1 a 6 piezas / 1 to 6 pieces)

# /PETIT/



Gris / Grey

led / leds

architectural

## MODULO ELECTRO

[www.modulelectro.ru](http://www.modulelectro.ru)



Mini punto de luz decorativo.  
A miniature decorative led light point.



CÓDIGO CODE	COLOR COLOUR	LÁMPARA LAMP	VOLT. VOLT	W W	HAZ BEAM	EQUIPO GEAR	INSTALACIÓN INSTALLATION	
55-3401-N3-M3	●	SMDLED	-	0,1W	-	Not inc		

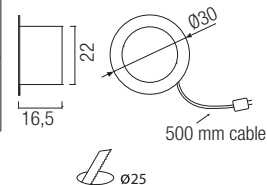

Luz fría  
Cold light

Driver (Máx. 6 un.)  
Driver (Max. 6 un.)

CÓDIGO CODE
71-3318-00-00

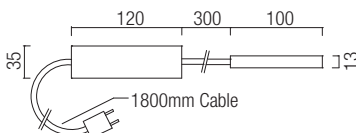

/153

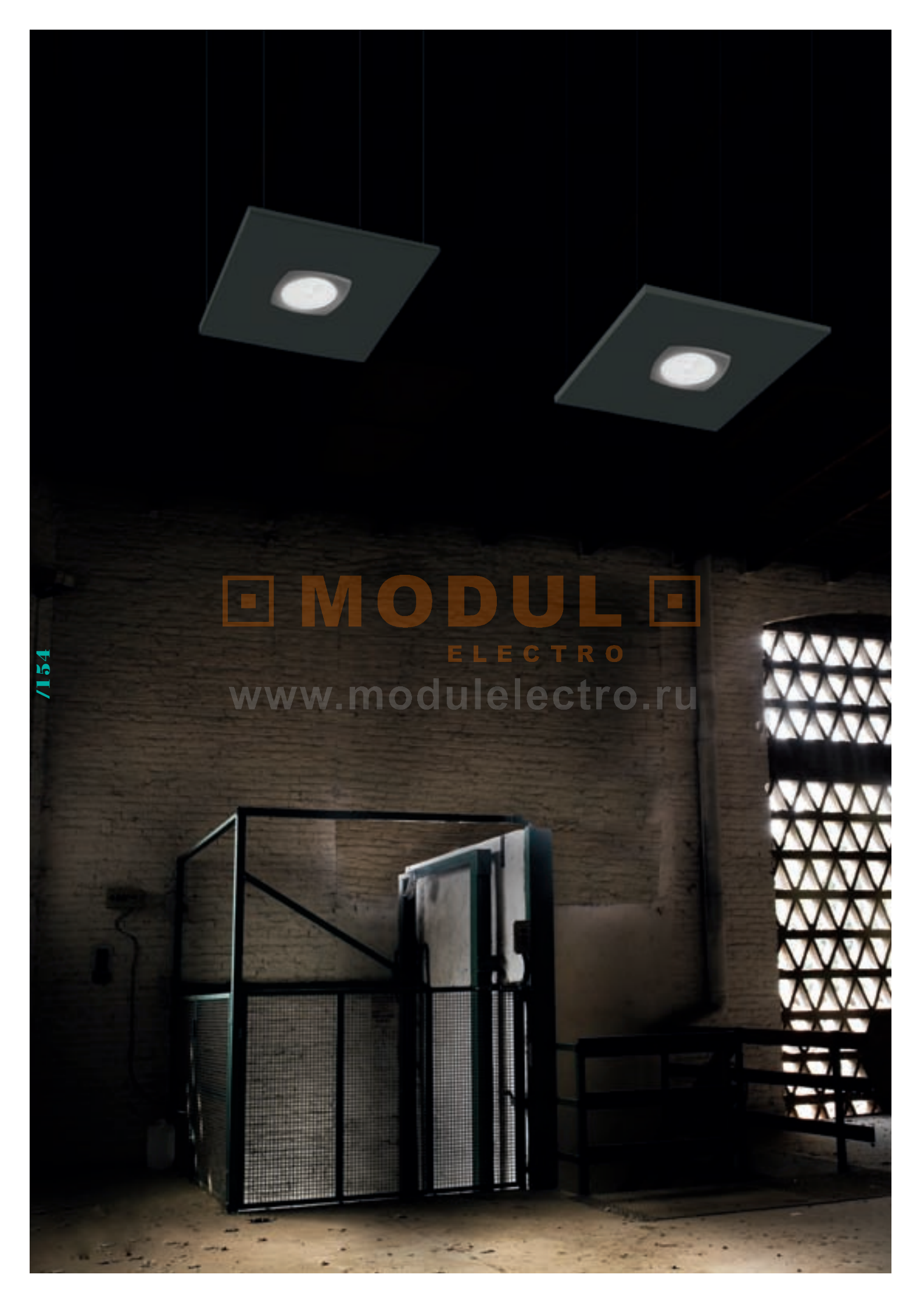

**MODUL**  
ELECTRO  
[www.modulelectro.ru](http://www.modulelectro.ru)

# /DELTA/

# /SOUND/

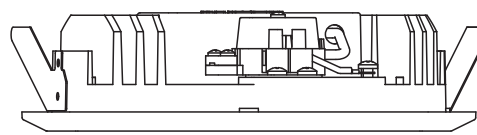
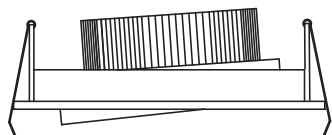

led / leds

architectural

## MODUL

### ELECTRO

#### DELTA

Downlight con diseño exclusivo compuesto de 6 o 9 leds. Puede conectarse a 350mA y a 500mA, con un rendimiento máximo de 18W. Ópticas intercambiables para ajustarse perfectamente a las necesidades del cliente.

*A downlight featuring an exclusive design of 6 or 9 leds. It can be connected to 350mA and to 500mA, with a maximum output of 18W. Interchangeable lenses to suit clients' needs perfectly.*

#### SOUND

Downlight de alta eficiencia con tecnología led de última generación, cuerpo inyectado en aluminio de alta densidad y disipador de temperatura laminar. La luminaria incluye un sistema de conexión a la red eléctrica y un controlador de equipo. Diseño único y vanguardista, disponible en diferentes acabados, tonalidad de luz blanca, con versiones empotrado y de superficie para satisfacer todas las necesidades.

*High efficiency downlight with latest generation led technology, featuring a body made of high-density injected aluminium and laminated heat sink. The lighting includes a rapid connection system to the electrical network and a equipment controller. It boasts a unique, cutting edge design available in different finishes, tones of white light, with fitted and surface versions to meet all needs.*

/155





Aluminio cepillado-Blanco/  
Brushed aluminium-White



Aluminio cepillado-Gris/  
Brushed aluminium-Grey

## DELTA 6

Downlight con diseño exclusivo compuesto de 6 leds.  
A downlight featuring an exclusive design of 6 leds.



CÓDIGO CODE	COLOR COLOUR	LÁMPARA LAMP	VOLT. VOLT	W		HAZ BEAM	EQUIPO GEAR	INSTALACIÓN INSTALLATION	
				350 MA	500 MA				
90-3427-S2-14 Warm W / Cálido 2900k		POWERLED	-	6W	12W	-	Not inc		103
90-3427-S2-N3 Warm W / Cálido 2900k		POWERLED	-						103

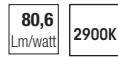
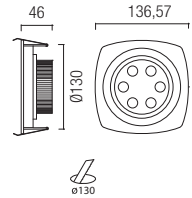

Luz cálida  
Warm light



Equipo no incluido, a pedir separadamente, ver pág. 194  
Gear not included, to be ordered separately, see page 194



## DELTA 9

Downlight con diseño exclusivo compuesto de 9 leds.  
A downlight featuring an exclusive design of 9 leds.



CÓDIGO CODE	COLOR COLOUR	LÁMPARA LAMP	VOLT. VOLT	W		HAZ BEAM	EQUIPO GEAR	INSTALACIÓN INSTALLATION	
				350 MA	500 MA				
90-3428-S2-14 Warm W / Cálido 2900k		POWERLED	-	9W	18W	-	Not inc		104
90-3428-S2-N3 Warm W / Cálido 2900k		POWERLED	-						104

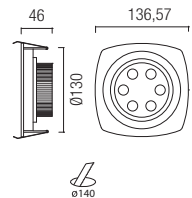

Luz cálida  
Warm light

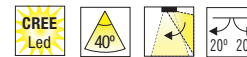

Equipo no incluido, a pedir separadamente, ver pág. 194  
Gear not included, to be ordered separately, see page 194

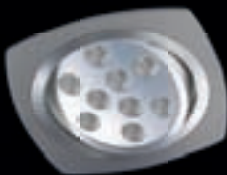

Kit de ópticas (50 un. de cada incluidas) de diferentes ángulos de apertura para la personalización del flujo luminoso de las luminarias: 15°, 25°, 60° y 80°. Están fabricadas en PMMA, material idóneo para el control de la luz.  
Kit of lenses of different angles (50 pcs. each included) for the personalisation of light flows: 15°, 25°, 60° and 80°. These are made of PMMA, an ideal material for light control.

- 71-3325-00-00
- 71-3326-00-00
- 71-3328-00-00
- 71-3329-00-00

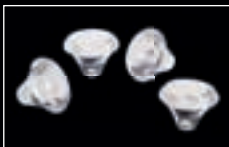

Disipador de temperatura tubular. Fabricado en aluminio mecanizado de alta densidad e integrado en la luminaria. Garantiza la correcta T° de trabajo de los led.

A tubular heat sink. Made of high density worked aluminium and incorporated into the lighting. It guarantees the correct led working temperature.

### DRIVERS

#### 350mA

ACT-0808-00-00 (1 pieza / 1 piece)

ACT-0816-00-00 (1 a 3 piezas / 1 to 3 pieces)

#### 500mA

71-3309-00-00 (1 pieza / 1 piece)

# /SOUND/

Ver fotometrías en página 214 y tabla de equivalencias de lámparas en página 223.

See Photometric data on page 214 and equivalent lamps table on page 223.

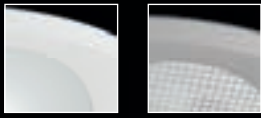

Blanco / White      Gris / Grey



M3      M2  
Cristal extra blanco/  
Extra white glass      PMMA / PMMA



led / leds

architectural



Downlight de alta eficiencia con tecnología led de última generación.  
High efficiency downlight with latest generation led technology.



	CÓDIGO CODE	COLOR COLOUR	LÁMPARA LAMP	VOLT. W* VOLT. W*	HAZ BEAM	EQUIPO GEAR	INSTALACIÓN INSTALLATION		
Cold W / Frío 6000k	90-3430-14-M3	○	SMDLED	- 15W		Elect. inc		108	
	90-3430-14-M2	○	SMDLED	- 15W				107	
	90-3430-N3-M3	●	SMDLED	- 15W				108	
	90-3430-N3-M2	●	SMDLED	- 15W				107	
Warm W / Cálido 2900k	90-3429-14-M3	○	SMDLED	- 15W					106
	90-3429-14-M2	○	SMDLED	- 15W				105	
	90-3429-N3-M3	●	SMDLED	- 15W				106	
	90-3429-N3-M2	●	SMDLED	- 15W				105	

96  
Lm/watt

64  
Lm/watt

6000K

2900K



Luz fría  
Cold light

Luz cálida  
Warm light

\* Potencia Total=Potencia LEDs + Potencia fuente alimentación. 15W=11W+4W.

\* Total Power = LED's power + Driver's power. 15W=11W+4W.

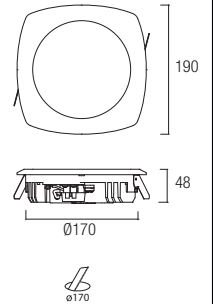

/157



Disipador de temperatura laminar, integrado en la misma carcasa de la luminaria. Fabricado en aluminio de alta pureza para garantizar la correcta Tº de trabajo de los led.

A laminated heat sink, built into the body of the lighting. Made of high quality injected aluminium. It guarantees the correct led working temperature.



Kit de superficie  
Surface kit

CÓDIGO CODE
71-3301-14-00

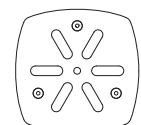
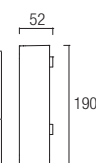



 **MODUL**   
ELECTRO

[www.modulelectro.com](http://www.modulelectro.com)

/158

# /EMPOTRABLES DE PARED



clam

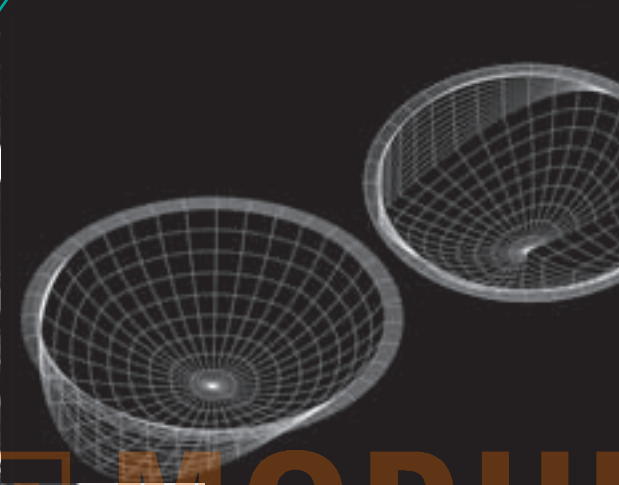

**MODUL**

ELECTRO

[www.modulelectro.ru](http://www.modulelectro.ru)

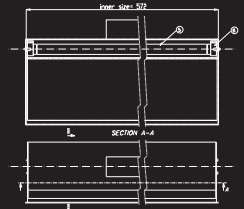

empotrables de pared / wall recessed

arquitectural

/159

*/wall recessed*





MODUL

www.modullectro.ru

LECTRO

# /CLAM/

Design by:  
PABLO MARTINEZ



empotrables de pared / wall recessed

arquitectural

## DESCRIPCIÓN / DESCRIPTION

Cuerpo metálico acabado en pintura epoxi de color blanco. Vano óptico realizado en chapa doblada con acabado blanco, con reflector incorporado de aluminio de alta pureza (99%). Disponible en 2 diámetros: 200 y 400mm. con fuentes de luz FLC y Halógenas (para versión LED RGB consultar).

El cuerpo va fijado a un marco de pre-instalación suministrado (ver instrucciones de montaje en pág.199) que permite la rotación de la luminaria para un enfoque óptimo del flujo luminoso a la vez que integra la pieza perfectamente en el entorno (concepto trimless). Los equipos quedan suspendidos del chasis del vano óptico facilitando la instalación y mantenimiento de los mismos.

CLAM ha nacido para integrarse en la arquitectura. Su concepto Trimless aunado a su mínima profundidad de instalación le permite ser instalado en muros tipo Pladur de 15 mm.

*Metallic body finished in white epoxy paint. Optic device made of steel with a high purity anodised aluminium reflector (99%).*

*Available in 2 diameters: 200 and 400mm. and 3 different lamp sources: CFL and halogen (for RGB LED version please advise).*

*The housing is fixed onto the supplied mounting kit (see page 199) allowing the rotation of the fitting and its output while integrating it on the wall. The gear hangs from the optic device housing to facilitate installation and maintenance.*

*CLAM means architecture's integration. Its Trimless concept together with its minimum depth allows it to be mounted in double plasterboard walls (15mm. depth).*

www.modulelectro.ru

## APLICACIÓN / APPLICATIONS

**Clam 200mm.**

Bañado de paredes y suelos. Alumbrado perimetral, en pasillos, escaleras y zonas de paso en general.

**Clam 400mm.**

Bañado de paredes y techos. Iluminación indirecta en general, tanto de zonas de paso como de grandes espacios diáfanos. Oficinas, tiendas, hoteles y sector terciario.

La solución perfecta para todos aquellos espacios donde se quiera disfrutar del confort lumínico de la iluminación indirecta.

*Clam 200mm.*

*Wall/Floor washers specially suitable as guide lights (perimetral lighting) for corridors, staircases or walkable areas.*

*Clam 400mm.*



*Wall/Ceiling washers for indirect lighting in spacious walkable areas. Mainly suitable for offices, shops, hotels or commercial areas.*

*The perfect solution for indirect lighting applications without any glare effects.*

/161





/CLAM/

 **MODUL**   
ELECTRO  
[www.modulelectro.ru](http://www.modulelectro.ru)

/162



 **MODUL**   
ELECTRO  
[www.modulelectro.ru](http://www.modulelectro.ru)

# VENTAJAS/ /ADVANTAGES/

## ROTACIÓN

CLAM permite ser orientada para un buen direccionamiento de su flujo luminoso, evitando así los deslumbramientos en caso de escaleras o iluminación de superficies a distinto nivel. Diseñado para crear efectos de luz o simplemente resaltar elementos arquitectónicos.

## ROTATION

*CLAM can be adjusted for a good direction of the luminous flux, avoiding glare when placed in staircases or at different heights. Designed to create light effects or stress architectural elements.*



**MODUL**  
ELECTRO

[www.modulelectro.ru](http://www.modulelectro.ru)

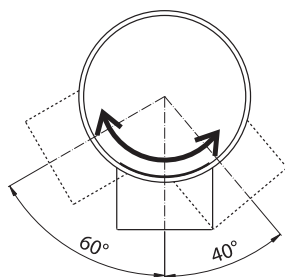
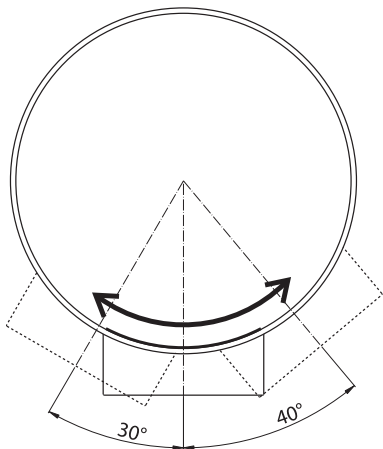

## ROTACIÓN

Ángulos de orientación del flujo luminoso para los dos tamaños de la luminaria Clam

## ROTATION

Angles of orientation of the luminous flux for both sizes.



## SISTEMA DE MONTAJE

El sistema de montaje es sencillo. Se trata de un tipo de sistema de montaje sin marco, tipo Trimless (ver instrucciones en pág.199). Una vez colocado el aro de instalación, el reflector (cuerpo) se coloca encajándolo en las pestañas posteriores. El vano óptico está dotado de un cable y platina para la sujeción del equipo de alimentación, por lo que deberemos introducir el equipo por la orificio realizado en la pared para instalar la luminaria y encajar después el vano óptico para dejar la instalación lista.

Este sistema permite una fácil y rápida reposición tanto de las lámparas como de los equipos en caso de avería o finalización de su vida útil.

## MOUNTING SYSTEM

The mounting system is fast and easy. It is a typical trimless mounting system (see mounting instructions on page 199).

Once the trim is fixed to the wall, the housing clips on it. As the gear hangs from the optic device housing by a cable and a metal plate to hold it, we will first pass the gear through the hole made to install the luminaire in the wall and then fix the optic device housing on it.

This system allows both an easy lamp or gear replacement in case of damage or any other circumstances.

**MODULO ELECTRO**  
www.modulelectro.ru

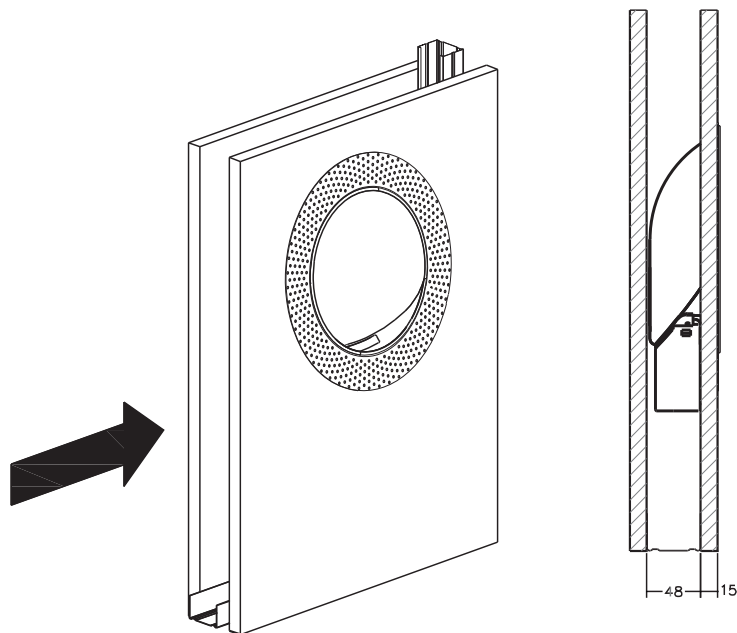

## PROFUNDIDAD DE INSTALACIÓN

CLAM ha sido concebida para su instalación en cualquier superficie, especialmente en tabiques de Pladur (15 mm.) donde empotrar luminarias suele ser imposible debido su poca profundidad. Con CLAM esto es posible en todas sus versiones.

## INSTALLATION DEPTH

CLAM has been designed to be installed in any type of surface, specially on double plaster walls (15mm) where mounting luminaries is often impossible due to its minimum depth.

# /CLAM/

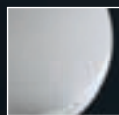

Blanco / White



QT-16 G9

Luminaria empotrable redonda para QT-16 o TC-DEL. Óptica asimétrica tipo bañador  
Round recessed mounting luminaire for QT-16 or TC-DEL. Asymmetric reflector for wall washer

CÓDIGO CODE	COLOR COLOUR	LÁMPARA LAMP	VOLT. VOLT	W W	HAZ BEAM	EQUIPO GEAR	INSTALACIÓN INSTALLATION	
EP-1601-14-14	○	QT-16 G9	230	max. 40W	-	-		*

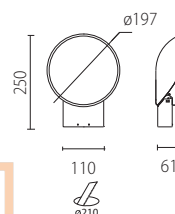

TC-DEL G24q-2

CÓDIGO CODE	COLOR COLOUR	LÁMPARA LAMP	VOLT. VOLT	W W	HAZ BEAM	EQUIPO GEAR	INSTALACIÓN INSTALLATION	
EP-1602-14-14	○	TC-DEL G24q-2	230	18W	-	Elect. inc.		*

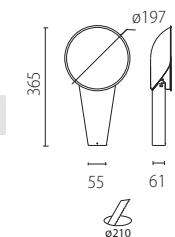

TC-F 2G10

Luminaria empotrable redonda para QT-16, TC-F o CDM-Tm. Óptica asimétrica tipo bañador  
Round recessed mounting luminaire for QT-16, TC-F or CDM-Tm. Asymmetric reflector for wall washer

CÓDIGO CODE	COLOR COLOUR	LÁMPARA LAMP	VOLT. VOLT	W W	HAZ BEAM	EQUIPO GEAR	INSTALACIÓN INSTALLATION	
EP-1608-14-14	○	TC-F 2G10	230	24W	-	Elect. inc.		*

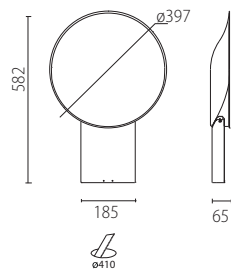

QT-16 G9 CDM-Tm PGJ5

EP-1605-14-14	○	QT-16 G9	230	max. 60W	-	-		*
EP-1610-14-14	○	CDM-Tm PGJ5	230	20W	-	Elect. inc.		*

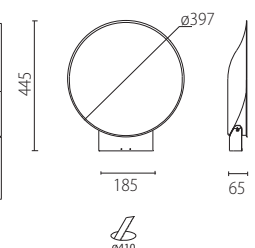

(\*) Consultar  
(\*) Consult





**MODUL**  
ELECTRO

[www.modulelectro.ru](http://www.modulelectro.ru)



/168

# /CLAM E-MODUL E ELECTRO

[www.modulelectro.ru](http://www.modulelectro.ru)





embutridos de pared / wall recessed

arquitectural

**MODUL**  
ELECTRO  
[www.modul-electro.ru](http://www.modul-electro.ru)

/169



 **MODUL**   
ELECTRO  
[www.modulelectro.ru](http://www.modulelectro.ru)

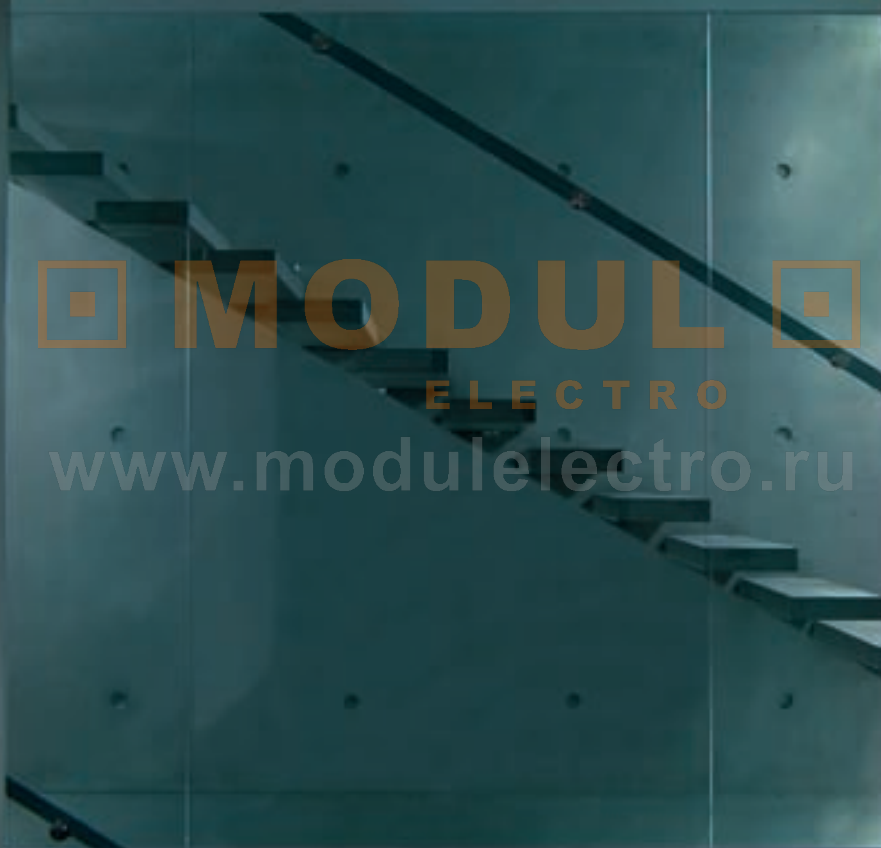

# WALL/

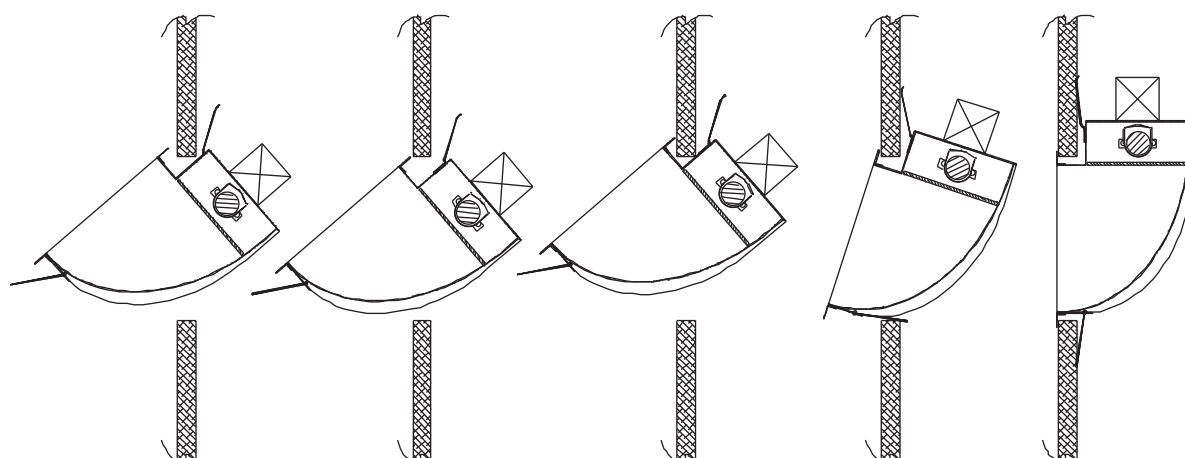

## DESCRIPCIÓN / DESCRIPTION

Gama de empotrables de pared para iluminación de señalización o ambiental.

Cuerpo en chapa de acero con tratamiento anticorrosión.

Marco embellecedor en fundición de aluminio acabado con pintura epoxi de color gris/plata.

Reflector asimétrico, tipo bañador de suelo o pared, en aluminio anodizado mate.

Cristal templado transparente de protección de la lámpara.

Disponible en tres versiones y para lámparas fluorescentes compactas TC-TEL 18W o 26W, halógena QT-DE y fluorescencia lineal T5 de 24 W.

*Wall recessed luminaires for environmental and signalling lighting.*

*Housing made of steel protected against corrosion.*

*Outer trim in die-cast aluminium finished in grey-silver epoxy painting.*

*Asymmetric reflector in matt anodised aluminium for wall or floor washing.*

*Lamp protected with a tempered clear glass.*

*Available in three different versions and for compact fluorescent TC-TEL 18W or 26W, halogen QT-DE and fluorescent lamp T5 24W.*

## APLICACIÓN / APPLICATIONS

Luminarias para ser utilizadas en cualquier proyecto de iluminación de señalización o ambiental en zonas comerciales, oficinas, hoteles, etc.

*Luminaires to be used in any environmental or signalling project in commercial areas, offices, hotels, etc.*





Gris / Grey

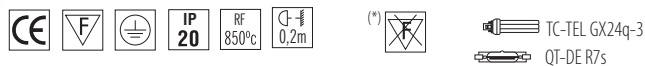

Caja de empotrar incluida.  
Wall recessing box included.

Luminaria empotrable asimétrica para TC-TEL O QT-DE.  
Recessed mounting asymmetric luminaire for TC-TEL or QT-DE lamp.

CÓDIGO CODE	COLOR COLOUR	LÁMPARA LAMP	VOLT. VOLT	W W	HAZ BEAM	EQUIPO GEAR	INSTALACIÓN INSTALLATION	
EP-0344-N3-XY	●	TC-TEL GX24q-3	230	1x26W	-	Elect. inc.		125
EP-0345-N3-00	●	QT-DE R7s	230	max.150W	-	-		68

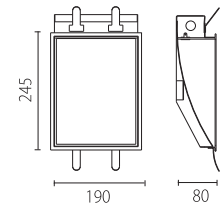

215 x 345 x 100 mm con caja / with box

180 x 240 mm sin caja / without box

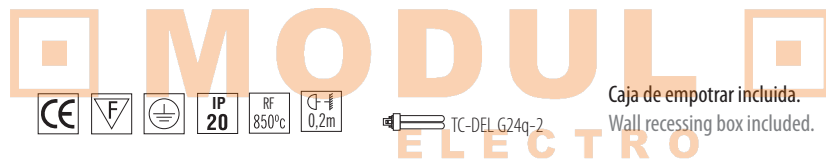

Caja de empotrar incluida.  
Wall recessing box included.

Luminaria empotrable asimétrica para TC-DEL.  
Recessed mounting asymmetric luminaire for TC-DEL lamp.

CÓDIGO CODE	COLOR COLOUR	LÁMPARA LAMP	VOLT. VOLT	W W	HAZ BEAM	EQUIPO GEAR	INSTALACIÓN INSTALLATION	
EP-0346-N3-XY	●	TC-DEL G24q-2	230	1x18W	-	Elect. inc.		*

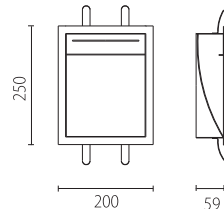

215 x 345 x 100 mm con caja / with box

190 x 240 mm sin caja / without box



Luminaria empotrable asimétrica para T5 de 24W.  
Recessed mounting asymmetric luminaire for T5 fluorescent lamp 24W.

CÓDIGO CODE	COLOR COLOUR	LÁMPARA LAMP	VOLT. VOLT	W W	HAZ BEAM	EQUIPO GEAR	INSTALACIÓN INSTALLATION	
EP-0347-N3-00	●	T5 G5	230	max.24W	-	Elect. inc.		126

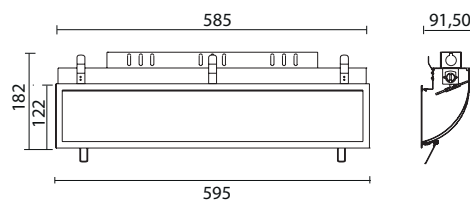

589 x 109 mm

(\*) Consultar  
(\*) Consult

**MODUL**  
ELECTRO  
[www.modulelectro.ru](http://www.modulelectro.ru)

empotrables de pared / wall recessed

arquitectural



**MODUL**  
ELECTRO  
[www.modulelectro.ru](http://www.modulelectro.ru)

/171/

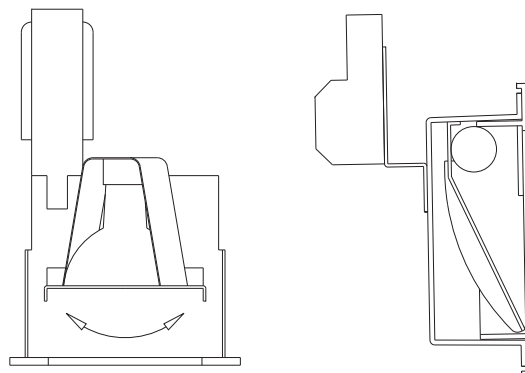

## DESCRIPCIÓN / DESCRIPTION

Gama de pequeños empotrables para iluminación de señalización o ambiental.

Tres versiones disponibles:

- Versión para lámpara QR-CB51.
- Versión asimétrica para lámpara halógena 230V o LED ideal para la iluminación decorativa de escaleras
- Versión con PowerLed de 1W y que permite la incorporación de filtros de color y de pictogramas.

Todas estas luminarias se caracterizan por la excelente calidad de los materiales utilizados en su fabricación y por la enorme facilidad de instalación.

*Small recessed range for sign lighting and the creation of special environments with light.*

*Three versions available:*

- for QR-CB51 lamp.
  - asymmetric for small halogen 230 V or LED, ideal for stairs decorative lighting.
  - with 1W PowerLed which allows to incorporate coloured filters and pictograms.
- All luminaires are characterised by the excellent quality of all materials used in their manufacturing and by the ease of installation.*

## APLICACIÓN / APPLICATIONS

Luminarias para ser utilizadas en cualquier proyecto de iluminación de señalización o ambiental en zonas comerciales, oficinas, hoteles, etc.

*Luminaires to be used in any environmental or signalling project in commercial areas, offices, hotels, etc.*

## ACCESORIOS / ACCESSORIES

La versión para QR-CB51 se suministra con marco embellecedor.

La versión para PowerLed puede incorporar filtros de color y pictogramas.

Las versiones asimétrica y con PowerLed se suministran con una caja de empotramiento para facilitar la instalación de estos productos.

*QR-CB51 version is supplied with decorative trim.*

*The PowerLed version can incorporate colour filters and/or pictograms.*

*For the asymmetric and the PowerLed version a recessing box is supplied to facilitate the installation of these products.*







●  
Gris / Grey



CE, F, III, IP 20, RF 850°C, 0.5m, (\*) F para QR-CB51 < 35W, QR-CB51 GU5.3

Luminaria empotrable cuadrada para QR-CB51.  
Square recessed mounting luminaire for QR-CB51 lamp.

CÓDIGO CODE	COLOR COLOUR	LÁMPARA LAMP	VOLT. VOLT	W	HAZ BEAM	EQUIPO GEAR	INSTALACIÓN INSTALLATION	
EP-0348-N3-XY	●	QR-CB51 GU5.3	12	max.50W	-	Not inc		127

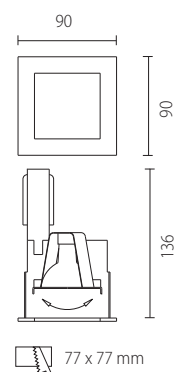

CE, F, III, IP 20, RF 850°C, 0.5m, Halopin G9, Power Led

Luminaria empotrable asimétrica.  
Square recessed asymmetric luminaire.

Caja de empotrar incluida.  
Wall recessing box included.

CÓDIGO CODE	COLOR COLOUR	LÁMPARA LAMP	VOLT. VOLT	W	HAZ BEAM	EQUIPO GEAR	INSTALACIÓN INSTALLATION	
EP-0349-N3-XY	●	Halopin G9	230	25W	-	-		52
EP-0356-N3-00	●	Power Led (5500-6000K)	-	1,2W	-	Not inc		*

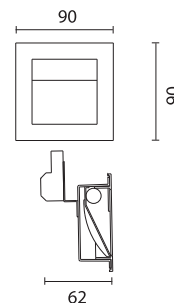

EP-0356. Requiere driver de 350 mA

80 x 116 x 62 mm con caja / with box

77 x 116 mm sin caja / without box

CE, F, III, IP 43, RF 850°C, 0.1m, Power Led

Luminaria empotrable asimétrica para PowerLed. 350 mA  
Square recessed luminaire for PowerLed. 350 mA

Caja de empotrar incluida.  
Wall recessing box included.

CÓDIGO CODE	COLOR COLOUR	LÁMPARA LAMP	VOLT. VOLT	W	HAZ BEAM	EQUIPO GEAR	INSTALACIÓN INSTALLATION	
EP-0360-N3-XY	●	Power Led (5500-6000K)	-	1W	-	Not inc		53

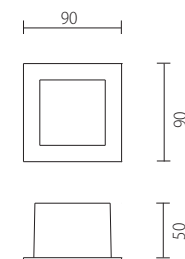

80 x 116 x 62 mm con caja / with box

77 x 77 mm sin caja / without box

(\*) Consultar  
(\*) Consult

Ver drivers de 350 mA en página 194 para EP-0360 / EP-0356  
See 350 mA drivers in page 194 for EP-0360 / EP-0356



# MODUL ELECTRO

www.modulelectro.ru

## ACCESORIOS ACCESSORIES

Filtros de colores.  
Colour filters.

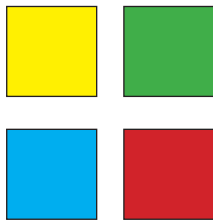

CÓDIGO CODE	COLOR COLOUR
ACT-0364-00-00	-

Pictogramas.  
Pictograms.



CÓDIGO CODE	COLOR COLOUR
ACT-0365-00-00	-





baco



**MODUL**  
ELECTRO

[www.modulelec.ru](http://www.modulelec.ru)

/178

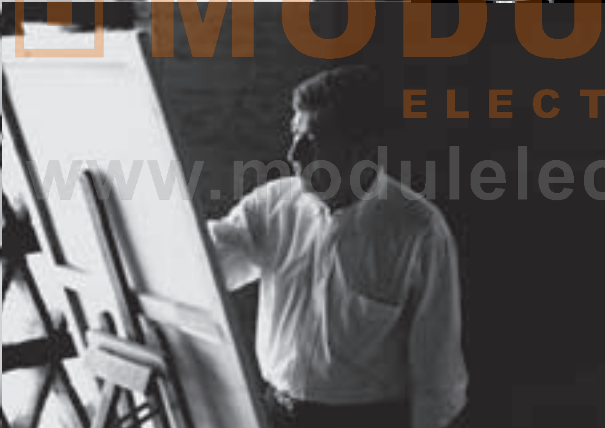

/ADOSABLES/



adobables / surface mounted

architectural

**MODUL**  
ELECTRO

[www.modul.com](http://www.modul.com)

/179

*/surface mounted*



**MODUL**  
ELECTRO  
[www.modul-electro.ru](http://www.modul-electro.ru)

# /BACO/

Design by:  
RAMON BENEDITO

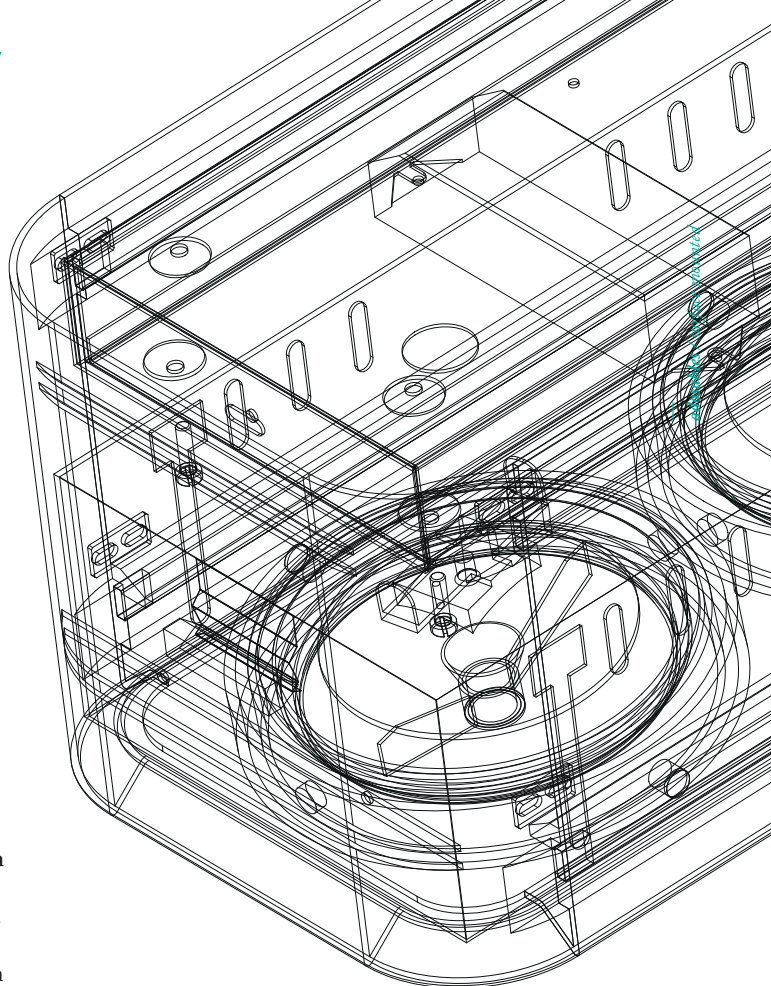
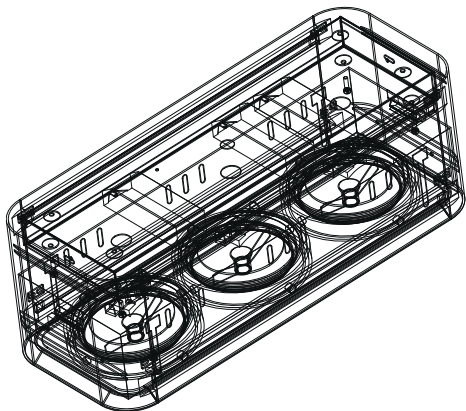

**BACO es el nuevo sistema de iluminación multidireccional para alumbrado general de pequeños espacios y ambiental o de acentuación en áreas diáfnas.**

**La variedad de lámparas que admite, la posibilidad de combinación de las mismas y su sistema de montaje en superficies de paredes y techos lo hacen ideal para todo aquel lugar donde no exista la opción de empotrar elementos.**

**Con su kit de suspensión, BACO se convierte en una elegante luminaria técnica- decorativa.**

**Combine lámparas de descarga con lámparas halógenas, seleccione la ubicación y disposición que más le agrade. Haga los enfoques con el sistema de rotación multidireccional del vano óptico...**

**Bienvenido a la versatilidad.**

*BACO is our new range of multidirectional fittings for general lighting of small spaces or ambient and/or accent lighting for diaphanous areas.*

*The possibility to combine halogen and discharge lamps and the different mounting options on walls or ceilings make this range suitable for spaces where recessed mounting is not permitted.*

*The Suspension kit turns BACO into an elegant technical but at the same time decorative fitting.*

*Just select the right location, the correct adjustment and the number of optics needed and combine halogen and discharge lamps... Welcome to versatility.*





La facilidad de instalación, la variedad de acabados y las posibilidades de montaje en pared, techo o suspensión junto con sus 6 tamaños hacen a BACO ideal para la iluminación de espacios donde se requiera una modularidad y versatilidad elevadas.

Se ofrece la posibilidad de combinar lámparas halógenas de bajo voltaje y de descarga (consultar).

*The ease of installation, the variety of finishes and the different mounting possibilities on wall, ceilings or as a suspensions together with 6 different sizes make BACO an ideal range for lighting spaces where modularity and versatility is a must.*

*It also offers the possibility to combine low voltage halogen lamps together with discharge lamps (on demand).*

**MODUL**  
ELECTRO

[www.modulelectro.ru](http://www.modulelectro.ru)





**MODUL**  
ELECTRO  
[www.modulelectro.ru](http://www.modulelectro.ru)

Las versiones para lámpara QR-111 ofrecen la posibilidad, mediante el correspondiente accesorio, de ser convertidas en su versión de suspensión (ver página 185).

*Versions for QR-111 halogen lamp offer the possibility to be converted into suspensions by acquiring and installing the correspondent accessory (see page 185).*





Blanco / White



Negro / Black

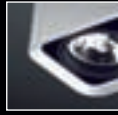

Gris / Grey



Luminaria de superficie para iluminación general, ambiente o acentuación.  
Surface mounted luminaire for general, ambient and/or accent lighting.

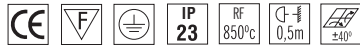

QR-111 G53

CÓDIGO CODE	COLOR COLOUR	LÁMPARA LAMP	VOLT. VOLT	W W	HAZ BEAM	EQUIPO GEAR	INSTALACIÓN INSTALLATION	
DM-1100-14-00	○	QR-CBC51 GU5.3	230	max.75W	—			01-08
DM-1100-60-00	●	QR-CBC51 GU5.3	230	max.75W	—	Elect. inc.		01-08
DM-1100-N3-00	●	QR-CBC51 GU5.3	230	max.75W	—			01-08

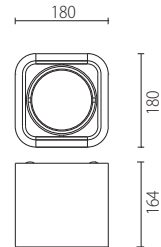

CÓDIGO CODE	COLOR COLOUR	LÁMPARA LAMP	VOLT. VOLT	W W	HAZ BEAM	EQUIPO GEAR	INSTALACIÓN INSTALLATION	
DM-1101-14-00	○	QR-CBC51 GU5.3	230	max.2x75W	—			01-08
DM-1101-60-00	●	QR-CBC51 GU5.3	230	max.2x75W	—	Elect. inc.		01-08
DM-1101-N3-00	●	QR-CBC51 GU5.3	230	max.2x75W	—			01-08

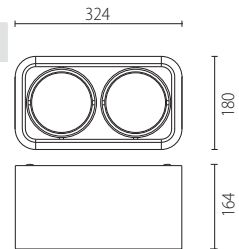

CÓDIGO CODE	COLOR COLOUR	LÁMPARA LAMP	VOLT. VOLT	W W	HAZ BEAM	EQUIPO GEAR	INSTALACIÓN INSTALLATION	
DM-1102-14-00	○	QR-CBC51 GU5.3	230	max.3x75W	—			01-08
DM-1102-60-00	●	QR-CBC51 GU5.3	230	max.3x75W	—	Elect. inc.		01-08
DM-1102-N3-00	●	QR-CBC51 GU5.3	230	max.3x75W	—			01-08

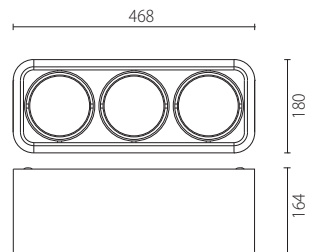

CÓDIGO CODE	COLOR COLOUR	LÁMPARA LAMP	VOLT. VOLT	W W	HAZ BEAM	EQUIPO GEAR	INSTALACIÓN INSTALLATION	
DM-1103-14-00	○	QR-CBC51 GU5.3	230	max.4x75W	—			01-08
DM-1103-60-00	●	QR-CBC51 GU5.3	230	max.4x75W	—	Elect. inc.		01-08
DM-1103-N3-00	●	QR-CBC51 GU5.3	230	max.4x75W	—			01-08

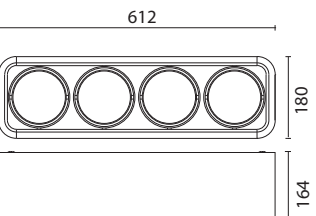

Versiones de descarga consultar.  
Discharge lamps versions on demand.

# MODULO

## ELECTRO

[www.modulelectro.ru](http://www.modulelectro.ru)

/185



CÓDIGO CODE	COLOR COLOUR	DESCRIPCIÓN DESCRIPTION	PARA CÓDIGO FOR CODE
ACT-9044-14-00	○	Kit suspensión + 1 sirga/ <i>Suspension Kit + 1 steel cable</i>	DM-1100
ACT-9044-60-00	●	Kit suspensión + 1 sirga/ <i>Suspension Kit + 1 steel cable</i>	DM-1100
ACT-9044-N3-00	●	Kit suspensión + 1 sirga/ <i>Suspension Kit + 1 steel cable</i>	DM-1100
ACT-9045-14-00	○	Kit suspensión + 2 sirgas/ <i>Suspension Kit + 2 steel cables</i>	DM-1101, DM-1102, DM-1103
ACT-9045-60-00	●	Kit suspensión + 2 sirgas/ <i>Suspension Kit + 2 steel cables</i>	DM-1101, DM-1102, DM-1103
ACT-9045-N3-00	●	Kit suspensión + 2 sirgas/ <i>Suspension Kit + 2 steel cables</i>	DM-1101, DM-1102, DM-1103

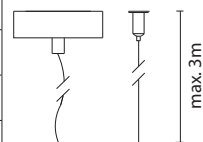

Para versión suspendida solicitar luminaria + kit suspensión.  
For suspended version, order luminaire + suspension kit.



● Blanco / White



○ Negro / Black



● Gris / Grey

## MODULO ELECTRO

Luminaria de superficie para iluminación general, ambiente o acentuación.  
Surface mounted luminaire for general, ambient and/or accent lighting.



QR-CBC51 GUS.3

CÓDIGO CODE	COLOR COLOUR	LÁMPARA LAMP	VOLT. VOLT	W W	HAZ BEAM	EQUIPO GEAR	INSTALACIÓN INSTALLATION	
DM-1150-14-00	○	QR-CBC51 GUS.3	230	max. 50W	-			01-08
DM-1150-60-00	●	QR-CBC51 GUS.3	230	max. 50W	-	Elect. inc.		01-08
DM-1150-N3-00	●	QR-CBC51 GUS.3	230	max. 50W	-			01-08

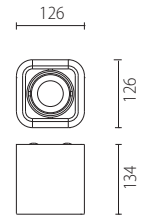

CÓDIGO CODE	COLOR COLOUR	LÁMPARA LAMP	VOLT. VOLT	W W	HAZ BEAM	EQUIPO GEAR	INSTALACIÓN INSTALLATION	
DM-1151-14-00	○	QR-CBC51 GUS.3	230	max. 2x50W	-			01-08
DM-1151-60-00	●	QR-CBC51 GUS.3	230	max. 2x50W	-	Elect. inc.		01-08
DM-1151-N3-00	●	QR-CBC51 GUS.3	230	max. 2x50W	-			01-08

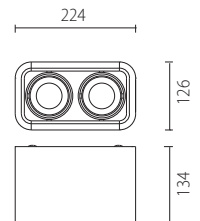



**MODUL**  
ELECTRO  
[www.modulselectro.ru](http://www.modulselectro.ru)

— adosables / surface mounted

/187/

**MODUL**  
ELECTRO  
[www.modulelectro.ru](http://www.modulelectro.ru)

BACCO



**MODUL**

**ELECTRO**

[www.modulelectro.ru](http://www.modulelectro.ru)



**MODUL**  
ELECTRO  
[www.modulelectro.ru](http://www.modulelectro.ru)



# /RAPID C/

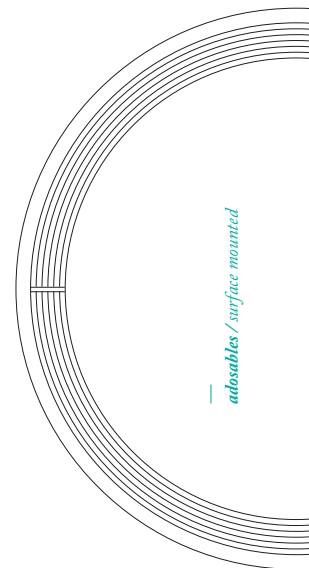
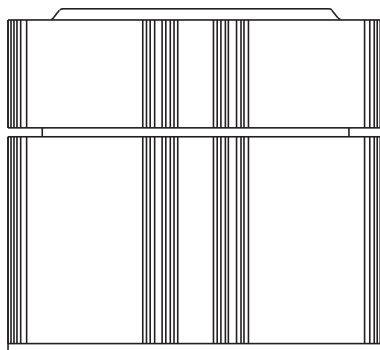

adobables / surface mounted

architectural

## DESCRIPCIÓN / DESCRIPTION

Gama de downlights fijos para iluminación general (instalación en superficie).

Cuerpo en extrusión de aluminio acabado con pintura epoxi de color blanco.

Reflector en aluminio anodizado mate.

Disponible para lámparas fluorescentes compactas TC-TEL 2x26W o para lámparas de descarga HIT-DE 70W (en ambos casos, equipo electrónico incorporado en el aparato).

El cierre inferior incorpora un cristal templado arenado para un mayor confort visual.

*Fixed surface mounted downlights for general lighting.*

*Extruded aluminium housing finished with white epoxy painting.*

*High purity anodised aluminium reflector with matt finishing.*

*Available for compact fluorescent TC-TEL 2x26W or for compact discharge*

*HIT-DE 70W (in both cases, electronic gear is incorporated into the luminaire).*

*The bottom closure integrates a sanded tempered glass for higher visual comfort.*

## APLICACIÓN / APPLICATION

Luminarias para ser utilizadas en cualquier proyecto de iluminación general interior y en ciertas localizaciones al exterior – marquesinas, pasillos, recepciones, etc.

Se trata de la serie idónea para esas instalaciones que no permiten el empotramiento de las luminarias.

*Luminaires to be used in any indoor general lighting project and also in certain covered outdoor applications –awnings, passageways, reception areas, etc.*

*It is the ideal series for these types of installations where luminaires cannot be embedded.*





# /RAPID C/

Ver fotometrías en página 214 y tabla de equivalencias de lámparas en página 223.

See Photometric data on page 214 and equivalent lamps table on page 223.



Blanco / White



/192



Downlight para montaje en superficie.  
Surface mounted downlight.



HIT-DE Rx7s

TC-TEL GX24q-3

CÓDIGO CODE	COLOR COLOUR	LÁMPARA LAMP	VOLT. VOLT	W W	HAZ BEAM	EQUIPO GEAR	INSTALACIÓN INSTALLATION	
DN-0581-14-B9	○	HIT-DE Rx7s	230	70W	-	Elect. inc		34
DN-0580-14-B9	○	TC-TEL GX24q-3	230	2x26W	-			58

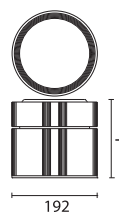

DN-0581-14-B9 L= 176 mm  
DN-0580-14-B9 L= 263 mm





**MODUL**  
ELECTRO  
[www.modulelectro.ru](http://www.modulelectro.ru)

adossables / surface mounted

architectural

# /UNIDADES ELÉCTRICAS ELECTRICAL UNITS/

## Transformadores de seguridad electrónicos para lámparas halógenas 12V.

Antiparasitario. Uso independiente. Clase II. IP 20.

Electronic transformers. Security electronic transformers for 12V halogen lamps.

Antiparasitic.

Class II. IP20.

CÓDIGO CODE	W	DIMENSIONES DIMENSIONS
ACT-TRA-001	20-60W	37x28x128
ACT-TRA-002	20-70W	37x28x128
ACT-TRA-003	20-105W	37x28x128
ACT-TRA-004	50-150W	37x28x184



## Equipo electrónico para PowerLeds. 100~240V, 700 mA

Antiparasitario. Uso independiente. Clase II. IP20.

Drivers (Electronic gear for PowerLEDs). 100~240V; 700 mA.

Antiparasitic.

Class II. IP20.

CÓDIGO CODE	W
71-3305-00-00	3W
71-3306-00-00	4W
71-3307-00-00	12W
71-3308-00-00	18W



## Equipo electrónico para PowerLeds. 100~240V, 500 mA

Antiparasitario. Uso independiente. Clase II. IP20.

Drivers (Electronic gear for PowerLEDs). 100~240V; 500 mA.

Antiparasitic.

Class II. IP20.

CÓDIGO CODE	W
71-3309-00-00	16W

## Equipo electrónico para PowerLeds. 100~240V, 350 mA

Antiparasitario. Uso independiente. Clase II. IP20.

Drivers (Electronic gear for PowerLEDs). 100~240V; 350 mA.

Antiparasitic.

Class II. IP20.

CÓDIGO CODE	W	DIMENSIONES DIMENSIONS
ACT-0803-00-00	3W	49x39x21
ACT-0804-00-00	4W	40x67x16
ACT-0808-00-00	8W	85x40x16
ACT-0816-00-00	18W	103x67x31



Para todas las luminarias suministradas sin equipo de funcionamiento (debidamente identificadas en el catálogo), éste deberá ser pedido separadamente.

*For all luminaries supplied without gear (all of them correctly identified in the catalogue), this one shall be ordered separately.*

**Reactancia electrónica para lámparas de halogenuros metálicos. 220~240V, 50-60Hz**

Uso independiente. Clase II. IP20.

Alargamiento de la vida de las lámparas y ahorro de energía.

Electronic gear for HIT lamps. 220~240V; 50-60Hz.

Class II. IP20.

Longer lamp life and energy savings.

CÓDIGO CODE	W	DIMENSIONES DIMENSIONS
ACT-BAL-003	35W	67x31x140
ACT-BAL-004	2x35W	89x37x224
ACT-BAL-005	70W	89x37x186
ACT-BAL-006	2x70W	89x37x224
ACT-BAL-007	150W	89x37x186

**Equipo magnético de alimentación para lámparas de halogenuros metálicos. ~230V, 50Hz**

Uso independiente. Clase II. IP40.

Interruptor térmico incorporado.

Magnetic gear for HIT lamps. 230V; 50Hz.

Class II. IP40.

Thermal switch integrated.

CÓDIGO CODE	W	DIMENSIONES DIMENSIONS
ACT-BAL-009	35W	73x61x222
ACT-BAL-010	70W	73x61x222
ACT-BAL-011	150W	73x61x250



# /LÁMPARAS LAMPS/

## Halógenas B.T con reflector / Low voltage halogen with reflector

### MASTER line 111 - Philips

40% ahorro de energía: intensidad de haz de 60W = 100W estándar.

40% energy savings: 60W lamp has same beam intensity as the standard 100W.

40% menos calor generado. El doble de vida útil comparada con las QR-111 estándar.

40% less heat generated: important savings in air conditioning. Double life time compared with standard QR-111 lamps.

QR-111



CÓDIGO CODE	CASQUILLO BASE	V	W	COLOR COLOUR	HAZ (°) BEAM (°)	I (CD)	Φ (LM)	VIDA (H) LIFE (H)
ACT-FLH-001	G53	12	30		8	23000		4000
ACT-FLH-002	G53	12	30		24	4000		4000
ACT-FLH-003	G53	12	45		8	33000		4000
ACT-FLH-004	G53	12	45		24	5300		4000
ACT-FLH-005	G53	12	45		45	1900		4000
ACT-FLH-006	G53	12	60		8	48000		4000
ACT-FLH-007	G53	12	60		24	8500		4000
ACT-FLH-008	G53	12	60		45	2800		4000

### Halospot 70 - Osram

Reflector facetado para una distribución luminosa uniforme

Faceted reflector for an uniform luminous distribution.

QR-70



CÓDIGO CODE	CASQUILLO BASE	V	W	COLOR COLOUR	HAZ (°) BEAM (°)	I (CD)	Φ (LM)	VIDA (H) LIFE (H)
ACT-FLH-021	BA15d	12	20		8	7700		3000
ACT-FLH-022	BA15d	12	20		24	900		3000
ACT-FLH-023	BA15d	12	50		8	12500		3000
ACT-FLH-024	BA15d	12	50		24	2600		3000

### Decostar 51 IRC - Osram

30% ahorro de energía: intensidad de haz de 35W = 50W estándar

30% energy savings: 35W lamp has same beam intensity as the standard 50W.

El doble de vida útil comparada con las QR-CB51 estándar.

30% less heat generated: important savings in air conditioning. Double life time compared with standard QR-CB51 lamps.

QR-CB51



CÓDIGO CODE	CASQUILLO BASE	V	W	COLOR COLOUR	HAZ (°) BEAM (°)	I (CD)	Φ (LM)	VIDA (H) LIFE (H)
ACT-FLH-009	GU5.3	12	35		10	12500		4000
ACT-FLH-010	GU5.3	12	35		24	4400		4000
ACT-FLH-011	GU5.3	12	35		36	2200		4000
ACT-FLH-012	GU5.3	12	35		60	1100		4000
ACT-FLH-013	GU5.3	12	50		10	15000		4000
ACT-FLH-014	GU5.3	12	50		24	5700		4000
ACT-FLH-015	GU5.3	12	50		36	2850		4000
ACT-FLH-016	GU5.3	12	50		60	1430		4000

## Halógenas B.T. sin reflector / Low voltage halogen without reflector

### CAPSULEline Pro - Philips

QT-12



CÓDIGO CODE	CASQUILLO BASE	V	W	COLOR COLOUR	HAZ (°) BEAM (°)	I (CD)	Φ (LM)	VIDA (H) LIFE (H)
ACT-FLH-017	GY6.35	12	35				600	3000
ACT-FLH-018	GY6.35	12	50				880	3000
ACT-FLH-019	GY6.35	12	75				1575	3000
ACT-FLH-020	GY6.35	12	100				2200	3000

### MasterLine-TC - Philips

Excelentes eficacia y vida útil.

Excellent efficacy and lamp life.

QT-TC



CÓDIGO CODE	CASQUILLO BASE	V	W	COLOR COLOUR	HAZ (°) BEAM (°)	I (CD)	Φ (LM)	VIDA (H) LIFE (H)
ACT-FLH-025	G8.5	12	45				1100	5000
ACT-FLH-026	G8.5	12	60				1600	5000

## Fluorescentes compactas para balastro magnético / Compact fluorescent for magnetic gear

### Dulux D - Osram

TC-D



CÓDIGO CODE	CASQUILLO BASE	V	W	COLOR COLOUR	HAZ (°) BEAM (°)	I (CD)	Φ (LM)	VIDA (H) LIFE (H)
ACT-FLF-001	G24d-1	230	13	830			900	8000
ACT-FLF-002	G24d-1	230	13	840			900	8000
ACT-FLF-003	G24d-2	230	18	830			1200	8000
ACT-FLF-004	G24d-2	230	18	840			1200	8000
ACT-FLF-005	G24d-3	230	26	830			1800	8000
ACT-FLF-006	G24d-3	230	26	840			1800	8000

## Fluorescentes compactas para balastro electrónico / Compact fluorescent for electronic gear

### Dulux D/E - Osram

TC-DEL



CÓDIGO CODE	CASQUILLO BASE	V	W	COLOR COLOUR	HAZ (°) BEAM (°)	I (CD)	Φ (LM)	VIDA (H) LIFE (H)
ACT-FLF-007	G24q-1	230	13	830			900	10000
ACT-FLF-008	G24q-1	230	13	840			900	10000
ACT-FLF-009	G24q-2	230	18	830			1200	10000
ACT-FLF-010	G24q-2	230	18	840			1200	10000
ACT-FLF-011	G24q-3	230	26	830			1800	10000
ACT-FLF-012	G24q-3	230	26	840			1800	10000

## Fluorescentes compactas para balastro electrónico / Compact fluorescent for electronic gear

### Dulux T/E - Osram

TC-TEL



CÓDIGO CODE	CASQUILLO BASE	V	W	COLOR COLOUR	HAZ (°) BEAM (°)	I (CD)	Φ (LM)	VIDA (H) LIFE (H)
ACT-FLF-013	GX24q-3	230	26	830			1800	10000
ACT-FLF-014	GX24q-3	230	26	840			1800	10000
ACT-FLF-015	GX24q-3	230	32	830			2400	10000
ACT-FLF-016	GX24q-3	230	32	840			2400	10000
ACT-FLF-017	GX24q-4	230	42	830			3200	10000
ACT-FLF-018	GX24q-4	230	42	840			3200	10000

### PL-H - Philips

PL-H



CÓDIGO CODE	CASQUILLO BASE	V	W	COLOR COLOUR	HAZ (°) BEAM (°)	I (CD)	Φ (LM)	VIDA (H) LIFE (H)
ACT-FLF-030	2G8	230	60	830			4000	20000
ACT-FLF-031	2G8	230	60	840			4000	20000
ACT-FLF-032	2G8	230	85	830			6000	20000
ACT-FLF-033	2G8	230	85	840			6000	20000
ACT-FLF-034	2G8	230	120	830			9000	20000
ACT-FLF-035	2G8	230	120	840			9000	20000

## Fluorescentes compactas para balastro electrónico / Compact fluorescent for electronic gear

### Dulux F - Osram

TC-F



CÓDIGO CODE	CASQUILLO BASE	V	W	COLOR COLOUR	HAZ (°) BEAM (°)	I (CD)	Φ (LM)	VIDA (H) LIFE (H)
ACT-FLF-037	2G10	230	24	830			1700	
ACT-FLF-038	2G10	230	24	840			1700	

# /LÁMPARAS LAMPS/

## Halogenos metálicos con reflector de aluminio / Metal halide with aluminium reflector integrated

**MasterColour CDM-R111 - Philips**, Estabilidad de color. Mejor reproducción cromática. Usar sólo con reactancias electrónicas  
*Colour stability. Better chromatic rendering. Use only with electronic gear.*

CDM-R111



CÓDIGO CODE	CASQUILLO BASE	V	W	COLOR COLOUR	HAZ (°) BEAM (°)	I (CD)	Φ (LM)	VIDA (H) LIFE (H)
<b>ACT-FLD-008</b>	GX8.5	230	35	830	10°	35000		20000
<b>ACT-FLD-009</b>	GX8.5	230	35	830	24°	8500		20000
<b>ACT-FLD-010</b>	GX8.5	230	35	830	40°	4000		20000
<b>ACT-FLD-011</b>	GX8.5	230	70	830	10°	50000		20000
<b>ACT-FLD-012</b>	GX8.5	230	70	830	24°	15000		20000
<b>ACT-FLD-013</b>	GX8.5	230	70	830	40°	6500		20000

## Halogenos metálicos de doble terminal / Double terminal metal halide

**MHW-TD Pro - Philips**  
Excelentes eficacia y vida útil  
*Good efficacy and lamp life*

HIT-DE



CÓDIGO CODE	CASQUILLO BASE	V	W	COLOR COLOUR	HAZ (°) BEAM (°)	I (CD)	Φ (LM)	VIDA (H) LIFE (H)	RAEE
<b>ACT-FLD-001</b>	Rx7s	230	70	942			5700	9000	0,30
<b>ACT-FLD-002</b>	Rx7s	230	150	942			12900	9000	0,30

## Halogenos metálicos de un terminal / Single terminal metal halide

**MasterColour CDM-T - Philips**  
Estabilidad de color. Mejor reproducción cromática  
*Colour stability. Better chromatic rendering.*

HIT-T



CÓDIGO CODE	CASQUILLO BASE	V	W	COLOR COLOUR	HAZ (°) BEAM (°)	I (CD)	Φ (LM)	VIDA (H) LIFE (H)	RAEE
<b>ACT-FLD-003</b>	G12	230	35	830			3300	12000	0,30
<b>ACT-FLD-004</b>	G12	230	70	830			6600	12000	0,30
<b>ACT-FLD-005</b>	G12	230	150	830			14000	12000	0,30

**MasterColour CDM-TC - Philips**  
Estabilidad de color. Mejor reproducción cromática  
*Colour stability. Better chromatic rendering.*  
Se aconseja el uso de la lámpara de 70W sólo con reactancia electrónica  
*Advisable to use the 70W lamp with electronic gear.*

HIT-TC



CÓDIGO CODE	CASQUILLO BASE	V	W	COLOR COLOUR	HAZ (°) BEAM (°)	I (CD)	Φ (LM)	VIDA (H) LIFE (H)	RAEE
<b>ACT-FLD-006</b>	G8,5	230	35	830			3300	9000	0,30
<b>ACT-FLD-007</b>	G8,5	230	70	830			6400	6000	0,30

CDM-Tm



**MasterColour CDM-Tm - Philips**  
Estabilidad de color. Mejor reproducción cromática  
*Colour stability. Better chromatic rendering.*  
Sólo funciona con el equipo electrónico de Philips suministrado con nuestras luminarias  
*Works only with electronic gear Philips (delivered with our luminaires).*

CÓDIGO CODE	CASQUILLO BASE	V	W	COLOR COLOUR	HAZ (°) BEAM (°)	I (CD)	Φ (LM)	VIDA (H) LIFE (H)	RAEE
<b>ACT-FLD-015</b>	PGJ5	230	20	830			1615	9000	0,30

# INSTRUCCIONES DE MONTAJE MOUNTING INSTRUCTIONS/

Instalación de las versiones sin marco (Trimless) / Installation instructions for the trimless version

## MULTIDIR

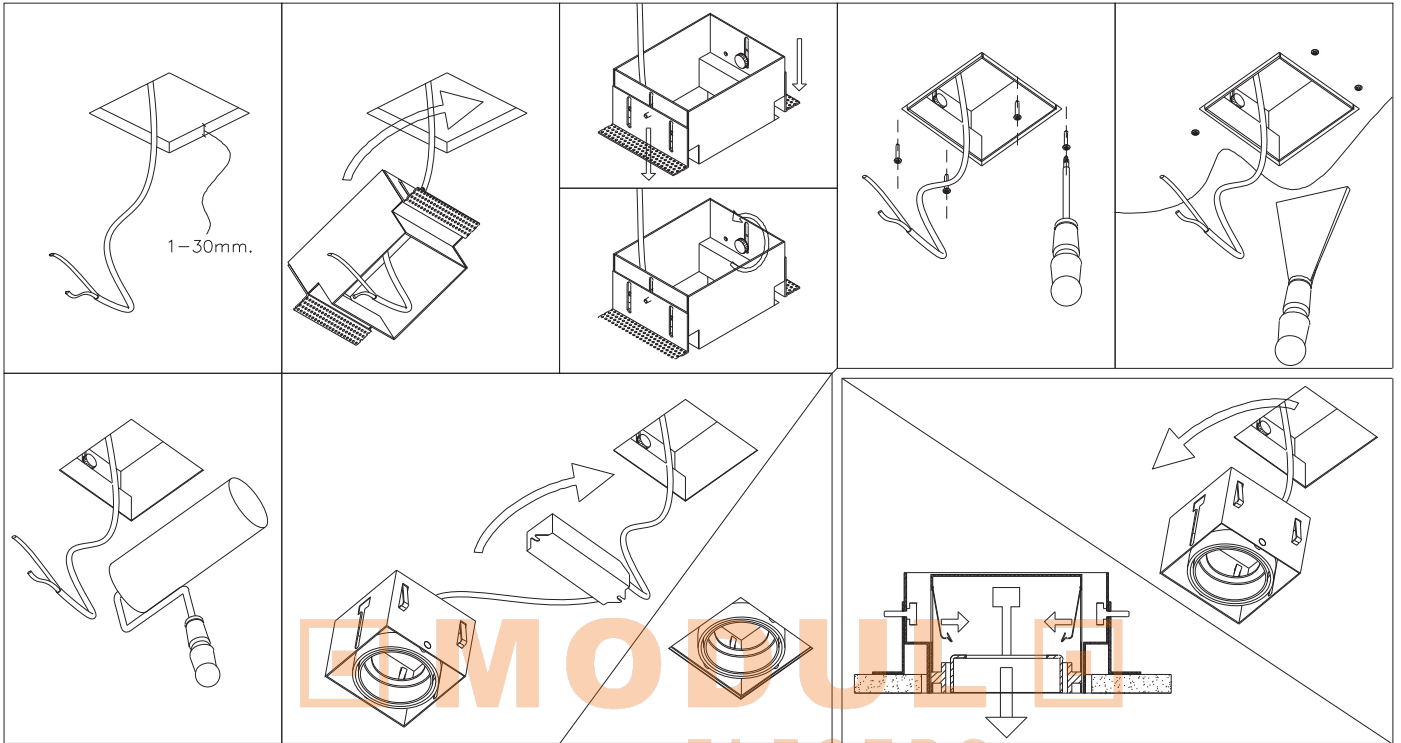

MODULELECTRO

www.modulelectro.ru

## CLAM

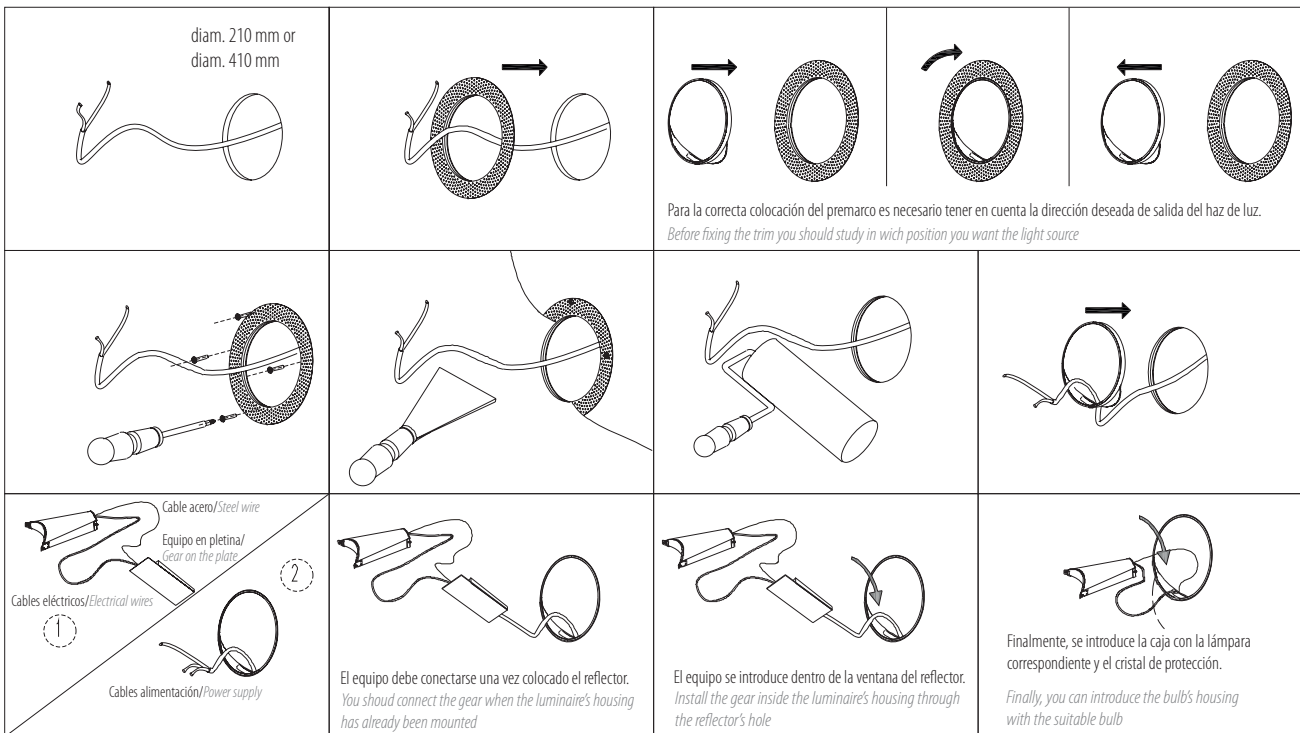



/OTRAS LUMINARIAS/  
ELECTRO  
/OTHER LUMINAIRES/  
[www.modulelectro.ru](http://www.modulelectro.ru)



■  
MODUL ■  
GROK.  
ELEKTRO  
www.modulelectro.ru

/201

/GROK

# linear

design :: Ramon Benedito

Linear

Chok

/202



**MODULO**  
ELECTRO  
[www.modulelectro.ru](http://www.modulelectro.ru)

00-0338-Y6-Y6



Y6

Aluminio satinado  
Satin aluminium

Reactancia electrónica  
Electronic ballast

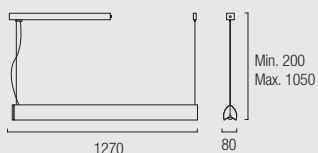

Reactancia electrónica  
Electronic ballast

00-0338-Y6-Y6

T5 54W FLUORESCENT included





15-2781-S2-M1

onda **MODUL** ELECTRO  
 design :: Josep Patsi  
[www.modulelectro.ru](http://www.modulelectro.ru)



15-2780-S2-M1

— Onda

— Grok

/203

Aluminio pulido y satinado  
 Polished and burnished aluminium  
**S2**

 <b>15-2779-S2-M1</b> T5 FC 22W+40W 	 <b>15-2780-S2-M1</b> 2G11 4x36W 	 <b>15-2781-S2-M1</b> 2G11 4x55W 
---	--	--



15-2779-S2-M1

/204

**MODUL**  
ELECTRO  
[www.modulelectro.ru](http://www.modulelectro.ru)

/OUTDOOR

# MICENAS

<b>Materiales / Materials</b> 	<b>Especificaciones / Specifications</b> 	<b>Acabados / Finishes</b> <span style="display: inline-block; width: 15px; height: 15px; background-color: grey; margin-right: 5px;"></span> 34 Gris Grey <span style="display: inline-block; width: 15px; height: 15px; background-color: black; margin-right: 5px;"></span> Z5 Gris urbano Urban grey
<b>Incluido / Included</b> 		

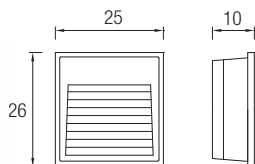

**05-9388-34-T2** ■  
**05-9388-Z5-T2** ■

G12 35W Halogenurs

IP 54 2 IK 04

**BAG Included**

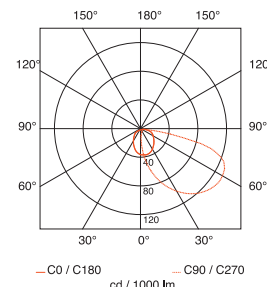

Pompeya / Micenas

Outdoor

# POMPEYA

<b>Materiales / Materials</b> 	<b>Especificaciones / Specifications</b> 	<b>Acabados / Finishes</b> <span style="display: inline-block; width: 15px; height: 15px; background-color: grey; margin-right: 5px;"></span> 34 Gris Grey

MODULE ELECTRO

www.modulelectro.ru

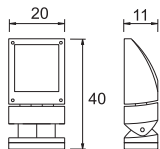

**05-9252-34-37** ■

Rx7s 70W Halogenurs

IP 65 2 IK 08

**PHILIPS Included**

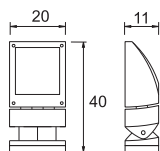
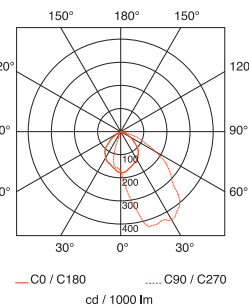

**05-9253-34-37** ■

Rx7s 150W Halogenurs

IP 65 2 IK 08

**PHILIPS Included**

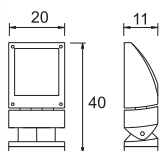
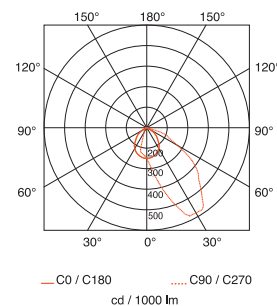

**05-9254-34-37** ■

2 x GX24q-3 26W Fluo

IP 65 2 IK 08

**PHILIPS Included**

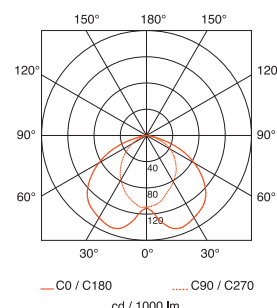

/205

# AFRODITA

Afrodita

Outdoor

## Materiales / Materials



## Especificaciones / Specifications



## Acabados / Finishes

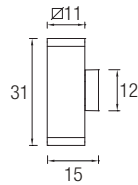

05-9368-34-37 ■  
05-9368-Z5-37 ■

2 x Par-30 E-27 max. 75W

Par-30 E-27 15W Fluo

IP 65 6 IK 08

Par-30 75W

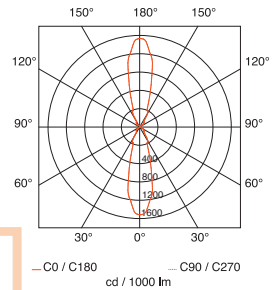

# MODULO



05-9369-34-37 ■  
05-9369-Z5-37 ■

G12 70W Halogenurs

IP 65 2 IK 08

BAG + Reflector simple y doble  
Double and simple reflector. **Included**

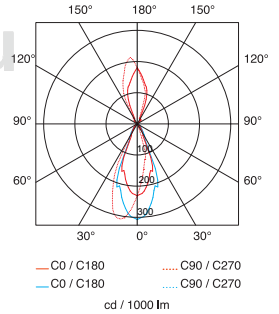

/206

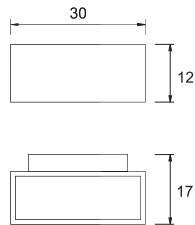
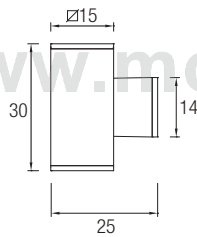

05-9227-34-37 ■  
05-9227-Z5-37 ■

Rx7s. 150W Halogenurs

IP 65 2 IK 04

BAG **Included**

Accesorio reflector  
Reflector accessory

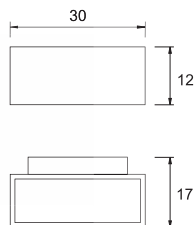
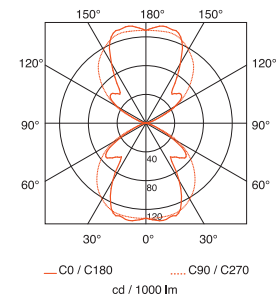

05-9228-34-37 ■  
05-9228-Z5-37 ■

2 x G24q-3 26W Fluo

IP 65 2 IK 04

PHILIPS 26W **Included**

Accesorio reflector  
Reflector accessory

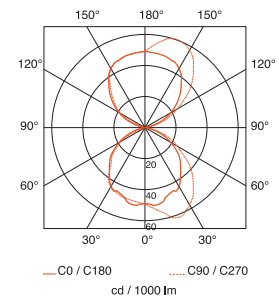

# COSMOS

## Materiales / Materials



## Especificaciones / Specifications

IP 65 CE RF 850% ENERGY SAVING IK 08

## Acabados / Finishes

34 Gris Grey      Z5 Gris urbano Urban grey



Cosmos

Outdoor

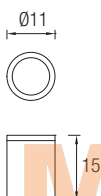

15-9362-34-37 ■  
15-9362-Z5-37 ■  
Par-30 E-27 max. 75W  
Par-30 E-27 15W Fluo  
IP 65 6 IK 08

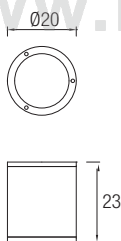
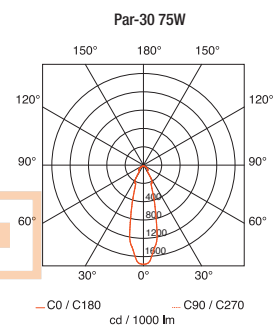

15-9363-34-37 ■  
15-9363-Z5-37 ■  
Par-38 E-27 80W  
PL elect. E-27 max. 30W  
Par-38 E-27 23W Fluo  
IP 65 4 IK 08

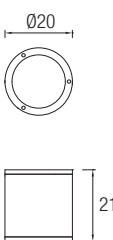
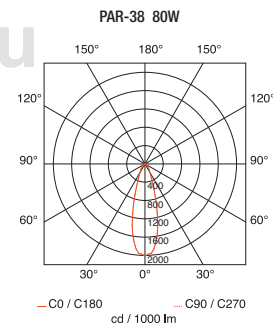

15-9364-34-37 ■  
15-9364-Z5-37 ■  
G12 70W Halogenus  
IP 65 2 IK 08  
BAG Included

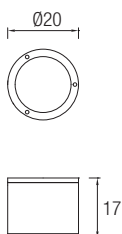
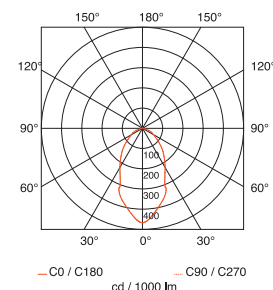

15-9365-34-T2 ■  
15-9365-Z5-T2 ■  
2 x GX24d-3 26W  
IP 65 2 IK 08  
BAG Included

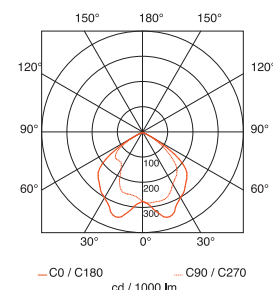



# GEA

## Materiales / Materials



## Especificaciones / Specifications



## Acabados / Finishes



Gea

Outdoor

/208

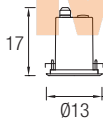

**15-9381-Y4-37**

GU-10 max. 50W  
GU-10 max. 11W Fluorescent

IP 67 4 IK 08



GU-10 50W

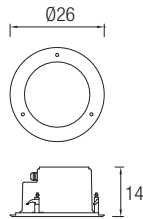
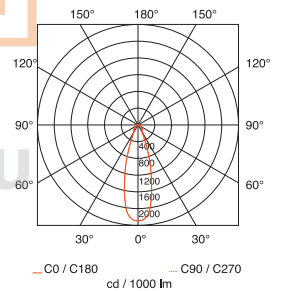

**15-9391-Y4-T2**

GX24d-3 26W

IP 66 2 IK 08

BAG Included

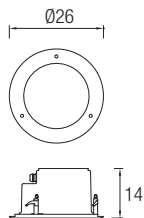
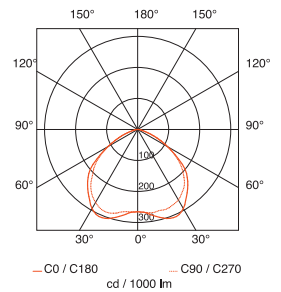

**15-9392-Y4-T2**

2 x GX24d-3 26W

IP 66 2 IK 08

BAG Included

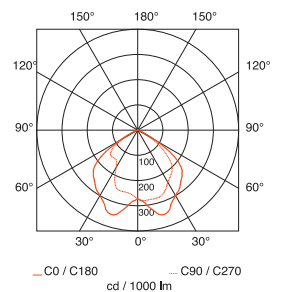

# GEA

Materiales / Materials



Incluido / Included



Especificaciones / Specifications

IP 67 CE RF 850° ENERGY SAVING IK 08



Acabados / Finishes

Y4 Acero inoxidable  
Stainless steel

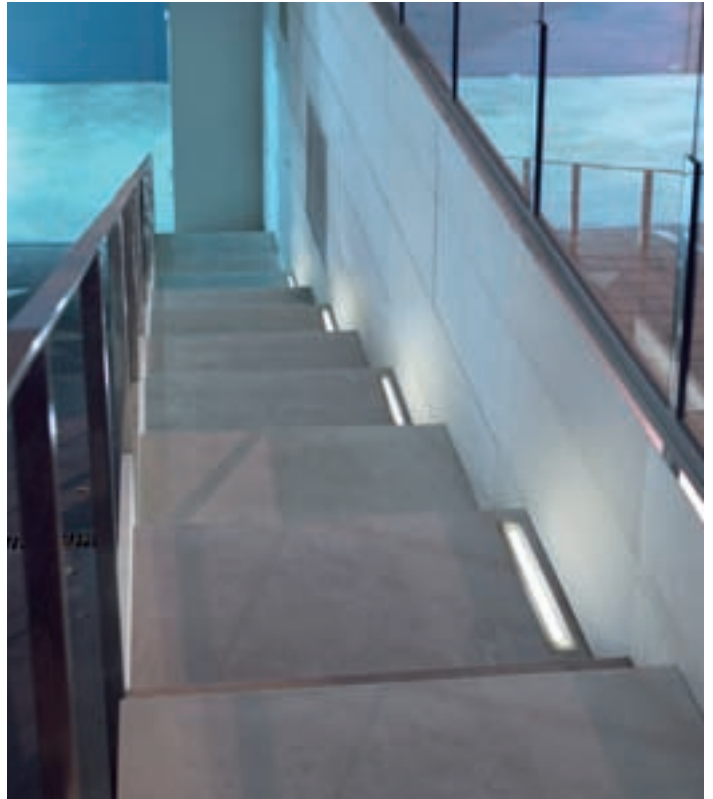

Gea

Outdoor

/209

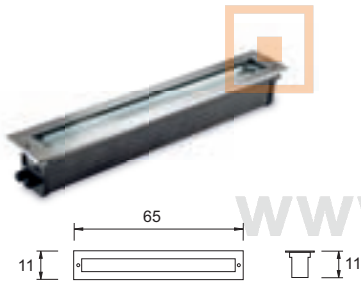

55-9264-Y4-37

T5 24W Fluorescent

IP 67 IK 08

VOSSLOH Included

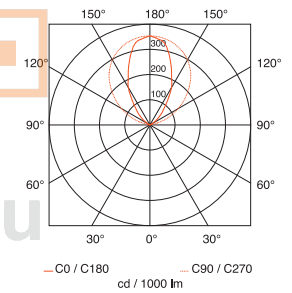

55-9265-Y4-37

T5 39W Fluorescent

IP 67 IK 08

VOSSLOH Included

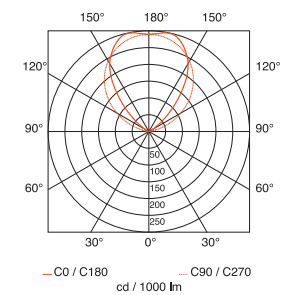

55-9266-Y4-37

T5 54W Fluorescent

IP 67 IK 08

VOSSLOH Included

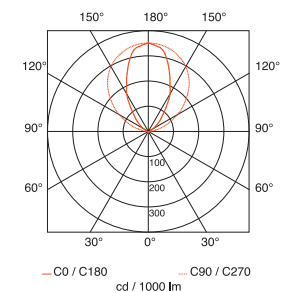

**Materiales / Materials**



2 reflectores incluidos.  
2 reflectors included.

**Especificaciones / Specifications**

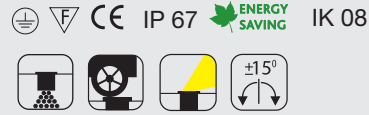

**Incluido / Included**



**Acabados / Finishes**

Y4 Acero inoxidable  
Stainless steel

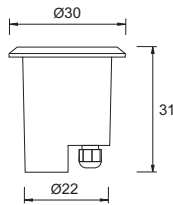

**55-9267-Y4-37**

G12 150W Halogenurs

IP 67  $\pm 0.5m$  2 ENERGY SAVING IK 08

BAG Included

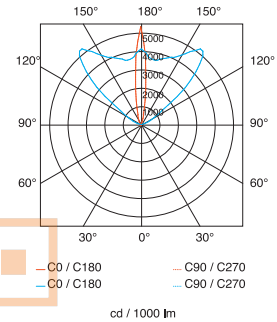

# MODULO ELECTRO

[www.modulelectro.ru](http://www.modulelectro.ru)

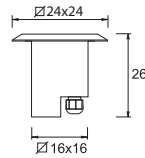

**55-9232-Y4-37**

G12 70W Halogenurs

IP 67 2 ENERGY SAVING IK 08

BAG Included

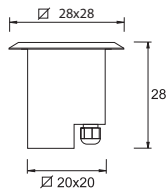
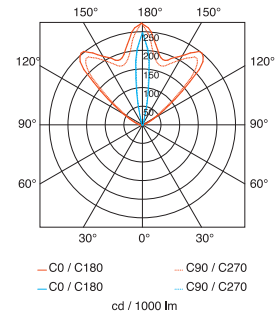

**55-9233-Y4-37**

G12 150W Halogenurs

IP 67 2 ENERGY SAVING IK 08

BAG Included

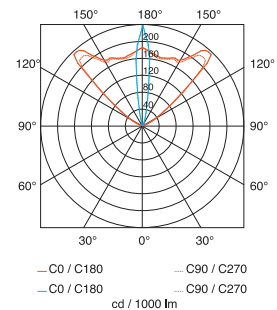

## Materiales / Materials



2 reflectores incluidos.  
2 reflectors included.

## Especificaciones / Specifications

IP 67 CE ENERGY SAVING IK 08



## Incluido / Included



## Acabados / Finishes

Y4 Acero inoxidable  
Stainless steel

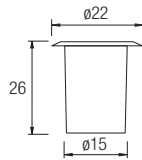

### 55-9323-Y4-37

G12 35W Halogenurs

IP 67 G0.5m IK 08

BAG Included

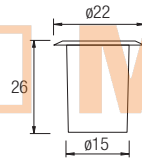
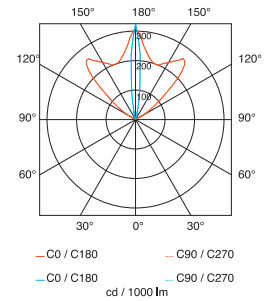

### 55-9187-Y4-37

G12 70W Halogenurs

IP 67 G0.5m IK 08

BAG Included

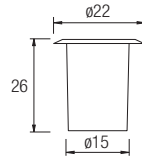
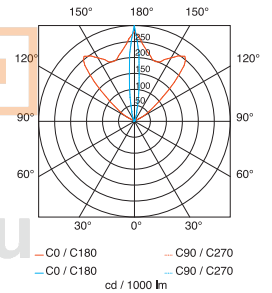

### 55-9395-Y4-37

G12 70W Halogenurs

IP 67 G0.5m IK 08

BAG Included

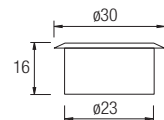
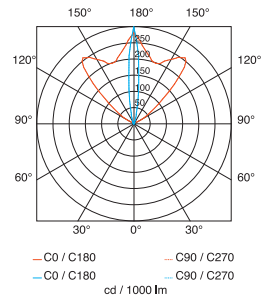

### 71-9187-Y4-37

Accesorio para 55-9187, 55-9323 y 55-9395  
Accessory for 55-9187, 55-9323 and 55-9395

2 IK 08



set completo / complete set

**55-9187-Y4-37 + 71-9187-Y4-37**

set completo / complete set

**55-9323-Y4-37 + 71-9187-Y4-37**

set completo / complete set

**55-9395-Y4-37 + 71-9187-Y4-37**



**Materiales / Materials**



**Incluido / Included**



**Especificaciones / Specifications**

IP 67 CE RF 850° IK 08



**Acabados / Finishes**

Y4 Acero inoxidable  
Stainless steel

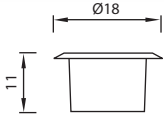

**55-9337-Y4-37**

G-53 75W Hal. 12V.

IP 67 IK 08



QR-R 111 50W 24D

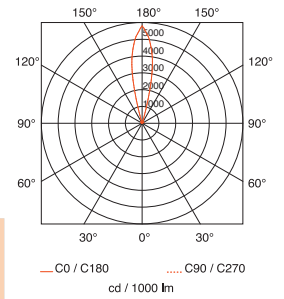

# MODULO

ELECTRO

[www.modulelectro.ru](http://www.modulelectro.ru)

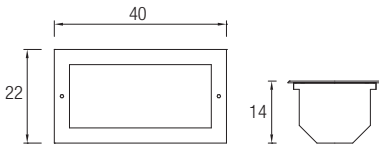

**55-9384-Y4-37**

2 x G-53 50W Hal. 12V.

IP 67 IK 08



QR-R 111 50W 24D

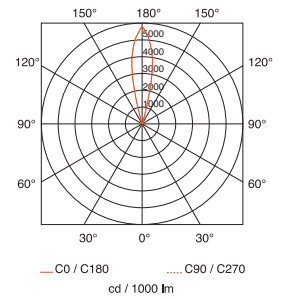

/ESPECIFICACIONES TÉCNICAS/  
/TECHNICAL SPECIFICATIONS/

**ELECTRO**  
[www.modulelectro.ru](http://www.modulelectro.ru)

**n° 01**

QR-CBC51 35W 10°  
η=100 %

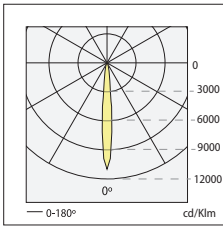

H (m)	Emed (lux)	D (m)
1	5066.55	0.18
2	1266.64	0.36
3	562.95	0.55
4	316.66	0.73

**n° 02**

QR-CBC51 35W 24°  
η=100 %

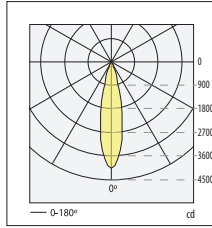

H (m)	Emed (lux)	D (m)
1	1854.86	0.43
2	463.71	0.86
3	206.10	1.28
4	115.93	1.71

**n° 03**

QR-CBC51 35W 36°  
η=100 %

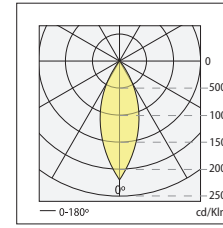

H (m)	Emed (lux)	D (m)
1	877.59	0.69
2	219.40	1.38
3	97.51	2.07
4	54.85	2.75

**n° 04**

QR-CBC51 35W 60°  
η=100 %

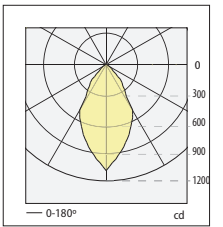

H (m)	Emed (lux)	D (m)
1	389.23	1.15
2	96.06	2.31
3	42.69	3.46
4	24.01	4.62

**n° 05**

QR-CBC51 50W 10°  
η=100 %

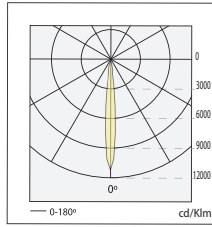

H (m)	Emed (lux)	D (m)
1	6237.31	0.18
2	1559.33	0.36
3	693.03	0.55
4	389.83	0.73

**n° 06**

QR-CBC51 50W 24°  
η=100 %

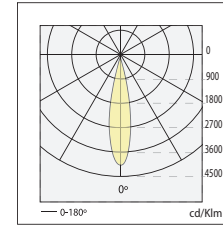

H (m)	Emed (lux)	D (m)
1	2568.26	0.43
2	642.07	0.86
3	285.36	1.28
4	160.52	1.71

**n° 07**

QR-CBC51 50W 36°  
η=100 %

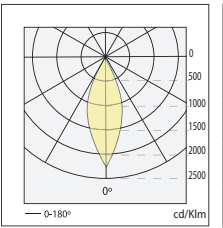

H (m)	Emed (lux)	D (m)
1	1350.14	0.69
2	337.53	1.38
3	150.02	2.07
4	84.38	2.75

**n° 08**

QR-CBC51 50W 60°  
η=100 %

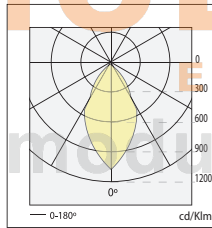

H (m)	Emed (lux)	D (m)
1	591.13	1.15
2	275.00	2.31
3	122.22	3.46
4	68.95	4.62

**n° 09**

QR-111 60W 8°  
η=100 %

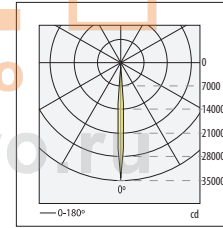

H (m)	Emed (lux)	D (m)
1	34096.61	0.12
2	8524.15	0.24
3	3788.35	0.36
4	2131.04	0.48

**n° 10**

QR-111 60W 24°  
η=100 %

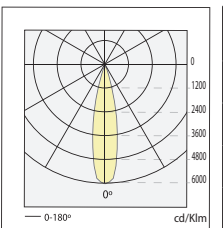

H (m)	Emed (lux)	D (m)
1	6057.03	0.40
2	1514.26	0.80
3	673.00	1.20
4	378.56	1.59

**n° 11**

QR-111 60W 45°  
η=100 %

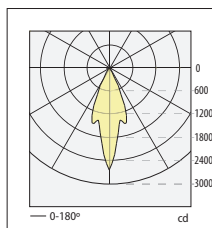

H (m)	Emed (lux)	D (m)
1	1623.45	0.83
2	405.86	1.66
3	190.38	2.49
4	101.47	3.32

**n° 12**

QR-111 100W 8°  
η=100 %

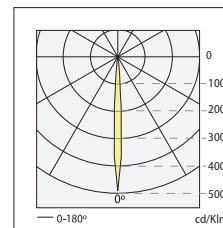

H (m)	Emed (lux)	D (m)
1	34123.65	0.11
2	8530.91	0.23
3	3791.52	0.34
4	2132.73	0.46

**n° 14**

QR-111 G53 100W 45°  
η=100 %

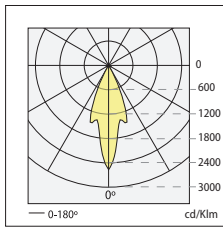

H (m)	Emed (lux)	D (m)
1	1512.03	0.73
2	378.01	1.46
3	168.00	2.18
4	94.50	2.91

**n° 15**

CDM-R111 35W 10°  
η=100 %

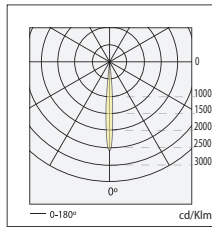

H (m)	Emed (lux)	D (m)
1	21476	0.15
1.5	9545	0.23
3	5369	0.30
4	2386.5	0.45

**n° 16**

CDM-R111 35W 24°  
η=100 %

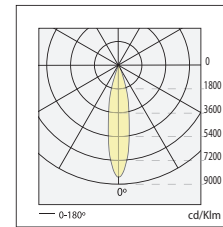

H (m)	Emed (lux)	D (m)
1	9331.27	0.38
2	2332.82	0.75
3	1036.81	1.13
4	583.20	1.51

**n° 17**  
CDM-R111 35W 40°  
η=100 %

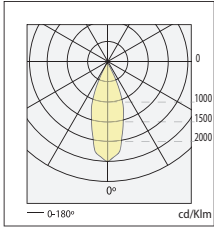

H (m)	Emed (lux)	D (m)
1	2376.5	0.69
1.5	1056	1.03
2	594	1.38
3	264	2.07

**n° 18**  
CDM-R111 70W 10°  
η=100 %

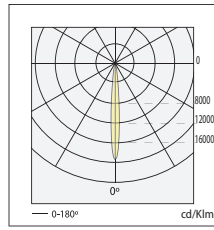

H (m)	Emed (lux)	D (m)
1	41523.4	0.17
1.5	18455	0.25
2	10380.5	0.34
3	4613.5	0.50

**n° 19**  
CDM-R111 70W 24°  
η=100 %

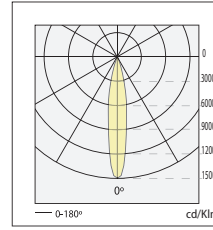

H (m)	Emed (lux)	D (m)
1	29205.14	0.38
2	7301.29	0.75
3	3245.02	1.13
4	1825.32	1.51

**n° 20**  
CDM-R111 70W 40°  
η=100 %

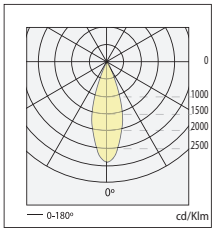

H (m)	Emed (lux)	D (m)
1	5956.5	0.62
1.5	2647.5	0.93
2	1489	1.25
3	661.5	1.87

**n° 21**  
MACH1 HIT-T 70W 10°  
η=56.000 %

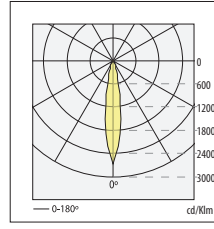

H (m)	Emed (lux)	D (m)
1	12507.38	0.32
2	3126.84	0.63
3	1389.71	0.95
4	781.71	1.26

**n° 22**  
MACH1 HIT-T 150W 45°  
η=50.500 %

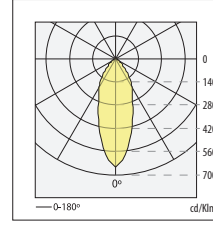

H (m)	Emed (lux)	D (m)
1	5896.75	0.69
2	1454.19	1.38
3	646.31	2.08
4	363.55	2.77

**n° 23**  
DUPLO HIT-TC 70W  
η=60.200 %

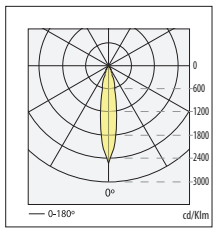

H (m)	Emed (lux)	D (m)
1	11790.41	0.35
2	2947.60	0.70
3	1310.05	1.05
4	736.90	1.40

**n° 24**  
DUPLO QT-TC 60W  
η=60.200 %

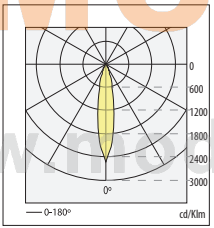

H (m)	Emed (lux)	D (m)
1	2858.28	0.35
2	714.57	0.70
3	317.59	1.05
4	178.64	1.40

**n° 25**  
DUPLO 8x PowerLed 1W  
η=87.54 %

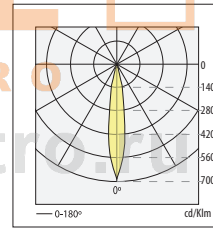

H (m)	Emed (lux)	D (m)
1	1690.78	0.31
2	422.70	0.63
3	187.86	0.94
4	105.67	1.25

**n° 26**  
TRIMIUM HIT-DE 70W  
η=65.600 %

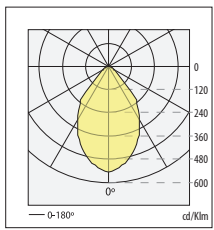

H (m)	Emed (lux)	D (m)
1	1831.35	1.27
2	457.84	2.55
3	203.48	3.82
4	114.96	5.09

**n° 27**  
TRIMIUM 2x18W  
η=66.600 %

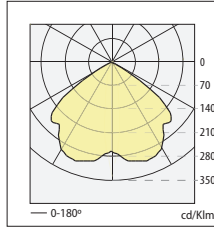

H (m)	Emed (lux)	D (m)
1	229.52	2.86
2	59.38	5.72
3	25.50	8.58
4	14.35	11.44

**n° 28**  
TRIMIUM E HIT-T 150W 12°  
η=80.100 %

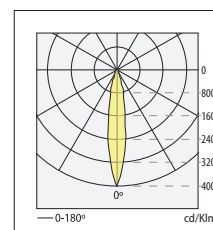

H (m)	Emed (lux)	D (m)
1	39001.26	0.32
2	9750.32	0.64
3	4333.97	0.95
4	2437.58	1.27

**n° 29**  
TRIMIUM E HIT-T 150W 40°  
η=70.600 %

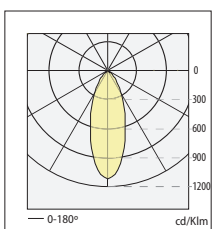

H (m)	Emed (lux)	D (m)
1	9906.60	0.70
2	2476.65	1.40
3	1100.73	2.10
4	619.16	2.80

**n° 30**  
TRIMIUM S130 HIT-TC 70W  
η=57.900 %

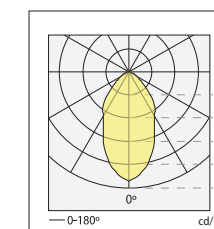

H (m)	Emed (lux)	D (m)
1	1820.12	1.07
2	455.03	2.14
3	202.24	3.22
4	113.76	4.29

**n° 31**  
TRIMIUM S130 QT-TC 60W  
η=64.900 %

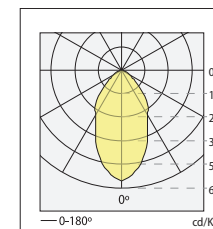

H (m)	Emed (lux)	D (m)
1	614.31	1.09
2	153.58	2.19
3	68.26	3.28
4	38.39	4.38



**n° 32**

TRIMIUM S100 QT-12 100W + ACT-0291  
 $\eta=48.500\%$

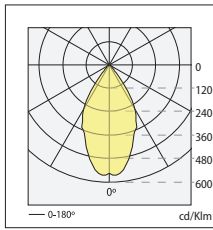

H (m)	Emed (lux)	D (m)
1	855.63	1.07
2	213.91	2.13
3	95.07	3.20
4	53.48	4.26

**n° 33**

TRIMIUM S100 CDM-Tm 20W  
 $\eta=67.640\%$

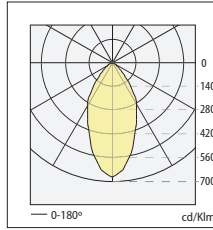

H (m)	Emed (lux)	D (m)
1	585.65	0.98
2	146.41	1.97
3	65.07	2.95
4	36.60	3.94

**n° 34**

RAPID C HIT-DE 70W  
 $\eta=53.900\%$

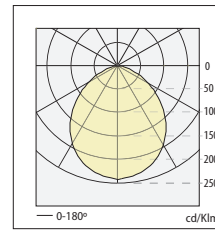

H (m)	Emed (lux)	D (m)
1	540.45	2.06
2	135.11	4.13
3	60.05	6.19
4	33.78	8.26

**n° 35**

CUADRO1 1x18W + ACT-0253-B9  
 $\eta=44.710\%$

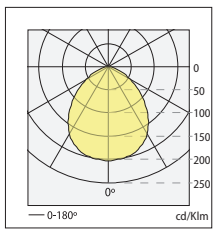

H (m)	Emed (lux)	D (m)
1	104.72	2.12
2	26.18	4.24
3	11.64	6.35
4	6.54	8.47

**n° 36**

CUADRO1 1x18W + ACT-0253-H6  
 $\eta=50.570\%$

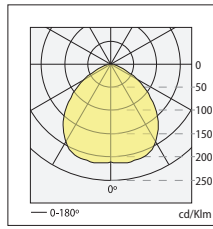

H (m)	Emed (lux)	D (m)
1	99.98	2.44
2	24.91	4.87
3	11.11	7.31
4	6.25	9.75

**n° 37**

CUADRO2 2x26W + ACT-0258-B9  
 $\eta=38.660\%$

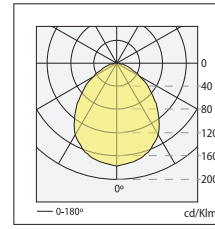

H (m)	Emed (lux)	D (m)
1	273.02	2.10
2	68.26	4.20
3	30.34	6.30
4	17.06	8.40

**n° 38**

CUADRO2 2x26W + ACT-0258-H6  
 $\eta=44.200\%$

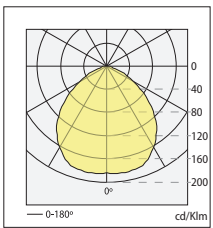

H (m)	Emed (lux)	D (m)
1	261.78	2.42
2	65.45	4.84
3	28.09	7.25
4	16.36	9.67

**n° 39**

CARDEX E QT-12 100W  
 $\eta=57.000\%$

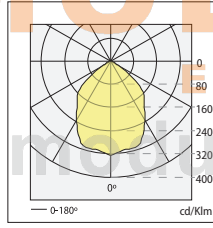

H (m)	Emed (lux)	D (m)
1	379.75	1.82
2	91.94	3.64
3	42.19	5.46
4	23.73	7.28

**n° 40**

CARDEX E HIT-TC 70W  
 $\eta=59.900\%$

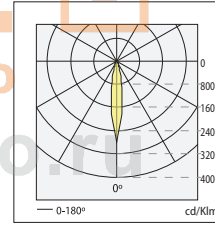

H (m)	Emed (lux)	D (m)
1	12939.19	0.32
2	3234.87	0.65
3	1437.72	0.97
4	808.72	1.29

**n° 41**

CARDEX C HIT-T 70W 10°  
 $\eta=69.600\%$

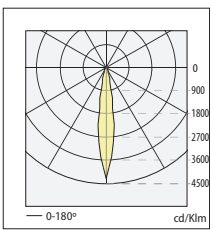

H (m)	Emed (lux)	D (m)
1	19057.38	0.28
2	4764.34	0.56
3	2117.49	0.84
4	1191.09	1.12

**n° 42**

CARDEX C HIT-T 70W 45°  
 $\eta=59.400\%$

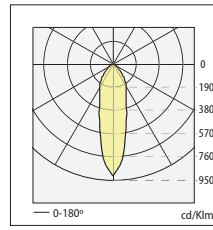

H (m)	Emed (lux)	D (m)
1	4030.65	0.52
2	1007.65	1.03
3	447.85	1.55
4	251.92	2.07

**n° 43**

QR-70 50W 8°  
 $\eta=100\%$

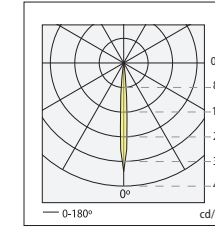

H (m)	Emed (lux)	D (m)
1	8920.82	0.13
2	2230.20	0.26
3	991.20	0.38
4	557.55	0.51

**n° 44**

QR-70 50W 24°  
 $\eta=100\%$

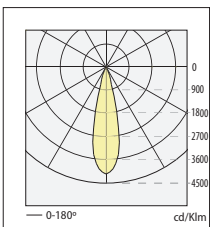

H (m)	Emed (lux)	D (m)
1	1901.47	0.46
2	475.37	0.93
3	211.27	1.39
4	118.84	1.86

**n° 45**

CARDEX CM CDM-Tm 20W 12°  
 $\eta=70.500\%$

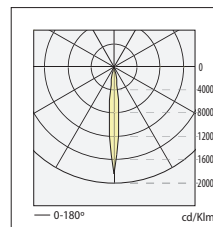

H (m)	Emed (lux)	D (m)
1	19170.46	0.20
2	4792.62	0.40
3	2130.05	0.60
4	1198.15	0.81

**n° 46**

CARDEX CM CDM-Tm 20W 36°  
 $\eta=68.400\%$

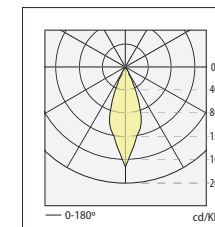

H (m)	Emed (lux)	D (m)
1	1588.58	0.68
2	397.14	1.35
3	176.51	2.03
4	99.29	2.71

**n° 47**  
VITRO HIT-DE 70W  
 $\eta=72.800\%$

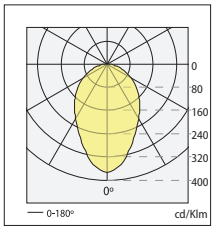

H (m)	Emed (lux)	D (m)
1	1114.46	1.69
2	278.62	3.37
3	123.83	5.06
4	69.65	6.75

**n° 48**  
SATIN 26W  
 $\eta=37.400\%$

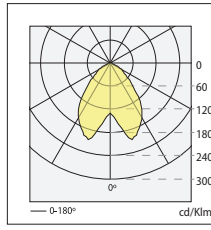

H (m)	Emed (lux)	D (m)
1	183.94	1.81
2	45.98	3.61
3	20.44	5.42
4	11.50	7.22

**n° 49**  
LEDIO PowerLed 1W 15°  
 $\eta=95.000\%$

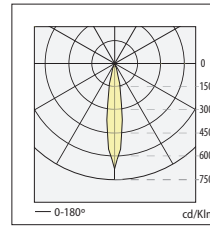

H (m)	Emed (lux)	D (m)
1	223.53	0.30
2	55.88	0.61
3	24.84	0.91
4	13.97	1.22

**n° 50**  
LEDIO PowerLed 1,2W 50°  
 $\eta=91.000\%$

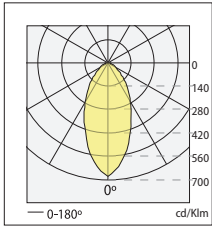

H (m)	Emed (lux)	D (m)
1	16.92	0.96
2	4.23	1.92
3	1.88	2.88
4	1.06	3.84

**n° 51**  
LEDIO PowerLed 3W 15°  
 $\eta=91.330\%$

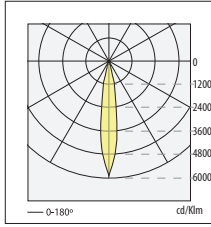

H (m)	Emed (lux)	D (m)
1	265.85	0.28
2	64.21	0.56
3	28.54	0.84
4	16.05	1.13

**n° 52**  
SIGN HALOPIN G9  
 $\eta=12.760\%$

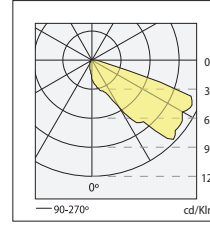

H (m)	Emed (lux)	D (m)
1	1.24	6.63
2	0.31	13.27
3	0.14	19.90
4	0.08	26.53

**n° 53**  
SIGN PowerLed 1W  
 $\eta=20.220\%$

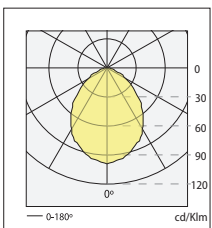

H (m)	Emed (lux)	D (m)
1	1.92	2.00
2	0.49	4.00
3	0.22	6.00
4	0.12	8.00

**n° 54**  
TRIMIUM HIT-DE 150W  
 $\eta=65.6\%$

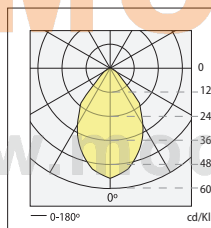

H (m)	Emed (lux)	D (m)
1	3662.71	1.27
2	915.68	2.55
3	406.97	3.82
4	228.92	5.09

**n° 55**  
TRIMIUM TC-D 2X26W sin cristal / without glass  
 $\eta=66.6\%$

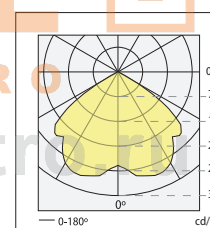

H (m)	Emed (lux)	D (m)
1	344.28	2.86
2	86.07	5.72
3	38.25	8.58
4	21.52	11.44

**n° 56**  
TRIMIUM TC-TEL 26W sin cristal / without glass  
 $\eta=66.1\%$

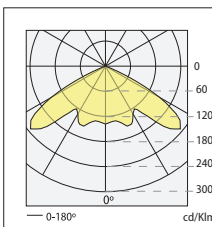

H (m)	Emed (lux)	D (m)
1	110.91	3.58
2	27.73	7.17
3	12.32	10.75
4	6.93	14.33

**n° 57**  
TRIMIUM TC-TEL 2X26W sin cristal / without glass  
 $\eta=63.3\%$

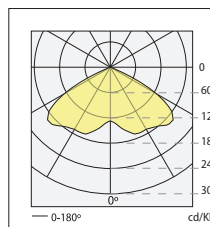

H (m)	Emed (lux)	D (m)
1	206.37	3.65
2	51.59	7.30
3	22.93	10.95
4	12.90	14.59

**n° 58**  
RAPID C TC-TEL 2X26W  
 $\eta=20.54\%$

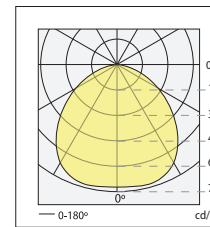

H (m)	Emed (lux)	D (m)
1	90.69	2.80
2	22.67	5.60
3	10.08	8.41
4	5.67	11.21

**n° 59**  
CUADRO TC-TEL 2X26W con reflector B9 / with B9 reflector  
 $\eta=44.91\%$

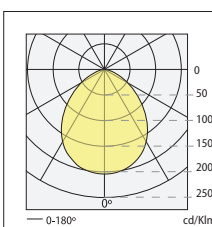

H (m)	Emed (lux)	D (m)
1	314.19	2.13
2	78.55	4.27
3	34.91	6.40
4	19.64	8.53

**n° 60**  
CUADRO TC-TEL 2X26W con reflector H6 / with H6 reflector  
 $\eta=51.12\%$

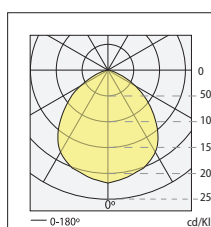

H (m)	Emed (lux)	D (m)
1	314.94	2.37
2	78.73	4.74
3	34.99	7.10
4	19.68	9.47

**n° 61**  
VITRO HIT-DE 150W  
 $\eta=72.8\%$

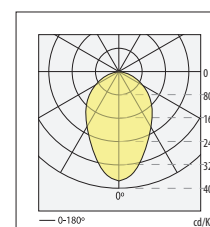

H (m)	Emed (lux)	D (m)
1	2057.47	1.69
2	514.37	3.37
3	228.61	5.06
4	128.59	6.75

**n° 62**

VITRO QT-DE 150W  
 $\eta=72.800\%$

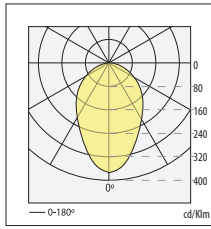

H (m)	Emed (lux)	D (m)
1	385.78	1.69
2	96.44	3.37
3	42.86	5.06
4	24.11	6.75

**n° 63**

EXTRA HIT-TC G8.5 70W  
 $\eta=51.900\%$

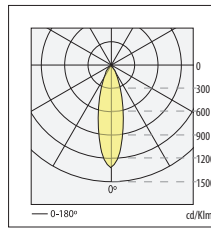

H (m)	Emed (lux)	D (m)
1	5764.07	0.51
2	1441.02	1.01
3	640.45	1.52
4	360.25	2.02

**n° 64**

EXTRA Masterline-TC G8.5 60W  
 $\eta=49.210\%$

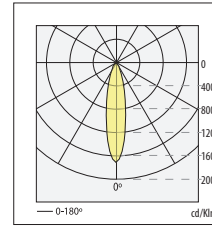

H (m)	Emed (lux)	D (m)
1	1870.18	0.40
2	683.63	0.79
3	303.83	1.19
4	170.91	1.59

**n° 68**

WALL QT-DE 100W  
 $\eta=16.620\%$

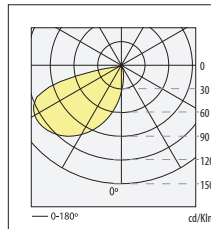

H (m)	Emed (lux)	D (m)
1	6.65	8.02
2	1.41	16.05
3	0.63	24.07
4	0.35	32.09

**n° 69**

SIGNO QR-CBC 51 50W  
 $\eta=71.700\%$

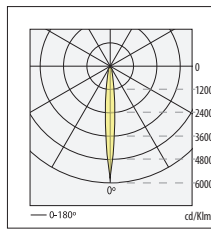

H (m)	Emed (lux)	D (m)
1	3462.45	0.17
2	865.61	0.34
3	384.72	0.51
4	216.40	0.68

**n° 70**

RECTA T5 24W  
 $\eta=39.180\%$

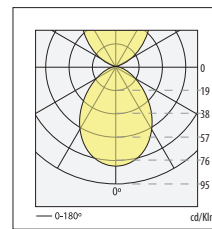

H (m)	Emed (lux)	D (m)
1	70.45	2.02
2	17.61	4.04
3	7.83	18.25
4	4.40	10.27

**n° 72**

RECTA T5 54W  
 $\eta=42.560\%$

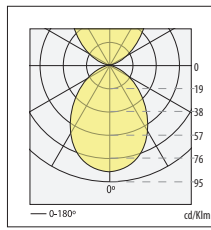

H (m)	Emed (lux)	D (m)
1	180.50	2.11
2	45.13	4.22
3	20.06	6.33
4	11.28	8.45

**n° 73**

RECTA T5 24W  
 $\eta=28.830\%$

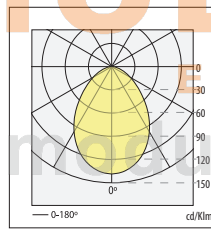

H (m)	Emed (lux)	D (m)
1	125.76	1.91
2	31.44	3.82
3	13.97	5.73
4	7.86	7.64

**n° 74**

RECTA T5 39W  
 $\eta=24.940\%$

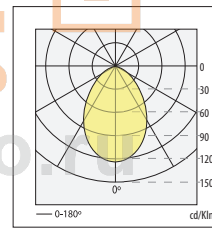

H (m)	Emed (lux)	D (m)
1	198.53	1.82
2	49.63	3.69
3	22.06	5.54
4	12.41	7.39

**n° 75**

RECTA T5 54W  
 $\eta=29.620\%$

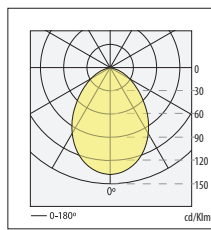

H (m)	Emed (lux)	D (m)
1	297.26	2.00
2	74.31	4.01
3	33.03	6.01
4	18.58	8.01

**n° 76**

RECTA T5 24W  
 $\eta=28.830\%$

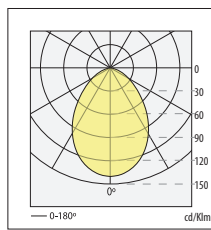

H (m)	Emed (lux)	D (m)
1	125.76	1.91
2	31.44	3.82
3	13.97	5.73
4	7.86	7.64

**n° 77**

RECTA T5 39W  
 $\eta=24.940\%$

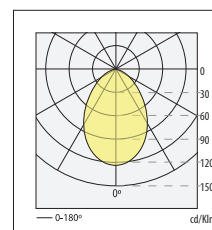

H (m)	Emed (lux)	D (m)
1	198.53	1.82
2	49.63	3.69
3	22.06	5.54
4	12.41	7.39

**n° 78**

RECTA T5 54W  
 $\eta=29.620\%$

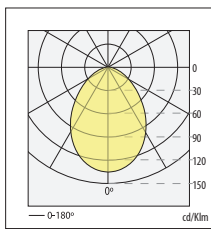

H (m)	Emed (lux)	D (m)
1	297.26	2.00
2	74.31	4.01
3	33.03	6.01
4	18.58	8.01

**n° 79**

MACH1 HIT-T 35W 10°  
 $\eta=56\%$

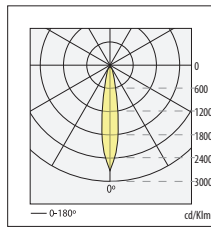

H (m)	Emed (lux)	D (m)
1	6253.69	0.32
2	1563.42	0.63
3	694.85	0.95
4	390.86	1.26

**n° 80**

MACH1 HIT-T 150W 10°  
 $\eta=56\%$

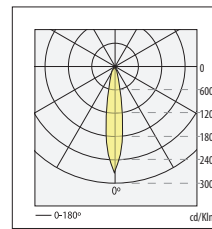

H (m)	Emed (lux)	D (m)
1	26530.80	0.32
2	6632.70	0.63
3	2947.87	0.95
4	1658.18	1.26

**n° 81**  
MACH1 HIT-T 35W 45°  
 $\eta=50.500\%$

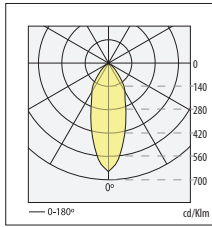

H (m)	Emed (lux)	D (m)
1	1371.09	0.69
2	342.77	1.38
3	152.34	2.08
4	85.69	2.77

**n° 82**  
MACH1 HIT-T 70W 45°  
 $\eta=50.500\%$

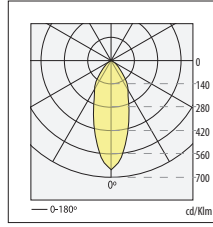

H (m)	Emed (lux)	D (m)
1	2742.18	0.69
2	685.55	1.38
3	304.69	2.08
4	171.39	2.77

**n° 83**  
FILIPA P QT-TC 60W  
 $\eta=70\%$

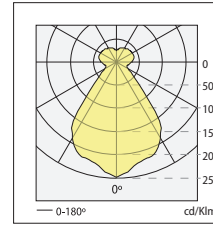

H (m)	Emed (lux)	D (m)
1	211.76	1.63
2	52.94	3.26
3	23.53	4.88
4	13.23	6.51

**n° 84**  
FILIPA HIT-T 70W con reflector B9  
 $\eta=73.400\%$

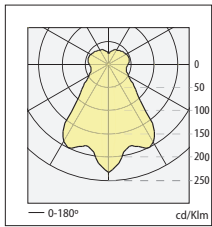

H (m)	Emed (lux)	D (m)
1	783.24	1.63
2	195.81	3.26
3	87.63	4.89
4	48.95	6.51

**n° 85**  
FILIPA G PL-H 120W con reflector B9  
 $\eta=78.600\%$

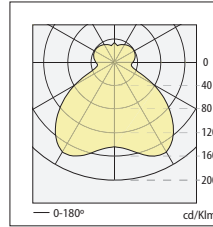

H (m)	Emed (lux)	D (m)
1	459.93	3.27
2	114.98	6.53
3	51.10	9.80
4	28.75	13.06

**n° 86**  
FILIPA G HIT-T 70W con reflector S2 / with S2 reflector  
 $\eta=54.200\%$

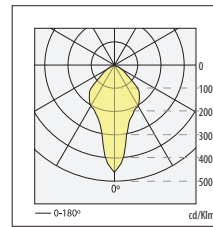

H (m)	Emed (lux)	D (m)
1	1725.71	0.70
2	431.43	1.40
3	191.75	2.10
4	107.86	2.80

**n° 87**  
HIT-T 35W-10° BUBO PR-0909  
 $\eta=70.5\%$

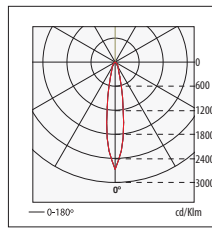

H (m)	Emed (lux)	D (m)
1	6253.42	0.32
2	1563.42	0.63
3	694.85	0.95
4	390.86	1.26

**n° 88**  
HIT-T 35W-45° BUBO PR-0910  
 $\eta=68.4\%$

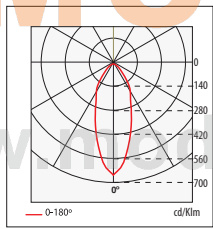

H (m)	Emed (lux)	D (m)
1	1371.09	0.69
2	342.77	1.38
3	152.34	2.08
4	85.69	2.77

**n° 89**  
HIT-T 70W-10° BUBO PR-0911  
 $\eta=68.4\%$

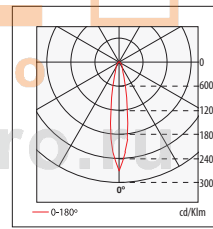

H (m)	Emed (lux)	D (m)
1	12507.38	0.32
2	3126.84	0.63
3	1389.71	0.95
4	781.71	1.26

**n° 90**  
HIT-T 70W-45° BUBO PR-0912  
 $\eta=68.4\%$

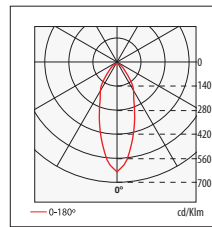

H (m)	Emed (lux)	D (m)
1	2742.18	0.69
2	685.55	1.38
3	304.69	2.08
4	171.39	2.77

**n° 91**  
HIT-T 150W-10° BUBO PR-0913  
 $\eta=70.5\%$

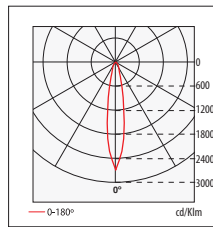

H (m)	Emed (lux)	D (m)
1	26530.80	0.32
2	6632.70	0.63
3	2947.87	0.95
4	1658.18	1.26

**n° 92**  
HIT-T 150W-45° BUBO PR-0914  
 $\eta=68.4\%$

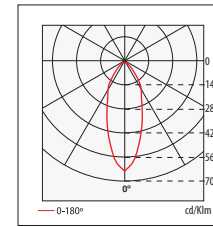

H (m)	Emed (lux)	D (m)
1	5816.75	0.69
2	1454.19	1.38
3	646.31	2.08
4	363.55	2.77

**n° 93**  
TL5 G5-3x14W BORBOLETA AD-0616  
 $\eta=61,52\%$

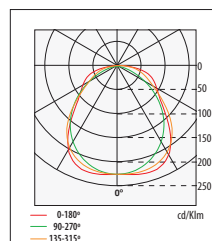

H (m)	Emed (lux)	D (m)
1	314.09	2.46
2	78.52	4.92
3	34.90	7.38
4	19.63	9.84

**n° 94**  
TL5 G5-2x14W BORBOLETA  
 $\eta=61,52\%$

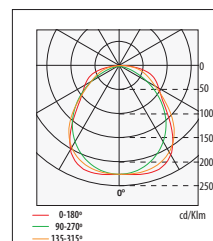

H (m)	Emed (lux)	D (m)
1	209.39	2.46
2	52.35	4.92
3	23.27	7.38
4	13.09	9.84

**n° 95**  
TL5 G5-3x24W BORBOLETA  
 $\eta=61,52\%$

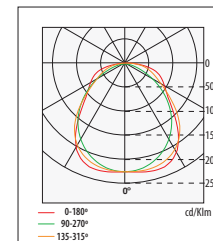

H (m)	Emed (lux)	D (m)
1	485.05	2.46
2	114.51	4.92
3	50.89	7.38
4	28.63	9.84

**nº 96**

TL5 G5-2x24W BORBOLETA  
 $\eta=61,52\%$

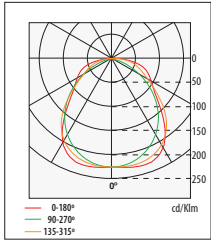

H (m)	Emed (lux)	D (m)
1	305.37	2.46
2	76.34	4.92
3	33.93	7.38
4	19.09	9.84

**nº 97**

TL5 G5-3x14W BORBOLETA  
 $\eta=61,52\%$

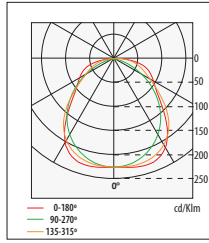

H (m)	Emed (lux)	D (m)
1	314.09	2.46
2	78.52	4.92
3	34.90	7.38
4	19.63	9.84

**nº 98**

TL5 G5-2x14W BORBOLETA  
 $\eta=61,52\%$

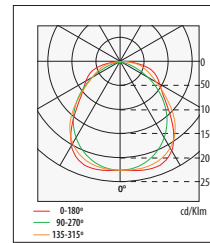

H (m)	Emed (lux)	D (m)
1	209.39	2.46
2	52.35	4.92
3	23.27	7.38
4	13.09	9.84

**nº 99**

TL5 G5-3x24W BORBOLETA  
 $\eta=61,52\%$

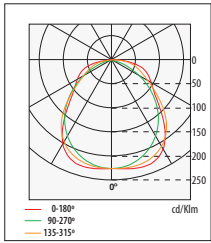

H (m)	Emed (lux)	D (m)
1	458.05	2.46
2	114.51	4.92
3	50.89	7.38
4	28.63	9.84

**nº 100**

TL5 G5-2x24W BORBOLETA  
 $\eta=61,52\%$

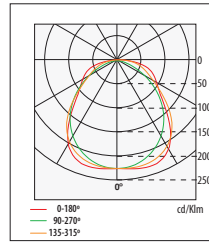

H (m)	Emed (lux)	D (m)
1	305.37	2.46
2	76.34	4.92
3	33.93	7.38
4	19.09	9.84

**nº 101**

Blanco cálido / Warm white - 3w - 15º BIT 05-3308  
 $\eta=100\%$

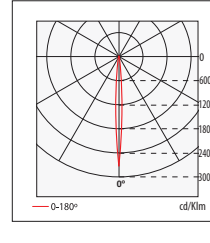

H (m)	Emed (lux)	D (m)
1	2119	0.11
2	530	0.23
3	235	0.34
4	132	0.46
5	85	0.57

**nº 102**

CUADRO HIT DE 70W  
 $\eta=43,74\%$

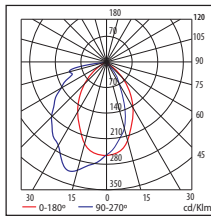

H (m)	Emed (lux)	D (m)
1	550	1.40
2	138	2.80
3	61	4.20
4	34	5.60
5	22	7.00

**nº 103**

Blanco cálido / Warm white - 12w - 40º DELTA 6 90-3427  
 $\eta=100\%$

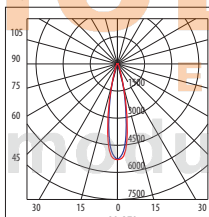

H (m)	Emed (lux)	D (m)
1	1803	0.39
2	451	0.78
3	200	1.16
4	113	1.54
5	72	1.93

**nº 104**

Blanco cálido / Warm white - 18w - 40º DELTA 9 90-3428  
 $\eta=100\%$

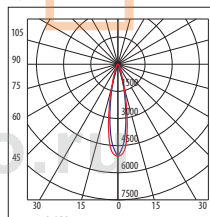

H (m)	Emed (lux)	D (m)
1	2244	0.39
2	561	0.78
3	249	1.17
4	140	1.56
5	90	1.95

**nº 105**

Blanco cálido pmma / Warm white pmma SOUND 90-3429  
 $\eta=74,43\%$

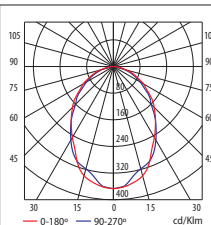

H (m)	Emed (lux)	D (m)
1	307	1.85
2	77	3.69
3	34	5.54
4	19	7.38
5	12	9.23

**nº 106**

Blanco cálido cristal / Warm white glass SOUND 90-3429  
 $\eta=63,53\%$

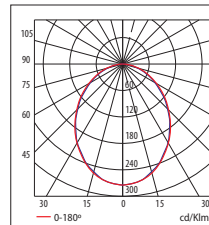

H (m)	Emed (lux)	D (m)
1	230	2.18
2	58	4.37
3	26	6.55
4	14	8.74
5	9	10.92

**nº 107**

Blanco frío pmma / Cold white pmma SOUND 90-3430  
 $\eta=73,17\%$

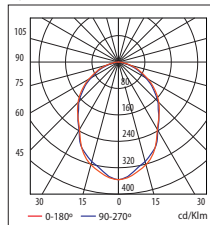

H (m)	Emed (lux)	D (m)
1	391	1.91
2	98	3.81
3	43	5.72
4	24	7.62
5	16	9.53

**nº 108**

Blanco frío cristal / Cold white glass SOUND 90-3430  
 $\eta=62,08\%$

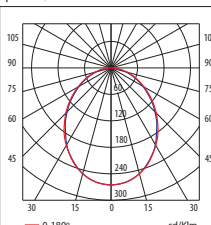

H (m)	Emed (lux)	D (m)
1	291	2.23
2	73	4.45
3	32	6.68
4	18	8.90
5	12	11.13

**nº 109**

CAMALEON DN-1301 GX24q-3  
 $\eta=50,01\%$

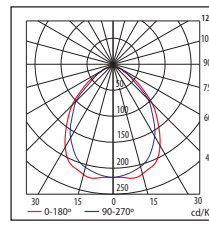

H (m)	Emed (lux)	D (m)
1	368	2.28
2	92	4.56
3	41	6.84
4	23	9.12
5	15	11.39

**nº 110**

DM-0044-14-00 SATIN 1x32W TC-TEL opal  
 $\eta=28,89\%$

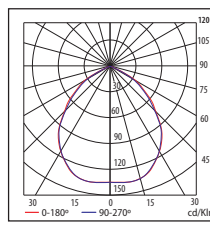

H (m)	Emed (lux)	D (m)
1	114	2.22
2	29	4.44
3	13	6.67
4	7	8.89
5	5	11.11

**n° 111**

DM-0045-14-00 SATIN 2x26W TC-TEL opal  
 $\eta=32,64\%$

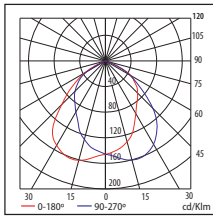

H (m)	Emed (lux)	D (m)
1	225	1.91
2	56	3.81
3	25	5.72
4	14	7.62
5	9	9.53

**n° 112**

DM-0046-14-00 SATIN 3x26W TC-TEL opal  
 $\eta=35,22\%$

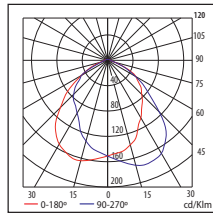

H (m)	Emed (lux)	D (m)
1	321	2.10
2	80	4.20
3	36	6.30
4	20	8.40
5	13	10.50

**n° 113**

DM-0047-14-00 SATIN 4x26W TC-TEL opal  
 $\eta=33,82\%$

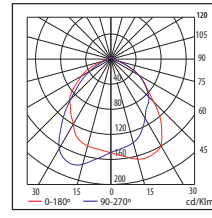

H (m)	Emed (lux)	D (m)
1	409	2.21
2	102	4.42
3	45	6.62
4	26	8.83
5	16	11.04

**n° 114**

DM-0058-14-00 SATIN 2x18  
 $\eta=21,99\%$

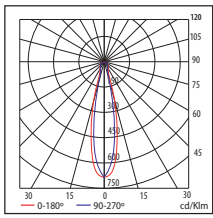

H (m)	Emed (lux)	D (m)
1	1266	0.44
2	317	0.89
3	141	1.33
4	79	1.78
5	51	2.22

**n° 115**

DM-0059-14-00 SATIN 2x24W  
 $\eta=27,26\%$

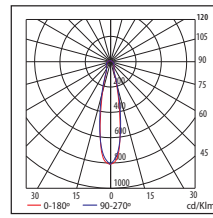

H (m)	Emed (lux)	D (m)
1	2461	0.37
2	615	0.74
3	273	1.11
4	154	1.48
5	98	1.85

**n° 116**

DM-0060-14-00 SATIN FC 22+40W 50W  
 $\eta=43,15\%$

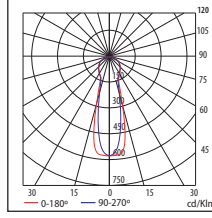

H (m)	Emed (lux)	D (m)
1	1927	0.55
2	482	1.09
3	214	1.64
4	120	2.18
5	77	2.73

**n° 117**

TRIMIUM S130 1x26W GX24q-3  
 $\eta=34,56\%$

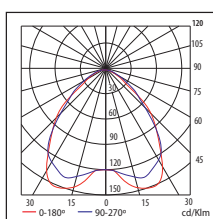

H (m)	Emed (lux)	D (m)
1	107	2.13
2	27	4.27
3	12	6.40
4	7	8.54
5	4	7.00

**n° 118**

DN-1400-14-00 ECO 18W TC-D opal  
 $\eta=64,34\%$

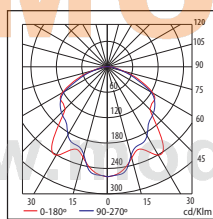

H (m)	Emed (lux)	D (m)
1	63	3.21
2	16	6.42
3	7	9.63
4	4	12.85
5	3	16.06

**n° 119**

DN-1401-14-00 ECO 2x18W TC-D opal  
 $\eta=54,75\%$

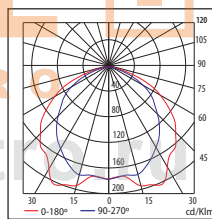

H (m)	Emed (lux)	D (m)
1	130	3.38
2	33	6.77
3	14	10.15
4	8	13.54
5	5	16.92

**n° 120**

DN-1402-14-00 1x26W G24d-3  
 $\eta=65,36\%$

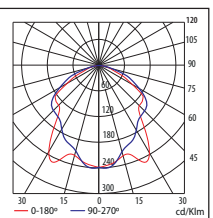

H (m)	Emed (lux)	D (m)
1	105	2.86
2	26	5.72
3	12	8.58
4	7	11.44
5	4	14.30

**n° 121**

DN-1403-14-00 2x26W G24d-3  
 $\eta=47,49\%$

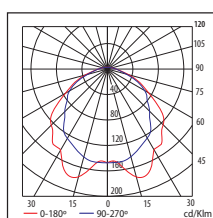

H (m)	Emed (lux)	D (m)
1	198	2.85
2	50	5.69
3	22	8.54
4	12	11.38
5	8	14.23

**n° 122**

DN-1406-14-00 ECO 2x18W G24q-2 dif. opal  
 $\eta=60,87\%$

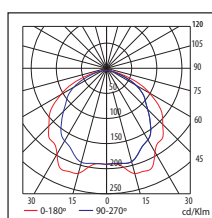

H (m)	Emed (lux)	D (m)
1	138	3.49
2	34	6.97
3	15	10.46
4	9	13.94
5	6	17.43

**n° 123**

DN-1407-14-00 ECO.1x26W G24q-2 dif. opal  
 $\eta=69,05\%$

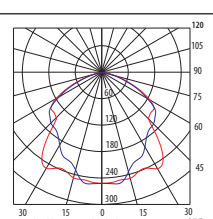

H (m)	Emed (lux)	D (m)
1	91	3.42
2	23	6.84
3	10	10.26
4	6	13.69
5	4	17.11

**n° 124**

DN-1408-14-00 2x26W G24q-3  
 $\eta=53,15\%$

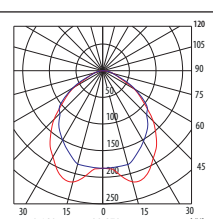

H (m)	Emed (lux)	D (m)
1	255	2.32
2	64	4.65
3	28	6.97
4	16	9.29
5	10	11.62

**n° 125**

EP-0344-N3-XY WALL 1x26W TC-TEL opal  
 $\eta=18,60\%$

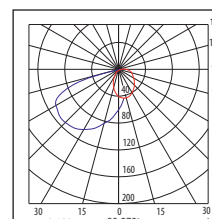

H (m)	Emed (lux)	D (m)
1	14	1.80
2	3	3.60
3	2	5.40
4	1	7.20
5	1	9.00

**n° 126**

EP-0347-N3-00 WALL 1x24W T5 opal  
 $\eta=47,80\%$

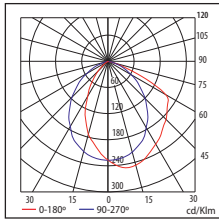

H (m)	Emed (lux)	D (m)
1	118	2.42
2	30	4.84
3	13	7.27
4	7	9.69
5	5	12.11

**n° 127**

EP-0348-00-00 SIGN 50W micro opal  
 $\eta=85,46\%$

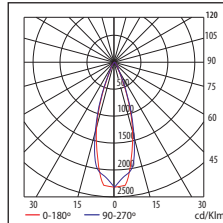

H (m)	Emed (lux)	D (m)
1	1342	0.58
2	336	1.16
3	149	1.75
4	84	2.33
5	54	2.91

**n° 128**

SP-0089-N3-37 FILIPA HIT-T 70W G12 dif.  
 con reflector 37 / with 37 reflector  
 $\eta=85,45\%$

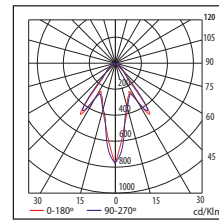

H (m)	Emed (lux)	D (m)
1	2704	0.50
2	676	1.01
3	300	1.51
4	169	2.01
5	108	2.52

**n° 129**

SP-0090-N3-37 FILIPA HIT-T 70W G12 dif.  
 $\eta=85,45\%$

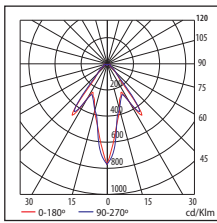

H (m)	Emed (lux)	D (m)
1	2704	0.50
2	676	1.01
3	300	1.51
4	169	2.01
5	108	2.52

**n° 130**

SP-0091-N3-37 FILIPA PL-H 85W 2G8  
 $\eta=85,64\%$

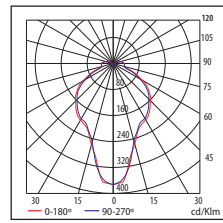

H (m)	Emed (lux)	D (m)
1	840	1.53
2	210	3.07
3	93	4.60
4	52	6.14
5	34	7.67

**n° 131**

SP-0092-N3-S2 FILIPA PL-H 85W 2G8  
 $\eta=68,94\%$

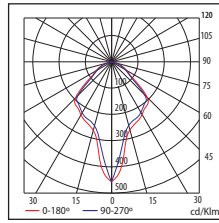

H (m)	Emed (lux)	D (m)
1	496	1.22
2	124	2.45
3	55	3.67
4	31	4.90
5	20	6.12

**n° 132**

SP-0108-N3-37 FILIPA halog 60W G8.5  
 $\eta=43,71\%$

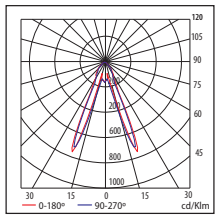

H (m)	Emed (lux)	D (m)
1	689	0.15
2	172	0.30
3	77	0.45
4	43	0.60
5	28	0.74

**n° 133**

LEDIO PowerLed 3W 50°  
 $\eta=97\%$

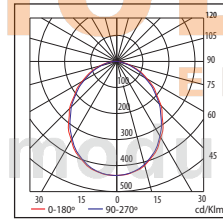







H (m)	Emed (lux)	D (m)
1	9	2.26
2	2	4.53
3	1	6.79
4	1	9.06
5	0	11.32

Symbol	Abbreviation	wattage	voltage	Lamp holder	Osram	Half peak	luminous intensity (lm flux (cd)	Colour temp. (°k)	IRC %	Average Life (h)	Philips	Half peak	luminous intensity (lm flux (cd)	Colour temp. (°k)	IRC %	Average Life (h)	
	Zvei	P(w)	U (v)			value °						value °					
	QR-LP 111																
		30W	12V	G53							MASTER Line 111	8°	2300cd	3000	100	4000	
		30W	12V	G53							MASTER Line 111	24°	4000cd	3000	100	4000	
		35W	12V	G53													
		35W	12V	G53	HALOSPOT 111	4°	3500cd	3000	100	3000							
		35W	12V	G53	HALOSPOT 111 IRC	8°	2250cd	3000	100	4000							
		35W	12V	G53	HALOSPOT 111	24°	2500cd	3000	100	3000							
		35W	12V	G53	HALOSPOT 111 IRC	24°	4500cd	3000	100	4000							
		45W	12V	G53							MASTER Line 111	8°	3300cd	3000	100	4000	
		45W	12V	G53							MASTER Line 111	24°	5300cd	3000	100	4000	
		45W	12V	G53							MASTER Line 111	45°	1900cd	3000	100	4000	
		50W	12V	G53	HALOSPOT 111	4°	4000cd	3000	100	3000							
		50W	12V	G53	HALOSPOT 111	8°	2000cd	3000	100	3000							
		50W	12V	G53	HALOSPOT 111 IRC	8°	3300cd	3000	100	4000	ALULINE Pro	8°	2300cd	3000	100	3000	
		50W	12V	G53	HALOSPOT 111	24°	4000cd	3000	100	3000							
		50W	12V	G53	HALOSPOT 111 IRC	24°	5800cd	3000	100	4000	ALULINE Pro	24°	4000cd	3000	100	3000	
		50W	12V	G53	HALOSPOT 111	45°	1400cd	3000	100	3000							
		50W	12V	G53	HALOSPOT 111 IRC	45°	2000cd	3000	100	4000							
		60W	12V	G53							MASTER Line 111	8°	4800cd	3000	100	4000	
		60W	12V	G53							MASTER Line 111	24°	8500cd	3000	100	4000	
		60W	12V	G53							MASTER Line 111	45°	2800cd	3000	100	4000	
	65W	12V	G53	HALOSPOT 111 IRC	8°	4500cd	3000	100	4000								
	65W	12V	G53	HALOSPOT 111 IRC	24°	8500cd	3000	100	4000								
	65W	12V	G53	HALOSPOT 111 IRC	45°	2800cd	3000	100	4000								
	75W	12V	G53	HALOSPOT 111	8°	3000cd	3000	100	3000	ALULINE Pro	8°	3000cd	3000	100	3000		
	75W	12V	G53	HALOSPOT 111	24°	5300cd	3000	100	3000	ALULINE Pro	24°	5300cd	3000	100	3000		
	75W	12V	G53	HALOSPOT 111	45°	2000cd	3000	100	3000	ALULINE Pro	45°	-	3000	100	3000		
	100W	12V	G53	HALOSPOT 111	8°	4800cd	3000	100	3000	ALULINE Pro	8°	4800cd	3000	100	3000		
	100W	12V	G53	HALOSPOT 111	24°	8500cd	3000	100	3000	ALULINE Pro	24°	8500cd	3000	100	3000		
	100W	12V	G53	HALOSPOT 111	45°	2800cd	3000	100	3000	ALULINE Pro	45°	-	3000	100	3000		
	QR-LP 70																
		20W	12V	BA 15d 70	HALOSPOT 70	8°	7700cd	3000	100	3000							
		20W	12V	BA 15d 70	HALOSPOT 70	24°	900cd	3000	100	3000							
		50W	12V	BA 15d 70	HALOSPOT 70	8°	12500cd	3000	100	3000							
		50W	12V	BA 15d 70	HALOSPOT 70	24°	2600cd	3000	100	3000							
	QR-CBC51																
		20W	12V	GU 5,3							MASTER LINE ES	8°	6500cd	3000	100	5000	
		20W	12V	GU 5,3	DECOSTAR 51 TITAN	10°	5000cd	3000	100	4000	BRILLANTINE Pro	10°	5000cd	3000	100	4000	
		20W	12V	GU 5,3	DECOSTAR 51 IRC	10°	6000cd	3000	100	5000	BRILLANTINE Pro	24°	1800cd	3000	100	4000	
		20W	12V	GU 5,3	DECOSTAR 51 IRC	24°	2300cd	3000	100	5000	BRILLANTINE Pro	30°	780cd	3000	100	4000	
		20W	12V	GU 5,3	DECOSTAR 51 TITAN	36°	780cd	3000	100	4000	BRILLANTINE Pro	36°	780cd	3000	100	4000	
		20W	12V	GU 5,3	DECOSTAR 51 IRC	36°	1000cd	3000	100	5000	MASTER LINE ES	36°	1000cd	3000	100	5000	
		30W	12V	GU 5,3	DECOSTAR 51 TITAN	60°	350cd	3000	100	4000	BRILLANTINE Pro	60°	350cd	3000	100	5000	
		20W	12V	GU 5,3	DECOSTAR 51 IRC	60°	450cd	3000	100	5000							
		30W	12V	GU 5,3							MASTER LINE ES	8°	1100cd	3000	100	5000	
		30W	12V	GU 5,3							MASTER LINE ES	24°	3350cd	3000	100	5000	
		30W	12V	GU 5,3							MASTER LINE ES	36°	1600cd	3000	100	5000	
		30W	12V	GU 5,3							MASTER LINE ES	60°	750cd	3000	100	5000	
		35W	12V	GU 5,3							MASTER LINE ES	8°	1400cd	3000	100	5000	
		35W	12V	GU 5,3	DECOSTAR 51 TITAN	10°	9100cd	3000	100	4000	BRILLANTINE Pro	10°	10000cd	3000	100	4000	
		35W	12V	GU 5,3	DECOSTAR 51 IRC	10°	12500cd	3000	100	5000	BRILLANTINE Pro	10°	8000cd	3000	100	4000	
		35W	12V	GU 5,3	DECOSTAR 51 TITAN	24°	3100cd	3000	100	4000	BRILLANTINE Pro	24°	3100cd	3000	100	4000	
		35W	12V	GU 5,3	DECOSTAR 51 IRC	24°	4400cd	3000	100	5000	MASTER LINE ES	24°	4400cd	3000	100	5000	
		35W	12V	GU 5,3	DECOSTAR 51 TITAN	36°	1500cd	3000	100	4000	BRILLANTINE Pro	36°	1500cd	3000	100	4000	
		35W	12V	GU 5,3	DECOSTAR 51 IRC	36°	2200cd	3000	100	5000	MASTER LINE ES	36°	2200cd	3000	100	5000	
		35W	12V	GU 5,3	DECOSTAR 51 TITAN	60°	700cd	3000	100	4000	BRILLANTINE Pro	60°	700cd	3000	100	4000	
		35W	12V	GU 5,3	DECOSTAR 51 IRC	60°	1100cd	3000	100	5000	MASTER LINE ES	60°	1050cd	3000	100	5000	
		45W	12V	GU 5,3							MASTER LINE ES	8°	16000cd	3000	100	5000	
		45W	12V	GU 5,3							MASTER LINE ES	24°	5450cd	3000	100	5000	
		45W	12V	GU 5,3							MASTER LINE ES	36°	2850cd	3000	100	5000	
		45W	12V	GU 5,3							MASTER LINE ES	60°	1300cd	3000	100	5000	
		50W	12V	GU 5,3	DECOSTAR 51 TITAN	10°	12500cd	3000	100	4000	BRILLANTINE Pro	24°	4400cd	3000	100	4000	
		50W	12V	GU 5,3	DECOSTAR 51 IRC	10°	15000cd	3000	100	5000	BRILLANTINE Pro	36°	2200cd	3000	100	4000	
		50W	12V	GU 5,3	DECOSTAR 51 TITAN	24°	4400cd	3000	100	4000	BRILLANTINE Pro	50°	1100cd	3000	100	4000	
		50W	12V	GU 5,3	DECOSTAR 51 IRC	24°	5700cd	3000	100	5000							
		50W	12V	GU 5,3	DECOSTAR 51 TITAN	36°	2200cd	3000	100	4000							
		50W	12V	GU 5,3	DECOSTAR 51 IRC	36°	2850cd	3000	100	5000							
	50W	12V	GU 5,3	DECOSTAR 51 TITAN	60°	1100cd	3000	100	4000								
	50W	12V	GU 5,3	DECOSTAR 51 IRC	60°	1430cd	3000	100	5000								
	QT-12 ax																
		20W	12V	GY 6,35	HALOSTAR Starlite	-	320lm	3000	100	4000	CAPSULINE Pro	-	300lm	3000	100	4000	
		25W	12V	GY 6,35	HALOSTAR IRC	-	500lm	3000	100	4000							
		35W	12V	GY 6,35	HALOSTAR Starlite	-	600lm	3000	100	4000	CAPSULINE Pro	-	600lm	3000	100	4000	
		35W	12V	GY 6,35	HALOSTAR IRC	-	900lm	3000	100	4000							
		50W	12V	GY 6,35	HALOSTAR Starlite	-	910lm	3000	100	4000	CAPSULINE Pro	-	950lm	3000	100	4000	
		50W	12V	GY 6,35	HALOSTAR IRC	-	1250lm	3000	100	4000							
		65W	12V	GY 6,35	HALOSTAR IRC	-	1700lm	3000	100	4000							
		75W	12V	GY 6,35	HALOSTAR Starlite	-	1450lm	3000	100	4000	CAPSULINE Pro	-	1575lm	3000	100	4000	
		90W	12V	GY 6,35	HALOSTAR Starlite	-	1800lm	3000	100	4000							
	100W	12V	GY 6,35							CAPSULINE Pro	-	2550lm	3000	100	4000		
	QT-1C																
		45W	12V	G 8,5							MASTER Line 1C	-	1100lm	3000	100	5000	
	60W	12V	G 8,5							MASTER Line 1C	-	1600lm	3000	100	5000		
	QT-DE 12																
		60W	230V	R7s	HALOLINE	-	840lm	3000	100	2000	PLUSLINE Pro	-	828lm	3000	100	2000	
		100W	230V	R7s	HALOLINE	-	1600lm	3000	100	2000	PLUSLINE Pro	-	1				



Symbol	Abbreviation	wattage	voltage	Lamp holder	Osram	Half peak	luminous intensity (lm) flux (cd)	Colour temp. (°k)	IRC %	Average Life (h)	Philips	Half peak value °	luminous intensity (lm) flux (cd)	Colour temp. (°k)	IRC %	Average Life (h)	
	QT-16	25W	230V	G9	HALOPIN clear	-	260lm	2900	100	2000	Clickline MV clear	-	290lm	2770	100	2000	
		40W	230V	G9	HALOPIN clear	-	490lm	2900	100	2000	Clickline MV clear	-	490lm	2770	100	2000	
		60W	230V	G9	HALOPIN clear	-	820lm	2900	100	2000	Clickline MV clear	-	820lm	2700	100	2000	
		75W	230V	G9	HALOPIN clear	-	1100lm	2900	100	2000	Clickline MV clear	-	1100lm	2770	100	2000	
		25W	230V	G9	HALOPIN matt	-	230lm	2900	100	2000	Clickline MV frosted	-	260lm	2800	100	2000	
		40W	230V	G9	HALOPIN matt	-	460lm	2900	100	2000	Clickline MV frosted	-	460lm	2800	100	2000	
		60W	230V	G9	HALOPIN matt	-	790lm	2900	100	2000	Clickline MV frosted	-	790lm	2800	100	2000	
		75W	230V	G9	HALOPIN matt	-	1050lm	2900	100	2000	Clickline MV frosted	-	1050lm	2800	100	2000	
			TC-D	13W	230V	G24d-1	DULUX D	-	900lm	2700	80	8000	Master PL-C 2 Pin	-	900lm	2700	82
13W	230V			G24d-1	DULUX D	-	900lm	3000	80	8000	Master PL-C 2 Pin	-	900lm	3000	82	8000	
13W	230V			G24d-1	DULUX D	-	900lm	4000	80	8000	Master PL-C 2 Pin	-	900lm	4000	82	8000	
13W	230V			G24d-1								Master PL-C 2 Pin	-	900lm	6500	80	8000
18W	230V			G24d-2	DULUX D	-	1200lm	2700	80	8000	Master PL-C 2 Pin	-	1200lm	2700	82	8000	
18W	230V			G24d-2	DULUX D	-	1200lm	3000	80	8000	Master PL-C 2 Pin	-	1200lm	3000	82	8000	
18W	230V			G24d-2	DULUX D	-	1200lm	4000	80	8000	Master PL-C 2 Pin	-	1200lm	4000	82	8000	
18W	230V			G24d-2								Master PL-C 2 Pin	-	1200lm	6500	80	8000
26W	230V			G24d-3	DULUX D	-	1800lm	2700	80	8000	Master PL-C 2 Pin	-	1800lm	2700	82	8000	
26W	230V			G24d-3	DULUX D	-	1800lm	3000	80	8000	Master PL-C 2 Pin	-	1800lm	3000	82	8000	
26W	230V			G24d-3	DULUX D	-	1800lm	4000	80	8000	Master PL-C 2 Pin	-	1800lm	4000	82	8000	
26W	230V			G24d-3								Master PL-C 2 Pin	-	1800lm	6500	80	8000
	TC-DEL			10W	230V	G24q-1	DULUX D/E	-	600lm	2700	80	10000	Master PL-C 4 Pin	-	600lm	2700	82
		10W	230V	G24q-1	DULUX D/E	-	600lm	3000	80	10000	Master PL-C 4 Pin	-	600lm	3000	82	10000	
		10W	230V	G24q-1	DULUX D/E	-	600lm	4000	80	10000	Master PL-C 4 Pin	-	600lm	4000	82	10000	
		13W	230V	G24q-1	DULUX D/E	-	900lm	2700	80	10000	Master PL-C 4 Pin	-	900lm	2700	82	10000	
		13W	230V	G24q-1	DULUX D/E	-	900lm	3000	80	10000	Master PL-C 4 Pin	-	900lm	3000	82	10000	
		13W	230V	G24q-1	DULUX D/E	-	900lm	4000	80	10000	Master PL-C 4 Pin	-	900lm	4000	82	10000	
		18W	230V	G24q-2	DULUX D/E	-	1200lm	2700	80	10000	Master PL-C 4 Pin	-	1200lm	2700	82	10000	
		18W	230V	G24q-2	DULUX D/E	-	1200lm	3000	80	10000	Master PL-C 4 Pin	-	1200lm	3000	82	10000	
		18W	230V	G24q-2	DULUX D/E	-	1200lm	4000	80	10000	Master PL-C 4 Pin	-	1200lm	4000	82	10000	
		26W	230V	G24q-3	DULUX D/E	-	1800lm	2700	80	10000	Master PL-C 4 Pin	-	1800lm	2700	82	10000	
		26W	230V	G24q-3	DULUX D/E	-	1800lm	3000	80	10000	Master PL-C 4 Pin	-	1800lm	3000	82	10000	
		26W	230V	G24q-3	DULUX D/E	-	1800lm	4000	80	10000	Master PL-C 4 Pin	-	1800lm	3500	82	10000	
		26W	230V	G24q-3								Master PL-C 4 Pin	-	1800lm	4000	82	10000
26W	230V	G24q-3								Master PL-C 4 Pin	-	1800lm	6500	80	10000		
	TC-TEL	18W	230V	GX24q-2	DULUX T/E	-	1200lm	2700	80	10000	Master PL-T 4Pin	-	1200lm	2700	82	10000	
		18W	230V	GX24q-2	DULUX T/E	-	1200lm	3000	80	10000	Master PL-T 4Pin	-	1200lm	3000	82	10000	
		18W	230V	GX24q-2	DULUX T/E	-	1200lm	4000	80	10000	Master PL-T 4Pin	-	1200lm	4000	82	10000	
		26W	230V	GX24q-3	DULUX T/E	-	1800lm	2700	80	10000	Master PL-T 4Pin	-	1800lm	2700	82	10000	
		26W	230V	GX24q-3	DULUX T/E	-	1800lm	3000	80	10000	Master PL-T 4Pin	-	1800lm	3000	82	10000	
		26W	230V	GX24q-3	DULUX T/E	-	1800lm	4000	80	10000	Master PL-T 4Pin	-	1800lm	4000	82	10000	
		32W	230V	GX24q-3	DULUX T/E	-	2400lm	2700	80	10000	Master PL-T 4Pin	-	2400lm	2700	82	10000	
		32W	230V	GX24q-3	DULUX T/E	-	2400lm	3000	80	10000	Master PL-T 4Pin	-	2400lm	3000	82	10000	
		32W	230V	GX24q-3	DULUX T/E	-	2400lm	4000	80	10000	Master PL-T 4Pin	-	2400lm	4000	82	10000	
		42W	230V	GX24q-4	DULUX T/E	-	3200lm	2700	80	10000	Master PL-T 4Pin	-	3200lm	2700	82	10000	
		42W	230V	GX24q-4	DULUX T/E	-	3200lm	3000	80	10000	Master PL-T 4Pin	-	3200lm	3000	82	10000	
		42W	230V	GX24q-4	DULUX T/E	-	3200lm	4000	80	10000	Master PL-T 4Pin	-	3200lm	4000	82	10000	
			PL-H	60W	230V	2G8-1							Master PL-H 4Pin	-	4000lm	3000	82
60W	230V			2G8-1							Master PL-H 4Pin	-	4000lm	4000	82	20000	
85W	230V			2G8-1							Master PL-H 4Pin	-	6000lm	3000	82	20000	
85W	230V			2G8-1							Master PL-H 4Pin	-	6000lm	4000	82	20000	
120W	230V			2G8-1	Osram Dulux 120w	-	9000lm	3000	80	20000	Master PL-H 4Pin	-	9000lm	3000	82	20000	
120W	230V	2G8-1	Osram Dulux 120w	-	9000lm	4000	80	20000	Master PL-H 4Pin	-	9000lm	4000	82	20000			
	TC-L	18W	230V	2G11	DULUX L	-	1200lm	2700	80	8000	PL-L/4P	-	950lm	2700	90	16000	
		18W	230V	2G11	DULUX L	-	1200lm	3000	80	8000	PL-L 90 De Luxe Pro	-	950lm	4000	90	16000	
		18W	230V	2G11	DULUX L	-	1200lm	4000	80	8000	PL-L 90 De Luxe Pro	-	950lm	5300	90	16000	
		24W	230V	2G11	DULUX L	-	1800lm	2700	80	8000							
		24W	230V	2G11	DULUX L	-	1800lm	3000	80	8000	Master PL-L Polar	-	2900lm	3000	82	16000	
		24W	230V	2G11	DULUX L	-	1800lm	4000	80	8000	Master PL-L Polar	-	2900lm	4000	82	16000	
		55W	230V	2G11	DULUX L	-	4800lm	2700	80	10000							
		55W	230V	2G11	DULUX L	-	4800lm	3000	80	10000	Master PL-L Polar	-	4800lm	3000	82	16000	
		55W	230V	2G11	DULUX L	-	4800lm	4000	80	10000	Master PL-L Polar	-	4800lm	4000	82	16000	
	TC-F	24W	230V	2G10	DULUX F	-	1700lm	2700	80								
		24W	230V	2G10	DULUX F	-	1700lm	3000	80								
		24W	230V	2G10	DULUX F	-	1700lm	3500	80								

Symbol	Abbreviation	wattage	voltage	Lamp holder	Osram	Half peak	luminous	Colour temp.	IRC	Average Life	Philips	Half peak	luminous	Colour temp.	IRC	Average Life	
	T16	14W	230V	G5	T5 HE High Efficiency	-	1200lm	2700	80.89	24000	Master TL5 HE Super	-	1200lm	2700	85	24000	
		14W	230V	G5	T5 HE High Efficiency	-	1200lm	3000	80.89	24000	Master TL5 HE Super	-	1200lm	3000	85	24000	
		14W	230V	G5	T5 HE High Efficiency	-	1200lm	4000	80.89	24000	Master TL5 HE Super	-	1200lm	4000	85	24000	
		14W	230V	G5	T5 HE High Efficiency	-	1200lm	5400	80.89	24000	Master TL5 HE Super	-	1100lm	5000	85	24000	
		14W	230V	G5	T5 HE High Efficiency	-	1100lm	6500	80.89	24000	Master TL5 HE Super	-	1100lm	6500	85	24000	
		24W	230V	G5	T5 HO High Output	-	1750lm	2700	80.89	24000	Master TL5 HO Super	-	1750lm	2700	85	24000	
		24W	230V	G5	T5 HO High Output	-	1750lm	3000	80.89	24000	Master TL5 HO Super	-	1750lm	3000	85	24000	
		24W	230V	G5	T5 HO High Output	-	1750lm	3500	80.89	24000	Master TL5 HO Super	-	1750lm	3500	85	24000	
		24W	230V	G5	T5 HO High Output	-	1750lm	4000	80.89	24000	Master TL5 HO Super	-	1750lm	4000	85	24000	
		24W	230V	G5	T5 HO High Output	-	1600lm	6500	80.89	24000	Master TL5 HO Super	-	1650lm	5000	85	24000	
		24W	230V	G5	T5 HO High Output	-	1550lm	8000	80.89	24000	Master TL5 HO Super	-	1650lm	6500	85	24000	
		39W	230V	G5	T5 HO High Output	-	3100lm	2700	80.89	24000	Master TL5 HO Super	-	3100lm	2700	85	24000	
		39W	230V	G5	T5 HO High Output	-	3100lm	3000	80.89	24000	Master TL5 HO Super	-	3100lm	3000	85	24000	
		39W	230V	G5	T5 HO High Output	-	3100lm	3500	80.89	24000	Master TL5 HO Super	-	3100lm	3500	85	24000	
		39W	230V	G5	T5 HO High Output	-	3100lm	4000	80.89	24000	Master TL5 HO Super	-	3100lm	4000	85	24000	
		39W	230V	G5	T5 HO High Output	-	2850lm	6500	80.89	24000	Master TL5 HO Super	-	3100lm	6500	85	24000	
		39W	230V	G5	T5 HO High Output	-	2750lm	8000	80.89	24000	Master TL5 HO Super	-	2950lm	6500	85	24000	
		54W	230V	G5	T5 HO High Output	-	4450lm	2700	80.89	24000	Master TL5 HO Super	-	4450lm	2700	85	24000	
		54W	230V	G5	T5 HO High Output	-	4450lm	3000	80.89	24000	Master TL5 HO Super	-	4450lm	3000	85	24000	
		54W	230V	G5	T5 HO High Output	-	4450lm	3500	80.89	24000	Master TL5 HO Super	-	4450lm	3500	85	24000	
54W	230V	G5	T5 HO High Output	-	4450lm	4000	80.89	24000	Master TL5 HO Super	-	4450lm	4000	85	24000			
54W	230V	G5	T5 HO High Output	-	4050lm	6500	80.89	24000	Master TL5 HO Super	-	4450lm	6500	85	24000			
54W	230V	G5	T5 HO High Output	-	4000lm	8000	80.89	24000	Master TL5 HO Super	-	4450lm	8000	85	24000			
	T16-R	22W	230V	2GX13	T5 FC	-	1800lm	2700	80.89	24000	TL5 Circular Super 80	-	1800lm	2700	85	24000	
		22W	230V	2GX13	T5 FC	-	1800lm	3000	80.89	24000	TL5 Circular Super 80	-	1800lm	3000	85	24000	
		22W	230V	2GX13	T5 FC	-	1800lm	4000	80.89	24000	TL5 Circular Super 80	-	1800lm	4000	85	24000	
		22W	230V	2GX13	T5 FC	-	1710lm	6500	80.89	24000	TL5 Circular Super 80	-	1800lm	6500	85	24000	
		40W	230V	2GX13	T5 FC	-	3200lm	2700	80.89	24000	TL5 Circular Super 80	-	3300lm	2700	85	24000	
		40W	230V	2GX13	T5 FC	-	3200lm	3000	80.89	24000	TL5 Circular Super 80	-	3300lm	3000	85	24000	
		40W	230V	2GX13	T5 FC	-	3200lm	4000	80.89	24000	TL5 Circular Super 80	-	3300lm	4000	85	24000	
		40W	230V	2GX13	T5 FC	-	3000lm	6500	80.89	24000	TL5 Circular Super 80	-	3300lm	6500	85	24000	
	HIPAR111	20W	230V/5kV	GX 8,5	Powerball HCI-R111	10°	17000cd	3000	80	20000							
		20W	230V/5kV	GX 8,5	Powerball HCI-R111	24°	4200cd	3000	80	20000							
		20W	230V/5kV	GX 8,5	Powerball HCI-R111	40°	2000cd	3000	80	20000							
		35W	230V/5kV	GX 8,5	Powerball HCI-R111	10°	35000cd	4200	90	20000							
		35W	230V/5kV	GX 8,5	Powerball HCI-R111	24°	8500cd	4200	90	20000							
		35W	230V/5kV	GX 8,5	Powerball HCI-R111	40°	4000cd	4200	90	20000							
		35W	230V/5kV	GX 8,5	Powerball HCI-R111	10°	35000cd	3000	80	20000	Master Colour CDM-R111	10°	35000cd	3000	81	20000	
		35W	230V/5kV	GX 8,5	Powerball HCI-R111	24°	8500cd	3000	80	20000	Master Colour CDM-R112	24°	8500cd	3000	81	20000	
		35W	230V/5kV	GX 8,5	Powerball HCI-R111	40°	4000cd	3000	80	20000	Master Colour CDM-R113	40°	4000cd	3000	81	20000	
		70W	230V/5kV	GX 8,5	Powerball HCI-R111	10°	55000cd	3000	80	20000	Master Colour CDM-R114	10°	50000cd	3000	84	20000	
70W	230V/5kV	GX 8,5	Powerball HCI-R111	24°	15000cd	3000	80	20000	Master Colour CDM-R115	24°	15000cd	3000	84	20000			
70W	230V/5kV	GX 8,5	Powerball HCI-R111	40°	9000cd	3000	80	20000	Master Colour CDM-R116	40°	9000cd	3000	84	20000			
	HIT-DE	70W	230V/5kV	RX7s	Powerball HCI-TS	-	6900lm	3000	80	9000							
		70W	230V/5kV	RX7s	Powerball HCI-TS	-	6700lm	4200	90	9000	MHN-TD Pro	-	5700lm	4200	80	9000	
		150W	230V/5kV	RX7s-24	Powerball HCI-TS	-	14800lm	3000	80	9000							
		150W	230V/5kV	RX7s-24	Powerball HCI-TS	-	14200lm	4200	90	9000	MHN-TD Pro	-	12900lm	4200	80	9000	
	HIT-T	35W	230V	G12	Powerball HCI-T	-	3400lm	3000	80	12000	Master Colour CDM-T	-	3300lm	3000	81	12000	
		35W	230V	G12	Powerball HCI-T	-	3300lm	4200	90	12000							
		70W	230V	G12	Powerball HCI-T	-	7000lm	3000	80	12000	Master Colour CDM-T	-	6600lm	3000	81	12000	
		70W	230V	G12	Powerball HCI-T	-	6700lm	4200	90	12000	Master Colour CDM-T	-	6600lm	4200	92	12000	
		100W	230V	G12	Powerball HCI-T	-	9500lm	3000	80	12000							
		100W	230V	G12	Powerball HCI-T	-	9500lm	4200	90	12000							
		150W	230V	G12	Powerball HCI-T	-	15500lm	3000	80	12000	Master Colour CDM-T	-	14000lm	3000	85	12000	
		150W	230V	G12	Powerball HCI-T	-	14500lm	4200	90	12000	Master Colour CDM-T	-	12700lm	4200	96	12000	
	HIT-TC	20W	230V/5kV	G 8.5	Powerball HCI-TC	-	1700lm	3000	80	6000							
		35W	230V/5kV	G 8.5	Powerball HCI-TC	-	3400lm	3000	80	6000							
		35W	230V/5kV	G 8.5	Powerball HCI-TC	-	3200lm	4200	90	6000	Master Colour CDM-TC	-	3300lm	3000	81	6000	
		70W	230V/5kV	G 8.5	Powerball HCI-TC	-	6900lm	3000	80	6000	Master Colour CDM-TC	-	6400lm	3000	83	6000	
		70W	230V/5kV	G 8.5	Powerball HCI-TC	-	6900lm	4200	90	6000							
	CDM-Tm	20W	230V/1,5kV	PGJ 5							CDM-Tm	-	1650lm				
		35W	230V/1,5kV	PGJ 5									-	3000lm			



Todos los productos están fabricados siguiendo las normas de seguridad y electromagnetismo de Europa: EN 60598-1 y marcado CE.  
All products are manufactured according to the European safety norms and electromagnetic standards: EN 60598-1 and CE mark.



Todas las luminarias marcadas con este símbolo pueden ser instaladas sobre una superficie normalmente inflamable.  
All luminaires bearing this symbol are suitable for installation on normally inflammable surfaces.



Todas las luminarias marcadas con este símbolo no pueden ser instaladas sobre una superficie normalmente inflamable.  
All luminaires bearing this symbol are unsuitable for installation on normally inflammable surfaces.



La protección contra choques eléctricos incluye medidas de seguridad basadas en la conexión de las partes conductoras accesibles a un conductor de seguridad puesto a tierra.  
Protection against electrical shocks includes other measures based on the connection of accessible conductive parts to an earthing conductor.



La protección contra choques eléctricos incluye medidas de seguridad basadas en el doble aislamiento o el aislamiento reforzado. Excluye toma de tierra.  
Protection against electrical shocks includes other measures based on the double reinforced insulation. Excludes earthing.



La protección contra choques eléctricos se basa en una alimentación de muy baja tensión, a través de un transformador de seguridad, sin generarse tensiones superiores a ésta.  
Protection against electrical shocks includes other measures based on a very low voltage through a security transformer, without generating higher voltages.



Resistente a hilo incandescente a 850°C.  
Resistance to incandescent wire at 850°C.



Este símbolo indica la distancia mínima entre el foco de la luminaria y el objeto iluminado.  
Minimum security distance between the light source and the illuminated object.



Lumens/watios.  
Lumens/Watts.



Ángulo de la ópticas.  
Lents angle.



Corte de empotramiento.  
Hole dimensions for recessing.



Diámetro de empotramiento.  
Hole diameter for recessing.



Todas las luminarias marcadas con este símbolo están protegidas contra la penetración de sólidos de tamaño superior a 12mm.  
Protection degree against the ingress of solids over 12 mm.



Todas las luminarias marcadas con este símbolo están protegidas contra la penetración de sólidos de tamaño superior a 1mm.  
Protection degree against the ingress of solids over 1 mm.



Todas las luminarias marcadas con este símbolo están protegidas contra la penetración de sólidos de tamaño superior a 1mm y salpicaduras de agua.  
Protection degree against the ingress of solids over 1 mm and against the water splashing.



Peso.  
Weight.



Orientable ±40° alrededor de los dos ejes que forman el plano horizontal.  
Adjustable ±40° around the 2 axis forming the horizontal plane.



Rotación en el plano horizontal de ±20°.  
Adjustable ±20° on the horizontal axis.



Rotación en el plano horizontal de ±40°.  
Adjustable ±40° on the horizontal axis.



Rotación en el plano horizontal de ±90°.  
Adjustable ±90° on the horizontal axis.



Ajustable de 0° a 90° en relación al plano horizontal.  
Adjustable from 0° to 90° on the horizontal axis.



Rotación de 355° alrededor del plano vertical.  
Adjustable from 0° to 355° on the vertical axis.

DALI / PUSH PULL

Reactancia regulable por sistema DALI (Digital Adressable Lighting Interface) o por sistema PUSH-PULL (mediante señal digital controlada por pulsador)  
Digital dimming ballast by DALI protocol (Digital Adressable Lighting Interface) or by PUSH-PULL system (digital signal controlled by a push button).

regul./dim. 1...10V :

Reactancia de regulación analógica por potenciómetro de 1 a 10 voltios.  
Analogic dimming ballast by 1 to 10 volts potentiometer.

EQUIPO / GEAR



Equipo electrónico incluido.  
Electronic gear included.



Equipo magnético incluido.  
Magnetic gear included.



Equipo no incluido.  
Gear not included.

INSTALACIÓN / INSTALATION



Carril trifásico  
3-circuit track



Empotrable pared  
Wall recessed



Empotrable techo  
Ceiling recessed



Empotrable suelo  
Floor recessed



Adosable techo  
Surface mounted



Adosable pared  
Wall mounted



Suspensión  
Suspended

□ **MODUL** □  
ELECTRO  
INDEX  
[www.modulelectro.ru](http://www.modulelectro.ru)

Código/Code	Gama/Range	Pag	Código/Code	Gama/Range	Pag	Código/Code	Gama/Range	Pag
05-3307-S2-00	BIT	152	ACT-9080-N3-B9	LOMA	127	CR-0325-14-00	CARRILES	29
05-3308-S2-00	BIT	152	ACT-9081-N3-B9	LOMA	127	CR-0325-60-00	CARRILES	29
55-3401-N3-M3	PETIT	153	ACT-9082-N3-B9	LOMA	127	CR-0326-14-00	CARRILES	29
71-3305-00-00	UNIDADES ELÉCTRICAS	194	ACT-9083-N3-00	LOMA	127	CR-0326-60-00	CARRILES	29
71-3306-00-00	UNIDADES ELÉCTRICAS	194	ACT-9084-N3-00	LOMA	127	CR-0327-14-00	CARRILES	29
71-3307-00-00	UNIDADES ELÉCTRICAS	194	ACT-9085-N3-00	LOMA	127	CR-0327-60-00	CARRILES	29
71-3308-00-00	UNIDADES ELÉCTRICAS	194	ACT-9086-00-00	LOMA	127	CR-0328-14-00	CARRILES	29
71-3325-00-00	DELTA	156	ACT-9087-08-00	LOMA	127	CR-0328-60-00	CARRILES	29
71-3326-00-00	DELTA	156	ACT-9087-11-00	LOMA	127	CR-0329-14-00	CARRILES	29
71-3328-00-00	DELTA	156	ACT-9087-24-00	LOMA	127	CR-0329-60-00	CARRILES	29
71-3329-00-00	DELTA	156	ACT-9087-25-00	LOMA	127	CR-0331-14-00	CARRILES	29
71-3309-00-00	UNIDADES ELÉCTRICAS	194	ACT-9105-N3-00	PROYECTORES	14-24	CR-0331-60-00	CARRILES	29
90-3427-S2-14	DELTA6	156	ACT-9105-60-00	PROYECTORES	14-24	CR-0332-14-00	CARRILES	29
90-3427-S2-N3	DELTA6	156	ACT-9105-14-00	PROYECTORES	14	CR-0332-60-00	CARRILES	29
90-3428-S2-14	DELTA9	156	ACT-9106-N3-00	PROYECTORES	14-24	CR-0333-N3-00	CARRILES	28
90-3428-S2-N3	DELTA9	156	ACT-9106-60-00	PROYECTORES	14-24	CR-0333-14-00	CARRILES	28
90-3429-14-M2	SOUND	157	ACT-9106-14-00	PROYECTORES	14	CR-0334-N3-00	CARRILES	28
90-3429-14-M3	SOUND	157	ACT-BAL-003	UNIDADES ELÉCTRICAS	195	CR-0334-14-00	CARRILES	28
90-3429-N3-M2	SOUND	157	ACT-BAL-004	UNIDADES ELÉCTRICAS	195	CR-0335-00-00	CARRILES	28
90-3429-N3-M3	SOUND	157	ACT-BAL-005	UNIDADES ELÉCTRICAS	195	CR-0336-N3-00	CARRILES	28
90-3430-14-M2	SOUND	157	ACT-BAL-006	UNIDADES ELÉCTRICAS	195	CR-0336-14-00	CARRILES	28
90-3430-14-M3	SOUND	157	ACT-BAL-007	UNIDADES ELÉCTRICAS	195	DM-0044-14-00	SATIN	100
90-3430-N3-M2	SOUND	157	ACT-BAL-009	UNIDADES ELÉCTRICAS	195	DM-0045-14-00	SATIN	100
90-3430-N3-M3	SOUND	157	ACT-BAL-010	UNIDADES ELÉCTRICAS	195	DM-0046-14-00	SATIN	100
ACT-0065-14-00	CARDEX E/C	87	ACT-BAL-011	UNIDADES ELÉCTRICAS	195	DM-0047-14-00	SATIN	100
ACT-0065-N3-00	CARDEX E/C	87	ACT-TRA-001	UNIDADES ELÉCTRICAS	194	DM-0048-N3-00	MINI	116
ACT-0066-14-00	CARDEX E/C	87	ACT-TRA-002	UNIDADES ELÉCTRICAS	194	DM-0049-N3-00	MINI	116
ACT-0066-N3-00	CARDEX E/C	87	ACT-TRA-003	UNIDADES ELÉCTRICAS	194	DM-0050-N3-00	MINI	117
ACT-0067-14-00	CARDEX E/C	87	ACT-TRA-004	UNIDADES ELÉCTRICAS	194	DM-0051-N3-00	MINI	117
ACT-0067-N3-00	CARDEX E/C	87	AD-0616-N3-00	BORBOLETA	36	DM-0053-14-00	MULTIDIR	109
ACT-0068-14-00	CARDEX E/C	87	AD-0617-N3-00	BORBOLETA	36	DM-0053-N3-00	MULTIDIR	109
ACT-0068-N3-00	CARDEX E/C	87	AD-0618-N3-00	BORBOLETA	36	DM-0054-14-00	MULTIDIR	109
ACT-0233-00-00	TRIMIUM	53	AD-0619-N3-00	BORBOLETA	36	DM-0054-N3-00	MULTIDIR	109
ACT-0294-00-00	TRIMIUM S100	66	AD-0624-N3-00	BORBOLETA	36	DM-0055-14-00	MULTIDIR	109
ACT-0364-00-00	SIGN	177	AD-0625-N3-00	BORBOLETA	36	DM-0055-N3-00	MULTIDIR	109
ACT-0365-00-00	SIGN	177	AD-0626-N3-00	BORBOLETA	36	DM-0056-14-00	MULTIDIR	109
ACT-0458-N3-00	LEDIO	146	AD-0627-N3-00	BORBOLETA	36	DM-0056-N3-00	MULTIDIR	109
ACT-0803-00-00	UNIDADES ELÉCTRICAS	194	AD-0632-N3-00	BORBOLETA	36	DM-0058-14-00	SATIN Evolution	102
ACT-0804-00-00	UNIDADES ELÉCTRICAS	194	AD-0633-N3-00	BORBOLETA	36	DM-0059-14-00	SATIN Evolution	102
ACT-0808-00-00	UNIDADES ELÉCTRICAS	194	AD-0634-N3-00	BORBOLETA	36	DM-0060-14-00	SATIN Evolution	102
ACT-0816-00-00	UNIDADES ELÉCTRICAS	194	AD-0635-N3-00	BORBOLETA	36	DM-0061-14-00	MULTIDIR	108
ACT-9044-N3-00	BACO	185	AP-0501-S2-00	LEDIO	148	DM-0061-N3-00	MULTIDIR	108
ACT-9044-14-00	BACO	185	AP-0503-S2-00	LEDIO	148	DM-0062-14-00	MULTIDIR	108
ACT-9044-60-00	BACO	185	CR-0323-N3-00	CARRILES	28	DM-0062-N3-00	MULTIDIR	108
ACT-9045-N3-00	BACO	185	CR-0323-14-00	CARRILES	28	DM-0063-14-00	MULTIDIR	108
ACT-9045-14-00	BACO	185	CR-0323-60-00	CARRILES	28	DM-0063-N3-00	MULTIDIR	108
ACT-9045-60-00	BACO	185	CR-0324-N3-00	CARRILES	28	DM-0064-14-00	MULTIDIR	108
ACT-9046-N3-00	BORBOLETA	37	CR-0324-14-00	CARRILES	28	DM-0064-N3-00	MULTIDIR	108
ACT-9061-00-00	CAMALEON	44	CR-0324-60-00	CARRILES	28	DM-0073-N3-00	EXTRA	96

Código/Code	Gama/Range	Pag
DM-0074-N3-00	EXTRA	96
DM-0075-N3-00	EXTRA	96
DM-0076-N3-00	EXTRA	96
DM-0077-N3-00	EXTRA	96
DM-0078-N3-00	EXTRA	96
DM-0081-14-00	MULTIDIR TRIMLESS	110
DM-0081-60-00	MULTIDIR TRIMLESS	110
DM-0082-14-00	MULTIDIR TRIMLESS	110
DM-0082-60-00	MULTIDIR TRIMLESS	110
DM-0083-14-00	MULTIDIR TRIMLESS	110
DM-0083-60-00	MULTIDIR TRIMLESS	110
DM-0084-14-00	MULTIDIR TRIMLESS	110
DM-0084-60-00	MULTIDIR TRIMLESS	110
DM-0093-14-00	MULTIDIR TRIMLESS	111
DM-0093-60-00	MULTIDIR TRIMLESS	111
DM-0094-14-00	MULTIDIR TRIMLESS	111
DM-0094-60-00	MULTIDIR TRIMLESS	111
DM-0095-14-00	MULTIDIR TRIMLESS	111
DM-0095-60-00	MULTIDIR TRIMLESS	111
DM-0096-14-00	MULTIDIR TRIMLESS	111
DM-0096-60-00	MULTIDIR TRIMLESS	111
DM-1100-14-00	BACO	184
DM-1100-60-00	BACO	184
DM-1100-N3-00	BACO	184
DM-1101-14-00	BACO	184
DM-1101-60-00	BACO	184
DM-1101-N3-00	BACO	184
DM-1102-14-00	BACO	184
DM-1102-60-00	BACO	184
DM-1102-N3-00	BACO	184
DM-1103-14-00	BACO	184
DM-1103-60-00	BACO	184
DM-1103-N3-00	BACO	184
DM-1150-14-00	BACO	186
DM-1150-60-00	BACO	186
DM-1150-N3-00	BACO	186
DM-1151-14-00	BACO	186
DM-1151-60-00	BACO	186
DM-1151-N3-00	BACO	186
DN-0236-14-37	TRIMIUM E	58
DN-0236-N3-37	TRIMIUM E	58
DN-0238-14-37	TRIMIUM E	58
DN-0238-N3-37	TRIMIUM E	58
DN-0250-14-B9	CUADRO	78
DN-0250-14-H6	CUADRO	78
DN-0250-N3-B9	CUADRO	78
DN-0250-N3-H6	CUADRO	78
DN-0252-14-B9	CUADRO	79
DN-0252-14-H6	CUADRO	79

Código/Code	Gama/Range	Pag
DN-0252-N3-B9	CUADRO	79
DN-0252-N3-H6	CUADRO	79
DN-0268-14-00	CARDEX E	84
DN-0268-N3-00	CARDEX E	84
DN-0269-14-00	CARDEX E	84
DN-0269-N3-00	CARDEX E	84
DN-0270-14-00	CARDEX C	86
DN-0270-N3-00	CARDEX C	86
DN-0273-14-00	CARDEX C	86
DN-0273-N3-00	CARDEX C	86
DN-0274-14-00	CARDEX C	86
DN-0274-N3-00	CARDEX C	86
DN-0275-14-00	CARDEX C	86
DN-0275-N3-00	CARDEX C	86
DN-0276-N3-B9	VITRO	92
DN-0277-N3-B9	VITRO	92
DN-0278-14-00	CARDEX CM	88
DN-0278-N3-00	CARDEX CM	88
DN-0279-14-00	CARDEX CM	88
DN-0279-N3-00	CARDEX CM	88
DN-0280-14-00	CARDEX CM	88
DN-0280-N3-00	CARDEX CM	88
DN-0289-N3-00	LEDIO	147
DN-0290-N3-00	LEDIO	147
DN-0297-N3-00	LEDIO	146
DN-0373-14-B9	CUADRO	80
DN-0373-14-H6	CUADRO	80
DN-0373-N3-B9	CUADRO	80
DN-0373-N3-H6	CUADRO	80
DN-0470-S2-00	LEDIO	146
DN-0472-S2-00	LEDIO	146
DN-0510-S2-00	LEDIO	146
DN-0511-S2-00	LEDIO	146
DN-0512-N3-00	LEDIO	146
DN-0520-14-00	TRIMIUM MINI	70
DN-0520-60-00	TRIMIUM MINI	70
DN-0520-N3-00	TRIMIUM MINI	70
DN-0520-S2-00	TRIMIUM MINI	70
DN-0521-14-00	TRIMIUM MINI	70
DN-0521-60-00	TRIMIUM MINI	70
DN-0521-N3-00	TRIMIUM MINI	70
DN-0521-S2-00	TRIMIUM MINI	70
DN-0522-14-00	TRIMIUM MINI	70
DN-0522-60-00	TRIMIUM MINI	70
DN-0522-N3-00	TRIMIUM MINI	70
DN-0522-S2-00	TRIMIUM MINI	70
DN-0524-14-00	TRIMIUM MINI	71
DN-0524-60-00	TRIMIUM MINI	71
DN-0524-N3-00	TRIMIUM MINI	71

Código/Code	Gama/Range	Pag
DN-0524-S2-00	TRIMIUM MINI	71
DN-0580-14-B9	RAPID C	192
DN-0581-14-B9	RAPID C	192
DN-0610-14-00	TRIMIUM MINI	71
DN-0610-60-00	TRIMIUM MINI	71
DN-0610-N3-00	TRIMIUM MINI	71
DN-0610-S2-00	TRIMIUM MINI	71
DN-0750-N3-B9	VITRO	92
DN-0950-14-B9	TRIMIUM	50
DN-0950-N3-B9	TRIMIUM	50
DN-0951-14-B9	TRIMIUM	50
DN-0951-N3-B9	TRIMIUM	50
DN-0952-14-B9	TRIMIUM	50
DN-0952-N3-B9	TRIMIUM	50
DN-0953-14-B9	TRIMIUM	50
DN-0953-N3-B9	TRIMIUM	50
DN-0954-14-B9	TRIMIUM	50
DN-0954-N3-B9	TRIMIUM	50
DN-0955-14-00	TRIMIUM	51
DN-0955-N3-00	TRIMIUM	51
DN-0956-14-00	TRIMIUM	51
DN-0956-N3-B9	TRIMIUM	51
DN-0960-14-B9	TRIMIUM	52
DN-0960-N3-B9	TRIMIUM	52
DN-0961-14-B9	TRIMIUM	52
DN-0961-N3-B9	TRIMIUM	52
DN-0962-14-B9	TRIMIUM	52
DN-0962-N3-B9	TRIMIUM	52
DN-0963-14-B9	TRIMIUM	52
DN-0963-N3-B9	TRIMIUM	52
DN-0964-14-B9	TRIMIUM	52
DN-0964-N3-B9	TRIMIUM	52
DN-0965-14-00	TRIMIUM	51
DN-0965-N3-00	TRIMIUM	51
DN-0966-14-00	TRIMIUM	51
DN-0966-N3-00	TRIMIUM	51
DN-0970-14-B9	TRIMIUM	50
DN-0970-N3-B9	TRIMIUM	50
DN-0971-14-B9	TRIMIUM	50
DN-0971-N3-B9	TRIMIUM	50
DN-0972-14-B9	TRIMIUM	50
DN-0972-N3-B9	TRIMIUM	50
DN-0975-14-B9	TRIMIUM	52
DN-0975-N3-B9	TRIMIUM	52
DN-0976-14-B9	TRIMIUM	52
DN-0976-N3-B9	TRIMIUM	52
DN-0977-14-B9	TRIMIUM	52
DN-0977-N3-B9	TRIMIUM	52
DN-0980-14-B9	TRIMIUM	50

Código/Code	Gama/Range	Pag	Código/Code	Gama/Range	Pag	Código/Code	Gama/Range	Pag
DN-0980-N3-B9	TRIMIUM	50	DN-1006-N3-B9	TRIMIUM S130	63	DN-1409-N3-00	ECO	74
DN-0981-14-B9	TRIMIUM	50	DN-1006-S2-B9	TRIMIUM S130	63	DN-1410-14-00	ECO	74
DN-0981-N3-B9	TRIMIUM	50	DN-1007-14-B9	TRIMIUM S130	63	DN-1410-N3-00	ECO	74
DN-0982-14-B9	TRIMIUM	50	DN-1007-60-B9	TRIMIUM S130	63	DN-1500-14-B9	CUADRO	78
DN-0982-N3-B9	TRIMIUM	50	DN-1007-N3-B9	TRIMIUM S130	63	DN-1500-14-H6	CUADRO	78
DN-0985-14-B9	TRIMIUM	52	DN-1007-S2-B9	TRIMIUM S130	63	DN-1500-N3-B9	CUADRO	78
DN-0985-N3-B9	TRIMIUM	52	DN-1008-14-B9	TRIMIUM S130	63	DN-1500-N3-H6	CUADRO	78
DN-0986-14-B9	TRIMIUM	52	DN-1008-60-B9	TRIMIUM S130	63	DN-1501-14-B9	CUADRO	79
DN-0986-N3-B9	TRIMIUM	52	DN-1008-N3-B9	TRIMIUM S130	63	DN-1501-14-H6	CUADRO	79
DN-0987-14-B9	TRIMIUM	52	DN-1008-S2-B9	TRIMIUM S130	63	DN-1501-N3-B9	CUADRO	79
DN-0987-N3-B9	TRIMIUM	52	DN-1009-14-B9	TRIMIUM S100	67	DN-1501-N3-H6	CUADRO	79
DN-0990-14-B9	TRIMIUM	50	DN-1009-60-B9	TRIMIUM S100	67	DN-1502-14-B9	CUADRO	80
DN-0990-N3-B9	TRIMIUM	50	DN-1009-N3-B9	TRIMIUM S100	67	DN-1502-14-H6	CUADRO	80
DN-0991-14-B9	TRIMIUM	50	DN-1009-S2-B9	TRIMIUM S100	67	DN-1502-N3-B9	CUADRO	80
DN-0991-N3-B9	TRIMIUM	50	DN-1010-14-B9	TRIMIUM S100	67	DN-1502-N3-H6	CUADRO	80
DN-0992-14-B9	TRIMIUM	50	DN-1010-60-B9	TRIMIUM S100	67	DN-1510-14-B9	CUADRO	78
DN-0992-N3-B9	TRIMIUM	50	DN-1010-N3-B9	TRIMIUM S100	67	DN-1510-14-H6	CUADRO	78
DN-0995-14-B9	TRIMIUM	52	DN-1010-S2-B9	TRIMIUM S100	67	DN-1510-N3-B9	CUADRO	78
DN-0995-N3-B9	TRIMIUM	52	DN-1011-14-B9	TRIMIUM S100	67	DN-1510-N3-H6	CUADRO	78
DN-0996-14-B9	TRIMIUM	52	DN-1011-60-B9	TRIMIUM S100	67	DN-1511-14-B9	CUADRO	79
DN-0996-N3-B9	TRIMIUM	52	DN-1011-N3-B9	TRIMIUM S100	67	DN-1511-14-H6	CUADRO	79
DN-0997-14-B9	TRIMIUM	52	DN-1011-S2-B9	TRIMIUM S100	67	DN-1511-N3-B9	CUADRO	79
DN-0997-N3-B9	TRIMIUM	52	DN-1301-14-00	CAMALEON	44	DN-1511-N3-H6	CUADRO	79
DN-1000-14-B9	TRIMIUM S130	62	DN-1301-S2-00	CAMALEON	44	DN-1512-14-B9	CUADRO	80
DN-1000-60-B9	TRIMIUM S130	62	DN-1302-14-00	CAMALEON	44	DN-1512-14-H6	CUADRO	80
DN-1000-N3-B9	TRIMIUM S130	62	DN-1302-S2-00	CAMALEON	44	DN-1512-N3-B9	CUADRO	80
DN-1000-S2-B9	TRIMIUM S130	62	DN-1303-14-00	CAMALEON	45	DN-1512-N3-H6	CUADRO	80
DN-1001-14-B9	TRIMIUM S130	62	DN-1303-S2-00	CAMALEON	45	DN-1520-14-H6	CUADRO	78
DN-1001-60-B9	TRIMIUM S130	62	DN-1304-14-00	CAMALEON	45	DN-1520-N3-H6	CUADRO	78
DN-1001-N3-B9	TRIMIUM S130	62	DN-1304-S2-00	CAMALEON	45	DN-1521-14-H6	CUADRO	79
DN-1001-S2-B9	TRIMIUM S130	62	DN-1305-14-00	CAMALEON	44	DN-1521-N3-H6	CUADRO	79
DN-1002-14-B9	TRIMIUM S130	62	DN-1305-S2-00	CAMALEON	44	DN-1522-14-H6	CUADRO	80
DN-1002-60-B9	TRIMIUM S130	62	DN-1400-14-00	ECO	74	DN-1522-N3-H6	CUADRO	80
DN-1002-N3-B9	TRIMIUM S130	62	DN-1400-N3-00	ECO	74	EP-0343-14-00	CUADRO	80
DN-1002-S2-B9	TRIMIUM S130	62	DN-1401-14-00	ECO	74	EP-0343-N3-00	CUADRO	80
DN-1003-14-B9	TRIMIUM S100	66	DN-1401-N3-00	ECO	74	EP-0344-N3-XY	WALL	172
DN-1003-60-B9	TRIMIUM S100	66	DN-1402-14-00	ECO	74	EP-0345-N3-00	WALL	172
DN-1003-N3-B9	TRIMIUM S100	66	DN-1402-N3-00	ECO	74	EP-0346-N3-XY	WALL	172
DN-1003-S2-B9	TRIMIUM S100	66	DN-1403-14-00	ECO	74	EP-0347-N3-00	WALL	172
DN-1004-14-B9	TRIMIUM S100	66	DN-1403-N3-00	ECO	74	EP-0348-N3-XY	SIGN	176
DN-1004-60-B9	TRIMIUM S100	66	DN-1405-14-00	ECO	74	EP-0349-N3-XY	SIGN	176
DN-1004-N3-B9	TRIMIUM S100	66	DN-1405-N3-00	ECO	74	EP-0356-N3-00	SIGN	176
DN-1004-S2-B9	TRIMIUM S100	66	DN-1406-14-00	ECO	74	EP-0360-N3-XY	SIGN	176
DN-1005-14-B9	TRIMIUM S100	66	DN-1406-N3-00	ECO	74	EP-0506-00-B9	LEDIO	147
DN-1005-60-B9	TRIMIUM S100	66	DN-1407-14-00	ECO	74	EP-0612-14-B9	BORBOLETA	36
DN-1005-N3-B9	TRIMIUM S100	66	DN-1407-N3-00	ECO	74	EP-0613-14-B9	BORBOLETA	36
DN-1005-S2-B9	TRIMIUM S100	66	DN-1408-14-00	ECO	74	EP-0614-14-B9	BORBOLETA	36
DN-1006-14-B9	TRIMIUM S130	63	DN-1408-N3-00	ECO	74	EP-0615-14-B9	BORBOLETA	36
DN-1006-60-B9	TRIMIUM S130	63	DN-1409-14-00	ECO	74	EP-0620-14-B9	BORBOLETA	36

Código/Code	Gama/Range	Pag
EP-0621-14-B9	BORBOLETA	36
EP-0622-14-B9	BORBOLETA	36
EP-0623-14-B9	BORBOLETA	36
EP-0628-14-B9	BORBOLETA	36
EP-0629-14-B9	BORBOLETA	36
EP-0630-14-B9	BORBOLETA	36
EP-0631-14-B9	BORBOLETA	36
EP-0636-14-B9	BORBOLETA	36
EP-0637-14-B9	BORBOLETA	36
EP-0640-14-B9	BORBOLETA	36
EP-0641-14-B9	BORBOLETA	36
EP-1601-14-14	CLAM	166
EP-1602-14-14	CLAM	166
EP-1605-14-14	CLAM	166
EP-1608-14-14	CLAM	166
EP-1610-14-14	CLAM	166
PR-0009-N3-00	DUPLO	24
PR-0010-N3-00	DUPLO	24
PR-0011-N3-00	DUPLO	24
PR-0012-N3-00	DUPLO	24
PR-0013-N3-00	DUPLO	24
PR-0014-N3-00	DUPLO	25
PR-0015-N3-00	DUPLO	25
PR-0016-N3-00	DUPLO	25
PR-0019-N3-00	MACH1	20
PR-0020-N3-00	MACH1	20
PR-0383-N3-00	MACH1	20
PR-0385-N3-00	MACH1	20
PR-0901-14-00	BUBO	15
PR-0901-60-00	BUBO	15
PR-0901-N3-00	BUBO	15
PR-0902-14-00	BUBO	15
PR-0902-60-00	BUBO	15
PR-0902-N3-00	BUBO	15
PR-0903-14-00	BUBO	15
PR-0903-60-00	BUBO	15
PR-0903-N3-00	BUBO	15
PR-0906-14-00	BUBO	14
PR-0906-60-00	BUBO	14
PR-0906-N3-00	BUBO	14
PR-0907-14-00	BUBO	14
PR-0907-60-00	BUBO	14
PR-0907-N3-00	BUBO	14
PR-0908-14-00	BUBO	14
PR-0908-60-00	BUBO	14
PR-0908-N3-00	BUBO	14
PR-0909-14-00	BUBO	14
PR-0909-60-00	BUBO	14

Código/Code	Gama/Range	Pag
PR-0909-N3-00	BUBO	14
PR-0910-14-00	BUBO	14
PR-0910-60-00	BUBO	14
PR-0910-N3-00	BUBO	14
PR-0911-14-00	BUBO	14
PR-0911-60-00	BUBO	14
PR-0911-N3-00	BUBO	14
PR-0912-14-00	BUBO	14
PR-0912-60-00	BUBO	14
PR-0912-N3-00	BUBO	14
PR-0913-14-00	BUBO	14
PR-0913-60-00	BUBO	14
PR-0913-N3-00	BUBO	14
PR-0914-14-00	BUBO	14
PR-0914-60-00	BUBO	14
PR-0914-N3-00	BUBO	14
SP-0087-N3-B9	FILIPA	141
SP-0088-N3-B9	FILIPA	141
SP-0089-N3-37	FILIPA	140
SP-0089-N3-B9	FILIPA	140
SP-0089-N3-S2	FILIPA	140
SP-0090-N3-37	FILIPA	140
SP-0090-N3-B9	FILIPA	140
SP-0090-N3-S2	FILIPA	140
SP-0091-N3-37	FILIPA	140
SP-0091-N3-B9	FILIPA	140
SP-0091-N3-S2	FILIPA	140
SP-0092-N3-37	FILIPA	140
SP-0092-N3-B9	FILIPA	140
SP-0092-N3-S2	FILIPA	140
SP-0100-S2-00	LEDIO	148
SP-0105-N3-00	MULTIDIR	113
SP-0108-N3-37	FILIPA	141
SP-0650-N3-B9	RECTA	136
SP-0651-N3-B9	RECTA	136
SP-0652-N3-B9	RECTA	136
SP-0654-N3-B9	RECTA	136
SP-0655-N3-B9	RECTA	136
SP-0656-N3-B9	RECTA	136
SP-0658-N3-B9	RECTA	136
SP-0659-N3-B9	RECTA	136
SP-0660-N3-B9	RECTA	136
SP-1801-N3-B9	LOMA	126
SP-1802-N3-B9	LOMA	126
SP-1803-N3-B9	LOMA	126
SP-1805-N3-B9	LOMA	126
SP-1806-N3-B9	LOMA	126
SP-1807-N3-B9	LOMA	126

OTRAS LUMINARIAS / ANOTHER LUMINAIRES

Código/Code	Gama/Range	Pag
00-0338-Y6-Y6	LINEAR (GROK)	202
15-2779-S2-M1	ONA (GROK)	203
15-2780-S2-M1	ONA (GROK)	203
15-2781-S2-M1	ONA (GROK)	203
05-9227-34-37	AFRODITA (OUTDOOR)	206
05-9227-Z5-37	AFRODITA (OUTDOOR)	206
05-9228-34-37	AFRODITA (OUTDOOR)	206
05-9228-Z5-37	AFRODITA (OUTDOOR)	206
05-9252-34-37	POMPEYA (OUTDOOR)	205
05-9253-34-37	POMPEYA (OUTDOOR)	205
05-9254-34-37	POMPEYA (OUTDOOR)	205
05-9368-34-37	AFRODITA (OUTDOOR)	206
05-9368-Z5-37	AFRODITA (OUTDOOR)	206
05-9369-34-37	AFRODITA (OUTDOOR)	206
05-9369-Z5-37	AFRODITA (OUTDOOR)	206
05-9388-34-T2	MICENAS (OUTDOOR)	205
05-9388-Z5-T2	MICENAS (OUTDOOR)	205
15-9362-34-37	COSMOS (OUTDOOR)	207
15-9362-Z5-37	COSMOS (OUTDOOR)	207
15-9363-34-37	COSMOS (OUTDOOR)	207
15-9363-Z5-37	COSMOS (OUTDOOR)	207
15-9364-34-37	COSMOS (OUTDOOR)	207
15-9364-Z5-37	COSMOS (OUTDOOR)	207
15-9365-34-37	COSMOS (OUTDOOR)	207
15-9365-Z5-37	COSMOS (OUTDOOR)	207
15-9381-Y4-37	GEA (OUTDOOR)	208
15-9391-Y4-T2	GEA (OUTDOOR)	208
15-9392-Y4-T2	GEA (OUTDOOR)	208
55-9187-Y4-37	GEA (OUTDOOR)	211
55-9232-Y4-37	GEA (OUTDOOR)	210
55-9233-Y4-37	GEA (OUTDOOR)	210
55-9264-Y4-37	GEA (OUTDOOR)	209
55-9265-Y4-37	GEA (OUTDOOR)	209
55-9266-Y4-37	GEA (OUTDOOR)	209
55-9267-Y4-37	GEA (OUTDOOR)	210
55-9323-Y4-37	GEA (OUTDOOR)	211
55-9337-Y4-37	GEA (OUTDOOR)	212
55-9384-Y4-37	GEA (OUTDOOR)	212
55-9395-Y4-37	GEA (OUTDOOR)	211
71-9187-Y4-37	GEA (OUTDOOR)	211



La empresa se reserva el derecho de modificar las descripciones técnicas y dimensiones o anular cualquier artículo sin previo aviso.

No se aceptará responsabilidad alguna debida a errores de impresión.

Todas las luminarias cumplen con las directivas comunitarias a las que están sujetas los productos de iluminación y van marcadas con el logotipo CE.

Los artículos especiales, a fabricar previa demanda, son variaciones de los artículos estándar, hecho que puede implicar la supresión de las marcas de aprobación y del número de tipo. En cualquier caso, se fabrican bajo cumplimiento de las directivas comunitarias aplicables y siguen un estricto control de calidad avalado por la certificación ISO 9001 y por la ISO 14001, que ratifica la garantía del sistema de gestión ambiental de LEDS-C4

En las luminarias en las que no se incluye el transformador o equipo de funcionamiento necesario, si éste no se solicita y suministra junto con la luminaria, ésta no estará sometida a la "Directiva de Compatibilidad Electromagnética (EMC)" y la responsabilidad final en cuanto a su cumplimiento recae en el instalador. A menos que se especifique lo contrario, las lámparas no se suministran junto con la luminaria.

Our company reserves the right to modify the technical descriptions or delete any item without previous warning.

No responsibility shall be derived from printing errors.

All luminaires comply with the European norms and have the CE mark.

All derived and special luminaires are variations of the standard ones which might implicate the suppression of the approval marks. In any case, they are manufactured in accordance with applicable EU community directives. They follow a strict quality control process that has been certified by ISO 9001 and ISO 14001, which attests to the LEDS-C4's environmental management system.

The necessary transformer or switchgear is not included with the luminaires, unless it has been requested and supplied with the luminary. The luminary will not be subject to the "Electromagnetic Compatibility (EMC) directive" and ultimate responsibility as regards compliance lies with the fitter.

Unless specified otherwise, lamps are not included with the luminaires.

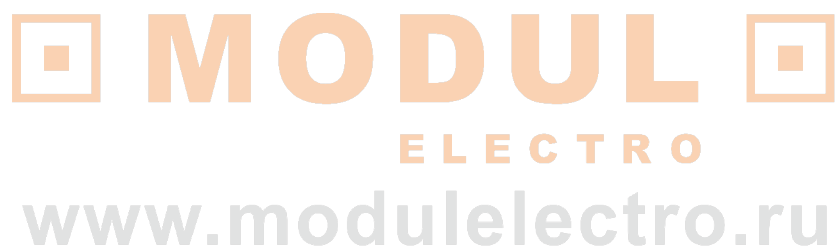

Todos los derechos reservados. Ninguna parte de este libro puede ser reproducida en ningún formato de papel o electrónico, sin el consentimiento previo del editor o de los propietarios de los derechos.

All rights reserved. No part of this publication may be reproduced or transmitted in any form or by any means, electronic storage and retrieval system, without permission in writing from the copyright owner (s).



**LEDS-C4, S.A.**

Afuera s/n, - 25750 - TORA (Lleida) SPAIN

[www.leds-c4.com](http://www.leds-c4.com)

**España**

Tel.: 973 46 81 01

Fax.: 973 46 81 29

[info@leds-c4.com](mailto:info@leds-c4.com)

**Europe**

Tel.: + 34 973 46 81 02

Fax.: + 34 973 46 81 06

[europe@leds-c4.com](mailto:europe@leds-c4.com)

**France - Portugal**

Tel.: + 34 973 46 81 30

Fax.: + 34 973 46 81 29

[france@leds-c4.com](mailto:france@leds-c4.com)

[portugal@leds-c4.com](mailto:portugal@leds-c4.com)

**Asia - Pacific and Africa**

Tel.: + 34 973 46 81 16

Fax.: + 34 973 46 81 06

[export@leds-c4.com](mailto:export@leds-c4.com)

**USA - Canada - Ireland**

Tel.: +34 973 46 81 09

Fax: +34 973 46 81 06

[lighting@leds-c4.com](mailto:lighting@leds-c4.com)

**América Latina**

Tel.: + 34 973 46 81 15

Fax.: + 34 973 46 81 06

[sudamerica@leds-c4.com](mailto:sudamerica@leds-c4.com)

**Middle East Countries**

Tel.: + 34 973 46 81 08

Fax.: + 34 973 46 81 06

[dep-export@leds-c4.com](mailto:dep-export@leds-c4.com)



[www.modulelectro.ru](http://www.modulelectro.ru)