

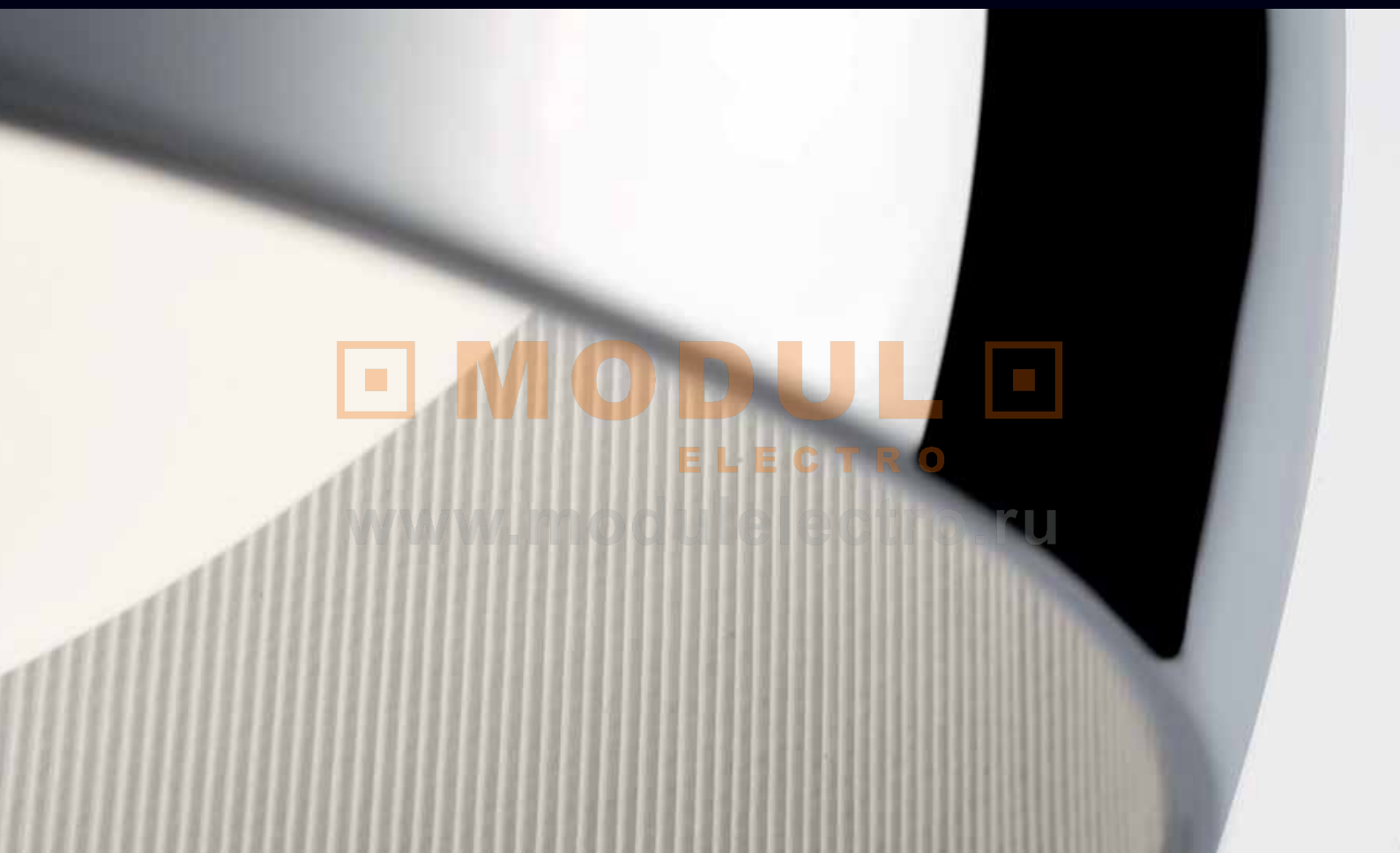

GROK

CATÁLOGO GENERAL 2010
GENERAL CATALOGUE 2010



MODUL
ELECTRO
www.modulelectro.ru

LED S · C4



MODUL
GROK

www.modulelectro.ru

Benedito Design

Beauty's utility.
La utilidad de la belleza.



Jantze, Brogård & Asshoff Design

We beautify and simplify our surroundings to improve the everyday life.
Embellecemos y simplificamos nuestro entorno para mejorar el día a día

Josep Patsí

When art and technique come together.
Cuando arte y técnica se encuentran.



MODUL
ELECTRO

www.modulelectro.ru



Estudi Ribaudí

We work in a world where ideas are born, we make them grow and we transform them into objects.
Trabajamos en el mundo donde nacen las ideas, las hacemos crecer y las transformamos en objetos

WIS Design

Wisdom and poetry for everyday objects.
Sabiduría y poesía para los objetos cotidianos.



Xavi Muixí

It allows us to appreciate all the beauty surrounding us, each project is a trial to make a tribute, The Light.
Ella nos permite apreciar todo lo bello que nos rodea, cada proyecto es un intento de rendirle tributo, La Luz.

_Designers

 **MODULO**
ELECTRO
www.modulelectro.ru

Benedito Design
Jantze, Brogård & Asshoff Design
Josep Patsí
Estudi Ribaudí
WIS Design
Xavi Muixí



MODUL

ELECTRO

www.modulelectro.ru

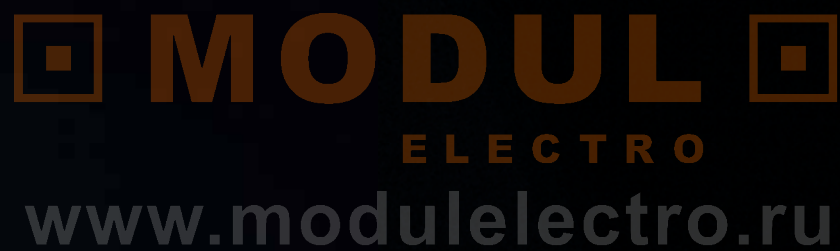

_Índice
_Index
_Index
_Index
_Índice

_colgantes
 _pendants
 _suspensions
 _pendelleuchten
 _lampade a sospensione



adagio_36-38-39

balloons_12 new



class_34



clear_18 new



duna_46



everyday_26



leila_30-32



linear_48

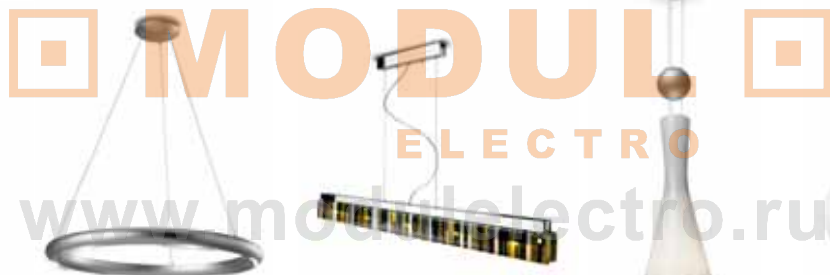

oxygen_44

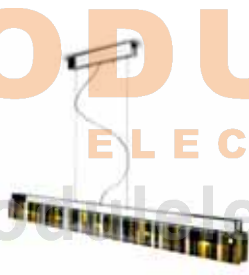

scala_35



shi_28



siluet_16 new



slimm_42



swing_52



tempo_40



troppo_20



twins_50



umbrella_22



_apliques
 _wall fixtures
 _appliques
 _wandleuchten
 _lampade da parete



adagio_68 arc_66 boomerang_78 ciao_80



class_84 dolce_102 duna_82 escher_62 flat_74



hotels_98 ibis_174 leila_96 level_71 mini_178-180



mirror_86 moon_177 nemo_148 ^{new} ola_103 open_90 oxygen_70



quattro_184 scala_104 ska_182 slight_144 ^{new} slimm_72



suite_92 suite_94 tempo_76 traç_56 ^{new} troppo_60 versatil_100

MODULO
 ELECTRO
 www.modulelectro.ru

_sobremesas
 _table lamps
 _lampes de tables
 _tischleuchten
 _lampade da tavolo



adagio_118 adn_123 arc_114 bonne nuit_120 class_122



escher_110 everyday_126 gloria_128 hotels_130 leila_132



office_138 open_136 soul_131 suite_134 suite_135



totem mini_140 troppo_116 umbrella_124

_plafones
 _ceiling fixtures
 _plafoniers
 _deckenleuchten
 _plafoniere



adagio_166 adn_188 basic_168-170-171



diana_176 escher_156 ibis_174 mini_178-180 moon_177



nemo_148 new

ocho_162-164

ona_158

quattro_184

ska_182



slight_144-146 new

slimm_186

square_172

traç_150 new

troppo_152

_pies salón
 _floor lamps
 _lampadaires
 _stehleuchten
 _lampade da terra

MODUL
 ELECTRO
www.modulelectro.ru





adagio_209 adn_204 arc_206 class_208 escher_194 everyday_200 everyday outdoor_196 fiore_223



hotels_214 leila_212 open_220 scala_222 slimm_210 soul_215 suite_218 suite_216 totem_224 troppo_192 umbrella_202



 **MODUL** 
ELECTRO
www.modulelectro.ru



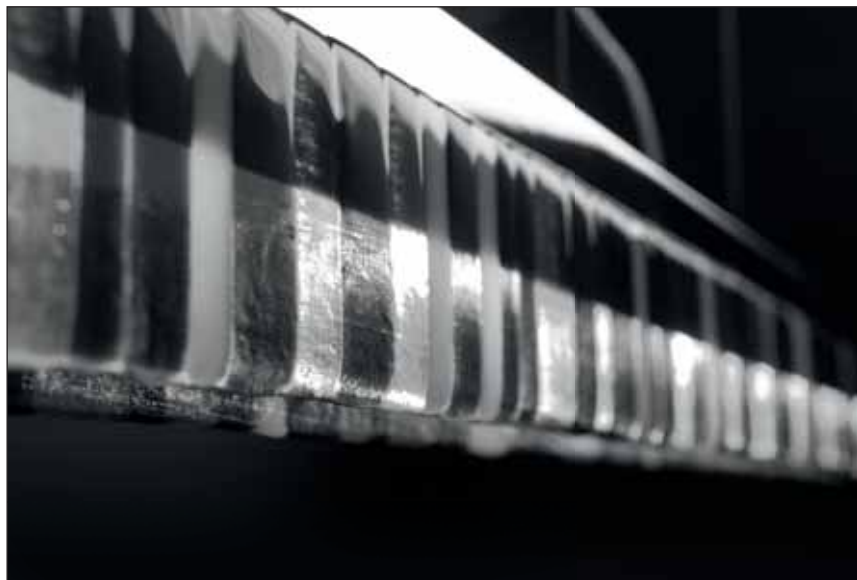

_colgantes

_pendants

_suspensions

_pendelleuchten

_lampade a sospensione

MODUL
ELECTRO

www.modulelectro.ru

- balloons_12
- siluet_16
- clear_18
- troppo_20
- umbrella_22
- everyday_26
- shi_28
- leila_30
- class_34
- scala_35
- adagio_36
- tempo_40
- slimm_42
- oxygen_44
- duna_46
- linear_48
- twins_50
- swing_52

balloons new

design _ Josep Patsi

Estructura y detalles de metal acabado en cromo. Difusor de cristal opal soplado de color blanco mate que permite luz directa e indirecta. Cable de tela. Interior plisado en tela blanca que distribuye la luz en todas direcciones.

Chrome metal body and details. Matte-white blown opal glass diffuser that gives direct and indirect light. Cord cable. White pleated fabric interior that distributes light in all directions.

Structure et détails en métal avec finitions chromées. Diffuseur blanc mat en verre opale soufflé, qui permet la lumière directe et indirecte. Câble en tissu. Intérieur en tissu blanc plissé qui distribue la lumière.

Gehäuse und Details aus verchromtem Metall. Diffusor aus geblasenem Opalglas, Farbe mattweiß, zur direkten und indirekten Beleuchtung geeignet. Textilkabel. Plissierter Innenschirm aus weißem Stoff zur Verteilung des Lichts in alle Richtungen.

Struttura e particolari in metallo, con finitura cromata. Diffusore in cristallo opale soffiato, in colore bianco opaco, che consente luce diretta e indiretta. Cavo in tela. Interno plissettato in tela bianca, che distribuisce la luce in tutte le direzioni.



MODULO
ELECTRO
www.modulelectro.ru



21 Chrome	F9 Verre opal triplex	Optisches Glas	
Chrom	Vetro ottico		

00-4348-21-F9
E-27 Max. 150W
HALOGEN
PL E-27 30W
ENERGY SAVING



MODUL
ELECTRO
www.modulelectro.ru



MODULO
ELECTRO
www.modulelectro.ru



DUJ
ELECTRO
www.modulelectro.ru

Estructura de poliuretano pintado en color blanco. Difusor de policarbonato matizado. Cable forrado en tela. Luz directa e indirecta.

Polyurethane body painted in white. Matte polycarbonate diffuser. Cord cable. Direct and indirect light.

Structure en polyuréthane peint en blanc. Diffuseur en polycarbonate teinté. Câble en tissu rayé. Lumière directe et indirecte.

Gehäuse aus Polyurethan, weiß lackiert. Diffusor aus matten Polykarbonat. Stoffisoliertes Kabel. Zur direkten und indirekten Beleuchtung.

Struttura in poliuretano dipinto, di colore bianco. Diffusore in policarbonato opacizzato. Cavo rivestito di tela. Luce diretta e indiretta.



MODUL

ELECTRO

www.modulelectro.ru

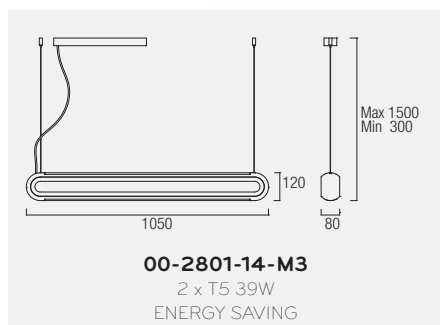

Iluminación indirecta
Indirect light



Iluminación directa
Direct light



- | | |
|------------------------------------|--|
| ○ Blanco
White | ○ Policarbonato mate
Matt polycarbonate |
| 14 Blanc
Weiss
Bianco | M3 Polycarbonate mat
Matter Polykarbonat
Polycarbonato matt |



MODUL
ELECTRO
www.modulselectro.ru

clear ^{new}

design _ Josep Patsí

Estructura metàlica acabada en cromo negro. Cable de tela. El difusor óptico de policarbonato transparente permite una luz ideal para ambientes íntimos.

Black chrome metal body and details. Cord cable. The transparent polycarbonate optical diffuser provides ideal lighting for intimate atmospheres.

Structure métallique avec finitions chromées noires. Câble en tissu. Le diffuseur optique en polycarbonate transparent diffuse une lumière idéale pour les atmosphères intimes.

Gehäuse aus verchromtem Metall in Schwarz. Textilkabel. Diffusor aus transparentem Polycarbonat, ideal zur diskreten Ambientebeleuchtung.

Struttura metallica rifinita con cromatura nera. Cavo in tela. Il diffusore ottico in policarbonato trasparente consente la luce ideale per ambienti raccolti.



MODULO
ELECTRO
www.modulelectro.ru

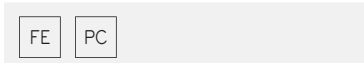

- Cromo negro
Black chrome
Chrome noir
Schwartz Chrom
Cromo nero
- Policarbonato transparente
Transparent polycarbonate
M2 Polycarbonate transparent
Transparenter Polykarbonat
Policarbonato transparente

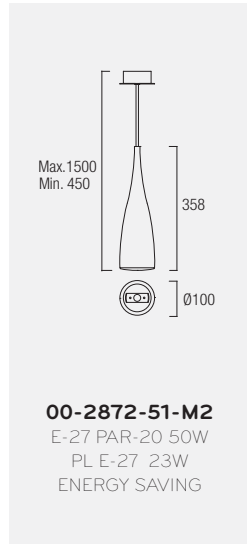

MODUL
ELECTRO
www.modulelectro.ru

tropo

design _Benedito Design

tropo_collection

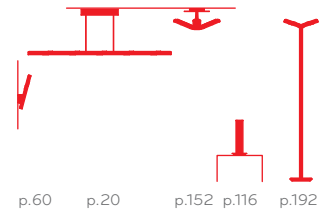

Estructura de aluminio acabado en cromo. Cristales de borosilicato matizado. Elegante combinación de formas simples: líneas y círculos. Emite luz directa y también indirecta gracias a las aperturas de la parte superior de la estructura.

Chrome aluminium body. Matte borosilicate glass. Elegant combination of simple shapes - lines and circles. Provides direct and indirect light thanks to openings at the top of the luminaire.

Structure en aluminium avec finitions chromées. Verre borosilicate teinté. Combinaison élégante de formes simples telles que des lignes et des cercles. Émet une lumière directe mais aussi indirecte grâce aux ouvertures de la partie supérieure de la structure.

Gehäuse aus verchromtem Aluminium. Mattes Borosilikatglas. Elegante Kombination einfacher Formen: Linien und Kreise. Direkte Beleuchtung sowie indirekte Beleuchtung durch die Öffnungen an der Oberseite der Leuchte.

Struttura in alluminio con finitura cromata. Cristalli di borosilicato opacizzato. Elegante accostamento di forme semplici: linee e cerchi. Emette luce diretta e indiretta, anche grazie alle aperture della parte superiore della struttura.



MODULO
ELECTRO
www.modulelectro.ru

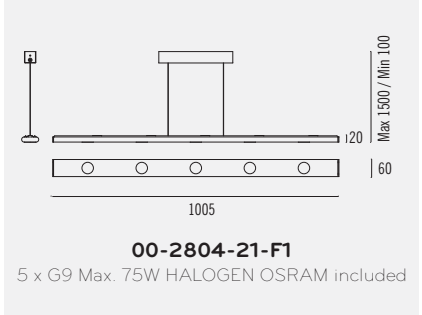

Cromo	Cristal anti-deslumbrante		
Chrome	Anti-glare glass		
21 Chrome	F1 Verre antiéblouissante		
Chrom	Blendfreies Glas		
Cromo	Vetro antiriflesso		





 **MODUL** 
ELECTRO
www.modulelectro.ru

umbrella

design _ WIS design

umbrella_collection

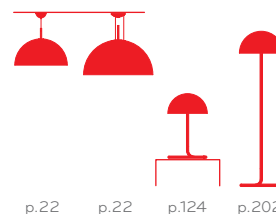

Estructura semiesférica disponible en acabados blanco y negro. Difusor de cristal óptico matizado. Interior plisado disponible en plateado y dorado respectivamente. Disponible en 2 diámetros, 60cm y 100cm. Cable de tela. Luz directa.

Semispherical body available in black and white. Matte optical glass diffuser. Pleated interior available in silver and gold. Available in 2 sizes: 60 cm and 100 cm. Cord cable. Direct light.

Structure semisphérique avec finitions proposées en noir et en blanc. Diffuseur en verre optique teinté. Intérieur plissé disponible en argenté ou en doré. Décliné en deux diamètres: 60 cm et 100 cm. Câble en tissu. Lumière directe.

Halbrundes Gehäuse, in Weiß und Schwarz lieferbar. Diffusor aus mattem Optikglas. Mit silber- oder goldfarbenen plissiertem Innenschirm lieferbar. In 2 Durchmessern lieferbar: 60 cm oder 100 cm. Textilkabel. Direkte Beleuchtung.

Struttura semisferica, disponibile con finitura bianca e nera. Diffusore in cristallo ottico opacizzato. Interno plissettato disponibile nella versione argentata e dorata. Disponibile in 2 diametri, 60 cm e 100 cm. Cavo in tela. Luce diretta.

MODULO
ELECTRO
www.modulelectro.ru



AP Pantalla interior plisada dorada
Golden pleated interior shade
Intérieur d'abat-jour plissé doré
Schirm, Innenseite Gold plissee
Paralume interna plisata oro

05 Lacado negro
Black lacquered
Laqué en noir
Schwarz lackiert
Laccato nero

AQ Pantalla interior plisada plata
Silver pleated interior shade
Intérieur d'abat-jour plissé argenté
Schirm, Innenseite Silver plissee
Paralume interna plisada argento

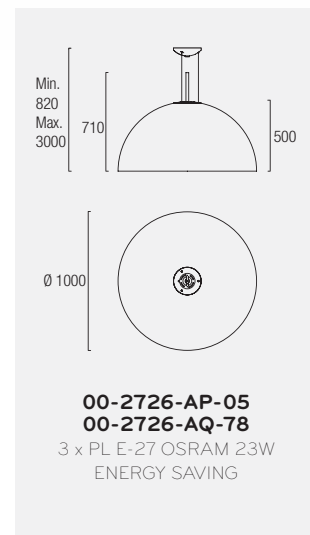
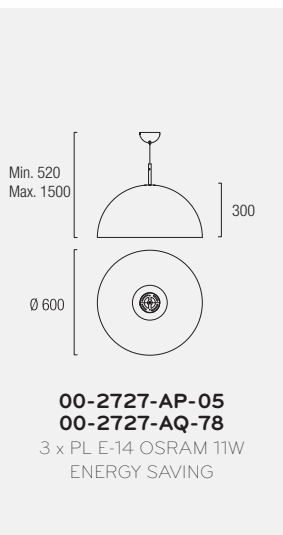

78 Lacado blanco
White lacquered
Laqué en blanc
Weiss lackiert
Laccato bianco





MODUL
ELECTRO
www.modulelectro.ru

umbrella

 **MODUL** 
ELECTRO
www.modulelectro.ru

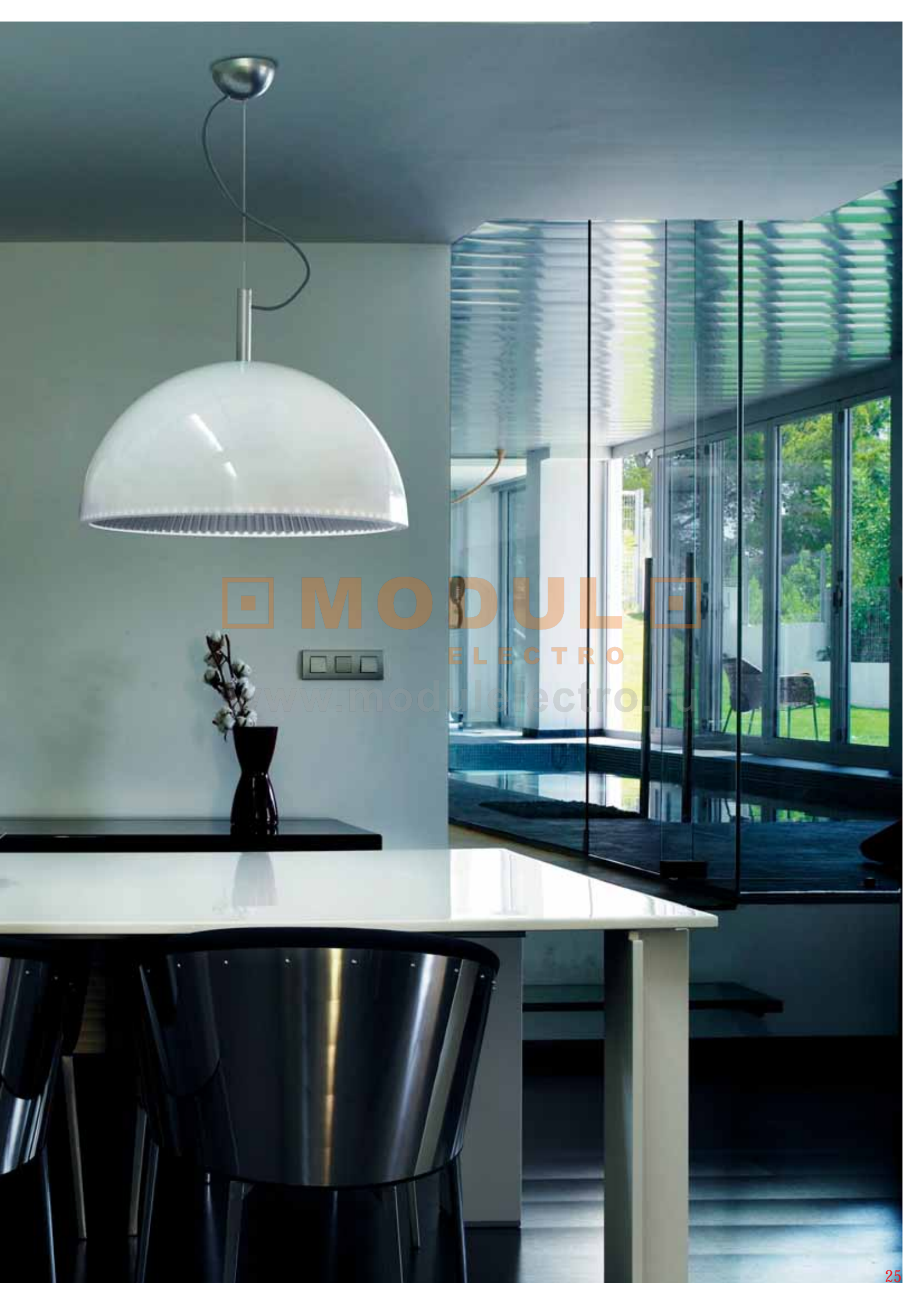

MODULE
ELECTRO
www.modulelectro.fr

everyday

design _ JBA design

everyday_collection

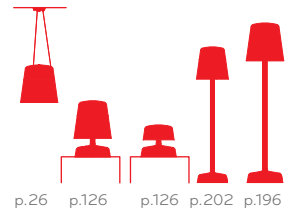

Estructura metálica blanca combinada con un difusor de cristal opal que oculta completamente la fuente de luz. Cable de tela.

White metal body combined with an opal glass diffuser that completely hides the light source. Cord cable.

Structure métallique blanche associée à un diffuseur en verre opale qui cache entièrement la source de lumière. Câble en tissu.

Gehäuse aus Metall, weiß lackiert. Kombiniert mit Diffusor aus Opalglas, der die Lichtquelle komplett verdeckt. Textilkabel.

Struttura metallica in colore bianco, abbinata a un diffusore in cristallo opale, che cela completamente la fonte luminosa. Cavo in tela.



MODUL
ELECTRO

www.modulelectro.ru

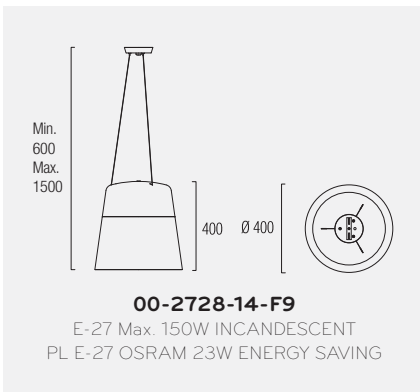

- | | |
|-----------------|------------------------------|
| ○ Blanco | ○ Cristal opal triplex |
| ○ White | ○ Triplex Opal glass |
| 14 Blanc | F9 Verre opal triplex |
| ○ Weiss | ○ Optisches Glas |
| ○ Bianco | ○ Vetro ottico |

MODUL
ELECTRO
www.modulelectro.ru



shi

design _ Josep Patsi

Estructura y esfera metálicas en acabado aluminio mate. Difusor de cristal opal disponible en negro y en blanco. Luz inferior directa. Luz superior de ambiente, que permite el cambio de color gracias al mando a distancia incluido.

Matte aluminium body and sphere. Opal glass diffuser available in black and white. Direct lower light. Ambient upper light that can change colour using the remote control included.

Structure et sphère métalliques avec finitions en aluminium mat. Diffuseur en verre opale proposé en noir et en blanc. Lumière inférieure directe. Lumière supérieure d'ambiance avec changement de couleur grâce à la télécommande fournie.

Gehäuse und Kugel aus Metall, Oberfläche matten Aluminium. Diffusor aus Opalglas, lieferbar in Schwarz und in Weiß. Unteres Licht direkte Beleuchtung. Oberes Licht Ambientebeleuchtung, mit Farbwechsel über mitgelieferter Fernbedienung.

Struttura e sfere metalliche con finitura in alluminio opaco. Diffusore in cristallo opale, disponibile in nero e in bianco. Luce inferiore diretta. Luce ambiente superiore, che consente di cambiare il colore grazie al telecomando fornito.

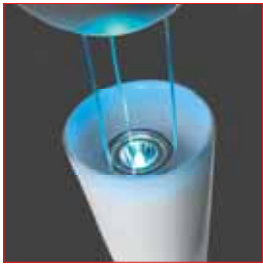

Cambio de color LED con mando a distancia
LED color changing with remote control
Changement de couleur par télécommande à distance
LED Farbwechsel mit Fernbedienung
Cambio di colore del LED con comando

MODUL
ELECTRO
www.modulelectro.ru

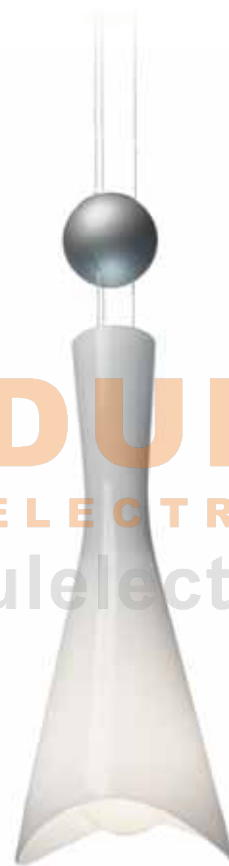

Y5  Aluminio mate
Matt aluminium
Aluminium mat
Alluminium matt
Alluminio opaco

05  Cristal opal negro
Black opal glass
Verre opale noir
Schwarzes Opalglas
Vetro opal nero

14  Cristal opal blanco
White opal glass
Verre opale blanc
Weisses Opalglas
Vetro opal bianco

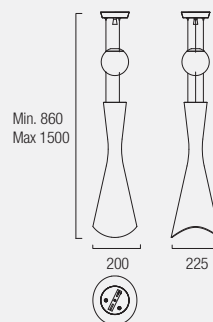

00-2725-Y5-05
00-2725-Y5-14

E-27 Max. 100W INCANDESCENT
GU10 LEDS 5W Included



MODULO
ELECTRO
www.modulelectro.ru

leila

design_Benedito Design

leila_collection

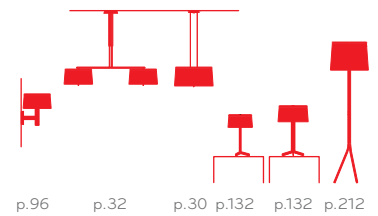

Estructura metálica en acabado cromo y aluminio satinado. Pantallas de tela disponibles en negro y en blanco. Difusor de metacrilato matizado. Sistema de doble iluminación Up & Down. Regulación de la luz superior mediante dimmer y inferior mediante ON-OFF. Luz directa e indirecta.

Chrome or satin aluminium body. Fabric shades available in black and white. Matte methacrylate diffuser. Up & Down double lighting system. Upper light regulated using dimmer switch and lower light by using on/off switch. Direct and indirect light.

Structure métallique avec finitions chromées et en aluminium satiné. Écrans en tissu, proposés en noir et en blanc. Diffuseur en méthacrylate teinté. Système à double éclairage «Up & Down». Réglage de la lumière supérieure par variateur et de la lumière inférieure par interrupteur. Lumière directe et indirecte.

Metallgehäuse, Oberfläche verchromt und aus satiniertem Aluminium. Stoffschirme in Schwarz und Weiß lieferbar. Diffusor aus matiertem Plexiglas. Doppeltes Beleuchtungssystem Up & Down. Regulierung des Oberlichts mit Dimmer und Regulierung des Unterlichts mit Ein-/Aus-Schalter. Zur direkten und indirekten Beleuchtung.

Struttura metallica con finitura cromata e alluminio satinato. Paralumi in tela disponibili in colore nero e bianco. Diffusore in metacrilato opacizzato. Sistema a doppia illuminazione Up & Down. Regolazione della luce superiore tramite un dimmer e di quella inferiore tramite ON-OFF. Luce diretta e indiretta.



ON - OFF

ILUMINACIÓN INFERIOR (E-27)
BOTTOM LIGHTING (E-27)

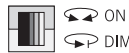

ON - OFF

DIMMER

DIMMER
ILUMINACIÓN SUPERIOR (G9)
TOP LIGHTING (G9)

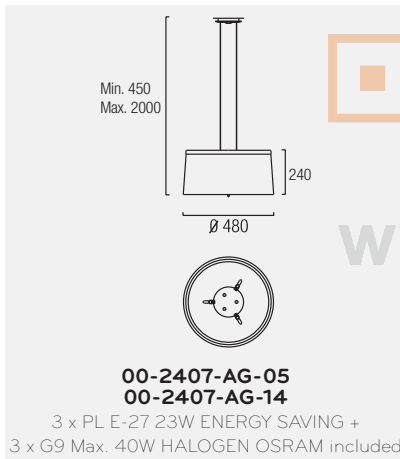

Metacrilato matizado / Methacrylate diffuser



AG Aluminio con cromo
Aluminium with chrome
Aluminium avec chrome
Aluminium mit Chrom
Alluminio con cromo

05 Pantalla negra de tela incluida
Black fabric shade included
Abat-jour noir en tissu compris
Schwarz Schirm inklusiv
Paralume di tela nero inclusa

14 Pantalla blanca de tela incluida
White fabric shade included
Abat-jour blanche en tissu compris
Weiss Schirm inklusiv
Paralume di tela bianca inclusa



MODULO
ELECTRO
www.modulelectro.ru

A photograph of a dining room featuring a dark wooden table and six chairs with high, slatted backs. A large, cylindrical pendant lamp hangs above the table. The room has large windows with sheer curtains, and the floor is dark and reflective. The overall lighting is dim, with light coming from the windows and the lamp.

MODUL
ELECTRO
www.modulelectro.ru



ON - OFF

ILUMINACIÓN INFERIOR (E-14)
BOTTOM LIGHTING (E-14)



ON - OFF
DIMMER

DIMMER
ILUMINACIÓN SUPERIOR (G9)
TOP LIGHTING (G9)

Dimmer para la iluminación superior en una pantalla e interruptor ON-OFF para la iluminación inferior en la otra pantalla

Dimmer for the top lighting in one shade, and ON-OFF switch for bottom lighting in the other shade

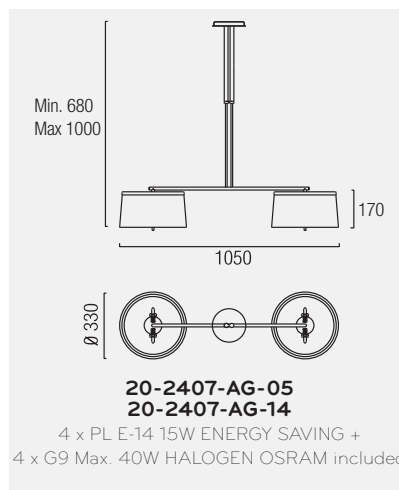

Metacrilato matizado / Methacrylate diffuser



MODUL
ELECTRO
www.modulelectro.ru

class

design _ Josep Patsí

class_collection

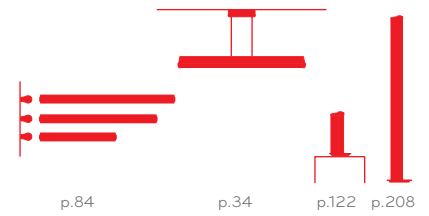

Estructura de aluminio Ecobright. Doble difusor: interior de policarbonato opal y exterior de borosilicato transparente. Luz directa.

Ecobright aluminium body. Double diffuser - inner: opal polycarbonate, exterior: transparent borosilicate Direct light.

Structure en aluminium Ecobright. Double diffuseur : intérieur en polycarbonate opale et extérieur en borosilicate transparente. Lumière directe.

Gehäuse aus Ecobright-Aluminium. Doppelter Diffusor: Innen aus Opal-Polykarbonat und außen aus transparentem Borosilikat. Direkte Beleuchtung.

Struttura in alluminio Ecobright. Doppio diffusore: interno in policarbonato opale ed esterno in borosilicato trasparente. Luce diretta.



Doble difusor
Double diffuser
Diffuseur double
Doppelglas
Difusore doppio

MODULO
ELECTRO
www.modulelectro.ru

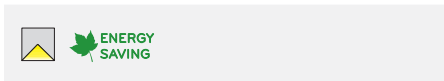
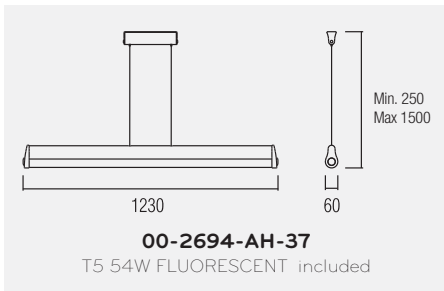

○ Aluminio Ecobright
Ecobright aluminium
AH Aluminium Ecobright
Ecobright aluminium
Alluminio Ecobright



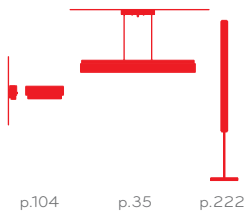

Estructura metálica en acabado cromo. Difusor de cristal fusing con tonos color cava. Luz directa.

Chrome metal body. Fusing glass diffuser in pale yellow tones. Direct light.

Structure métallique avec finitions chromées. Diffuseur en verre fondu avec des tons champagne. Lumière directe.

Gehäuse aus verchromtem Metall. Diffusor aus Fusing-Glas mit Sektfarbtönen. Direkte Beleuchtung.

Struttura metallica con finitura cromata. Diffusore in cristallo fusing, con toni color champagne. Luce diretta.

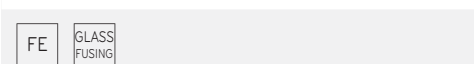
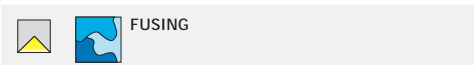
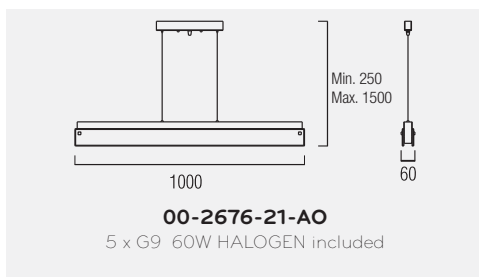

- Cromo
- Chrome
- 21** Chrome
- Chrom
- Cromo
- Cristal fusing cava
- Fusing cava glass
- AO** Verre fusing "cava"
- Sektfarbiges-fusing-Glas
- Vetro fusing cava

adagio

design _ Josep Patsí

adagio_collection

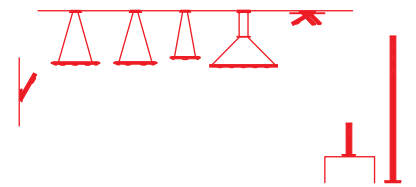

p.68 p.38 p.39 p.38 p.36 p.166 p.118 p.209

Estructura de aluminio y difusores de cristal anti-deslumbrante. Disponible en 4 versiones: lineal, cuadrada, rectangular de 6 y 8 luces. Disponible en acabados cromo y aluminio pulido satinado. Luz directa e indirecta.

Aluminium body and anti-glare glass diffusers. Available in 4 versions: line, square, 6-light and 8-light rectangle. Available in chrome or polished and satin aluminium. Direct and indirect light.

Structure en aluminium et diffuseurs en verre antireflets. Proposée en quatre versions : linéaire, carrée et rectangulaire avec six/huit lumières. Finitions chromées d'une part, et polies et satinées en aluminium d'autre part. Lumière directe mais aussi indirecte.

Gehäuse aus Aluminium und Diffusore aus entspiegeltem Glas. In 4 Ausführungen lieferbar: Linear, quadratisch, rechteckig 6 Lampen und 8 Lampen. Alle Ausführungen sind auch mit verchromter Oberfläche und aus poliertem satiniertem Aluminium lieferbar. Direkte Beleuchtung sowie indirekte Beleuchtung.

Struttura in alluminio e diffusori in cristallo anti-abbagliamento. Disponibile in 4 versioni: lineare, quadrata, rettangolare a 6 luci e a 8 luci. Disponibili con finitura cromata e finitura in alluminio lucido satinato. Luce diretta e indiretta.



MODULO
ELECTRO
www.modulelectro.ru

□ F RF 850°C



AL GLASS MAT

● Cromo
21 Chrome
Chrome
Chrom
Cromo

● Aluminio pulido y satinado
S3 Polished and burnished aluminium
Aluminium poli et satiné
Aluminium poliert und mattglänzend
Alluminio lucidato e satinato

○ Cristal anti-deslumbrante
F1 Anti-glare glass
Verre antiéblouissant
Blendfreies Glas
Vetro antiriflesso

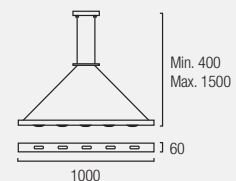

00-0221-21-F1
00-0221-S3-F1
5 x G9 Max. 75W 230V
HALOGEN OSRAM included



MODUL
ELECTRO
www.modul-electro.ru

ES.
nsola

TORRES.
Fransola

TORRES.
Fransola

TORRES.
Fransola

TORRES.
Fransola

adagio

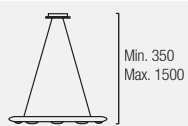

Min. 350
Max. 1500

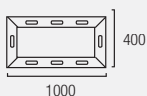

1000

400

20-0313-21-F1
20-0313-S3-F1

8 x G9 Max. 75W 230V
HALOGEN OSRAM included



MODUL
ELECTRO

www.modulelectro.ru



Min. 200
Max. 1500

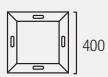

400

400

20-0221-21-F1
20-0221-S3-F1

4 x G9 Max. 75W 230V
HALOGEN OSRAM included





Min. 300
Max. 1500

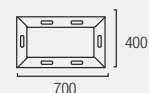



400

700

20-0536-21-F1
20-0536-S3-F1

6 x G9 Max. 75W 230V
HALOGEN OSRAM included

 **MODULO** 
ELECTRO
www.modulelectro.ru

tempo

design _ Josep Patsí

tempo_collection

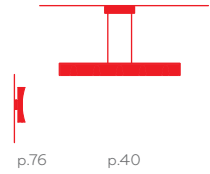

p.76

p.40

Estructura de aluminio disponible en 3 acabados: Ecobright, lacado negro y lacado blanco. Luz directa e indirecta gracias al difusor de metacrilato transparente matizado.

Aluminium body available in 3 finishes: Ecobright, black lacquer or white lacquer. Direct and indirect light thanks to matte and transparent methacrylate diffuser.

Structure en aluminium proposée avec trois finitions: Ecobright, verni noir et verni blanc. Lumière directe et indirecte grâce au diffuseur en méthacrylate teinté transparent.

Gehäuse aus Aluminium, lieferbar in 3 Ausführungen: Ecobright, schwarz lackiert und weiß lackiert. Zur direkten und indirekten Beleuchtung durch Diffusor aus transparentem mattiertem Plexiglas.

Struttura in alluminio, disponibile in 3 finiture: Ecobright, laccato nero e laccato bianco. Luce diretta e indiretta, grazie al diffusore in metacrilato trasparente opacizzato.



Metacrilato transparente matizado
Transparent sand-blasted methacrylate

MODULO

ELECTRO

www.modulelectro.ru

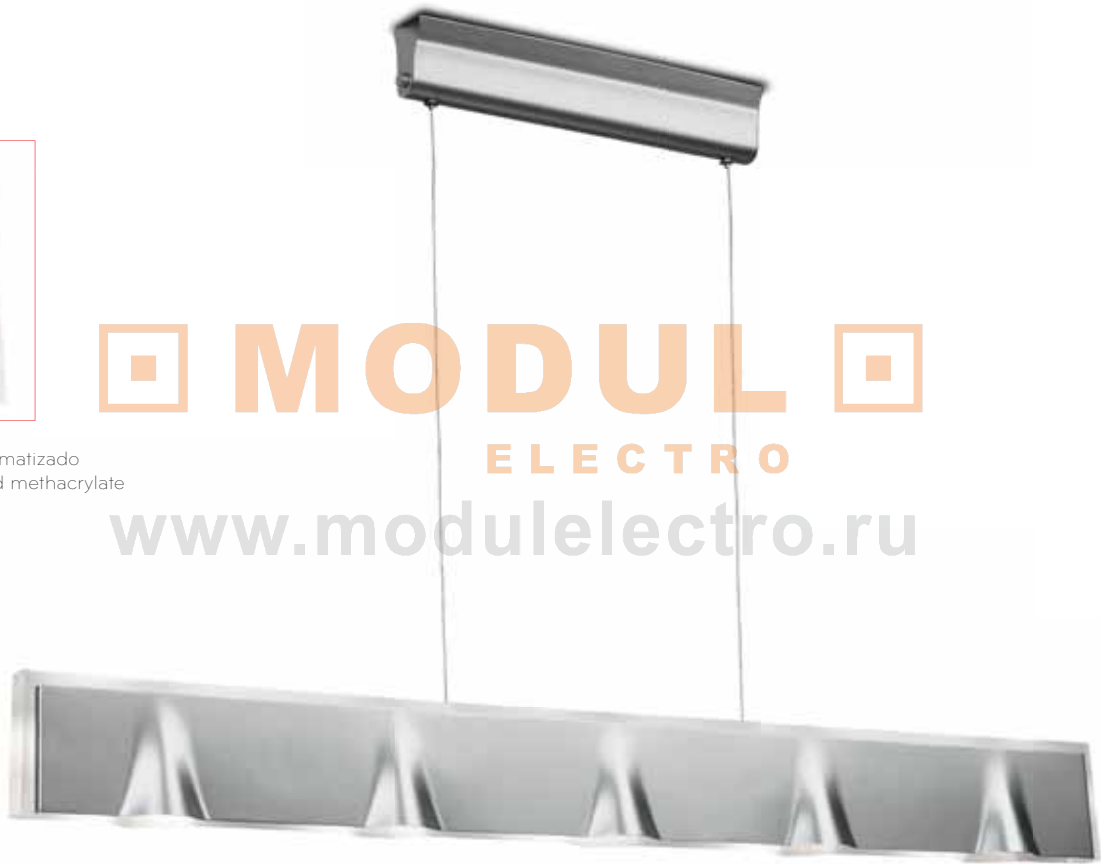

○ Aluminium Ecobright
Ecobright aluminium
AH Aluminium Ecobright
Ecobright aluminium
Alluminio Ecobright

● Lacado negro
Black lacquered
05 Laqué en noir
Schwarz lackiert
Laccato nero

○ Lacado blanco
White lacquered
78 Laqué en blanc
Weiss lackiert
Laccato bianco

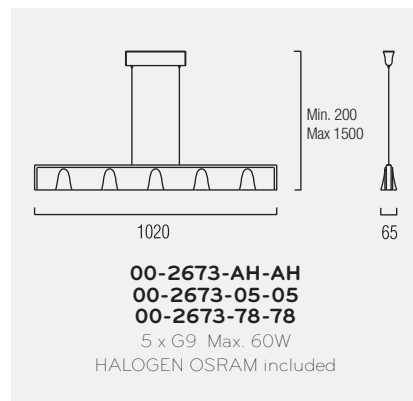



MODUL
ELECTRO

www.modulerealestate.ru



slimm

design _ Estudi Ribaudi

slimm_collection

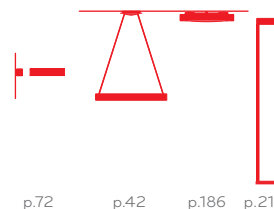

Estructura metálica disponible en acabados cromo y aluminio mate. Difusor de cristal óptico en la parte inferior. Incluye embellecedores de metacrilato en 3 colores intercambiables. Luz directa e indirecta.

Metal body available in chrome or matte aluminium. Optical glass diffuser in lower part. Includes methacrylate trims in 3 interchangeable colours. Direct and indirect light.

Structure métallique proposée avec finitions chromées et en aluminium mat. Diffuseur en verre optique pour la partie inférieure. Inclut des caches en méthacrylate en trois couleurs interchangeables. Lumière directe et indirecte.

Metallgehäuse lieferbar in Chrom und mattem Aluminium. Diffusor aus Optikglas an Unterseite. Mitgeliefert werden austauschbare Plexiglasauflätze in 3 Farben. Zur direkten und indirekten Beleuchtung.

Struttura metallica disponibile con finitura cromata e alluminio opaco. Diffusore in cristallo ottico nella parte inferiore. Comprende elementi decorativi in metacrilato, in 3 colori intercambiabili. Luce diretta e indiretta.



Incluye 3 acrílicos de color intercambiables
Includes 3 color interchangeable acrylic pieces

	Cromo Chrome 21 Chrome Chrom Cromo		
	Cristal óptico Optic glass E9 Verre optique Optisches Glas Vetro ottico		
	Aluminio mate Matt aluminium Y5 Aluminium mat Alluminium matt Alluminio opaco		

MODULO
ELECTRO
www.modulelectro.ru



00-2397-Y5-E9
00-2397-21-E9
2 x R7s L=118 Max. 150W
HALOGEN OSRAM included



MODUL
ELECTRO
www.modulelectro.ru

oxygen

design _ Josep Patsí

oxygen_collection



p.70

p.44

Estructura de aluminio circular acabado Ecobright. Difusores de cristal anti-deslumbrante. Emite luz directa y también indirecta gracias a las aperturas de la parte superior de la estructura.

Circular Ecobright aluminium body. Anti-glare glass diffusers. Provides direct and indirect light thanks to openings at the top of the luminaire.

Structure circulaire en aluminium avec finitions Ecobright. Diffuseurs en verre antireflets. Émet une lumière directe mais aussi indirecte grâce aux ouvertures de la partie supérieure de la structure.

Rundes Gehäuse aus Aluminium, Oberfläche Ecobright. Diffusore aus entspiegeltem Glas. Direkte Beleuchtung sowie indirekte Beleuchtung durch die Öffnungen an der Oberseite der Leuchte.

Struttura in alluminio circolare con finitura Ecobright. Diffusori in cristallo anti-abbagliamento. Emette luce diretta e indiretta, anche grazie alle aperture della parte superiore della struttura.



MODULO
ELECTRO
www.modulelectro.ru

AH Aluminio Ecobright Ecobright aluminium Aluminium Ecobright Ecobright aluminium Alluminio Ecobright	B8 Cristal anti-deslumbrante Anti-glare glass Verre antiéblouissante Blendfreies Glas Vetro antiriflesso		

00-0573-AH-B8
6 x G9 Max. 60W 230V
HALOGEN OSRAM included



MODUL
ELECTRO
www.modulelectro.ru

duna

design _ Álex Sánchez

duna_collection

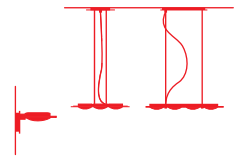

p.82 p.46 p.46

Estructura de aluminio satinado. Difusor de cristal óptico. Disponible en 2 versiones, rectangular y cuadrada. Luz directa e indirecta.

Satin aluminium body. Optical glass diffuser. Available in 2 versions: rectangle and square. Direct and indirect light.

Structure en aluminium satiné. Diffuseur en verre optique. Proposée en deux versions: rectangulaire et carrée.

Gehäuse aus satiniertem Aluminium. Diffusor aus mattem Optikglas. In 2 Ausführungen: rechteckig und quadratisch.

Struttura in alluminio satinato. Diffusore in cristallo ottico. Disponibile in 2 versioni: rettangolare e quadrata.

		RF 850°C
AL	GLASS OPT	
Y6	Aluminio satinado Satin aluminium Aluminium satiné Aluminium matt Alluminio satinato	E9
	Cristal óptico Optic glass Verre optique Optisches Glas Vetro ottico	

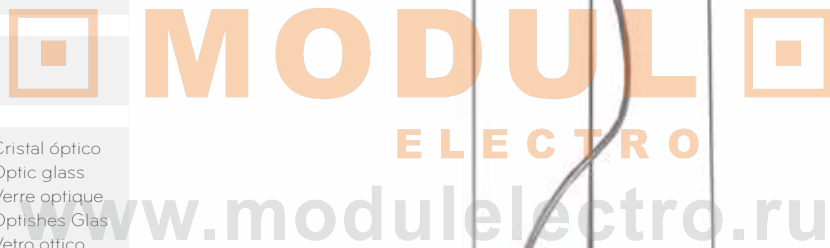

20-0325-Y6-E9
4 x G9 Max. 75W 230V
HALOGEN OSRAM included

20-0326-Y6-E9
4 x G9 Max. 75W 230V
HALOGEN OSRAM included

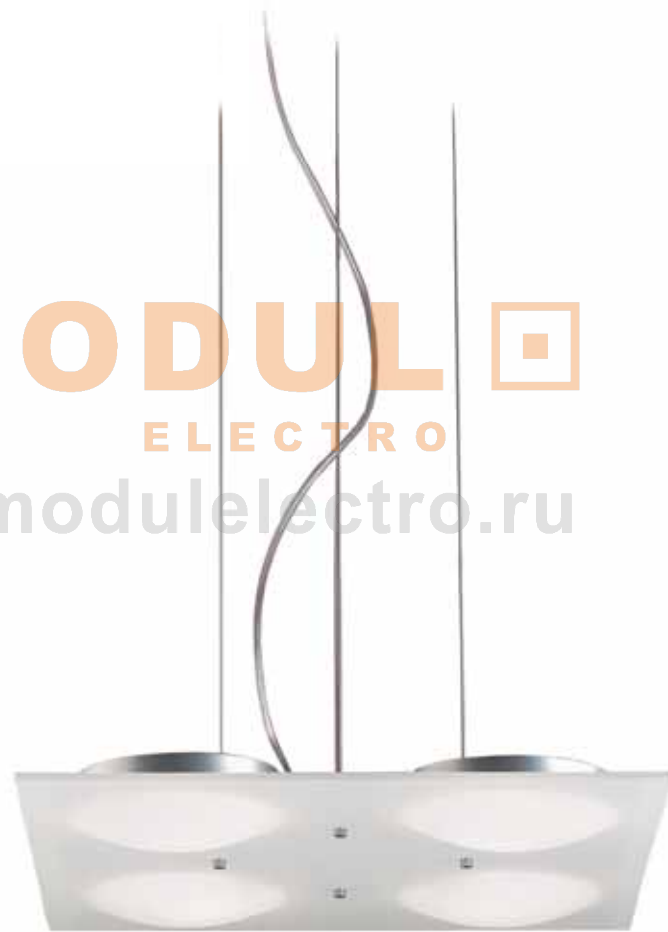



MODUL
ELECTRO
www.modulelectro.ru

linear

design _Benedito Design

Estructura de aluminio acabado pulido satinado. La basculación de la estructura permite elegir la cantidad de luz directa e indirecta deseada.

Metal body finished in satin aluminium. The body's tilt allows you to choose the quantity of direct and indirect light desired.

Structure en aluminium avec finitions polies satinées. L'inclinaison de la structure permet de choisir la quantité désirée de lumière directe et indirecte.

Gehäuse aus Aluminium, glatte satinierte Oberfläche. Das Gehäuse ist kippbar, so dass der gewünschte Grad der direkten und indirekten Beleuchtung reguliert werden kann.

Struttura in alluminio, finitura lucida satinata. La struttura basculante consente di scegliere la quantità di luce diretta e indiretta desiderata.



MODUL
ELECTRO
www.modulelectro.ru



AL

● Aluminio satinado
Satin aluminium
Y6 Aluminium satiné
Aluminium matt
Alluminio satinato

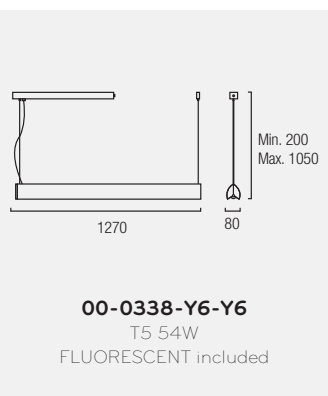

00-0338-Y6-Y6
T5 54W
FLUORESCENT included



MODULO
ELECTRO
www.modulelectro.ru

twins

design _Benedito Design

Estructura metálica en acabado gris textura. El difusor combina el cristal transparente y el cristal opal triplex. Luz directa.

Metal body in grey textured finish. The diffuser combines transparent glass and triplex opal glass. Direct light.

Structure métallique avec finitions de texture grise. Le diffuseur allie le verre transparent et le verre opale triplex. Lumière directe.

Metallgehäuse mit Oberfläche in grauer Textur. Der Diffusor kombiniert transparentes Glas und Triplex-Opalglas. Direkte Beleuchtung.

Struttura metallica con finitura grigia texture. Il diffusore abbina il cristallo trasparente al cristallo opale triplex. Luce diretta.



MODULO
ELECTRO
www.modulelectro.ru

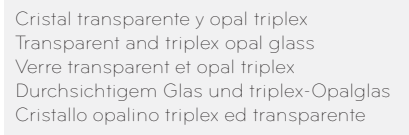
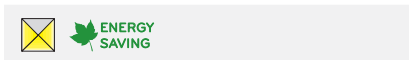
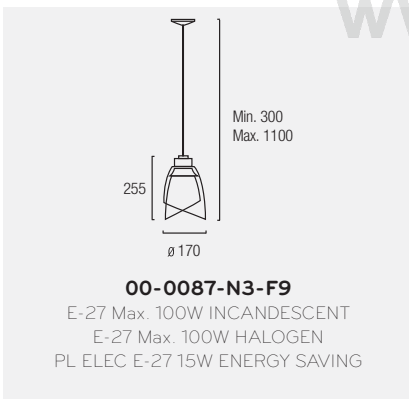



swing

design _ Josep Patsí

Estructura metalizada en acabado gris textura con detalles en cromo. Difusor de cristal óptico. Posibilidad de instalar en techos inclinados. Luz directa e indirecta.

Metal body in grey textured finish with chrome details. Optical glass diffuser. Can be installed on sloping ceilings. Direct and indirect light.

Structure métallisée avec finitions à texture grise avec des détails chromés. Diffuseur en verre optique. Installation sur toits inclinés possible. Lumière directe et indirecte.

Metallgehäuse mit Oberfläche in grauer Textur mit verchromten Details. Diffusor aus mattem Optikglas. Zur Befestigung an Dachschrägen geeignet. Zur direkten und indirekten Beleuchtung.

Struttura metallizzata con finitura grigia texture, con finiture cromate. Diffusore in cristallo ottico. Possibilità di installazione su soffitti inclinati. Luce diretta e indiretta.

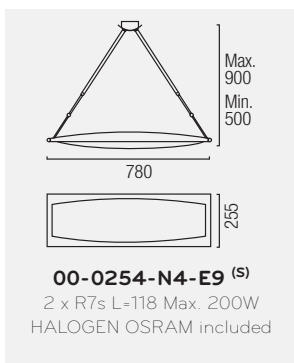

MODULO ELECTRO
www.moduloelectro.ru



	Gris textura con cromo Grey texture with chrome N4 Gris à effet de texture avec chrome Grau rauh-matt mit Chrom Grigio rugoso con cromo	
	Cristal óptico Optic glass E9 Verre optique Optishes Glas Vetro ottico	



otras referencias / other references

LOMA es una colección del catálogo ARCHITECTURAL de LEDS-C4

LOMA is an ARCHITECTURAL catalogue series (LEDS-C4)



MODULO
ELECTRO

www.modulelectro.ru

LOMA



Sistema de fluorescencia lineal preparada para conexión de dispositivos.
Fluorescent lineal lighting system suitable for optional devices.

Loma es algo más que una luminaria. Su arquitectura modular y su diseño permiten la incorporación de una variada gama de dispositivos. Equipada con lámparas T5 (39W-54W-80W) que proporcionan luz directa e indirecta para lograr un mayor confort lumínico.

LOMA is more than a luminaire. Its modular architecture and its design give the possibility to incorporate a wide variety of devices. The modules are equipped with fluorescent tubes T5 (39-54-80W) that provide excellent luminous comfort through direct/indirect light emission.

SP-1801-N3-B9 TL5 G5 3x39W (1022 x 214 x max.2200 cm)
SP-1802-N3-B9 TL5 G5 3x54W (1322 x 214 x max.2200 cm)
SP-1803-N3-B9 TL5 G5 3x80W (1622 x 214 x max.2200 cm)
SP-1805-N3-B9 TL5 G5 3x39W (1010 x 214 x max.2200 cm)
SP-1806-N3-B9 TL5 G5 3x54W (1310 x 214 x max.2200 cm)
SP-1807-N3-B9 TL5 G5 3x80W (1610 x 214 x max.2200 cm)



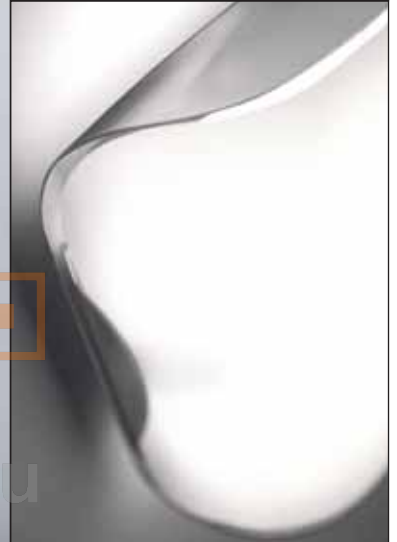

MODULO
ELECTRO
www.modulelectro.ru



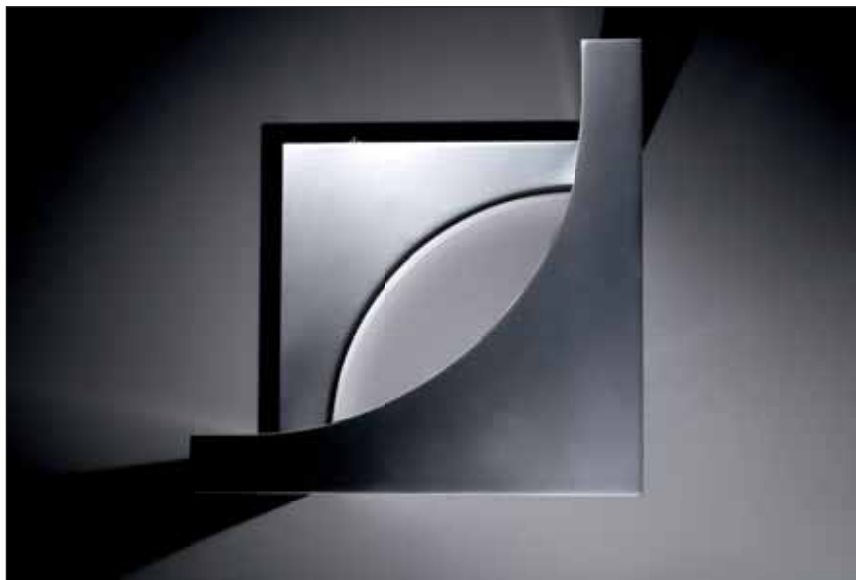

_apliques

_wall fixtures

_appliques

_wandleuchten

_lampade da parete

 **MODUL** 
ELECTRO

www.modulelectro.ru

traç_56

troppo_60

escher_62

arc_66

adagio_68

oxygen_70

level_71

slimm_72

flat_74

tempo_76

boomerang_78

ciao_80

duna_82

class_84

mirror_86

open_90

suite_92

leila_96

hotels_98

versatil_100

dolce_102

ola_103

scala_104

Estructura de aluminio Ecobright y reflector metálico disponible en 2 acabados, blanco y pan de plata. Luz principalmente indirecta y en parte directa gracias al difusor de cristal anti-deslumbrante.

Ecobright aluminium body and metal reflector available in 2 finishes: white and silver leaf. Mainly indirect light and some direct light thanks to an anti-glare glass diffuser.

Structure en aluminium Ecobright et réflecteur métallique proposés avec deux finitions (en blanc et en argenté). Lumière principalement indirecte, partiellement directe à travers son diffuseur en verre antireflets.

Gehäuse aus Ecobright-Aluminium und Metallreflektor, lieferbar in 2 Ausführungen: Weiß und Silberfolie. Direkte Beleuchtung und auch indirekte Beleuchtung durch Diffusor aus entspiegeltem Glas.

Struttura in alluminio Ecobright e riflettore metallico disponibile in due finiture, bianco e foglia d'argento. Luce principalmente indiretta e parzialmente diretta, grazie al diffusore in cristallo anti-abbagliamento.



<p> Blanco</p> <p>AH White</p> <p>Blanc</p> <p>Weiss</p> <p>Bianco</p>	<p> Pan de plata</p> <p>Silver leaf</p> <p>D9 Feuille d'argent</p> <p>Blattsilber</p> <p>Foglia argento</p>		
<p> Cristal anti-deslumbrante</p> <p>Anti-glare glass</p> <p>F1 Verre antiéblouissant</p> <p>Blendfreies Glas</p> <p>Vetro antiriflesso</p>			

05-2870-AH-F1
05-2870-D9-F1
G9 Max. 75W
HALOGEN OSRAM included



MODUL
ELECTRO
www.modullectro.ru





www.modulelectro.ru





MODULO
ELECTRO
www.modulelectro.ru

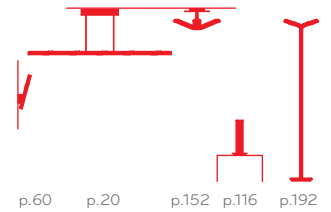

Estructura de aluminio acabado en cromo. Cristales de borosilicato matizado. Elegante combinación de formas simples: línea y círculo. Emite luz directa y también indirecta gracias a las aperturas de la parte posterior de la estructura.

Aluminium body finished in chrome. Matte borosilicate glass. Elegant combination of simple shapes - lines and circles. Provides direct and indirect light thanks to openings on the back of the luminaire.

Structure en aluminium avec finitions chromées. Verre borosilicate teinté. Combinaison élégante de formes simples telles que des lignes et des cercles. Émet une lumière directe mais aussi indirecte grâce aux ouvertures de la partie postérieure de la structure.

Wandleuchte Gehäuse aus verchromtem Aluminium. Mattes Borsilikatglas. Elegante Kombination einfacher Formen: Linie und Kreis. Direkte Beleuchtung sowie indirekte Beleuchtung durch die Öffnungen an der Rückseite der Leuchte.

Struttura in alluminio con finitura cromata. Cristalli di borosilicato opacizzato. Elegante accostamento di forme semplici: linee e cerchi. Emette luce diretta e indiretta, anche grazie alle aperture nella parte posteriore della struttura.

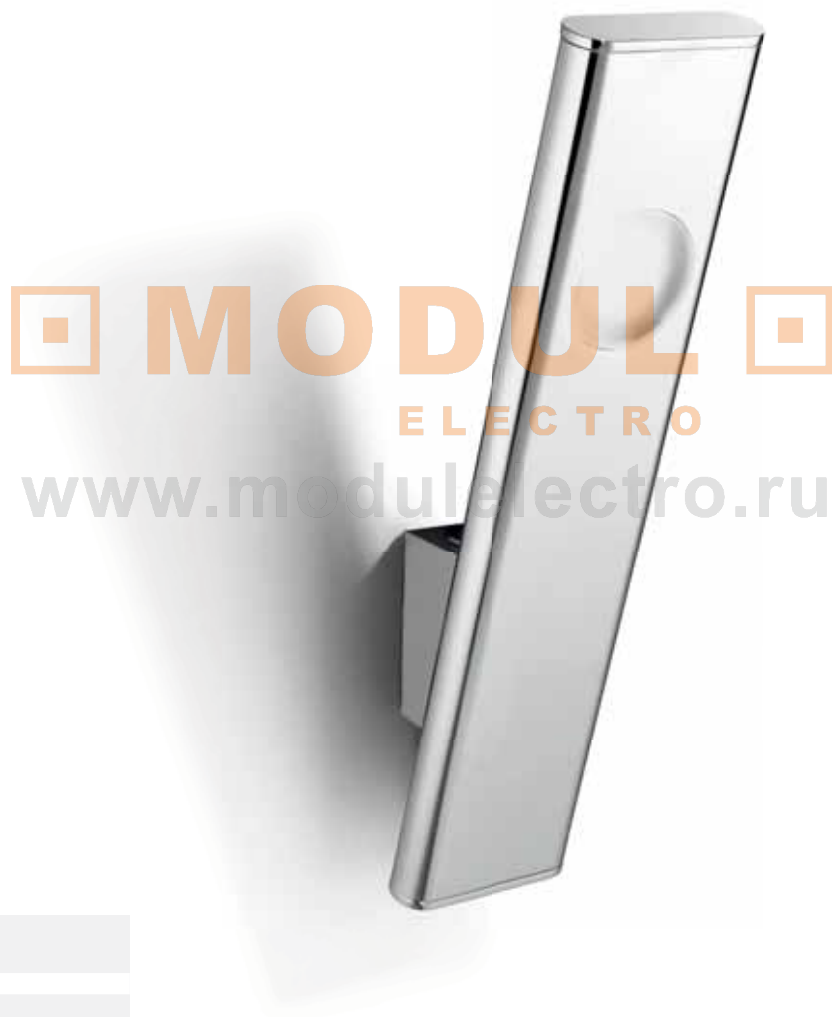

● Cromo
● Chrome
21 Chrome
● Chrom
● Cromo

○ Cristal anti-deslumbrante
○ Anti-glare glass
F1 Verre antiéblouissante
○ Blendfreies Glas
○ Vetro antiriflesso

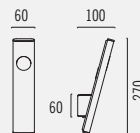

05-2804-21-F1

G9 75W

HALOGEN OSRAM included



 **MODUL** 
ELECTRO
www.modulelectro.ru



escher

design _ Josep Patsí

escher_collection

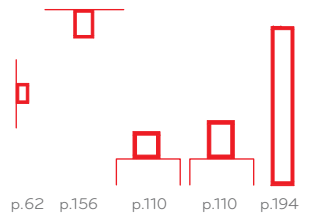

Estructura metálica en 3 acabados disponibles: aluminio Ecobright, lacado blanco y lacado negro. Luz indirecta.

Metal body available in 3 finishes: Ecobright, black lacquer or white lacquer. Indirect light.

Structure métallique proposée avec trois finitions : aluminium Ecobright, verni blanc et verni noir. Lumière indirecte.

Metallgehäuse in 3 Ausführungen lieferbar: Ecobright-Aluminium, weiß lackiert und schwarz lackiert. Indirekte Beleuchtung.

Struttura metallica disponibile con 3 finiture: alluminio Ecobright, laccato bianco e laccato nero. Luce indiretta.

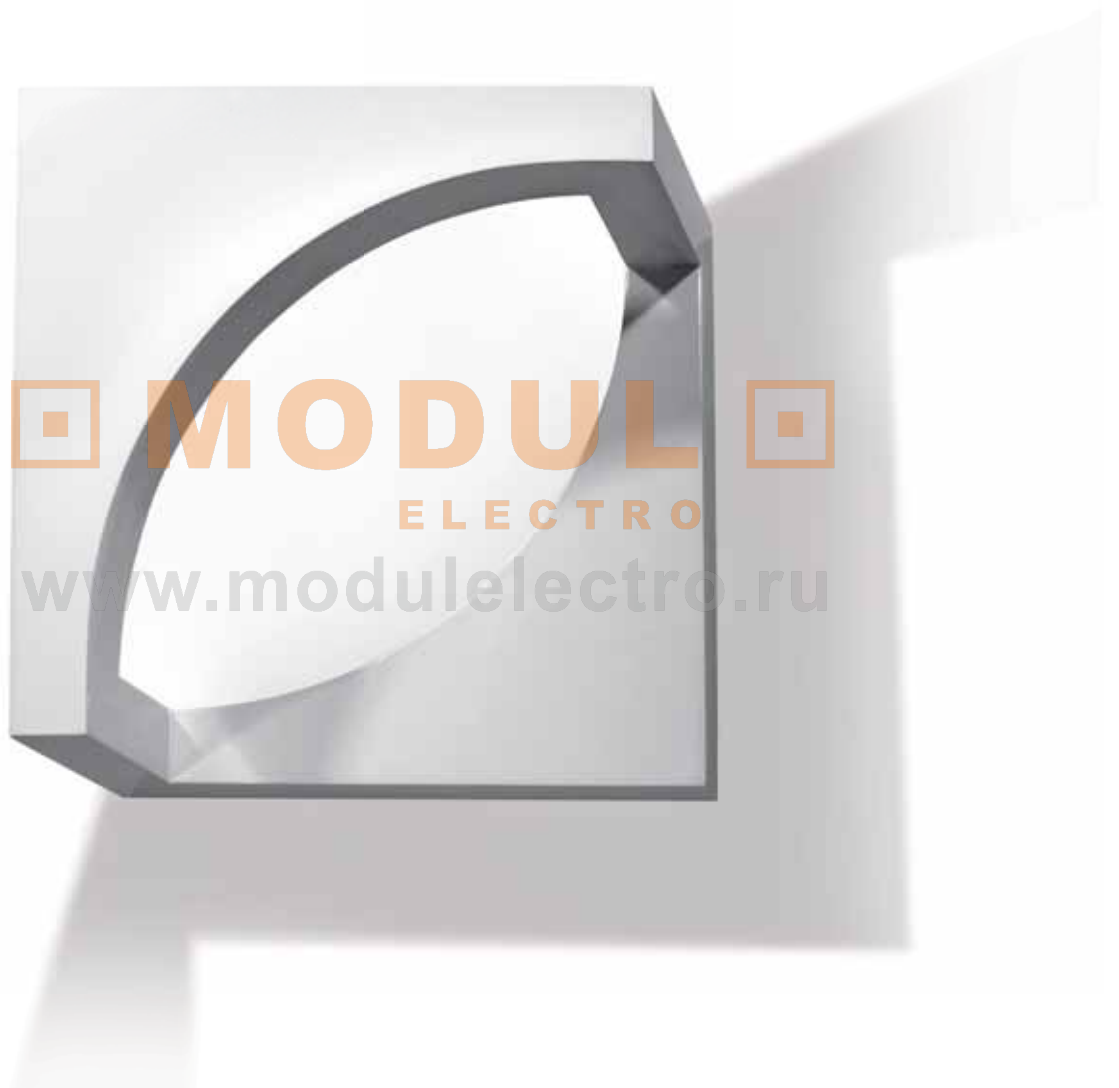

MODUL
ELECTRO
www.modulelectro.ru



FE

● Aluminium Ecobright
Ecobright aluminium
AH Aluminium Ecobright
Ecobright aluminium
Alluminio Ecobright

● Lacado negro
Black lacquered
05 Laqué en noir
Schwarz lackiert
Laccato nero

○ Lacado blanco
White lacquered
78 Laqué en blanc
Weiss lackiert
Laccato bianco

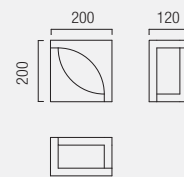

05-2782-AH-AH
05-2782-05-05
05-2782-78-78



2 x G9 75W
HALOGEN OSRAM included

A close-up, low-angle photograph of a dark, metallic mechanical component, possibly a valve or a part of a machine. The lighting is dramatic, highlighting the curves and edges of the metal against a dark background. A logo and website address are overlaid in the center of the image.

MODUL
ELECTRO
www.modulelectro.ru

escher



 **MODUL** 
ELECTRO
www.modulelectro.ru



MODUL
ELECTRO
www.modulelectro.ru

arc

design _ Estudi Ribaudí

arc_collection

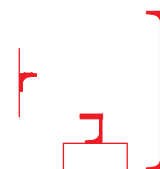

p.66 p.114 p.206

Estructura de aluminio y difusor de metacrilato. Disponible en 3 acabados: aluminio Ecobright, lacado blanco y lacado negro. Luz indirecta.

Aluminium body and methacrylate diffuser. Available in 3 finishes: Ecobright aluminium, black lacquer or white lacquer. Indirect light.

Applique Structure en aluminium et diffuseur en méthacrylate. Proposée avec trois finitions: aluminium Ecobright, verni blanc et verni noir. Lumière indirecte.

Gehäuse aus Aluminium und Diffusor aus Plexiglas. In 3 Ausführungen lieferbar: Ecobright-Aluminium, weiß lackiert und schwarz lackiert. Indirekte Beleuchtung.

Struttura in alluminio e diffusore in metacrilato. Disponibile in 3 finiture: alluminio Ecobright, laccato bianco e laccato nero. Luce indiretta.



AH Aluminium Ecobright
Ecobright aluminium
Aluminium Ecobright
Ecobright aluminium
Alluminio Ecobright

05 Lacado negro
Black lacquered
Laqué en noir
Schwarz lackiert
Laccato nero

78 Lacado blanco
White lacquered
Laqué en blanc
Weiss lackiert
Laccato bianco

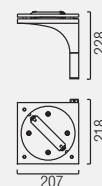

05-2580-AH-AH
05-2580-05-05
05-2580-78-78

R7s L=118 Max 150W
HALOGEN OSRAM included

 **MODUL** 
ELECTRO

www.modulselectro.ru



adagio

design _ Josep Patsí

adagio_collection

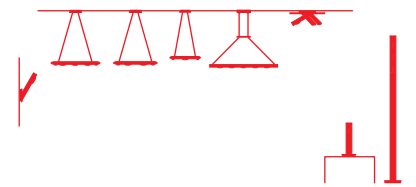

p.68 p.38 p.39 p.38 p.36 p.166 p.118 p.209

Estructura de aluminio y difusores de cristal anti-deslumbrante. Disponible en acabados cromo y aluminio pulido satinado. Emite luz directa y también indirecta gracias a las aperturas de la parte posterior de la estructura.

Aluminium body and anti-glare glass diffusers. Available in chrome or polished and satin aluminium. Provides direct and indirect light thanks to openings on the back of the luminaire.

Structure en aluminium et diffuseurs en verre anti-reflets. Proposée avec des finitions chromées et en aluminium poli satiné. Émet une lumière directe mais aussi indirecte grâce aux ouvertures de la partie postérieure de la structure.

Gehäuse aus Aluminium und Diffusore aus entspiegeltem Glas. Verchromt und in poliertem satinier-tem Aluminium lieferbar. Direkte Beleuchtung sowie indirekte Beleuchtung durch die Öffnungen an der Rückseite der Leuchte.

Struttura in alluminio e diffusori in cristallo anti-abbagliamento. Disponibile con finitura in cromo e alluminio lucido satinato. Emette luce diretta e indiretta, anche grazie alle aperture nella parte posteriore della struttura.

MODUL
ELECTRO
www.modulelectro.ru

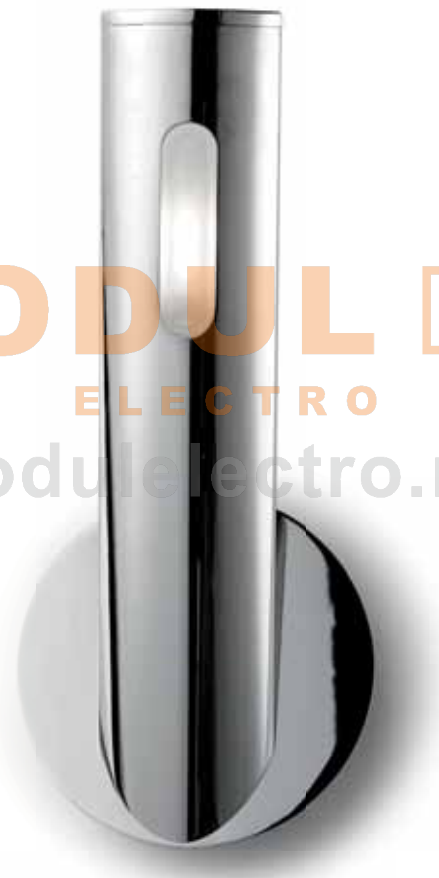

● Cromo
● Chrome
● Chrom
● Cromo
21

● Aluminio pulido y satinado
● Polished and burnished aluminium
● Aluminium poli et satiné
● Aluminium poliert und mattglänzend
● Alluminio lucidato e satinato
S3

○ Cristal anti-deslumbrante
○ Anti-glare glass
F1 Verre antiéblouissante
Blendfreies Glas
Vetro antiriflesso

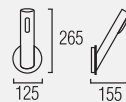

05-0221-21-F1

05-0221-S3-F1

G9 Max. 75W 230V

HALOGEN OSRAM included



MODUL
ELECTRO
www.modulelectro.ru

oxygen

design _ Josep Patsí

oxygen_collection



p.70

p.44

Estructura de aluminio semi-circular, acabado Ecobright. Difusores de cristal anti-deslumbrante. Luz indirecta.

Circular Ecobright aluminium body. Anti-glare glass diffusers. Indirect light.

Structure semi-circulaire en aluminium avec finitions Ecobright. Diffuseurs en verre antireflets. Lumière indirecte.

Halbrundes Gehäuse aus Aluminium, Oberfläche Ecobright. Diffusoren aus entspiegeltem Glas. Direktes und indirektes Licht.

Struttura in alluminio semicircolare, con finitura Ecobright. Diffusori in cristallo anti-abbagliamento. Luce diretta e indiretta.



MODUL
ELECTRO

www.modulelectro.ru

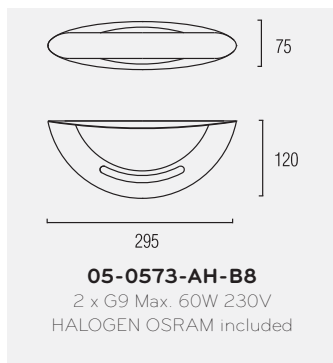

	Aluminio Ecobright Ecobright aluminium Aluminium Ecobright Ecobright aluminium Alluminio Ecobright		
	Cristal anti-deslumbrante Anti-glare glass Verre antiéblouissante Blendfreies Glas Vetro antiriflesso		

Estructura metálica que combina los acabados cromo y gris textura. Cristal óptico matizado. Luz indirecta.

Metal body that combines in chrome and grey textured finishes. Matte optical glass. Indirect light.

Structure métallique qui associe des finitions chromées et une texture grise. Verre optique teinté. Lumière indirecte.

Metallgehäuse mit Oberfläche aus Chrom und grauer Textur. Mattiertes Optikglas. Indirekte Beleuchtung.

Struttura metallica che abbina finiture cromate e grigio texture. Cristallo ottico opacizzato. Luce indiretta.



MODULO
ELECTRO
www.modulelectro.ru

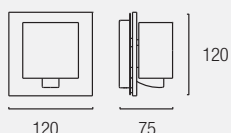

05-0567-N4-B9

G9 Max. 75W 230V
HALOGEN OSRAM included



● Gris textura con cromo
Grey texture with chrome
N4 Gris à effet de texture avec chrome
Grau rauh-matt mit Chrom
Grigio rugoso con cromo

○ Cristal óptico
Optic glass
B9 Verre optique
Optisches Glas
Vetro ottico



slimm

design _ Estudi Ribaudí

slimm_collection



Estructura metálica disponible en acabados cromo y aluminio mate. Difusor de cristal óptico en la parte inferior. Incluye embellecedores de metacrilato en 3 colores intercambiables. Luz emitida hacia arriba y hacia abajo.

Metal body available in chrome or matte aluminium. Optical glass diffuser in lower part. Includes methacrylate trims in 3 interchangeable colours. Lighting diffused up and down.

Structure métallique proposée avec finitions chromées et en aluminium mat. Diffuseur en verre optique pour la partie inférieure. Inclut des caches en méthacrylate en trois couleurs interchangeables. Lumière émise vers le haut et vers le bas.

Metallgehäuse lieferbar in Chrom und mattem Aluminium. Diffusor aus Optikglas an Unterseite. Mitgeliefert werden austauschbare Plexiglasauflsätze in 3 Farben. Lichtstrahl nach oben und nach unten.

Struttura metallica disponibile con finitura cromata e alluminio opaco. Diffusore in cristallo ottico nella parte inferiore. Comprende elementi decorativi in metacrilato, in 3 colori intercambiabili. Flusso di luce emesso verso l'alto e verso il basso.

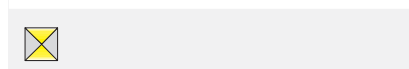
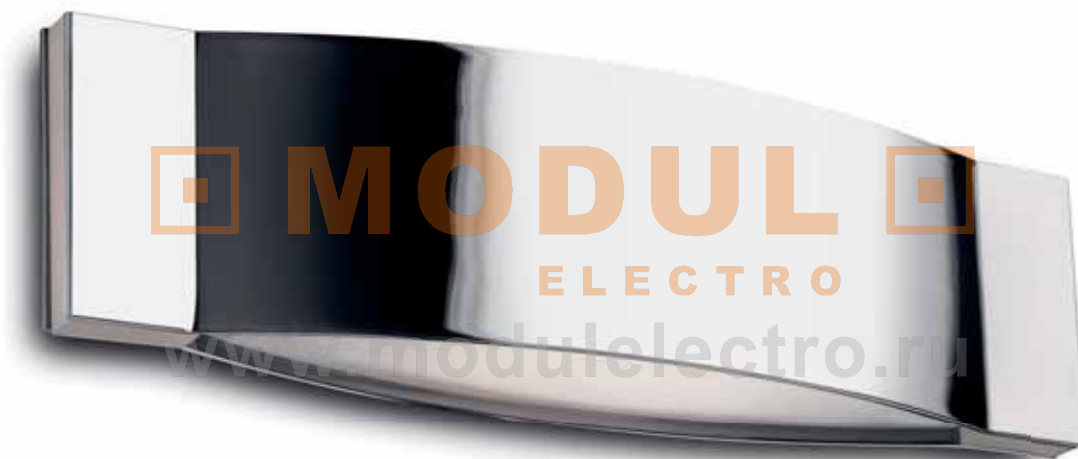

- Cromo
Chrome
21 Chrom
Cromo
- Aluminio mate
Matt aluminium
Y5 Aluminium mat
Alluminio opaco

- Cristal óptico
Optic glass
E9 Verre optique
Optisches Glas
Vetro ottico

05-2397-Y5-E9
05-2397-21-E9
R7s L=118 Max. 150W
HALOGEN OSRAM included

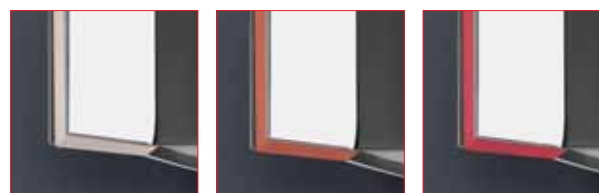

Incluye 3 acrílicos de color intercambiables
Includes 3 color interchangeable acrylic pieces

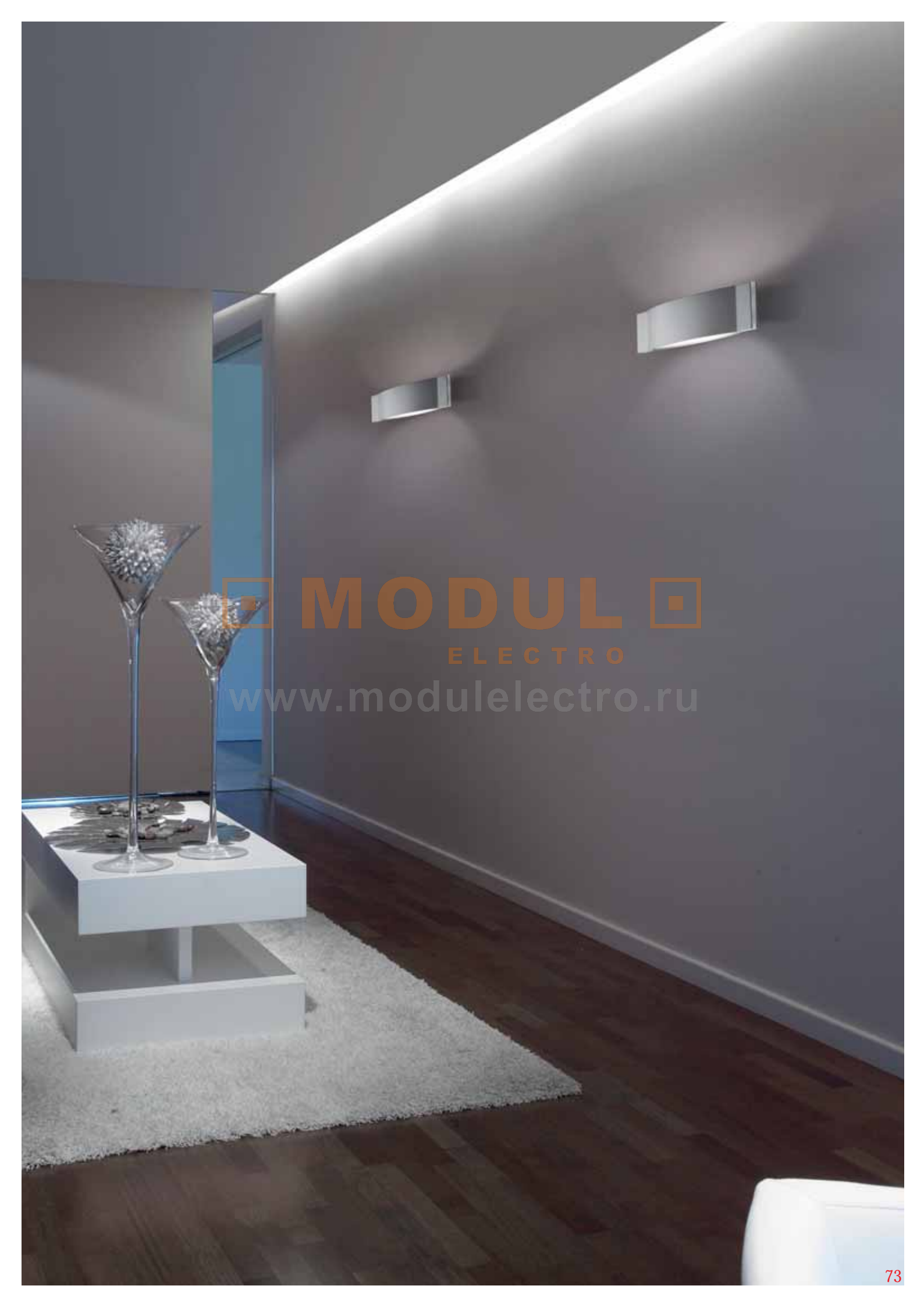

MODUL
ELECTRO
www.modulelectro.ru



Estructura metálica en acabado níquel satinado. Difusor de cristal óptico matizado. Disponible en 3 tamaños distintos: 18 cm de ancho sólo para halógeno y 25 y 40 cm de ancho para halógeno o fluorescente. Luz directa e indirecta.

Satin nickel metal body. Matte optical glass diffuser. Available in 3 different sizes: 18 cm for halogen lamps only and 25 and 40 cm for halogen and fluorescent lamps. Direct and indirect light.

Structure métallique avec finitions en nickel satiné. Diffuseur en verre optique teinté. Proposée en trois tailles: largeur de 18 cm de large (seulement pour l'halogène) et largeur de 25 et 40 cm pour la version fluoescence. Lumière directe et indirecte.

Metallgehäuse in satinier-tem Nickel. Diffusor aus mattem Optikglas. In 3 Größen lieferbar: 18 cm breit nur für Halogenlam- pen und 25 und 40 cm breit Für Halogen- und fluoesczierende Lampen. Zur direkten und indirekten Beleuchtung.

Struttura metallica con finitura nichel satinato. Diffusore in cristallo ottico opacizzato. Disponibile in 3 diverse misure: 18 cm di larghezza, solo per alogene e 25 e 40 cm di larghez- za per alogene e lampade fluoescenti. Luce diretta e indiretta.

05-0570-81-B9
R7s L=78 Max. 100W
HALOGEN OSRAM included

05-0571-81-B9
R7s L=118 Max. 150W
HALOGEN OSRAM included

05-2366-81-B9
G24d-2 18W
ENERGY SAVING

05-0572-81-B9
2 x R7s L=118 Max. 150W
HALOGEN OSRAM included

05-2367-81-B9
2 x G24d-2 18W
ENERGY SAVING

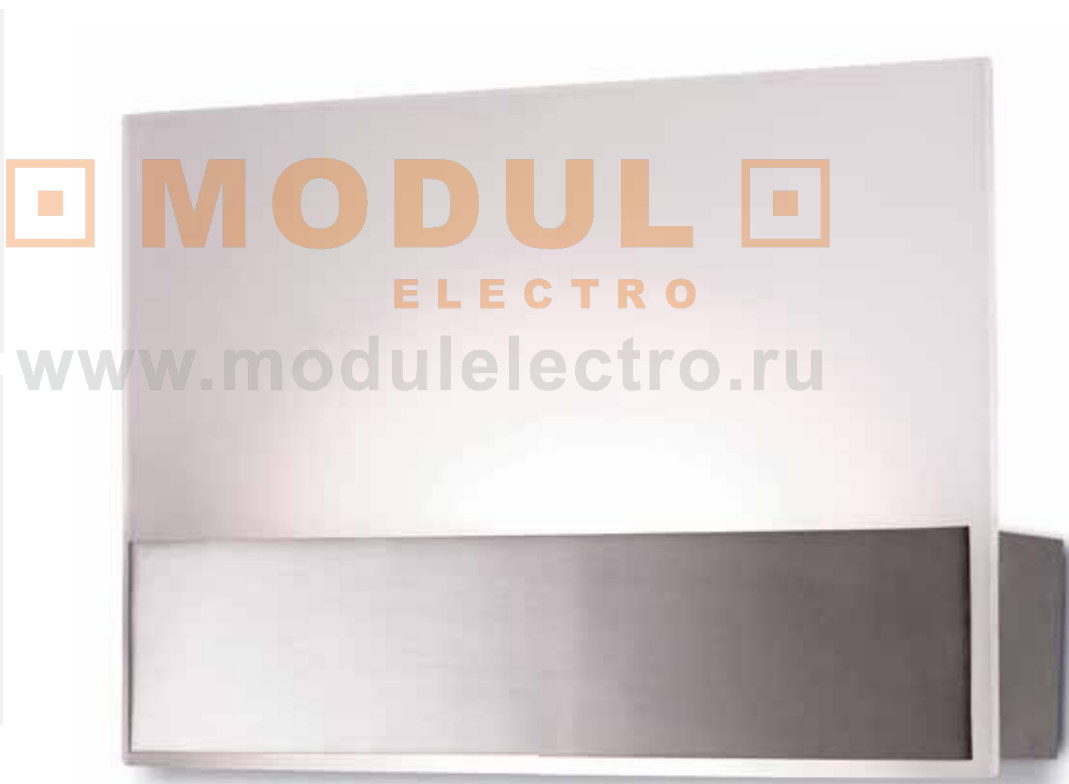

⊕ F RF 850°C ®

⊗ ENERGY SAVING

FE GLASS OPT ZAMAK

● Níquel Satinado
Satin nickel
81 Nickel satiné
Nickel matt
Nichel satinato

○ Cristal óptico
Optic glass
B9 Verre optique
Optishes Glas
Vetro ottico





MODUL
ELECTRO
www.modulelectro.ru

tempo

design _ Josep Patsí

tempo_collection

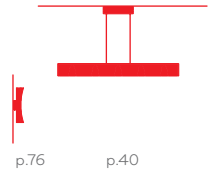

Estructura de aluminio disponible en 3 acabados: Ecobright, lacado negro y lacado blanco. Luz directa e indirecta gracias al difusor de cristal óptico matizado.

Aluminium body available in 3 finishes: Ecobright, black lacquer or white lacquer. Direct and indirect light thanks to matte optical glass diffuser.

Structure en aluminium proposée avec trois finitions : Ecobright, verni noir et verni blanc. Lumière directe et indirecte grâce au diffuseur en verre optique teinté.

Gehäuse aus Aluminium, lieferbar in 3 Ausführungen: Ecobright, schwarz lackiert und weiß lackiert. Zur direkten und indirekten Beleuchtung durch Diffusor aus mattiertem Optikglas.

Struttura in alluminio, disponibile in 3 finiture: Ecobright, laccato nero e laccato bianco. Luce diretta e indiretta, grazie al diffusore in cristallo ottico opacizzato.

MODUL ELECTRO

www.modulelectro.ru



AH Aluminio Ecobright
Ecobright aluminium
Aluminium Ecobright
Ecobright aluminium
Alluminio Ecobright

05 Lacado negro
Black lacquered
Laqué en noir
Schwarz lackiert
Laccato nero

78 Lacado blanco
White lacquered
Laqué en blanc
Weiss lackiert
Laccato bianco

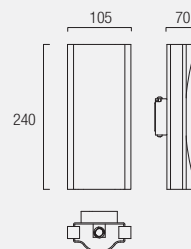

05-2673-AH-AH (S)
05-2673-05-05 (S)
05-2673-78-78 (S)

2 x G9 75W
HALOGEN OSRAM included



MODUL
ELECTRO
www.modulelectro.ru

boomerang

design _ Josep Patsí

boomerang_collection



Estructura metálica en acabado níquel satinado. Difusor de cristal óptico matizado. Disponible en versión halógena (20cm ancho) y en versión fluorescente (25cm ancho). Luz directa.

Satin nickel metal body. Matte optical glass diffuser. Available in halogen version (20 cm) and fluorescent version (25 cm). Direct light.

Structure métallique avec finitions en nickel satiné. Diffuseur en verre optique teinté. Proposée en halogène (20 cm de largeur) et en version fluorescente (25 cm de largeur). Lumière directe.

Metallgehäuse in satinier-tem Nickel. Diffusor aus mattem Optikglas. Lieferbar für Halogenlampen (20cm breit) und für fluoreszierende Lampen (25 cm breit). Direkte Beleuchtung.

Struttura metallica con finitura níchel satinato. Diffusore in cristallo ottico opacizzato. Disponibile in versione alogena (larghezza 20 cm) e fluorescente (larghezza 25 cm). Luce diretta.



⚡ ⚠️ RF 850°C ®

⚡ ENERGY SAVING

FE GLASS OPT

● Níquel Satinado
Satin nickel
81 Nickel satiné
Nickel matt
Níchel satinato

○ Cristal óptico
Optic glass
B4 Verre optique
Optisches Glas
Vetro ottico

250 100 210

05-2573-81-B4
G24d2 18W
ENERGY SAVING

200 100 210

05-2572-81-B4
R7s L=118 Max. 150W
HALOGEN OSRAM included

MODULO ELECTRO

www.modulelectro.ru





MODUL
ELECTRO
www.modulelectro.ru

ciao

design _ Josep Patsí

Estructura metálica en acabado cromo. Difusor de cristal óptico matizado. Luz directa.

Chrome metal body. Matte optical glass diffuser. Direct light.

Structure métallique avec finitions chromées. Diffuseur en verre optique teinté. Lumière directe.

Gehäuse aus verchromtem Metall. Diffusor aus mattem Optikglas. Direkte Beleuchtung.

applique Struttura metallica con finitura cromata. Diffusore in cristallo ottico opacizzato. Luce diretta.



MODUL

ELECTRO

www.modulelectro.ru

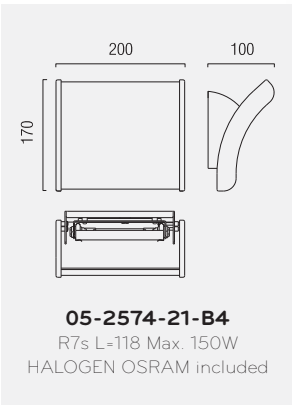

● Cromo
● Chrome
21 Chrome
● Chrom
● Cromo

○ Cristal óptico
○ Optic glass
B4 Verre optique
○ Optishes Glas
○ Vetro ottico

www.modulelectro.ru

duna

design _ Álex Sánchez

duna_collection

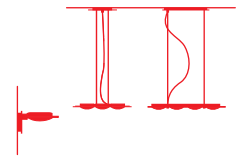

p.82 p.46 p.46

Estructura de aluminio satinado. Difusor de cristal óptico. Luz emitida hacia arriba y hacia abajo.

Satin aluminium body. Optical glass diffuser. Lighting diffused up and down.

Structure en aluminium satiné. Diffuseur en verre optique. Lumière émise vers le haut et vers le bas.

Gehäuse aus satiniertem Aluminium. Diffusor aus mattedem Optikglas. Lichtstrahl nach oben und nach unten.

Struttura in alluminio satinato. Diffusore in cristallo ottico. Flusso di luce emesso verso l'alto e verso il basso.



● Níquel Satinado
Satin nickel
81 Nickel satiné
Nickel matt
Nichel satinato

○ Cristal óptico
Optic glass
E9 Verre optique
Optishes Glas
Vetro ottico

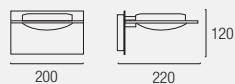

05-0325-81-E9
G9 Max. 75W 230V
HALOGEN OSRAM included



MODUL
ELECTRO
www.modulelectro.ru

class

design _ Josep Patsi

class_collection

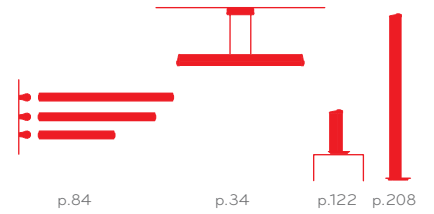

Estructura de aluminio Ecobright. Doble difusor: interior de policarbonato opal y exterior de borosilicato transparente. Luz directa. Disponible en 3 tamaños. Luz directa. Apto para baño (IP44).

Double diffuser - inner: opal polycarbonate, exterior: transparent borosilicate Direct light. Available in 3 sizes. Direct light. Suitable for bathrooms (IP44).

Double diffuseur: intérieur en polycarbonate opale et extérieur en borosilicate transparent. Lumière directe. Proposée en trois largeurs. Lumière directe. Convient à un usage en salle de bain (IP44).

Diffusor: Innen aus Opal-Polykarbonat und außen aus transparentem Borosilikat. Direkte Beleuchtung. In 3 Größen lieferbar. Geeignet für Badezimmer (IP44).

Doppio diffusore: interno in policarbonato opale ed esterno in borosilicato trasparente. Luce diretta. Disponibile in 3 misure. Luce diretta. Adatto per il bagno (IP44).



Doble difusor
Double diffuser
Diffuseur double
Doppelglas
Difusore doppio

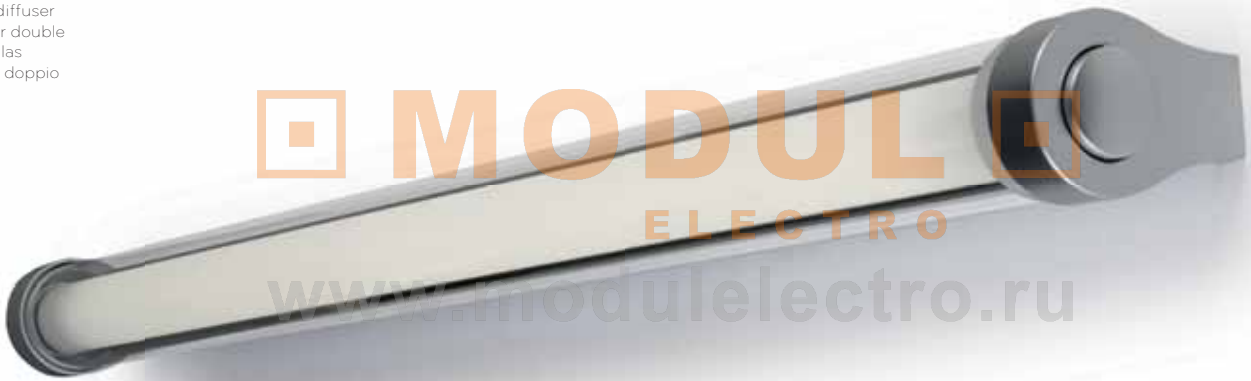

MODUL
ELECTRO
www.modulelectro.ru

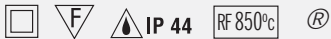

○ Aluminio Ecobright
Ecobright aluminium
AH Aluminium Ecobright
Ecobright aluminium
Alluminio Ecobright

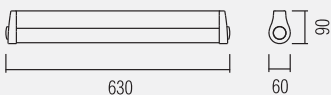

05-2694-AH-37 (S)

T5 24W FLUORESCENT included

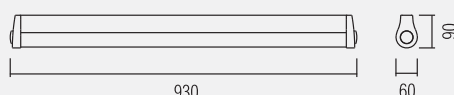

05-2695-AH-37 (S)

T5 39W FLUORESCENT included

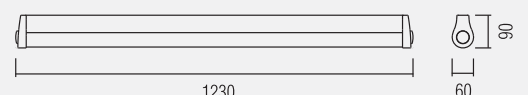

05-2696-AH-37 (S)

T5 54W FLUORESCENT included



MODUL
ELECTRO

www.modulelectro.ru



mirror

design _ Josep Patsí

mirror_collection



Estructura de aluminio satinado. Difusor de policarbonato opal. Disponible en 3 tamaños: 60cm, 90cm y 120cm de ancho. Luz directa. Apto para baño (IP44).

Satin aluminium body. Opal polycarbonate diffuser. Available in 3 sizes: 60cm, 90cm and 120cm. Direct light. Suitable for bathrooms (IP44).

Structure en aluminium satiné. Diffuseur en polycarbonate opale. Proposée en trois largeurs: 60 cm, 90 cm et 120 cm. Lumière directe. Convient à un usage en salle de bain (IP44).

Gehäuse aus satiniertem Aluminium. Diffusor aus Opal-Polykarbonat. In 3 Größen lieferbar: 60cm, 90cm und 120cm breit. Direkte Beleuchtung. Geeignet für Badezimmer (IP44).

Struttura in alluminio satinato. Diffusore in policarbonato opale. Disponibile in 3 misure: larghezza 60 cm, 90 cm e 120 cm. Luce diretta. Adatto per il bagno (IP44).



MODUL
ELECTRO
www.modulelectro.ru



Y6  Aluminio satinado
Satin aluminium
Aluminium satiné
Aluminium matt
Alluminio satinato

M1  Difusor policarbonato opal
Opal polycarbonate diffuser
Diffuseur polycarbonate opale
Polykarbonatdiffusor Opal
Diffusore in policarbonato opalino



05-0267-Y6-M1
T5 54W
FLUORESCENT
included

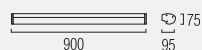

05-0266-Y6-M1
T5 39W
FLUORESCENT
included



05-0265-Y6-M1
T5 24W
FLUORESCENT
included



MODUL
ELECTRO
www.modulelectro.ru

mirror

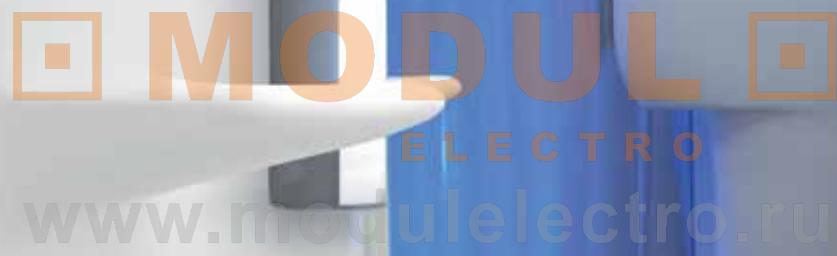
 MODUL ELECTRO
www.modulelectro.ru



MODUL
ELECTRO
www.modulelectro.ru

open

design _ Josep Patsí

open_collection

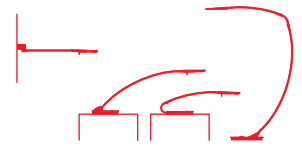

p.90 p.136 p.136 p.220

Estructura metálica en acabados aluminio Ecobright y cromo. Interruptor incluido. Difusor de policarbonato transparente. Cabezal orientable. Luz directa.

Metal body finished in Ecobright aluminium or chrome. Switch included. Transparent polycarbonate diffuser. Adjustable head. Direct light.

Structure métallique avec finitions en aluminium Ecobright et chromées. Interrupteur fourni. Diffuseur en polycarbonate transparent. Tête orientable. Lumière directe.

Metallgehäuse in den Ausführungen Ecobright-Aluminium und Chrom. Inkl. Schalter. Diffusor aus transparentem Polycarbonat. Verstellbares Kopfteil. Direkte Beleuchtung.

Struttura metallica con finitura cromata e alluminio Ecobright. Interruttore compreso. Diffusore in policarbonato trasparente. Testina orientabile. Luce diretta.

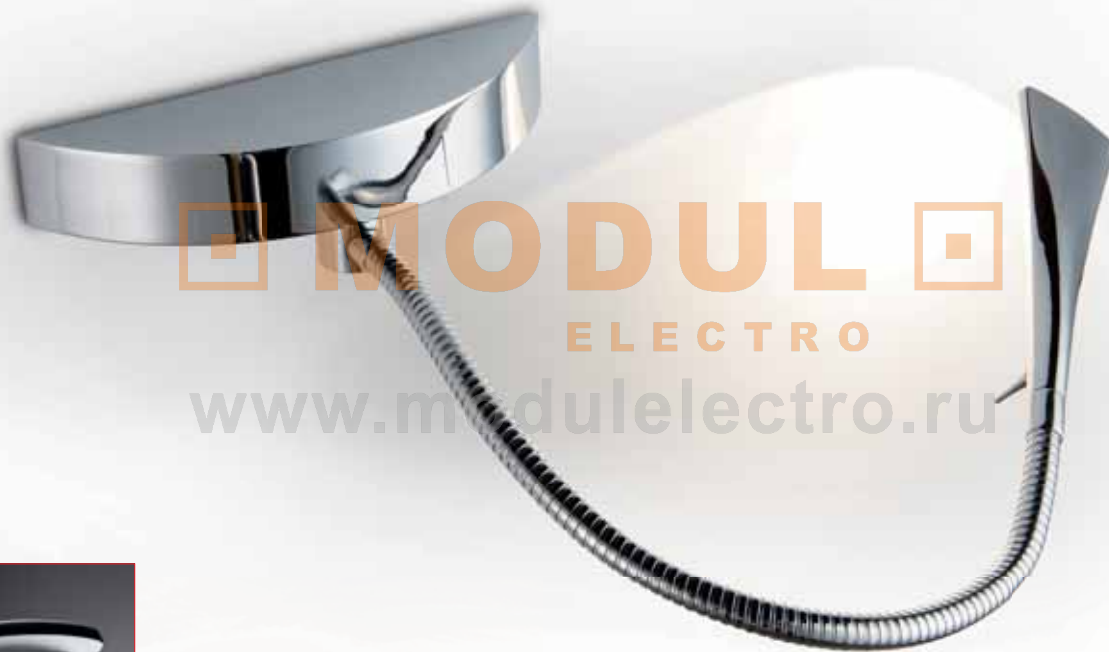

			ENERGY SAVING
	21		AH
Cromo	Chrome	Aluminio Ecobright	Ecobright aluminium
Chrome	Chrom	Aluminium Ecobright	Ecobright aluminium
Cromo		Alluminio Ecobright	

05-2708-21-21
05-2708-AH-AH
 LED 4,5W



MODULO
ELECTRO
www.modulelectro.ru

suite

design _ Benedito Design

suite_collection

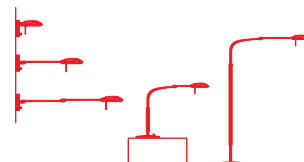

p.92

p.134

p.218

Estructura metálica en acabado níquel satinado. Interruptor-dimmer y luz directa. Difusor de cristal opal satinado. Sin brazo, con brazo articulado y con doble brazo articulado.

Satin nickel metal body. Dimmer switch and direct light. 3 models with satin opal crystal diffuser. No arm, articulated arm or double articulated arm.

Structure métallique avec finitions en nickel satiné. Interrupteur-variateur et lumière directe. Trois modèles dotés d'un diffuseur en verre opale satiné. Sans bras, avec bras articulé simple et avec bras double articulé.

Metallgehäuse in satiniertem Nickel. Dimmer-Schalter und direkte Beleuchtung. 3 Modelle mit Diffusor aus satiniertem Opalglas. Ohne Arm, mit Gelenkarm und mit Doppel-Gelenkarm.

Struttura metallica con finitura nichel satinato. Interruttore-dimmer e luce diretta. 3 modelli con diffusore in cristallo opale satinato. Senza braccio, con braccio articolato e con doppio braccio articolato.



DIMMER

MODULO

ELECTRO

www.modulelectro.ru

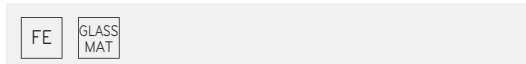
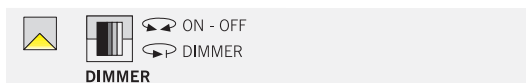

- 81** Níquel Satinado
Satin nickel
Nickel satiné
Nickel matt
Nichel satinato
- B8** Cristal opal satinado
Satin opal glass
Verre opal satin
Satiniertes opales Glas
Vetro opal satinado

05-0380-81-B8
G9 Max. 75W 230V
HALOGEN OSRAM included

05-0379-81-B8
G9 Max. 75W 230V
HALOGEN OSRAM included

05-0378-81-B8
G9 Max. 75W 230V
HALOGEN OSRAM included



MODUL
ELECTRO
www.modulelectro.ru

suite

design _ Benedito Design

suite_collection

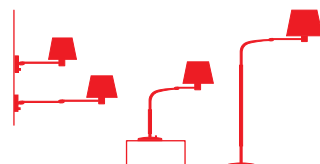

p.94

p.135

p.216

Estructura metálica en acabado níquel satinado con interruptor-dimmer y luz directa. Pantalla de tela gris Ópera.

Satin nickel metal body with dimmer switch and direct light. Grey fabric shade Opera.

Structure métallique avec finitions en nickel satiné. Interrupteur-variateur et lumière directe. Ecran en tissu gris Opéra.

Metallgehäuse in satiniertem Nickel. Dimmer-Schalter und direkter Beleuchtung. Schirm in grauem Opéra-Stoff lieferbar.

Struttura metallica con finitura nichel satinato. Interruttore-dimmer e luce diretta. Paralume in tela grigio Opera.



DIMMER



MODULO ELECTRO
www.modulelectro.ru



DIMMER



● Níquel Satinado
Satin nickel
81 Nickel satiné
Nickel matt
Nichel satinato

● Pantalla Gris Ópera incluida
Opera Grey shade included
AJ Abat-jour Gris Opéra compris
Grau Schirm inklusiv
Paralume grigio inclusa

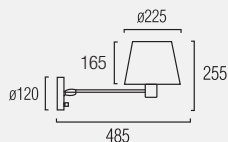

05-0381-81-AJ
E-27 Max. 60W
INCANDESCENT

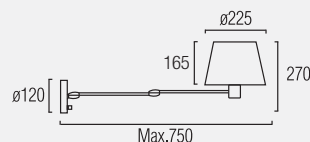

05-0382-81-AJ
E-27 Max. 60W
INCANDESCENT



MODUL
ELECTRO

www.modulelectro.ru

leila

design _ Bedito Design

leila_collection

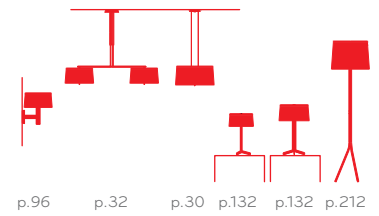

Estructura metálica en acabado cromo y aluminio satinado. Pantallas de tela disponibles en negro y en blanco. Luz directa.

Chrome or satin aluminium body. Fabric shades available in black and white. Direct light.

Structure métallique avec finitions chromées et en aluminium satiné. Écrans en tissu, proposés en noir et en blanc. Lumière directe.

Metallgehäuse, Oberfläche verchromt und aus satiniertem Aluminium. Stoffschirme in Schwarz und Weiß lieferbar. Direkte Beleuchtung.

Struttura metallica con finitura cromata e alluminio satinato. Paralumi in tela disponibili in colore nero e bianco. Luce diretta.



MODULO
ELECTRO
www.modulelectro.ru



● Aluminio con cromo
Aluminium with chrome
AG Aluminium avec chrome
Aluminium mit Chrom
Alluminio con cromo

● Pantalla negra de tela incluida
Black fabric shade included
05 Abat-jour noir en tissu compris
Schwarz Schirm inklusiv
Paralume di tela nero inclusa

● Pantalla blanca de tela incluida
White fabric shade included
14 Abat-jour blanche en tissu compris
Weiss Schirm inklusiv
Paralume di tela bianca inclusa

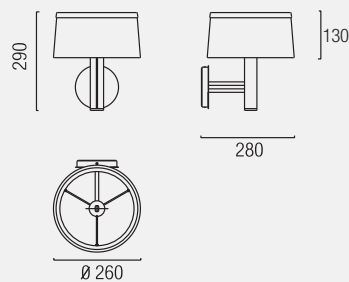

05-2407-AG-05

05-2407-AG-14

G9 Max. 40W

HALOGEN OSRAM included



MODUL
ELECTRO
www.modulelectro.ru

hotels

design _ Benedito Design

hotels_collection

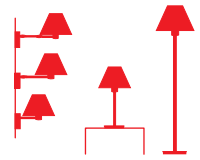

p.98 p.130 p.214

Estructura metálica en acabados níquel y oro satinado pintado. Sin brazo, con brazo articulado y con doble brazo articulado. Portalámparas E-27 y G24d1. Pantalla blanca y beige no incluidas.

Painted satin nickel or gold metallic body. No arm, articulated arm or double articulated arm. E-27 and G24d1 lampholders. White or beige shade not included.

Structure métallique avec finitions en nickel ou or peint satiné. Sans bras, avec bras articulé ou avec bras double articulé. Porte-lampe E-27 ou G24d1. Écran blanc ou beige non fournis.

Metallgehäuse in satiniertem lackiertem Nickel. Ohne Arm, mit Gelenkarm und mit Doppel-Gelenkarm. Je nach Lampenhalter (E-27 und G24d1) und je nach Schirm (weiß und beige). Schirme nicht im Lieferumfang enthalten.

Struttura metallica con finitura nichel e oro satinato dipinto. Senza braccio, con braccio articolato e con doppio braccio articolato. Portalampada E-27 e G24d1. Paralume bianco e beige non forniti.



Sistema patentado
Patented system

www.modulelectro.ru

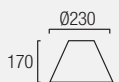

Pan-103-14
Pan-103-20



● Níquel satinado pintado
Painted satin nickel
U4 Nickel satiné peint
Lackiertes Nickel matt
Nichel satinato dipinto

● Oro satinado pintado
Painted satin gold
S8 Or satiné peint
Lackiertes Gold matt
Oro satinato dipinto

○ Pantalla blanca
White shade
14 Abat-jour blanc
Weiss Stoffschirm
Paralume bianca

○ Pantalla beige
Beige shade
20 Abat-jour beige
Beige Stoffschirm
Paralume beige

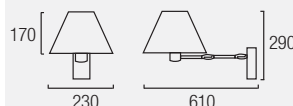

05-2275-U4-82
05-2275-S8-82
E-27 Max. 60W
INCANDESCENT

05-2276-U4-82
G24d1 13W
ENERGY SAVING

+ Pan-103-14 / Pan-103-20



05-2273-U4-82
E-27 Max. 60W
INCANDESCENT

05-2274-U4-82
G24d1 13W
ENERGY SAVING

+ Pan-103-14 / Pan-103-20

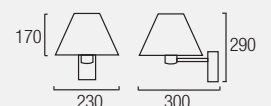

05-2271-U4-82
E-27 Max. 60W
INCANDESCENT

05-2272-U4-82
G24d1 13W
ENERGY SAVING

+ Pan-103-14 / Pan-103-20

Para conjunto completo solicite referencias de luminaria y pantalla
For complete set please order by separate fixture and shade reference



MODUL
ELECTRO

www.modulelectro.ru

versatil

design _ Estudi Ribaudí

Estructura y difusor metálicos en acabado níquel mate. Difusor giratorio y abatible. Interruptor incluido. Luz directa.

Matte nickel body and diffuser. Swivel and hinged diffuser. Switch included. Direct light.

Structure et diffuseur métalliques avec finitions en nickel mat. Diffuseur rotatif et inclinable. Interrupteur fourni. Lumière directe.

Gehäuse und Diffusor aus Metall mit Oberfläche in mattem Nickel. Diffusor dreh- und klappbar. Inkl. Schalter. Direkte Beleuchtung.

Struttura e diffusore metallici, con finitura in nichel opaco. Diffusore girevole e a scomparsa. Interruttore compreso. Luce diretta.



Níquel mate
Nickel matt
Nickel mat
Nickel matt
Nichel opaco

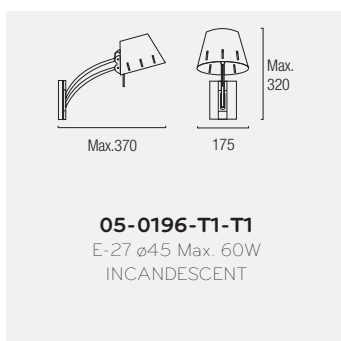

05-0196-T1-T1
E-27 ø45 Max. 60W
INCANDESCENT



 **MODUL** 
ELECTRO
www.modulelectro.ru



Estructura metálica en acabado níquel satinado. Difusor de cristal óptico matizado. Disponible en 2 tamaños: 20 cms y 30 cms. Luz directa.

Satin nickel metal body. Matte optical glass diffuser. Available in 2 sizes: 20cm and 30cm. Direct light.

Structure métallique avec finitions en nickel satiné. Diffuseur en verre optique teinté. Décliné en deux tailles: 20 cm et 30 cm. Lumière directe.

Metallgehäuse in satiniertem Nickel. Diffusor aus mattem Optikglas. Mit Durchmesser 30 cm oder 100 cm lieferbar. Direkte Beleuchtung.

Struttura metallica con finitura nichel satinato. Diffusore in cristallo ottico opacizzato. Disponibile in dimensioni da 20 e 30 cm. Luce diretta.

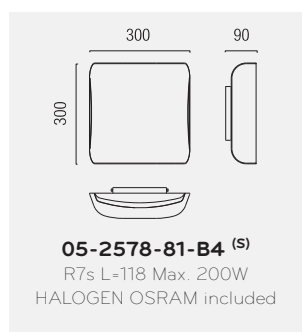
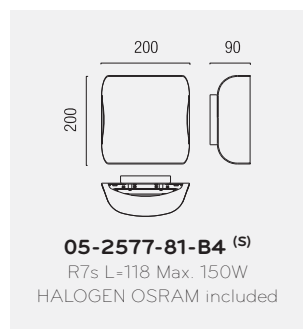

MODUL
ELECTRO
www.modulelectro.ru

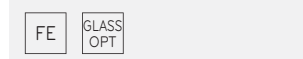
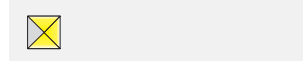

- Níquel Satinado
Satin nickel
- 81** Nickel satiné
Nickel matt
Nichel satinato
- Cristal óptico
Optic glass
- B4** Verre optique
Optishes Glas
Vetro ottico



Estructura metálica en acabado níquel satinado. Difusor de cristal óptico curvado y matizado. Luz directa.

Satin nickel metal body. Curved and matte optical glass diffuser. Direct light.

Structure métallique avec finitions en nickel satiné. Diffuseur en verre optique courbé et teinté. Lumière directe.

Metallgehäuse in satinier-tem Nickel. Diffusor aus gebogenem, mattiertem Optikglas. Direkte Beleuchtung.

Struttura metallica con finitura nichel satinato. Diffusore in cristallo ottico ricurvo e opacizzato. Luce diretta.

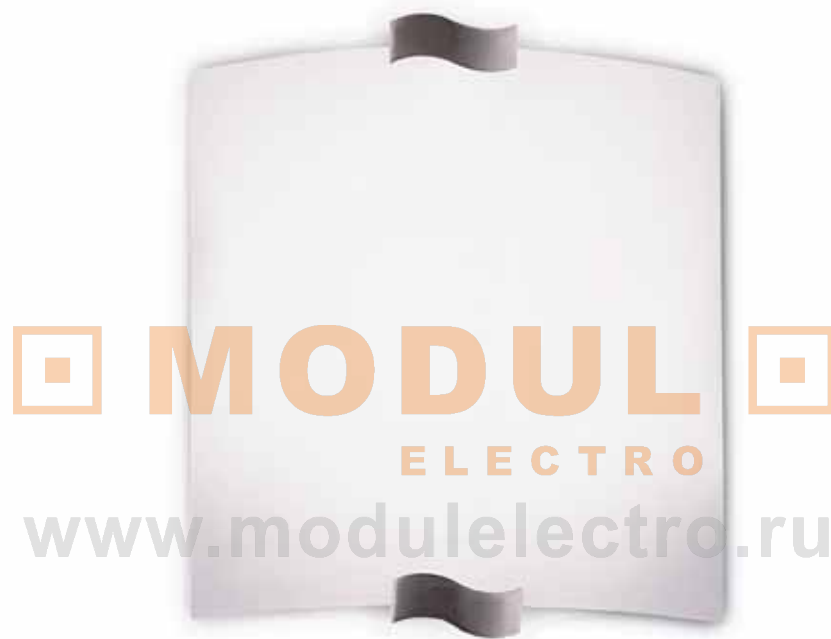

● Níquel Satinado Satin nickel 81 Nickel satiné Nickel matt Nichel satinato	○ Cristal óptico Optic glass E9 Verre optique Optishes Glas Vetro ottico		

05-1876-81-E9
 E-27 Max. 100W
 INCANDESCENT
 E-27 Max. 100W
 HALOGEN
 PL E-27 OSRAM 20W
 ENERGY SAVING



scala

design _ Josep Patsí / Xavier Muixí

scala_collection

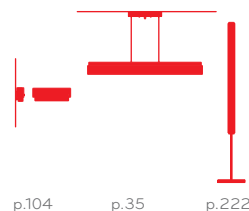

Estructura metálica en acabado cromo. Difusor de cristal fusing con tonos color cava. Luz directa e indirecta.

Chrome metal body. Fusing glass diffuser in pale yellow tones. Direct and indirect light.

Structure métallique avec finitions chromées. Diffuseur en verre fondu avec des tons champagne. Lumière directe et indirecte.

Gehäuse aus verchromtem Metall. Diffusor aus Fusing-Glas mit Sektfarbtönen. Zur direkten und indirekten Beleuchtung.

Struttura metallica con finitura cromata. Diffusore in cristallo fusing, con toni color champagne. Luce diretta e indiretta.

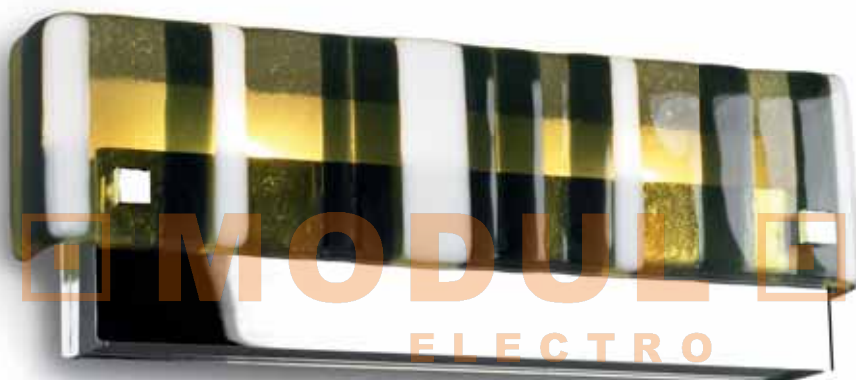

www.modulelectro.ru

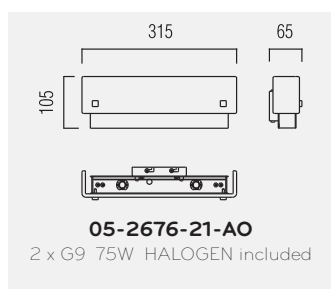

		FUSING	
<p> Cromo</p> <p>21 Chrome</p> <p>Chrom</p> <p>Cromo</p>	<p> Cristal fusing cava</p> <p>AO Fusing cava glass</p> <p>Verre fusing "cava"</p> <p>Sektfarbiges-fusing-Glas</p> <p>Vetro fusing cava</p>		



otras referencias / other references

YEDAY y STAR son colecciones del catálogo LED (LEDS-C4) / YEDAY and STAR are LED catalogue series (LEDS-C4)



Serie de apliques led de diseño minimalista realizados en aluminio pulido con junta transparente que crea un efecto de anillo luminoso. Innovadora familia con un espectacular haz de luz concentrado.

A series of minimalist led light-fittings executed in polished aluminium with a transparent joint to create an effect of a luminous ring. An innovative family boasting spectacular, concentrated light.

- 05-3377-52-00 Led 1-3W (50 x 49 x 40) cold / frío
- 05-3378-52-00 Led 1-3W (50 x 49 x 40) warm / cálido
- 05-3381-52-00 Led 2-6W (66 x 49 x 40) cold / frío
- 05-3382-52-00 Led 2-6W (66 x 49 x 40) warm / cálido

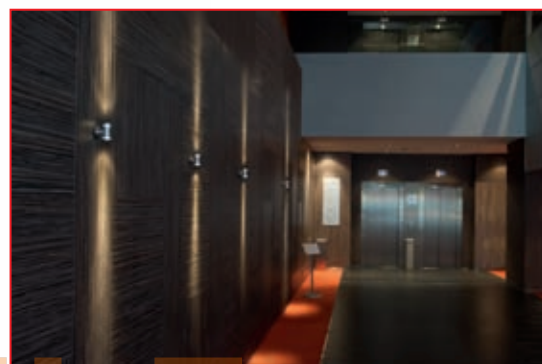

YEDAY



STAR



ELECTRO

www.modulelectro.ru

Aplique decorativo de superficie con tecnología led y cuerpo de aluminio. Proyecta 4 flujos luminosos perpendiculares creando un efecto de cuadrícula en la pared, por lo que resulta ideal para ambientes contemporáneos y modernos.

A decorative surface led light fitting with an aluminium body. It projects 4 luminous perpendicular beams, creating a grid effect onto the wall, which makes it ideal for contemporary and modern environments

- 05-3397-N3-00 Led 4W (Ø96 x 37 x 82) azul/ blue
- 05-3391-N3-00 Led 4W (Ø96 x 37 x 82) natural

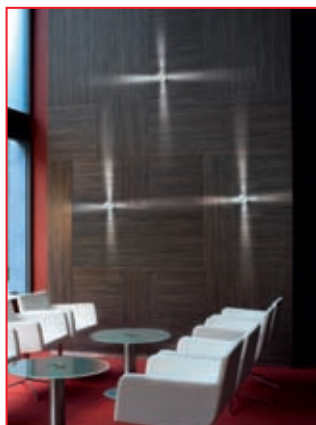

otras referencias / other references

CLAM es una colección del catálogo ARCHITECTURAL de LEDS-C4 / CLAM is an ARCHITECTURAL catalogue series (LEDS-C4)

Cuerpo metálico acabado en pintura epoxi de color blanco. Vano óptico realizado en chapa doblada con acabado blanco, con reflector incorporado de aluminio de alta pureza (99%). Disponible en 2 diámetros: 200 y 400mm, con fuentes de luz FLC y Halógenas (para versión LED RGB consultar).

El cuerpo va fijado a un marco de pre-instalación suministrado que permite la rotación de la luminaria para un enfoque óptimo del flujo luminoso a la vez que integra la pieza perfectamente en el entorno (concepto trimless). Los equipos quedan suspendidos del chasis del vano óptico facilitando la instalación y mantenimiento de los mismos.

CLAM ha nacido para integrarse en la arquitectura. Su concepto Trimless aunado a su mínima profundidad de instalación le permite ser instalado en muros tipo Pladur de 15 mm.

Metallic body finished in white epoxy paint. Optic device made of steel with a high purity anodised aluminium reflector (99%).

Available in 2 diameters: 200 and 400mm and 3 different lamp sources: CFL and halogen (for RGB LED version please advise).

The housing is fixed onto the supplied mounting kit allowing the rotation of the fitting and its output while integrating it on the wall. The gear hangs from the optic device housing to facilitate installation and maintenance.

CLAM means architecture's integration. Its Trimless concept together with its minimum depth allows it to be mounted in double plasterboard walls (15mm. depth).

EP-1601-14-14 QT-16 G9 max. 40W (250 x Ø197 x 61 cm)

EP-1602-14-14 TC-DEL G24q-2 18W (365 x Ø197 x 61 cm)

EP-1608-14-14 TC-F 2G10 24W (582 x Ø397 x 65 cm)

EP-1605-14-14 QT-16 G9 max. 60W (445 x Ø397 x 65 cm)

EP-1610-14-14 CDM-Tm PGJ5 max. 60W (445 x Ø397 x 65 cm)

MODULO
ELECTRO
www.modulelectro.ru



otras referencias / other references

SMART y THIN son colecciones del catálogo LED (LEDS-C4) / SMART and THIN are LED catalogue series (LEDS-C4)



Aplique inteligente de señalización, con tecnología led, de diseño contemporáneo con cuerpo de aluminio inyectado.

Incorpora un sensor infrarrojo de movimiento y un sensor detector de luz. Excelente para garantizar la seguridad en la oscuridad, proyectando un haz de luz cálido hacia el suelo al detectar el movimiento.

Versión empotrada o de superficie fácilmente adaptable.

Intelligent led light-fitting indicator with a modern design, featuring an injected aluminium body. It includes an infrared movement sensor and a light detector. Excellent to guarantee safety in the dark, projecting a warm beam of light towards the floor when it detects movement. Easily adaptable fitted or surface version.

05-3303-N3-00 Led 11W (110 x 110 x 34) warm / cálido

71-3303-N3-00 (110 x 110 x 36,5) Caja para montaje en superficie / Surface kit



Aplique inteligente de señalización que incorpora un sensor infrarrojo de movimiento y un sensor detector de luz.

Intelligent led light-fitting indicator that includes an infrared movement sensor and a light detector.

MODULO
SMART ENERGY SAVING ELECTRO
www.modulelectro.ru

THIN ENERGY SAVING



Kit de tres luminarias led minimalistas de señalización con un único controlador de equipo. Extremadamente delgado, ideal para suelos, paredes y techos de madera... permite una rápida y cómoda instalación en cualquier localización. El cuerpo está fabricado en aluminio con frontal de policarbonato resistente al peso y elevada estanqueidad.

A kit of three minimalist signposting led lights with a unique controller. It is extremely slim and ideal for wooden floors, walls and ceilings ... it enables rapid and convenient installation in any location. Features an aluminium body with a weight resistant polycarbonate frontal that is highly water resistant.

55-3357-54-M3 Led 3 x 0,5W (Ø55 x 8) warm / cálido

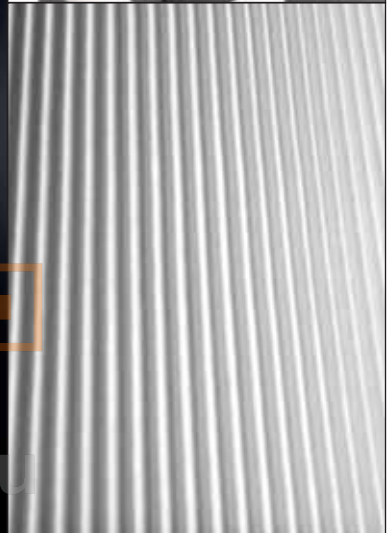
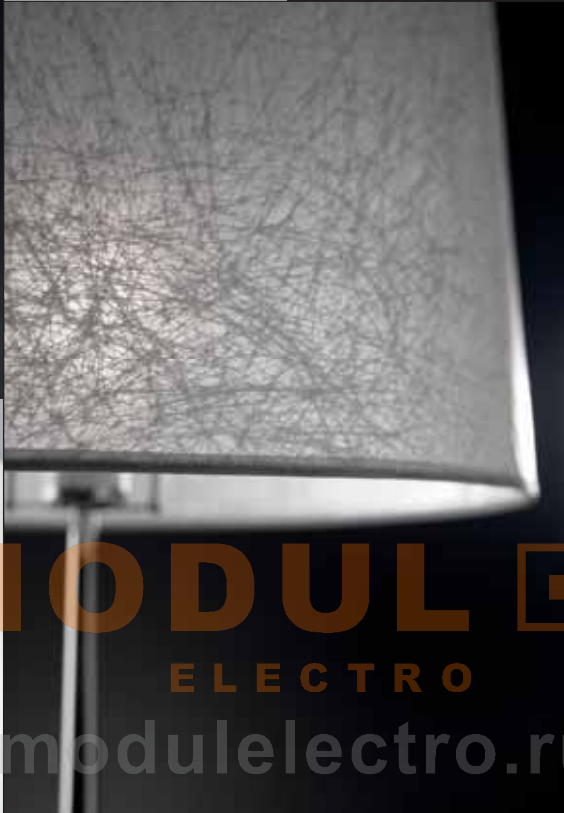



 **MODUL** 
ELECTRO
www.modulelectro.ru





_sobremesas

_table lamps

_lampes de tables

_tischleuchten

_lampade da tavolo

MODUL
ELECTRO

www.modulelectro.ru

escher_110

arc_114

tropo_116

adagio_118

bonne nuit_120

class_122

adn_123

umbrella_124

everyday_126

gloria_128

hotels_130

soul_131

leila_132

suite_134

open_136

office_138

totem mini_140

escher

design _ Josep Patsí

escher_collection

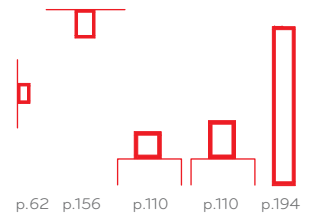

Estructura metálica en 3 acabados disponibles: aluminio Ecobright, lacado blanco y lacado negro. Los 3 acabados están disponibles en tamaño grande, con interruptor push-dimmer incorporado, y en tamaño pequeño, con interruptor-dimmer incluido. Cable de tela. Luz indirecta.

Metal body available in 3 finishes: Ecobright, black lacquer or white lacquer. The 3 finishes are available in large, with incorporated push-dimmer switch; and small, with dimmer switch included. Cord cable. Indirect light.

Structure métallique proposée avec trois finitions : aluminium Ecobright, verni blanc et verni noir. Celles-ci existent en grande taille avec interrupteur poussoir-variateur incorporé et en petite taille avec interrupteur-variateur fourni. Câble en tissu. Lumière indirecte.

Metallgehäuse in 3 Ausführungen lieferbar: Ecobright-Aluminium, weiß lackiert und schwarz lackiert. Die 3 Oberflächeausführungen sind in großer Größe, mit integriertem Push-Dimmerschalter und in kleiner Größe mit Dimmerschalter lieferbar. Textilkabel. Indirekte Beleuchtung.

Struttura metallica disponibile con 3 finiture: alluminio Ecobright, laccato bianco e laccato nero. Le 3 finiture sono disponibili in dimensione grande, con interruttore push-dimmer incorporato e in dimensione piccola, con interruttore dimmer compreso. Cavo in tela. Luce indiretta.

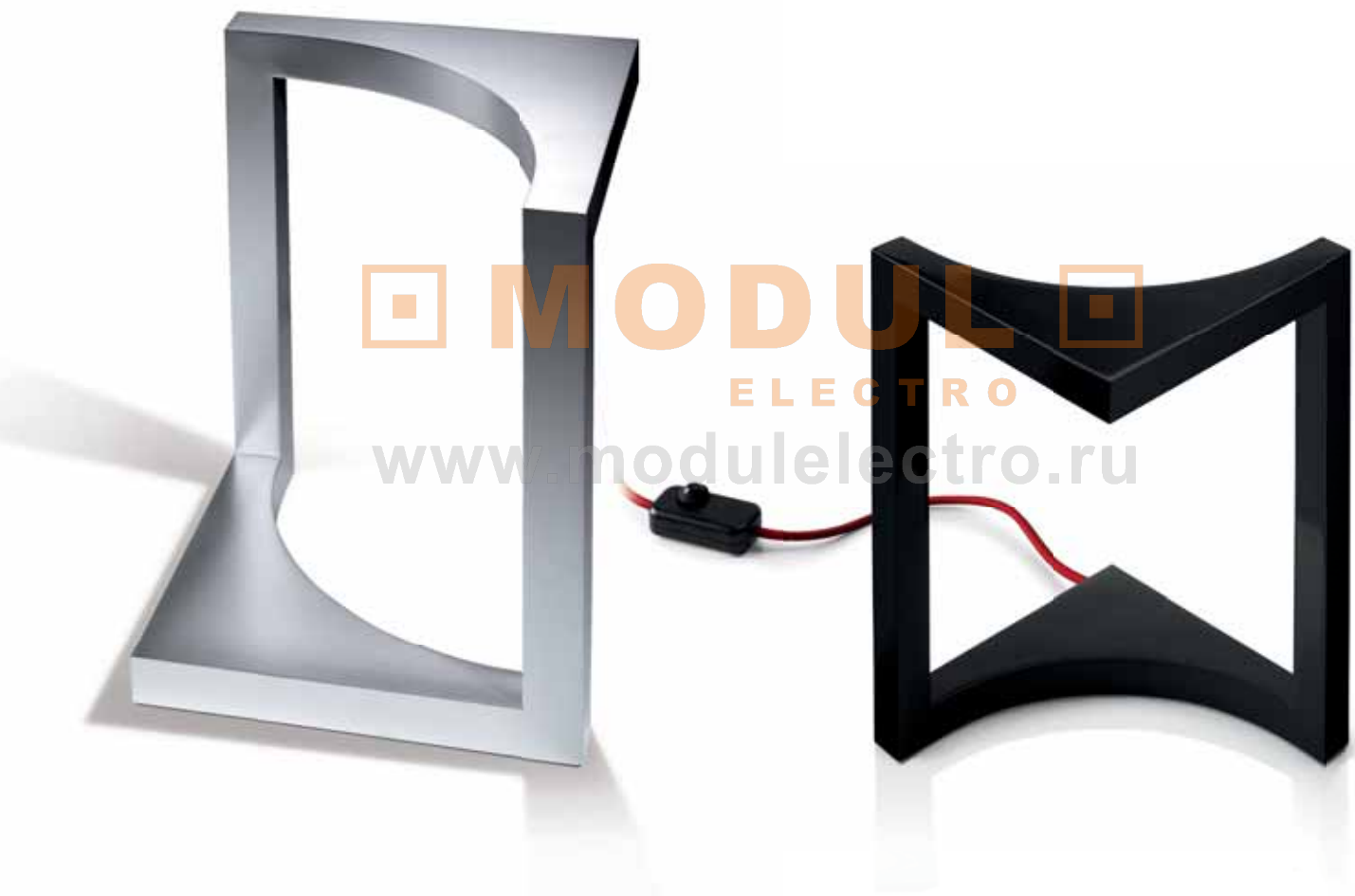

AH Aluminio Ecobright Ecobright aluminium Aluminium Ecobright Ecobright aluminium Alluminio Ecobright	05 Lacado negro Black lacquered Laqué en noir Schwarz lackiert Laccato nero	78 Lacado blanco White lacquered Laqué en blanc Weiss lackiert Laccato bianco	

10-2782-AH-AH
10-2782-05-05
10-2782-78-78
G9 75W
HALOGEN OSRAM included-
Push dimmer

10-2809-AH-AH
10-2809-05-05
10-2809-78-78
G9 60W
HALOGEN OSRAM included
Dimmer



MODUL ELECTRO
www.modulselectro.ru

escher

MODUL
ELECTRO

www.modulelectro.ru



MODUL
ELECTRO
www.modulelectro.ru

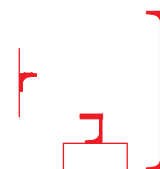

Estructura de aluminio y difusor de metacrilato matizado. Disponible en 3 acabados: aluminio Ecobright, lacado blanco y lacado negro. Interruptor incluido. Luz directa e indirecta.

Aluminium body and matte methacrylate diffuser. Available in 3 finishes: Ecobright, black lacquer or white lacquer. Switch included. Direct and indirect light.

Structure en aluminium et diffuseur en méthacrylate teinté. Proposée avec trois finitions : aluminium Ecobright, verni blanc et verni noir. Interrupteur fourni. Lumière directe et indirecte.

Gehäuse aus Aluminium und Diffusor aus mattiertem Plexiglas. In 3 Ausführungen lieferbar: Ecobright-Aluminium, weiß lackiert und schwarz lackiert. Inkl. Schalter. Zur direkten und indirekten Beleuchtung.

Struttura in alluminio e diffusore in metacrilato opacizzato. Disponibile in 3 finiture: alluminio Ecobright, laccato bianco e laccato nero. Interruttore compreso. Luce diretta e indiretta.



MODULO
ELECTRO
www.modulelectro.ru

<div style="display: flex; justify-content: space-around;"> <div style="border: 1px solid black; padding: 2px;">AL</div> <div style="border: 1px solid black; padding: 2px;">PMMA</div> </div>		
<p>○ Aluminium Ecobright Ecobright aluminium AH Aluminium Ecobright Ecobright aluminium Alluminio Ecobright</p>	<p>● Lacado negro Black lacquered 05 Laqué en noir Schwarz lackiert Laccato nero</p>	<p>○ Lacado blanco White lacquered 78 Laqué en blanc Weiss lackiert Laccato bianco</p>

10-2580-AH-AH
10-2580-05-05
10-2580-78-78
T5 circular 22W
FLUORESCENT included



MODUL
ELECTRO
www.modulelectro.ru

tropo

design_ Benedito Design

tropo_collection

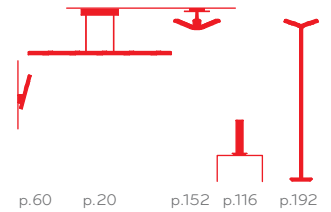

Estructura de aluminio acabado en cromo. Cristal de borosilicato matizado. Elegante combinación de formas simples: línea y círculo. Interruptor-dimmer incluido. Emite luz directa y también indirecta gracias a la apertura de la parte posterior de la estructura.

Chrome aluminium body. Matte borosilicate glass. Elegant combination of simple shapes - lines and circles. Dimmer switch included. Provides direct and indirect light thanks to an opening on the back of the luminaire.

Structure en aluminium avec finitions chromées. Verre en borosilicate teinté. Combinaison élégante de formes simples telles que des lignes et des cercles. Interrupteur-variateur fourni. Émet une lumière directe mais aussi indirecte grâce à l'ouverture de la partie postérieure de la structure.

Gehäuse aus verchromtem Aluminium. Mattiertes Borosilikat-Glas. Elegante Kombination einfacher Formen: Linie und Kreis. Inkl. Dimmerschalter. Direkte Beleuchtung sowie indirekte Beleuchtung durch die Öffnung an der Rückseite der Leuchte.

Struttura in alluminio con finitura cromata. Cristallo di borosilicato opacizzato. Elegante accostamento di forme semplici: linee e cerchi. Interruttore dimmer compreso. Emette luce diretta e indiretta, anche grazie all'apertura nella parte posteriore della struttura.



MODUL
ELECTRO

www.modulelectro.ru



10-2804-21-F1
G9 60W
HALOGEN OSRAM included

□ F RF 850°C ®

⊗

AL GLASS MAT

● Cromo
Chrome
21 Chrome
Chrom
Cromo

○ Cristal anti-deslumbrante
Anti-glare glass
F1 Verre antiéblouissante
Blendfreies Glas
Vetro antiriflesso



MODUL
ELECTRO
www.modulelectro.ru

adagio

design _ Josep Patsí

adagio_collection

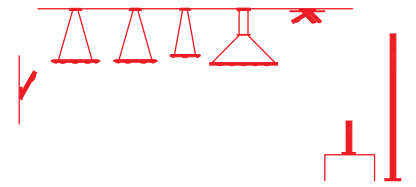

p.68 p.38 p.39 p.38 p.36 p.166 p.118 p.209

Estructura de aluminio y difusor de cristal anti-deslumbrante. Disponible en acabados cromo y aluminio pulido satinado. Interruptor incorporado. Emite luz directa y también indirecta gracias a la apertura de la parte posterior de la estructura.

Aluminium body and anti-glare glass diffuser. Available in chrome or polished and satin aluminium. Incorporated switch. Provides direct and indirect light thanks to an opening on the back of the luminaire.

Structure en aluminium et diffuseur en verre antireflets. Proposée avec des finitions chromées et en aluminium poli satiné. Interrupteur incorporé. Émet une lumière directe mais aussi indirecte grâce à l'ouverture de la partie postérieure de la structure.

Gehäuse aus Aluminium und Diffusor aus entspiegeltem Glas. Verchromt und in poliertem satiniertem Aluminium lieferbar. Inkl. Schalter. Direkte Beleuchtung sowie indirekte Beleuchtung durch die Öffnung an der Rückseite der Leuchte.

Struttura in alluminio e diffusore in cristallo anti-abbagliamento. Disponibile con finitura in cromo e alluminio lucido satinato. Interruttore incorporato. Emette luce diretta e indiretta, anche grazie all'apertura nella parte posteriore della struttura.



MODUL
ELECTRO
www.modulelectro.ru

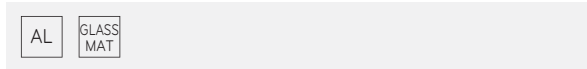

- Cromo
- Chrome
- 21** Chrome
- Chrom
- Cromo
- Aluminio pulido y satinado
- Polished and burnished aluminium
- S3** Aluminium poli et satiné
- Aluminium poliert und mattglänzend
- Alluminio lucidato e satinato

- Cristal anti-deslumbrante
- Anti-glare glass
- F1** Verre antiéblouissante
- Blendfreies Glas
- Vetro antiriflesso

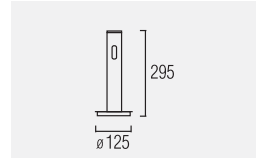

10-0221-21-F1
10-0221-S3-F1
G9 Max. 60W 230V
HALOGEN OSRAM included

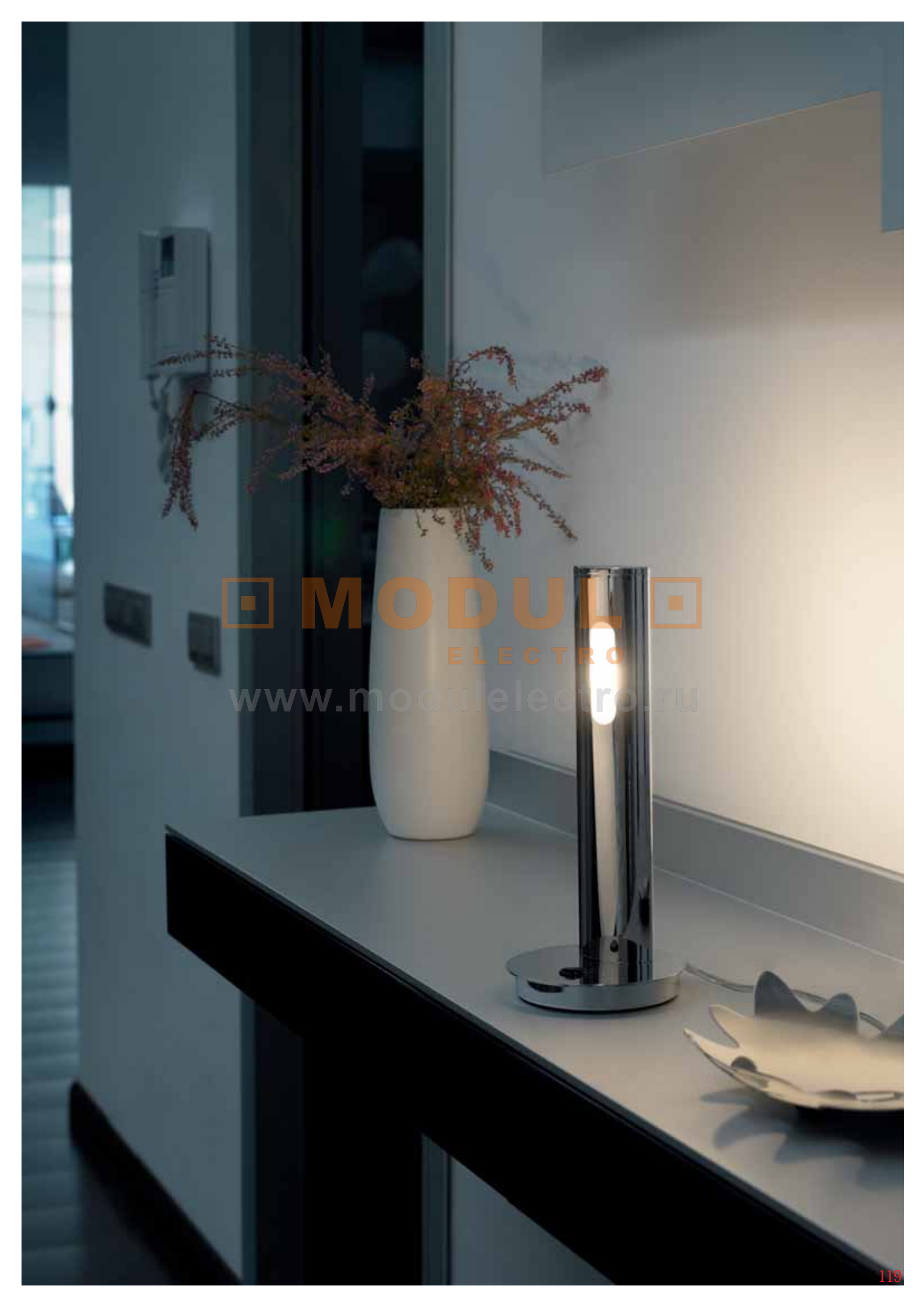

MODULO
ELECTRO
www.modulelectro.ru

bonne nuit

design _ Benedito Design

Estructura metálica en acabado níquel satinado. Difusor de cristal opal triplex. Interruptor incluido. Luz directa.

Satin nickel metal body. Triplex optical glass diffuser. Switch included. Direct light.

Structure métallique avec finitions en nickel satiné. Diffuseur en verre opale triplex. Interrupteur fourni. Lumière directe.

Metallgehäuse in satiniertem Nickel. Diffusor aus Triplex-Opalglas. Inkl. Schalter. Direkte Beleuchtung.

Struttura metallica con finitura nichel satinato. Diffusore in cristallo opale triplex. Interruttore compreso. Luce diretta.

www.modulelectro.ru



● Níquel Satinado
Satin nickel
81 Nickel satiné
Nickel matt
Nichel satinato

○ Cristal opal triplex
Triplex Opal glass
F9 Verre opal triplex
Optishes Glas
Vetro ottico

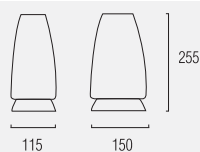

10-2056-81-F9
E-27 ø45 Max. 60W
INCANDESCENT
PL ELECT E-27 15W
ENERGY SAVING



MODUL
ELECTRO
www.modulelectro.ru

class

design _ Josep Patsí

class_collection

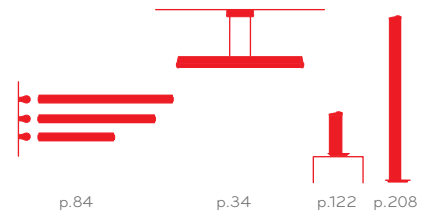

Estructura de aluminio Ecobright. Doble difusor: interior de policarbonato opal y exterior de borosilicato transparente. Interruptor incorporado. Luz directa.

Ecobright aluminium body. Double diffuser - inner: opal polycarbonate, exterior: transparent borosilicate. Incorporated switch. Direct light.

Structure en aluminium Ecobright. Double diffuseur: intérieur en polycarbonate opale et extérieur en borosilicate transparent. Interrupteur incorporé. Lumière directe.

Gehäuse aus Ecobright-Aluminium. Doppelter Diffusor: Innen aus Opal-Polycarbonat und außen aus transparentem Borosilikat. Inkl. Schalter. Direkte Beleuchtung.

Struttura in alluminio Ecobright. Doppio diffusore: interno in policarbonato opale ed esterno in borosilicato trasparente. Interruttore incorporato. Luce diretta.



Doble difusor
Double diffuser
Diffuseur double
Doppelglas
Difusore doppio

MODUL
ELECTRO
www.modulelectro.ru



	ENERGY SAVING		
AL	PC	GLASS BOSI	
	Aluminio Ecobright Ecobright aluminium AH Aluminium Ecobright Ecobright aluminium Alluminio Ecobright		

10-2694-AH-37 (S)
T5 8W FLUORESCENT included



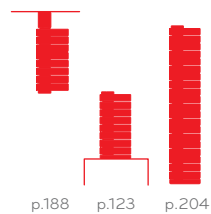

Estructura metálica y embellecedores de ABS, ambos en acabado cromo. Difusor compuesto por 8 pantallas giratorias de color blanco escarcha. Interruptor incluido. Luz directa.

Metal body and ABS trims, both finished in chrome. Diffuser consisting of 8 swivel frosted white shades. Switch included. Direct light.

Structure métallique et caches en ABS avec finitions chromées. Diffuseur composé de huit écrans rotatifs en blanc glacé. Interrupteur fourni. Lumière directe.

Metallgehäuse und Zierblende aus ABS, verchromt. Diffusor aus 8 drehbaren in Ice-Weiß. Inkl. Schalter. Direkte Beleuchtung.

Struttura metallica ed elementi di finitura in ABS, entrambi con finitura cromata. Diffusore composto da 8 paralumi girevoli in colore bianco ghiaccio. Interruttore compreso. Luce diretta.



<p> Cromo</p> <p>21 Chrome</p> <p>Chrom</p> <p>Cromo</p>	<p> Pantallas Blanco Escarcha incluidas</p> <p>AL Abat-jour gelée blanche compris</p> <p>Weiss Schirm inklusiv</p> <p>Paralume bianco brina inclusa</p>	

10-2705-21-AL
T5 24W
FLUORESCENT included



umbrella

design _ WIS design

umbrella_collection

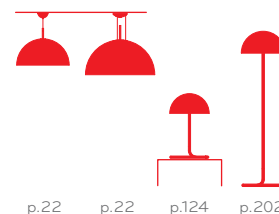

Estructura metálica con pantalla semiesférica de aluminio. Hay 2 versiones disponibles: acabado lacado blanco con pantalla interior plisada plata y acabado lacado negro con pantalla interior plisada dorada. Interruptor incluido. Cable de tela. Luz directa.

Metal body with semisphere aluminium shade. Available in 2 versions: white lacquer finish with inner silver pleated shade and black lacquer finish with inner gold pleated shade. Switch included. Cord cable. Direct light.

Structure métallique avec écran semisphérique en aluminium. Existe en deux déclinaisons: une avec finitions en vernis blanc avec écran intérieur plissé couleur argent et une autre avec finitions en vernis noir avec écran intérieur plissé couleur doré. Interrupteur fourni. Câble en tissu. Lumière directe.

Metallgehäuse mit halbrundem Schirm aus Aluminium. In 2 Ausführungen lieferbar: weiß lackierte Oberfläche mit silberfarben-plissiertem Innenschirm und schwarz lackierte Oberfläche mit goldfarben-plissiertem Innenschirm. Inkl. Schalter. Textilkabel. Direkte Beleuchtung.

Struttura metallica con paralume semisferico in alluminio. 2 versioni disponibili: finitura laccata bianca con paralume interno plissettato colore argento e finitura laccata nera, con paralume interno plissettato dorato. Interruttore compreso. Cavo in tela. Luce diretta.

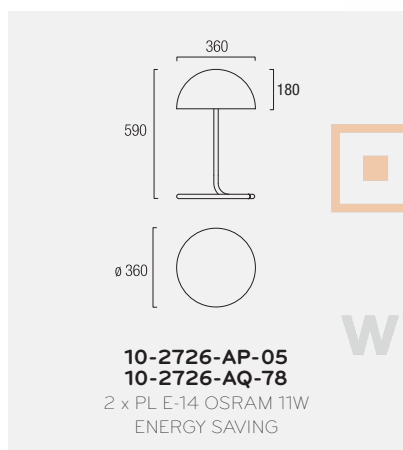

MODUL ELECTRO
www.modulelectro.ru



AP Pantalla interior plisada dorada
Golden pleated interior shade
Intérieur d'abat-jour plissé doré
Schirm, Innenseite Gold plissée
Paralume interna plisata oro

AQ Pantalla interior plisada plata
Silver pleated interior shade
Intérieur d'abat-jour plissé argenté
Schirm, Innenseite Silver plissée
Paralume interna plisada argento

05 Lacado negro
Black lacquered
Laqué en noir
Schwarz lackiert
Laccato nero

78 Lacado blanco
White lacquered
Laqué en blanc
Weiss lackiert
Laccato bianco



MODUL
ELECTRO
www.modulelectro.ru

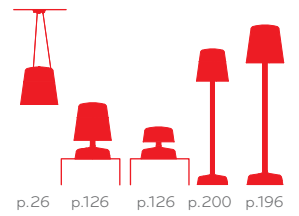

Estructura metálica blanca. Disponible con y sin difusor de cristal opal triplex. Interruptor de diseño. Cable de tela. Luz directa e indirecta.

White metal body. Available with or without triplex optical glass diffuser. Design switch. Cord cable. Direct and indirect light.

Structure métallique blanche. Proposée avec ou sans diffuseur en verre opale triplex. Interrupteur design. Câble en tissu. Lumière directe et indirecte.

Metallgehäuse, weiß. Lieferbar mit und ohne Diffusor aus Triplex-Opalglas. Design-Schalter. Textilkabel. Zur direkten und indirekten Beleuchtung.

Struttura metallica bianca. Disponibile con e senza diffusore in cristallo opale triplex. Interruttore di design. Cavo in tela. Luce diretta e indiretta.



FE			
Blanco	White	Cristal opal triplex	Triplex Opal glass
14 Blanc	14 Weiss	F9 Verre opal triplex	Optisches Glas
Bianco		Vetro ottico	

10-2729-14-14
2 x E-14 Max. 40W
INCANDESCENT
2 x PL E-14 OSRAM 11W
ENERGY SAVING

10-2728-14-F9
E-27 Max. 100W
INCANDESCENT
PL E-27 OSRAM 23W
ENERGY SAVING



MODUL
ELECTRO
www.modulelectro.ru

Estructura metálica en acabado níquel satinado con detalles en cromo. El difusor combina cristal anti-deslumbrante y pantalla plisada (no incluida). Interruptor incorporado en la parte superior. Posibilidad de esconder el cableado debajo de la base. Luz directa e indirecta.

Satin nickel body with chrome details. The diffuser combines anti-glare glass with pleated shade (not included). Switch incorporated in upper part. Cables can be hidden under the base. Direct and indirect light.

Structure métallisée avec finitions en nickel satiné, avec des détails chromés. Le diffuseur intègre du verre antireflets et un écran plissé (non fourni). Interrupteur incorporé sur la partie supérieure. Câble rangeable sous le socle. Lumière directe et indirecte.

Metallgehäuse in satinier-tem Nickel mit verchromten Details. Der Diffusor kombiniert entspiegeltes Glas und einen plissierten Schirm (nicht im Preis enthalten). Inkl. Schalter an Oberseite. Kabel lässt sich unter dem Fuß verstecken. Zur direkten und indirekten Beleuchtung.

Struttura metallica con finitura nichel satinata e finiture cromate. Il diffusore abbina cristallo anti-abbagliamento e paralume plissettato (non fornito). Interruttore integrato nella parte superiore. Possibilità di inserire il cavo sotto la base. Luce diretta e indiretta.

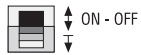

● Níquel satinado con cromo
Satin nickel with chrome
N6 Nickel satiné avec chrome
Nickel matt mitt Chrom
Nichel satinato con cromo

Cristal anti-deslumbrante
Anti-glare glass
Verre antiéblouissante
Blendfreies Glas
Vetro antiriflesso

Pantalla Plisada
Pleated cloth shade
Abat-jour en tissu plissé
Schirm aus Plisseestoff
Paralume plissettato

MODULO
ELECTRO
www.modulelectro.ru

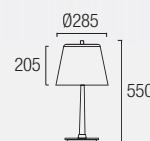

10-2278-N6-82
+ Pan-100-14
2 x E-14 Max. 60W
INCANDESCENT

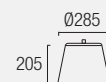

Pan-100-14

Para conjunto completo solicite referencias de luminaria y pantalla
For complete set please order by separate fixture and shade references



MODUL
ELECTRO
www.modulelectro.ru

hotels

design _ Benedito Design

hotels_collection

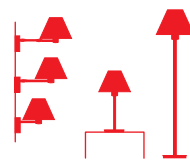

p.98 p.130 p.214

Estructura metálica. Hay 4 posibles combinaciones: en función del acabado, níquel satinado pintado u oro pintado; y en función de la pantalla, blanca o beige. Pantallas no incluidas. Interruptor incluido. Luz directa e indirecta.

Metal body. Available in 4 combinations: according to finish (painted satin nickel or painted gold) or shade (white or beige). Shades not included. Switch included. Direct and indirect light.

Structure métallique. Quatre combinaisons possibles en fonction des finitions (couleur nickel satiné ou peint en doré) et de l'écran (blanc ou beige). Écrans non fournis. Interrupteur fourni. Lumière directe et indirecte.

Metallgehäuse. 4 mögliche Kombinationen: Oberfläche in lackiertem satiniertem Nickel oder goldfarben lackiert. Lampenschirm weiß oder beige. Schirme nicht im Lieferumfang enthalten. Inkl. Schalter. Zur direkten und indirekten Beleuchtung.

Struttura metallica. Esistono 4 possibili combinazioni: in funzione della finitura, nickel satinato dipinto o oro dipinto e, in funzione del paralume, bianco o beige. Paralumi non forniti. Interruttore compreso. Luce diretta e indiretta.

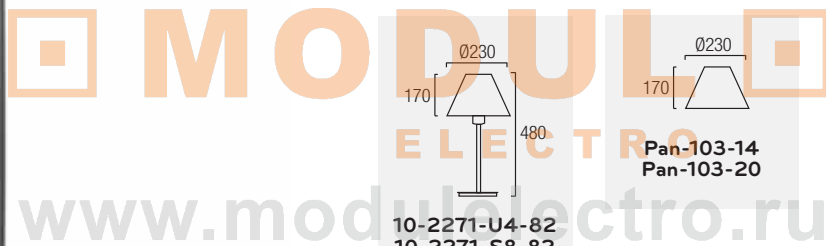

10-2271-U4-82

10-2271-S8-82

E-27 Max. 60W
INCANDESCENT

+
Pan-103-14
/ Pan-103-20

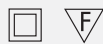

● Níquel satinado pintado
Painted satin nickel
U4 Nickel satiné peint
Lackiertes Nickel matt
Nichel satinato dipinto

● Oro satinado pintado
Painted satin gold
S8 Or satiné peint
Lackiertes Gold matt
Oro satinato dipinto

○ Pantalla blanca
White shade
14 Abat-jour blanc
Weiss Stoffchirm
Paralume bianca

○ Pantalla beige
Beige shade
20 Abat-jour beige
Beige Stoffchirm
Paralume beige

Para conjunto completo solicite referencias de luminaria y pantalla
For complete set please order by separate fixture and shade reference



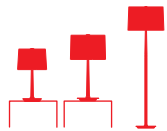

p.131 p.131 p.215

Estructura metálica en acabado cromo. Difusor superior de cristal fumé. Pantalla, de color negro soirée o blanco escarcha. Pantalla de tela incluida. Interruptor-dimmer incluido. 2 tamaños de lámpara.

Chrome metal body. Upper smoked glass diffuser. Soirée black or frosted white shade. Fabric shade included. Dimmer switch included. 2 sizes

Structure métallique avec finitions chromées. Diffuseur supérieur en verre fumé. Écran (couleur noir soirée ou blanc glacé). Écran en tissu fourni. Interrupteur-variateur fourni. 2 tailles.

Gehäuse aus verchromtem Metall. Oberer Diffusor aus Fumé-Glas. Schirm: Soirée-Schwarz oder Ice-Weiß. Mit Stoffschirm. Inkl. Dimmerschalter. Beleuchtung. 2 lieferbar.

Struttura metallica con finitura cromata. Diffusore superiore in cristallo fumé. Paralume, di colore nero soirée o bianco ghiaccio. Compreso paralume in tela. Interruttore dimmer compreso. 2 dimensioni

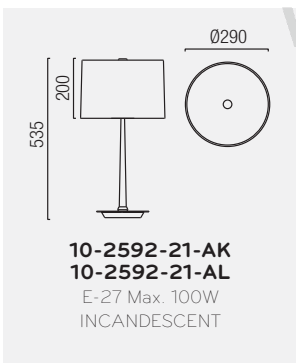
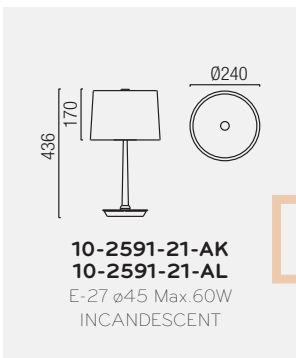
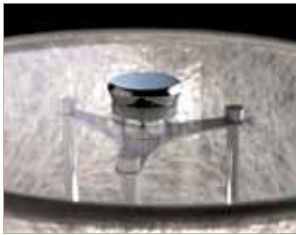

MODULO ELECTRO
www.modulelectro.ru



● Cromo
 Chrome
21 Chrom
 Chrom
 Cromo

● Pantalla negra de tela incluida
 Black fabric shade included
AK Abat-jour noir en tissu compris
 Schwarz Schirm inklusiv
 Paralume di tela nero inclusa

○ Cristal fumé
 Smoked glass
 Verre fumé
 Fumé Glas
 Vetro fumé

○ Pantalla blanca de tela incluida
 White fabric shade included
AL Abat-jour blanche en tissu compris
 Weiss Schirm inklusiv
 Paralume di tela bianca inclusa



leila

design _ Benedito Design

leila_collection

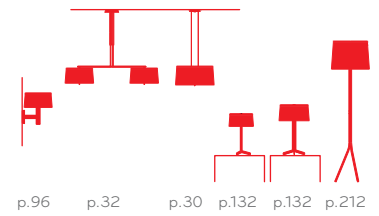

Estructura de la base de metal en acabado cromo y pie de aluminio satinado. Cristal superior óptico matizado. Disponible en 2 tamaños, cada uno con pantalla de tela de color negro o blanco. Interruptor incluido. Luz directa e indirecta.

Chrome base and satin aluminium foot. Upper matte optical glass. Available in 2 sizes, each with fabric shade in black or white. Switch included. Direct and indirect light.

Structure du socle en métal avec finitions chromées et pied en aluminium satiné. Verre optique supérieur teinté. Proposée en deux tailles, chacune avec écran en tissu noir ou blanc. Interrupteur fourni. Lumière directe et indirecte.

Basis aus verchromtem Metall und Fuß aus satiniertem Aluminium. Oberglas aus mattiertem Optikglas. In 2 Größen lieferbar, Schirm aus Stoff in Schwarz oder Weiß. Inkl. Schalter. Zur direkten und indirekten Beleuchtung.

Struttura della base di metallo con finitura cromata e base in alluminio satinato. Cristallo superiore ottico opacizzato. Disponibile in 2 dimensioni, ciascuna con paralume di tela di colore nero o bianco. Interruttore compreso. Luce diretta e indiretta.



Cristal óptico
Optic glass

MODUL
ELECTRO
www.modulelectro.ru



AL FE PVC TEXTIL ZAMAK

AG Aluminium con cromo
Aluminium with chrome
Aluminium avec chrome
Aluminium mit Chrom
Alluminio con cromo

05 Pantalla negra de tela incluida
Black fabric shade included
Abat-jour noir en tissu compris
Schwartz Schirm inklusiv
Paralume di tela nero inclusa

14 Pantalla blanca de tela incluida
White fabric shade included
Abat-jour blanche en tissu compris
Weiss Schirm inklusiv
Paralume di tela bianca inclusa

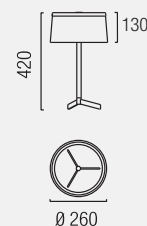

10-2407-AG-05
10-2407-AG-14
G9 Max. 75W
HALOGEN OSRAM included

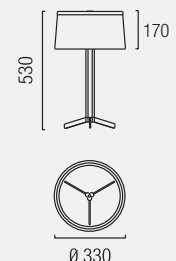

10-2571-AG-05
10-2571-AG-14
2 x E-14 Max. 60W
INCANDESCENT



MODUL
ELECTRO
www.modulelectro.ru

suite

design _ Benedito Design

suite_collection

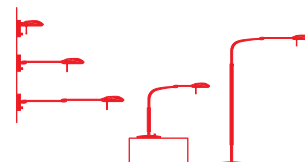

p.92

p.134

p.218

Estructura metálica en acabado níquel satinado. Difusor de cristal opal satinado. Interruptor-dimmer incorporado. Luz directa e indirecta.

Satin nickel metal body. Satin opal glass diffuser. Dimmer switch incorporated. Direct and indirect light.

Structure métallique avec finitions en nickel satiné. Diffuseur en verre opale satiné. Interrupteur-variateur incorporé. Lumière directe et indirecte.

Metallgehäuse in satiniertem Nickel. Diffusor aus satiniertem Opalglas. Einschbl. eingebautem Dimmerschalter. Zur direkten und indirekten.

Struttura metallica con finitura nichel satinato. Diffusore in cristallo opale satinato. Interruttore dimmer integrato. Luce diretta e indiretta.



DIMMER

MODULO ELECTRO

www.modulelectro.ru



10-0378-81-B8

G9 Max. 75W 230V
HALOGEN OSRAM included



DIMMER



● Níquel Satinado
Satin nickel
81 Nickel satiné
Nickel matt
Nichel satinato

○ Cristal opal satinado
Satin opal glass
B8 Verre opal satin
Satiniertes opales Glas
Vetro opal satinado



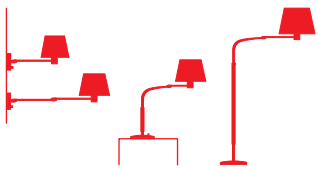

p.94

p.135

p.216

Estructura metálica en acabado níquel satinado. Pantalla de tela gris Ópera (incluida). Interruptor-dimmer incorporado. Luz directa e indirecta.

Satin nickel metal body. Grey fabric shade, Opera (included). Dimmer switch incorporated. Direct and indirect light.

Structure métallique avec finitions en nickel satiné. Écran en tissu gris Opéra. Interrupteur-variateur incorporé. Lumière directe et indirecte.

Metallgehäuse in satiniertem Nickel. Lieferbar mit Schirm aus grauem Opéra-Stoff (im Preis enthalten). Einschl. eingebautem Dimmerschalter. Zur direkten und indirekten Beleuchtung.

Struttura metallica con finitura nichel satinato. Paralume di tela grigia Opera (fornito). Interruttore dimmer integrato. Luce diretta e indiretta.



DIMMER

MODULO

ELECTRO

www.modul-electro.ru

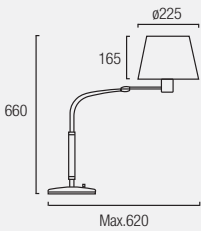

10-0381-81-AJ
E-27 Max. 60W
INCANDESCENT



DIMMER



● Níquel Satinado
Satin nickel

81 Nickel satiné
Nickel matt
Nichel satinato

● Pantalla Gris Ópera incluida
Opera Grey shade included
AJ Abat-jour Gris Opéra compris
Grau Schirm inklusiv
Paralume grigio inclusa



open

design _ Josep Patsi

open_collection

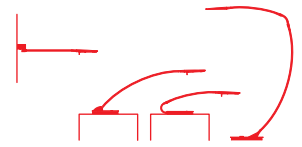

p.90 p.136 p.136 p.220

Estructura de aluminio en acabados Ecobright y cromo, ambos disponibles en formato basculante y en formato flexo orientable. Interruptor incorporado. Difusor de policarbonato transparente. Cabezal orientable. Luz directa.

Aluminium body in Ecobright or chrome finishes; both available in tilt or directionable flex format. Incorporated switch. Transparent polycarbonate diffuser. Adjustable head. Direct light.

Structure en aluminium avec finitions en Ecobright et chromées, toutes deux proposées dans un format à bascule ou flexible et orientable. Interrupteur incorporé. Diffuseur en polycarbonate transparent. Tête orientable. Lumière directe.

Gehäuse aus Aluminium in Ecobright und Chrom, beide Oberflächenaustrittungen kippbar und flexo-regulierbar lieferbar. Inkl. Schalter. Diffusor aus transparentem Polycarbonat. Verstellbares Kopfteil. Direkte Beleuchtung.

Struttura di alluminio con finitura Ecobright e cromo, entrambe disponibili in formato basculante e in formato flexo orientabile. Interruttore incorporato. Diffusore in policarbonato trasparente. Testina orientabile. Luce diretta.



MODULO
ELECTRO
www.modulelectro.ru

		RF 850°C	®
		ON - OFF	
AL	FE	PC	
● Cromo ● Chrome 21	● Aluminio Ecobright ● Ecobright aluminium ● Aluminium Ecobright ● Ecobright aluminium ● Alluminio Ecobright	AH	

Min. 780
Max. 1020

Min. 170
Max. 710

350°

10-2708-21-21
10-2708-AH-AH
LED 4,5W

Min. 300
Max. 650

Min. 120
Max. 670

10-2709-21-21
10-2709-AH-AH
LED 4,5W

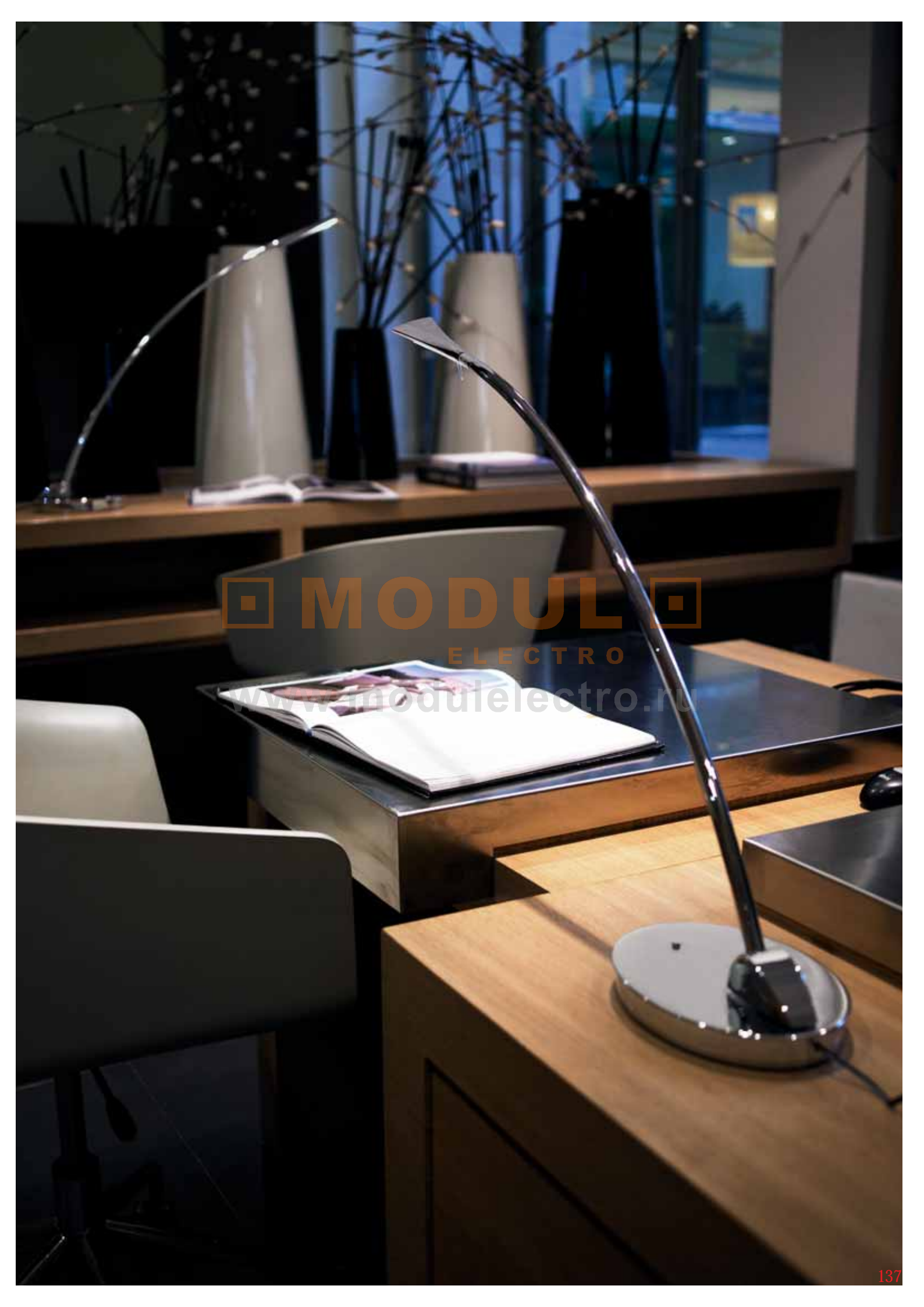

MODUL
ELECTRO
www.modulelectro.ru

office

design _ GROK Team

Estructura metálica disponible en acabados cromo y níquel satinado. Brazo basculante, cabezal orientable. Interruptor incluido. Luz directa.

Chrome or satin nickel body. Tilttable arm, adjustable head. Switch included. Direct light.

Structure métallique proposée avec finitions en nickel satiné et chromées. Bras à bascule, tête orientable. Interrupteur fourni. Lumière directe.

Metallgehäuse lieferbar in Chrom und satiniertem Nickel. Kipparm, verstellbares Kopfteil. Inkl. Schalter. Direkte Beleuchtung.

Struttura metallica disponibile con finitura cromata e nichel satinato. Braccio basculante, testina orientabile. Interruttore compreso. Luce diretta.

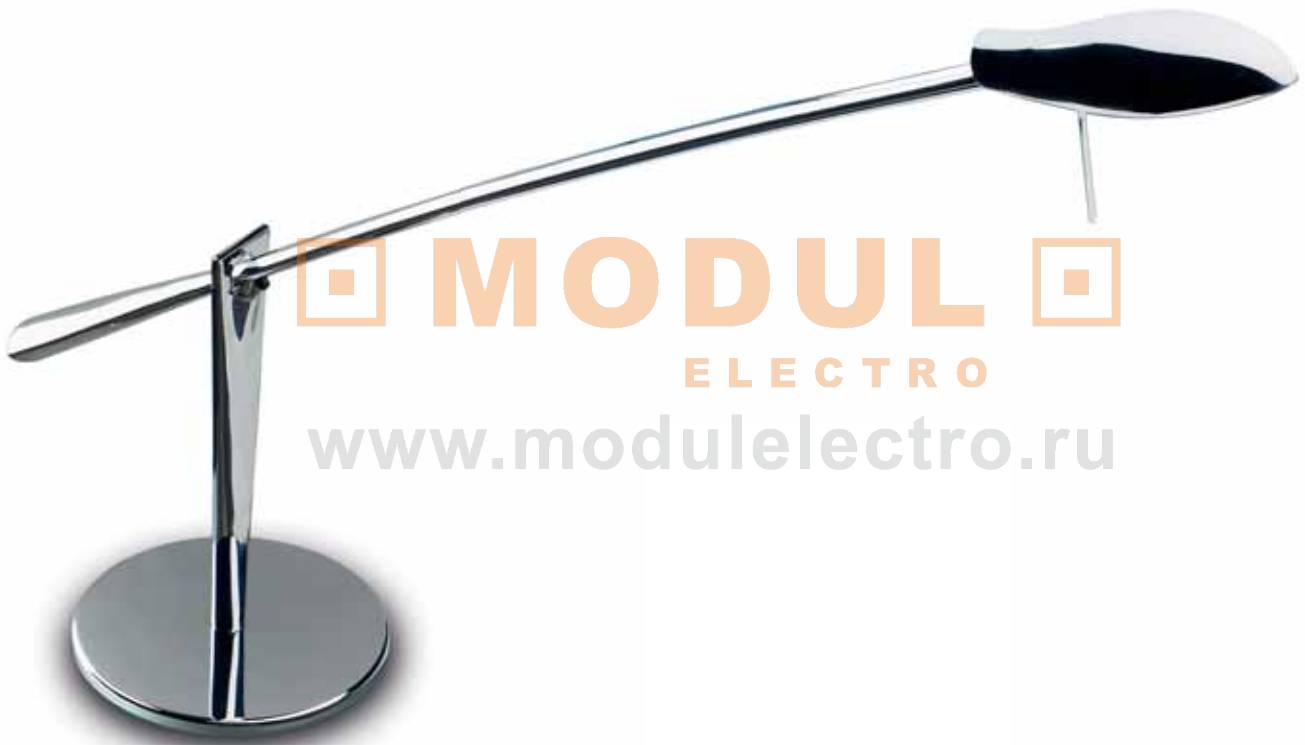

MODULO
ELECTRO
www.modulelectro.ru

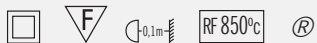

AL FE

● Cromo
● Chrome
21 Chrome
● Chrom
● Cromo

● Níquel Satinado
● Satin nickel
81 Nickel satiné
● Nickel matt
● Nichel satinato

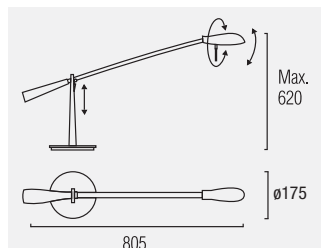

10-0080-21-21
10-0080-81-81
G9 Max. 60W 230V
HALOGEN OSRAM included



MODUL
ELECTRO

www.modulelectro.ru

totem mini

design _ Josep Patsí

totem_collection

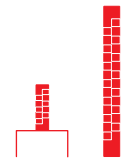

p.140 p.224

Estructura de aluminio en acabado satinado. Difusor acrílico opal. 2 interruptores independientes incorporados. Un interruptor enciende y apaga la luz principal; el otro enciende, apaga y cambia el color de la luz ambiente, permitiendo seleccionar entre 6 colores distintos así como el modo de cambio automático de color. Luz directa y luz de ambiente.

Satin aluminium body. Opal acrylic diffuser 2 independent switches incorporated. One switch turns the main light on /off; the other turns the ambient light on/off and changes the colour, selecting from 6 different colours as well as automatic colour-change mode. Direct and ambient light.

Structure en aluminium avec finitions satinées. Diffuseur acrylique opale. Deux interrupteurs incorporés indépendants : l'un allume et éteint la lumière principale, l'autre allume, éteint et change la couleur de la lumière d'ambiance (six couleurs différentes ainsi qu'un mode de changement automatique de la couleur). Lumière directe et lumière d'ambiance.

Gehäuse aus Aluminium mit satinierter Oberfläche. Diffusor Opal-Acryl. Mit 2 separaten Schaltern geliefert. Ein Schalter schaltet die Hauptlampe ein und aus, der zweite wählt und schaltet die Farbe des Ambientelechts. Auswahl zwischen 6 Farben möglich, sowie Modus zum automatischen Farbwechsel. Direkte Beleuchtung und Ambientebeleuchtung.

Struttura in alluminio, finitura lucida satinata. Diffusore acrilico opale. 2 interruttori indipendenti integrati. Un interruttore accende, spegne e regola la luce principale, mentre l'altro accende, spegne e cambia il colore della luce ambientale, consentendo di scegliere tra 6 diversi colori e la modalità di selezione automatica del colore. Luce diretta e luce ambientale.



MODULO
ELECTRO
www.modulelectro.ru



VERTICAL FLUORESCENT LIGHT



LED COLOR CONTROL

Presionar para cambiar el color de los LEDs (6 colores). Incluye opción de cambio automático de color. Presionar durante 2 segundos para apagar los LEDs.
Press to change the color of the LEDs (6 colors). Includes automatic color change. Pressing 2 seconds to switch off the LEDs.



- Aluminio satinado
Satin aluminium
AF Aluminium satiné
Aluminium matt
Alluminio satinato
- Difusor acrílico opal
Opal acrylic diffuser
M1 Diffuseur acrilique opale
Kunststoff - Reflektor
Diffusore acrilico opalino

RGB color system with LEDs



10-2384-AF-M1



2G11 Max. 24W
ENERGY SAVING included

36 LEDs RGB COLOR SYSTEM



MODUL
ELECTRO
www.modul-electro.ru



 **MODUL** 
ELECTRO
www.modulelectro.ru

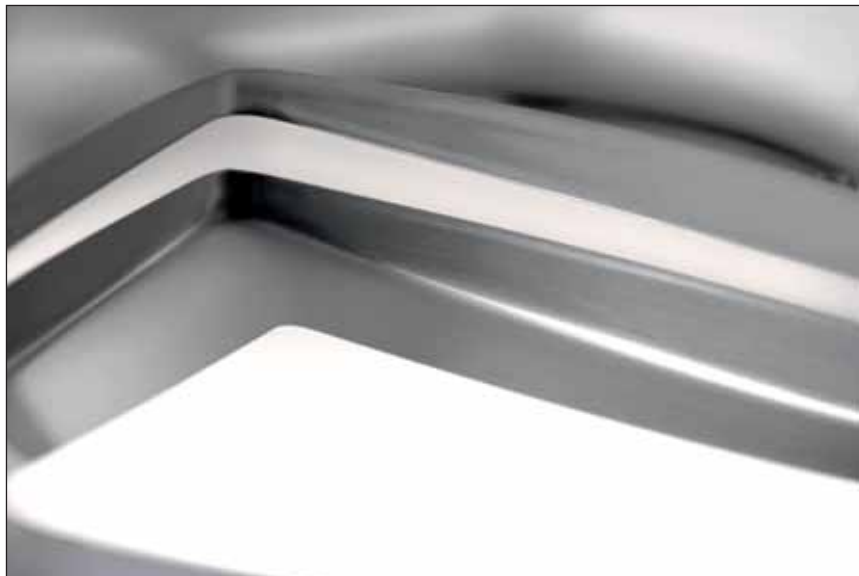

_plafones

_ceiling fixtures

_plafoniers

_deckenleuchten

_plafoniere

MODULO
ELECTRO

www.modulelectro.ru

slight_144

nemo_148

traç_150

troppo_152

escher_156

ona_158

ocho_162

adagio_166

basic_168

square_172

ibis_174

diana_176

moon_177

mini_178

ska_182

quattro_184

slimm_186

adn_188

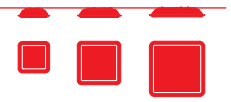

Estructura metálica cuadrada en acabado cromo. Difusor de cristal opal matizado. Disponible en 3 tamaños diferentes. Luz directa e indirecta.

Square metallic body in chrome finish. Matte opal glass diffuser. Available in 3 sizes. Direct and indirect light.

Structure métallique carrée avec finitions chromées. Diffuseur en verre opale teinté. Existe en trois tailles. Lumière directe et indirecte.

Quadratisches Gehäuse aus verchromtem Metall. Diffusor aus mattiertem Opalglas. In 3 Größen lieferbar. Zur direkten und indirekten Beleuchtung.

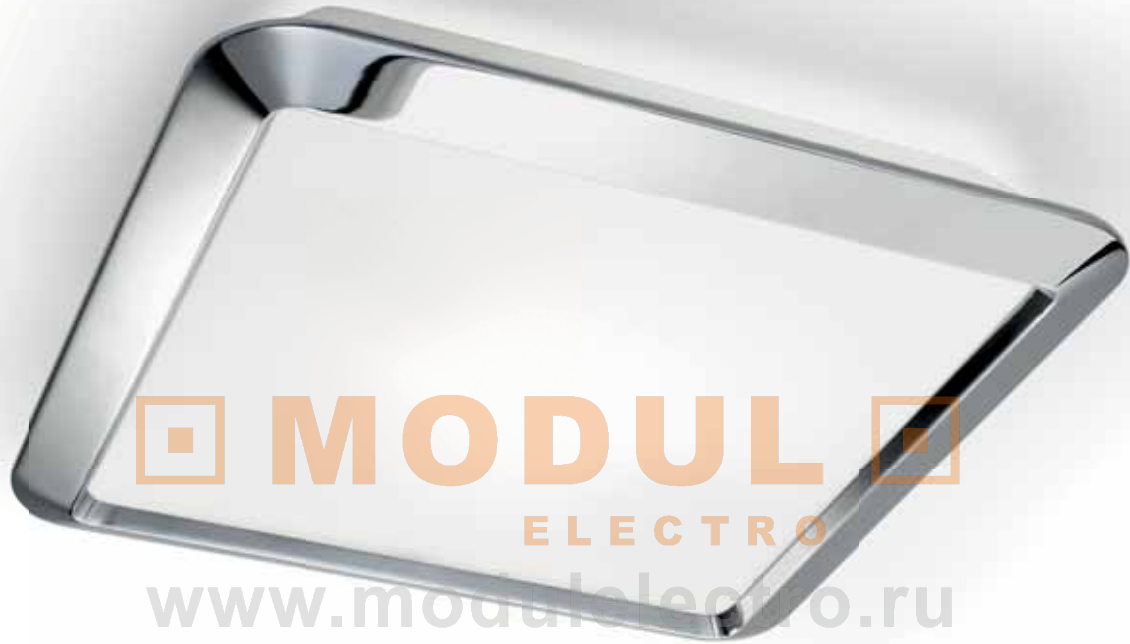

Struttura metallica quadrata con finitura cromata. Diffusore in cristallo opale opacizzato. Disponibile in 3 diverse misure. Luce diretta e indiretta.



		RF 850°C	®
	new		
FE	GLASS OPAL3		
● Cromo 21 Chrome Chrom Cromo	○ Cristal opal triplex Triplex Opal glass F9 Verre opal triplex Optishes Glas Vetro ottico		

15-4318-21-F9
 R7s L=118 Max. 230W
 HALOGEN
 OSRAM included



 **MODUL** 
ELECTRO
www.modulelectro.ru

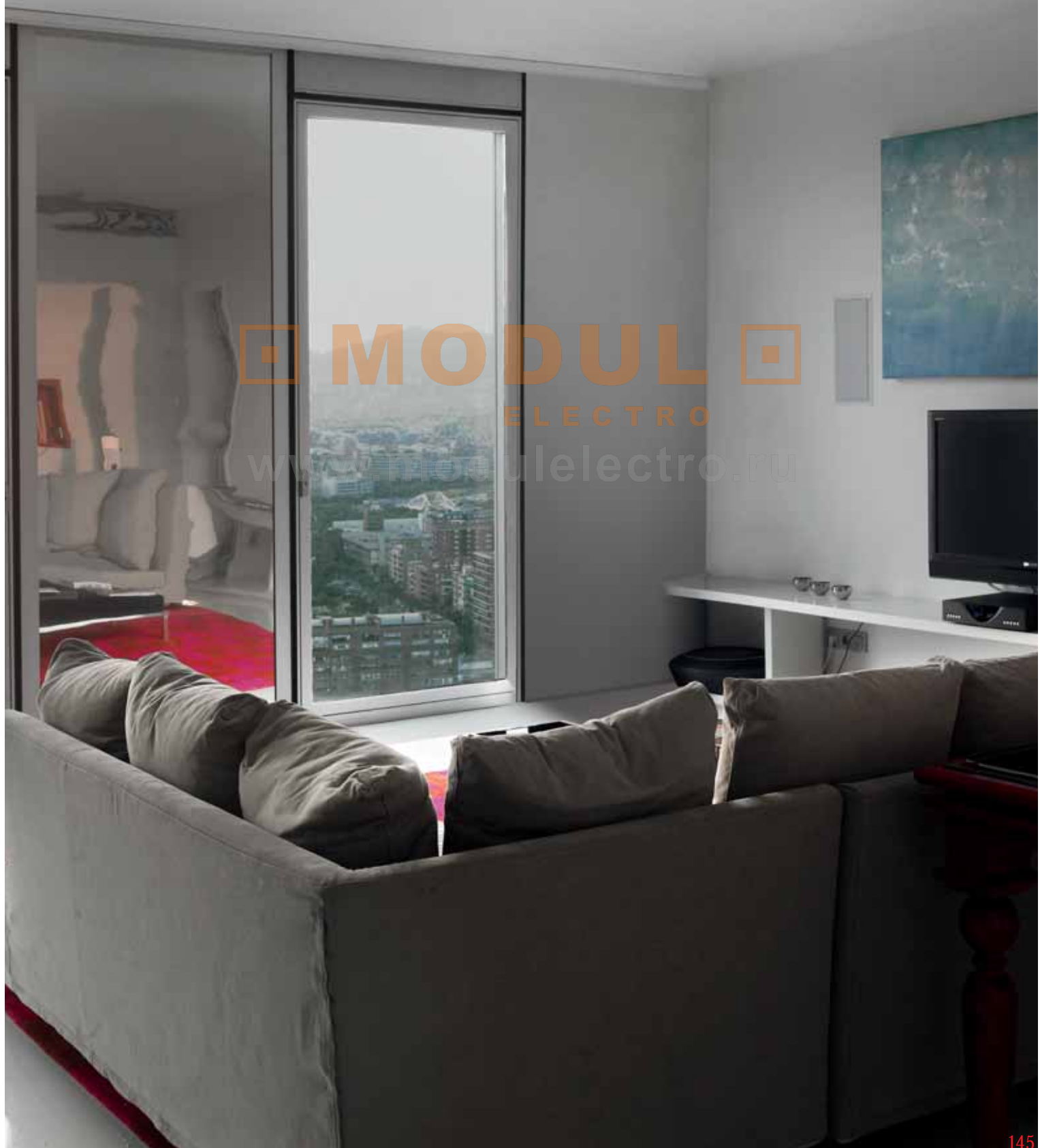

slight

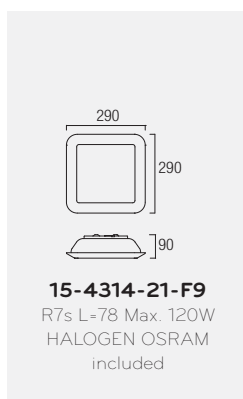
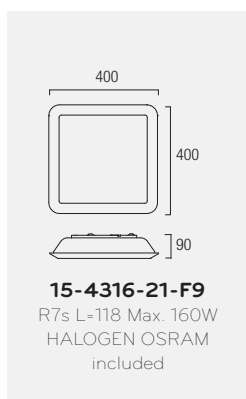



MODUL
ELECTRO
www.modulelectro.ru

Estructura metálica en acabado cromo. Difusor de cristal opal triplex. Luz directa e indirecta.

Chrome metal body. Triplex optical glass diffuser. Direct and indirect light.

Structure métallique avec finitions chromées. Diffuseur en verre opale triplex. Lumière directe et indirecte.

Gehäuse aus verchromtem Metall. Diffusor aus Triplex-Opalglas. Zur direkten und indirekten Beleuchtung.

Struttura metallica con finitura cromata. Diffusore in cristallo opale triplex. Luce diretta e indiretta.



MODULO ELECTRO

www.modulelectro.ru



		RF 850°C	
ZAMAK	GLASS OPAL3		
Cromo Chrome 21 Chrome Chrom Cromo	Cristal opal triplex Triplex Opal glass F9 Verre opal triplex Optishes Glas Vetro ottico		

15-4332-21-F9
R7s L=78 Max. 100W
HALOGEN OSRAM included



MODUL
ELECTRO
www.modulelectro.ru



Estructura de aluminio Ecobright. Reflector metálico disponible en 2 acabados, blanco y pan de plata. Luz principalmente indirecta y en parte directa gracias al difusor de cristal anti-deslumbrante.

Ecobright aluminium body. Metal reflector available in 2 finishes: white and silver leaf. Mainly indirect light and some direct light thanks to an anti-glare glass diffuser.

Structure en aluminium Ecobright. Réflecteur métallique proposé avec deux finitions (en blanc et en argenté). Lumière principalement indirecte, partiellement directe à travers son diffuseur en verre antireflets.

Gehäuse aus Ecobright-Aluminium. Reflektor aus Metall, lieferbar in 2 Ausführungen: weiß und Silberfolie. Direkte Beleuchtung und auch indirekte Beleuchtung durch Diffusor aus entspiegeltem Glas.

Struttura in alluminio Ecobright. Riflettore metallico disponibile in 2 finiture, bianco e foglia d'argento. Luce principalmente indiretta e parzialmente diretta, grazie al diffusore in cristallo anti-abbagliamento.



		RF 850°C	
AL	FE	GLASS MAT	
<p> Blanco</p> <p> White</p> <p>AH Blanc</p> <p> Weiss</p> <p> Bianco</p>	<p> Pan de plata</p> <p> Silver leaf</p> <p>D9 Feuille d'argent</p> <p> Blattsilber</p> <p> Foglia argento</p>		
<p> Cristal anti-deslumbrante</p> <p> Anti-glare glass</p> <p>F1 Verre antiéblouissant</p> <p> Blendfreies Glas</p> <p> Vetro antiriflesso</p>			

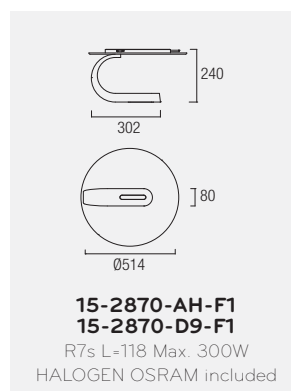



MODUL
ELECTRO
www.modulelectro.ru



tropo

design_ Benedito Design

tropo_collection

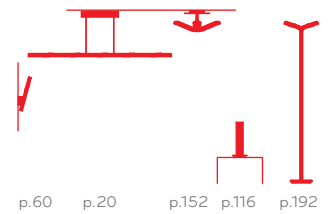

Estructura con 3 brazos de aluminio en acabado cromo. Cristales de borosilicato matizado. Emite luz directa y también indirecta gracias a las aperturas de la parte superior de la estructura.

Chrome aluminium body with 3 arms. Matte borosilicate glass. Provides direct and indirect light thanks to openings at the top of the luminaire.

Structure avec trois bras en aluminium avec finitions chromées. Verre borosilicate teinté. Émet une lumière directe mais aussi indirecte grâce aux ouvertures de la partie supérieure de la structure.

Gehäuse mit 3 Armen aus Aluminium, Oberfläche verchromt. Mattes Borosilikatglas. Direkte Beleuchtung sowie indirekte Beleuchtung durch die Öffnungen an der Oberseite der Leuchte.

Struttura con 3 bracci in alluminio con finitura cromata. Cristalli di borosilicato opacizzato. Emette luce diretta e indiretta, anche grazie alle aperture della parte superiore della struttura.

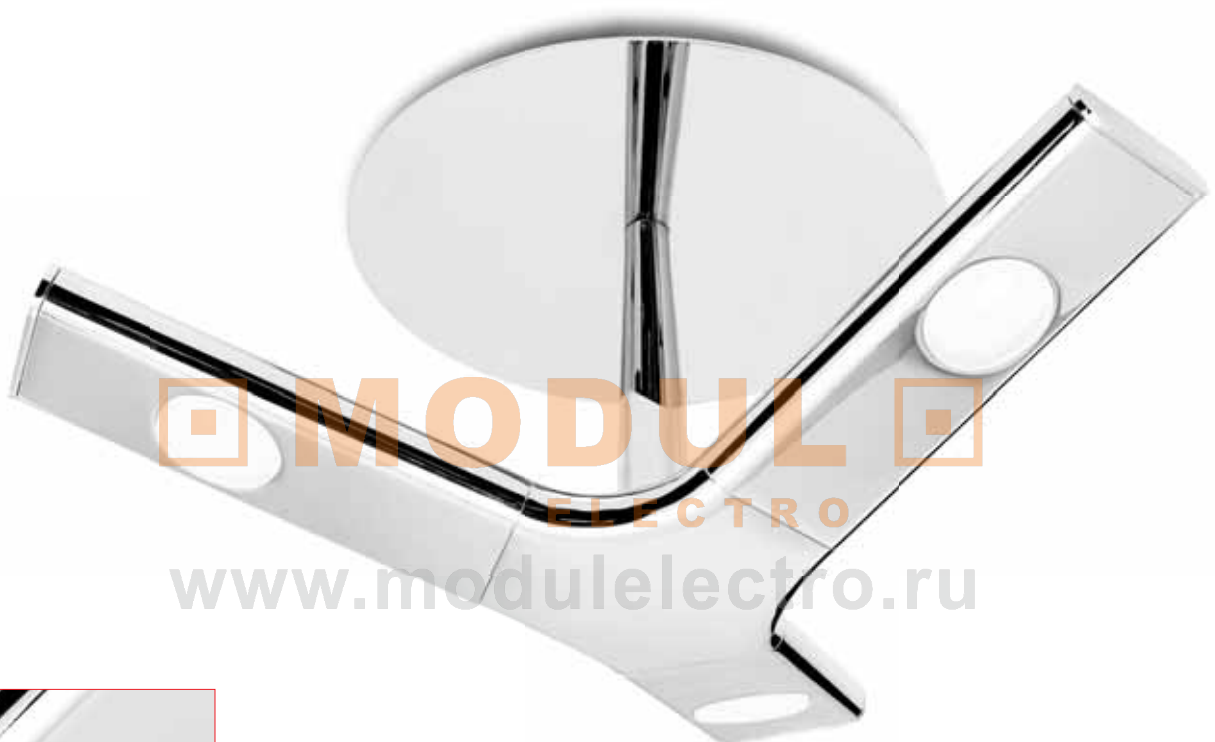

MODUL ELECTRO
www.modulelectro.ru

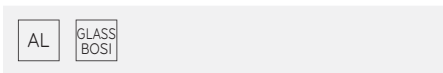
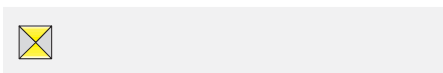

- Cromo / Chrome / Chrom / Cromo
- Cristal anti-deslumbrante / Anti-glare glass / Verre antiéblouissante / Blendfreies Glas / Vetro antiriflesso
- 21** Chrome / Chrom / Cromo
- F1** Verre antiéblouissante / Blendfreies Glas / Vetro antiriflesso

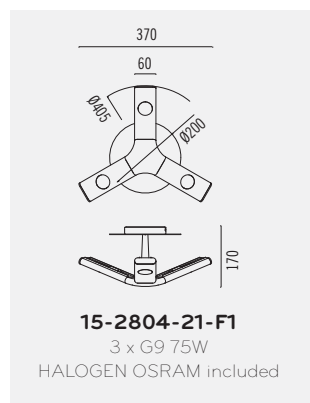

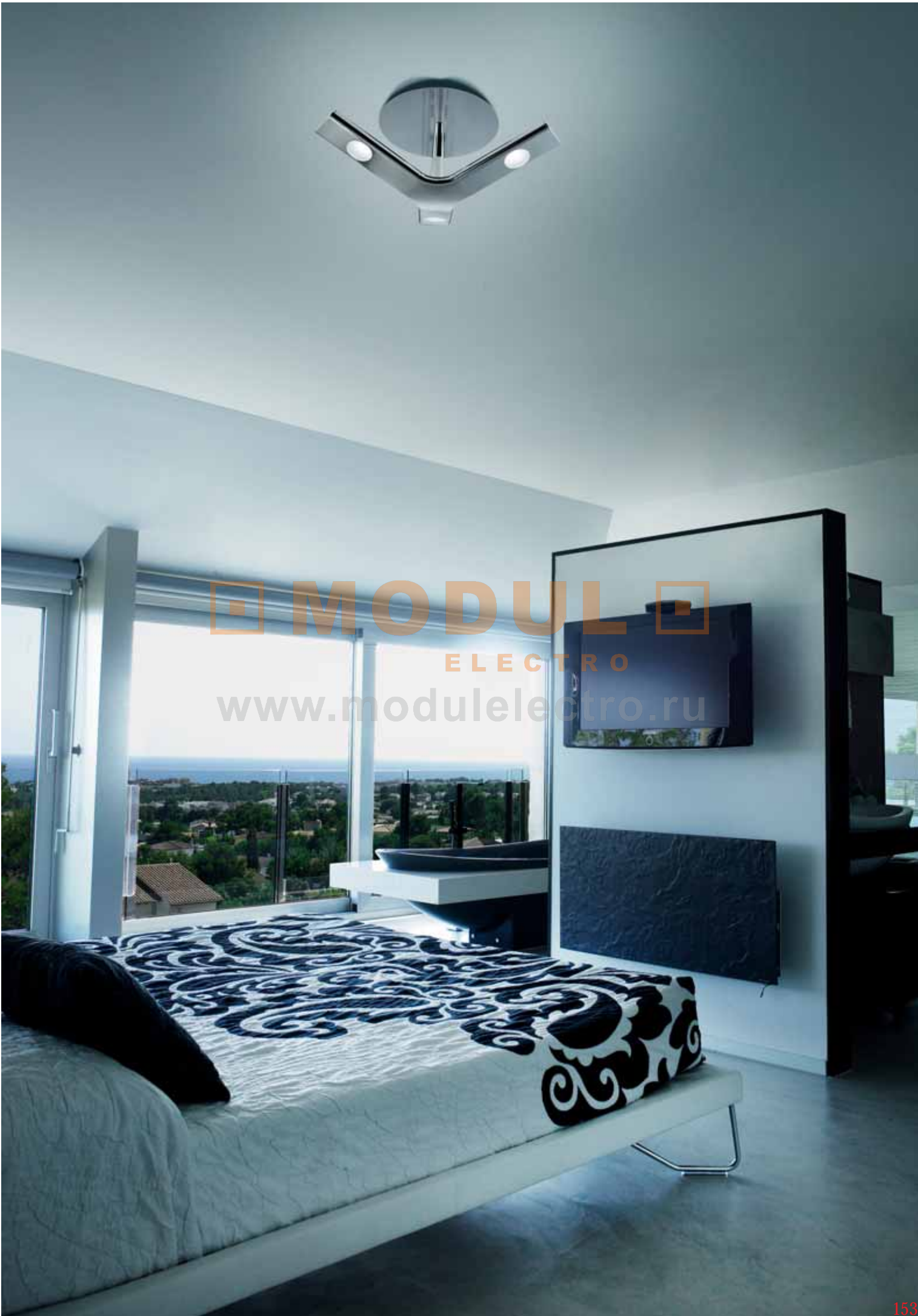

MODUL
ELECTRO
www.modulelectro.ru



MODUL
ELECTRO
www.modulelectro.ru



escher

design _ Josep Patsí

escher_collection

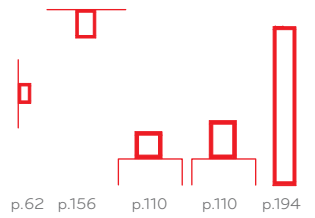

Estructura metálica en 3 acabados disponibles: aluminio Ecobright, lacado blanco y lacado negro. Luz indirecta.

Metal body available in 3 finishes: Ecobright, black lacquer or white lacquer. Indirect light.

Structure métallique proposée avec trois finitions: aluminium Ecobright, verni blanc et verni noir. Lumière indirecte.

Metallgehäuse in 3 Ausführungen lieferbar: Ecobright-Aluminium, weiß lackiert und schwarz lackiert. Indirekte Beleuchtung.

Struttura metallica disponibile con 3 finiture: alluminio Ecobright, laccato bianco e laccato nero. Luce indiretta.

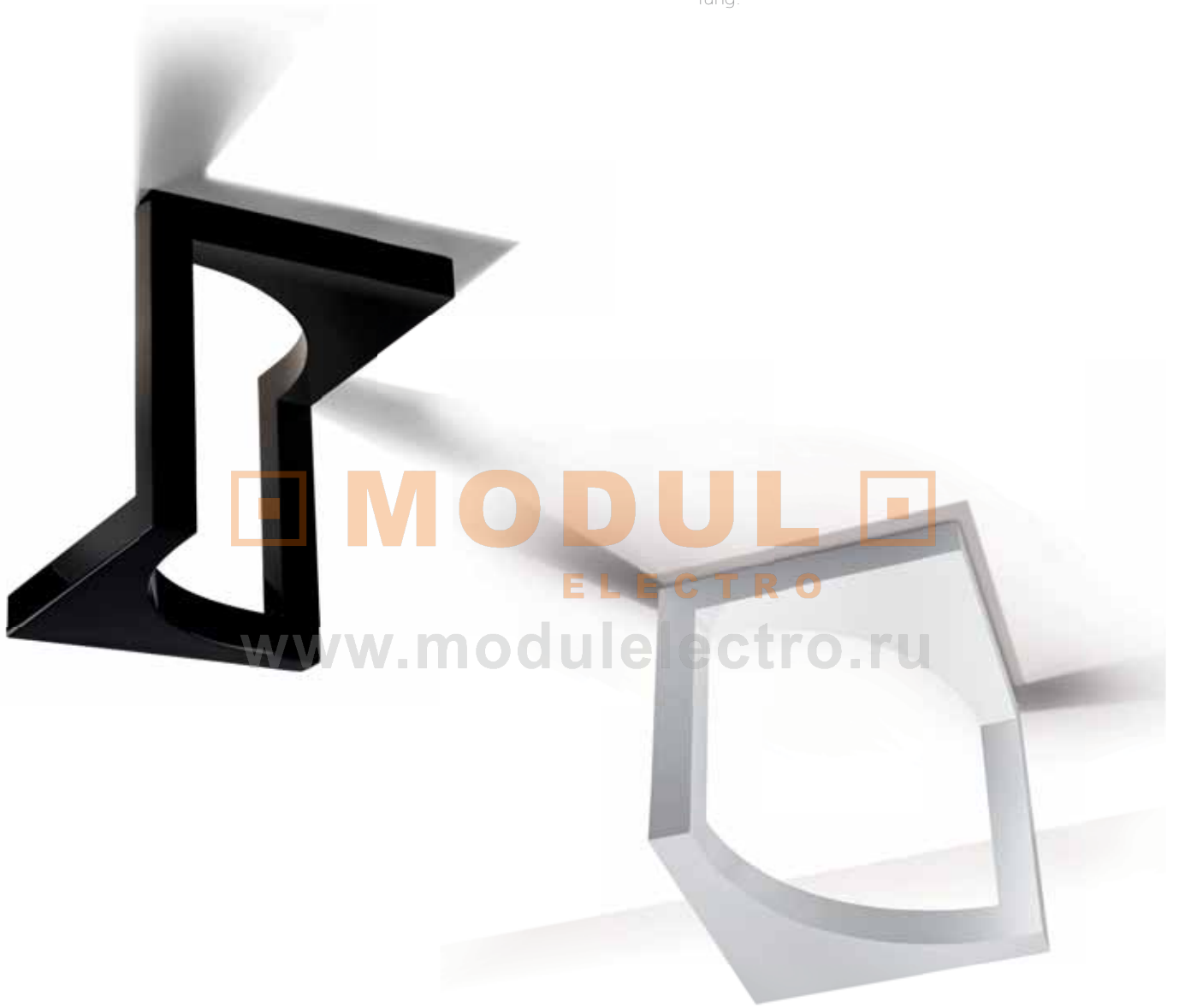

FE

● Aluminio Ecobright
Ecobright aluminium
AH Aluminium Ecobright
Ecobright aluminium
Alluminio Ecobright

● Lacado negro
Black lacquered
05 Laqué en noir
Schwarz lackiert
Laccato nero

○ Lacado blanco
White lacquered
78 Laqué en blanc
Weiss lackiert
Laccato bianco

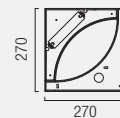

15-2782-AH-AH
15-2782-05-05
15-2782-78-78

R7s L=118 Max. 300W
HALOGEN OSRAM included

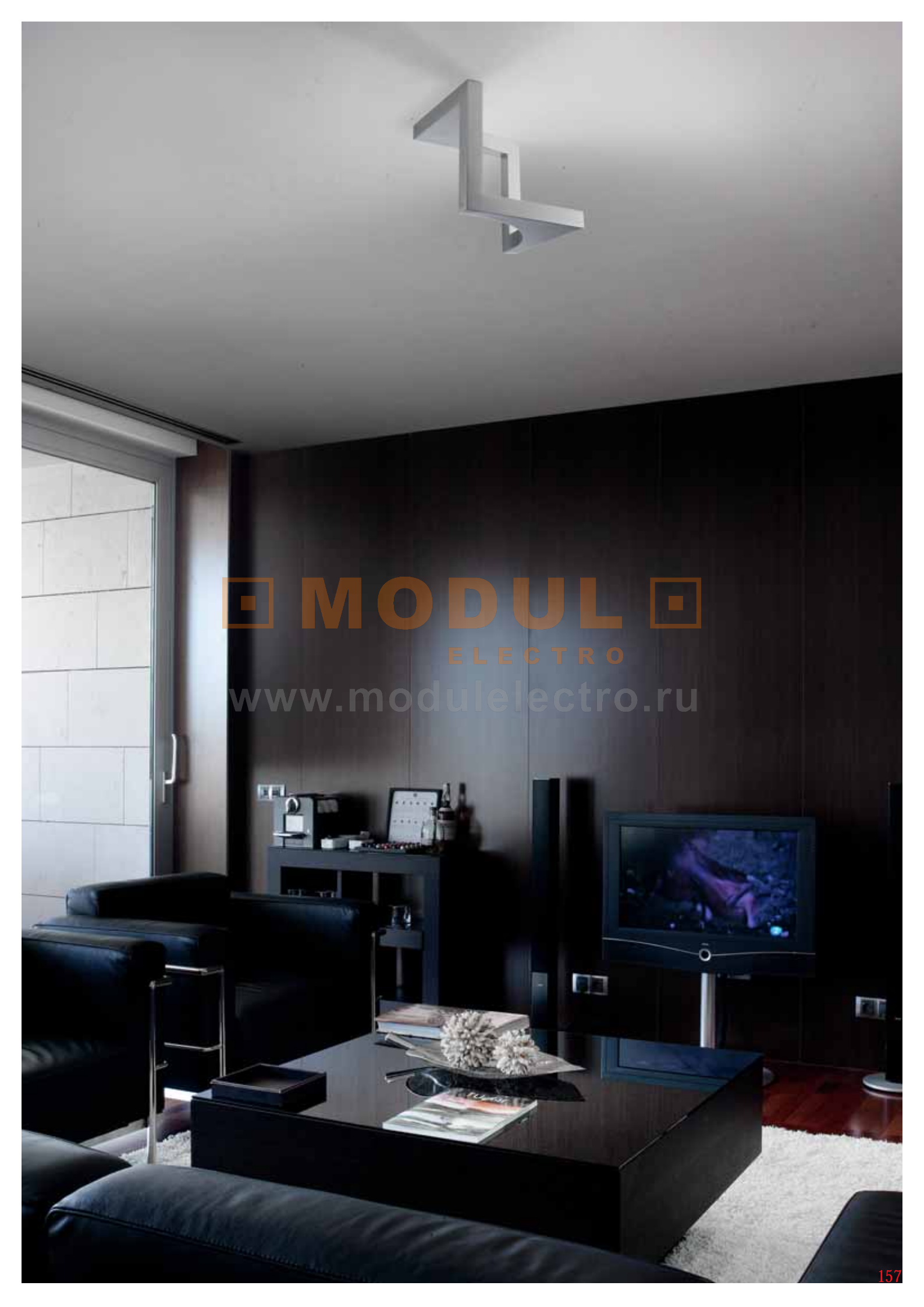

MODUL
ELECTRO
www.modulelectro.ru



Estructura de aluminio pulido y satinado. Difusor de metacrilato matizado. Disponible en 3 tamaños: 44cm, 60cm y 80cm. Luz directa.

Polished and satin aluminium body. Matte methacrylate diffuser. Available in 3 sizes: 44cm, 60cm and 80cm. Direct light.

Structure en aluminium poli et satiné. Diffuseur en méthacrylate teinté. Proposée en trois largeurs: 44 cm, 60 cm et 80 cm. Lumière directe.

Gehäuse aus poliertem und satiniertem Aluminium. Diffusor aus mattiertem Plexiglas. In 3 Größen lieferbar: 44 cm, 60 cm und 80 cm. Direkte Beleuchtung.

Struttura in alluminio, lucido satinato. Diffusore in metacrilato opacizzato. Disponibile in 3 misure: 44 cm, 60 cm e 80 cm. Luce diretta.



S2  Aluminio pulido y satinado
Polished and burnished aluminium
Aluminium poli et satiné
Aluminium poliert und mattglänzend
Alluminio lucidato e satinato

M1  Difusor policarbonato opal
Opal polycarbonate diffuser
Diffuseur polycarbonate opale
Polykarbonatdiffusor Opal
Diffusore in policarbonato opalino

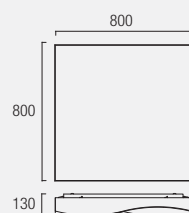

15-2781-S2-M1
2G11 4x55W
ENERGY SAVING
included

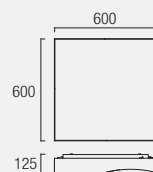

15-2780-S2-M1
2G11 4x36W
ENERGY SAVING
included



15-2779-S2-M1
T5 FC 22W+40W
ENERGY SAVING
included



MODUL

ELECTRO

www.modulelectro.ru

ona



MODUL
ELECTRO
www.modulelectro.ru





MODUL
ELECTRO
www.modulelectro.ru





Estructura de poliuretano en acabado blanco mate. Difusor de metacrilato matizado. Disponible en versión de una, dos y cuatro luces, ésta última con sistema de doble iluminación independiente. Luz directa.

Matte-white polyurethane body. Matte methacrylate diffuser. Available in one, two or four lamp versions. Four-lamp version with independent double lighting system. Direct light.

Structure en polyuréthane avec finitions en blanc mat. Diffuseur en méthacrylate teinté. Proposée en déclinaisons d'une, deux et quatre lumières, cette dernière incluant un système de double éclairage indépendant. Lumière directe.

Gehäuse aus Polyurethan, Oberfläche mattweiß. Diffusor aus mattiertem Plexiglas. Lieferbar mit einer, zwei und vier Lampen. 4er Ausführung mit unabhängiger Doppelbeleuchtung. Direkte Beleuchtung.

Struttura in poliuretano con finitura bianco opaco. Diffusore in metacrilato opacizzato. Disponibile in versione da una, due e quattro luci. Quest'ultima è dotata di un sistema a doppia illuminazione indipendente. Luce diretta.

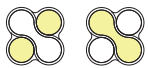
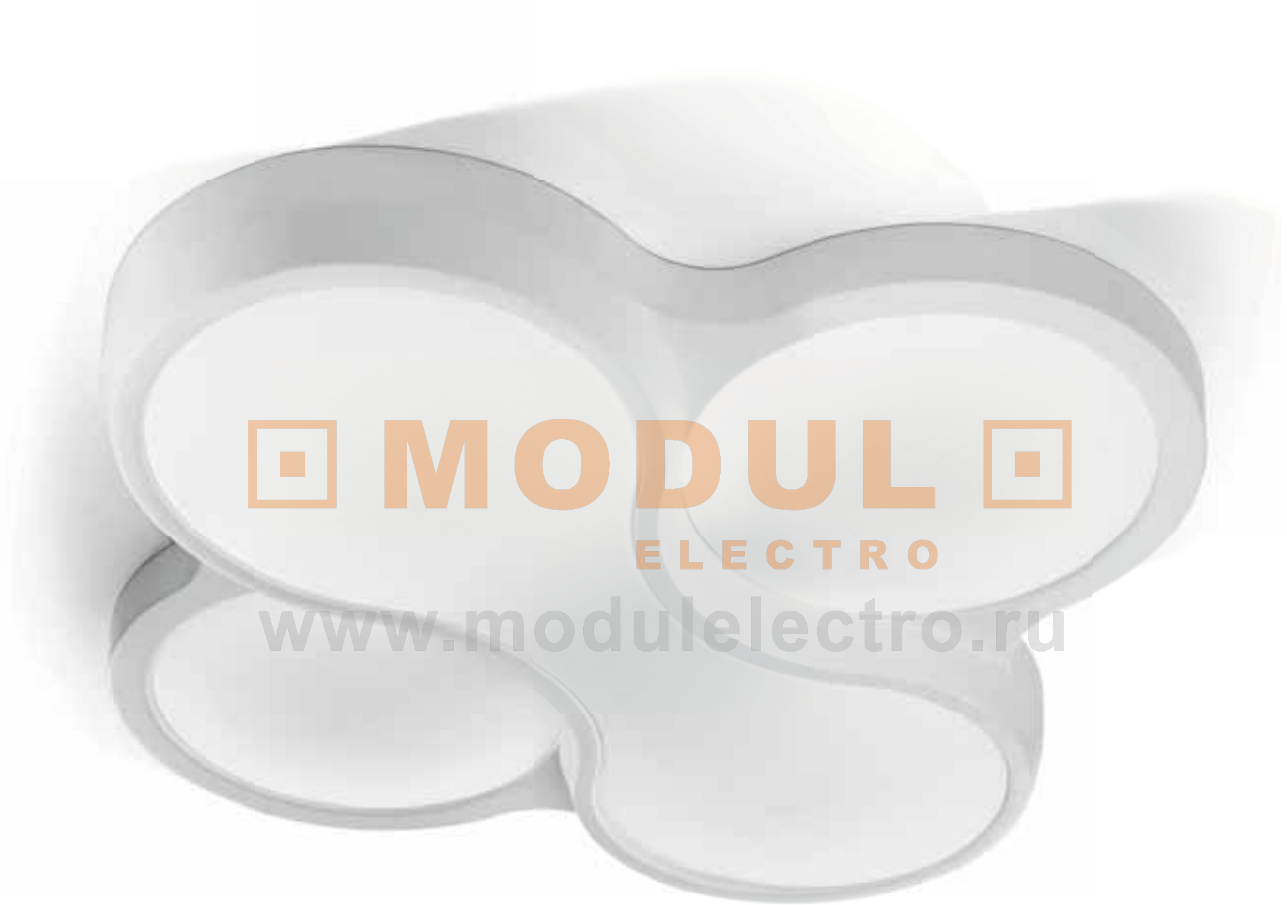

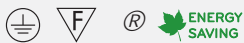

Sistema de doble iluminación independiente
Independent double lighting system

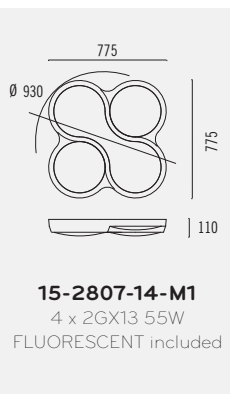

- | | |
|------------------------------------|--|
| ○ Blanco
White | ○ Difusor policarbonato opal
Opal polycarbonate diffuser |
| 14 Blanc
Weiss
Bianco | M1 Diffuseur polycarbonate opale
Polykarbonatdiffusor Opal
Diffusore in policarbonato opalino |





 **MODUL** 
ELECTRO
www.modulelectro.ru





MODUL
ELECTRO

www.modulelectro.ru



15-2805-14-M1
2GX13 55W
FLUORESCENT included

15-2806-14-M1
2 x 2GX13 55W
FLUORESCENT included

 **MODUL** 
ELECTRO

www.modulelectro.ru

adagio

design _ Josep Patsí

adagio_collection

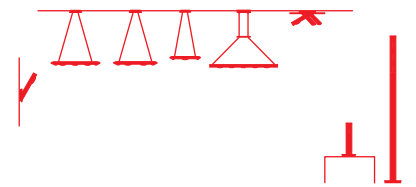

p.68 p.38 p.39 p.38 p.36 p.166 p.118 p.209

Estructura con 3 brazos de aluminio y difusores de cristal anti-deslumbrante. Disponible en acabados cromo y aluminio pulido satinado. Emite luz directa y también indirecta gracias a las aperturas en la parte posterior de los brazos.

Aluminium body with 3 arms and anti-glare glass diffusers. Available in chrome or polished and satin aluminium. Provides direct and indirect light thanks to openings on the back of the arms.

Structure dotée de trois bras en aluminium et diffuseurs en verre antireflets. Proposée avec des finitions chromées et en aluminium poli satiné. Émet une lumière directe mais aussi indirecte grâce aux ouvertures derrière les bras.

Gehäuse mit 3 Armen aus Aluminium und Diffusore aus entspiegeltem Glas. Verchromt und in poliertem satiniertem Aluminium lieferbar. Direkte Beleuchtung sowie indirekte Beleuchtung durch die Öffnungen an der Rückseite der Arme.

Struttura con 3 bracci in alluminio e diffusori in cristallo anti-abbagliamento. Disponibile con finitura in cromo e alluminio lucido satinato. Emette luce diretta e indiretta, anche grazie alle aperture nella parte posteriore dei bracci.



⚡ F RF 850°C



AL GLASS MAT

● 21 Cromo
Chrome
Chrom
Cromo

● S3 Aluminio pulido y satinado
Polished and burnished aluminium
Aluminium poli et satiné
Aluminium poliert und mattglänzend
Alluminio lucidato e satinato

○ F1 Cristal anti-deslumbrante
Anti-glare glass
Verre antiéblouissante
Blendfreies Glas
Vetro antiriflesso

155

∅ 405

15-0221-21-F1
15-0221-S3-F1

3 x G9 Max. 75W 230V
HALOGEN OSRAM included



MODUL
ELECTRO
www.modulselectro.ru

basic

design _ Josep Patsí

basic_collection



p.168 p.168 p.168 p.171 p.171 p.171 p.170 p.170

Estructura metálica. Difusor de cristal óptico. 3 versiones con difusor circular y 3 versiones con difusor cuadrado, disponibles en cromo y en níquel satinado. Luz directa e indirecta.

Metal body. Optical glass diffuser. 3 different size versions with circular diffuser and 3 different size versions with square diffuser, available in chrome and satin nickel. Direct and indirect light.

Structure métallique. Diffuseur en verre optique. Trois versions dotées d'un diffuseur circulaire, et trois autres versions avec diffuseur carré, proposées en chrome et en nickel satiné. Lumière directe et indirecte.

Metallgehäuse. Diffusor aus mattem Optikglas. 3 Ausführungen mit kreisförmigem Diffusor, in verschiedenen Größen, alle verchromt. 3 Ausführungen mit quadratischem Diffusor, in verschiedenen Größen, und die 2 quadratischen. Zur direkten und indirekten Beleuchtung.

Struttura metallica. Diffusore in cristallo ottico. 3 versioni con diffusore circolare, et 3 versioni con diffusore quadrato, disponibili in cromo e in nichel satinato. Luce diretta e indiretta.

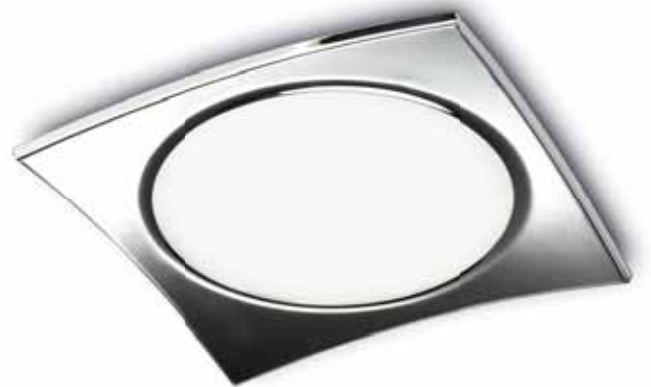

- Cromo / Chrome / Chrom / Cromo
- Níquel Satinado / Satin nickel / Nickel satiné / Nickel matt / Nichel satinato

- Cristal óptico / Optic glass / Verre optique / Optisches Glas / Vetro ottico

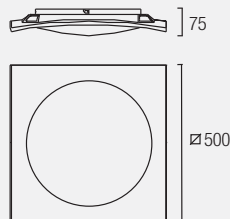

15-2393-21-E9 (S)
R7s L=118 Max. 300W
HALOGEN OSRAM included

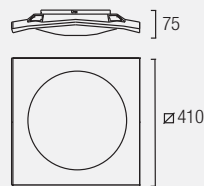

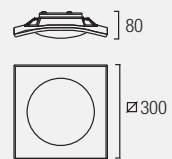

15-2391-21-E9
R7s L=118 Max. 200W
HALOGEN OSRAM included



15-2390-21-E9
R7s L=78 Max. 150W
HALOGEN OSRAM included





 **MODUL** 
ELECTRO
www.modulelectro.ru



MODUL

ELECTRO

www.modulelectro.ru



VISTA LATERAL 15-2388
SIDE VIEW 15-2388



VISTA LATERAL 15-2389
SIDE VIEW 15-2389

15-2388-21-B9
15-2388-81-B9
R7s L=118 Max. 300W
HALOGEN OSRAM included

15-2389-21-B9
4 x 2G11 Max. 24W
ENERGY SAVING included



MODUL
ELECTRO
www.modulelectro.ru

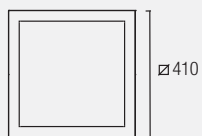
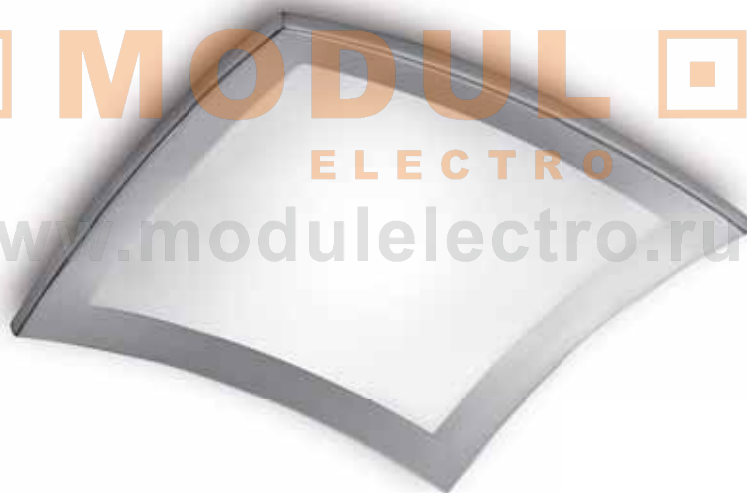

15-2386-21-B9
15-2386-81-B9
R7s L=118 Max. 200W
HALOGEN OSRAM included

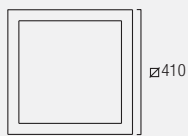

15-2387-21-B9
4 x 2G11 Max. 18W
ENERGY SAVING included

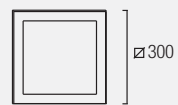

15-2385-21-B9
15-2385-81-B9
R7s L=78 Max. 150W
HALOGEN OSRAM included



square

design _ Toni Dias

square_collection



Estructura cuadrada de aluminio pulido y satinado. Difusor acrílico opal. Disponible en 3 tamaños diferentes. Luz directa.

Square polished and satin aluminium body. Opal acrylic diffuser Available in 3 sizes. Direct light.

Structure carrée en aluminium poli et satiné. Diffuseur acrylique opale. Existe en trois tailles. Lumière directe.

Quadratisches Gehäuse aus poliertem und satinierem Aluminium. Diffusor Opal-Acryl. In 3 Größen lieferbar. Direkte Beleuchtung.

Struttura quadrata in alluminio, lucido satinato. Diffusore acrilico opale. Disponibile in 3 diverse misure. Luce diretta.

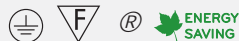
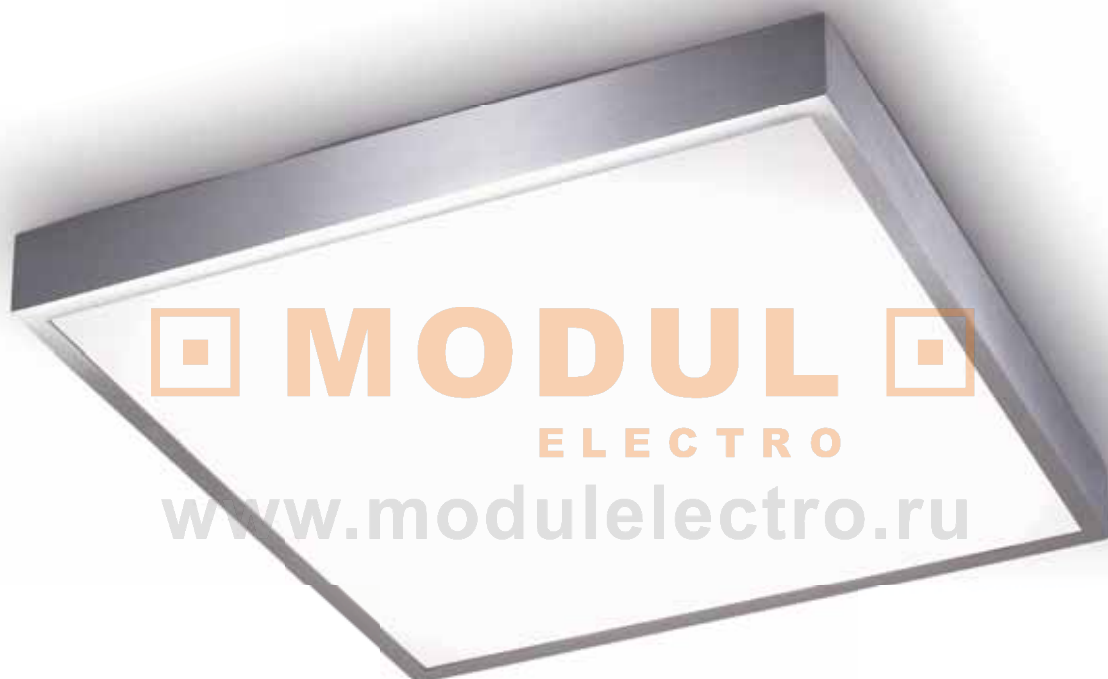

S2 ● Aluminio pulido y satinado
Polished and burnished aluminium
Aluminium poli et satiné
Aluminium poliert und mattglänzend
Alluminio lucidato e satinato

M1 ○ Difusor acrílico opal
Opal acrylic diffuser
Diffuseur acrylique opale
Kunststoff - Reflektor
Diffusore acrilico opalino

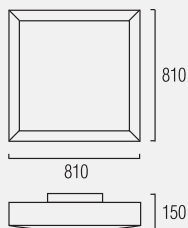

15-0592-S2-M1
4 x 2G11 55W
ENERGY SAVING included

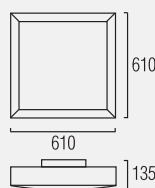

15-0591-S2-M1
4 x 2G11 36W
ENERGY SAVING included

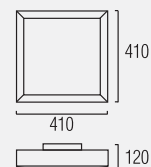

15-0590-S2-M1
4 x 2G11 18W
ENERGY SAVING included

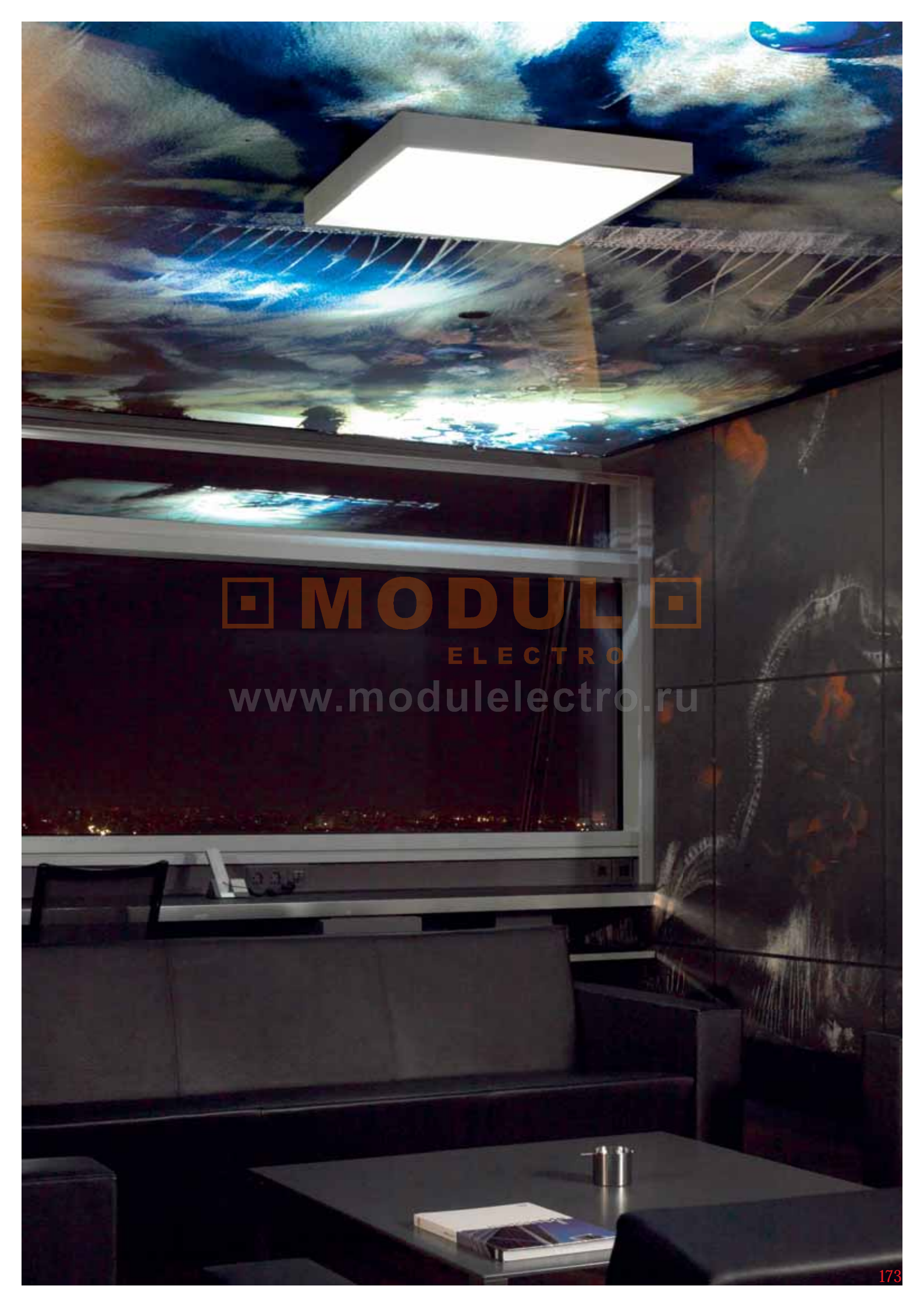

MODUL
ELECTRO
www.modulelectro.ru



Estructura metálica en acabado níquel satinado y reflector de color blanco. Disponible en 4 tamaños diferentes. Luz indirecta.

Satin nickel body and white reflector. Available in 4 sizes. Indirect light.

Structure métallique avec finitions en nickel satiné et un réflecteur blanc. Existe en quatre tailles. Lumière indirecte.

Metallgehäuse in satiniertem Nickel und Reflektor in Weiß. In 4 Größen lieferbar. Indirekte Beleuchtung.

Struttura metallica con finitura nichel satinata e riflettore in colore bianco. Disponibile in 4 diverse misure. Luce indiretta.

MODULO
ELECTRO
www.modulelectro.ru

FE

Níquel Satinado
Satin nickel
81 Nickel satiné
Nickel matt
Nichel satinato

IBIS C/47-81
R7s L=118 Max. 300W
HALOGEN OSRAM
included

IBIS C/37-81
R7s L=118 Max. 200W
HALOGEN OSRAM
included

IBIS C/27-81
R7s L=78 Max. 150W
HALOGEN OSRAM
included

IBIS C/17-81
G9 Max. 75W 230V
HALOGEN OSRAM
included



MODUL
ELECTRO
www.modulelectro.ru

diana

design _ Benedito Design

Estructura de aluminio disponible en acabados cromo y níquel satinado. Difusor de vidrio templado extrablanco. Luz directa e indirecta.

Aluminium body available in chrome or satin nickel. Extra-white tempered glass diffuser. Direct and indirect light.

Structure en aluminium proposée avec finitions chromées et en nickel satiné. Diffuseur en verre délicat extra blanc. Lumière directe et indirecte.

Aluminiumgehäuse lieferbar in Chrom und satinier-tem Nickel. Diffusor aus extraweißem Milchglas. Zur direkten und indirekten Beleuchtung.

Struttura in alluminio disponibile con finitura cromata e nichel satinato. Diffusore in vetro temperato extrabianco. Luce diretta e indiretta.



MODULO
ELECTRO
www.modulelectro.ru



- | | |
|--|---|
| ● Cromo
Chrome
21 Chrom
Cromo | ● Níquel Satinado
Satin nickel
81 Nickel satiné
Nickel matt
Nichel satinato |
|--|---|

- | |
|--|
| ○ Vidrio templado extrablanco
Extra white tempered glass
E9 Verre tempérant extra blanc
Ätzmattes neutral Glas gehärtet
Vetro extra bianco temperato |
|--|

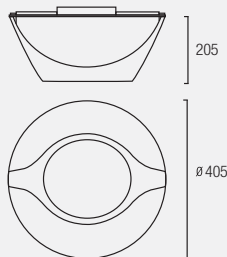

15-0562-21-E9
15-0562-81-E9
R7s L=118 Max. 300W
HALOGEN OSRAM included



Estructura de aluminio y reflector de hierro. Disponibles 2 versiones: una en acabado cromo con reflector acabado en aluminio mate y otra en acabado níquel satinado con reflector blanco. Luz indirecta y parcialmente directa.

Aluminium body and iron reflector. Available in 2 versions: chrome finish with matte aluminium reflector and satin nickel finish with white reflector. Indirect and partial direct light.

Structure en aluminium et réflecteur en fer. Existe en deux déclinaisons : l'une présente des finitions en chrome, livrée avec son réflecteur avec finitions en aluminium mat, et l'autre possède des finitions en nickel satiné, avec réflecteur blanc. Lumière indirecte et partiellement directe.

Aluminiumgehäuse und Reflektor aus Eisen. In zwei Ausführungen lieferbar: Ausführung mit verchromter Oberfläche mit Reflektor in mattem Aluminium oder mit Oberfläche in satiniertem Nickel mit weißem Reflektor. Indirekte Beleuchtung und teilweise direkte Beleuchtung.

Struttura in alluminio e riflettore in ferro. Disponibile in 2 versioni: una con finitura cromata e riflettore con finitura in alluminio opaco e l'altra con finitura in nickel satinato con riflettore in colore bianco. Luce indiretta e parzialmente diretta.



MODULO ELECTRO
www.moduloelectro.ru

Chrome 21 Chrome Chrom Cromo	Níquel Satinado Satin nickel 81 Nickel satiné Nickel matt Nichel satinato		

15-2138-21-21
15-2138-81-81
R7s L=118 Max. 200W
HALOGEN OSRAM included



mini

design _ Josep Patsí

mini_collection



p.178 p.178 p.180 p.180

Estructura metálica en acabado níquel satinado. Difusor frontal de cristal óptico y perimetral de policarbonato. Disponible en 2 tamaños, ambos en versión cuadrada y circular. Luz directa e indirecta.

Satin nickel metal body. Front optical glass diffuser and polycarbonate perimeter. Available in 2 sizes, both in square and circular versions. Direct and indirect light.

Structure métallique avec finitions en nickel satiné. Diffuseur frontal en verre optique et diffuseur périmétral en polycarbonate. Existe en deux tailles et en déclinaisons carrée et circulaire. Lumière directe et indirecte.

Metallgehäuse in satiniertem Nickel. Diffusor an Vorderseite aus Optikglas und Diffusor rund um die Leuchte aus Polycarbonat. In 2 Größen lieferbar, beide quadratisch und kreisförmig. Zur direkten und indirekten Beleuchtung.

Struttura metallica con finitura nichel satinato. Diffusore frontale in cristallo ottico e perimetrale in polycarbonato. Disponibile in 2 versioni, entrambe in versione quadrata e circolare. Luce diretta e indiretta.

**MODULO**
ELECTRO
www.modulelectro.ru

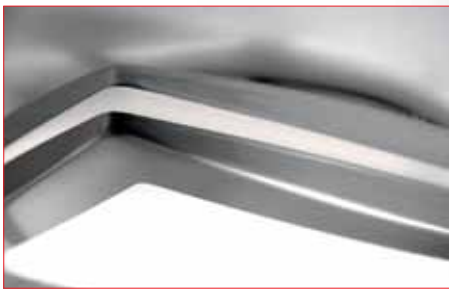

● Níquel Satinado
Satin nickel
81 Nickel satiné
Nickel matt
Nichel satinato

○ Cristal óptico
Optic glass
E9 Verre optique
Optishes Glas
Vetro ottico

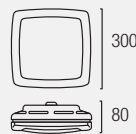

15-0258-81-E9
R7s L=118 Max. 200W
HALOGEN OSRAM included



15-0223-81-E9
R7s L=78 Max. 100W
HALOGEN OSRAM included

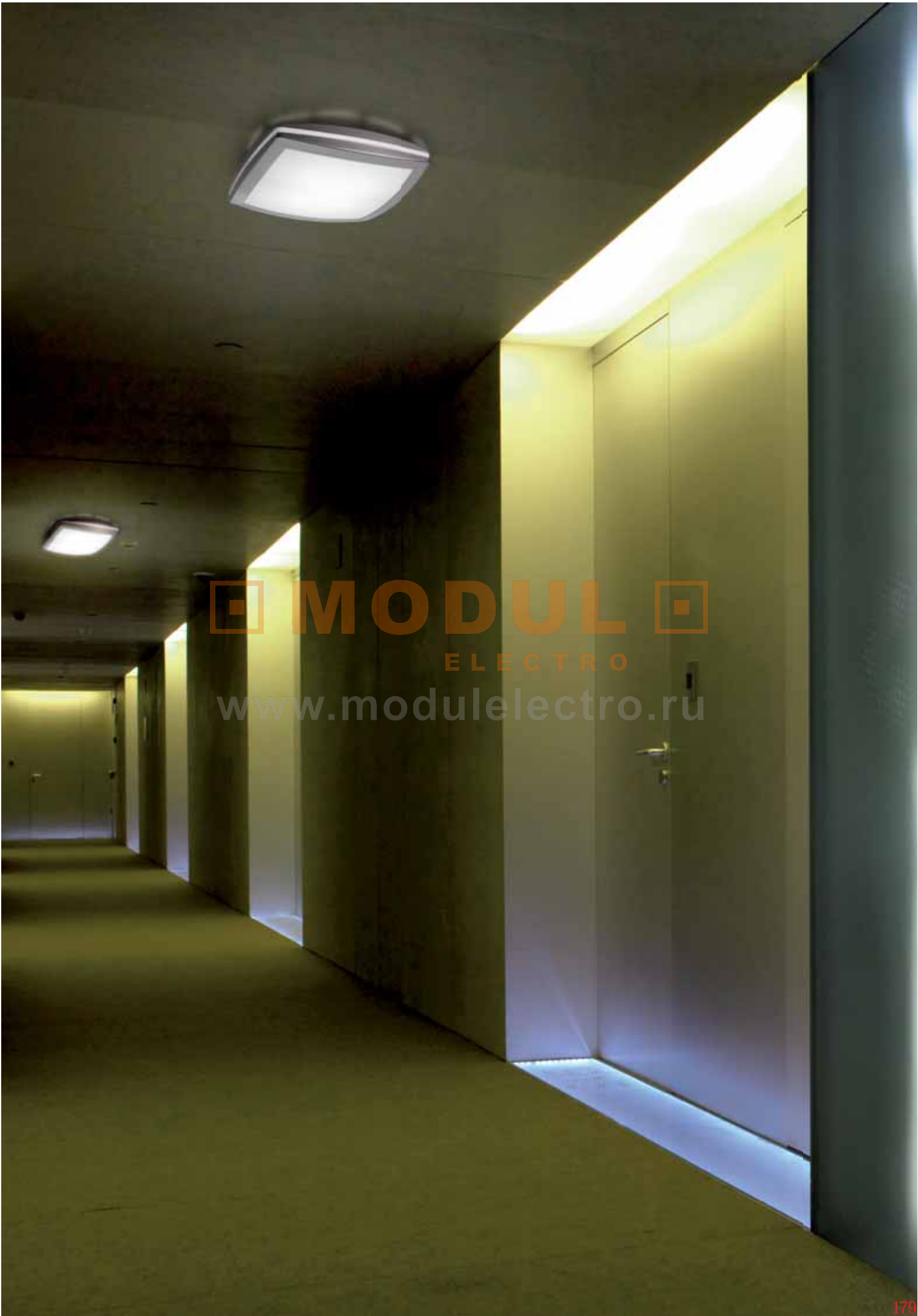

MODUL
ELECTRO
www.modulelectro.ru

mini



MODUL
ELECTRO

www.modulelectro.ru

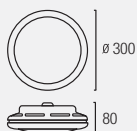

15-0256-81-E9

R7s L=118 Max. 200W
HALOGEN OSRAM included

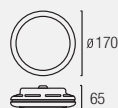

15-0222-81-E9

R7s L=78 Max. 100W
HALOGEN OSRAM included

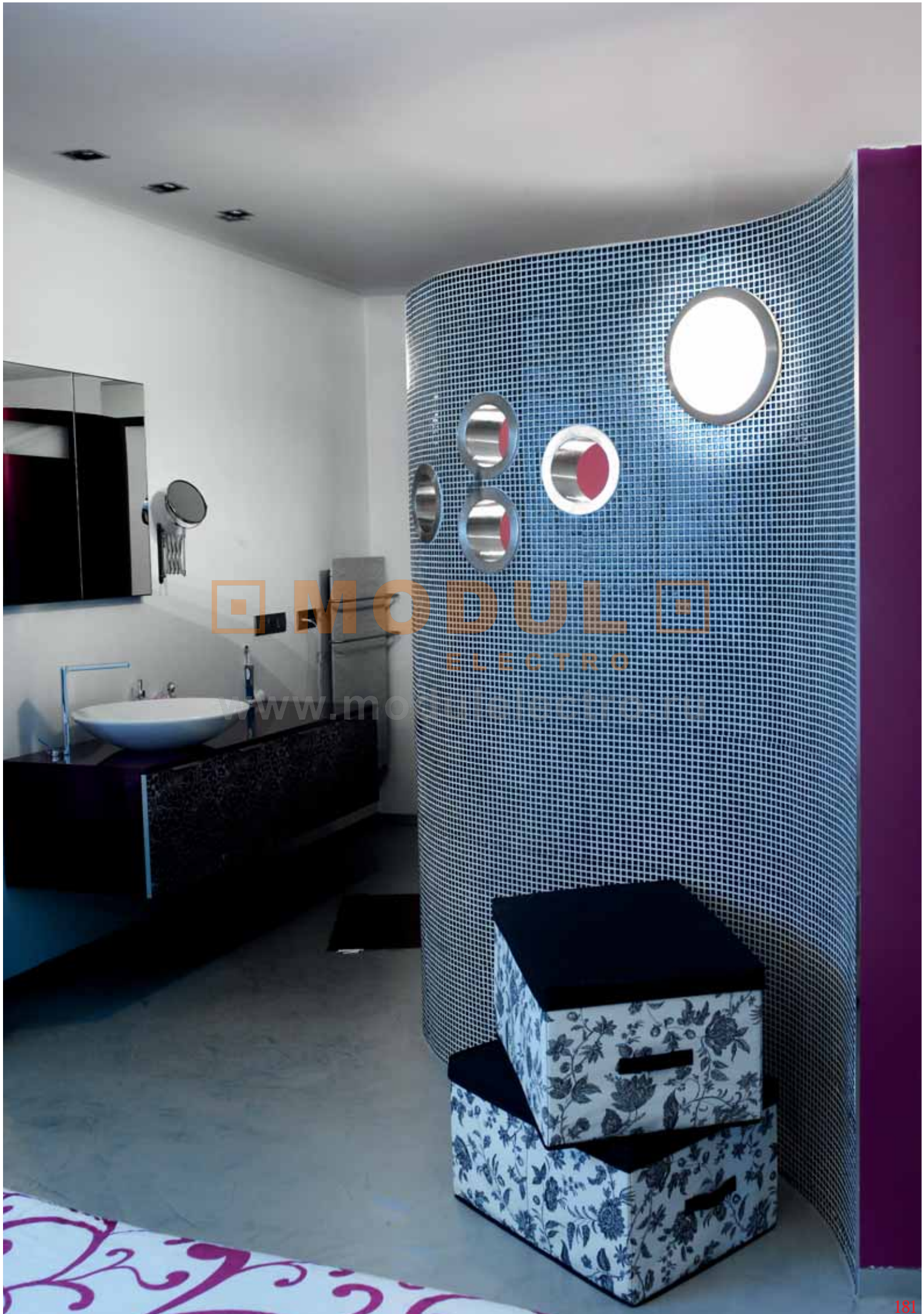

MODULI
LUMINOSI

www.moduli.it

ska

design _ Josep Patsí

ska_collection



Estructura cuadrada metálica en acabado níquel satinado y disponible en 4 tamaños diferentes. Difusor de cristal óptico. Sistema de apertura abatible en todas las versiones (excepto en la de menor tamaño). Luz directa e indirecta.

Square metal body in satin nickel finish and available in 4 different sizes. Optical glass diffuser. Hinged opening system in all versions (except smallest). Direct and indirect light.

Structure carrée métallique avec finitions en nickel satiné. Existe en quatre tailles. Diffuseur en verre optique. Système d'ouverture inclinable pour toutes les versions (sauf celle de taille inférieure). Lumière directe et indirecte.

Quadratisches Gehäuse aus Metall mit Oberfläche in satiniertem Nickel. Diffusor aus mattem Optikglas. Kippsystem zum Öffnen bei allen Ausführungen (außer bei der kleinsten Größe). Zur direkten und indirekten Beleuchtung.

Struttura quadrata metallica, con finitura in nichel satinato. Diffusore in cristallo ottico. Sistema di apertura a scomparsa in tutte le versioni (ad eccezione di quella più piccola). Luce diretta e indiretta.

MODUL
ELECTRO
www.modulelectro.ru



<p>● Níquel Satinado Satin nickel</p> <p>81 Nickel satiné Nickel matt Nichel satinato</p>	<p>○ Cristal óptico Optic glass</p> <p>E9 Verre optique Optisches Glas Vetro ottico</p>	

15-0159-81-E9
R7s L=118 Max. 300W
HALOGEN OSRAM included

15-0158-81-E9
R7s L=118 Max. 200W
HALOGEN OSRAM included

15-2575-81-E9
3 x G24d-2 18W
ENERGY SAVING

15-0157-81-E9
R7s L=118 Max. 150W
HALOGEN OSRAM included

15-0318-81-E9
G9 Max. 75W 230V
HALOGEN OSRAM included



MODUL
ELECTRO
www.modul-electro.ru



Estructura metálica en acabado níquel satinado. Difusor de cristal óptico. Disponible en 3 tamaños diferentes. Luz directa e indirecta.

Satin nickel metal body. Optical glass diffuser. Available in 3 sizes. Direct and indirect light.

Structure métallique avec finitions en nickel satiné. Diffuseur en verre optique. Existe en trois tailles. Lumière directe et indirecte.

Metallgehäuse in satiniertem Nickel. Diffusor aus mattem Optikglas. In 3 Größen lieferbar. Zur direkten und indirekten Beleuchtung.

Struttura metallica con finitura nichel satinato. Diffusore in cristallo ottico. Disponibile in 3 diverse misure. Luce diretta e indiretta.

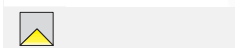

● Níquel Satinado
Satin nickel
81 Nickel satiné
Nickel matt
Nichel satinato

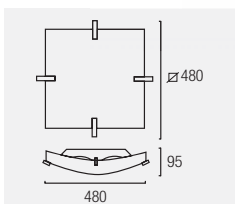

15-0079-81-B5

R7s L=118 Max. 300W
HALOGEN OSRAM
included

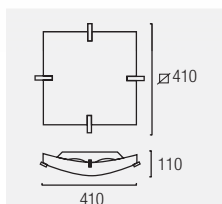

15-0638-81-B5

R7s L=118 Max. 150W
HALOGEN OSRAM
included

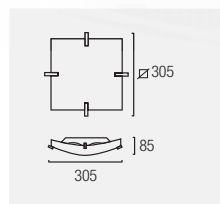

15-0635-81-B5

R7s L=118 Max. 150W
HALOGEN OSRAM
included

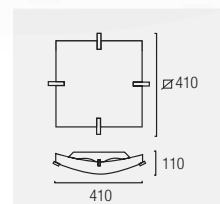

15-0636-81-B5

3 x E-27 ø45 Max. 40W
INCANDESCENT

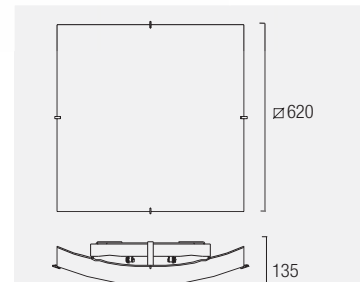

15-2405-81-B5 (S)

R7s L=118 Max. 500W
HALOGEN OSRAM included



MODUL
ELECTRO
www.modulelectro.ru

slimm

design _ Estudi Ribaudí

slimm_collection

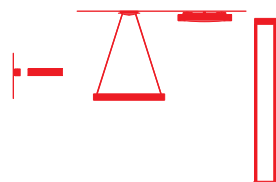

p.72 p.42 p.186 p.210

Estructura metálica disponible en acabados cromo y aluminio mate. Difusor de cristal óptico. Incluye embellecedores de metacrilato en 3 colores intercambiables. Luz directa.

Metal body available in chrome or matte aluminium. Optical glass diffuser. Includes methacrylate trims in 3 interchangeable colours. Direct light.

Structure métallique proposée avec finitions chromées et en aluminium mat. Diffuseur en verre optique. Inclut des caches en méthacrylate en trois couleurs interchangeables. Lumière directe.

Metallgehäuse lieferbar in Chrom und mattem Aluminium. Diffusor aus mattem Optikglas. Mitgeliefert werden austauschbare Plexiglasaufsätze in 3 Farben. Direkte Beleuchtung.

Struttura metallica disponibile con finitura cromata e alluminio opaco. Diffusore in cristallo ottico. Comprende elementi decorativi in metacrilato, in 3 colori intercambiabili. Luce diretta.

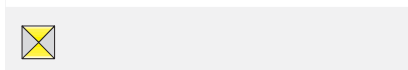

- Cromo
21 Chrome
Chrom
Cromo
- Aluminio mate
Y5 Matt aluminium
Alluminium mat
Alluminio opaco

- Cristal óptico
E9 Optic glass
Verre optique
Optisches Glas
Vetro ottico

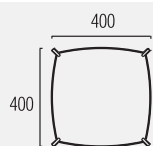



15-2399-Y5-E9 ^(S)
15-2399-21-E9 ^(S)
 R7s L=118 Max. 200W
 HALOGEN OSRAM
 included

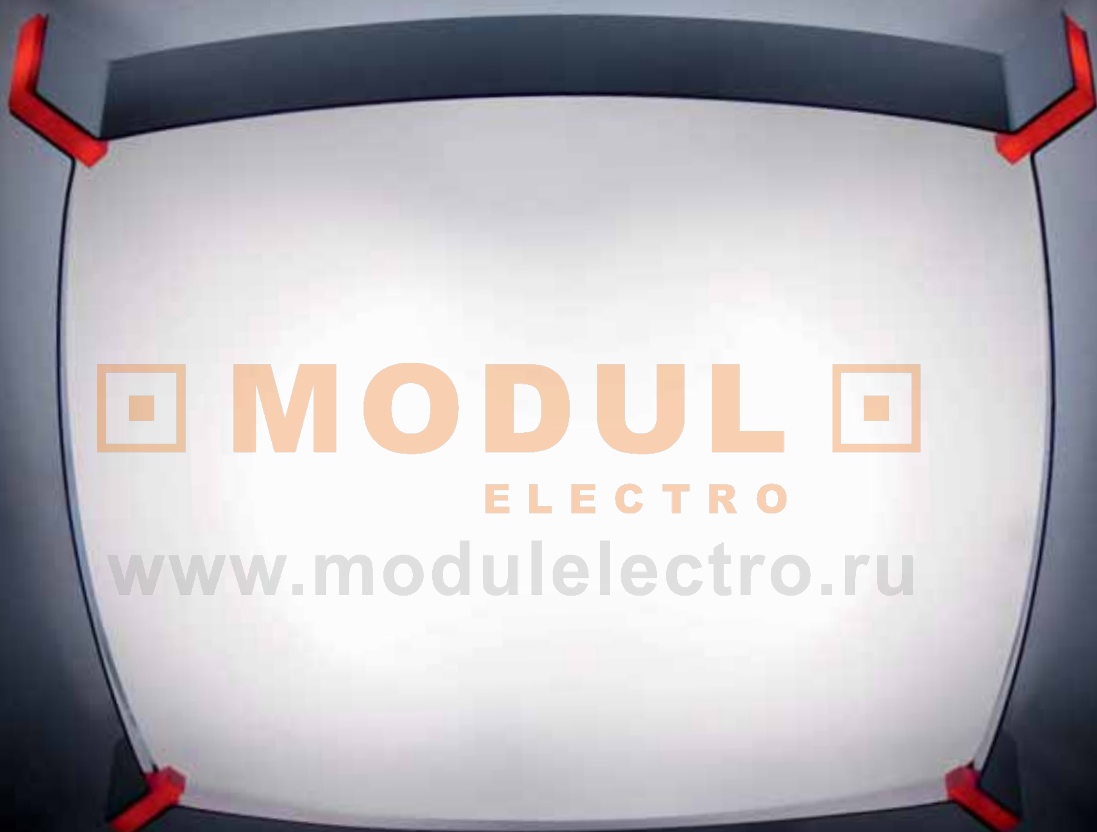

Incluye 3 acrílicos de color intercambiables
 Includes 3 color interchangeable acrylic pieces



 **MODUL** 
ELECTRO
www.modulelectro.ru

adn

design _ Josep Patsí

adn_collection

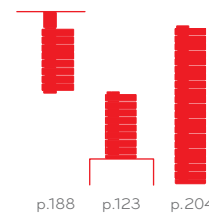

Estructura metálica y embellecedores de ABS ambos en acabado cromo. Difusor compuesto por 8 pantallas giratorias de color blanco escarcha. Luz directa.

Metal body and ABS trims, both finished in chrome. Diffuser consisting of 8 swivel frosted white shades. Direct light.

Structure métallique et caches en ABS avec finitions chromées. Diffuseur composé de huit écrans rotatifs en blanc glacé. Lumière directe.

Metallgehäuse und Zierblende aus ABS, verchromt. Diffusor aus 8 drehbaren in Ice-Weiß. Direkte Beleuchtung.

Struttura metallica ed elementi di finitura in ABS, entrambi con finitura cromata. Diffusore composto da 8 paralumi girevoli in colore bianco ghiaccio. Luce diretta.



MODULO
ELECTRO
www.modulelectro.ru



- | | |
|--|--|
| ● Cromo
Chrome
21 Chrome
Chrom
Cromo | ● Pantallas Blanco Escarcha incluida
Iced white shades included
AL Abat-jour gelée blanche compris
Weiss Schirm inklusiv
Paralume bianco brina inclusa |
|--|--|



15-2705-21-AL
T5 24W
FLUORESCENT included



CAMALEON



- DN-1302-14-00 QR-111 G53 max. 100W (Ø220 x 170 mm)
- DN-1302-J2-00 QR-111 G53 max. 100W (Ø220 x 170 mm)
- DN-1305-14-00 CDM-R111 GX8.5 max. 70W (Ø220 x 170 mm)
- DN-1305-J2-00 CDM-R111 GX8.5 max. 70W (Ø220 x 170 mm)
- DN-1301-14-00 TC-TEL GX24q-3 2x26/32W (Ø220 x 116 mm)
- DN-1301-J2-00 TC-TEL GX24q-3 2x26/32W (Ø220 x 116 mm)
- DN-1304-14-00 QR-CBC51 GU5.3 max. 50W (Ø120 x 179 mm)
- DN-1304-J2-00 QR-CBC51 GU5.3 max. 50W (Ø120 x 179 mm)
- DN-1303-14-00 QR-CBC51 GU5.3 max. 50W (Ø120 x 150 mm)
- DN-1303-J2-00 QR-CBC51 GU5.3 max. 50W (Ø120 x 150 mm)

Camaleón es una serie de apliques empotrables multifunción. Ha sido concebida para adaptarse perfectamente a su entorno. Camaleón, en su acabado blanco mate, se ha desarrollado para integrarse cromáticamente en la superficie de instalación. La luminaria permite ser pintada con la misma pintura que usted usaría para colorear su pared o techo camuflándose así de forma perfecta en el ambiente. Una nueva forma de concebir la iluminación.

Designed to achieve a perfect integration with the environment, a new range of recessed multifunction fittings is born under the name of Camaleon.

The matt white version has been developed to match chromatically with the mounting surface. Its external housing can be coloured with the same paint used on walls or ceilings matching perfectly with different atmospheres.

A new lighting concept is born.



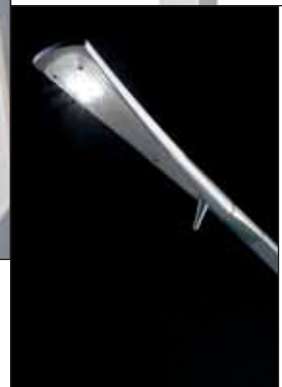
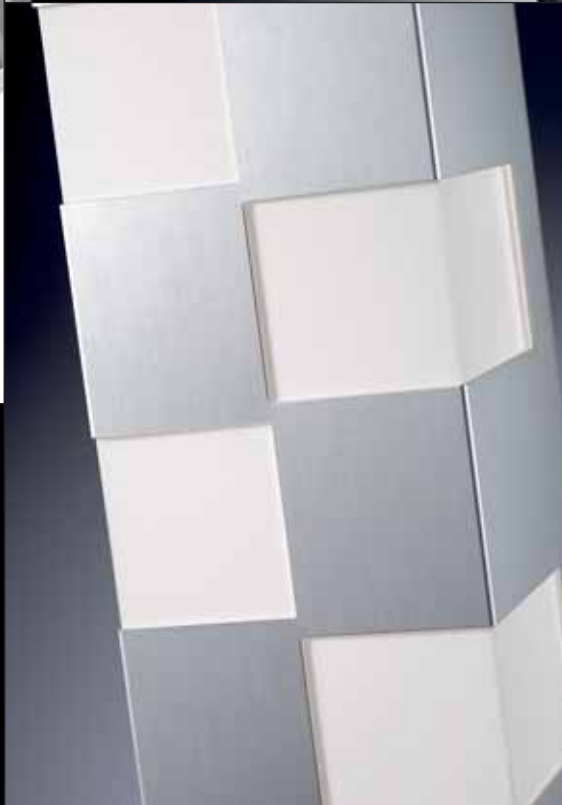



_pies salón
_floor lamps
_lampadaires
_stehleuchten
_lampade da terra

MODUL

ELECTRO

www.modulelectro.ru

troppo_192
escher_194
everyday outdoor_196
everyday_200
umbrella_202
adn_204
arc_206
class_208
adagio_209
slimm_210
leila_212
hotels_214
soul_215
suite_216
open_220
scala_222
fiore_223
totem_224

tropo

design_ Benedito Design

tropo_collection

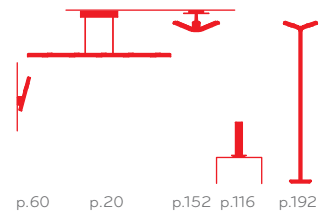

Estructura y brazos de aluminio en acabado cromo. Cristales de borosilicato matizado. Elegante combinación de formas simples: líneas y círculos. Interruptor foot-dimmer incluido. Emite luz directa y también indirecta gracias a la apertura de la parte posterior de los 2 brazos.

Aluminium body and arms finished in chrome. Matte borosilicate glass. Elegant combination of simple shapes—lines and circles. Foot dimmer switch included. Provides direct and indirect light thanks to opening on the back of the 2 arms.

Structure et bras en aluminium avec finitions chromées. Verre borosilicate teinté. Combinaison élégante de formes simples telles que des lignes et des cercles. Pédale interrupteur-variateur fournie. Émet une lumière directe mais aussi indirecte grâce à l'ouverture derrière ses deux bras.

Gehäuse und Arme aus Aluminium, Oberfläche verchromt. Mattes Borosilikatglas. Elegante Kombination einfacher Formen: Linien und Kreise. Inkl. Fußdimmer. Direkte Beleuchtung sowie indirekte Beleuchtung durch die Öffnung an der Rückseite der 2 Arme.

Struttura e bracci in alluminio con finitura cromata. Cristalli di borosilicato opacizzato. Elegante accostamento di forme semplici: linee e cerchi. Compreso interruttore foot-dimmer. Emette luce diretta e indiretta, anche grazie all'apertura nella parte posteriore dei 2 bracci.

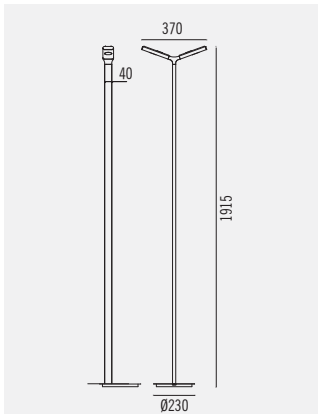

25-2804-21-F1

2 x G9 75W

HALOGEN OSRAM included



FOOT DIMMER



● Cromo
● Chrome
21 Chrome
● Chrom
● Cromo

○ Cristal anti-deslumbrante
○ Anti-glare glass
F1 Verre antiéblouissante
● Blendfreies Glas
● Vetro antiriflesso

MODUL
ELECTRO
www.modulelectro.ru





MODUL
ELECTRO
www.modulelectro.ru

escher

design _ Josep Patsí

escher_collection

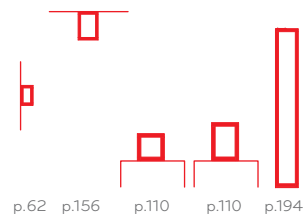

Estructura de aluminio en 3 acabados disponibles: aluminio Ecobright, lacado blanco y lacado negro. Interruptor foot-dimmer incluido. Cable de tela. Luz indirecta.

Aluminium body available in 3 finishes: Ecobright, black lacquer or white lacquer. Foot dimmer switch included. Cord cable. Indirect light.

Structure en aluminium proposée avec trois finitions: aluminium Ecobright, verni blanc et verni noir. Pédale interrupteur-variateur fournie. Câble en tissu. Lumière indirecte.

Gehäuse aus Aluminium in 3 lieferbaren Ausführungen: Ecobright-Aluminium, weiß lackiert und schwarz lackiert. Inkl. Fußdimmer. Textilkabel. Indirekte Beleuchtung.

Struttura in alluminio, disponibile in 3 finiture: alluminio Ecobright, laccato bianco e laccato nero. Compreso interruttore foot-dimmer. Cavo in tela. Luce indiretta.

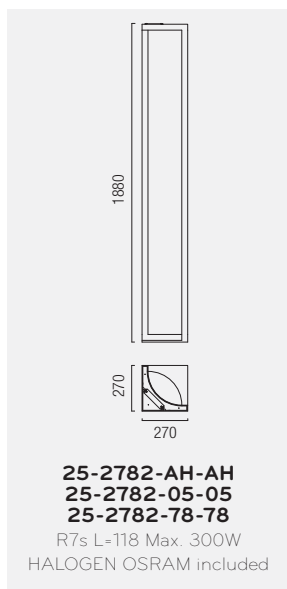

MODUL
ELECTRO
www.modulelectro.ru



FOOT DIMMER

AL

Aluminio Ecobright
Ecobright aluminium
AH Aluminium Ecobright
Ecobright aluminium
Alluminio Ecobright

Lacado negro
Black lacquered
05 Laqué en noir
Schwarz lackiert
Laccato nero

Lacado blanco
White lacquered
78 Laqué en blanc
Weiss lackiert
Laccato bianco



MODUL
ELECTRO
www.modulelectro.ru

everyday outdoor

design _ JBA design

everyday_collection

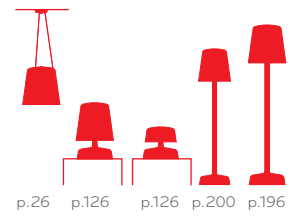

Estructura de aluminio de color blanco. Difusor de polietileno rotomoldeado. Apto para exteriores (IP66). Luz directa.

White aluminium body. Rotomolded polyethylene diffuser. Suitable for exterior (IP66). Direct light.

Structure en aluminium de couleur blanche. Diffuseur en polyéthylène rotomoulé. Convient à un usage en extérieur (IP66). Lumière directe.

Gehäuse aus Aluminium in Weiß. Diffusor aus rotationsgeformtem Polyethylen. Geeignet für Verwendung im Freien (IP66). Direkte Beleuchtung.

Struttura in alluminio di colore bianco. Diffusore in polietilene realizzato con la tecnica Rotomoulded. Adatto per esterni (IP66). Luce diretta.



MODULO
ELECTRO

www.modulelectro.ru

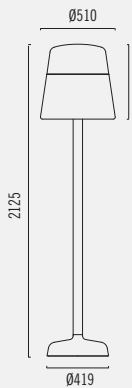

25-2803-14-M1

PL E-27 30W ENERGY SAVING
E-27 Max. 150W HALOGEN



- | | |
|-----------------|---|
| ○ Blanco | ○ Difusor policarbonato opal |
| ○ White | ○ Opal polycarbonate diffuser |
| 14 Blanc | M1 Diffuseur polycarbonate opale |
| ○ Weiss | ○ Polykarbonatdiffusor Opal |
| ○ Bianco | ○ Diffusore in policarbonato opalino |

ELEMENTOS DE FIJACIÓN AL SUELO INCLUIDOS
INSTALLATION ELEMENTS INCLUDED

Apta para exteriores / Suitable for outdoor use



MODUL
ELECTRO
www.modulelectro.ru

everyday outdoor



MODUL
ELECTRO
www.modulelectro.ru



MODUL
ELECTRO
www.modulelectro.ru

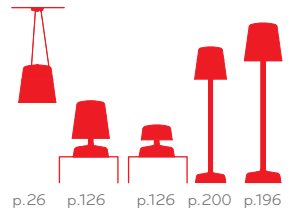

Estructura metálica blanca. Difusor de cristal opal triplex. Interruptor de diseño. Luz directa.

White metal body. Triplex optical glass diffuser. Design switch. Direct light.

Structure métallique blanche. Diffuseur en verre opale triplex. Interrupteur design. Lumière directe.

Metallgehäuse, weiß. Diffusor aus Triplex-Opalglas. Design-Schalter. Direkte Beleuchtung.

Struttura metallica bianca. Diffusore in cristallo opale triplex. Interruttore di design. Luce diretta.



MODULO
ELECTRO
www.modulelectro.ru

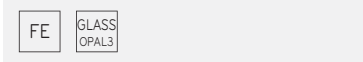
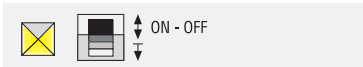
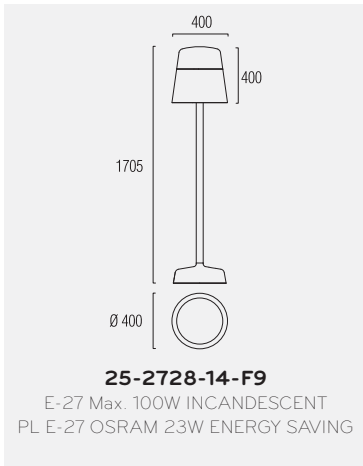

- | | |
|----------|------------------------|
| ○ Blanco | ○ Cristal opal triplex |
| White | Triplex Opal glass |
| Blanc | Verre opal triplex |
| Weiss | Optisches Glas |
| Bianco | Vetro ottico |
- 14** **F9**





MODUL
ELECTRO
www.modulelectro.ru

umbrella

design _ WIS design

umbrella_collection

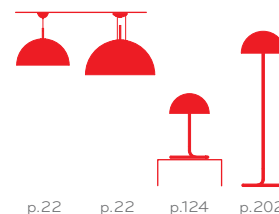

Estructura metálica con pantalla de aluminio semiesférica. Hay 2 versiones disponibles: acabado lacado blanco con pantalla interior plisada plata y acabado lacado negro con pantalla interior plisada dorada. Interruptor de pie incluido. Luz directa.

Metal body with hemisphere aluminium shade. Available in 2 versions: white lacquer finish with inner silver pleated shade and black lacquer finish with inner gold pleated shade. Foot switch included. Direct light.

Structure métallique avec écran semisphérique en aluminium. Existe en deux déclinaisons : une avec finitions en vernis blanc avec écran intérieur plissé couleur argent et une autre avec finitions en vernis noir avec écran intérieur plissé couleur doré. Pédale interrupteur fournie. Lumière directe.

Metallgehäuse mit halbrunden Schirm aus Aluminium. In 2 Ausführungen lieferbar: weiß lackierte Oberfläche mit silberfarben-plissiertem Innenschirm und schwarz lackierte Oberfläche mit goldfarben-plissiertem Innenschirm. Inkl. Fußschalter. Direkte Beleuchtung.

Struttura metallica con paralume semisferico in alluminio. 2 versioni disponibili: finitura laccata bianca con paralume interno plissettato colore argento e finitura laccata nera, con paralume interno plissettato dorato. Interruttore da piede compreso. Luce diretta.

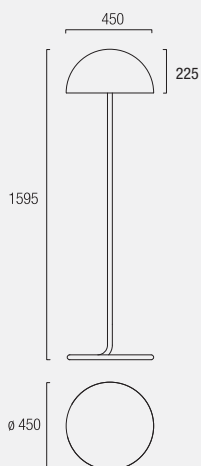

25-2726-AP-05
25-2726-AQ-78

3 x PL E-14 OSRAM 11W
ENERGY SAVING

MODUL
ELECTRO
www.modulelectro.ru



AL FE PVC TEXTIL

AP Pantalla interior plisada dorada
Golden pleated interior shade
Intérieur d'abat-jour plissé doré
Schirm, Innenseite Gold plissee
Paralume interna plisada oro

05 Lacado negro
Black lacquered
Laqué en noir
Schwarz lackiert
Laccato nero

AQ Pantalla interior plisada plata
Silver pleated interior shade
Intérieur d'abat-jour plissé argenté
Schirm, Innenseite Silver plissee
Paralume interna plisada argento

78 Lacado blanco
White lacquered
Laqué en blanc
Weiss lackiert
Laccato bianco





MODUL
ELECTRO
www.modulelectro.ru

adn

design _ Josep Patsí

adn_collection

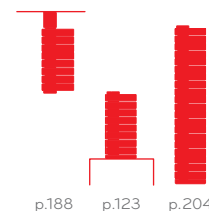

Estructura metálica y embellecedores de ABS, ambos en acabado cromo. Difusor compuesto por 20 pantallas giratorias de color blanco escarcha. Interruptor de pie incluido. Luz directa.

ABS body and trims finished in chrome. Diffuser consisting of 20 swivel frosted white shades. Foot switch included. Direct light.

Structure métallique et caches en ABS, avec finitions chromées. Diffuseur composé de vingt écrans rotatifs en blanc glacé. Pédale interrupteur fournie. Lumière directe.

Metallgehäuse und Zierblende aus ABS, verchromt. Diffusor aus 20 drehbaren in Ice-Weiß. Inkl. Fußschalter. Direkte Beleuchtung.

Struttura metallica ed elementi di finitura in ABS, entrambi con finitura cromata. Diffusore composto da 20 paralumi girevoli in colore bianco ghiaccio. Interruttore da piede compreso. Luce diretta.

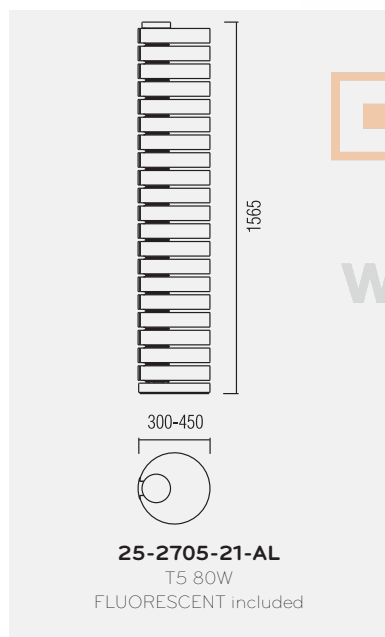

MODULO
ELECTRO
www.modulelectro.ru

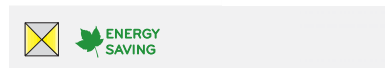
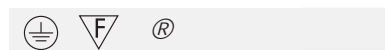

- Cromo
● Chrome
21 Chrome
● Chrom
● Cromo
- Pantallas Blanco Escarcha incluida
● Iced white shades included
AL Abat-jour gelée blanche compris
● Weiss Schirm inklusiv
● Paralume bianco brina inclusa

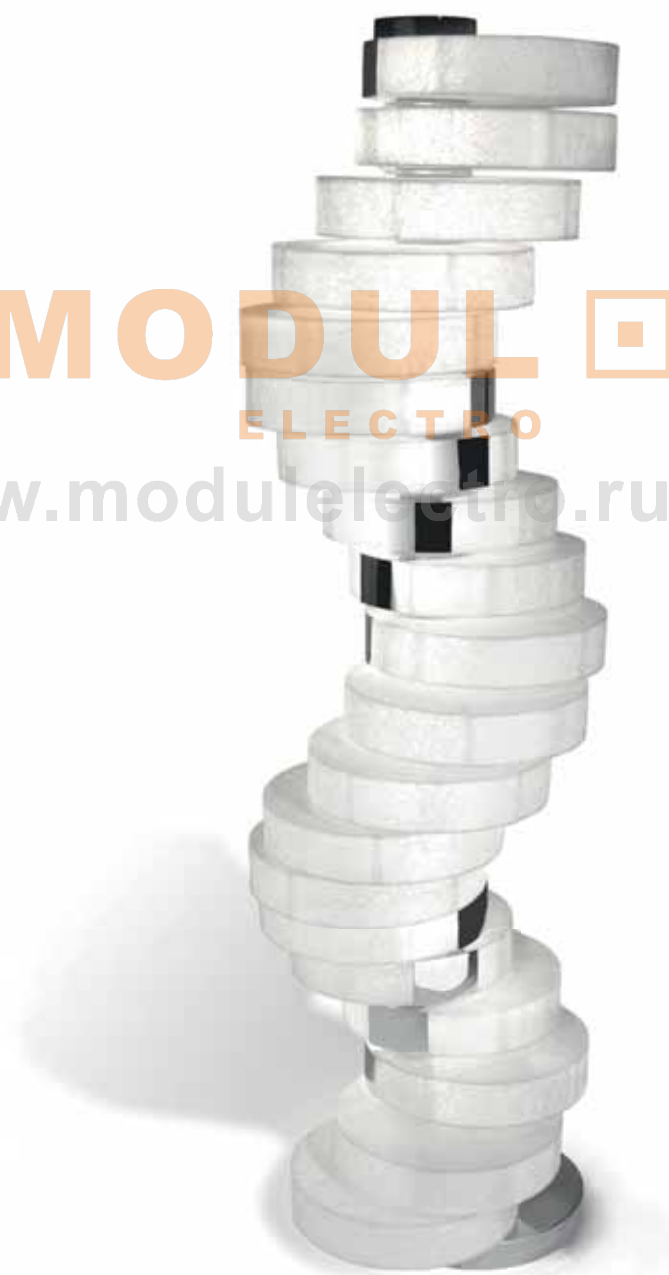

MODUL
ELECTRO

www.modulelectro.ru

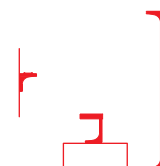

Estructura de aluminio y difusor de metacrilato matizado. Disponible en 3 acabados: aluminio Ecobright, lacado blanco y lacado negro. Interruptor-dimmer incluido. Luz indirecta.

Aluminium body and matte methacrylate diffuser. Available in 3 finishes: Ecobright, black lacquer or white lacquer. Dimmer switch included. Indirect light.

Structure en aluminium et diffuseur en méthacrylate teinté. Proposée avec trois finitions : aluminium Ecobright, verni blanc et verni noir. Interrupteur-variateur fourni. Lumière indirecte.

Gehäuse aus Aluminium und Diffusor aus mattiertem Plexiglas. In 3 Ausführungen lieferbar: Ecobright-Aluminium, weiß lackiert und schwarz lackiert inkl. Dimmerschalter. Indirekte Beleuchtung.

Struttura in alluminio e diffusore in metacrilato opacizzato. Disponibile in 3 finiture: alluminio Ecobright, laccato bianco e laccato nero. Interruttore dimmer compreso. Luce indiretta.



25-2580-AH-AH
25-2580-05-05
25-2580-78-78
 R7s L=118 Max. 300W
 HALOGEN OSRAM included

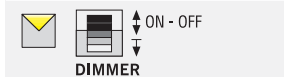

- Aluminio Ecobright
Ecobright aluminium
AH Aluminium Ecobright
Ecobright aluminium
Alluminio Ecobright
- Lacado negro
Black lacquered
05 Laqué en noir
Schwarz lackiert
Laccato nero
- Lacado blanco
White lacquered
78 Laqué en blanc
Weiss lackiert
Laccato bianco

MODULO
 ELECTRO
www.modulelectro.ru

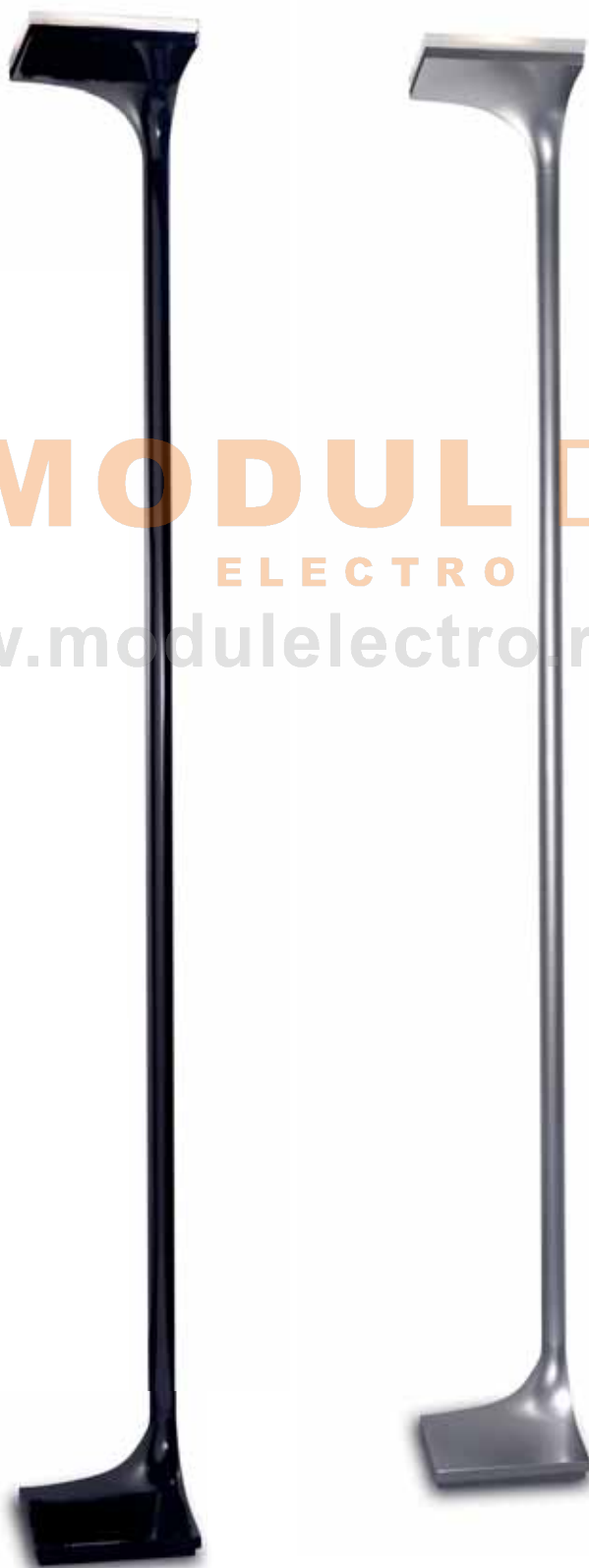

MODUL
ELECTRO

www.modulelectro.ru

class

design _ Josep Patsí

class_collection

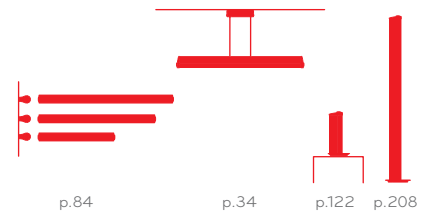

Estructura de aluminio Ecobright. Doble difusor: interior de policarbonato opal y exterior de borosilicato transparente. Interruptor-dimmer incorporado. Luz directa.

Ecobright aluminium body. Double diffuser - inner: opal polycarbonate, exterior: transparent borosilicate Dimmer switch incorporated. Direct light.

Structure en aluminium Ecobright. Double diffuseur : intérieur en polycarbonate opale et extérieur en borosilicate transparent. Interrupteur-variateur incorporé. Lumière directe.

Gehäuse aus Ecobright-Aluminium. Doppelter Diffusor: Innen aus Opal-Polycarbonat und außen aus transparentem Borosilikat. Einschl. eingebauter Dimmerschalter. Direkte Beleuchtung.

Struttura in alluminio Ecobright. Doppio diffusore: interno in policarbonato opale ed esterno in borosilicato trasparente. Interruttore dimmer integrato. Luce diretta.



Doble difusor
Double diffuser
Diffuseur double
Doppelglas
Difusore doppio

MODULO ELECTRO

www.modulelectro.ru

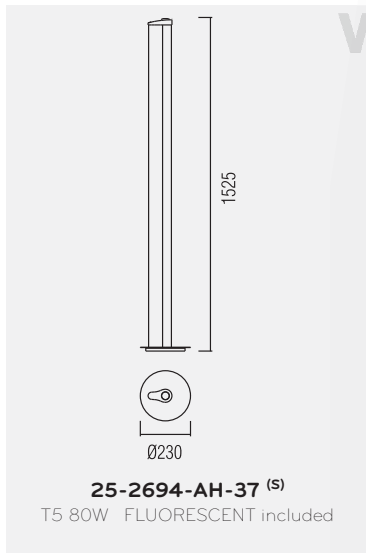

Aluminio Ecobright
Ecobright aluminium
AH Aluminium Ecobright
Ecobright aluminium
Alluminio Ecobright



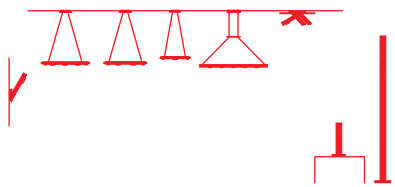

p.68 p.38 p.39 p.38 p.36 p.166 p.118 p.209

Estructura de aluminio y difusores de cristal anti-deslumbrante. Disponible en acabados cromo y aluminio pulido satinado. Interruptor-dimmer incorporado. Emite luz directa y también indirecta gracias a las aperturas de la parte posterior.

Aluminium body and anti-glare glass diffusers. Available in chrome or polished and satin aluminium. Dimmer switch incorporated. Provides direct and indirect light thanks to openings at the back of the luminaire.

Structure en aluminium et diffuseurs en verre anti-reflets. Proposée avec des finitions chromées et en aluminium poli satiné. Interrupteur-variateur incorporé. Émet une lumière directe mais aussi indirecte grâce aux ouvertures postérieures.

Gehäuse aus Aluminium und Diffusore aus entspiegeltem Glas. Verchromt und in poliertem satiniertem Aluminium lieferbar. Einsch. eingebauter Dimmerschalter. Direkte Beleuchtung sowie indirekte Beleuchtung durch die Öffnungen an der Rückseite.

Struttura in alluminio e diffusori in cristallo anti-abbagliamento. Disponibile con finitura in cromo e alluminio lucido satinato. Interruttore dimmer integrato. Emette luce diretta e indiretta, anche grazie alle aperture nella parte posteriore.

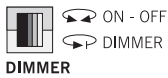

MODUL
ELECTRO

www.modulelectro.ru

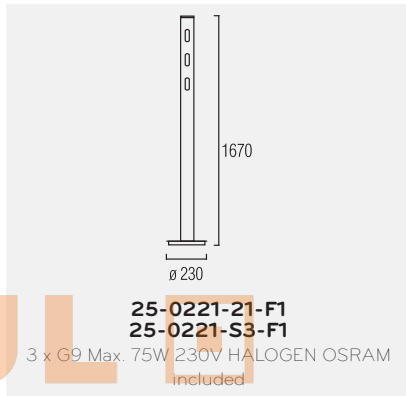

DIMMER		
	Cromo Chrome Chrom Cromo	
	Aluminio pulido y satinado Polished and burnished aluminium Aluminium poli et satiné Aluminium poliert und mattglänzend Alluminio lucidato e satinato	
	Cristal anti-deslumbrante Anti-glare glass Verre antiéblouissante Blendfreies Glas Vetro antiriflesso	

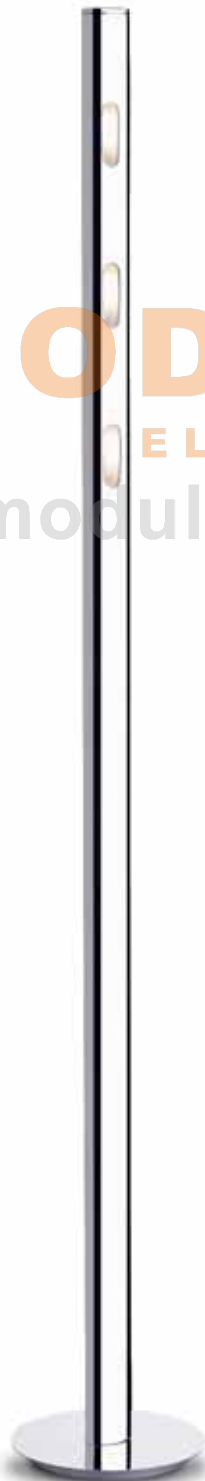

slimm

design _ Estudi Ribaudí

slimm_collection

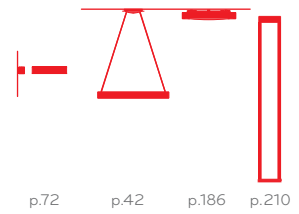

Estructura metálica disponible en acabados cromo y aluminio mate. Difusor de cristal óptico en la parte inferior. Incluye embellecedores de metacrilato en 3 colores intercambiables. Interruptor-dimmer incorporado. Luz directa e indirecta.

Metal body available in chrome or matte aluminium. Optical glass diffuser in lower part. Includes methacrylate trims in 3 interchangeable colours. Dimmer switch incorporated. Direct and indirect light.

Structure métallique proposée avec finitions chromées et en aluminium mat. Diffuseur en verre optique pour la partie inférieure. Inclut des caches en méthacrylate en trois couleurs interchangeables. Interrupteur-variateur incorporé. Lumière directe et indirecte.

Metallgehäuse lieferbar in Chrom und mattem Aluminium. Diffusor aus Optikglas an Unterseite. Mitgeliefert werden austauschbare Plexiglasauflätze in 3 Farben. Einsch. eingebauter Dimmerschalter. Zur direkten und indirekten Beleuchtung.

Struttura metallica disponibile con finitura cromata e alluminio opaco. Diffusore in cristallo ottico nella parte inferiore. Comprende elementi decorativi in metacrilato, in 3 colori intercambiabili. Interruttore dimmer integrato. Luce diretta e indiretta.



PUSH DIMMER

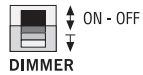

MODULO
ELECTRO
www.modulelectro.ru

Incluye 3 acrílicos de color intercambiables
Includes 3 color interchangeable acrylic pieces



PUSH DIMMER



21 Cromo
Chrome
Chrom
Cromo

Y5 Aluminio mate
Matt aluminium
Alluminium matt
Alluminio opaco

E9 Cristal óptico
Optic glass
Verre optique
Optisches Glas
Vetro ottico

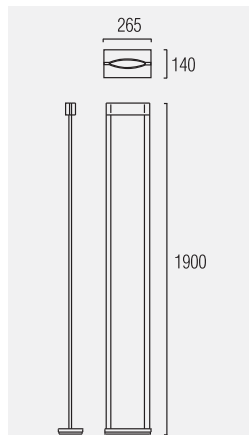

25-2397-Y5-E9
25-2397-21-E9 (S)

R7s L=118 Max. 200W
HALOGEN OSRAM included





MODUL
ELECTRO
www.modulelectro.ru

leila

design _ Benedito Design

leila_collection

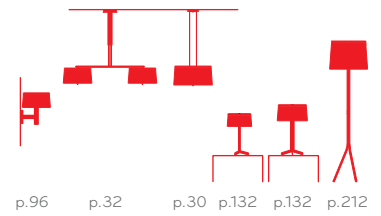

Estructura de aluminio satinado combinado con detalles cromados. Pantalla de tela disponible en negro y en blanco. Sistema de doble iluminación Up & Down. Regulación de la luz superior mediante dimmer y inferior mediante ON-OFF. Luz directa e indirecta.

Satin aluminium body combined with chrome details. Fabric shade available in black and white. Up & Down double lighting system. Upper light regulated using dimmer switch and lower light by using on/off switch. Direct and indirect light.

Structure en aluminium satiné ornée de détails chromés. Écran en tissu proposé en noir et en blanc. Système à double éclairage «Up & Down». Réglage de la lumière supérieure par variateur et de la lumière inférieure par interrupteur. Lumière directe et indirecte.

Gehäuse aus satiniertem Aluminium mit verchromten Details. Stoffschirm lieferbar in Schwarz und Weiß. Doppelles Beleuchtungssystem Up & Down. Regulierung des Oberlichts mit Dimmer und Regulierung des Unterlichts mit On-/Off-Schalter. Zur direkten und indirekten Beleuchtung.

Struttura in alluminio satinato, abbinato a dettagli cromati. Paralume in tela disponibile in colore nero e bianco. Sistema a doppia illuminazione Up & Down. Regolazione della luce superiore tramite un dimmer e di quella inferiore tramite ON-OFF. Luce diretta e indiretta.



PL E-27



G9

MODULO ELECTRO

www.modulelectro.ru

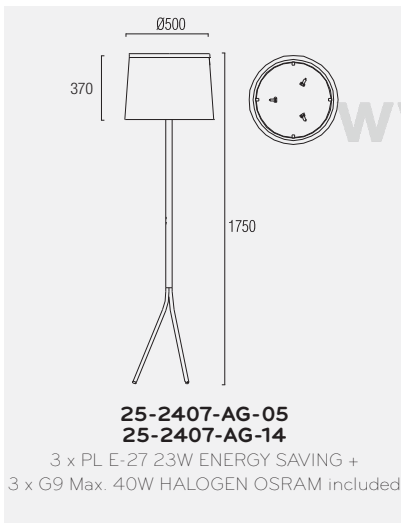

● Aluminium con cromo
● Aluminium with chrome
AG Aluminium avec chrome
● Aluminium mit Chrom
● Alluminio con cromo

● Pantalla negra de tela incluida
● Black fabric shade included
05 Abat-jour noir en tissu compris
● Schwartz Schirm inklusiv
● Paralume di tela nero inclusa

● Pantalla blanca de tela incluida
● White fabric shade included
14 Abat-jour blanche en tissu compris
● Weiss Schirm inklusiv
● Paralume di tela bianca inclusa





 **MODUL** 
ELECTRO
www.modul-electro.ru

hotels

design _ Benedito Design

hotels_collection

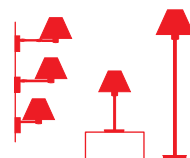

p.98 p.130 p.214

Estructura metálica. Hay 4 posibles combinaciones en función del acabado, níquel satinado pintado u oro pintado; y en función de la pantalla, blanca o beige. Pantallas no incluidas. Interruptor de pie incluido. Luz directa e indirecta.

Metal body. Available in 4 different combinations according to finish (painted satin nickel or painted old) or shade (white or beige). Shades not included. Foot switch included. Direct and indirect light.

Structure métallique. Quatre combinaisons possibles en fonction des finitions (couleur nickel satiné ou peinte dorée) et de l'écran (blanc ou beige). Écrans non fournis. Pédale interrupteur fournie. Lumière directe et indirecte.

Metallgehäuse. 4 mögliche Kombinationen: Oberfläche in lackiertem satiniertem Nickel oder goldfarben lackiert. Lampenschirm weiß oder beige. Schirme nicht im Lieferumfang enthalten. Inkl. Fußschalter. Zur direkten und indirekten Beleuchtung.

Struttura metallica. Possibilità di 4 diverse combinazioni in funzione della finitura, nichel satinato dipinto o oro dipinto e in funzione del paralume, bianco o beige. Paralumi non forniti. Interruttore da piede compreso. Luce diretta e indiretta.



Pan-104-14
Pan-104-20

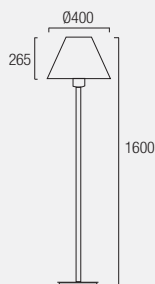

25-2271-U4-82
25-2271-S8-82

E-27 Max. 100W
INCANDESCENT

+
Pan-104-14 / Pan-104-20

MODULO
ELECTRO
www.modulelectro.ru



AL TEXTIL ZAMAK

U4 Níquel satinado pintado
Painted satin nickel
Nickel satiné peint
Lackiertes Nickel matt
Nichel satinato dipinto

S8 Oro satinado pintado
Painted satin gold
Or satiné peint
Lackiertes Gold matt
Oro satinato dipinto

14 Pantalla blanca
White shade
Abat-jour blanc
Weiss Stoffchirm
Paralume bianca

20 Pantalla beige
Beige shade
Abat-jour beige
Beige Stoffchirm
Paralume beige

Para conjunto completo solicite referencias de luminaria y pantalla
For complete set please order by separate fixture and shade reference

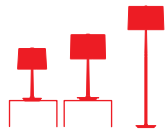

p.131 p.131 p.215

Estructura metálica en acabado cromo. Difusor superior de cristal fumé. Disponible con pantalla de color negro soirée y blanco escarcha. Pantalla de tela incluida. Interruptor foot-dimmer incluido. Luz directa e indirecta.

Chrome metal body. Upper smoked glass diffuser. Available with soirée black or frosted white shades. Fabric shade included. Foot dimmer switch included. Direct and indirect light.

Structure métallique avec finitions chromées. Diffuseur supérieur en verre fumé. Proposée avec écran noir soirée et blanc glacé. Écran en tissu fourni. Pédale interrupteur-variateur fournie. Lumière directe et indirecte.

Gehäuse aus verchromtem Metall. Oberer Diffusor aus Fumé-Glas. Lieferbar mit Schirm in Soirée-Schwarz und Ice-Weiß. Mit Stoffschirm. Inkl. Fußdimmer. Zur direkten und indirekten Beleuchtung.

Struttura metallica con finitura cromata. Diffusore superiore in cristallo fumé. Disponibile con paralume di colore nero soirée e bianco ghiaccio. Fornito paralume in tela. Compreso interruttore foot-dimmer. Luce diretta e indiretta.



MODULO ELECTRO
www.modulelectro.ru



FOOT DIMMER ENERGY SAVING

Cromo
Chrome
21 Chrome
Chrom
Cromo

Pantalla Negro Soirée incluida
Black Soiree shade included
AK Abat-jour noir soirée compris
Schwartz Schirm inklusiv
Paralume nero Soirée inclusa

Cristal fumé
Smoked glass
Verre fumé
Fumé Glas
Vetro fumé

Pantalla Blanco Escarcha incluida
Iced white shade included
AL Abat-jour gelée blanche compris
Weiss Schirm inklusiv
Paralume bianco brina inclusa

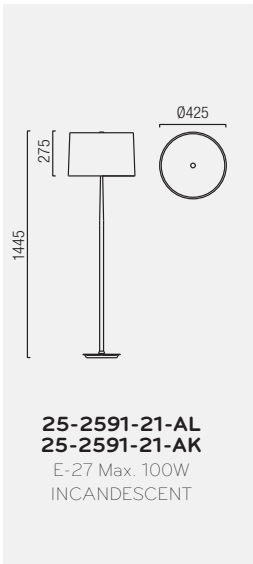

suite

design _ Benedito Design

Estructura metálica en acabado níquel satinado. Con pantalla de tela gris Ópera (incluida). Interruptor foot-dimmer incluido. Luz directa.

Satin nickel metal body. Opera grey fabric shade included. Foot dimmer switch included. Direct light.

Structure métallique avec finitions en nickel satiné. Écran en tissu gris Opéra. Pédale interrupteur-variateur fournie. Lumière directe.

Metallgehäuse in satiniertem Nickel. Schirm aus grauem Opera-Stoff (im Preis enthalten). Inkl. Fußdimmer. Direkte Beleuchtung.

Struttura metallica con finitura nichel satinato. Paralume di tela grigia Opera (fornito). Compreso interruttore foot-dimmer. Luce diretta.

suite_collection

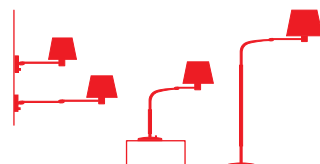

p.94

p.135

p.216



MODULO
ELECTRO
www.modulelectro.ru

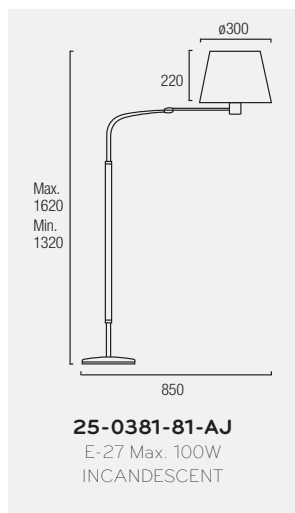

 **FOOT DIMMER**

 Níquel Satinado
Satin nickel
81 Nickel satiné
Nickel matt
Nichel satinato

 Pantalla Gris Ópera incluida
Opera Grey shade included
AJ Abat-jour Gris Opéra compris
Gau Schirm inklusiv
Paralume grigio inclusa



MODUL
ELECTRO
www.modulelectro.ru

suite

design _ Benedito Design

suite_collection

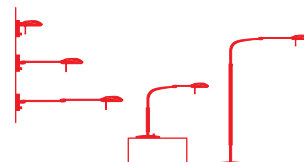

p.92

p.134

p.218

Estructura metálica en acabado níquel satinado. Con difusor de cristal opal satinado. Interruptor foot-dimmer incluido. Luz directa.

Satin nickel metal body. Satin opal glass diffuser. Foot dimmer switch included. Direct light.

Structure métallique avec finitions en nickel satiné. Diffuseur en verre opale satiné. Pédale interrupteur-variateur fournie. Lumière directe.

Metallgehäuse in satinier-tem Nickel. Diffusor aus satinier-tem Opalglas. Inkl. Fußdimmer. Direkte Beleuchtung.

Struttura metallica con finitura nichel satinato. Diffusore in cristallo opale satinato. Compreso interruttore foot-dimmer. Luce diretta.



MODULO
ELECTRO
www.modulelectro.ru

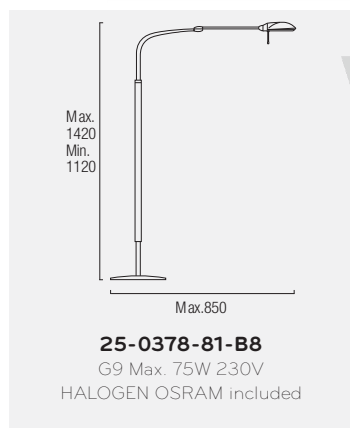

 **FOOT DIMMER**

 FE  GLASS MAT

 Níquel Satinado
Satin nickel
81 Nickel satiné
Nickel matt
Nichel satinato

 Cristal opal satinado
Satin opal glass
B8 Verre opal satin
Satiniertes opales Glas
Vetro opal satinado



MODUL
ELECTRO
www.modulelectro.ru

open

design _ Josep Patsí

open_collection

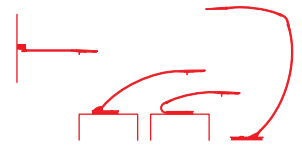

p.90 p.136 p.136 p.220

Estructura de aluminio disponible en acabados Ecobright y cromo. Brazo orientable mediante flexo y cabezal giratorio. Interruptor incorporado. Difusor de policarbonato transparente. Luz directa.

Aluminium body available in Ecobright or chrome finishes. Adjustable arm using flex and swivel head. Incorporated switch. Transparent polycarbonate diffuser Direct light.

Structure en aluminium proposée avec finitions Ecobright et chromées. Bras flexible orientable et tête rotative. Interrupteur incorporé. Diffuseur en polycarbonate transparent. Lumière directe.

Gehäuse aus Aluminium lieferbar in Ecobright und Chrom. Verstellbarer Arm mittels Flexo und Drehkopf. Inkl. Schalter. Diffusor aus transparentem Polykarbonat. Direkte Beleuchtung.

Struttura in alluminio, disponibile con finitura cromata ed Ecobright. Braccio orientabile mediante flexo e testina girevole. Interruttore incorporato. Diffusore in policarbonato trasparente. Luce diretta.



MODULO ELECTRO

www.modulelectro.ru



		RF 850°C	
		ON - OFF	
AL	FE	PC	
	Cromo Chrome Chrome Chrom Cromo		
	Aluminio Ecobright Ecobright aluminium Aluminium Ecobright Ecobright aluminium Alluminio Ecobright		

Min. 470
Max. 670

Min. 950
Max. 1550

25-2708-21-21
25-2708-AH-AH
LED 4,5W

A black leather tufted armchair is positioned in a room with a textured, brown wall. A modern floor lamp with a curved, adjustable arm and a conical shade stands next to the chair. The lamp has a circular base. The floor is made of large, brown tiles.

MODUL
ELECTRO
www.modulelectro.ru

scala

design _ Josep Patsí / Xavier Muixí

scala_collection

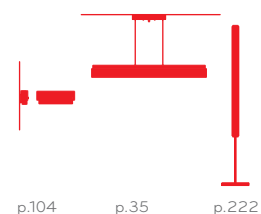

Estructura metálica en acabado cromo. Difusor de cristal fusing con tonos color cava. Interruptor de pie incluido. Luz directa e indirecta.

Chrome metal body. Fusing glass diffuser in pale yellow tones. Foot switch included. Direct and indirect light.

Structure métallique avec finitions chromées. Diffuseur en verre fondu avec des tons champagne. Pédale interrupteur fournie. Lumière directe et indirecte.

Gehäuse aus verchromtem Metall. Diffusor aus Fusing-Glas mit Sektfarbtönen. Inkl. Fußschalter. Zur direkten und indirekten Beleuchtung.

Struttura metallica con finitura cromata. Diffusore in cristallo fusing, con toni color champagne. Interruttore da piede compreso. Luce diretta e indiretta.



MODULO
ELECTRO
www.modulelectro.ro



		FUSING	ENERGY SAVING
		GLASS FUSING	
		21 Cromo Chrome Chrom Cromo	
		AO Cristal fusing cava Fusing cava glass Verre fusing "cava" Sektfarbiges-fusing-Glas Vetro fusing cava	

25-2676-21-AO
T5 54W FLUORESCENT included

Estructura metálica en acabado aluminio Ecobright. Difusor de cristal opal triplex. 2 interruptores independientes incorporados. Un interruptor enciende, apaga y regula la luz principal; el otro enciende, apaga y cambia el color de la luz ambiente, permitiendo seleccionar entre 7 colores distintos así como el modo de cambio automático de color.

Ecobright aluminium metal body. Triplex optical glass diffuser. 2 independent switches incorporated. One switch turns the main light on/off; the other turns the ambient light on/off and changes the colour, selecting from 7 different colours as well as automatic colour-change mode.

Structure métallique avec finitions Ecobright en aluminium. Diffuseur en verre opale triplex. Deux interrupteurs incorporés indépendants: l'un allume, éteint et régule la lumière principale, l'autre allume, éteint et change la couleur de la lumière d'ambiance (sept couleurs différentes ainsi qu'un mode de changement automatique de la couleur).

Metallgehäuse aus Ecobright-Aluminium. Diffusor aus Triplex-Opalglas. Mit 2 separaten Schaltern geliefert. Ein Schalter schaltet die Hauptlampe ein und aus, der zweite wählt und schaltet die Farbe des Ambientlichts. Auswahl zwischen 7 Farben möglich, sowie Modus zum automatischen Farbwechsel.

Struttura metallica con finitura in alluminio Ecobright. Diffusore in cristallo opale triplex. 2 interruttori indipendenti integrati. Un interruttore accende, spegne e regola la luce principale, mentre l'altro accende, spegne e cambia il colore della luce ambientale, consentendo di scegliere tra 7 diversi colori e la modalità di selezione automatica del colore.



MODULO ELECTRO
www.modulelectro.ru

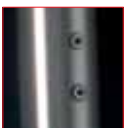

LED COLOR CONTROL

Presionar para cambiar el color de los LEDS (7 colores). Incluye opción de cambio automático de color. Presionar durante 2 segundos para apagar los LEDS.

Press to change the color of the LEDS (7 colors). Includes automatic color change. Pressing 2 seconds to switch off the LEDS.

DIMMER			
Aluminium Ecobright Ecobright aluminium Aluminium Ecobright Aluminium Ecobright	Cristal opal triplex Triplex Opal glass Verre opal triplex Optishes Glas Vetro ottico		

25-2687-AH-F9
E-14 Max. 150W
HALOGEN included
20 LED RGB COLOR SYSTEM

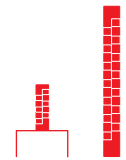

p.140 p.224

Estructura de aluminio en acabado satinado. Difusor acrílico opal. 3 interruptores independientes incorporados. Un interruptor enciende y apaga la luz directa; otro enciende, apaga y regula la luz indirecta superior; y el tercero enciende, apaga y cambia el color de la luz ambiente, permitiendo seleccionar entre 6 colores distintos así como el modo de cambio automático de color.

Satin aluminium body. Opal acrylic diffuser 3 independent switches incorporated. One switch turns the direct light on/off; another turns on/off and regulates the upper indirect light; and the third turns the ambient light on/off and changes the colour, selecting from 6 different colours as well as automatic colour-change mode.

Structure en aluminium avec finitions satinées. Diffuseur acrylique opale. Trois interrupteurs incorporés indépendants: le premier allume et éteint la lumière directe, le deuxième allume, éteint et régule la lumière indirecte supérieure et le troisième allume, éteint et change la couleur de la lumière d'ambiance (six couleurs différentes ainsi qu'un mode de changement automatique de la couleur).

Gehäuse aus Aluminium mit satinierter Oberfläche. Diffusor Opal-Acryl. Mit 3 separaten Schaltern geliefert. Ein Schalter schaltet die direkte Beleuchtung ein und aus, der zweite schaltet und reguliert die indirekte Beleuchtung und der dritte wählt und schaltet die Farbe des Ambientlichts, Auswahl zwischen 6 Farben möglich, sowie Modus zum automatischen Farbwechsel.

Struttura in alluminio, finitura lucida satinata. Diffusore acrilico opale. 3 interruttori indipendenti integrati. Un interruttore accende e spegne la luce diretta, mentre l'altro accende, spegne e regola la luce indiretta superiore. Il terzo, infine, accende, spegne e cambia il colore della luce ambientale, offrendo la possibilità di scegliere tra 6 diversi colori e la modalità di selezione automatica del colore.



Luz superior halógena
Top halogen light



TOP HALOGEN LIGHT

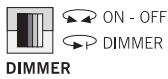

DIMMER



VERTICAL FLUORESCENT LIGHT



DIMMER



LED COLOR CONTROL
6-position push button

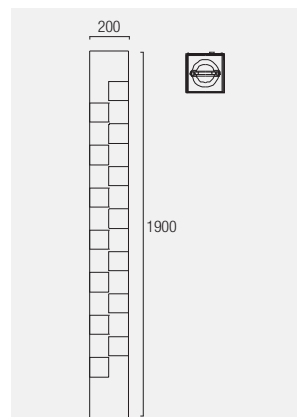
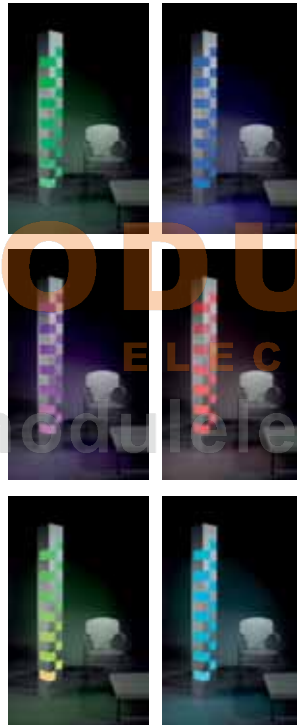

25-2384-AF-M1

R7s L=118 Max. 300W
HALOGEN OSRAM included
T8 58W
FLUORESCENT included
95 LEDS RGB COLOR SYSTEM



AF Aluminio satinado
Satin aluminium
Aluminium satiné
Aluminium matt
Alluminio satinato



M1 Difusor acrílico opal
Opal acrylic diffuser
Diffuseur acrilique opale
Kunststoff - Reflektor
Diffusore acrilico opalino

RGB color system with LEDS



MODUL
ELECTRO
www.modulelectro.ru

_simbologia_materiales_índice
_symbols_materials_index
_symboles_matériaux_index
_symbole_materialien_index
_simboli_materiali_indice

 **MODULO** 
ELECTRO
www.modulelectro.ru

DIALux

CONSULTORIA DE ILUMINACIÓN - DIALUX

LEDS-C4 dispone de un departamento técnico de proyectos de iluminación destinado a ayudar y asesorar a nuestros clientes sobre cualquier consulta en materia de iluminación. Este departamento está preparado para seleccionar el tipo de iluminación según sus necesidades y la funcionalidad de la zona. Asimismo, puede asesorarle sobre la mejor distribución de la intensidad de la luz. Además, LEDS-C4 ofrece a sus clientes la posibilidad de trabajar con DIALux, el software líder en planificación de iluminación, que utilizan más de 30.000 proyectistas y lighting designers de todo el mundo.

LIGHTING CONSULTANCY - DIALUX

LEDS-C4 has a technical department for lighting projects, with the aim to help and advise our clients about any questions they may have about lighting. This department is equipped to select the type of lighting according to your needs and the functionality of the area. It can also advise you on the best distribution of the light intensity.

LEDS-C4 also offers its clients the possibility of working with DIALux, the leading software in lighting planning, with more than 30,000 draftspeople and lighting designers from all over the world.

LE CONSEIL EN ILLUMINATION - DIALUX

LEDS-C4 dispose d'un département technique de projets d'illumination destiné à aider et conseiller nos clients en matière d'illumination. Ce département est capable de choisir, avec vous, le meilleur type d'éclairage en fonction des vos besoins et des fonctionnalités de la zone en question. Ainsi, nous pouvons vous conseiller sur la meilleure distribution et intensité de la lumière.

De plus, LEDS-C4 offre à ses clients la possibilité de travailler avec DIALux, le logiciel leader en études et simulations d'éclairage, utilisé par plus de 30.000 designers et concepteurs lumière du monde entier.

CONSULENZA DI ILLUMINAZIONE - DIALUX

LEDS-C4 dispone di un reparto tecnico di progetti di illuminazione destinato ad aiutare e consigliare i nostri clienti per qualsiasi problema in fatto di illuminazione. Questo reparto è preparato per selezionare il tipo di illuminazione a seconda delle necessità del cliente e la funzionalità della zona. Al tempo stesso, il cliente potrà essere consigliato in quanto alla distribuzione ottimale dell'intensità luminosa.

Inoltre, LEDS-C4 offre ai suoi clienti la possibilità di lavorare con DIALux, il software leader in pianificazione di illuminazione, utilizzato da oltre 30.000 progettisti e lighting designer di tutto il mondo.

ABTEILUNG FÜR BELEUCHTUNGSBERATUNG - DIALUX

LEDS-C4 stellt den Kunden eine Abteilung zur technischen Beratung für Beleuchtungsprojekte zur Verfügung, die bezüglich jeder Angelegenheit im Zusammenhang mit der Beleuchtung Rat und Auskunft erteilt. Diese Abteilung ist Ihnen bei der Auswahl der Beleuchtungsart behilflich, die sich am besten an Ihre Bedürfnisse anpasst und die höchste Funktionalität im jeweiligen Einsatzbereich bietet. Darüber hinaus kann Sie diese Abteilung bezüglich der günstigsten räumlichen Lichtstärkeverteilung beraten.











LEDS-C4 bietet den Kunden überdies die Möglichkeit, mit DIALux zu arbeiten, der im Bereich der Beleuchtungsplanung marktführenden Software, die von über 30.000 Projekttechnikern und Beleuchtungsdesignern der ganzen Welt benutzt wird.

MODUL

ELECTRO

www.modulelectro.ru



Marcas y símbolos	Marks and Symbols	Marques et Symboles	Brukezeichen und Symbole	Marche e Simboli	
	Todas las luminarias marcadas con este símbolo están construidas de manera que permiten ser instaladas sobre una superficie normalmente inflamable.	All lighting fixtures bearing this symbol are suitable for installation on normally inflammable surfaces.	Tous les appareils marqués avec ce symbole sont fabriqués de façon à permettre leur installation sur une surface normalement inflammable.	Alle mit diesem Symbol gekennzeichneten Leuchten dürfen unter normalen Bedingungen leicht entzündbaren Oberflächen angebracht werden.	Tutte le lampade contraddistinte con questo simbolo sono costruite in modo tale da poter essere installate su di una superficie normalmente infiammabile.
	Todas las luminarias marcadas con este símbolo no pueden ser instaladas sobre una superficie normalmente inflamable.	All lighting fixtures bearing this symbol are unsuitable for installation on normally inflammable surfaces.	Il n'est pas permis d'installer les appareils marqués avec ce symbole sur des surfaces normalement inflammables.	Alle mit diesem Symbol gekennzeichneten Leuchten dürfen nicht auf unter normalen Bedingungen leicht entzündbaren Oberflächen angebracht werden.	Tutte le lampade contraddistinte con questo simbolo non possono essere installate su di una superficie normalmente infiammabile.
	Todas las luminarias marcadas con este símbolo son de Clase I. Estas luminarias disponen sólo de aislamiento básico y, por tanto, deberán conectarse a la toma de tierra de la vivienda.	All light fittings bearing this symbol are Class I models. These light fittings have only basic isolation and therefore must be connected to the earthing system of the residential dwelling.	Toutes les lampes marquées avec ce symbole appartiennent à la Classe I. Ces lampes sont uniquement munies d'une isolation de base et, par conséquent, elles devront être branchées à la prise de terre du logement.	Alle mit diesem Symbol angegebenen Leuchtkörper gehören zur Klasse I. Diese Leuchtkörper haben lediglich eine Einfachisolierung und sind daher an die Erdung der Wohnung anzuschließen.	Tutte le luci contraddistinte con questo simbolo sono di Classe I. Queste luci dispongono solo di isolamento base e, pertanto, devono essere collegate alla presa di terra dell'appartamento.
	Todas las luminarias marcadas con este símbolo son de Clase II. Ninguna parte metálica de las luminarias de Clase II se conectará al conductor de Toma de Tierra de la instalación de la vivienda.	All lighting fixtures bearing this symbol are of Class II. No metal part of Class II fixtures shall be connected to the ground connection of the home installation.	Tous les appareils marqués avec ce symbole appartiennent à la Classe II. Aucune partie métallique d'un appareil de Classe II ne doit être raccordée à la terre.	Alle mit diesem Symbol gekennzeichneten Leuchten gehören der Klasse II an. Metallteile von Klasse II-Leuchten dürfen nicht mit der Erdung der elektrischen Installation in der Wohnung in Berührung kommen.	Tutte le lampade contraddistinte con questo simbolo sono di Classe II. Nessuna parte metallica di queste lampade di Classe II verranno collegate alla Presa di Terra dell'impianto della casa.
	Este símbolo indica la distancia mínima entre el foco de la luminaria y el objeto iluminado.	This symbol indicates the minimum distance to be left between the focus of the lighting fixture and the lighted object.	Ce symbole indique la distance minimale entre la lampe et l'objet à éclairer.	Dieses Symbol gibt den Mindestabstand zwischen der Lichtquelle und dem zu beleuchtenden Objekt an.	Questo simbolo indica la distanza minima tra il fuoco della lampada e l'oggetto illuminato.
	Todas las luminarias marcadas con este símbolo están protegidas contra las proyecciones de agua.	All light fittings bearing this symbol are protected against water projections.	Toutes les lampes marquées avec ce symbole sont protégées contre les projections d'eau.	Alle mit diesem Symbol angegebenen Leuchtkörper sind gegen Spritzwasser geschützt.	Tutte le luci contraddistinte con questo simbolo sono protette contro gli schizzi d'acqua.
	Lámpara totalmente protegida contra la penetración de polvo y contra las pulverizaciones de agua con una presión de 1 bar a 3 metros.	Dust-tight lamp, protected against water jets and against water spray at a pressure of 1 bar at three metres.	Luminaire totalement protégé contre les poussières et les jets d'eau dans toutes les directions et les pulvérisations d'eau à 1 m ne pression de 1 bar à trois mètres.	Lampe vollkommen geschützt gegen das Eindringen von Staub und gegen Wasserbestäubung mit einem Druck bis zu 1 bar aus 3 Meter Entfernung.	Lampada a prova di polvere e protetta dalle pulverizzazioni d'acqua a pressione di 3 bar a distanza di 3 metri.
	Resistente a hilo incandescente a 850°C.	Resistance to incandescent wire at 850°C.	Tenue au feu 850°C.	Glührahtbeständig auf 850°C.	Resistente a filo incandescente 850°C.
	Modelos registrados.	Registered models.	Modèles enregistrés.	Eingetragene Modelle.	Modelli registrati.
	Consultar disponibilidad.	Check availability.	Vérifiez la disponibilité.	Bitte nach Verfügbarkeit fragen.	Verificare la disponibilità.

Simbolos	Symbols	Symboles	Symbole	Simboli	
 OPENING SYSTEM	Sistema de apertura abatible.	Collapsible opening system.	Système d'ouverture rabattable.	Kippbares Öffnungssystem.	Sistema di apertura ribaltabile.
 TILT SYSTEM	Sistema de inclinación.	Tilt system.	Système d'inclinaison.	Neigung system.	Sistema d'inclinazione.
 CABLE IN - OUT	Sistema para recoger el cable.	Cord storage system.	Système pour replier le câble.	System zur Einrollung des Kabels.	Raccogli cavo.
 FUSING	Elaborado artesanalmente mediante la técnica del "fusing".	Manufactured in the traditional way using a "fusing" technique.	Fabrication artisanale à partir de la technique du "fusing".	Handwerklich mittels Fusing-Technik hergestellt.	Realizzato artigianalmente mediante la tecnica del "fusing".
 DIMMER	Con regulador de intensidad.	With dimmer.	Avec régulateur d'intensité.	Mit Intensitätsregler.	Con regolatore d'intensità.
 ON-OFF	Interruptor integrado.	Built-in switch.	Interrupteur intégré.	Eingebauter Schalter.	Interruttore integrato.
 ENERGY SAVING	Bajo consumo.	Energy saving.	Économie d'énergie.	Energiesparlampe.	Risparmio energetico.
 new	Novedad.	New.	Nouveau.	Neu.	Nuevo.
 Elect. inc.	Reactancia electrónica incluida.	Electronic ballast included.	Ballaste électronique compris.	Elektronisches Vorschaltgerät (EVG) inklusiv.	Reattanza elettronica inclusa.
	Dirección del halo de luz.	Halo light direction.	Lichtstrahl Richtung.	Direction flux lumineux.	Direzione del flusso della luce.

	Materiales	Materials	Matériaux	Materialien	Materiali
ABS	ABS	ABS plastic	Plastique ABS	ABS-kunststoff	Plastica ABS
AL	Aluminio	Aluminum	Aluminium	Aluminium	Alluminio
FE	Acero	Steel	Acier	Stahl	Acciaio
GLASS BOSI	Vidrio de borosilicato	Borosilicate glass	Verre borosilicaté	Borosilikatglas	Vetro borosilicato
GLASS FUME	Vidrio fumé	Smoked glass	Verre fumé	Fumé glas	Vetro fumé
GLASS FUSING	Cristal fusing	Fusing glass	Verre fusing	Fusing-Glas	Vetro fusing
GLASS MAT	Vidrio mate	Matt glass	Verre mat	Matter Glas	Vicchiere matt
GLASS OPAL3	Cristal opal tríp lex	Triplex Opal glass	Verre opal triplex	Optishes Glas	Vetro ottico
GLASS OPT	Cristal óptico	Optic glass	Verre optique	Optishes Glas	Vetro ottico
GLASS TRANS	Cristal transparente	Transparent glass	Verre transparent	Transparenter Glas	Vicchiere transparente
PC	Policarbonato	Polycarbonate	Polycarbonate	Polykarbonat	Polycarbonate
PE	Polietileno	Polyethylene	Polyéthylène	Polyethylen	Polietilene
PMMA	PMMA	PMMA	PMMA	PMMA	PMMA
POL +FV	Poliéster + fibra vidrio	Polyester + fiberglass	Polyester + fibre de verre	Polyester + glasfaser	Poliestere + fibra di vetro
PUR	Poliuretano	Polyurethane	Polyuréthane	Polyurethan	Poliuretano
PVC	PVC	PVC	PVC	PVC	PVC
TEXTIL	Tela	Fabric	Tissu	Stoff	Tela
ZAMAK	Zamak	Zamak	Zamak	Zamak	Zama

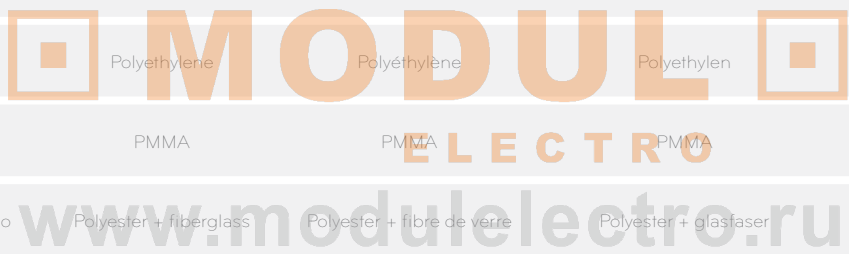

	Especificación Bombillas	Bulbs Specification	Spécification Ampoules	Beschreibung Leuchtmittel	Caratteristiche Lampadina
INCANDESCENT	E-27 Standard	E-27 ø45	E-14	E-14	
HALOGEN	R7s Halogen	Halopin G9 Osram	E-14	E-27 Standard	
ENERGY SAVING FLUORESCENT	PL elec E-27	G24d1 G24d1	2G11	G13 / T8	G5 T5 / TL5 2GX13 / T5 circular
LED	LED	RGB LED	GU 10 LED		

_índice_index_indice

colgantes pendants suspensions pendelleuchten lampade a sospensione	05-2577.....102 05-2578102 05-2580.....66 05-267376 05-2676.....104 05-269484 05-269584 05-269684 05-270890 05-278262 05-2804.....60 05-287056	15-2385.....171 15-2386.....171 15-2387171 15-2388.....170 15-2389.....170 15-2390.....168 15-2391.....168 15-2393.....168 15-2399.....186 15-2405.....184 15-2575.....182 15-2705188 15-2779.....158 15-2780158 15-2781158 15-2782156 15-2804152 15-2805.....164 15-2806164 15-2807162 15-2870150 15-4314146 15-4316.....146 15-4318144 15-4332.....148 IBIS C/17174 IBIS C/27174 IBIS C/37174 IBIS C/47174	
00-008750 00-0221.....36 00-025452 00-0338.....48 00-057344 00-239742 00-240730 00-267340 00-267635 00-269434 00-272528 00-272622 00-272722 00-272826 00-2801.....16 00-280420 00-287218 00-434812 20-0221.....38 20-031338 20-032546 20-032646 20-053639 20-240732	sobremesas table lamps lampes de tables tischleuchten lampade da tavolo	15-2779.....158 15-2780158 15-2781158 15-2782156 15-2804152 15-2805.....164 15-2806164 15-2807162 15-2870150 15-4314146 15-4316.....146 15-4318144 15-4332.....148 IBIS C/17174 IBIS C/27174 IBIS C/37174 IBIS C/47174	
apliques wall fixtures opliques wandleuchten lampade da parete	10-0080138 10-0221.....118 10-0378134 10-0381.....135 10-2056120 10-2271130 10-2278128 10-2384140 10-2407132 10-2571132 10-2580114 10-2591131 10-2592131 10-2694122 10-2705123 10-2708136 10-2709136 10-2726124 10-2728126 10-2729126 10-2782110 10-2804116 10-2809110	pies salon floor lamps lampadaires stehleuchten lampade da terra	25-0221.....209 25-0378218 25-0381.....216 25-2271.....214 25-2384224 25-2397210 25-2407212 25-2580.....206 25-2591.....215 25-2676.....222 25-2687.....223 25-2694208 25-2705204 25-2708220 25-2726202 25-2728200 25-2782194 25-2803196 25-2804.....192
05-0196100 05-0221.....68 05-026586 05-026686 05-026786 05-032582 05-037892 05-037992 05-038092 05-0381.....94 05-038294 05-056771 05-057074 05-057174 05-057274 05-057370 05-1876.....103 05-227198 05-227298 05-227398 05-227498 05-227598 05-227698 05-236674 05-236774 05-239772 05-240796 05-257278 05-257378 05-257480	plafones ceiling fixtures plafoniers deckenleuchten plafoniere	pantallas shades abat-jours schirme paralumi	PAN-100.....128 PAN-103.....98, 130 PAN-104.....214
	15-0079184 15-0157182 15-0158.....182 15-0159.....182 15-0221.....166 15-0222180 15-0223178 15-0256.....180 15-0258.....178 15-0318.....182 15-0562176 15-0590172 15-0591.....172 15-0592.....172 15-0635184 15-0636184 15-0638184 15-2138177		

Información general
General information
Information générale
Allgemeine Informationen
Informazione generale

• Las descripciones y medidas de los aparatos del presente catálogo son orientativas, pudiendo por tanto ser modificadas, a fin de mejorar las características técnicas o de diseño. • La empresa se reserva el derecho de anular o modificar cualquier modelo sin previo aviso. • Todos los modelos presentados cumplen las normas exigidas por la C.E. para aparatos de iluminación de uso doméstico y sus características vienen determinadas por las clases I y II. • Los acabados y las especificaciones técnicas corresponden a los productos que se suministran en Europa, pudiendo éstos variar en otros mercados. • Para una buena conservación de las lámparas, no usar bombillas de potencia superior a las recomendadas y limpiar simplemente con un paño seco. No usar limpia metales, ya que dañan los barnices protectores que garantizan la duración del acabado.

• The descriptions and dimensions of the items in this catalogue are indicative and may be modified for the purpose of technical or design improvements. • We reserve the right to cancel or change all models without prior notice. • All items meet the E.C. Class I and Class II safety regulations for home lighting appliances. • The finishes and technical specifications listed here are for the European market and may vary elsewhere. • Do not use stronger bulbs than recommended, and always clean lamps with a soft dry cloth alone since metal polish will damage the protective finish.

• Les descriptions et mesures des appareils de ce catalogue sont données à titre d'orientation, pouvant être modifiées dans le but d'améliorer les caractéristiques techniques ou de design. • L'usine se réserve le droit d'annuler ou modifier l'un ou l'autre de ses modèles sans avis préalable. • Tous les modèles présentés sont conformes aux normes exigées par la C.E. pour les appareils d'éclairage domestique et leur caractéristiques sont déterminées par la classe I et II. • Les finitions et spécifications techniques correspondent à la demande du marché européen. Elles peuvent être modifiées pour d'autres pays. • Ne pas utiliser d'ampoules d'une puissance supérieure à celle recommandée. Pour un bon entretien, utiliser simplement un chiffon sec. N'utilisez aucun produit pour métaux, ils abîment le vernis protecteur.

www.modulelectro.ru

• Die Beschreibung und Maße der in diesem Katalog aufgeführten Modelle dienen der Orientierung und können zur Verbesserung der technischen Eigenschaften oder des Designs geändert werden. • Der Hersteller behält sich das Recht vor, Modelle zu ändern oder aus dem Programm zu nehmen. • Die gezeigten Modelle erfüllen alle die innerhalb der EU geforderten Normen und Richtlinien für Leuchten für allgemeine Beleuchtungszwecke der Schutzklassen I und II. • Die Ausführungen und technischen Daten gelten für den europäischen Markt und können in anderen Ländern abweichen. • Für eine gute Erhaltung der Leuchten ist der Betrieb mit Lampen höherer Leistung als empfohlen zu vermeiden. Zur Reinigung benutzen Sie einfach ein trockenes Tuch, da Metallputzmittel die Schutzlackierung angreifen.

• Le descrizioni e le dimensioni degli articoli del presente catalogo vengono fornite a mero titolo orientativo e possono pertanto essere modificate al fine di migliorarne le caratteristiche tecniche o di design. • La Casa si riserva il diritto di cessare la produzione o di modificare qualsiasi modello senza preavviso. • Tutti i modelli presentati sono conformi alle normative C.E. per gli articoli da illuminazione per uso domestico di classe I e II. • Le rifiniture e le specifiche tecniche corrispondono ai prodotti venduti in Europa; tali dati possono pertanto variare su altri mercati. • Per una buona conservazione delle lampade, non utilizzare lampadine di potenza superiore a quella consigliata e pulirle semplicemente con un panno asciutto. Non utilizzare prodotti per la pulizia del metallo che potrebbero rovinare le vernici di protezione che garantiscono la vita della rifinitura.

• Todos los derechos reservados. Ninguna parte de este libro puede ser reproducida en ningún formato de papel o electrónico, sin el consentimiento previo del editor o de los propietarios de los derechos.
• All rights reserved. No part of this publication may be reproduced or transmitted in any form or by any means, electronic storage and retrieval system, without permission in writing from the copyright owner (s).
• Tous droits réservés. Aucune partie de ce livre ne pourra être reproduite en format papier ou électronique sans l'autorisation préalable de l'éditeur ou du propriétaire des droits.
• Sämtliche Rechte vorbehalten. Kein Teil dieses Buches darf in keinem Papier- oder elektronischem Format ohne ausdrückliche Zustimmung des Herausgebers oder der Inhaber der Urheberrechte wiedergegeben oder vervielfältigt werden.
• Tutti i diritti riservati. Nessuna parte di questo libro può essere riprodotta in nessun formato cartaceo o elettronico, senza la previa autorizzazione dell' editore o dei proprietari dei diritti.



LEDS-C4, S.A.

Afuera s/n, - 25750 - TORA (Lleida) SPAIN

www.leds-c4.com

España

Tel.: 973 46 81 01

Fax.: 973 46 81 29

info@leds-c4.com

Europe

Tel.: + 34 973 46 81 02

Fax.: + 34 973 46 81 06

europe@leds-c4.com

France - Portugal

Tel.: + 34 973 46 81 30

Fax.: + 34 973 46 81 29

france@leds-c4.com

portugal@leds-c4.com

Asia - Pacific and Africa

Tel.: + 34 973 46 81 16

Fax.: + 34 973 46 81 06

export@leds-c4.com

USA - Canada - Ireland

Tel.: +34 973 46 81 09

Fax: +34 973 46 81 06

lighting@leds-c4.com

América Latina

Tel.: + 34 973 46 81 15

Fax.: + 34 973 46 81 06

sudamerica@leds-c4.com

Middle East Countries

Tel.: + 34 973 46 81 08

Fax.: + 34 973 46 81 06

dep-export@leds-c4.com

