

LA CREU

CATALOGO GENERAL
GENERAL CATALOGUE
2009



MODUL
ELECTRO
www.modulelectro.ru

 **LED S-C4**

La Creu
MODULA
ELECTRO
www.modulelectro.ru

MODULO
ELECTRO
www.modulelectro.ru

Un año más nos complace presentarle nuestro catálogo LA CREU 2009, en el que encontrará ampliada nuestra gama de productos. Desde aquí queremos agradecerle su confianza en nuestra marca y confirmarle nuestra voluntad de seguir dando una respuesta a sus expectativas.

Once again this year we are pleased to introduce our catalogue LA CREU 2009, which contains our expanded range of lighting fixtures. Likewise, we take this opportunity to thank the many customers who place their trust in our brand and to reaffirm our will to continue meeting their expectations.

De nouveau cette année, nous sommes heureux de présenter notre catalogue LA CREU 2009, qui contient l'ensemble de notre gamme de luminaires. Par la même occasion, nous remercions les nombreux clients qui nous font confiance, et nous affirmons de nouveau notre volonté de poursuivre la recherche de leur satisfaction.

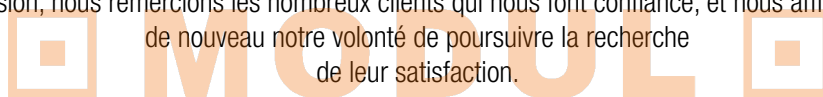

ELECTRO

Es freut uns Ihnen ein weiteres Jahr wieder unseren Katalog LA CREU 2009 vorstellen zu können. Von hier aus wollen wir Ihnen unseren besten Dank für das in unsere Produktmarke gelegte Vertrauen ausdrücken und Ihnen hiermit versichern, dass wir uns auch weiterhin bemühen werden Ihren Erwartungen und Bedürfnisse nachzukommen.

Ancora una altra volta quest'anno abbiamo il piacere di presentari il nostro catalogo LA CREU 2009. Contiene una gamma piu'vasta di lampade. Con l'occasione ringraziamo i nostri numerosi clienti che hanno avuto fiducia nel Nostro marchio ed e'nostra volonta'continuare questo rapporto.

Um ano mais, temos o prazer de apresentar o nosso catálogo LA CREU 2009, onde encontrará todas as novidades da nossa gama. Desde aquí queremos agradecerlhe a sua confiança na nossa marca e confirmarlhe o nosso desejo de prosseguir dando uma resposta cada vez mais adequada às suas expectativas.

**Apliques y Plafones · Wall and Ceiling fixtures · Appliques et Plafoniers ·
Wandleuchten und Deckenleuchten · Aplique e Plafoniere · Apliques e Plafones**



Brooklyn..... 11



Cumbia..... 16



Marc..... 19



New York..... 22



Stick..... 27



Twist..... 29



San Francisco... 36



Carla..... 45-46-47



Frame..... 52-53



Menorca..... 55-56



Denver..... 63



Dover..... 65

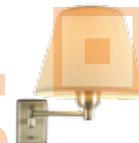

Canarias..... 69

MODULA
ELECTRO
www.modulelectro.ru



Lyon..... 71



Coimbra..... 73



Laura..... 75



Fusta..... 78



Cambridge..... 91



Devon..... 93



Edimburgo..... 95



Barca..... 100



Leather..... 105



Provenza..... 118-119



Chicago..... 107



Comba..... 111



Straight..... 113-114



Stringer..... 115



Xenia..... 122-123-124

**Apliques y Plafones · Wall and Ceiling fixtures · Appliques et Plafoniers ·
Wandleuchten und Deckenleuchten · Applique e Plafoniere · Apliques e Plafones**



Cairo..... 125



Martina..... 127



Sabana..... 129



Bristol..... 131-133



Balmoral..... 135



Llit..... 137



Book..... 139



Bed..... 141



Wall..... 142



Oxford..... 143



Track..... 145



Wing..... 147



Alpen..... 149



Alu..... 151-152

MODULO
ELECTRO
www.modulelectro.ru



Avila..... 155



Bremen..... 157



Candle..... 158



Sunny..... 159



Cannes..... 161



Glass..... 163



Granada..... 165



Half..... 167



Make Up..... 169



Niza..... 171-173



Oslo..... 175



Parma..... 176



Round..... 177



Siena..... 179



Newport..... 181

**Apliques y Plafones · Wall and Ceiling fixtures · Appliques et Plafoniers ·
Wandleuchten und Deckenleuchten · Applique e Plafoniere · Apliques e Plafones**



Toledo..... 183



Venecia..... 185



Lugo..... 187-188



Tils..... 189



Maya..... 191



Dakar..... 193



Kenya..... 195



Mali..... 197-198



Practic..... 199



Veronese..... 201-202-203



Wood..... 205-206-207-208



Flash..... 210-211



Orange..... 212-213



Shine..... 215-216-217

MODULO
ELECTRO
www.modulelectro.ru



Modena..... 219-220-221



Tech..... 224-225



Luxe..... 227



Split..... 229



Dresde..... 231



Verona..... 233



Bath..... 234-235



Lorient..... 237



Onda..... 239



Toilet..... 241



Toilet Q..... 243



Reflex..... 245-247

Colgantes • Pendants • Suspensions • Pendelleuchten • Pendenti • Pendentes



Brooklyn..... 12



Cumbia..... 16



Pop..... 25



Twist..... 30



Elix..... 31



San Francisco..... 35-37



Dress To Kill..... 39



Lisboa..... 41



Carla..... 47-49



Frame..... 51



Menorca..... 57



Nimes..... 60



Laura..... 75



Fusta..... 78-79-80



Up & Down..... 87

MODULO ELECTRO
www.modulelectro.ru



Barca..... 99



Pool..... 103



Wave..... 109



Comba..... 111



Straight..... 113



Provenza..... 117



Xenia..... 121



Tech..... 223

**Sobremesas · Table lamps · Lampes de table · Tischleuchten
Da tavolo · Candeeiros de mesa**



Brooklyn..... 11



Cumbia..... 15



Marc..... 19



New York..... 23



Stick..... 27



Twist..... 29



Madison..... 33



San Francisco..... 36



Lisboa..... 41



Brest..... 43



Carla..... 45



Frame..... 52



Messina..... 58



Nantes..... 59

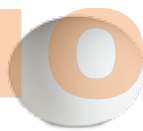

Nimes..... 60



Milan..... 61



Denver..... 63



Dover..... 67



Canarias..... 69



Lyon..... 71



Coimbra..... 73



Laura..... 76



Fusta..... 81



Up & Down..... 87



Cambridge..... 91



Devon..... 93



Edimburgo..... 95



Versalles..... 97



Barca..... 101



Leather..... 105



Chicago..... 107



Magma..... 110



Provenza..... 118-119



Martina..... 127



Llit..... 137

MODULO
ELECTRO
www.modulelectro.ru

**Pies salón • Floor lamps • Lampadaires • Stehleuchten
Piedistallo da salone • Candeeiros de sala**

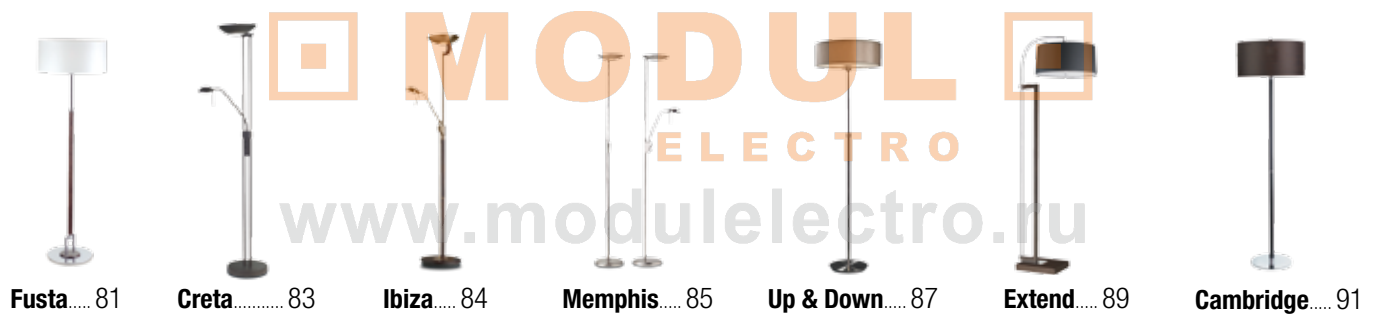

Ventilación • Ventilation • Ventilation • Ventilazione • Ventilação • Ventilation

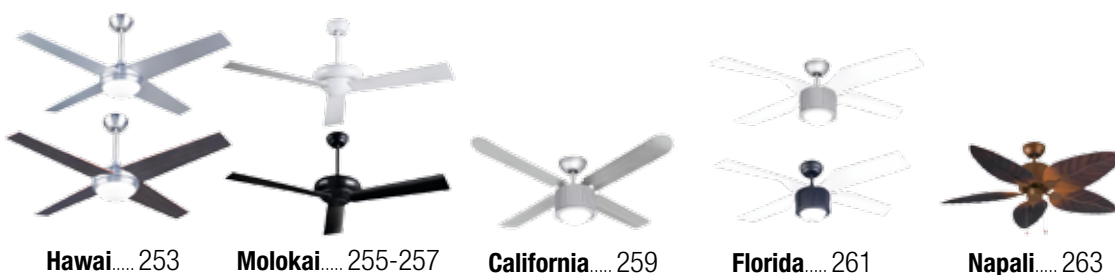



MODULO
ELECTRO
www.modulelectro.ru

BROOKLYN

21 Cromo
Chrome
Chrome
Chrom
Cromo
Cromo

14 Pantalla de tela blanca incluida
White fabric shade included
Abat-jour blanc en tissu compris
Stoffchirm weiss inklusiv
Schermo bianco compresa
Âbat-jour branco incluído

05 Pantalla de tela negra incluida
Black fabric shade included
Abat-jour noir en tissu compris
Stoffchirm schwarz inklusiv
Schermo nero compresa
Âbat-jour preto incluído



05-2775-21-05 *

05-2775-21-14

1 x E-27 Max. 60W esf. $\varnothing 45$ / 1 x PL Elec. E-27 15W

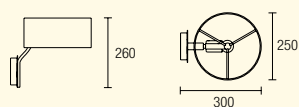

MODULO
ELECTRO
www.modulelectro.ru

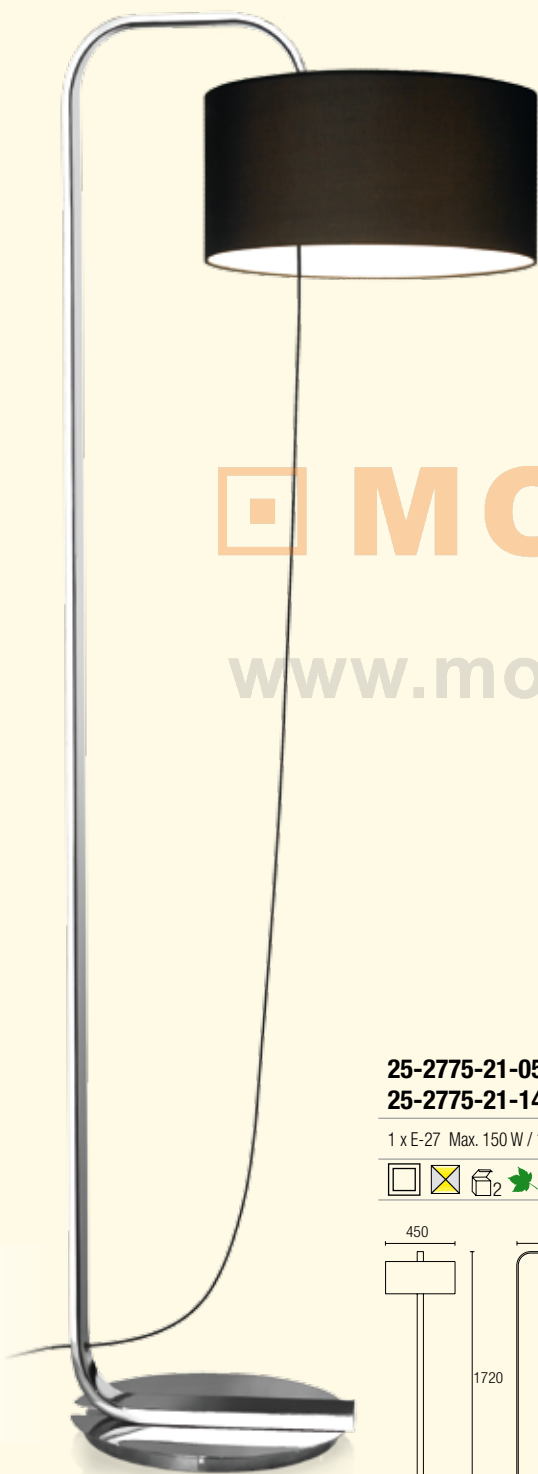

25-2775-21-05 *

25-2775-21-14

1 x E-27 Max. 150 W / 1 x PL Elec. E-27 30W

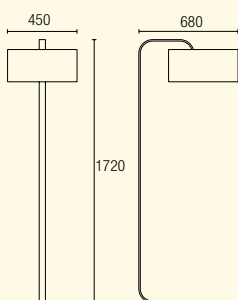
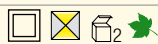

10-2775-21-05

10-2775-21-14 *

1 x E-27 Max. 60W esf. $\varnothing 45$ / 1 x PL Elec. E-27 15W

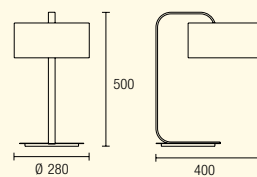
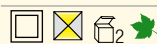



MODULO
ELECTRO
www.modulelectro.ru

00-2775-21-05

00-2775-21-14 *

2 x E-27 100W / PL Elec. 2 x 20W

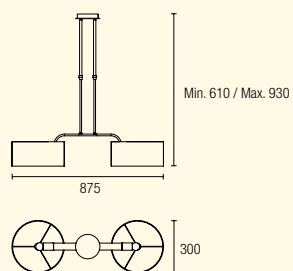
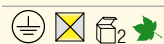



MODULO ELECTRO
www.modulelectro.ru

00-2776-21-05 *

00-2776-21-14

4 x E-27 60W / PL Elec. 4 x 15W

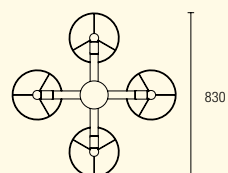
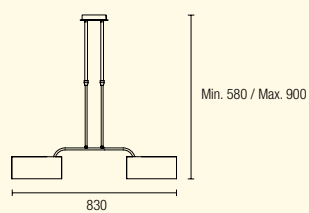
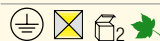



MODULO
ELECTRO
www.moduloelectro.ru

CUMBIA

21 Cromo
Chrome
Chrome
Chrom
Cromo
Cromo

AS Pantalla negro brillante / blanco brillante / cromo
Shining black / shining white / chrome shade
Abat-jour noir brillant/ blanc brillant / chrome
Schirm schwarz / glänzend weiss / schirm chrom
Paralume nero brillante / bianco brillante / cromo
Cupula preto brilhante / branco brilhante / cromo



10-2785-21-AS

2 x PL Elec. E-27 Max. 16W PHILIPS included

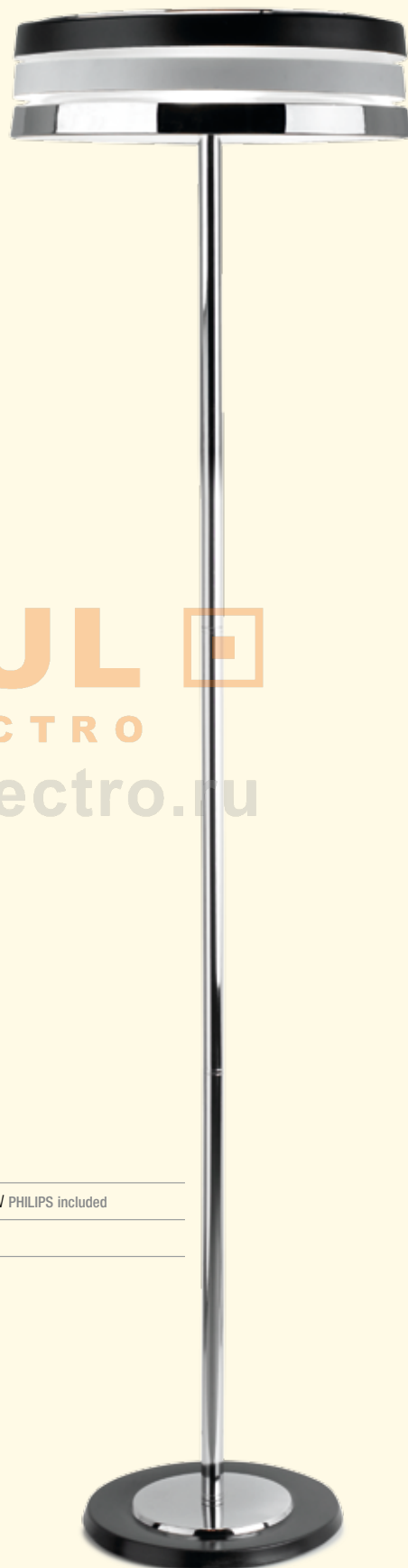
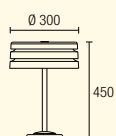
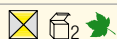

25-2785-21-AS

3 x PL Elec. E-27 Max. 20W PHILIPS included

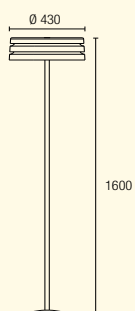
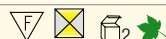

MODULO
ELECTRO
www.modulelectro.ru



MODULO
ELECTRO
www.modulelectro.ru

05-2785-21-AS

2 x PL Elec. E-27 Max. 20W PHILIPS included

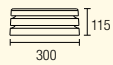
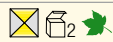

00-2785-21-AS

3 x PL Elec. E-27 Max. 20W PHILIPS included

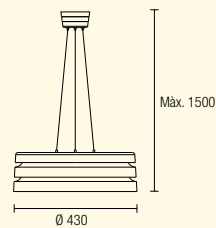
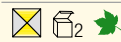

MODUL
ELECTRO
www.modulelectro.ru



337-AL

1 x E-27 PAR 30 Max. 75W

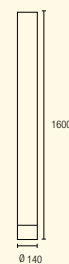

ABERDEEN

- | | |
|---|---|
| <p>AL Aluminio
Aluminium
Aluminium
Aluminium
Aluminio
Aluminio</p> | <p>Policarbonato opal mate
Matt opal polycarbonate
Policarbonate opal mat
Opales Polikarbonat matt
Policarbonato opalina opaco
Policarbonato opal fosco</p> |
|---|---|



MODUL
ELECTRO
www.modulelectro.ru

MARC

81 Niquel satinado
Satin nickel
Nickel satiné
Nickel matt
Níchel satinato
Níquel acetinado

14 Pantalla plisada blanca incluida
White pleated shade included
Abat-jour plissé blanc compris
Wiesser plissierter schirm inklusiv
Paralume bianco pieghettato incluso
Cupula plissada branca inclusa

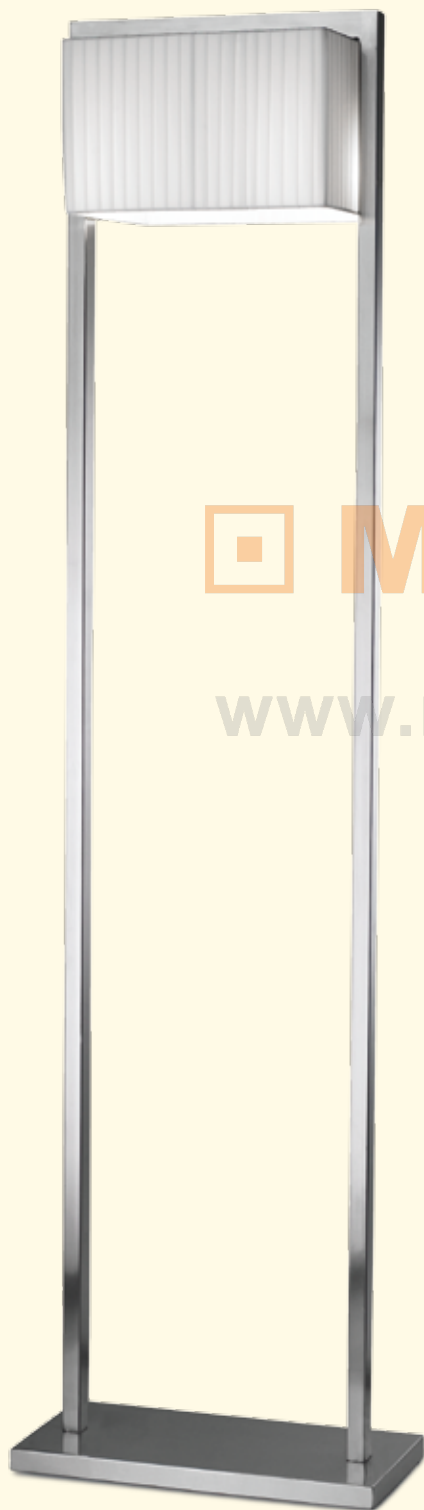

25-2827-81-14

2 x E-27 Max. 75W /
2 x PL Elec. E-27 20W

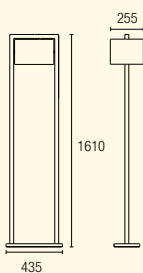
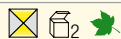

05-2827-81-14

2 x E-27 Max. 60W esf. ø45 /
2 x PL Elec. E-27 15W

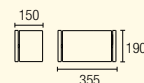

MODULO
ELECTRO
www.modulelectro.ru



10-2827-81-14

2 x E-27 Max. 60W esf. ø45 /
2 x PL Elec. E-27 15W

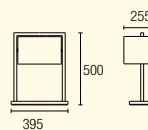
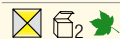



MODULO
ELECTRO
www.modulelectro.ru

NEW YORK

21 Cromo
Chrome
Chrome
Chrome
Cromo
Cromo

14 Pantalla de tela blanca incluida
White fabric shade included
Abat-jour blanc en tissu compris
Stoffschirm weiss inklusiv
Schermo bianco compresa
Âbat-jour branco incluído

10 Pantalla de tela naranja incluida
Orange fabric shade included
Abat-jour orange en tissu compris
Orange stoff schirm inklusiv
Schermo arancione compresa
Cupula de tela laranja inclusa

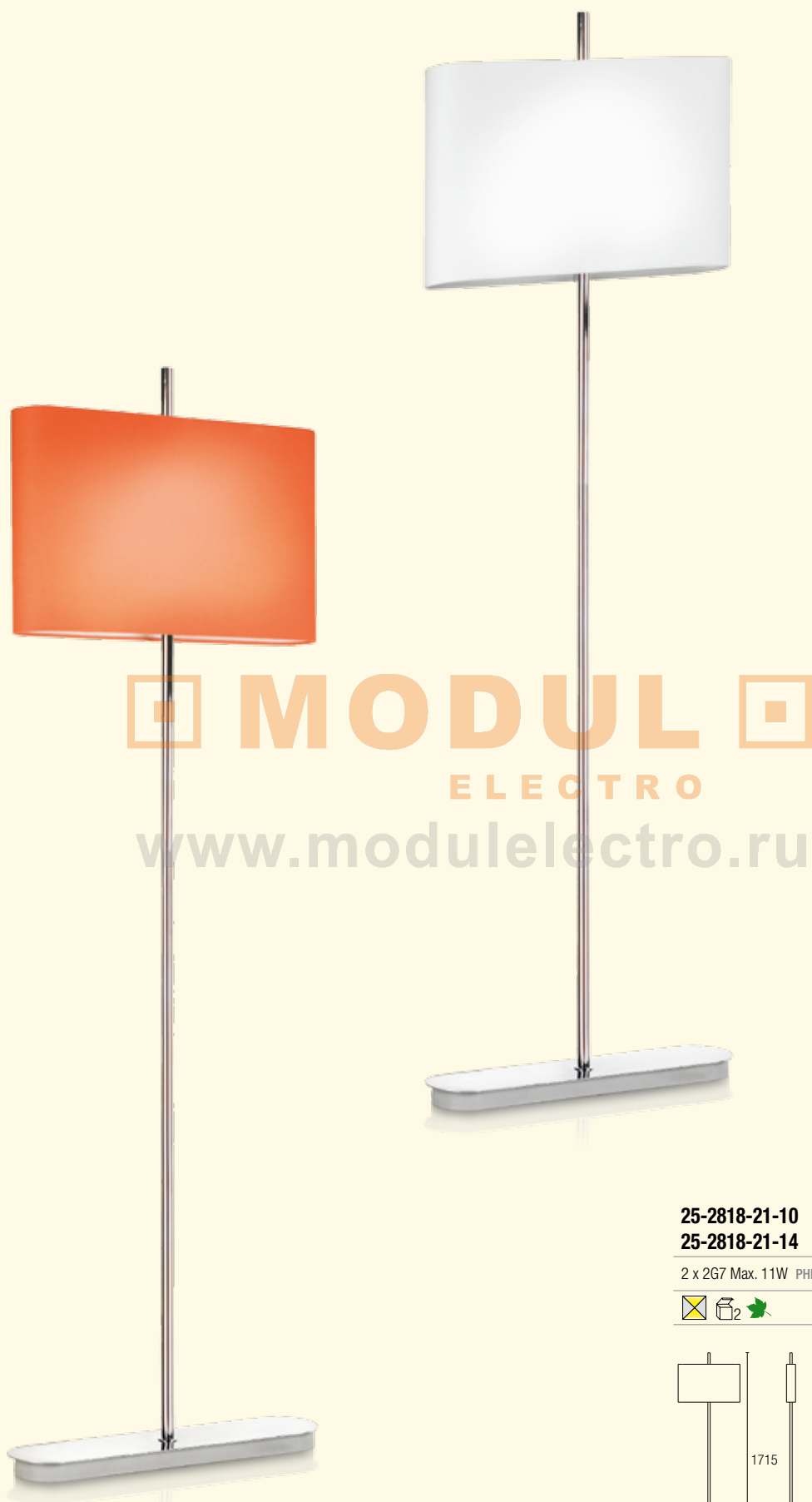

MODULO
ELECTRO
www.modulelectro.ru

25-2818-21-10

25-2818-21-14

2 x 2G7 Max. 11W PHILIPS included

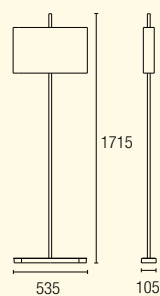
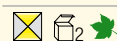



MODULO
ELECTRO

www.modulelectro.ru



05-2818-21-10
05-2818-21-14

2 x 2G7 Max. 9W PHILIPS included

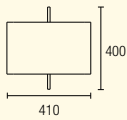
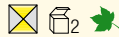



MODULO
ELECTRO
www.modulelectro.ru

10-2818-21-10
10-2818-21-14

2 x 2G7 Max. 9W PHILIPS included

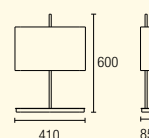
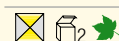



MODUL
ELECTRO
www.modulelectro.ru

POP

21 Cromo
Chrome
Chrome
Chrom
Cromo
Cromo



BC Pantalla serigrafiada no incluida
Serigraphic shade not included
Abat-jour serigraphié non compris
Serigraphie schirm nicht inklusiv
Paralume serigrafato no incluso
Cupula serigrafada não inclusa



Para conjunto completo solicite referencias de luminaria y pantalla
For complete set please order by separate fixture and shade references

(new)

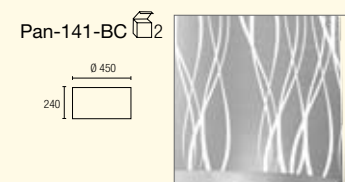
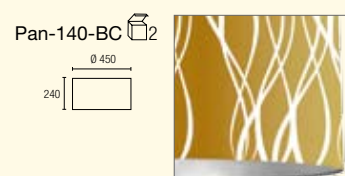
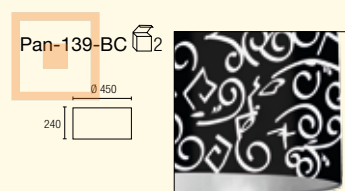
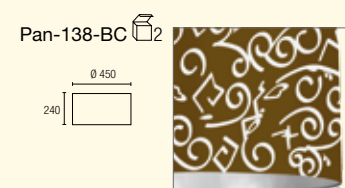
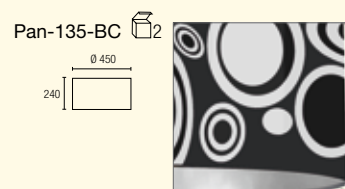
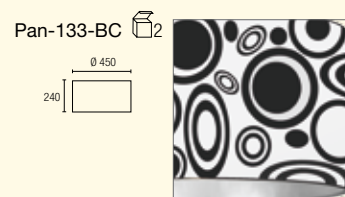
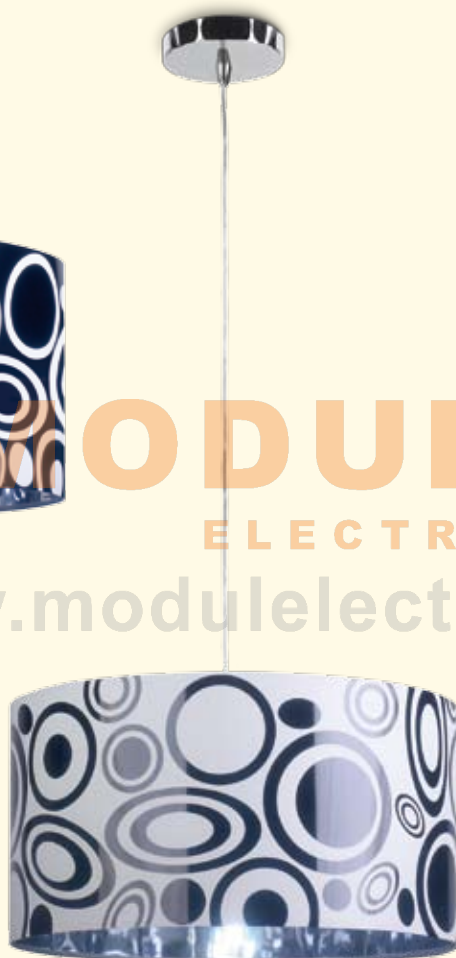

00-2843-21-21 + Pan 135-BC *

1 x E-27 Max. 150W / 1 x E-27 PL Elec 23W

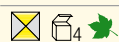

Tubo extensible
Telescopic tube

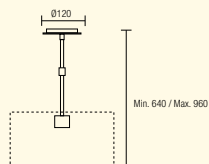

00-2844-21-21 + Pan 133-BC *

1 x E-27 Max. 150W / 1 x E-27 PL Elec 23W

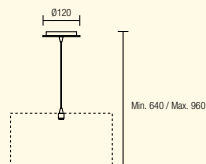
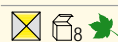

MODUL
ELECTRO
www.modulelectro.ru

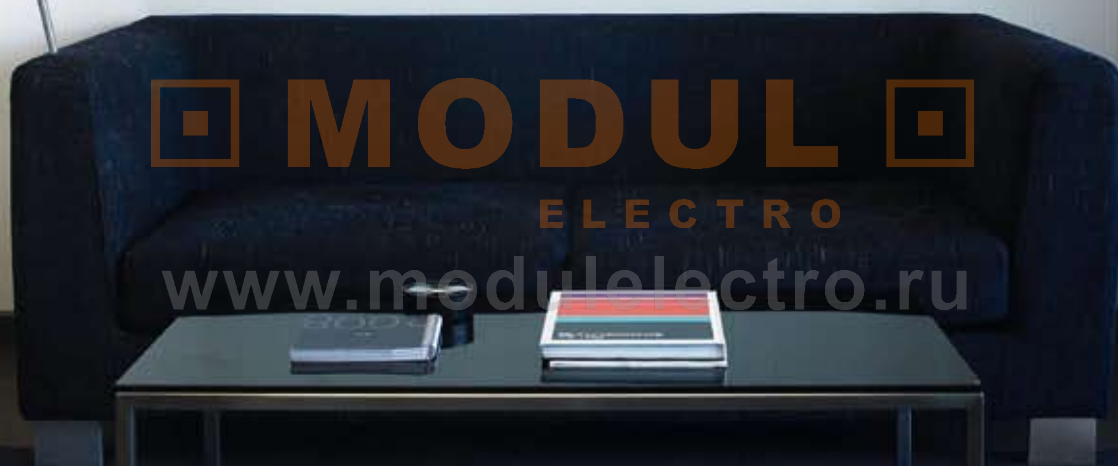

STICK

N3 Pintado gris
 Grey painted
 Peinture grise
 Grau lackiert
 Grigio pintato
 Pintado cinza

14 Pantalla plisada blanca incluida
 White pleated shade included
 Abat-jour plissé blanc compris
 Weisser plissierter schirm inklusiv
 Paralume piegato incluso
 Cupula plisada branca inclusa

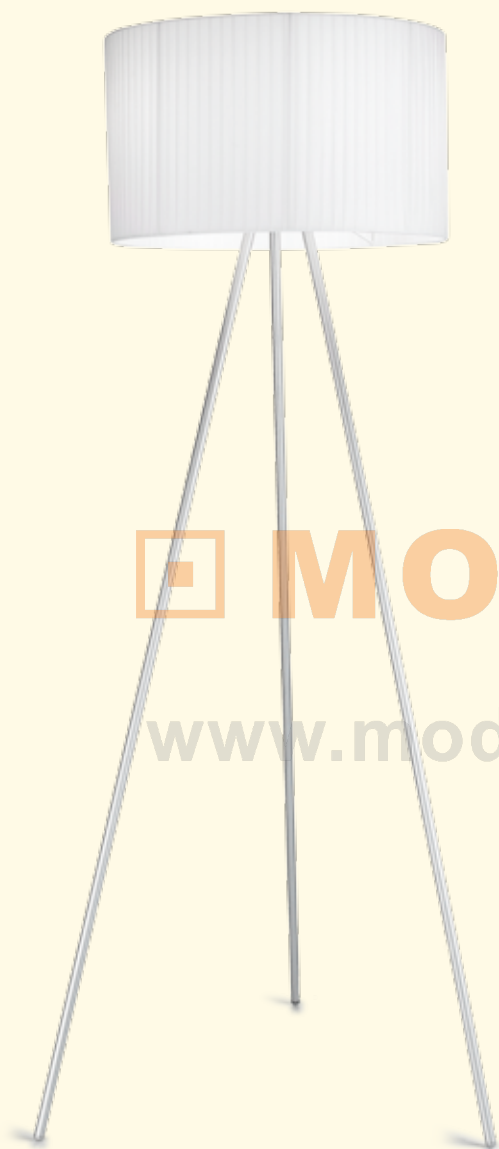
**25-2828-N3-14**

3 x E-27 Max. 60W / 3 x PL Elec. E-27 20W

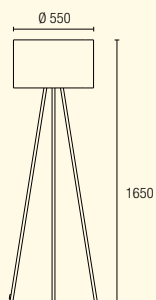
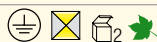
**05-2828-N3-14**

1 x E-27 Max. 60W / 1 x PL Elec. E-27 20 W

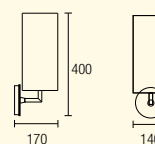
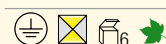

MODULO
ELECTRO
www.modulelectro.ru

**10-2828-N3-14**

1 x E-27 Max. 100W / 1 x PL Elec. E-27 20W

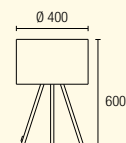
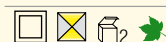



MODUL
ELECTRO
www.modulelectro.ru

TWIST

81 Níquel satinado
Satin nickel
Nickel satiné
Nickel matt
Nichel satinato
Níquel acetinado

14 Pantalla de tela blanca incluida
White fabric shade included
Abat-jour blanc en tissu compris
Stoffchirm weiss inklusiv
Schermo bianco compresa
Âbat-jour branco incluído



MODULO
ELECTRO
www.modulelectro.ru



05-2817-81-14

1 x E-27 Max. 60W esf. ø45 / 1 x E-27 PL Elec 15W

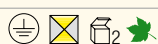

Pantalla rotatoria
Rotatory shade

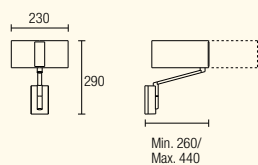

10-2817-81-14

1 x E-27 Max. 60W esf. ø45 / 1 x E-27 PL Elec 15W

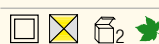

Pantalla rotatoria
Rotatory shade

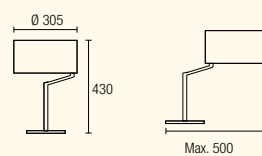

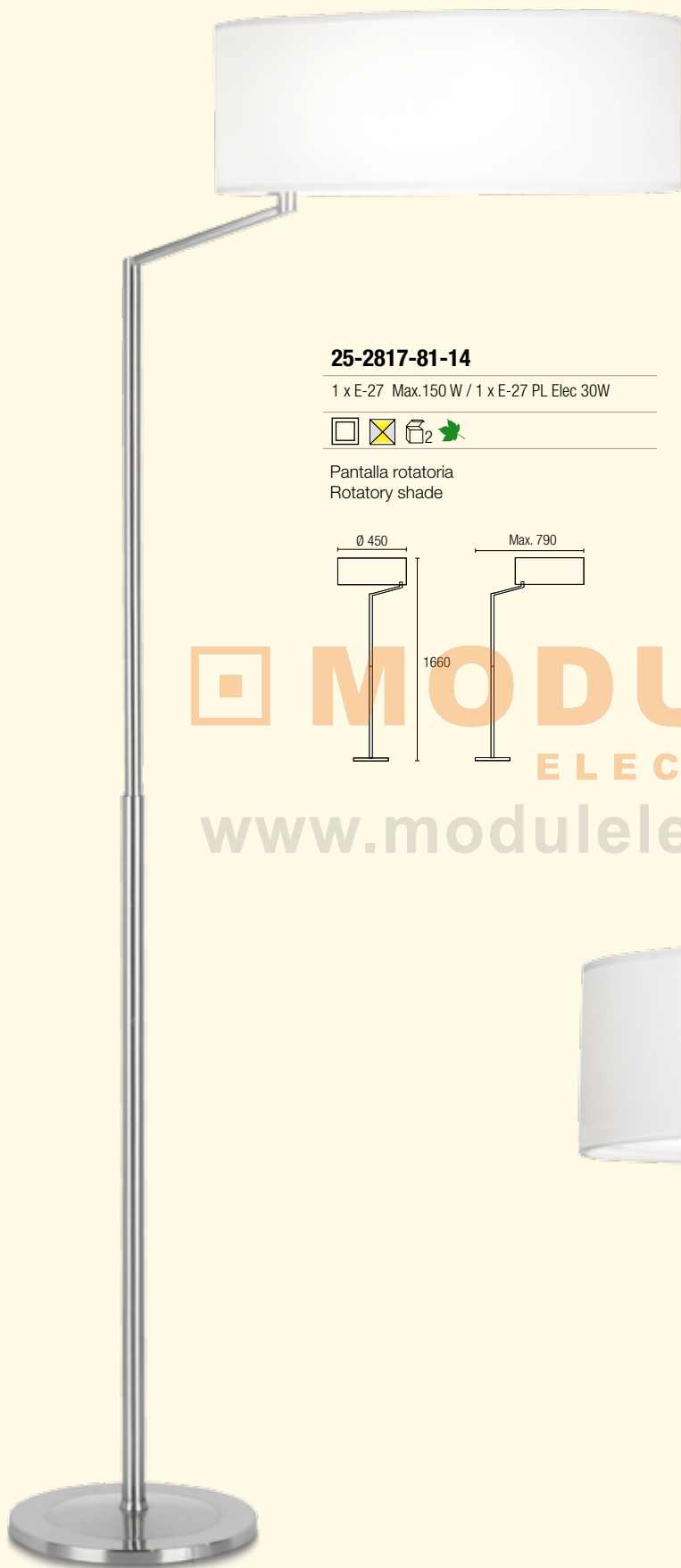

25-2817-81-14

1 x E-27 Max.150 W / 1 x E-27 PL Elec 30W



Pantalla rotatoria
Rotatory shade

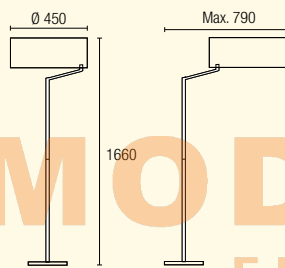

MODULO
ELECTRO
www.modulelectro.ru

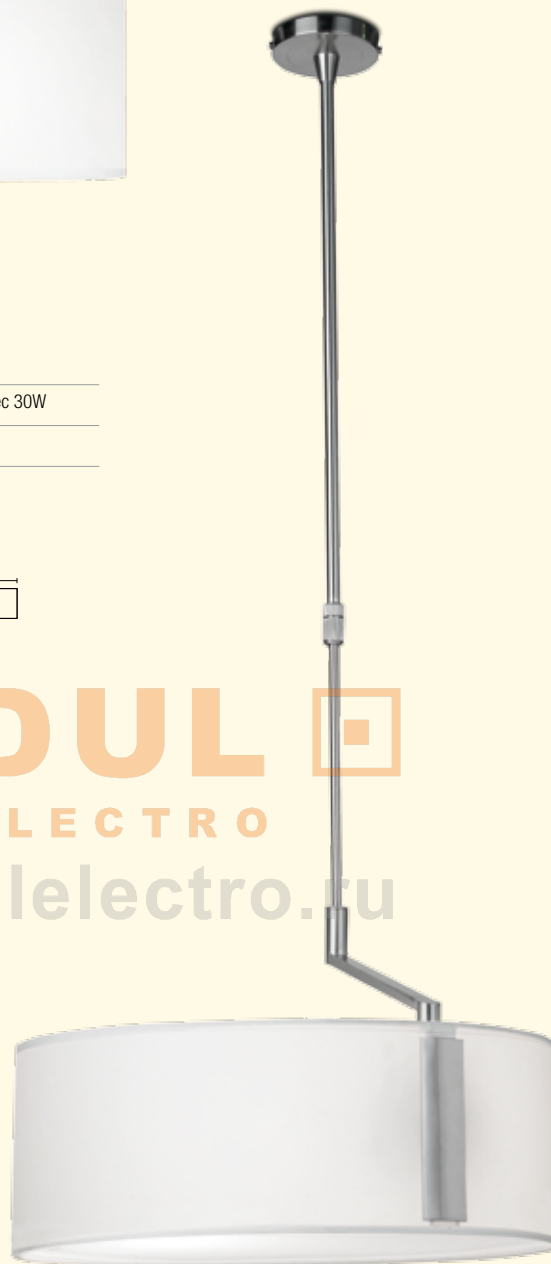

00-2817-81-14

1 x E-27 Max. 150W / 1 x E-27 PL Elec 30W

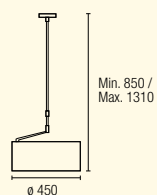

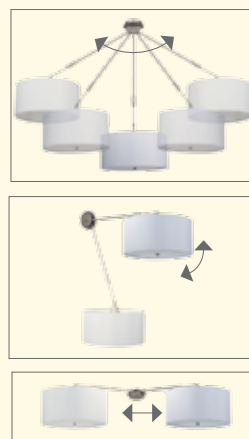
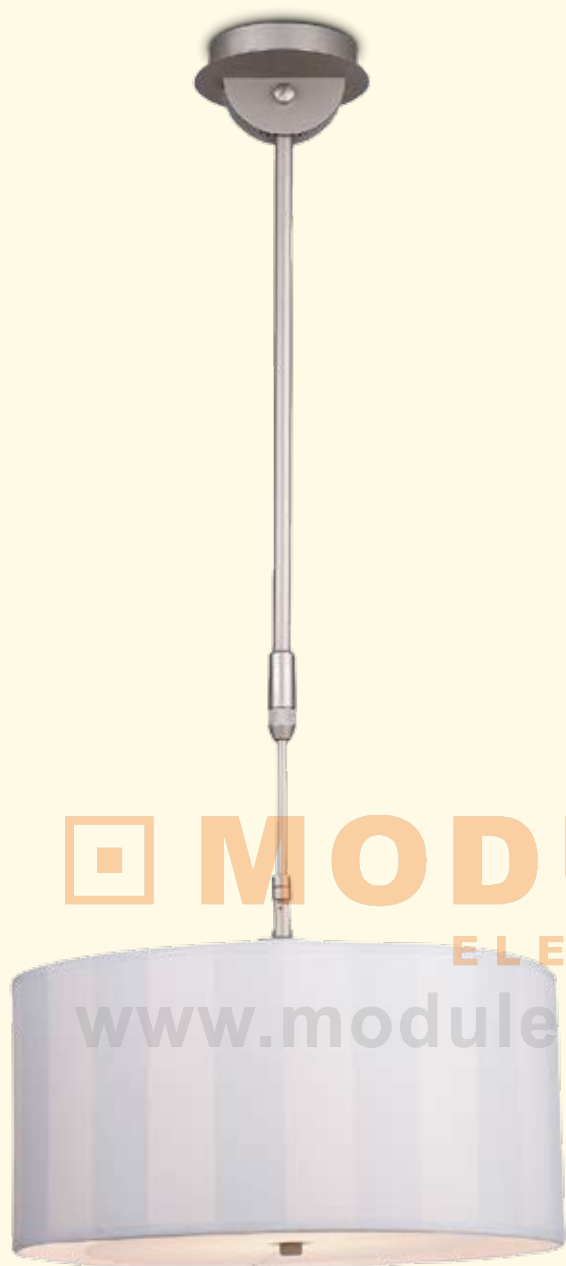

MODULO
ELECTRO
www.modulelectro.ru

260-NM

1 x E-27 Max. 100W

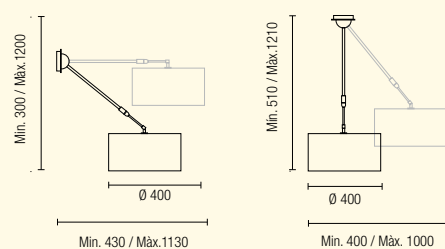

ELIX



NM Níquel mate
Nickel matt
Nickel mat
Nickel matt
Níquel opaco
Níquel fosco

Pantalla de tela incluida
Fabric shade included
Abat-jour en tissu inclus
Mit Stoffschirm
Schermo in tela compresa
Âbat-jour de tecido incluído



MODUL
ELECTRO
www.modulelectro.ru

MADISON

-  **14** Madera pintada / pantalla de tela blanca
Wood painted / White fabric shade
Bois peint / Abat-jour en tissu blanc
Lackiertes Holz / Stoffschirm weiss
Legno pintato / Paralume bianco
Madeira pintada / cupula branca
-  **92** Madera pintada / pantalla de tela wengé
Wood painted / wenge fabric shade
Bois peint / Abat-jour en tissu wengé
Lackiertes Holz / Stoffschirm wenge
Legno pintato / Paralume wengé
Madeira pintada / cupula wengé
-  **05** Madera pintada / pantalla de tela negra
Wood painted / Black fabric shade
Bois peint / Abat-jour en tissu noir
Lackiertes Holz / Stoffschirm schwarz
Legno pintato / Paralume nero
Madeira pintada / cupula preta



10-2819-14-14
10-2819-05-05
10-2819-92-92*

1 x E-27 Max. 100W / 1 x PL Elec. E-27 20W

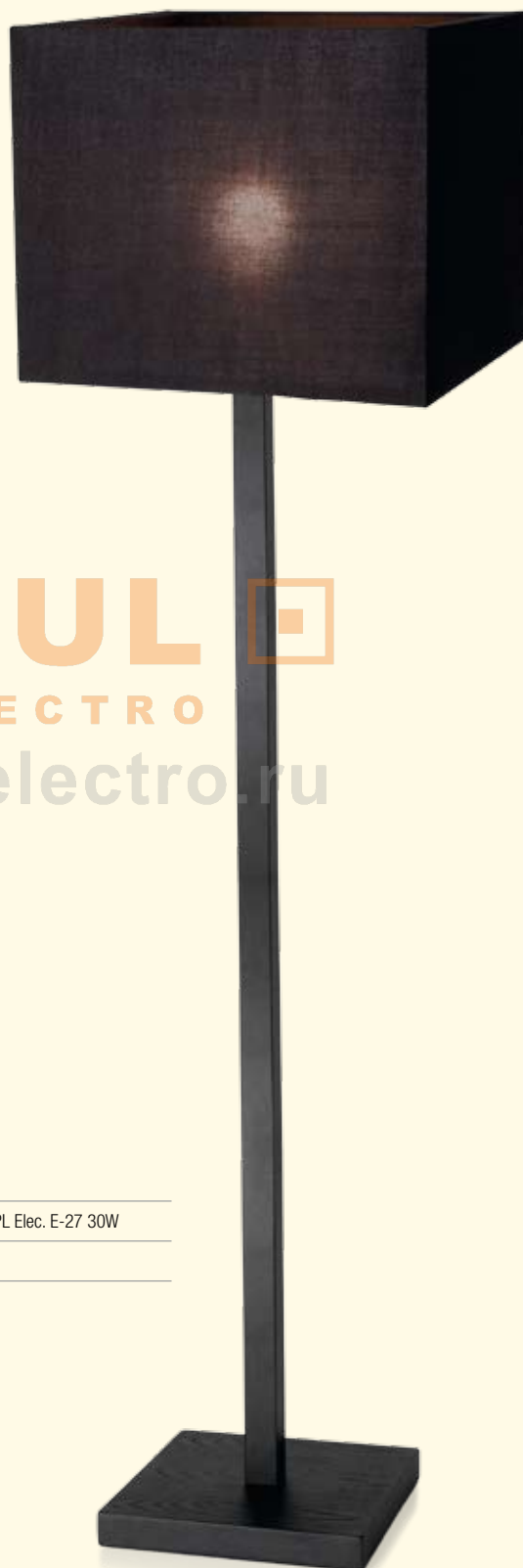
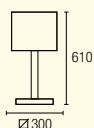
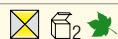

25-2819-14-14
25-2819-05-05*
25-2819-92-92

1 x E-27 Max. 150W / 1 x PL Elec. E-27 30W

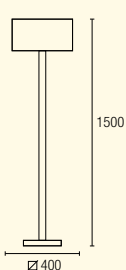
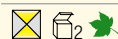

MODULO
ELECTRO
www.modulelectro.ru

MODUL ELECTRO
www.modul-electro.ru

SAN FRANCISCO

21 Cromo
 Chrome
 Chrome
 Chrom
 Cromo
 Cromo

J6 Pantalla de tela marrón incluida
 Brown fabric shade included
 Abat-jour marron en tissu compris
 Stoffchirm braun inklusiv
 Schermo marrone compresa
 Âbat-jour castanho incluído

**20-2786-21-J6**

4 x - E-27 Max. 60W / 4 x PL Elec 16W

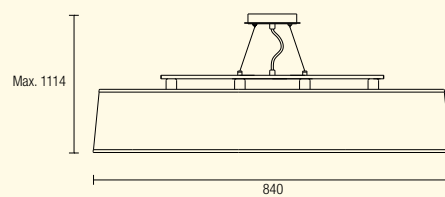
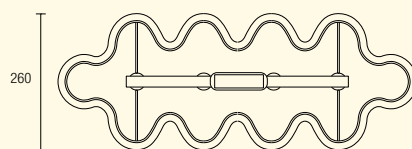



05-2786-21-J6

2 x E-27 Max. 60W / 2 x PL Elec 16W

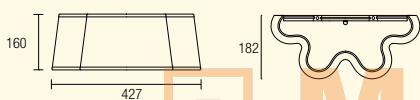
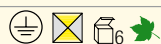

MODULO

ELECTRO

www.modulelectro.ru



10-2786-21-J6

1 x E-27 Max. 60W / 4 x PL Elec 16W

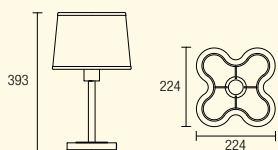

**20-2787-21-J6**

4 x E-27 Max. 60W / 4 x PL Elec 16W

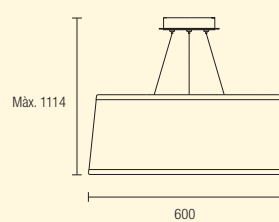
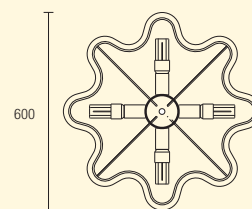



MODUL
ELECTRO

www.modul-electro.ru

DRESS TO KILL

21 Cromo
Chrome
Chrome
Chrom
Cromo
Cromo

05 Pantalla negra incluida
Black shade included
Âbat-jour noir en tissu compris
Stoffschirm schwarz inklusiv
Schermo nero compresa
Âbat-jour preto incluído

14 Pantalla blanca incluida
White shade included
Âbat-jour blanc en tissu compris
Stoffschirm weiss inklusiv
Schermo bianco compresa
Âbat-jour branco incluído

20-2691-21-05 *
20-2691-21-14

5 x G9 Max. 75W OSRAM included

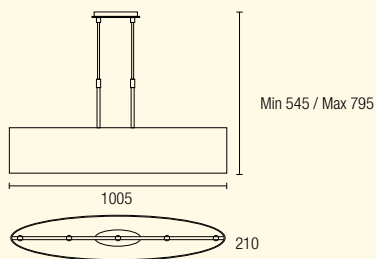

MODULO
ELECTRO
www.modulelectro.ru

00-2692-21-05 *
00-2692-21-14

5 x G9 Max. 75W OSRAM included



Kit para transformar a plafón incluido
 Set to convert it into a mounted fitting included

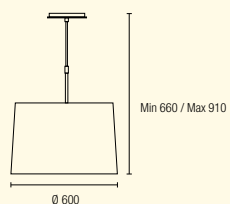

00-2691-21-05
00-2691-21-14 *

3 x G9 Max. 75W OSRAM included



Kit para transformar a plafón incluido
 Set to convert it into a mounted fitting included

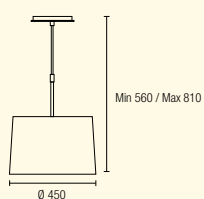



MODULO
ELECTRO
www.modulelectro.ru

LISBOA

14-14/BL Estructura lacada blanca y pantalla blanca incluida
 White lacquered structure and white shade included
 Structure laquée blanche et abat-jour blanc compris
 Weiss lackierte Armatur und weisser Schirm inklusiv
 Struttura laccata bianca e schermo bianco compresa
 Estrutura lacada branca e abat-jour branco incluído

05-05/NE Estructura lacada negra y pantalla negra incluida
 Black lacquered structure and black shade included
 Structure laquée noire et abat-jour noir compris
 Schwarz lackierte Armatur und schwarzer Schirm inklusiv
 Struttura laccata nera e schermo nero compresa
 Estrutura lacada preta e abat-jour preto incluído



00-2846-05-05 (NEW)

00-2846-14-14* (NEW)

1 x E-27 Max. 100W / 1 x PL Elect. 20W

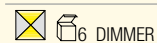

6 DIMMER

MODUL
ELECTRO

www.modulelectro.ru

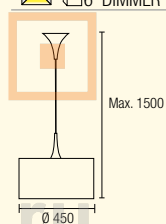

498-NE

498-BL*

1 x E-27 Max. 100W



2 FOOT DIMMER



497-NE*

497-BL

1 x E-27 Max. 60W



2 DIMMER

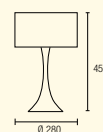



BREST

GB Gris / Blanco
 Grey / White
 Gris / Blanc
 Brau / Weiss
 Grigio / Bianco
 Cinzeto / Branco

GN Gris / Negro
 Grey / Black
 Gris / Noir
 Brau / Schwartz
 Grigio / Nero
 Cinzeto / Preto

Accesorio pinza incluido
 Clamp to desk accessory included



Para pared vertical
 For vertical wall

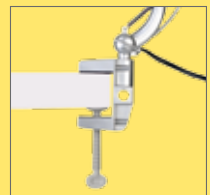

Para mesa horizontal
 For horizontal table

278-GB

1 x G23 11W included

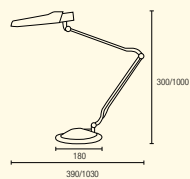
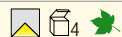

275-GN

1 x G9 Max. 60W included

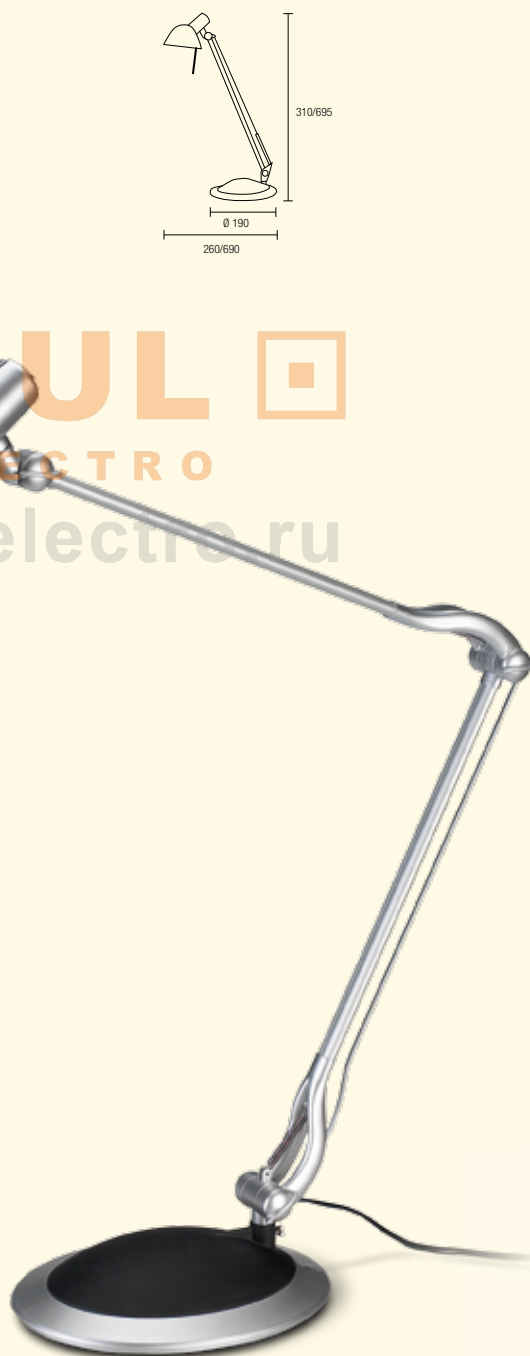
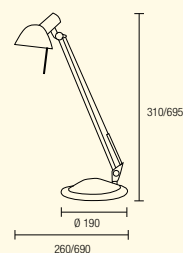
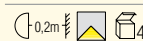

276-GN

1 x G9 Max. 60W included

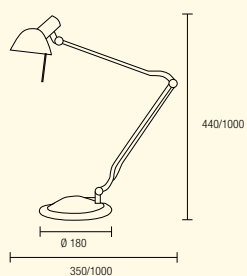
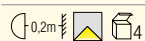

MODULO
ELECTRO
www.modulelectro.ru



CARLA

Y2 Marrón envejecido
 Old brown
 Marron vieilli
 Alt braun
 Marrone vecchio
 Castanho envelhecido

AE Vidrio Tiffany
 Tiffany glass
 Verre Tiffany
 Tiffany glas
 Vetro Tiffany
 Vidro Tiffany

15-2375-Y2-AE

5 x G9 Max. 60W OSRAM included

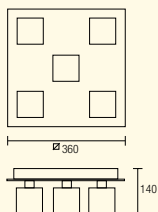
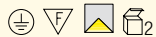

10-2374-Y2-AE

1 x G9 Max. 75W OSRAM included

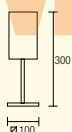

15-2376-Y2-AE *

1 x G9 Max. 75W OSRAM included



15-2377-Y2-AE

1 x R7s L=78 Max. 150W OSRAM included

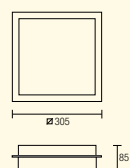

15-2378-Y2-AE

1 x R7s L=118 Max. 200W OSRAM included

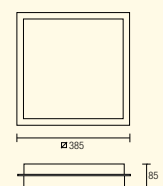

MODULO
ELECTRO
www.modulelectro.ru

05-2374-Y2-AE

1 x G9 Max. 60W OSRAM included

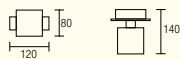
**05-2375-Y2-AE**

2 x G9 Max. 60W OSRAM included

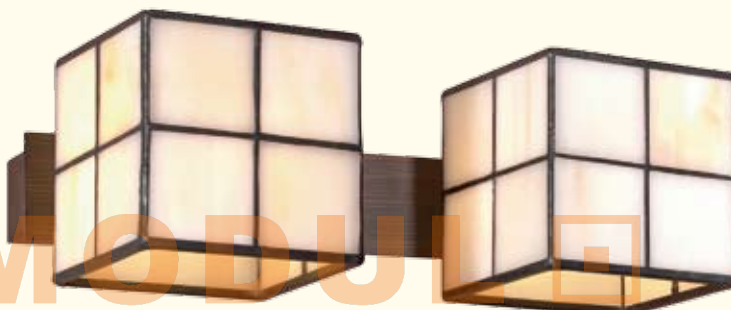
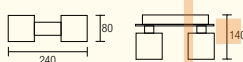

ELECTRO

www.modulelectro.ru

05-2376-Y2-AE

3 x G9 Max. 60W OSRAM included

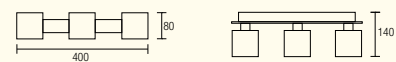



15-2374-Y2-AE

3 x G9 Max. 60W OSRAM included

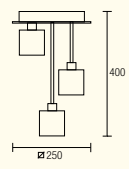

MODULO
ELECTRO
www.modulelectro.ru

20-2374-Y2-AE

4 x G9 Max. 60W OSRAM included

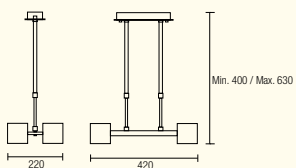



MODUL
ELECTRO
www.modulelectro.it



20-2376-Y2-AE

6 x G9 Max. 60W OSRAM included

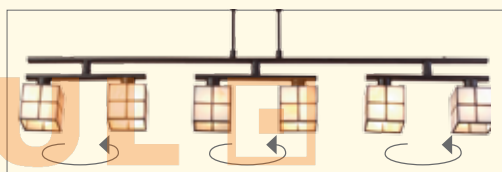
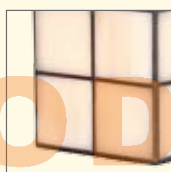
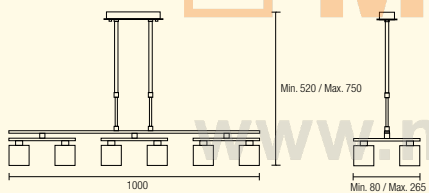

ELECTRO

www.modulelectro.ru

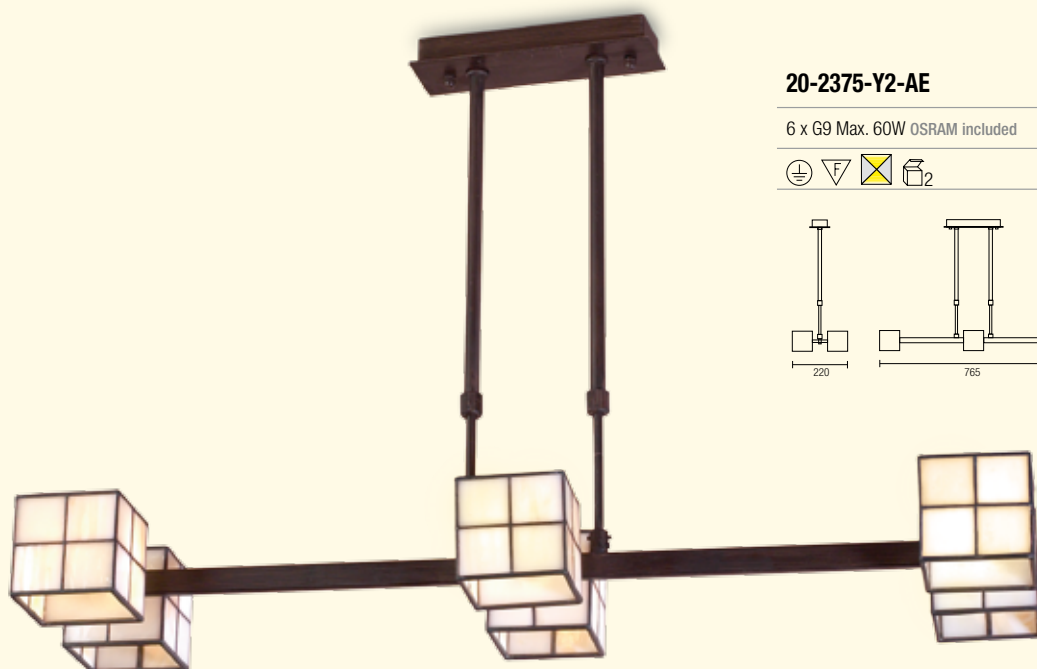

20-2375-Y2-AE

6 x G9 Max. 60W OSRAM included

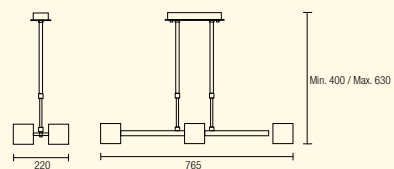

MODUL
ELECTRO
www.modulelectro.ru

FRAME

Y2 Marrón envejecido
Old brown
Marron vieilli
Alt braun
Marrone vecchio
Castanho envelhecido

14 Pantalla de tela blanca incluida
White fabric shade included
Abat-jour blanc en tissu compris
Stoffschirm weiss inklusiv
Schermo bianco compresa
Âbat-jour branco incluído

20-2569-Y2-14

4 x E-14 Max. 60W



2 Cristales satinados antideslumbrantes
2 Anti-glare satin glass

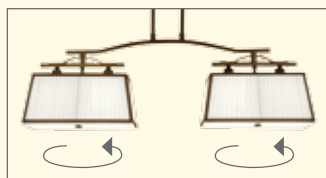

Estructuras giratorias / Rotating structures

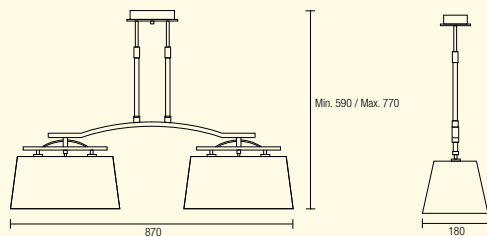
**20-2568-Y2-14**

4 x E-14 Max. 60W

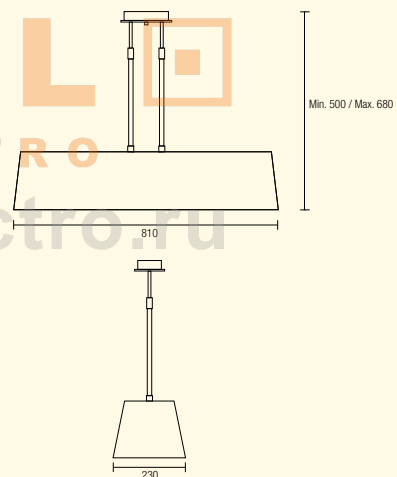

Cristal satinado antideslumbrante
Anti-glare satin glass

**00-2568-Y2-14**

3 x E-14 Max. 60W



Cristal satinado antideslumbrante
Anti-glare satin glass

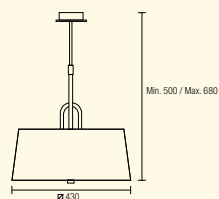

05-2569-Y2-14

2 x E-27 esf. ø 45 Max. 60W
2 x PL Elec E-27 23W GE Extra mini

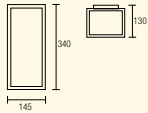
**10-2569-Y2-14**

1 x E-27 Max. 100W
+ 1 x E-27 Max. 60W

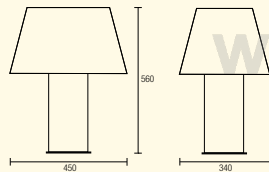

Protector de PC antideslumbrante
Anti-glare PC cover

**10-2568-Y2-14**

1 x E-14 Max. 60W
+ 1 x E-14 Max. 40W



Protector de PC antideslumbrante
Anti-glare PC cover

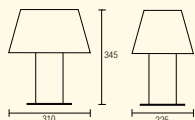



15-2570-Y2-14

1 x R7s L=118 Max. 200W OSRAM included



Cristal satinado antideslumbrante
Anti-glare satin glass

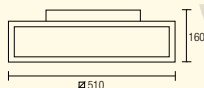

15-2569-Y2-14

1 x R7s L=118 Max. 150W OSRAM included



Cristal satinado antideslumbrante
Anti-glare satin glass

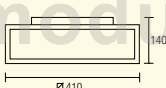

15-2568-Y2-14

1 x R7s L=118 Max. 100W OSRAM included



Cristal satinado antideslumbrante
Anti-glare satin glass

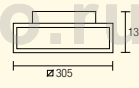

05-2568-Y2-14

2 x E-27 esf. ø 45 Max. 60W
2 x PL Elec. E-27 23W GE Extra mini

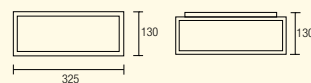



MENORCA

21 Cromo
Chrome
Chrome
Chrom
Cromo
Cromo

92 Madera oscura
Dark wood
Bois foncé
Dunkles Holz
Legno oscuro
Madeira escura



MODULO
ELECTRO
www.modulelectro.ru

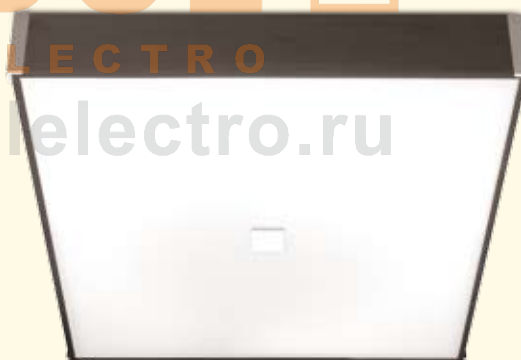

15-2598-21-92

1 x T5 tubular 22W included +
1 x T5 tubular 55W included

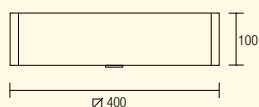

15-2597-21-92 *

1 x T5 tubular 22W included

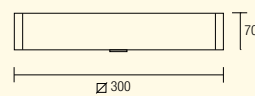



05-2597-21-92

1 x PL E-27 Max. 21W ECO OSRAM / 1 x PL Elec E-27 20W
included

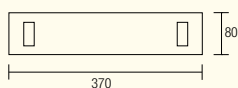

MODUL
ELECTRO
www.modulelectro.ru



05-2598-21-92

2 x PL E-27 Max. 21W ECO OSRAM / 2 x PL Elec E-27 20W included

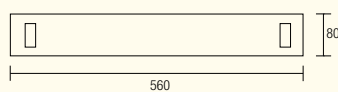
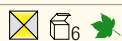

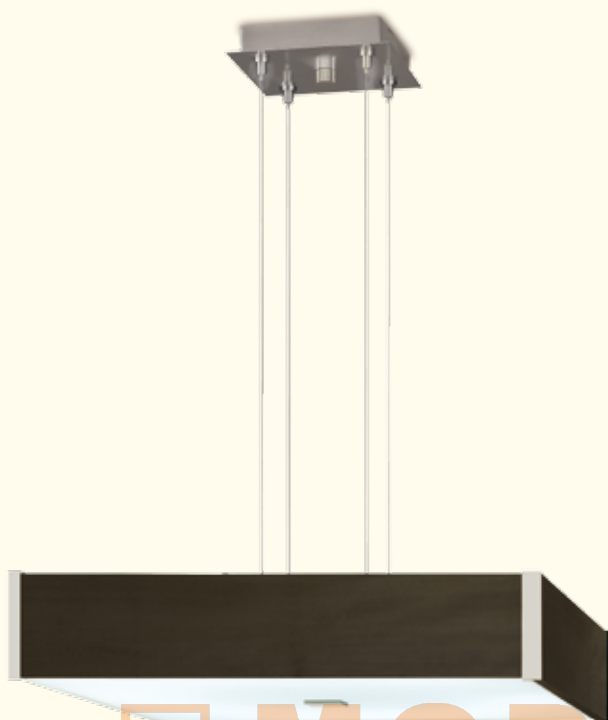
**00-2597-21-92**

1 x T5 tubular 22W included +
1 x T5 tubular 55W included

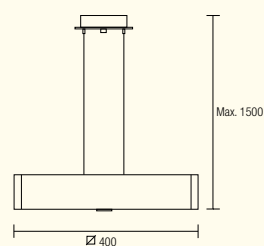

MODULO
ELECTRO

www.modulelectro.ru

20-2597-21-92

2 x 2G11 40W, included

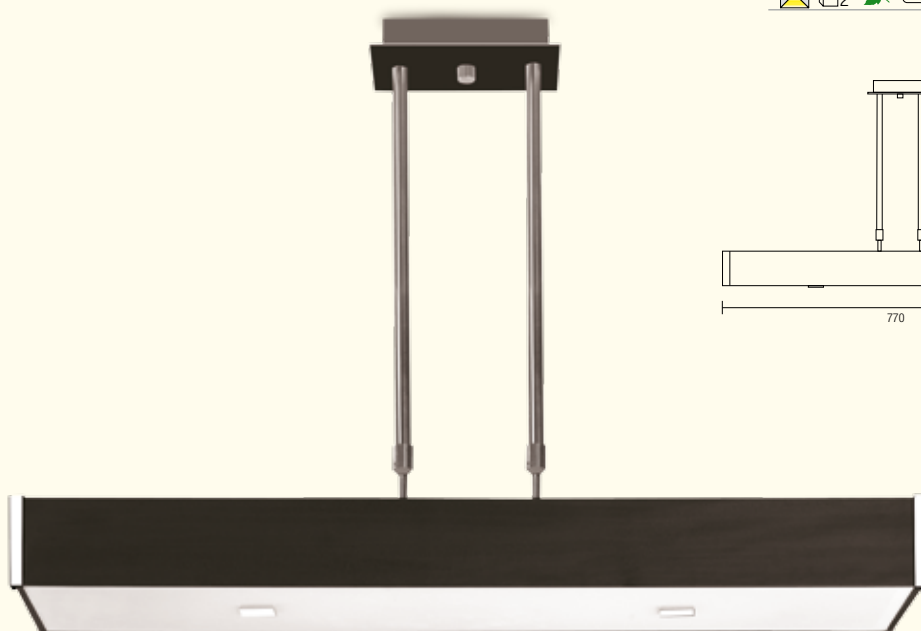
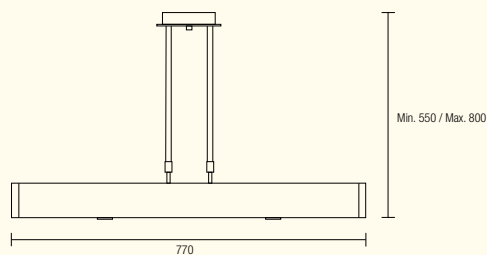



310-NS

1 x E-14 Max. 40W

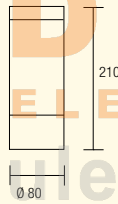

MODULO
ELECTRO
www.moduloelectro.ru

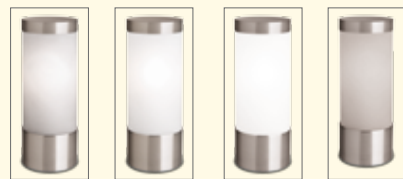

1 pulsación
1 touch

2 pulsaciones
2 touches

3 pulsaciones
3 touches

4 pulsaciones= Apagado
4 touches= Switch off

MESSINA

NS Níquel satinado
Satin nickel
Nickel satiné
Nickel matt
Níchel satinato
Níquel acetinado

Cristal satinado
Satin glass
Verre satiné
Satiniertes Glas
Cristallo satinato
Cristal acetinado



MODUL
ELECTRO

www.modulelectro.ru

150-GR

1 x E-27 Max. 60W



Pantalla de tela incluida
Fabric shade included
Âbat-jour en tissu inclus
Mit Stoffschirm
Schermo in tela compresa
Âbat-jour de tecido incluído

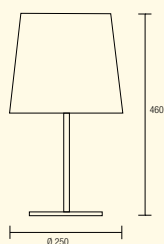

152-GR

1 x E-27 Max. 60W



Cristal opal
Opal glass
Verre opale
Opalglas
Vetro opalina
Vidro opala

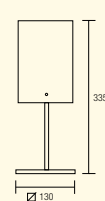

NANTES

GR Gris
Grey
Gris
Grau
Grigio
Cinzeto



300-BL

1 x E-14 Max. 40W



301-BL

1 x E-14 Max. 60W

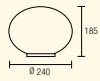

302-BL *

1 x E-27 Max. 60W

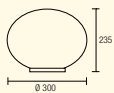

303-NS

1 x E-27 Max. 100W

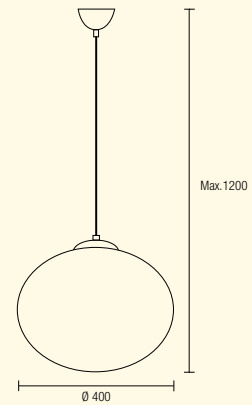

NIMES

BL Blanco
White
Blanc
Weiss
Bianco
Branco

NS Níquel satinado
Satin nickel
Nickel satiné
Nickel matt
Níchel satinato
Níquel acetinado

Cristal opal
Opal glass
Verre opale
Opalglas
Vetro opalina
Vidrio opala



MILAN

AM Níquel mate
Nickel matt
Nickel mat
Nickel matt
Nichel opaco
Níquel fosco

Pantalla de tela incluida
Fabric shade included
Âbat-jour en tissu inclus
Mit Stoffschirm
Schermo in tela compresa
Âbat-jour de tecido incluído



DENVER

 **NM** Níquel mate
Nickel matt
Nickel mat
Nickel matt
Níchel opaco
Níquel fosco

 Pantalla de tela incluida
Fabric shade included
Âbat-jour en tissu inclus
Mit Stoffschirm
Schermo in tela compresa
Âbat-jour de tecido incluído



237-NM

1 x E-27 Max. 60W

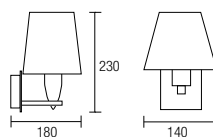

MODULO
ELECTRO
www.modulelectro.ru



240-NM

1 x E-27 Max. 100W

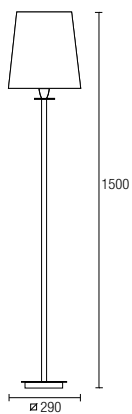

239-NM

1 x E-27 Max. 60W

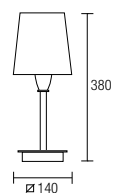



DOVER

NS Níquel satinado
Satin nickel
Nickel satiné
Nickel matt
Níchel satinato
Níquel acetinado

PP Patiné pintado
Painted antique brass
Brossé peint
Lackiertes Messing
Ottone verniciato
Patiné pintado

14 Pantalla blanca
White fabric shade
Âbat-jour blanc
Weiss stoffschirm
Schermo bianco
Âbat-jour branco

20 Pantalla beige
Beige fabric shade
Âbat-jour beige
Beige stoffschirm
Schermo beige
Âbat-jour beige



+ 172-NS PAN 103

172-NS *
172-PP

1 x E-27 Max. 60W

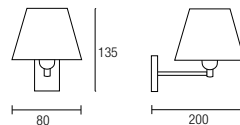

+ 171-PP PAN 103

171-NS
171-PP *

1 x E-27 Max. 60W

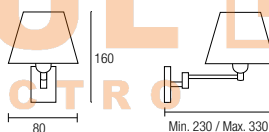

+ 170-NS PAN 103

170-NS *
170-PP

1 x E-27 Max. 60W

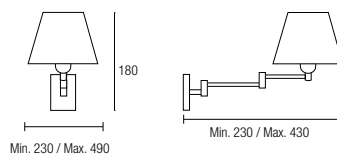

PAN-103-14



PAN 103-20

 **MODUL** 
ELECTRO
www.modulelectro.ru



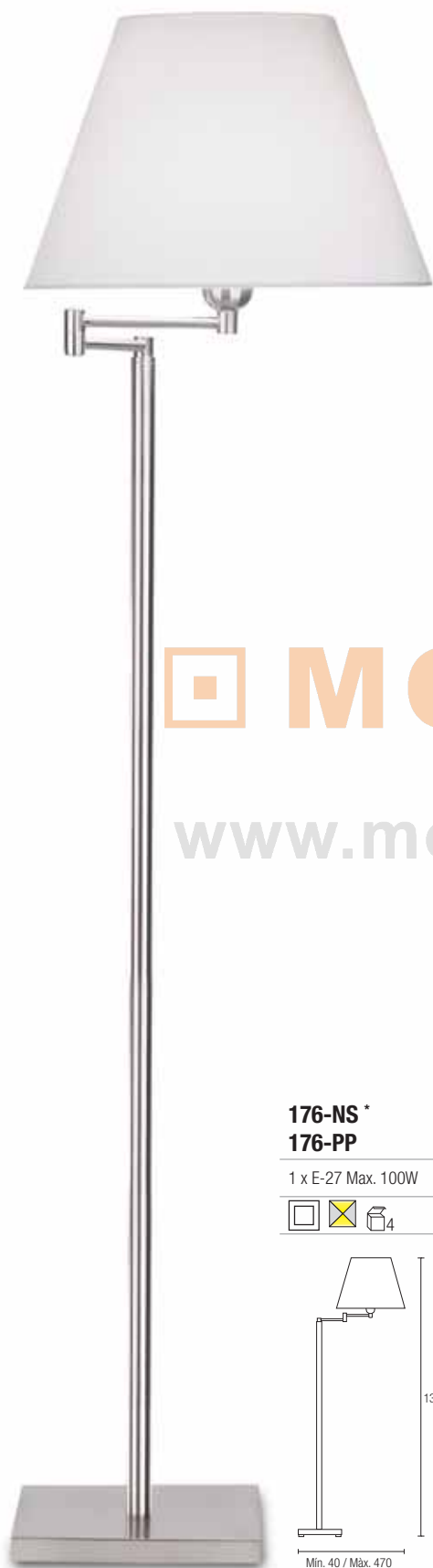

+ 176-NS PAN 104

176-NS*
176-PP

1 x E-27 Max. 100W

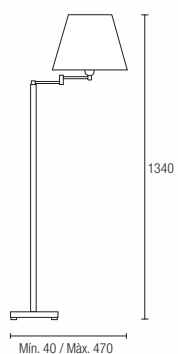

+ 174-PP PAN 103

174-NS*
174-PP

1 x E-27 Max. 60W

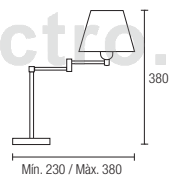

MODULO
ELECTRO
www.modulelectro.ru



PAN-103-14
PAN-104-14



PAN 103-20
PAN 104-20



MODUL
ELECTRO
www.modulelectro.ru

CANARIAS

81 Níquel satinado
Satin nickel
Nickel satiné
Satiniertes nickel
Níchel satinato
Níquel acetinado

14 Pantalla de tela blanca
White fabric shade
Âbat-jour en toile blanc
Stoffschirm weiss
Schermo in tela bianco
Âbat-jour de tecido branco



Para conjunto completo solicite referencias de luminaria y pantalla
For complete set please order by separate fixture and shade references
Pantalla (Pan 090 / Pan 104) no incluida / Shade (Pan 090 / Pan 104) Not included

25-2564-81-82 + Pan-104-14

1 x E-27 Max. 60W

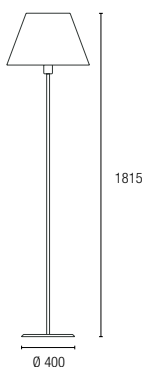
**05-2565-81-82 + Pan-090-14**

1 x E-27 Max. 60W

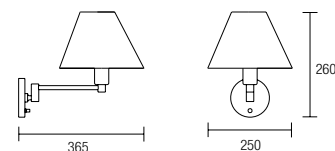

MODULO
ELECTRO

www.modulelectro.ru

**Pan-090-14
Pan-104-14****10-2564-81-82 + Pan-090-14**

1 x E-27 Max. 60W

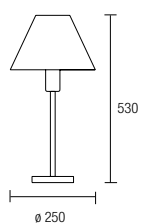



MODUL
ELECTRO
www.modulelectro.ru

LYON

■ **NS** Níquel satinado
Satin nickel
Nickel satiné
Nickel matt
Nichel satinato
Níquel acetinado

□ Pantalla de tela incluida
Fabric shade included
Âbat-jour en tissu inclus
Mit Stoffschirm
Schermo in tela compresa
Âbat-jour de tecido incluído



314-NS

1 x E-27 Max. 60W

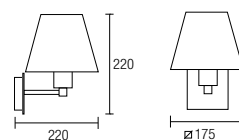

Interruptor incorporado ON-OFF
Switch included

MODULO
ELECTRO
www.modulelectro.ru

316-NS

1 x E-27 Max. 100W

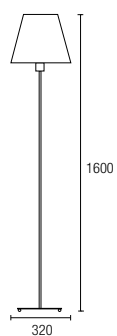

315-NS

1 x E-27 Max. 60W

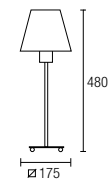



COIMBRA

■ **81-20 / NS** Níquel satinado
 Satin nickel
 Nickel Satiné
 Satiniertes Nickel
 Níchel satinato
 Níquel acetinado

Pantalla plisada de tela beige incluida
 Beige pleated fabric shade included
 Abat-jour de tissu beige plissé inclus
 Beige plissierter stoffschirm inklusiv
 Paralume beige pieghettato incluso
 Cupula plissadade tela beige inclusa

**05-2824-81-20 (new)**

1 x E-27 Max. 60W / 1 x E-27 PL Elec. Max. 20W

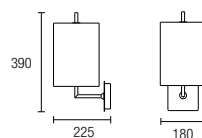

MODULO
ELECTRO
www.modulelectro.ru

**335-NS**

1 x E-27 Max. 100W / 1 x E-27 PL. Elec. Max. 23W

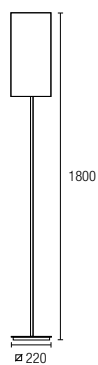
**333-NS**

1 x E-27 Max. 60W / 1 x E-27 PL Elec. Max. 20W

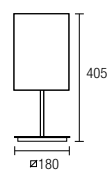



LAURA

21 Cromo y pintura wengué
 Chrome and wenge paint
 Chrome et peinture wengué
 Chrom und Wengefarbe
 Cromo e vernice wengue
 Cromagem e pintura wengue

20 Pantalla de tela beige incluida
 Beige fabric shade included
 Âbat-jour en toile beige inclus
 Mit Stoffschirm beige
 Schermo in tela beige compresa
 Âbat-jour de tecido beige incluído

ON - OFF
 DIMMER



20-2690-21-20

3 x E-27 esf ø45 Max. 60W

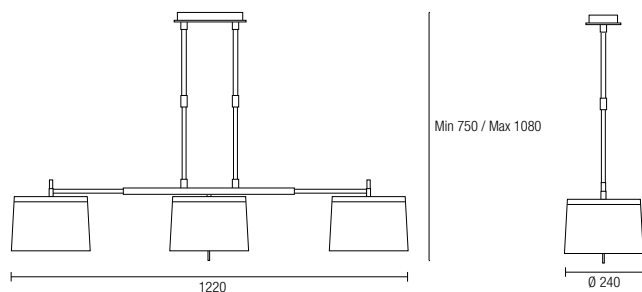
 2 DIMMER
**05-2690-21-20**

1 x E-14 Max. 100W

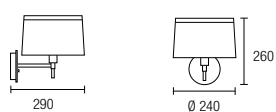
 9 DIMMER
**00-2690-21-20**

3 x E-27 Max. 60W

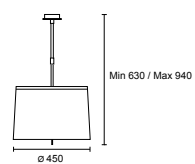
 2 DIMMER

**10-2690-21-20**

1 x E-27 esf. ø45 Max. 60W

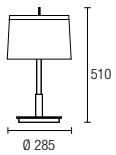
 4 DIMMER
**25-2690-21-20**

1 x E-27 Max. 100W

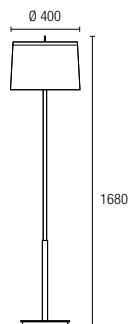
 2 FOOT DIMMER



MODUL
ELECTRO
www.modulelectro.ru

FUSTA

21 Cromo y madera wengué
Chrome and wenge wood
Chrome et bois de wengué
Chrom mit Wengé Holz
Cromo e legno wengue
Cromo e madeira wengué

20 Pantalla blanca incluida
White shade included
Âbat-jour blanc en tissu compris
Stoffschirm weiss inklusiv
Schermo bianco compresa
Âbat-jour branco incluído

 ON - OFF
DIMMER

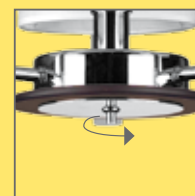
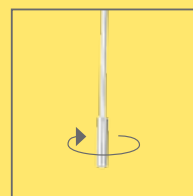



05-2380-21-20

1 x E-14 Max. 60W

 4 ON/OFF DIMMER

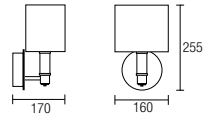

MODUL
ELECTRO
www.modulelectro.ru



00-2380-21-20

3 x E-27 Max. 60W esf. Ø 45

 2 ON/OFF DIMMER

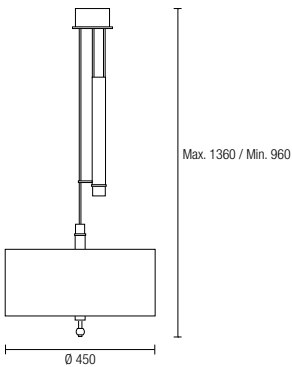

05-2381-21-20

1 x E-14 Max. 60W

 6 ON/OFF DIMMER

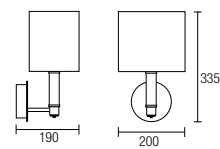

20-2380-21-20

2 x E-27 Max. 100W

 2 DIMMER

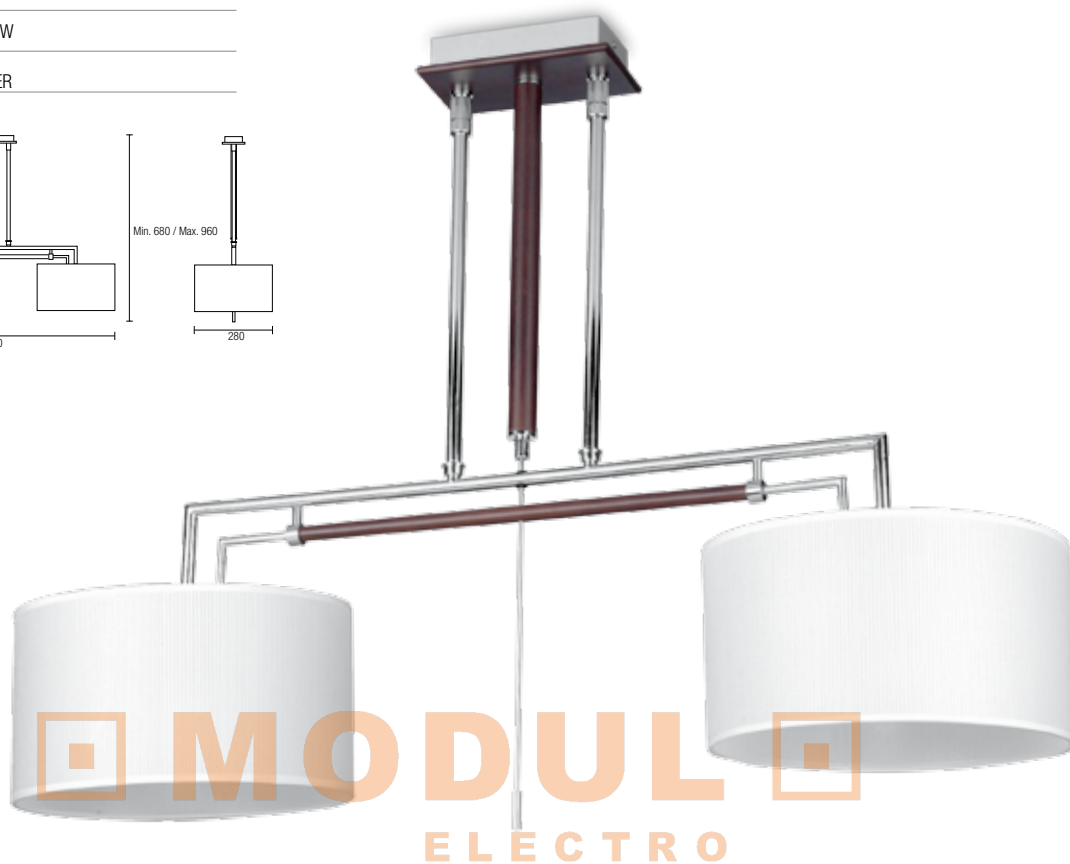
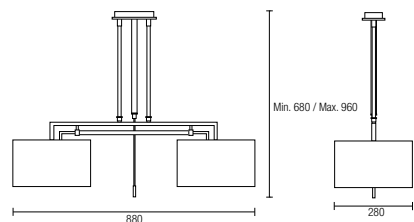

MODULO
ELECTRO

www.modulelectro.ru



20-2382-21-20

3 x E-14 Max. 60W

 2 DIMMER

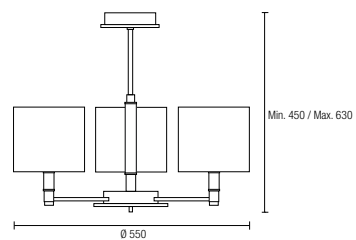

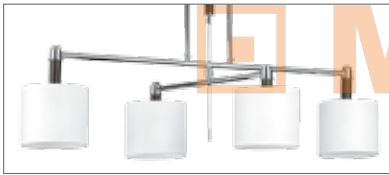

Pantallas centrales giratorias / Rotating central shades

20-2381-21-20

4 x E-14 Max. 60W

  DIMMER

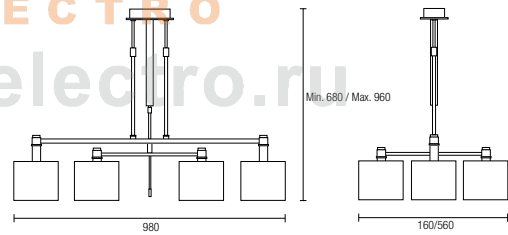

20-2383-21-20

5 x E-14 Max. 60W

  DIMMER

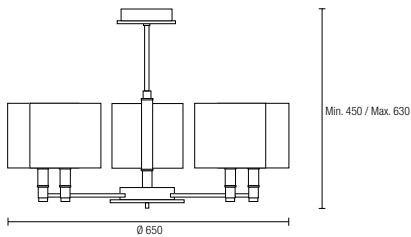



10-2381-21-20

1 x E-14 Max. 60W

  2 ON/OFF DIMMER

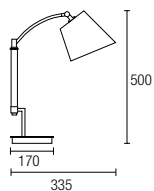

25-2381-21-20

1 x E-27 Max. 60W

  2

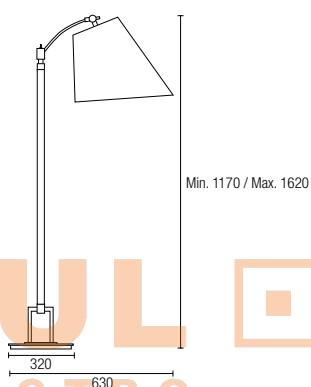

MODULO ELECTRO

www.modulelectro.ru

25-2380-21-20

1 x E-27 Max. 150W

  2 FOOT DIMMER

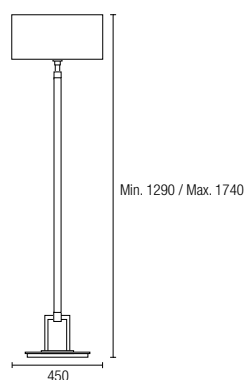

Tubo estensibile / Telescopic tube

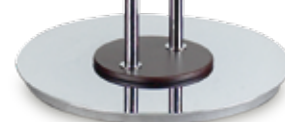

Tubo estensibile / Telescopic tube

10-2380-21-20

1 x E-14 Max. 60W

  2 ON/OFF DIMMER

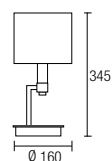



CRETA

NS Níquel satinado
Satin nickel
Nickel satiné
Nickel matt
Níchel satinato
Níquel acetinado

PA Patiné
Antique brass
Patiné
Antique brass
Patinato
Patinado

Y2 Marrón envejecido
Old brown
Marron vieille
Alt braun
Marrone vecchio
Castanho envelhecido

Cristal satinado
Satin glass
Verre satiné
Satiniertes Glas
Cristallo satinato
Cristal acetinado

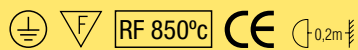

DIMMER + DIMMER brazo lector / DIMMER reading lamp / DIMMER bras lecteur / DIMMER Leselampe / DIMMER braccio lettore / DIMMER braço leitor



Cabezal orientable
Adjustable head

MODULO
ELECTRO
www.modulelectro.ru

127-NS

1 x R7s L=118 Max 300W included +
1 x GY 6,35 50W 12V Included



127-PA

1 x R7s L=118 Max 300W included +
1 x GY 6,35 50W 12V Included



127-Y2

1 x R7s L=118 Max 300W included +
1 x GY 6,35 50W 12V Included

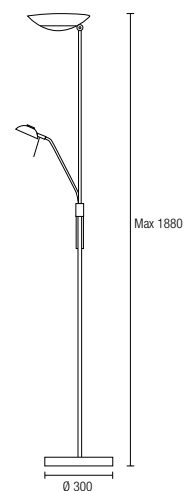

**429-CR**

1 x R7s L=118 Max 300W included +
1 x GY 6,35 50W 12V included

**429-NS**

1 x R7s L=118 Max 300W included +
1 x GY 6,35 50W 12V included

**429-PA**

1 x R7s L=118 Max 300W included +
1 x GY 6,35 50W 12V included



MODULO
ELECTRO
www.modulelectro.com

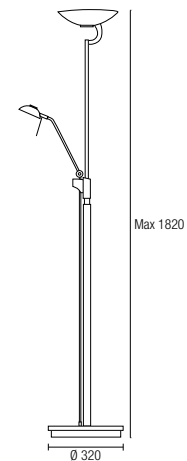

IBIZA

CR

Cromo
Chrome
Chrom
Chrom
Cromo
Cromo

NS

Níquel satinado
Satin nickel
Nickel satiné
Nickel matt
Nichel satinato
Níquel acetinado

PA

Patiné
Antique brass
Patiné
Antique brass
PatinatLegno
Patinado

Madera Wengué
Wenge Wood
Bois de Wengé
Wengé-Holz
Wengé
Madeira Wengé



RF 850°C



DIMMER + DIMMER brazo lector / DIMMER reading lamp / DIMMER bras lecteur /
DIMMER Leselampe / DIMMER braccio lettore / DIMMER braço leitor



**248-NS**

1 x R7s L=118 Max 300W included + 1 x GY 6,35 50W 12V included

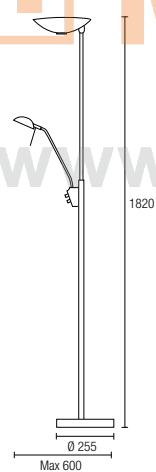
   2 DIMMER + DIMMER brazo lector / reading lamp

**247-NS**

1 x R7s L=118 Max 300W

  2 DIMMER

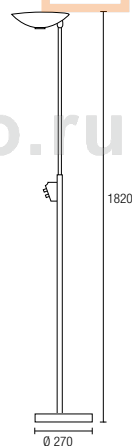

MEMPHIS

-  **NS** Níquel satinado
Satin nickel
Nickel satiné
Nickel matt
Níchel satinato
Níquel acetinado

MODUL
ELECTRO
electro.ru

UP & DOWN

81 Níquel satinado
Satin nickel
Nickel satiné
Nickel matt
Níchel satinato
Níquel acetinado

AJ Pantalla gris ópera incluida
Opera grey shade included
Âbat-jour gris opéra compris
Grau Schirm inklusiv
Paralume grigio compresa
Âbat-jour gris opera incluído

00-2713-81-AJ

1 x E-27 Halogen Max. 150W OSRAM INCLUDED



Max. 1500

Ø 500

Light
UPIluminación direccional
UP & DOWN
UP & DOWN directional lightLight
DOWN**10-2713-81-AJ**

1 x G9 Max. 75W OSRAM included

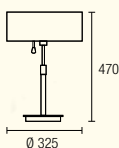

470

Ø 325

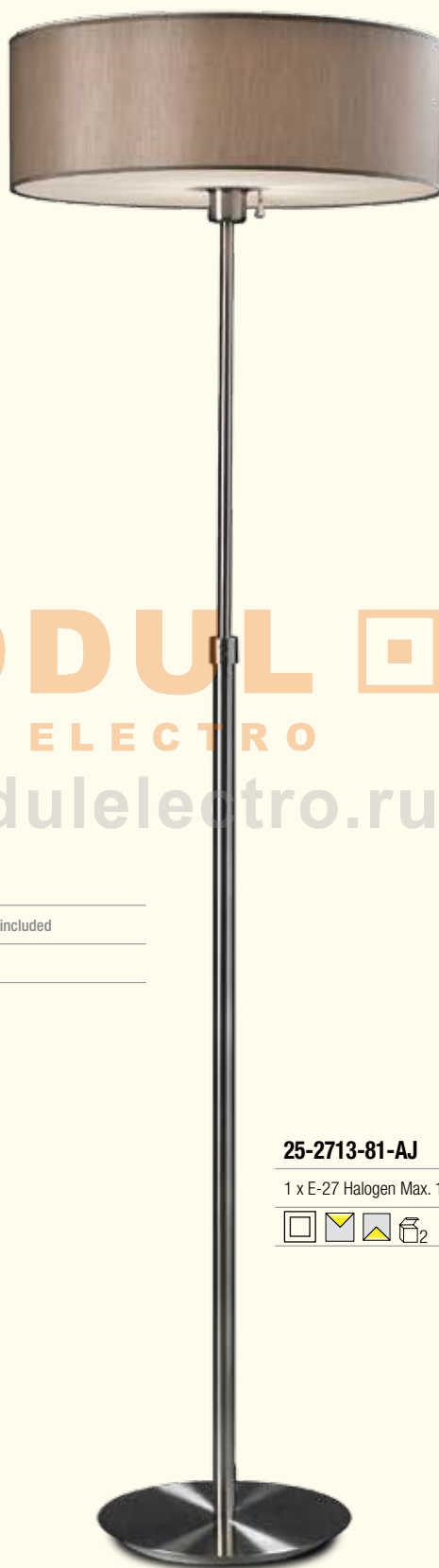
Light
UPLight
DOWNIluminación direccional
UP & DOWN
UP & DOWN directional light**25-2713-81-AJ**

1 x E-27 Halogen Max. 150W OSRAM included

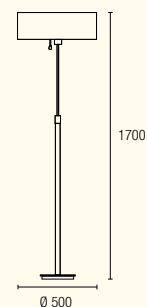

1700

Ø 500

MODULO
ELECTRO
www.modulelectro.ru



MODUL
ELECTRO
www.modulelectro.ru

EXTEND

■ **Y2** Cromo y pintura marron
Chrome and painted brown
Marron vieilli
Alt braun
Marrone vecchio
Castanho envelhecido

□ **14** Pantalla de tela blanca incluida
White fabric shade included
Abat-jour blanc en tissu compris
Stoffchirm weiss inklusiv
Schermo bianco compresa
Âbat-jour branco incluído

■ **05** Pantalla de tela negra incluida
Black fabric shade included
Abat-jour noir en tissu compris
Stoffchirm schwarz inklusiv
Schermo nero compresa
Âbat-jour preto incluído

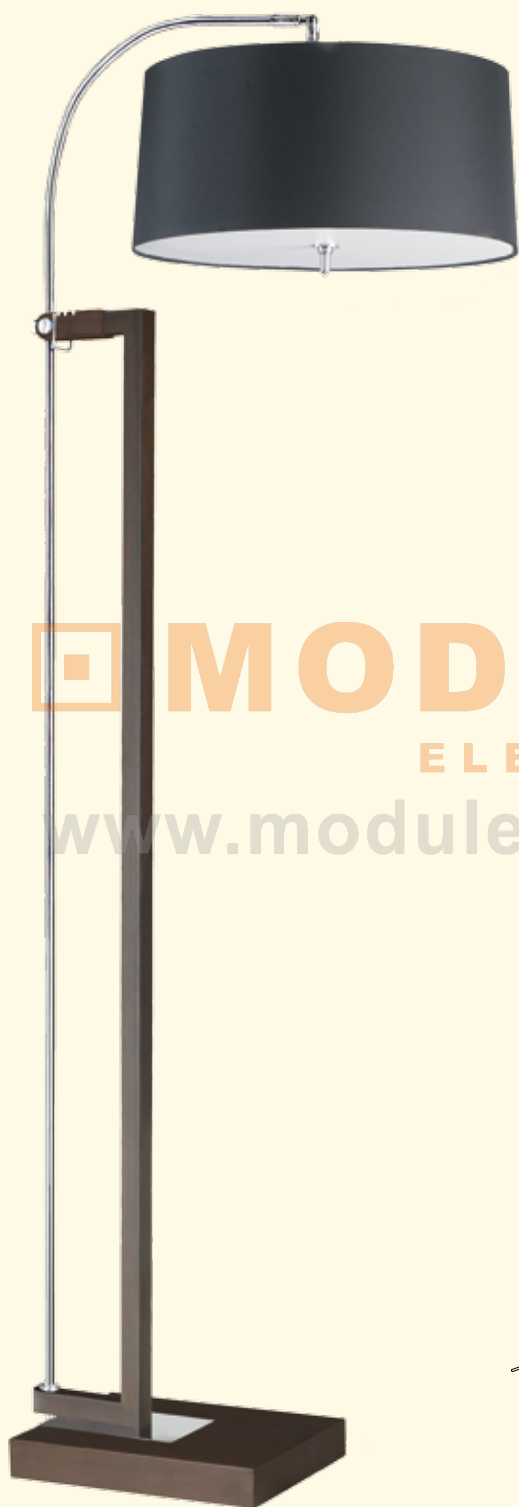

ON / OFF DIMMER



Protector antideslumbrante
Anti-glare protection

MODULO
ELECTRO
www.modulelectro.ru

25-2860-Y2-05*
25-2860-Y2-14

3 x E-27 Max. 60W

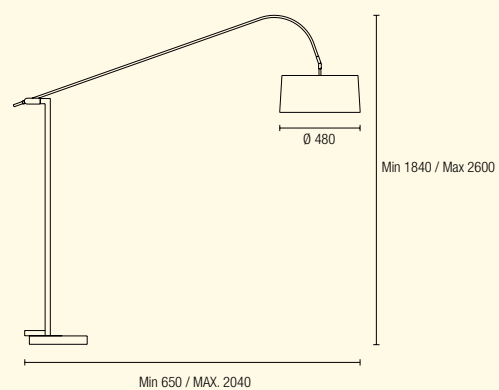



CAMBRIDGE

21 Cromo
 Chrome
 Chrome
 Chrom
 Cromo
 Cromo

92 Pantalla wengué incluida
 Wenge shade included
 Abat-jour wengé compris
 Wenge schirm inklusiv
 Paralume wengé compresa
 Cupula wengé inclusa

**05-2795-21-92**

1 x E-14 Max. 60W vela / 1 x PL Elec. E-14 11W

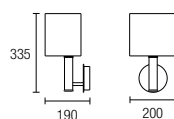
**25-2795-21-92**

1 x E-27 Max. 150W / 1 x PL Elec E-27 23W

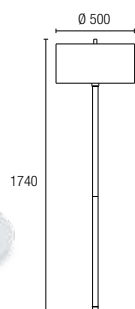
**10-2795-21-92**

1 x E-27 Max. 100W / 1 x PL Elec E-27 20W

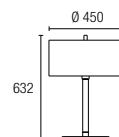

MODULO
ELECTRO
www.modulelectro.ru



MODUL
ELECTRO
www.modulselectro.ru

DEVON

21 Cromo
Chrome
Chrome
Chrom
Cromo
Cromo

14 Pantalla tela de lino blanca incluida
White fabric shade included
Abat-jour en lin inclus
Weiss linen stoffschirm inklusiv
Paralume lino bianco incluso
Cupula branca de linho inclusa



05-2825-21-14

1 x E-27 Max. 60W / 1 x PL Elec E-27 20W

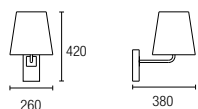

05-2826-21-14

2 x E-27 Max. 60W / 2 x PL Elec E-27 20W

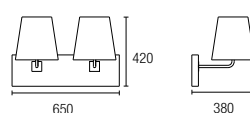

25-2825-21-14

1 x E-27 Max. 150W / 1 x PL Elec E-27 23W

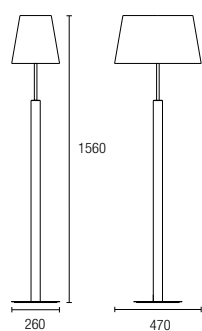

10-2825-21-14

1 x E-27 Max. 100W / 1 x PL Elec E-27 20W

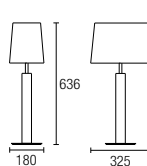

MODUL
ELECTRO
www.modulelectro.ru



MODULO
ELECTRO
www.modulelectro.ru

EDIMBURGO

D9 Pan de plata
Silver leaf
Feuille d'argent
Silber folie
Foglia di argento
Pão de prata

14 Pantalla chinz blanca incluida
White fabric shade included
Abat-jour en tissu blanc inclus
Weiss chintz stoffschirm inklusiv
Paralume chinz bianco incluso
Cupula branca chinz inclusa



25-2797-D9-14

3 x E-27 Max. 60W / 3 x PL Elec E-27 20W

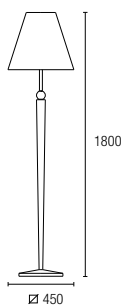

05-2797-D9-14

1 x E-27 Max. 60W / 1 x PL Elec E-27 20W

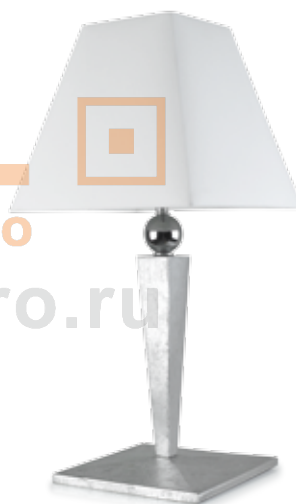
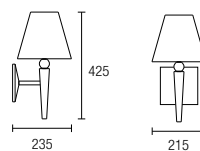

10-2797-D9-14

1 x E-27 Max. 100W / 1 x PL Elec. E-27 20W

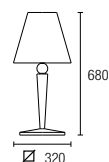

MODULO
ELECTRO
www.modulelectro.ru



VERSALLES

- | | | | |
|---|--|--|--|
| <p> D8 Pan de oro
Golden leaf
Feuille d'or
Gold folie
Foglia di oro
Pão de ouro</p> | <p> 92 Pantalla wengé incluida
Wenge shade included
Âbat-jour wengé compris
Stoffschirm wenge inklusiv
Schermo wengé compresa
Âbat-jour wengé incluído</p> | <p> D9 Pan de plata
Silver leaf
Feuille argent
Silber folie
Foglia di argento
Pão de prata</p> | <p> 14 Pantalla blanca incluida
White shade included
Âbat-jour blanc en tissu compris
Stoffschirm weiss inklusiv
Schermo bianco compresa
Âbat-jour branco incluído</p> |
|---|--|--|--|



10-2792-D9-14
10-2792-D8-92 *

1 x E-27 Max. 100W / 1 x E-27 PL Elec. 20W

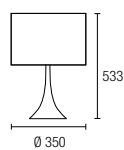

10-2793-D9-14 *
10-2793-D8-92

1 x E-27 Max. 150W / 1 x E-27 PL Elec. 30W

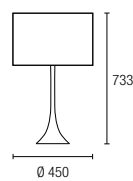



MODUL
ELECTRO
www.modulelectro.ru

BARCA

21 Cromo
Chrome
Chrome
Chrom
Cromo
Cromo

22 Latón pulido
Polish brass
Laiton poli
Messing poliert
Ottone pulito
Latão polido



Para conjunto completo solicite referencias de luminaria y pantalla
For complete set please order by separate fixture and shade references



MODULO
ELECTRO
www.modulelectro.ru

25-1515-22-82 + Pan-029-20
25-1515-21-82 + Pan-029-20 *

2 x E-27 Max. 60W



PAN-029 No incluida / Not included

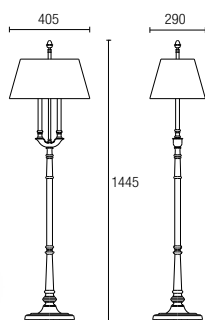

20-1515-22-82 + 3 Pan-028-20 *
20-1515-21-82 + 3 Pan-028-20 *

6 x E-27 Max. 60W



PAN-028 No incluida / Not included

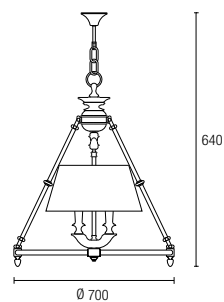



MODULO
ELECTRO
www.modulelectro.com

05-1515-22-82 + Pan-030-20
05-1515-21-82 + Pan-030-20 *

2 x E-27 Max. 60W



PAN-030 No incluida / Not included

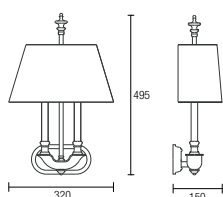

05-1516-22-82 + Pan-032-20 *
05-1516-21-82 + Pan-032-20

2 x E-27 Max. 60W



PAN-032 No incluida / Not included

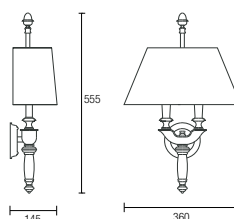



MODULO
ELECTRO
www.modulelectro.ru

10-1515-22-82 + Pan-031-20
10-1515-21-82 + Pan-031-20 *

2 x E-27 Max. 60W



PAN-031 No incluida / Not included

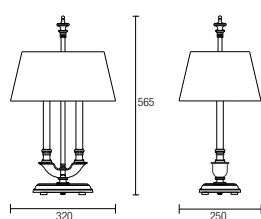

10-1516-22-82 + Pan-027-20 *
10-1516-21-82 + Pan-027-20

2 x E-27 Max. 60W



PAN-027 No incluida / Not included

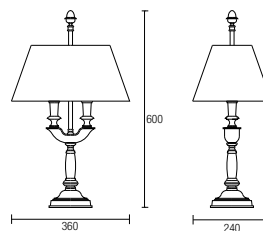



www.modulelectro.ru

E4 Patiné
Antique brass
Patiné
Alt Messing
Patinato
Patinado

08 Vidrio verde
Green glass
Verre vert
Grün glas
Vetro verde
Vidro verde

22 Latón pulido
Polish brass
Laiton poli
Messing poliert
Ottone pulito
Latão polido

26 Vidrio opal brillo
Bright opal glass
Verre opal brillant
Glänzendes opal glas
Vetro opal lucido
Vidro opal brilho

**20-2266-E4-08**

3 x E-27 Max. 60W

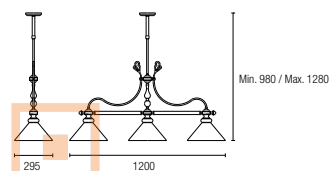

MODULO
ELECTRO

www.modulelectro.ru

**00-7022-22-26**

1 x E-27 Max. 100W

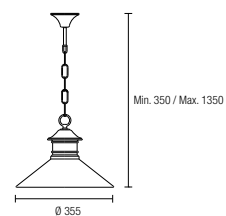



MODUI
ELECTRO
www.modulelectro.ru

LEATHER

T1 Níquel mate, polypiel marrón, cristal
Matt nickel, brown polypiel, glass
Nickel mate, polypiel marron, verre
Nickel matt, brauner polypiel, glas
Níchel opaco, pelle marrone, vetro
Níquel fosco, couro sintético marrom, vidro

20 Pantalla blanca incluida
White shade included
Âbat-jour blanc en tissu compris
Stoffschirm weiss inklusiv
Schermo bianco compresa
Âbat-jour branco incluído

**05-2567-T1-20**

1 x E-27 Max. 60W

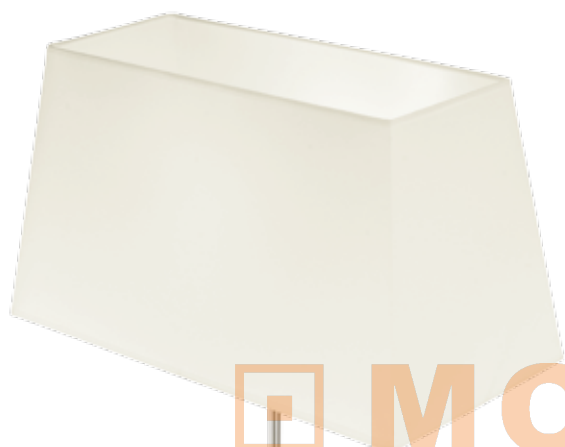
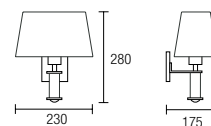

MODULO
ELECTRO

www.modulelectro.ru

**25-2567-T1-20**

1 x E-27 Max. 100W

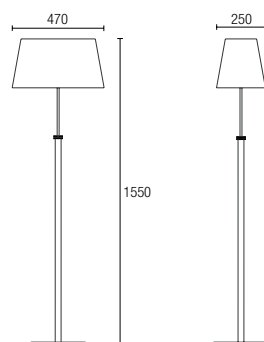
**10-2567-T1-20**

1 x E-27 Max. 60W

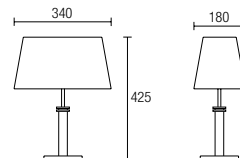



MODUL
ELECTRO
www.modulelectro.ru

CHICAGO

■ **Y2** Marrón envejecido
Old brown
Marron vielli
Alt Braun
Marrone vecchio
Castanho envelhecido

□ **20** Pantalla de tela beige incluida
Beige fabric shade included
Âbat-jour en toile beige inclus
Mit Stoffschirm beige
Schermo in tela beige compresa
Âbat-jour de tecido beige incluído

**05-2798-Y2-20**

1 x E-27 Max. 60W / 1 x PL Elec. E-27 20 W

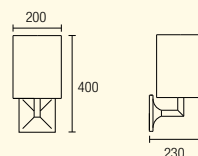
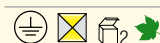

MODUL
ELECTRO
www.modulelectro.ru

**25-2798-Y2-20**

3 x E-27 Max. 60W / 3 x PL Elec. E-27 20 W

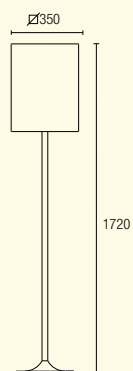
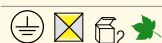
**10-2798-Y2-20**

1 x E-27 Max. 60W / 1 x PL Elec. E-27 20 W

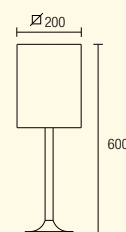



MODUL
ELECTRO
www.modulele.ro.ru

WAVE

21 Cromo
Chrome
Chrome
Chrom
Cromo
Cromo

Q3 Vidrio Fusing
Fusing glass
Verre fusing
Fusing Glas
Cristallo fusing
Cristal fusing



MODULO
ELECTRO
www.modulelectro.ru

00-2535-21-Q3

3 x E-27 Max. 60W

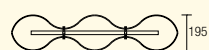
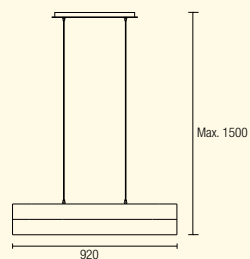



MODUL
ELECTRO
www.modul-electro.ru

10-2549-21-Q3

1 x E-27 Max. 60W

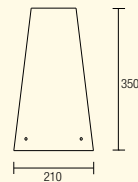

MAGMA

21 Cromo
Chrome
Chrome
Chrom
Cromo
Cromo

Q3 Vidrio Fusing
Fusing glass
Verre fusing
Fusing Glas
Cristallo fusing
Cristal fusing

**15-2593-05-Q3**

2 x 2G11 18W included

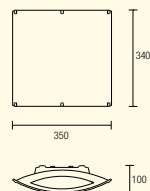
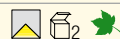
**00-2593-05-Q3**

2 x T5 24W included

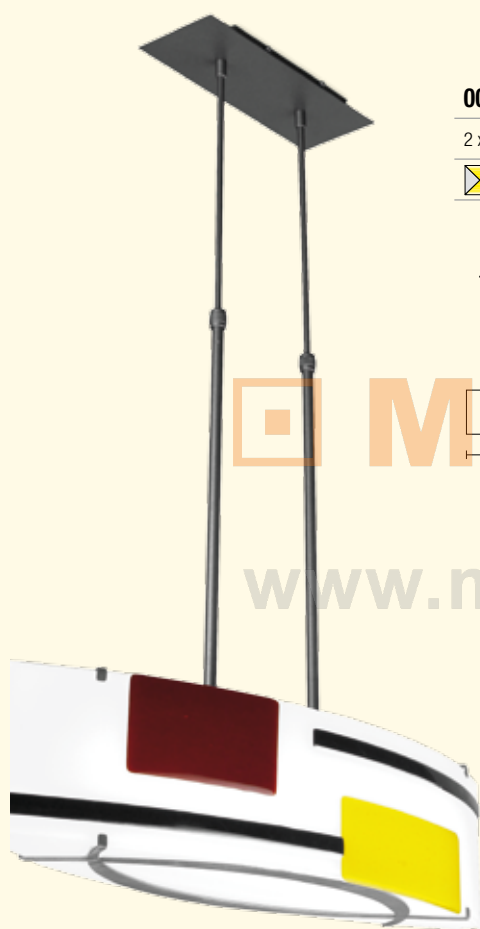
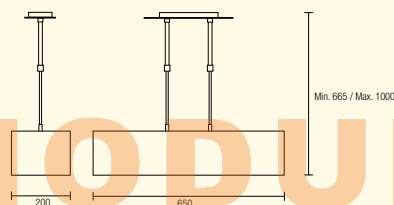
**05-2593-05-Q3**

2 x 2G11 18W included

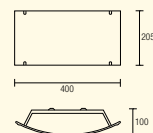
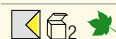

COMBA

05 Negro metalizado
Metalised black
Noir métallisé
Schwarz-Metallic
Nero metallizzato
Preto metalizado

Q3 Vidrio fusing
Fusing glass
Verre fusing
Fusing Glas
Cristallo fusing
Cristal fusing



RF 850°C



included



MODUL
ELECTRO
www.modulelectro.ru

STRAIGHT

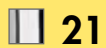
**21**

Cromo
Chrome
Chrome
Chrom
Cromo
Cromo

**81**

Níquel satinado
Satin nickel
Nickel Satiné
Satinierteres Nickel
Níchel satinato
Níquel acetinado

**Q3**

Vidrio Fusing
Fusing glass
Verre fusing
Fusing Glas
Cristallo fusing
Cristal fusing



RF 850°C



**05-2541-81-Q3**

2 x G9 Max. 60W OSRAM included

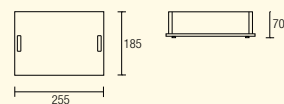
**00-2541-21-Q3**

3 x E-27 Max. 60W esf. ø 45

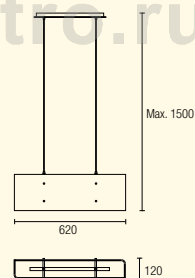
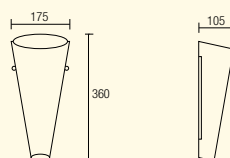
**05-2542-21-Q3**1 x G9 Max. 60W OSRAM included +
1 x G9 Max. 25W OSRAM included

05-2543-81-Q3

2 x G9 Max. 40W OSRAM* included

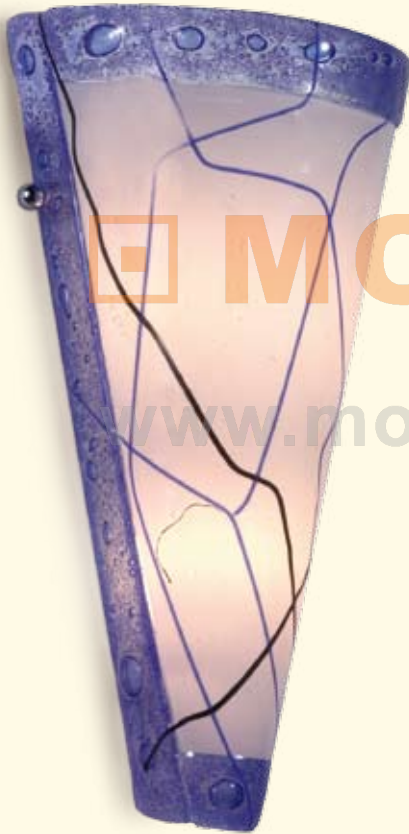
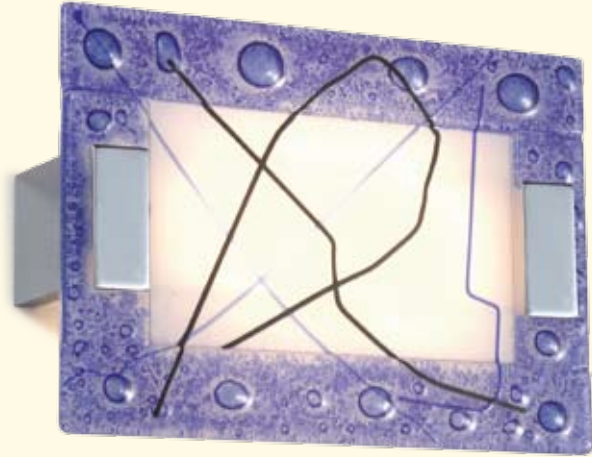
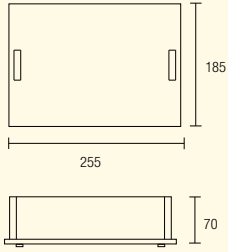

MODULO
ELECTRO

05-2544-21-Q3

1 x G9 Max. 60W OSRAM* included / 1 x G9 Max. 25W OSRAM* included

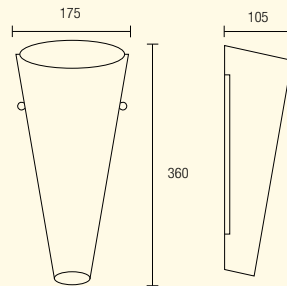

STRAIGHT

21 Cromo
Chrome
Chrome
Chrom
Cromo
Cromo

81 Níquel satinado
Satin nickel
Nickel Satiné
Satinierteres Nickel
Nichel satinato
Níquel acerinado

Q3 Vidrio Fusing
Fusing glass
Verre fusing
Fusing Glas
Cristallo fusing
Cristal fusing

**05-2550-21-Q3**

1 x E-27 Max. 60W

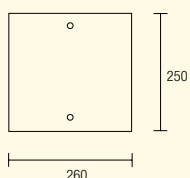

MODULO
ELECTRO
www.modulelectro.ru

05-2554-21-Q3

2 x E-14 Vela Max. 60W

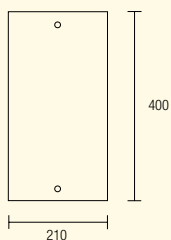

STRINGER

21 Cromo
Chrome
Chrome
Chrom
Cromo
Cromo

Q3 Vidrio Fusing
Fusing glass
Verre fusing
Fusing Glas
Cristallo fusing
Cristal fusing



PROVENZA

■ **Y2** Marrón envejecido
Old brown
Marron vielli
Alt Braun
Marrone vecchio
Castanho envelhecido

□ **20** Pantalla de tela beige incluida
Beige fabric shade included
Âbat-jour en toile beige inclus
Mit Stoffschirm beige
Schermo in tela beige compresa
Âbat-jour de tecido beige incluído

20-0544-Y2-20

5 x E-14 Max. 60W

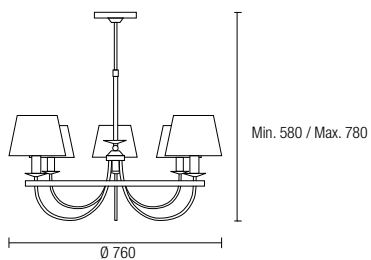

MODULO
ELECTRO
www.modulelectro.ru

20-0543-Y2-20

3 x E-14 Max. 60W

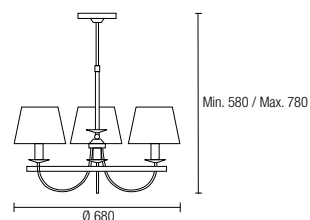
**20-0542-Y2-20**

3 x E-14 Max. 60W

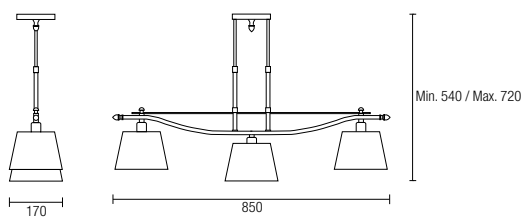



10-0542-Y2-20

1 x E-14 Max. 60W

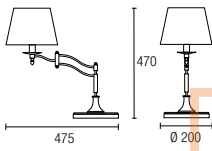

25-0543-Y2-20

1 x E-27 Max. 100W

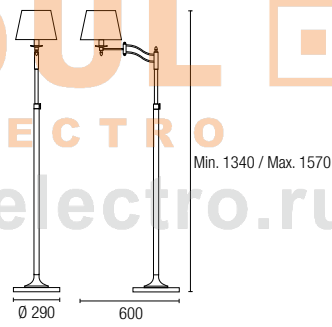

05-0544-Y2-20

1 x E-14 Max. 60W

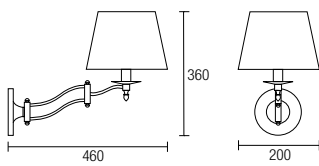

MODULO
ELECTRO
www.modulelectro.ru

**05-0542-Y2-20**

1 x E-14 Max. 60W

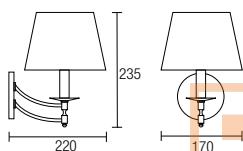
**10-0543-Y2-20**

1 x E-14 Max. 60W

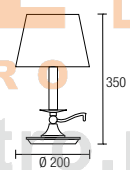
**25-0542-Y2-20**

1 x E-27 Max. 100W

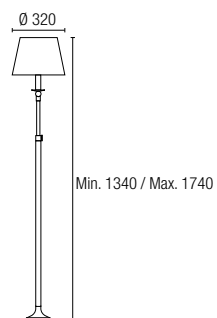
**05-0543-Y2-20**

1 x E-14 Max. 60W

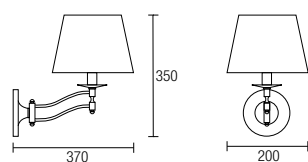

MODULO
ELECTRO
www.modulelectro.ru



MODUL
ELECTRO
www.moduloelectro.com

XENIA

■ **Y2** Marrón envejecido
Old brown
Marron vielli
Alt Braun
Marrone vecchio
Castanho envelhecido

□ **E7** Cristal Ámbar
Ambar Glass
Verre ambre
Bernsetein Glas
Cristallo Ambra
Vidro Âmbar

20-0576-Y2-E7

5 x E-14 Max. 60W OSRAM included

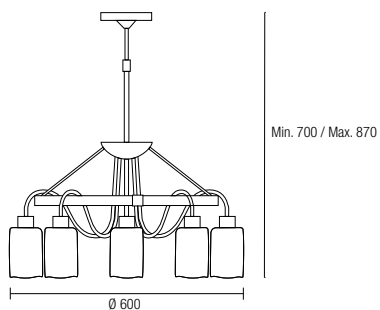
**20-0575-Y2-E7**

4 x E-14 Max. 60W

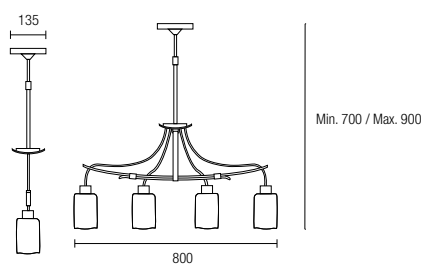

**15-0576-Y2-E7**

3 x G9 Max. 60W OSRAM included

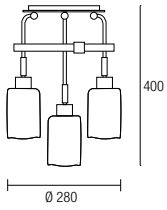

MODULO
ELECTRO
www.modulselectro.ru

**15-0575-Y2-E7**

3 x E-14 Max. 60W

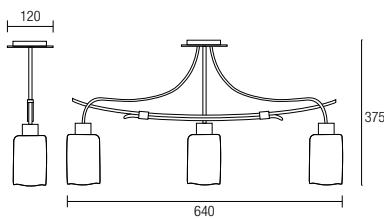

**05-0579-Y2-E7**

3 x G9 Max. 60W OSRAM included

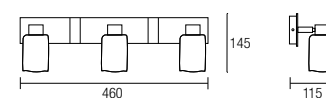
**05-0578-Y2-E7**

2 x G9 Max. 60W OSRAM included

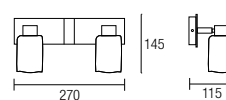
**05-0577-Y2-E7**

1 x G9 Max. 60W OSRAM included

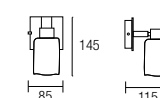

**05-0576-Y2-E7**

2 x E-14 Max. 60W

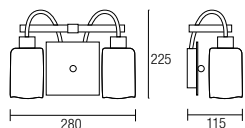

MODUL
ELECTRO
www.modulelectro.ru

**05-0575-Y2-E7**

1 x E-14 Max. 60W

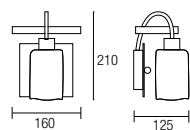



15-0553-S4-E7
15-0553-Y2-E7 *

1 x R7s Max. 300W OSRAM included

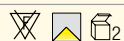

15-0552-S4-E7
15-0552-Y2-E7

1 x R7s Max. 150W OSRAM included

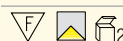

www.modulelectro.ru



15-0554-S4-E7 *
15-0554-Y2-E7

1 x R7s Max. 100W OSRAM included

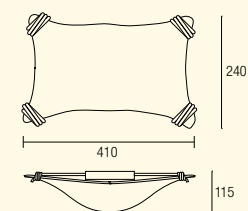
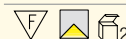

CAIRO

S4 Ámbar dorado
Golden amber
Ambré doré
Vergoldet Bernstein
Ambra dorato
Âmbar dourado

Y2 Marrón envejecido
Old brown
Marron vielli
Alt Braun
Marrone vecchio
Castanho envelhecido

E7 Cristal decorado
Decorated glass
Verre décoré
Dekoglas
Cristallo Decorato
Vidro decorado



MARTINA

S4 Ámbar dorado
 Golden amber
 Ambre doré
 Vergoldet Bernstein
 Ambra dorato
 Âmbar dourado

Z8 Cristal mosaico
 Mosaic glass
 Verre mosaïque
 Mosaikglas
 Mosaico di vetro
 Mosaico em vidro

**15-0582-S4-Z8**

1 x R7s L=78 Max. 100W OSRAM included

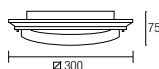
**15-0583-S4-Z8**

1 x R7s L=118 Max. 150W OSRAM included

**15-0584-S4-Z8**

1 x R7s L=118 Max. 200W OSRAM included

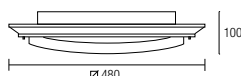

MODULO
ELECTRO
www.moduloelectro.ru

**05-0584-S4-Z8**

1 x R7s L=78 Max. 100W OSRAM included

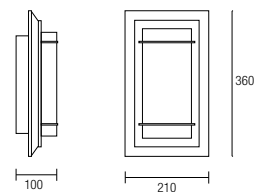
**05-0581-S4-Z8**

1 x G9 Max. 40W OSRAM included

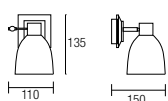
**10-0581-S4-Z8**

1 x G9 Max. 40W OSRAM included

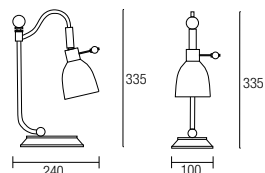



SABANA

S4 Ámbar dorado
 Golden amber
 Ambré doré
 Vergoldet Bernstein
 Ambra dorato
 Âmbar dourado



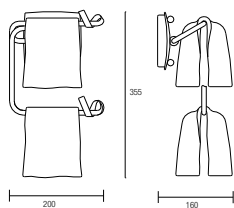
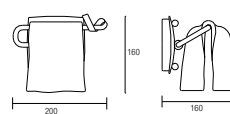

E7 Cristal Ámbar
 Ambar Glass
 Verre ambre
 Bernsetein Glas
 Cristallo Ambra
 Vidro âmbar

**05-2318-S4-E7**2 x E-14 Max. 60W esf. \varnothing 45**05-2317-S4-E7**1 x E-14 Max. 60W esf. \varnothing 45



MODUL
ELECTRO
www.modulelectro.ru

BRISTOL

- | | | | | |
|--|--|---|---|--|
|  81 Níquel satinado
Satin nickel
Nickel satiné
Nickel matt
Nichel satinato
Níquel acetinado |  21 Cromo
Chrome
Chrome
Chrom
Cromo
Cromo |  14 Pantalla blanca
White shade
Âbat-jour blanc
Stoffchirm weiss
Schermo bianco
Âbat-jour branco |  20 Pantalla beige
Beige shade
Âbat-jour beige
Mit Stoffschirm
Schermo beige
Âbat-jour beige |  05 Pantalla negra
Black shade
Âbat-jour noir
Stoffchirm schwarz
Schermo nero
Âbat-jour preto |
|--|--|---|---|--|



Pantalla de tela (PAN-144 /PAN-145) no incluida / Fabric shade (PAN-144 /PAN-145) not included
Para conjunto completo solicite referencias de luminaria y pantalla
For complete set please order by separate fixture and shade references

(NEW)



MODULO
ELECTRO

05-2815-81-81 + PAN
05-2815-21-21 + PAN

1 x E-27 Max. 60W esf. Ø45 / 1 x PL Elec. E-27 Max. 15W

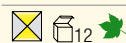

Posición indistinta UP & DOWN
UP&DOWN possible position

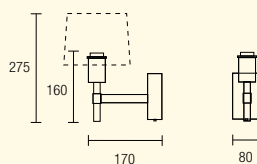

PAN-145-05 *
PAN-145-14
PAN-145-20

PAN-144-05
PAN-144-14
PAN-144-20 *

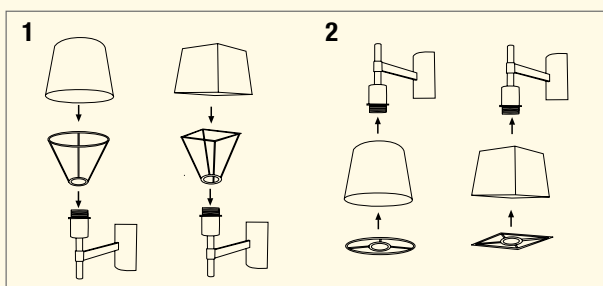
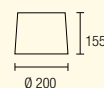
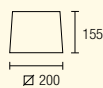



MODUL
ELECTRO
www.modulelectro.ru



MODULO
ELECTRO

www.modulo.ru

05-2816-81-81 + PAN

05-2816-21-21 + PAN

1 x E-27 Max. 60W esf. ø45 / 1 x PL Elec. E-27 Max. 15W + 1 Led x 3W

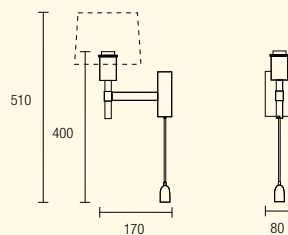
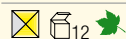

PAN-145-05 *
PAN-145-14
PAN-145-20

PAN-144-05
PAN-144-14
PAN-144-20 *

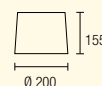
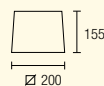



MODUL
ELECTRO
www.modulelectro.ru

BALMORAL

- | | | | |
|--|--|--|---|
| <p>81 Níquel satinado
Satin nickel
Nickel satiné
Nickel matt
Nichel satinato
Níquel acetinado</p> | <p>14 Pantalla blanca incluida
White shade included
Âbat-jour blanc compris
Stoffchirm weiss inklusiv
Schermo bianco compresa
Âbat-jour branco incluído</p> | <p>20 Pantalla beige incluida
Beige shade included
Âbat-jour beige inclus
Mit Stoffschirm beige
Schermo beige compresa
Âbat-jour beige incluído</p> | <p>05 Pantalla negra incluida
Black shade included
Âbat-jour noir compris
Stoffchirm schwarz inklusiv
Schermo nero compresa
Âbat-jour preto incluído</p> |
|--|--|--|---|



MODULO
ELECTRO
www.modulelectro.ru



05-2814-81-14

05-2814-81-20

05-2814-81-05

1 x E-27 Max. 60W esf. $\varnothing 45$ / 1 x PL Elec. E-27 Max. 15W + 1 x Led 3W

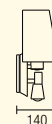
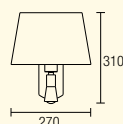



MODUL
ELECTRO
www.modulelectro.ru

LLIT

■ **81-81/NS** Níquel satinado
Satin nickel
Nickel satiné
Nickel matt
Níchel satinato
Níquel acetinado



Driver incluido
Driver included
Driver intégrée
Driver mit eingebaut
Driver integrato
Driver integrado



Interruptor incorporado
Switch included

Cabezal orientable
Adjustable head

**10-2842-81-81 (new)**

30 Leds x 0.073W = 2.2 total included

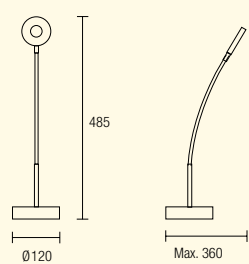
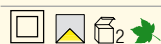
**446-NS**

30 Leds x 0.073W = 2.2 total included

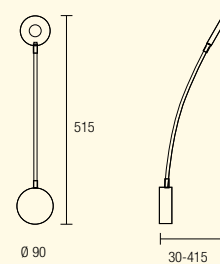



MODUL
ELECTRO
www.modulelectro.ru

BOOK

21-21

Cromo
Chrome
Chrome
Chrom
Cromo
Cromo

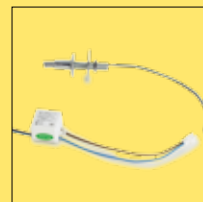

Driver incluido
Driver included
Driver intégrée
Driver mit eingebaut
Driver integrato
Driver integrado

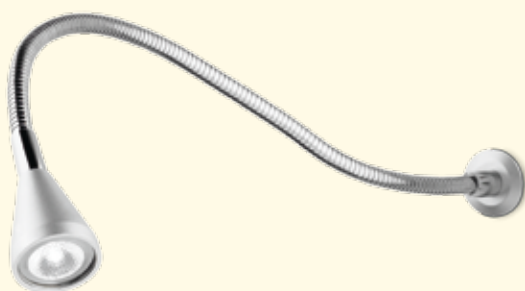

05-2839-21-21

1 Led x 1W

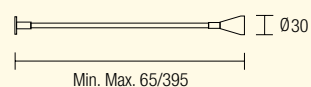

05-2838-21-21

1 Led x 1W

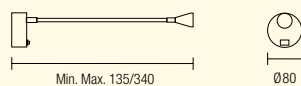

MODULO
ELECTRO
www.modulelectro.ru

05-2837-21-21

1 Led x 1W

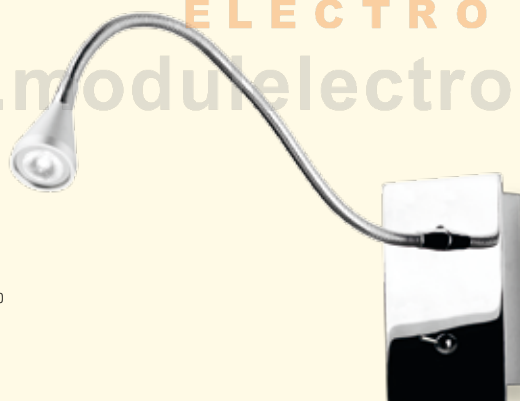
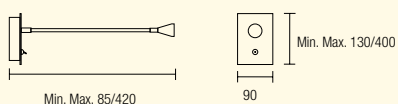

05-2845-21-21

1 Led x 3W

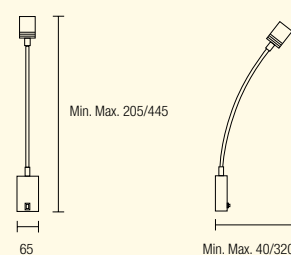



MODUL
ELECTRO
www.modulelectro.ru

BED

■ **34-34** Pintado gris
Grey painted
Peinture grise
Grau lackiert
Grigio pintato
Pintado cinza

Driver incluido
Driver included
Driver intégrée
Driver mit eingebaut
Driver integrato
Driver integrado



05-2830-34-34

1 Led 3W

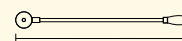

Min. Max. 150/530



Min. Max.
35/450

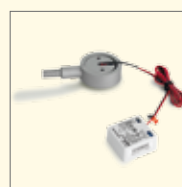

MODUL
ELECTRO

www.modulelectro.ru



05-2831-34-34

1 Led 3W

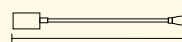
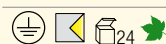

Min. Max. 170/565



Min. Max.
35/450



05-2835-54-54

1 Led x 1,2W

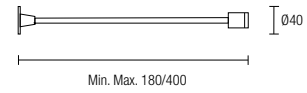

05-2834-54-54

1 Led x 1,2W

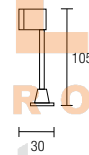

www.modulelectro.ru



05-2836-54-54

1 Led x 3W

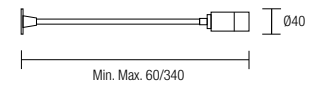

WALL

- **54-54** Aluminio anodizado
- Anodized aluminium
- Aluminium anodisé
- Eloxiertes aluminium
- Alluminio anodizzato
- Aluminio anodizado

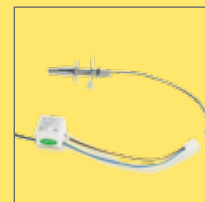

- Driver incluido
- Driver included
- Driver intégrée
- Driver mit eingebaut
- Driver integrato
- Driver integrado



MODULO
ELECTRO
www.modulelectro.ru

05-2840-21-14

1 x E-27 Max. 60W / 1 x PL E-27 Max. 16W + 1 Led x 1W

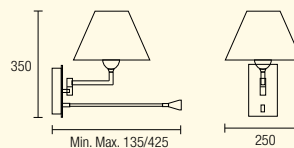
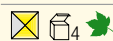

OXFORD

21 Cromo
Chrome
Chrome
Chrom
Cromo
Cromo

14 Pantalla plisada de tela blanca incluida
White pleated shade included
Abat-jour plissé blanc compris
Weisser plissierter Schirm inklusiv
Paralume bianco pieghettato incluso
Cupula plissada branca inclusa



MODUL
ELECTRO
www.modulelectro.ru

TRACK

- 54** Aluminio anodizado
 Anodized aluminium
 Aluminium anodisé
 Eloxiertes aluminium
 Alluminio anodizzato
 Aluminio anodizado



Se suministra para ir empotrado en superficies con facilidad de acceso posterior
 Is supplied to be recessed on surfaces with ease of acces at the back

(new)



DERECHO
RIGHT



05-2823-54-54

1 Led x 3W

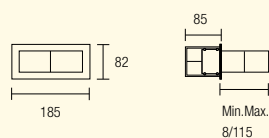
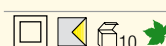

MODULO

ELECTRO

IZQUIERDO
LEFT



05-2822-54-54

1 Led x 3W

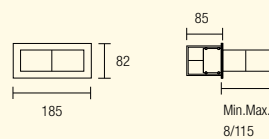
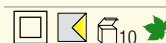

www.modulelectro.ru



71-2821-05-05

Caja para empotrar en pared
Flush fitting box

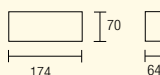



MODUL
ELECTRO
www.modulelectro.com

WING

81 Niquel satinado
Satin niquel
Nickel satiné
Nickel matt
Nichel satinato
Niquel acetinado

E9 Metacrilato y vidrio satinado
Metacrylate and satin glass
Méthyle et verre satiné
Metacrylate und satin glas
Metacrilato e cristallo decorato
Metacrilato e cristal acetinado

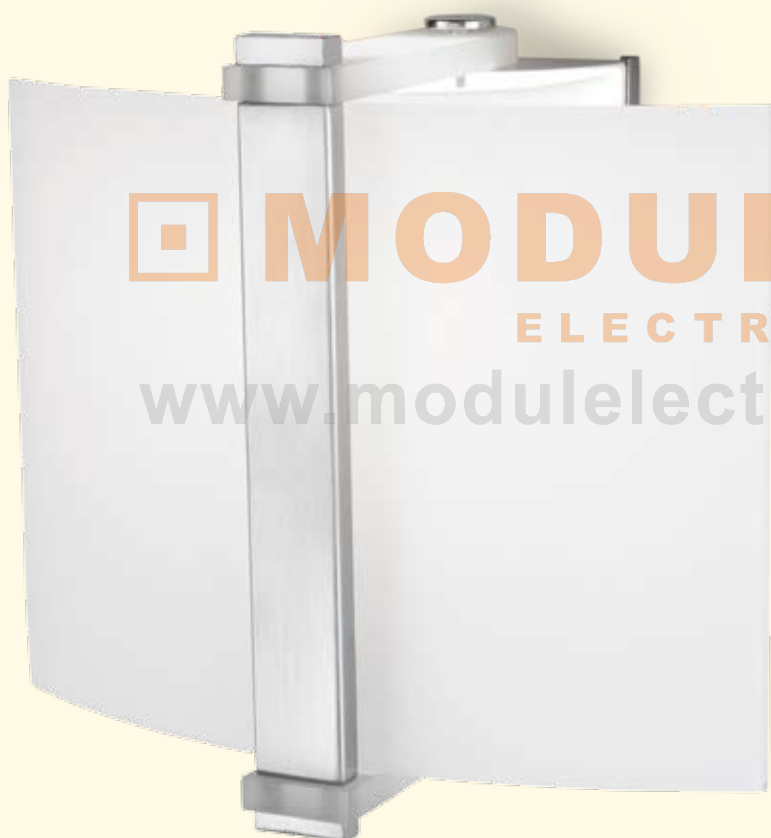

MODULO
ELECTRO
www.modulelectro.ru

05-2829-81-E9

1 x E-27 Max. 60W / 1 x E-27 PL Elec 20W

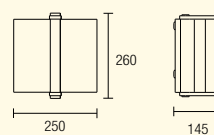
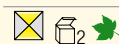



MODUL
ELECTRO
www.modulelectro.ru

ALPEN



GR

Gris
Grey
Gris
Grau
Grigio
Cinzeto

Cristal satinado
Satin glass
Verre satiné
Satiniertes Glas
Cristallo satinato
Cristal acetinado



RF 850°C



ENERGY
SAVING



included

**330-GR**

4 x 2G11 36W included

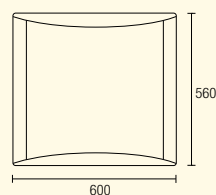
**332-GR**

2 x G24q3 26W included

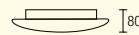
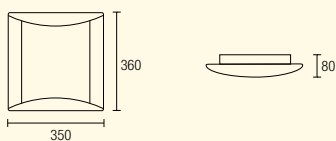
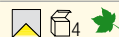
**331-GR**

2 x 2G11 55W included

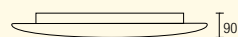
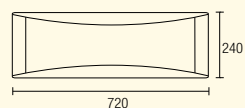

MODULO
ELECTRO
www.modulelectro.ru



ALU

AL Aluminio
 Aluminium
 Aluminium
 Aluminium
 Aluminio
 Aluminio

Cristal satinado
 Satin glass
 Verre satiné
 Satiniertes Glas
 Cristallo satinato
 Cristal acetinado



RF 850°C



2 Cristales templados satinados
 Top & bottom satin tempered glasses

**443-AL**

1 x R7s L=118 Max. 150W OSRAM included

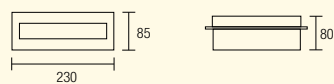

MODUL
ELECTRO

www.modulelectro.ru

491-AL

1 x T5 14W included

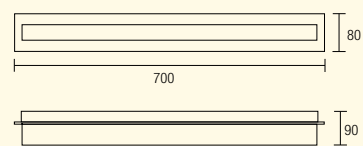
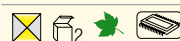

455-AL

1 x G9 Max 60W OSRAM included

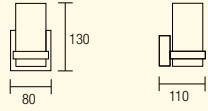

MODUL
ELECTRO



www.modulelectro.ru

456-AL

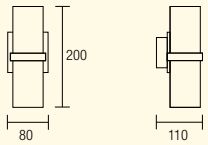
2 x G9 Max 60W / 2 x G9 40W OSRAM included





 **MODUL** 
ELECTRO
www.modulelectro.ru

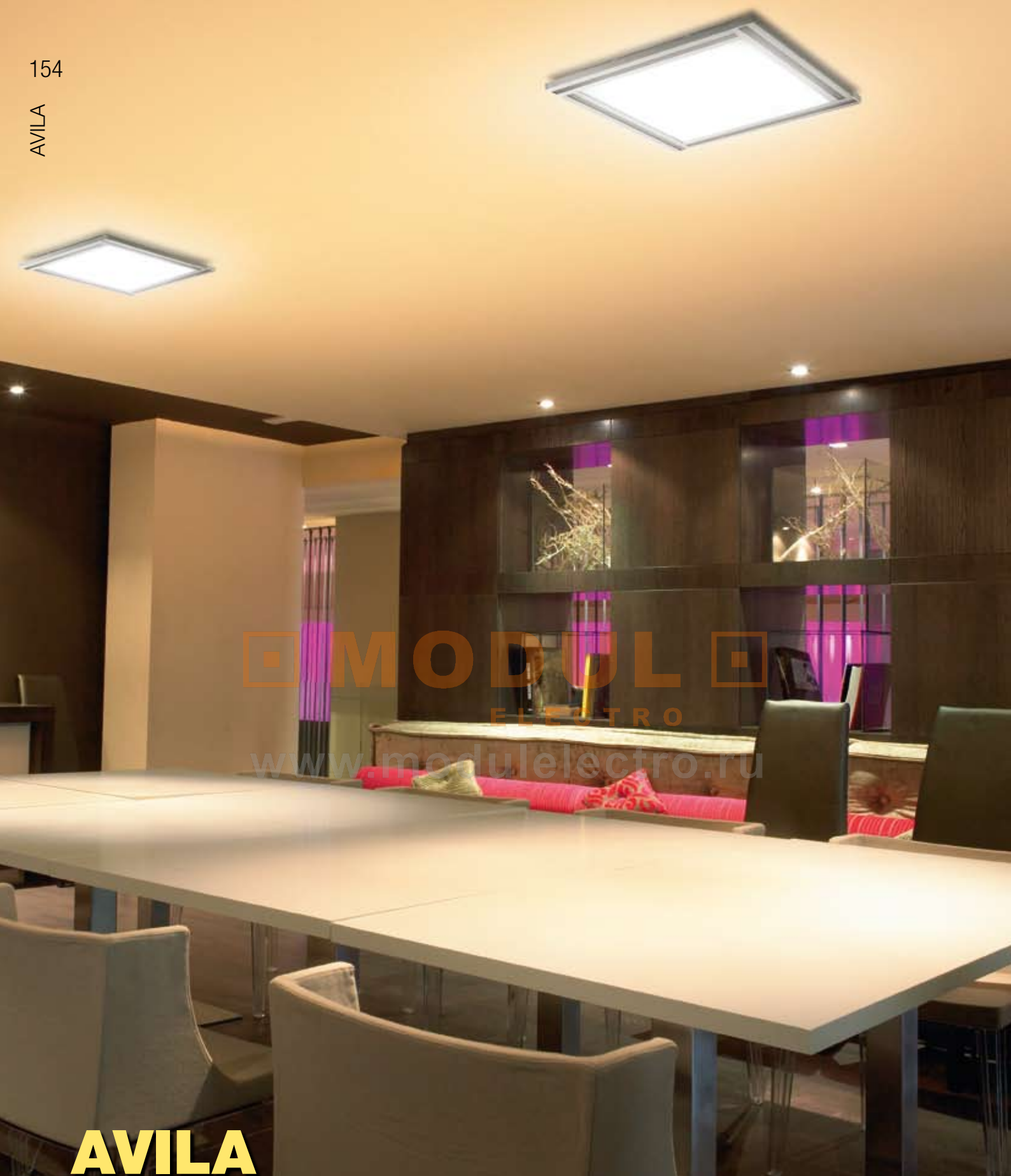

MODUL
ELECTRO
www.modulelectro.ru

AVILA

AW

Aluminio
Aluminium
Aluminium
Aluminium
Alluminio
Alumínio

Policarbonato opal mate
Matt opal polycarbonate
Polycarbonate opal mat
Opales Polikarbonat matt
Policarbonato opalina opaco
Policarbonato opala fosco



Detalles cromados en esquinas / Chrome pieces in corners.



RF 850°C



included

Incluye conjunto de tiras intercambiables en marrón claro y oscuro.
It includes an interchangeable set of strips in light & dark brown.

**494-AW**

2 x 2G11 55W included

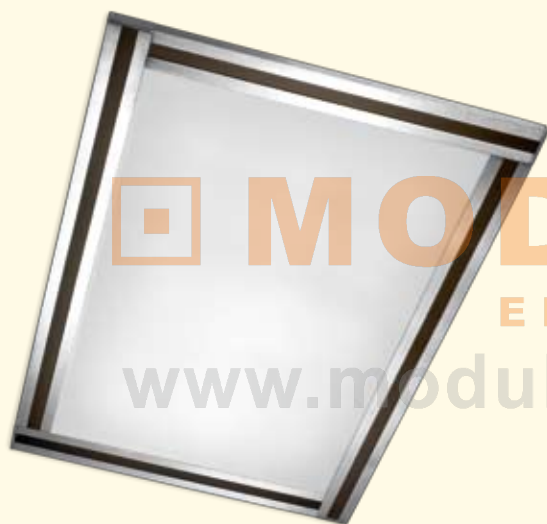
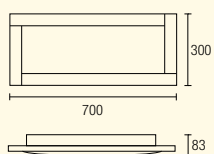
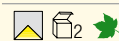
**495-AW**

3 x 2G11 55W included

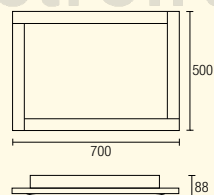
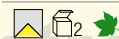
**496-AW**

3 x 2G11 24W included

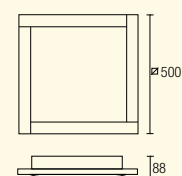
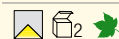

MODULO
ELECTRO
www.modulelectro.ru



BREMEN

 **CR**
 Cromo
 Chrome
 Chrome
 Chrom
 Cromo
 Cromo



RF 850°C



included

2 interruptores
2 switches

**284-CR**

2 x T5 21W included

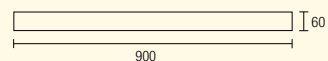
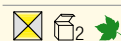

MODULO
ELECTRO
www.modulelectro.ru

**283-CR**

2 x T5 13W included

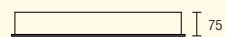
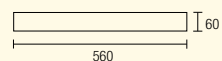
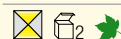



MODULO
ELECTRO
www.modulelectro.ru

511-NE
511-RO *

1 x E-14 Max. 40W Decor Silver OSRAM included

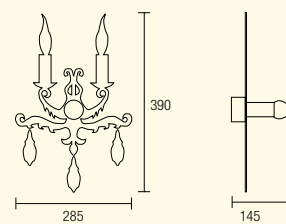
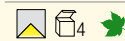

CANDLE

■ **NE** Policarbonato negro
Black polycarbonate
Policarbonate noir
Schwarz Polikarbonat
Policarbonato nero
Policarbonato preto

■ **RO** Policarbonato rojo
Red polycarbonate
Policarbonate rouge
Rot Polikarbonat
Policarbonato rosso
Policarbonato vermelho

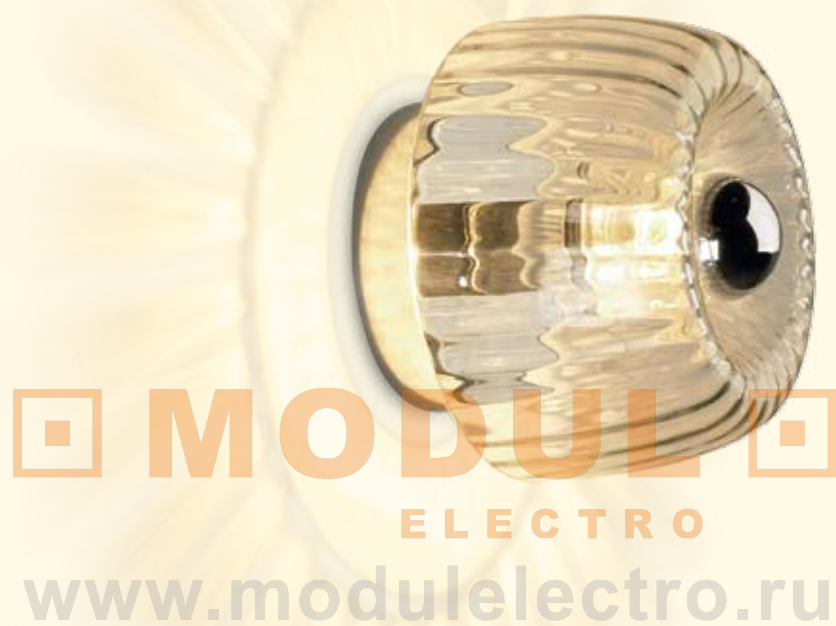
**510-CR**

1 x E-14 Max. 40W Decor Silver OSRAM* included



SUNNY

■ CR	Cromo	Cristal transparente
	Chrome	Transparent glass
	Chrome	Verre transparent
	Chrom	Transparentes Glas
	Cromo	Vetro trasparente
	Cromo	Cristal transparente



MODUL
ELECTRO
www.modulselectro.ru

CANNES

GR

Gris
Grey
Gris
Grau
Grigio
Cinzeto

NS

Níquel satinado
Satin nickel
Nickel satiné
Nickel matt
Níchel satinato
Níquel acetinado

Y2

Marrón envejecido
Old brown
Marron vieilli
Alt Braun
Marrone rustico
Castanho envelhecido

Cristal satinado
Satin glass
Verre satiné
Satiniertes Glas
Cristallo satinato
Cristal acetinado

**442-NS**

1 x R7s L=78 Max. 100W OSRAM included

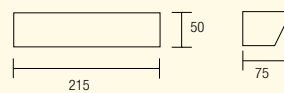
Cristal templado satinado
Satin tempered glass

MODULO
ELECTRO

www.modulelectro.ru

**441-GR *****441-Y2**

1 x R7s L=78 Max. 100W OSRAM included

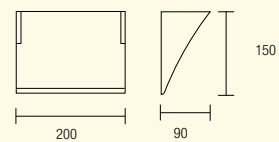



MODU
ELECTRO
www.modulelectro.ru

GLASS

BL Blanco
White
Blanc
Weiss
Bianco
Branco

NS Níquel satinado
Satin nickel
Nickel satiné
Nickel matt
Níchel satinato
Níquel acetinado

Cristal opal
Opal glass
Verre opale
Opalglas
Vetro opalina
Vidrio opala

**444-BL**

1 x E-27 Max. 60W / 1 x E-27 PL Elec 20W OSRAM

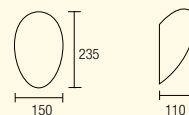

MODULO
ELECTRO
www.modulelectro.ru

**445-BL**

1 x E-27 Max. 60W / 1 x E-27 PL Elec 23W OSRAM

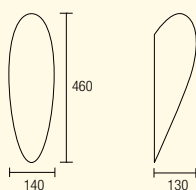
**440-NS**

1 x G9 Max. 60W OSRAM* included



Posición indistinta UP & DOWN
UP&DOWN possible position

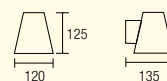



MODUL
ELECTRO
www.modulelectro.ru

GRANADA

GR Gris
Grey
Gris
Grau
Grigio
Cinzeto

Y2 Marrón envejecido
Old brown
Marron vieilli
Alt Braun
Marrone rustico
Castanho envelhecido

Policarbonato opal mate
Matt opal polycarbonate
Policarbonate opal matt
Opales Polikarbonat matt
Policarbonato opalina opaco
Policarbonato opala fosco



MODULO
ELECTRO
www.modulelectro.ru

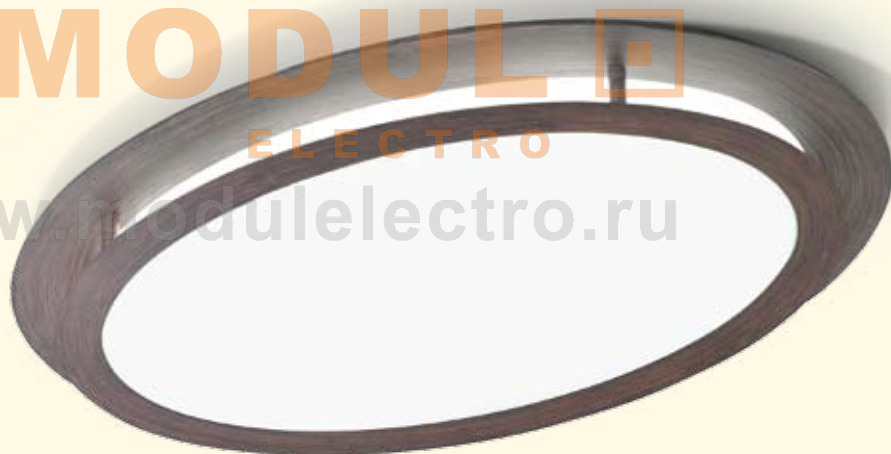

433-GR
433-Y2

4 x 2G11 55W included

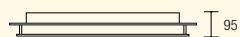
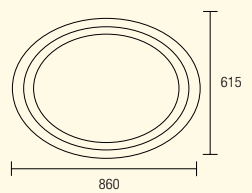

432-GR
432-Y2

3 x 2G11 36W included

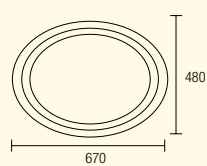

431-GR
431-Y2

3 x G24q3 26W included

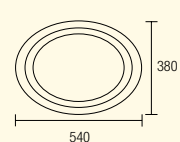



MODUL
ELECTRO
www.modulelectro.ru

HALF



Cromo
Chrome
Chrome
Chrom
Cromo
Cromo

Cristal satinado
Satin glass
Verre satiné
Satiniertes Glas
Cristallo satinato
Cristal acetinado

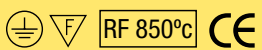

2 Cristales templados satinados
Top & bottom satin tempered glasses

**492-CR**

1 x R7s L=118 Max.150W OSRAM* included

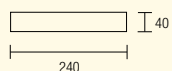

MODULO
ELECTRO

www.modulelectro.ru

**493-CR**

1 x T5 14W included

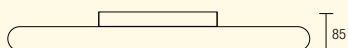
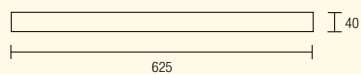
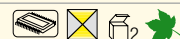



MODUL
ELECTRO
www.modulelectro.ru

MAKE UP

AL Aluminio satinado
Satin Aluminium
Aluminium satiné
Aluminium matt
Alluminio satinato
Alumínio acetinado

Cristal templado transparente y cristales templados satinados
Transparent and satinised tempered glasses
Verre trempé et verre trempé satiné
Durchsichtiges gehärtetes Glas und satinierte gehärtete Gläser
Vetro temperato e vetri temperati satinati
Vidro temperado transparente e vidros temperados acetinados

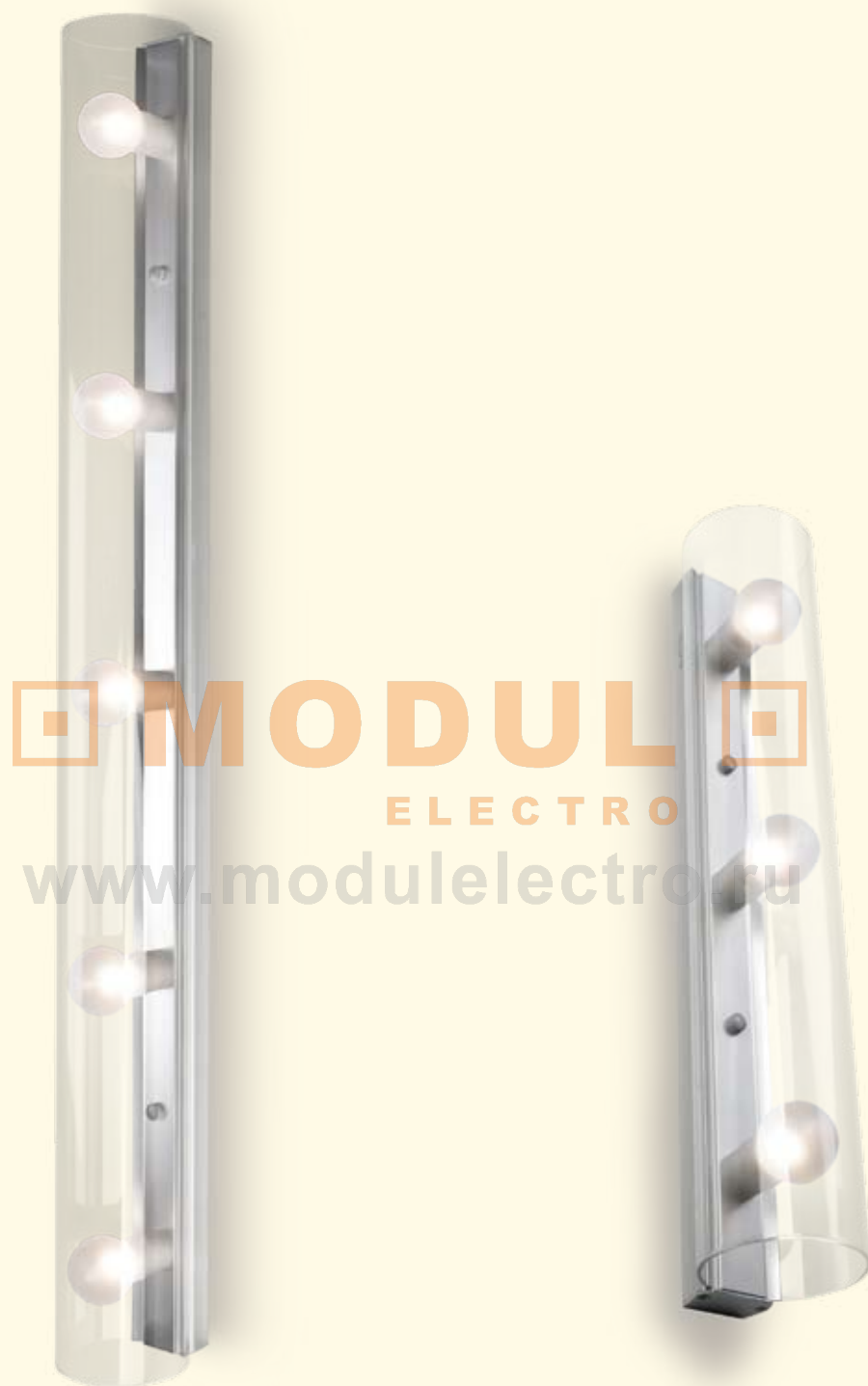
**489-AL**

5 x G9 Max. 60W / 5 x G9 40W OSRAM* included

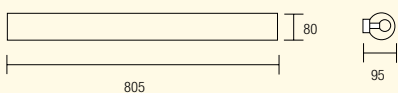
**488-AL**

3 x G9 Max. 60W / 3 x G9 40W OSRAM* included

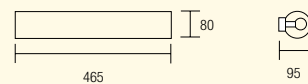

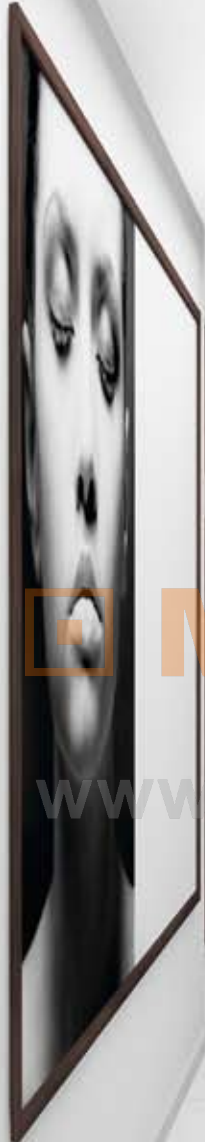

MODULO
ELECTRO
www.modulelectro.ru

NIZA

■ **CR**

Cromo
Chrome
Chrome
Chrom
Cromo
Cromo

■ **NS**

Níquel satinado
Satin nickel
Nickel satiné
Nickel matt
Níchel satinato
Níquel acetinado

■ **Y2**

Marrón envejecido
Old brown
Marron vieilli
Alt Braun
Marrone rustico
Castanho envelhecido

Cristal satinado
Satin glass
Verre satiné
Satiniertes Glas
Cristallo satinato
Cristal acetinado



RF 850°C





MODULO
ELECTRO
www.modulelectro.ru

505-NS
505-Y2

2 x E-27 esf. ø45 Max. 60W / 2 x E-27 PL Elec Max. 21W

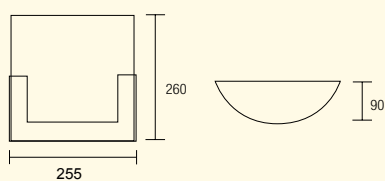

506-CR
506-Y2

2 x E-27 esf. ø45 Max. 60W / 2 x E-27 PL Elec Max. 21W

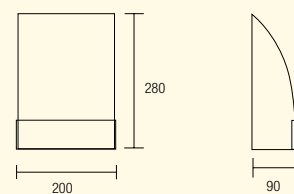



MODUL
ELECTRO
www.modulelectro.ru

**269-NS**

1 x R7s L=78 Max. 100W OSRAM* included

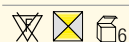
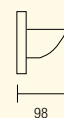
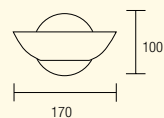
Cristal templado satinado
Satin tempered glass

MODULO
ELECTRO
www.modulelectro.ru

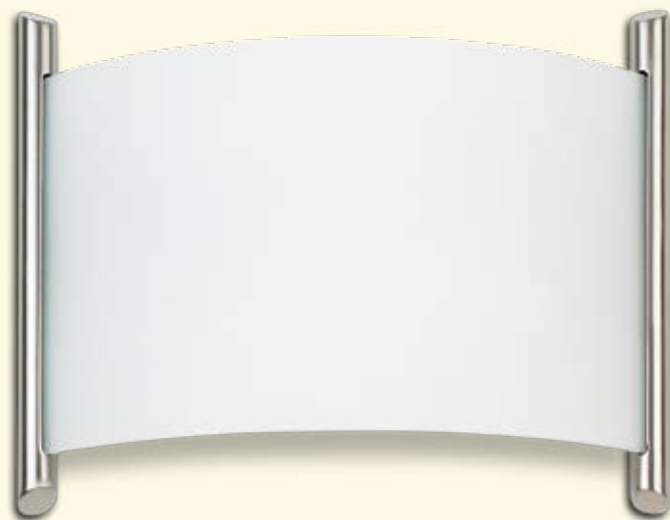
**274-NS**

2 x E-27 Max. 60W / 2 x E-27 PL Elec 18W

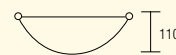
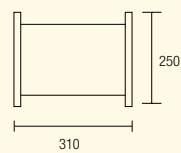

310

110



OSLO

NS Níquel satinado
 Satin nickel
 Nickel satiné
 Nickel matt
 Níchel satinato
 Níquel acetinado

Cristal satinado
 Satin glass
 Verre satiné
 Satiniertes Glas
 Cristallo satinato
 Cristal acetinado

**271-NS**

1 x R7s L=78 Max. 100W OSRAM* included

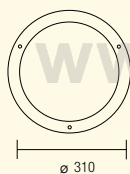
**272-NS**

1 x R7s L=118 Max. 200W OSRAM* included

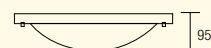
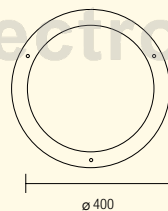
**270-NS**

1 x G9 Max. 40W OSRAM* included

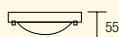
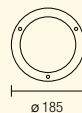



MODULO
ELECTRO

458-NS

2 x G24d3 26W OSRAM* included

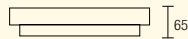
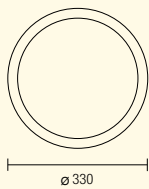
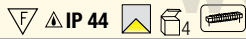
**366-NS**

1 x R7s L=78 Max.100W OSRAM* included

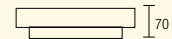
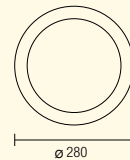
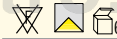

PARMA

NS Níquel satinado
Satin nickel
Nickel satiné
Nickel matt
Níquel satinato
Níquel acetinado

Cristal opal
Opal glass
Verre opale
Opalglas
Vetro opalina
Vidrio opala

**514-GR****514-Y2**

1 x T5 Tubular 22W included + 1 x T5 Tubular 55W included

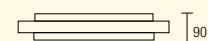
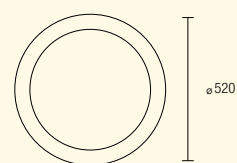

ROUND

■ **GR** Gris
Grey
Gris
Grau
Grigio
Cinzeto

■ **Y2** Marrón envejecido
Old brown
Marron vieilli
Alt Braun
Marrone rustico
Castanho envelhecido

Polycarbonato opal
Opal polycarbonato
Polycarbonate opal
Opales Polikarbonat
Polycarbonato opalina
Polycarbonato opala



SIENA

- NS** Níquel satinado
 Satin nickel
 Nickel satiné
 Nickel matt
 Níchel satinato
 Níquel acetinado

**279-NS**

1 x T5 8W included

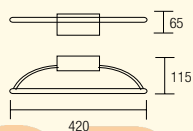

MODULO
ELECTRO

www.modulelectro.ru

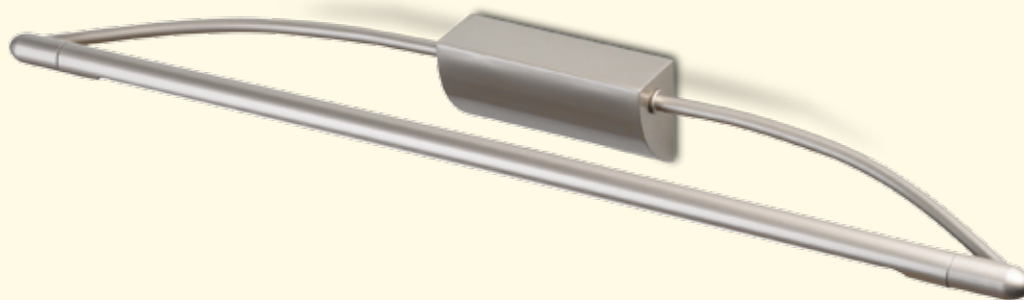
**280-NS**

1 x T5 13W included

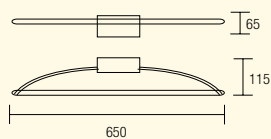



NEWPORT

NS Níquel satinado
 Satin nickel
 Nickel satiné
 Nickel matt
 Nichel satinato
 Níquel acerinado

PP Patiné pintado
 Painted antique
 Brossé peint
 Lackiertes Messing
 Ottone verniciato
 Patiné pintado

**119-PP**

2 x E-14 tubular Max. 40W

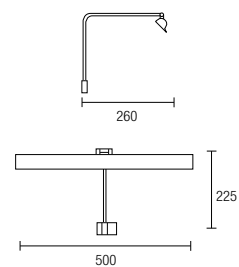
**118-PP**

2 x E-14 tubular Max. 40W

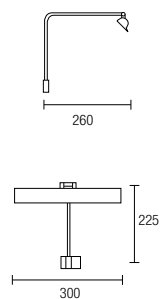

MODULO
ELECTRO

www.modulelectro.ru

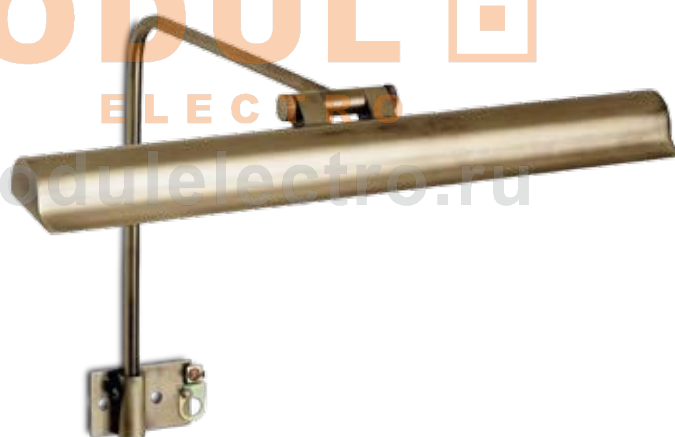
**117-NS**

2 x E-14 tubular Max. 40W

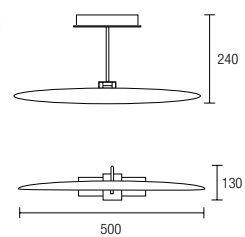



TOLEDO

■ **AL** Aluminio satinado
 Satin Aluminium
 Aluminium satiné
 Aluminium matt
 Alluminio satinato
 lumínio acetinado

Cristal satinado
 Satin glass
 Verre satiné
 Satiniertes Glas
 Cristallo satinato
 Cristal acetinado

435-AL

3 x 2G11 55W included

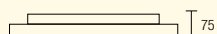
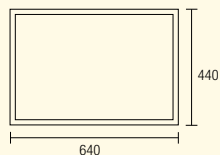
**434-AL**

2 x 2G11 55W included

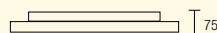
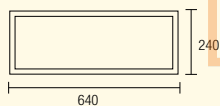

MODULO
ELECTRO

www.modulelectro.ru

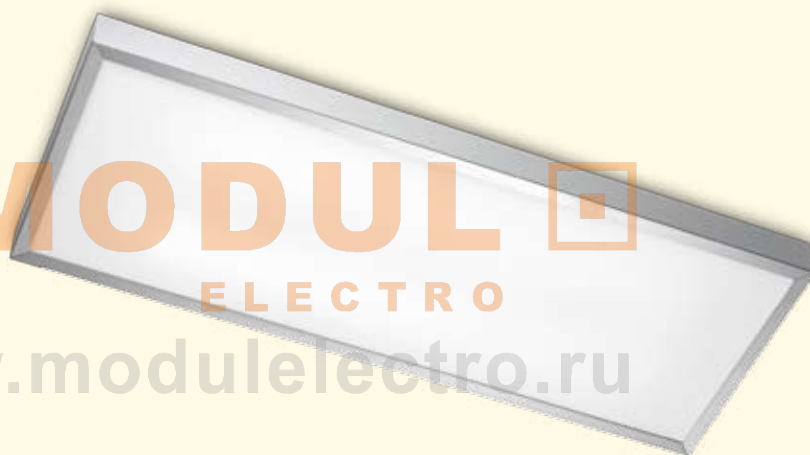
**436-AL**

4 x 2G11 55W included

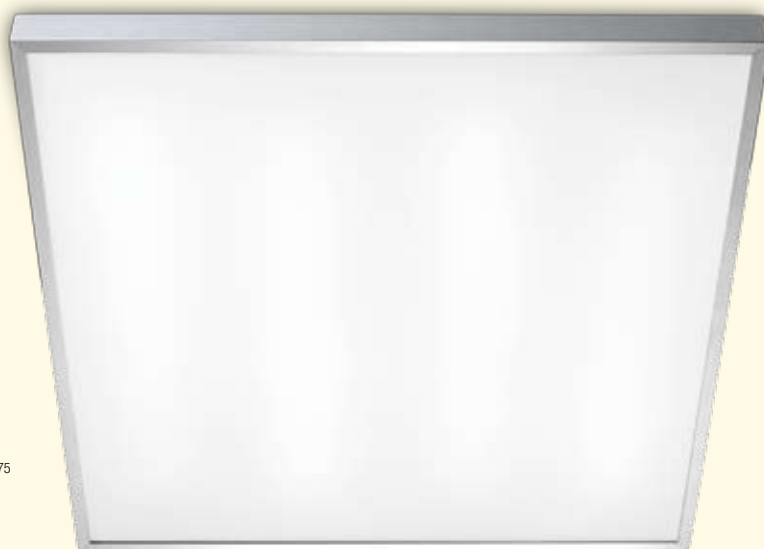
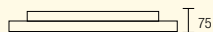
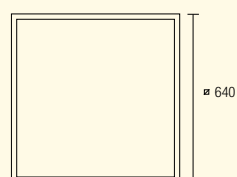



MODULO
ELECTRO
www.modulelectro.ru

VENEZIA

■ CR	Cromo	Cristal satinado y transparente
	Chrome	Satin and transparent glass
	Chrome	Verre satin et transparent
	Chrom	Satiniertes Klarglas
	Cromo	Cristallo satinato e trasparente
	Cromo	Cristal acetinado e transparente

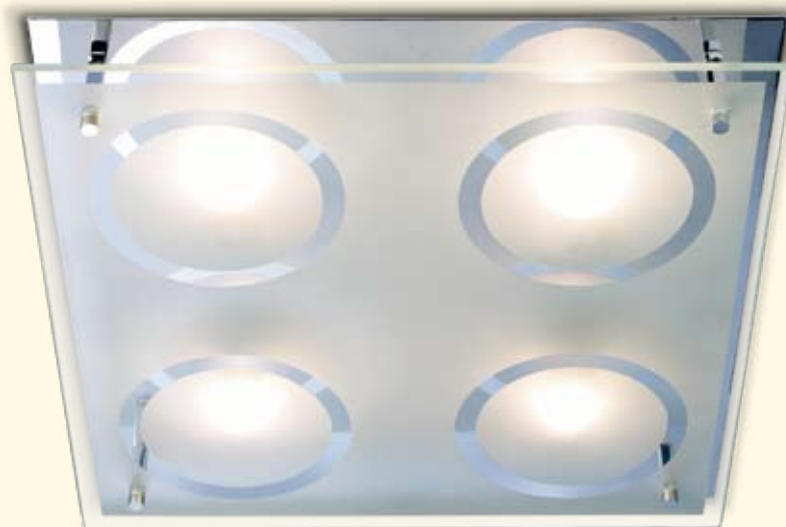
**363-CR**

4 x G9 Max. 60W OSRAM* included

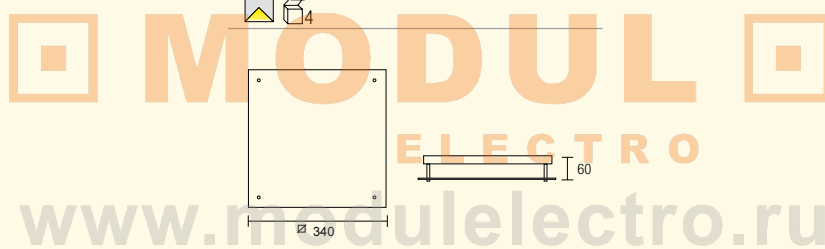
**362-CR**

1 x G9 Max. 60W OSRAM* included



What's New What's New

MODUL
ELECTRO
www.modulelectro.ru

LUGO

■ CR	Cromo	Cristal satinado	Acabado de las partes metálicas en wengué y cromado
	Chrome	Satin glass	Metal parts finished in wengue wood and chrome
	Chrome	Verre satiné	Finitions des pièces métalliques en wengé et chrome
	Chrom	Satiniertes Glas	Metallteile wengué-farben und verchromt
	Cromo	Cristallo satinato	Riniture delle parti metalliche in wengé e cromato
	Cromo	Cristal acetinado	Acabamento das partes metálicas em wengé e cromado

**479-CR**

2 x E-27 Max. 60W / 2 x E-27 PI Elec Max. 21W

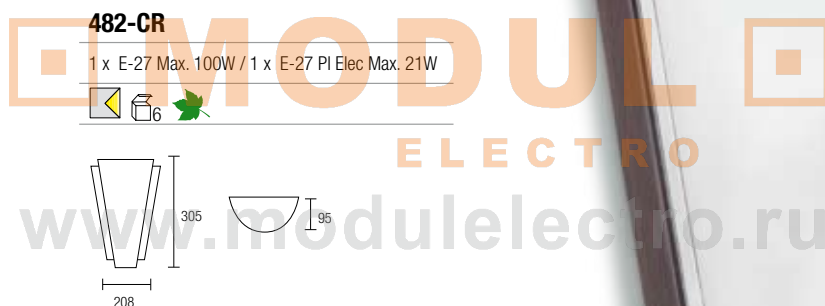
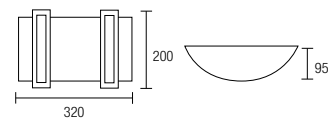
**482-CR**

1 x E-27 Max. 100W / 1 x E-27 PI Elec Max. 21W

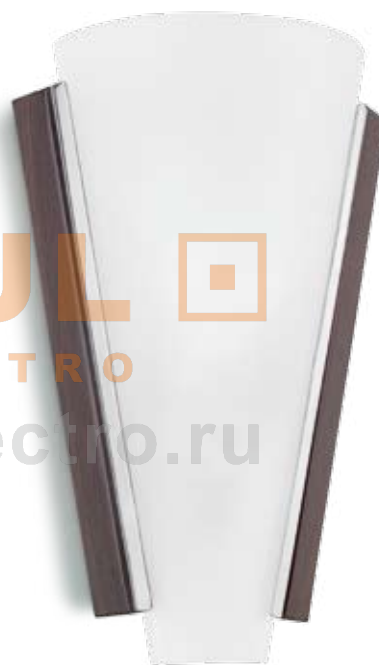
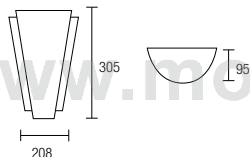
**478-CR**

1 x R7s L=118 Max. 150W OSRAM* included

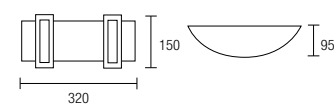



481-CR

1 x R7s L=118 Max. 200W OSRAM* included



484-CR

2 x E-27 Max. 100W / 2 x E-27 PL. Elec Max. 21W

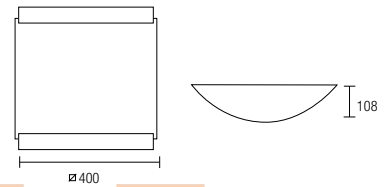
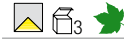

MODULO
ELECTRO

www.modulelectro.ru



480-CR

1 x R7s L=118 Max. 150W OSRAM* included



483-CR

2 x E-27 Max. 60W / 2 x E-27 PL. Elec Max. 21W

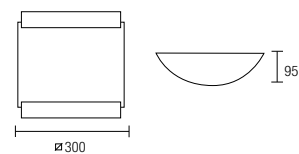



MODULO
ELECTRO

www.modulelectro.ru

465-NM

1 x R7s L=118 Max. 150W OSRAM* included

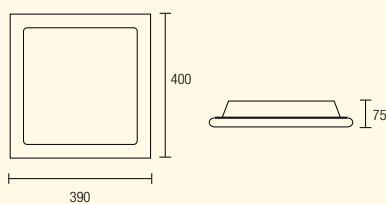

TILS

NM Níquel mate
Nickel matt
Nickel mat
Nickel matt
Nichel opaco
Níquel fosco

Cristal templado satinado
Satin tempered glass
Verre trempé satiné
Satiniertes Gehärtetes Glas
Cristallo temperato satinato
Cristal temperado acetinado



MODUL
ELECTRO
www.modulelectro.ru

MAYA

- **E4** Patiné
Antique brass
Patiné
Alt messing
Patinato
Patinado

**05-2175-E4-E4**

1 x GU-10 Max. 50W

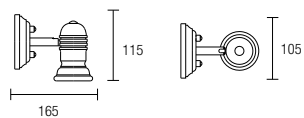



DAKAR

■ **Y2** Marrón envejecido
Old brown
Marron vielli
Alt Braun
Marrone vecchio
Castanho envelhecido

□ **E7** Cristal decorado
Decorated glass
Verre décoré
Dekoglas
Cristallo Decorato
Vidro decorado



15-0550-Y2-E7

1 x R7s Max. 100W OSRAM* included

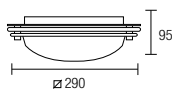

15-0551-Y2-E7

1 x R7s Max. 200W OSRAM* included

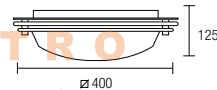

www.modulelectro.ru



15-0549-Y2-E7

1 x G9 Max. 40W OSRAM* included

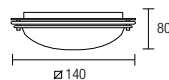



MODUL
ELECTRO
www.modulelectro.ru

KENYA

■ Y2 Marrón envejecido
Old brown
Marron vieilli
Dunkel braun
Marrone vecchio
Castanho envelhecido

□ E7 Cristal blanco
White glass
Verre blanc
Weisses glas
Vetro bianco
Cristal branco



MODUL
ELECTRO

www.modulelectro.ru



15-2588-Y2-E7

2 x E-14 Max. 60W

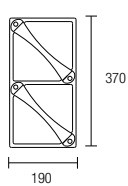

15-2589-Y2-E7

3 x E-14 Max. 60W

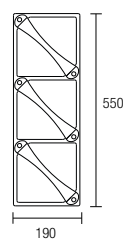



MODULO
ELECTRO
www.modulelectro.ru

MALI

S4 Ámbar dorado
Golden amber
Ambré doré
Vergoldet Bernstein
Ambradorato
Âmbar dourado

Y2 Marrón envejecido
Old brown
Marron vielli
Alt Braun
Marrone vecchio
Castanho envelhecido

E7 Cristal decorado
Decorated Glass
Verre décoré
Dekoglas
Cristallo Decorato
Vidro decorado

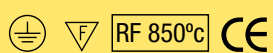

Cristal blanco para acabado marrón envejecido / White glass for old brown finishing
Cristal ámbar para acabado ámbar dorado / Amber Glass for golden amber finishing



15-0319-S4-E7

15-0319-Y2-E7

1 x E-14 Max. 60W esf. Ø 45

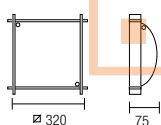

MODULO
ELECTRO

www.modulelectro.ru



15-0322-S4-E7

15-0322-Y2-E7 *

4 x E-14 Max. 60W esf. Ø 45

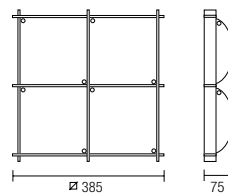

15-0320-S4-E7
15-0320-Y2-E7 *

2 x E-14 Max. 60W esf. Ø 45

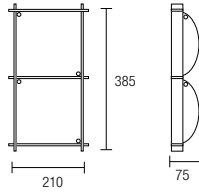

15-0321-S4-E7 *
15-0321-Y2-E7

3 x E-14 Max. 60W esf. Ø 45

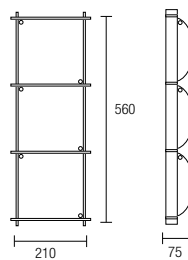

MODULO
ELECTRO
www.modulelectro.ru

**508-Y2**

1 x R7s L=114,2 Max. 150W OSRAM* included

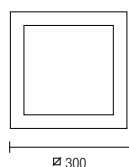
**509-Y2**

1 x R7s L=114,2 Max. 200W OSRAM* included



www.modulelectro.ru

**507-Y2**

1 x G9 Max. 75W OSRAM* included

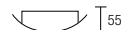
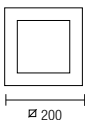

PRACTIC

Y2 Marrón envejecido
Old brown
Marron vieilli
Alt Braun
Marrone rustico
Castanho envelhecido

Cristal satinado
Satin glass
Verre satiné
Satiniertes Glas
Cristallo satinato
Cristal acetinado



MODUL
ELECTRO
www.modulelectro.ru

VERONESE

S4 Ámbar dorado
Golden amber
Ambré doré
Vergoldet Bernstein
Ambra dorato
Âmbar dourado

15 Cristal Ámbar
Ambar Glass
Verre ambre
Bernsetein Glas
Cristallo Ambra
Vidro âmbar

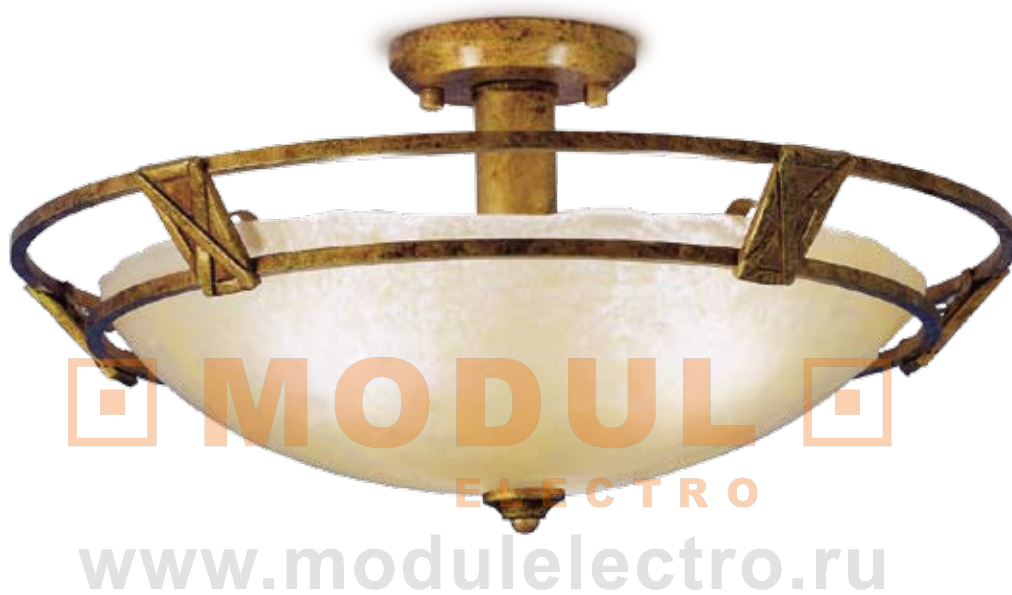
**15-2303-S4-15**

3 x E-27 Max. 60W esf. ø 45

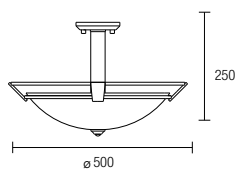

**15-2302-S4-15**

3 x E-27 Max. 60W esf. ø 45

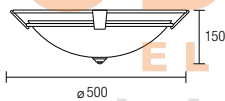

MODULO
ELECTRO
www.modulelectro.ru

**05-2304-S4-15**

1 x E-14 Max. 60W

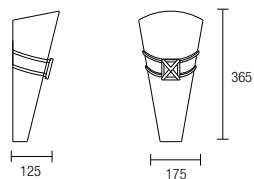

15-2300-S4-15

2 x E-27 Max. 60W esf. \varnothing 45

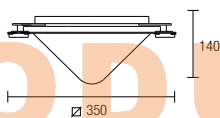

MODULO
ELECTRO

www.modulelectro.ru

15-2301-S4-15

2 x E-27 Max. 60W esf. \varnothing 45

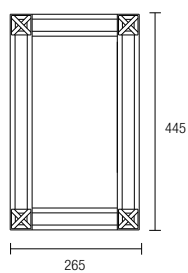
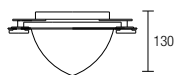



WOOD

■ CR

Cromo
Chrome
Chrome
Chrom
Cromo
Cromo

Madera wengué
Wenge wood
Bois de wengé
Wengé-Holz
Legno wengé
Madeira wengé

**415-CR**

5 x GU-10 Max. 50W OSRAM* included

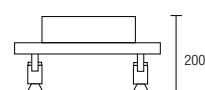
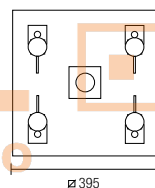
2 Encendidos independientes
2 Separate switches

www.modulelectro.ru

**414-CR**

3 x GU-10 Max. 50W OSRAM* included

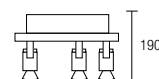
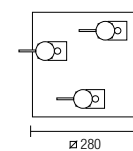

**413-CR**

2 x GU-10 Max. 50W OSRAM* included

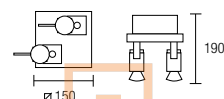

MODULO
ELECTRO

www.modulelectro.ru

**412-CR**

3 x GU-10 Max. 50W OSRAM* included

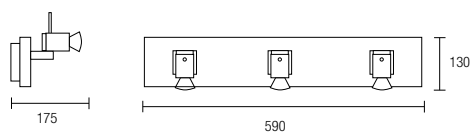

**411-CR**

2 x GU-10 Max. 50W OSRAM* included

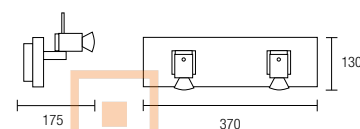

MODULO
ELECTRO

www.modulelectro.ru

**410-CR**

1 x GU-10 Max. 50W OSRAM* included ON-OFF

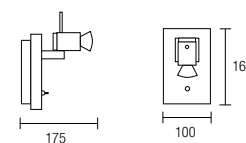
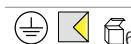

**416-CR**

5 x GU-10 Max. 50W OSRAM* included



2 Encendidos independientes
2 Separate switches

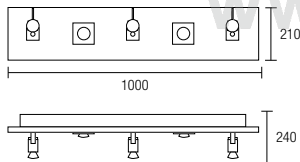

MODULO
ELECTRO

www.modulelectro.ru

**417-CR**

4 x GU-10 Max. 50W OSRAM* included

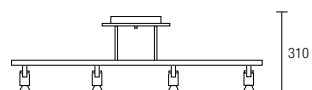
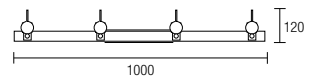



MODUL
ELECTRO
www.modulelectro.ru

FLASH

■	CR	Cromo	Cristal transparente extra blanco
		Chrome	Extra white transparent glass
		Chrome	Verre transparent extrablanc
		Chrom	Transparentes Glas superweiß
		Cromo	Vetro trasparente extra-bianco
		Cromo	Cristal transparente extra-branco

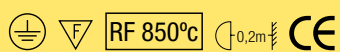

**385-CR**

4 x GU-10 Max. 50W OSRAM* included

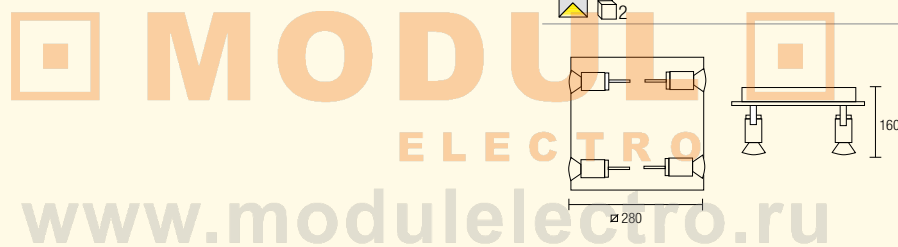
**380-CR**

1 x GU-10 Max. 50W OSRAM* included

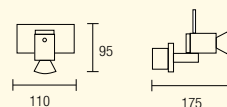

**382-CR**

3 x GU-10 Max. 50W OSRAM* included

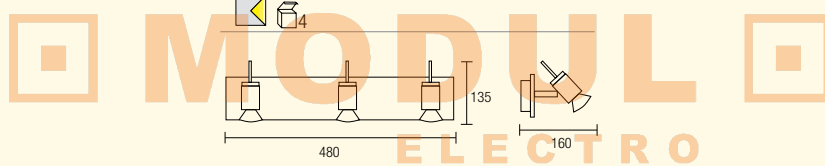

www.modulelectro.ru

**381-CR**

2 x GU-10 Max. 50W OSRAM* included

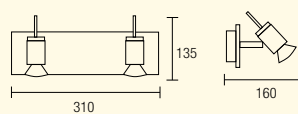

**391-CR**

2 x GU-10 Max. 50W OSRAM* included

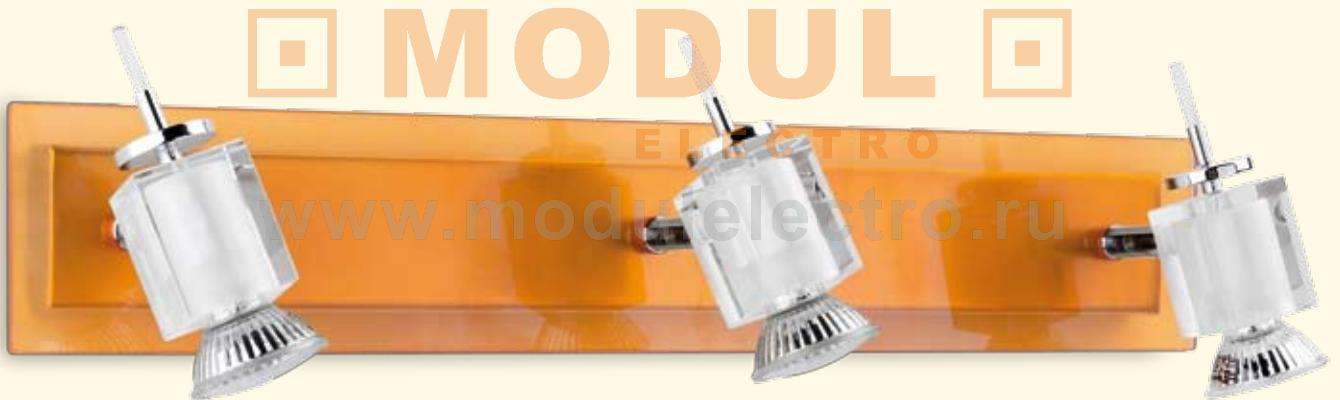
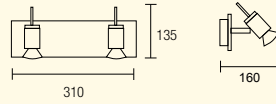
**392-CR**

3 x GU-10 Max. 50W OSRAM* included

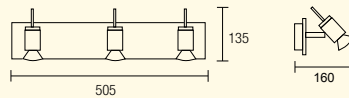
**ORANGE**

■ CR	Cromo	Cristal naranja
	Chrome	Orange glass
	Chrome	Verre orange
	Chrom	Oranges Glas
	Cromo	Vetro arancia
	Cromo	Cristal cor de laranja

**394-CR**

3 x GU-10 Max. 50W OSRAM* included

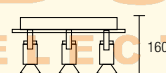
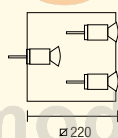

MODULO
ELECTRO
www.modulelectro.ru

**390-CR**

1 x GU-10 Max. 50W OSRAM* included





MODUL
ELECTRO
www.modulelectro.ru

SHINE

■ CR	Cromo	Espejo extra blanco
	Chrome	Extra white mirror
	Chrome	Miroir extra blanc
	Chrom	Extra weisser Spiegel
	Cromo	Specchio extra bianco
	Cromo	Espelho extra branco

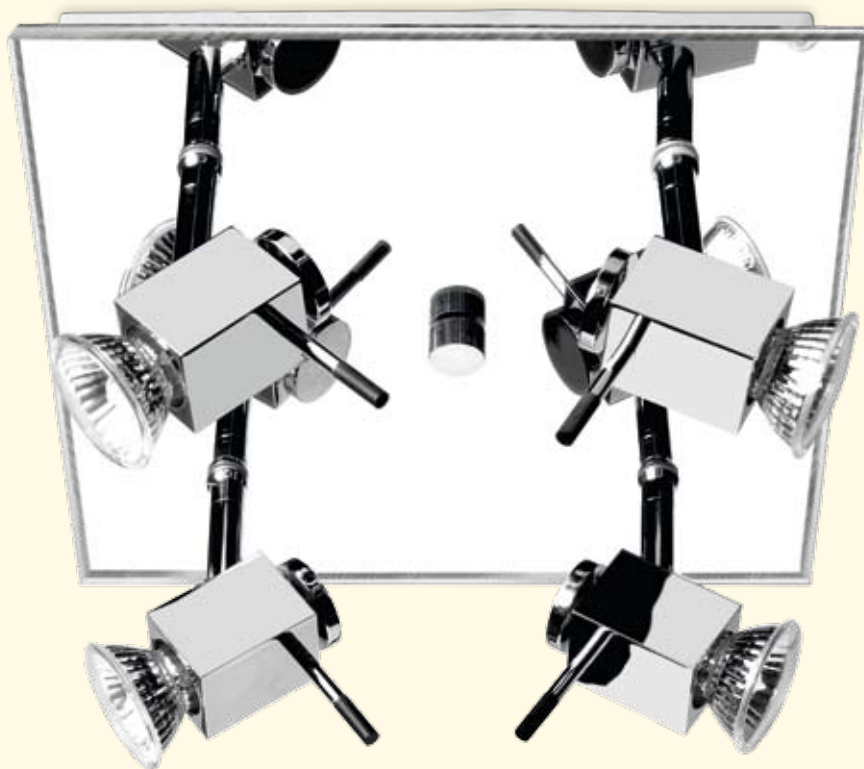

MODUL

503-CR

4 x GU-10 Max. 50W OSRAM* included



ELECTRO

www.modulelectro.ru

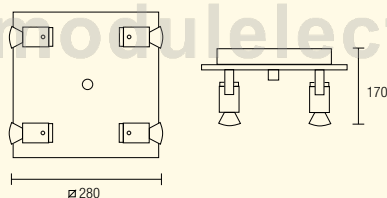

500-CR

1 x GU-10 Max. 50W OSRAM* included

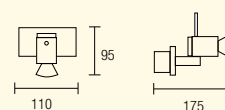



MODUL

ELECTRO

501-CR

2 x GU-10 Max. 50W OSRAM® included

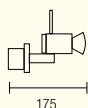
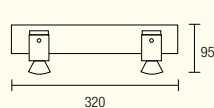

www.modulselectro.ru

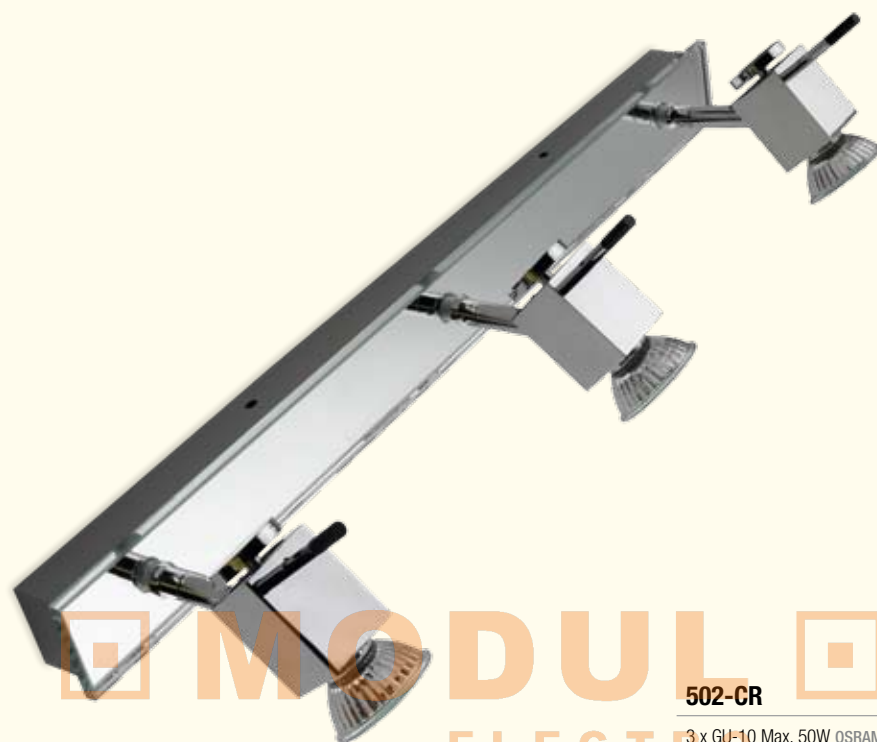

**502-CR**

3 x GU-10 Max. 50W OSRAM* included

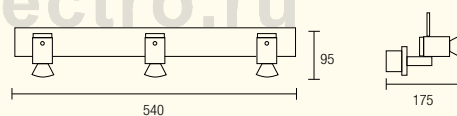
www.modulelectro.ru



MODUL
ELECTRO
www.modulselectro.ru

MODENA

■ CR

Cromo
Chrome
Chrome
Chrom
Cromo
Cromo

Cristal pirex
Pirex glass
Verre pirex
Pirexglas
Vetro pirex
Cristal pírex

**355-CR**

2 x GU-10 Max. 50W OSRAM* included

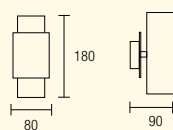

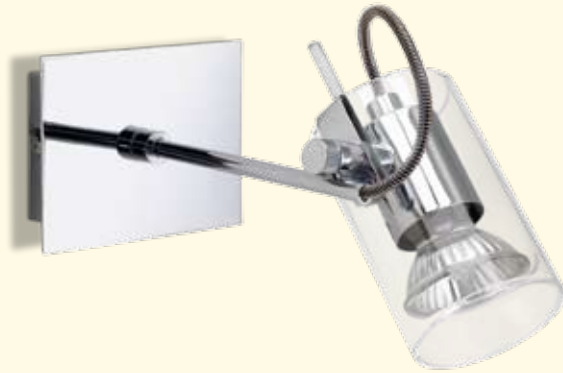
**352-CR**

1 x GU-10 Max. 50W OSRAM* included

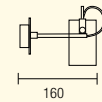
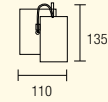
**353-CR**

2 x GU-10 Max. 50W OSRAM* included

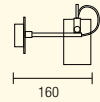
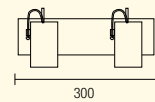
**354-CR**

3 x GU-10 Max. 50W OSRAM* included

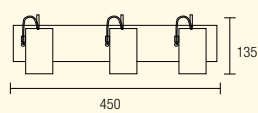

**357-CR**

4 x GU-10 Max. 50W OSRAM* included

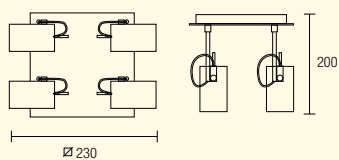



MODUL
ELECTRO

www.modulelectro.ru

TECH

- NM** Niquel mate
 Nickel matt
 Nickel mat
 Nickel matt
 Nichel opaco
 Niquel fosco

**201-NM**

4 x GU-10 Max. 50W OSRAM*included

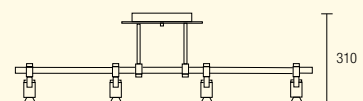
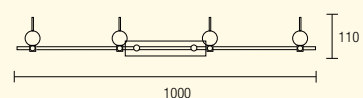

MODUL
ELECTRO

www.modulelectro.ru

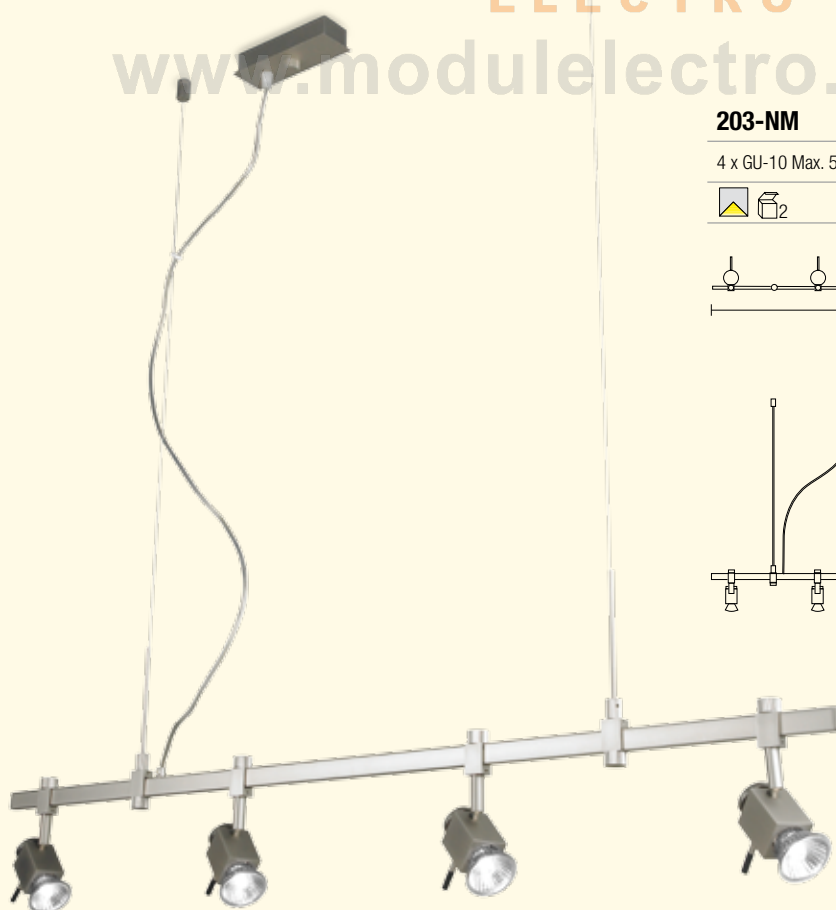
**203-NM**

4 x GU-10 Max. 50W OSRAM*included

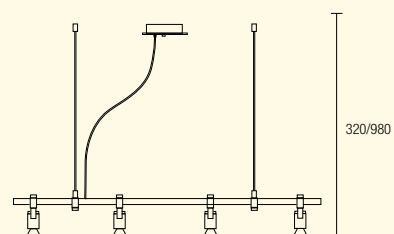
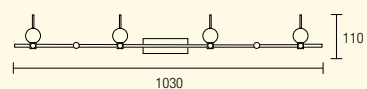

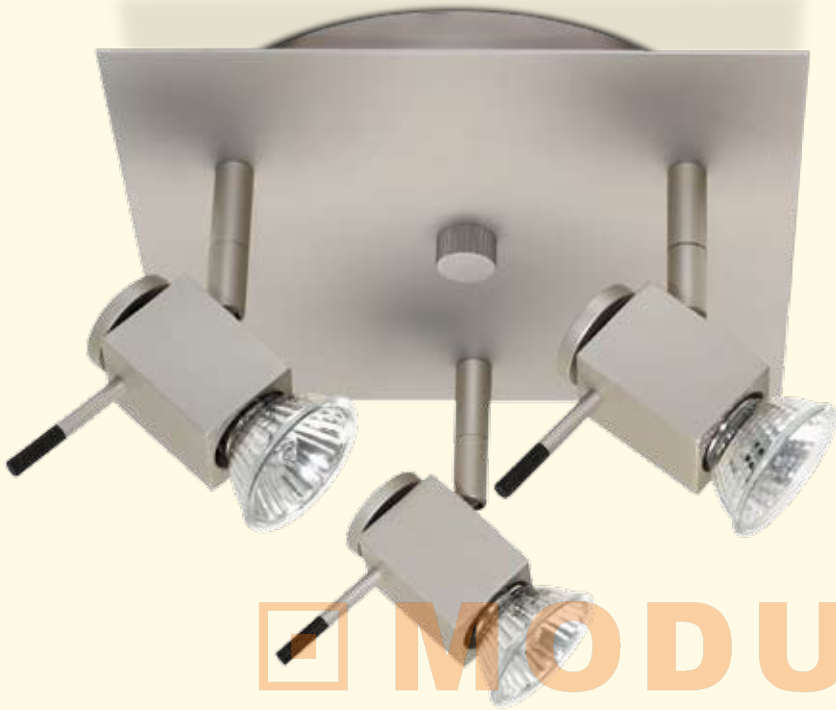
**200-NM**

3 x GU-10 Max. 50W OSRAM* included

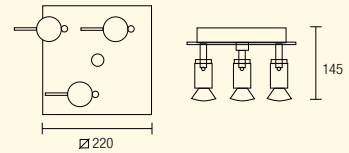

MODULO
ELECTRO

www.modulelectro.ru

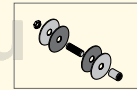
**242-NM**

Kit para espejo / Mirror kit / Kit pour miroir
Set für spiegel / Kit per specchio / Kit para espelho

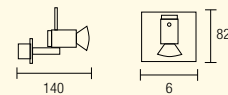
**195-NM**

1 x GU-10 Max. 50W OSRAM* included

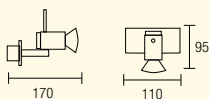

**198-NM**

4 x GU-10 Max. 50W OSRAM* included

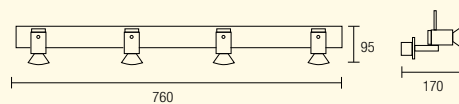
**197-NM**

3 x GU-10 Max. 50W OSRAM* included

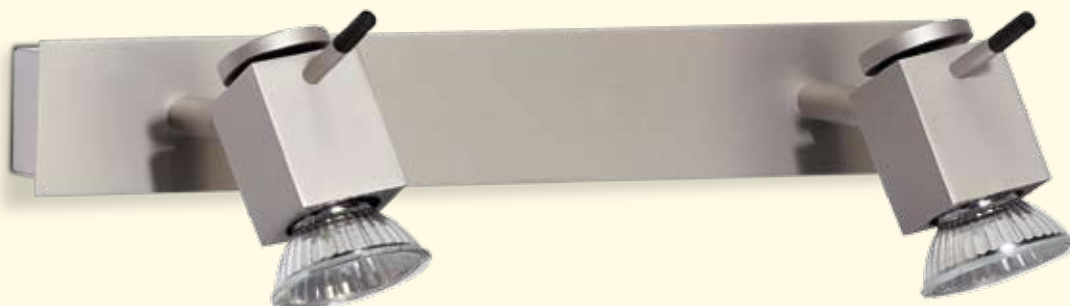
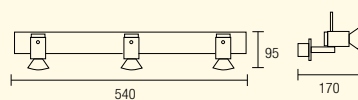
**196-NM**

2 x GU-10 Max. 50W OSRAM* included

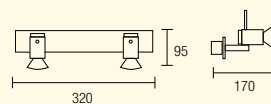

MODUL
ELECTRO
www.modulelectro.ru

LUXE

■ **CN** Cromo negro
Black chrome
Chrome noir
Schwartz Chrom
Cromo nero
Cromo preto

Cristal extra blanco
Extra white glass
Verre extrablanc
Glas superweiß
Vetro extra-bianco
Cristal extra-branco

**518-CN**

1 x G9 Max. 60W OSRAM included

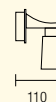
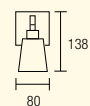
**519-CN**

2 x G9 Max. 60W / 2 x G9 40W OSRAM included

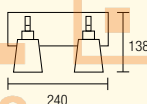
**520-CN**

3 x G9 Max. 60W / 3 x G9 40W OSRAM included

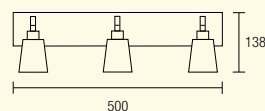

MODULO
ELECTRO
www.modulelectro.ru



MODUL
ELECTRO
www.modulelectro.ru

SPLIT

BL Blanco
White
Blanc
Weiss
Bianco
Branco

NS Níquel satinado
Satin nickel
Chrome
Chrom
Cromo
Cromo

CR Cromo
Chrome
Nickel satiné
Nickel matt
Níchel satinato
Níquel acetinado

Cristal templado
Tempered glass
Verre temple
Gehärtetes Glas
Vetro temperato
Cristal temperado



Transformador no incluido
Transformer not included

**320-BL**

1 x GU-5.3 Max. 50W 12V

**320-CR**

1 x GU-5.3 Max. 50W 12V

**320-NS**

1 x GU-5.3 Max. 50W 12V



MODULO
ELECTRO
www.modulelectro.ru



MODUL
ELECTRO
www.modulelectro.ru

DRESDE

CR

Cromo
Chrome
Chrome
Chrom
Cromo
Cromo

Policarbonato opal
Opal policarbonato
Policarbonato opal
Opales Polikarbonat
Policarbonato opalina
Policarbonato opala



IP 23



included

**325-CR**

1 x 2G11 18W included

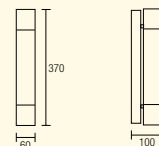
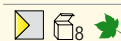
**326-CR**

1 x 2G11 24W included

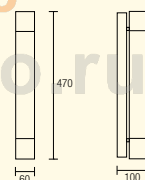
**327-CR**

1 x 2G11 40W included

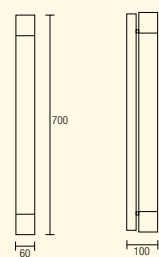
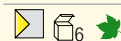

MODULO
ELECTRO
www.modulelectro.ru



MODUL
ELECTRO
www.modul-electro.ru

VERONA

■ CR	Cromo	Cristal espejo
	Chrome	Mirror glass
	Chrome	Verre miroir
	Chrom	Spiegelglas
	Cromo	Cristallo specchio
	Cromo	Cristal espelho



RF 850°C



IP 23



Indicado para superficie y empotrar
Suitable for surface & built-in

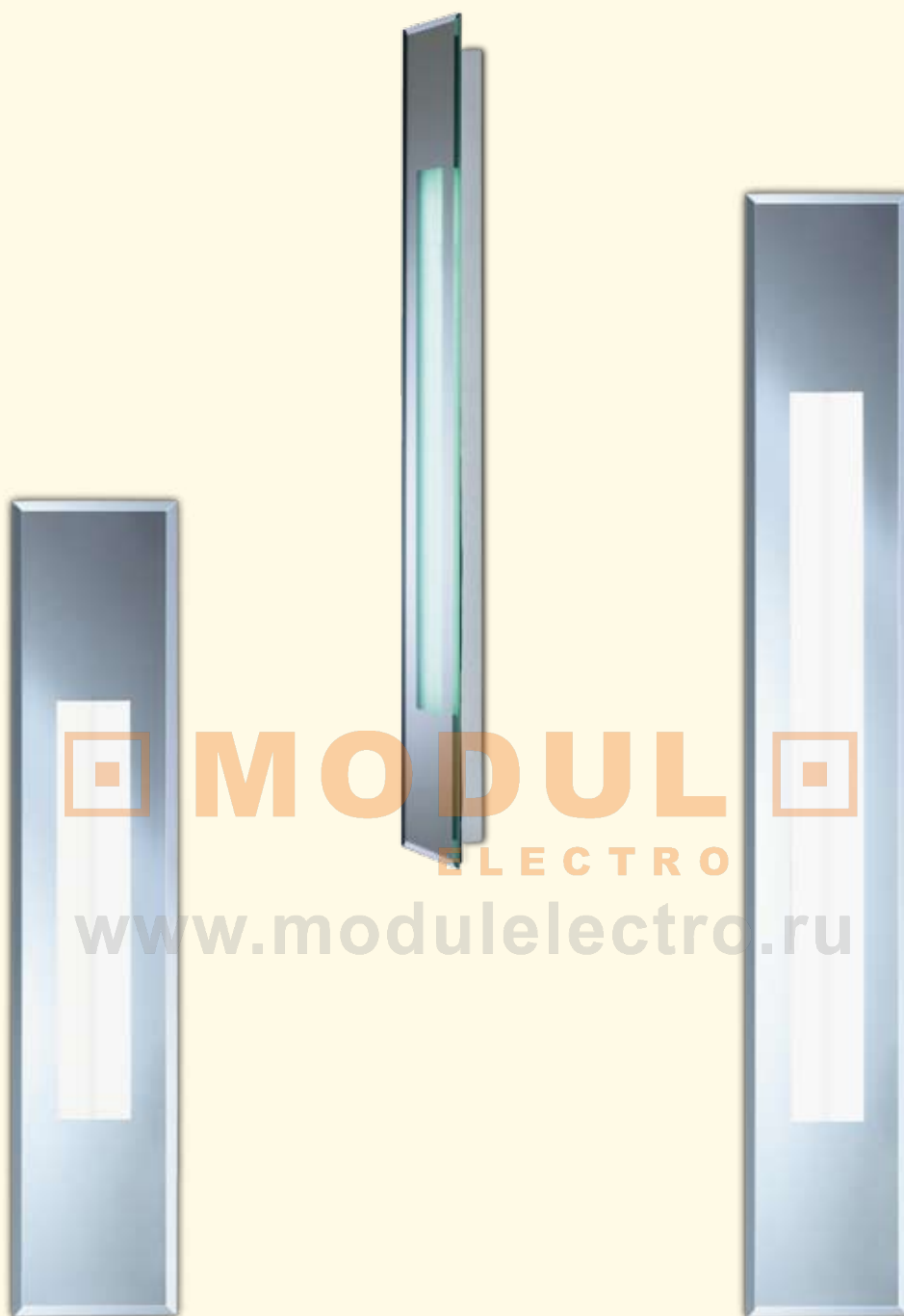

MODULO
ELECTRO
www.modulelectro.ru

318-CR

2 x T5 8W included

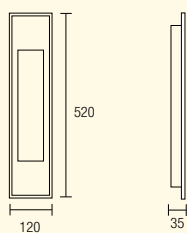
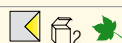
**319-CR**

2 x T5 13W included

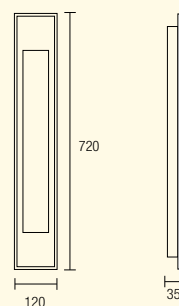
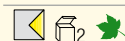

408-NS

1 x E-27 PL Elec 20W included

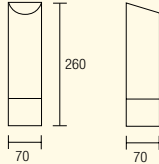

MODULO
ELECTRO
www.modulelectro.ru

**407-CR**

1 x G9 Max 60W OSRAM* included

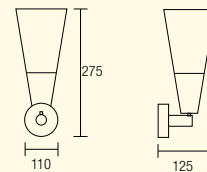
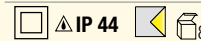
**BATH**

CR Cromo
Chrome
Chrome
Chrom
Cromo
Cromo

NS Níquel satinado
Satin nickel
Nickel satiné
Nickel matt
Níchel satinat
Níquel acetinado

Cristal opal
Opal glass
Verre opale
Opalglas
Vetro opalina
Vidrio opala

AL Aluminio satinado
Satin aluminium
Aluminium satiné
Aluminium matt
Aluminio satinado
Alumínio acetinado

Cristal templado satinado
Satin tempered glass
Verre trempé satiné
Satinieretes Gehärtetes glas
Cristallo temperato satinato
Cristal temperado acetinado

450-AL

1 x G9 Max 60W OSRAM* included

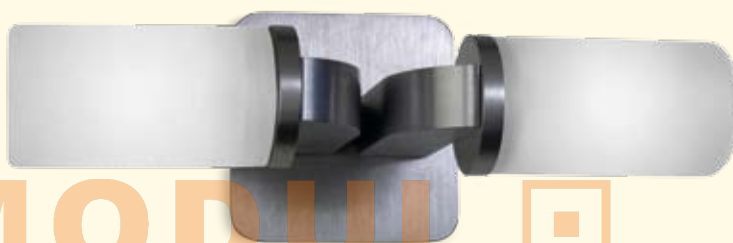
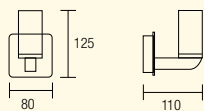
**451-AL**

2 x G9 Max 60W / 2 x G9 40W OSRAM* included

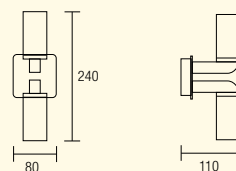

www.modulelectro.ru

**452-AL**

3 x G9 Max 60W / 3 x G9 40W OSRAM* included

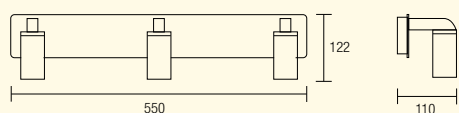

MODUL

ELECTRO

www.modulselectro.it

LORIENT

- CR Cromo
- Chrome
- Chrome
- Chrom
- Cromo
- Cromo

- Cristal opal
- Opal glass
- Verre opale
- Opalglas
- Vetro opalina
- Vidrio opala

**324-CR**

1 x G9 Max. 60W OSRAM included

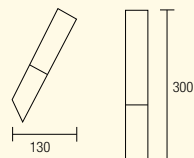

MODULO
ELECTRO
www.modulelectro.ru

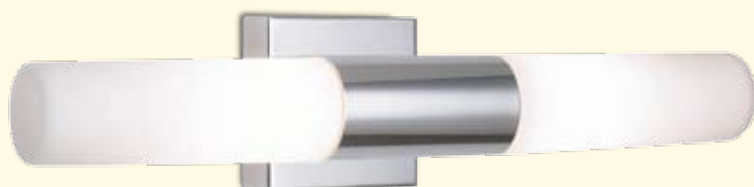
**323-CR**

2 x G9 Max. 40W OSRAM included



Posición vertical y horizontal
Vertical and horizontal position

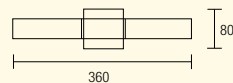



ONDA

	BL Cristal satinado Satin glass Verre satiné Satiniertes Glas Cristallo satinato Cristal acetinado	Acabado de las partes metálicas en lacado blanco Metal parts finished in white lacquer Finition des pièces métalliques laquées en blanc Metallteile weiß lackiert Rifiniture delle parti metalliche in laccato bianco Acabamento das partes metálicas em lacado branco
---	--	---

Incorpora kit para instalación directa encima de espejo
Incorporates kit for direct installation on top of mirror
Incorpore kit pour l'instation directe sur le miroir
Einschließlich Kit zum Einbau direkt über dem Spiegel
Include il kit per l'installazione diretta sullo specchio
Incorpora kit para instalação directa em cima de espelho

**485-BL**

1 x G9 Max. 75W OSRAM included

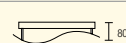
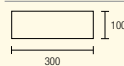

MODULO

486-BL

2 x G9 Max. 75W OSRAM included

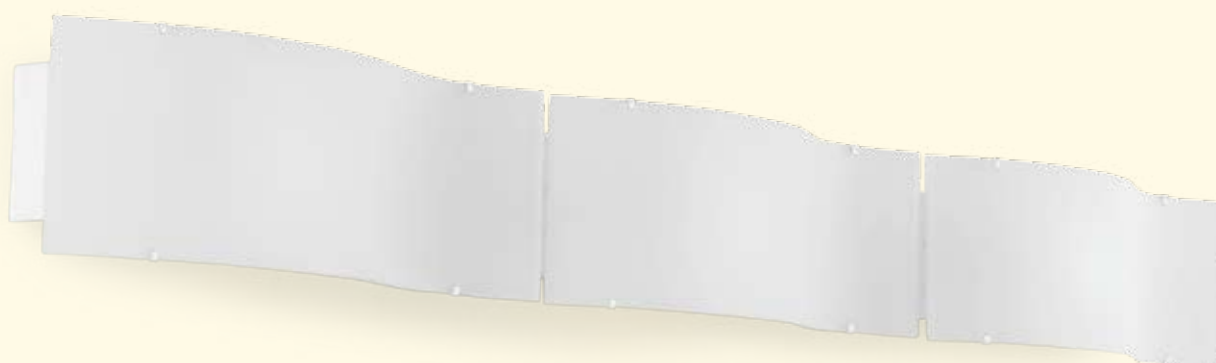
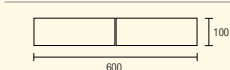
**487-BL**

3 x G9 Max. 75W OSRAM included

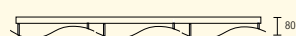
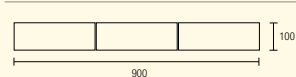

www.modulelect.ru

MODUL

ELECTRO

www.modulelectro.ru

TOILET

■ CR	Cromo	Policarbonato opal
	Chrome	Opal policarbonato
	Chrome	Policarbonato opal
	Chrom	Opales Polikarbonat
	Cromo	Policarbonato opalina
	Cromo	Policarbonato opala

**449-CR**

1 x T5 21W Included

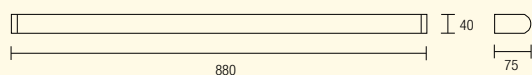
**448-CR**

1 x T5 14W Included

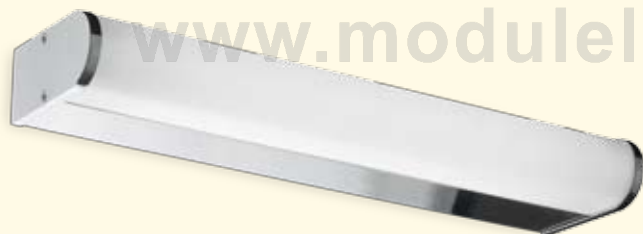
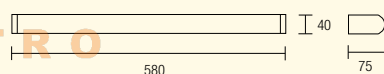
**447-CR**

1 x T5 8W Included

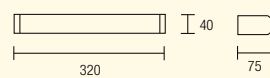
**457-CR**

1 x 2G11 24W Included

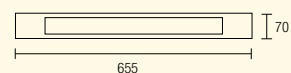
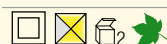

MODU
ELECTRO
www.modulelectro.ru



TOILET Q

■ CR	Cromo	Policarbonato opal
	Chrome	Opal policarbonate
	Chrome	Verre opale
	Chrom	Opalglas
	Cromo	Vetro opalina
	Cromo	Vidro opala



MODULO
ELECTRO
www.modulelectro.ru

515-CR

1 x T5 8W Included

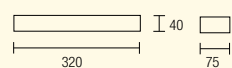
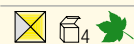
**516-CR**

1 x T5 14W Included

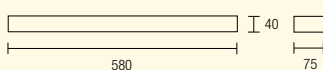
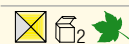
**517-CR**

1 x T5 21W Included

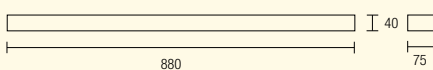
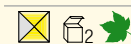



MODUL
ELECTRO
www.modulelectro.ru



REFLEX

ES Espejo
MIRROR
Miroir
Spiegel
Specchio
Espelho

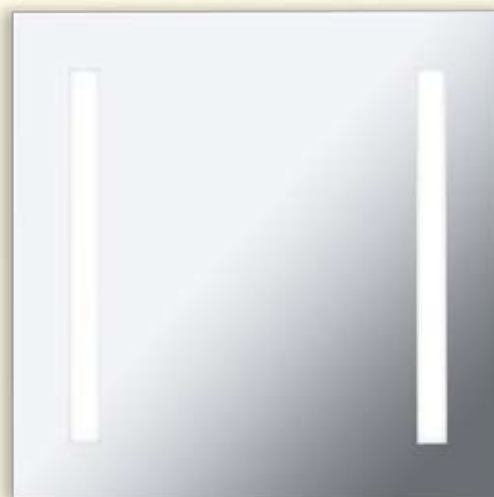
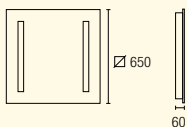

CR Cromo
Chrome
Chrome
Chrom
Cromo
Cromo

425-ES

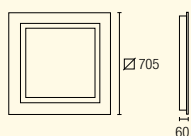

2 x 2G11 55W included

IP 23  **427-ES**

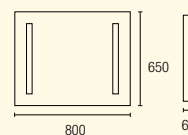

4 x 2G11 40W included

IP 23  **426-ES**

2 x 2G11 55W included

IP 23  **476-CR**

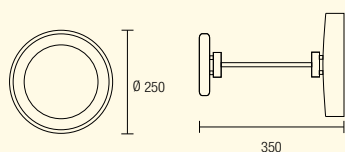
1 x T5 22W 4000K PHILLIPS included

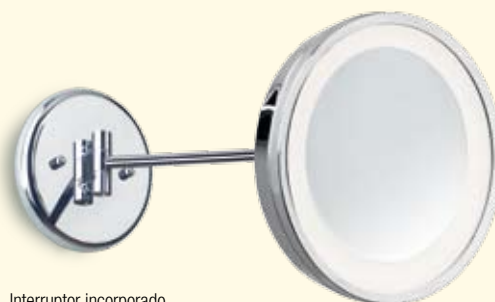
IP 44  Cable eléctrico blanco
White electrical cableEspejo orientable horizontalmente
Horizontally adjustable mirrorInterruptor incorporado
Switch incorporated



MODUL
ELECTRO
www.modul-electro.ru



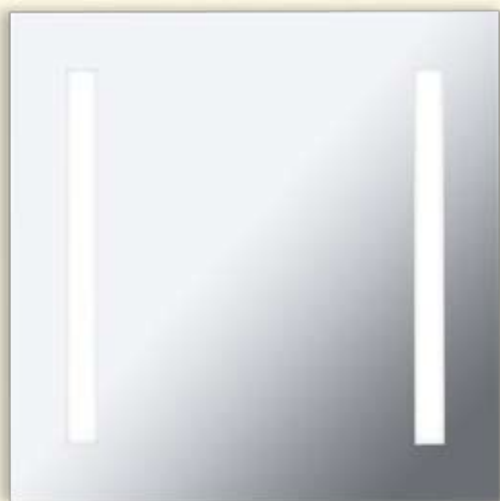



Incorpora sistema anti-vaho
Defogster system included
Système anti-buée inclus
Mit antibeschlag System
Incorpora sistema antivapore
Incorpora sistema anti embaciamento

468-ES

2 x 2G11 55W included

IP 23  

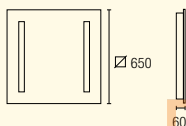

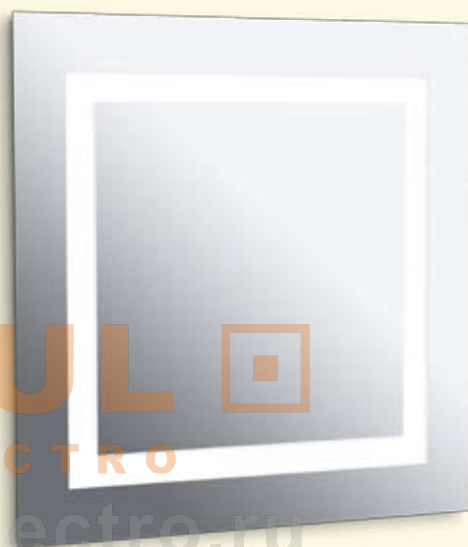

MODULO
ELECTRO
www.modulelectro.ru



469-ES

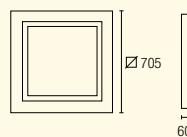

4 x 2G11 40W included

IP 23  



467-ES

2 x 2G11 55W included

IP 23  

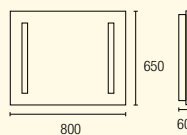

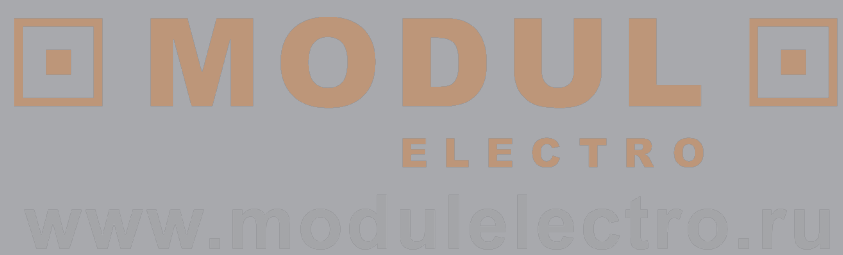

ventilación

ventilation

ventilation

MODUL

ELECTRO

www.modulelectro.ru

ventilazione

ventilação

ventilation

VENTILADORES

Las ventajas de los ventiladores de techo La Creu:

Una temperatura óptima Ahorro energético

En Verano:

Los ventiladores giran proporcionando una suave brisa que activa la circulación del aire impidiendo la acumulación de calor en la habitación. En el caso de que exista una instalación del aire acondicionado, los ventiladores hacen circular el aire fresco de forma uniforme, evitando que el aparato de aire acondicionado este en uso de forma constante pudiendo ahorrar energía hasta un 40% y reduciendo la factura de electricidad.

En Invierno:

También en Invierno los ventiladores La Creu son útiles. El aire caliente pesa menos que el aire frío, por lo que tiende a concentrarse en el techo. Los ventiladores La Creu giran inversamente a como lo hacen en verano. Haciendo que el aire acumulado en el techo baje y el calor se distribuya por toda la habitación.

La temperatura ambiente aconsejable en una habitación es de 20 a 24°, cada aumento o disminución de un grado, supone un 6% de los gastos de calefacción.

Escoja el mejor ventilador para cada habitación:

- Habitaciones de hasta 25 m² – Se aconseja un diámetro de ventilador de 112 cm a 122 cm.
- Habitaciones de hasta 40 m² – Se aconseja un diámetro de ventilador de 132 cm a 137 cm.

Situación del ventilador:

- La distancia máxima hasta el suelo 2,4 m. Si existe más distancia el aire no llegará bien.
- La distancia mínima desde el techo hasta la parte superior del ventilador: 30 cm.
- La distancia mínima desde el extremo exterior de la pala hasta la pared: 0,5 m.

The advantages of La Creu ceiling fans:

An optimum temperature Energy savings

In Summer:

The fans rotate and give off a soft breeze that activates air circulation, thus preventing an accumulation of heat in the room. In the event that there is an air conditioning unit, the fans circulate fresh air evenly. They thus prevent the air conditioning unit from being constantly in use. As a result, there can be an energy savings of up to 40% which lowers the electricity bill.

In Winter:

La Creu fans are also useful in Winter. Hot air weighs less than cold air. Therefore, it tends to concentrate near the ceiling. La Creu fans rotate inversely to the direction in which they rotate in summer. They make the air accumulated near the ceiling descend. Then heat is distributed throughout the room. The recommended room temperature for a room is between 20 and 24°. Each increase or decrease by one degree entails 6% of the heating expenses.

Choose the best fan for each room:

- Rooms up to 25 m² – We recommend a fan with a diameter from 112 cm to 122 cm.
- Rooms up to 40 m² – We recommend a fan with a diameter from 132 cm to 137 cm.

Fan location:

- The maximum distance to the floor is 2.4 m. If the distance is greater, the air will not properly reach its target.
- The minimum distance from the ceiling to the upper part of the fan: 30 cm.
- The minimum distance from the blade's outer edge to the wall: 0.5 m.

Les avantages des ventilateurs de plafond La Creu :

Une température optimale Économie d'énergie

En été :

Les ventilateurs tournent en apportant une douce brise qui active la circulation de l'air et empêche l'accumulation de chaleur dans la pièce. Dans le cas où il existe une installation de climatisation, les ventilateurs font circuler uniformément l'air frais en évitant que l'appareil soit en utilisation continue, ce qui permet un économie d'énergie allant jusqu'à 40 % et une réduction de la facture d'électricité.

En hiver :

Les ventilateurs La Creu sont aussi utiles en hiver. L'air chaud est moins lourd que l'air froid, donc il tend à se concentrer au plafond. Les ventilateurs La Creu tournent en sens inverse de celui suivi en été en permettant que l'air accumulé au plafond descende et que la chaleur se distribue dans toute la pièce. La température ambiante conseillée est de 20 à 24 °C; chaque augmentation ou diminution d'un degré suppose 6 % des frais de chauffage.

Choisissez votre ventilateur en fonction de la surface de la pièce à ventiler :

- Pièces allant jusqu'à 25 m² – Un diamètre du ventilateur de 112 à 122 cm est conseillé.
- Pièces allant jusqu'à 40 m² – Un diamètre du ventilateur de 132 à 137 cm est conseillé.

Emplacement du ventilateur :

- Distance maximale jusqu'au sol : 2,4 m. Si la distance est plus grande, l'air n'arrivera pas correctement.
- Distance minimale du plafond au dessus du ventilateur: 30 cm.
- Distance minimale de l'extrémité extérieure de la pale au mur: 0,5 m.

Die Vorteile der Deckenventilatoren La Creu:

Eine optimale Raumtemperatur
Energiesparend

Im Sommer:

Durch die Ventilatorumdrehung wird sanfter Wind erzeugt, die Umwälzung der Luft im Raum gefördert und das Anstauen der Wärme in einzelnen Bereichen des Zimmers verhindert.

Bei gleichzeitigem Betrieb einer Klimaanlage bewirken Ventilatoren ein gleichmäßiges Zirkulieren der kühlen Luft. Auf diese Weise muss das Klimagerät nicht ständig auf Hochtouren laufen und es können bis zu 40% des Energieverbrauchs eingespart werden, was eine dementsprechende Senkung der Stromrechnung zur Folge hat.

Im Winter:

Auch im Winter sind die Ventilatoren La Creu nützlich. Warmluft weist ein geringeres Gewicht als Kaltluft auf, weshalb sie dazu neigt, sich unterhalb der Zimmerdecke anzustauen. Die Ventilatoren La Creu laufen dann in umgekehrter Drehrichtung als im Sommer. Dadurch sinkt die an der Decke angestaute Luft nach unten und die Wärme verteilt sich gleichmäßig im gesamten Raum.

Empfehlenswert ist eine Raumtemperatur zwischen 20 und 24°C. Eine Steigerung um nur einen Grad bewirkt eine Erhöhung der Heizkosten um 6%.

Wählen Sie den geeignetsten Ventilator für jedes Zimmer:

- Zimmer bis zu 25 m² – Empfohlen werden Ventilatoren mit einem Durchmesser von 112 cm bis 122 cm.
- Zimmer bis zu 40 m² – Empfohlen werden Ventilatoren mit einem Durchmesser von 132 cm bis 137 cm.

Montageabstände vom Ventilator:

- Der Höchstabstand zum Boden beträgt 2,4 m. Bei höheren Abständen kann der Luftzug nur unzureichend verspürt werden.
- Der Mindestabstand von der Decke zum oberen Teil des Ventilators beträgt 30 cm.
- Der Mindestabstand von der oberen Kante der Flügelplatte zur Wand beträgt 0,5 m.

I vantaggi dei ventilatori da soffitto La Creu:

Temperatura ottimale
Risparmio energetico

In estate:

I ventilatori girano emettendo una leggera brezza che attiva la circolazione dell'aria, impedendo l'accumulo di calore nell'abitazione.

Qualora sia presente un impianto di condizionamento dell'aria, i ventilatori faranno circolare l'aria fresca in modo uniforme, evitando il funzionamento continuo del condizionatore dell'aria e consentendo quindi un risparmio energetico fino al 40%, con conseguente riduzione dei costi per l'energia elettrica.

In inverno:

I ventilatori La Creu sono utili anche in inverno. L'aria calda ha un peso inferiore rispetto all'aria fredda, poiché tende a concentrarsi sul soffitto.

I ventilatori La Creu girano in senso opposto rispetto a quanto effettuato in estate, consentendo la discesa dell'aria accumulata sul soffitto e garantendo quindi una distribuzione del calore in tutta l'abitazione.

La temperatura ambiente consigliata nelle abitazioni è pari a 20° - 24°; ogni aumento o diminuzione di un grado, è pari al 6% delle spese di riscaldamento.

Selezione del ventilatore più appropriato per ogni abitazione:

- abitazioni fino a 25 m² – si consiglia un ventilatore con diametro da 112 cm a 122 cm.
- abitazioni fino a 40 m² – si consiglia un ventilatore con diametro da 132 cm a 137 cm.

Ubicazione del ventilatore:

- distanza massima dal pavimento 2,4 m. Una distanza maggiore non consentirà una corretta propagazione dell'aria.
- distanza minima dal soffitto alla parte superiore del ventilatore: 30 cm.
- distanza minima dall'estremità esterna della pala alla parete: 0,5 m.

As vantagens dos ventiladores de tecto La Creu:

Uma temperatura ótima
Poupança de energia

No Verão:

Os ventiladores giram proporcionando uma suave brisa que activa a circulação do ar, impedindo a acumulação de calor na habitação.

Caso haja uma instalação de ar condicionado, os ventiladores fazem circular uniformemente o ar fresco, evitando que o aparelho de ar condicionado esteja constantemente em uso, podendo poupar até 40% de energia e reduzindo a factura da electricidade.

No Inverno:

No Inverno os ventiladores La Creu também são úteis. O ar quente pesa menos do que o ar frio, pelo que tende a concentrar-se no tecto. Os ventiladores La Creu giram inversamente à forma como o fazem no Verão, fazendo com que o ar acumulado no tecto baixe e o calor se distribua por toda a habitação.

A temperatura ambiente aconselhável numa habitação é de 20 a 24°. Cada aumento ou diminuição de um grau, representa 6% das despesas de aquecimento.

Escolha o melhor ventilador para cada quarto:

- Compartimentos até 25 m² – Aconselha-se um diâmetro de ventilador de 112 cm a 122 cm.
- Compartimentos até 40 m² – Aconselha-se um diâmetro de ventilador de 132 cm a 137 cm.

Localização do ventilador:

- A distância máxima até ao solo é de 2,4 m. Se houver uma maior distância, o ar não chegará bem.
- A distância mínima desde o tecto até à parte superior do ventilador é de 30 cm.
- A distância mínima desde a extremidade exterior da pá até à parede é de 0,5 m.



MODULO
ELECTRO
www.modulelectro.ru

HAWAI

■ **81** Níquel satinado
Satin nickel
Nickel satiné
Nickel matt
Nichel satinado
Níquel acetinado

■ **F9** Cristal opal mate
Matt opal glass
Verre opalin mat
Matt opales Glas
Vetro ottico satinato
Vidro opalino mate





30-2854-81-F9

1 x R7s Max. 100W OSRAM included

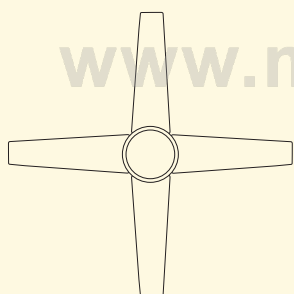

∅ 1322

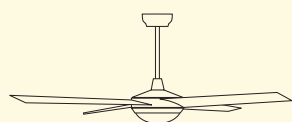

Min. 360 / Max. 515



Mando a distancia - incluido

MODULO
ELECTRO
www.modulelectro.ru





MOLOKAI

- 14** Blanco
 White
 Blanc
 Weiss
 Bianco
 Branco





30-2855-14-14

MODULO**ELECTRO**

Min. 335 / Max. 490

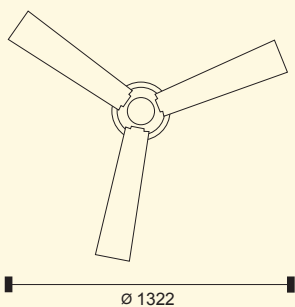
www.modulelectro.ru

Mando de distancia - incluido



MODULO
ELECTRO
www.modulelectro.ru

MOLOKAI

- 05 Negro
- Black
- Noir
- Schwartz
- Nero
- Preto





30-2855-05-05

MODULO

ELECTRO

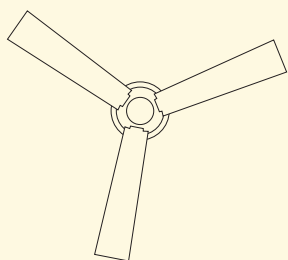

Min. 335 / Max. 490

www.modulelectro.ru

Ø 1322



Mando a distancia - incluido



MODUL
ELECTRO
www.modulelectro.ru

CALIFORNIA

N3 Gris textura
Grey texture
Gris avec texture
Grau rauh-matt
Grigio
Cinzeno textura

F9 Cristal opal mate
Matt opal glass
Verre opalin mat
Matt opales Glas
Vetro ottico satinato
Vidro opalino mate



**REMOTE
CONTROL
INCLUDED**





30-2858-N3-F9

1 x G9 Max. 60W OSRAM included



MODULO
ELECTRO

www.modulelectro.ru



Min. 355 / Max. 510

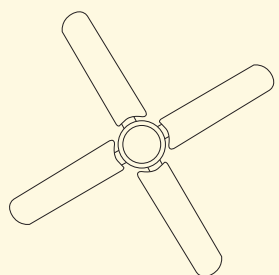

Ø 1330



Mando a distancia - incluido



FLORIDA

N3 Gris textura
Grey texture
Gris avec texture
Grau rauh-matt
Grigio
Cinzenito textura

F9 Cristal opal mate
Matt opal glass
Verre opalin mat
Matt opales Glas
Vetro ottico satinato
Vidro opalino mate

05 Negro
Black
Noir
Schwartz
Nero
Preto

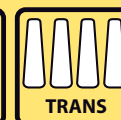

**30-2859-N3-F9**

1 x G9 Max. 60W OSRAM included

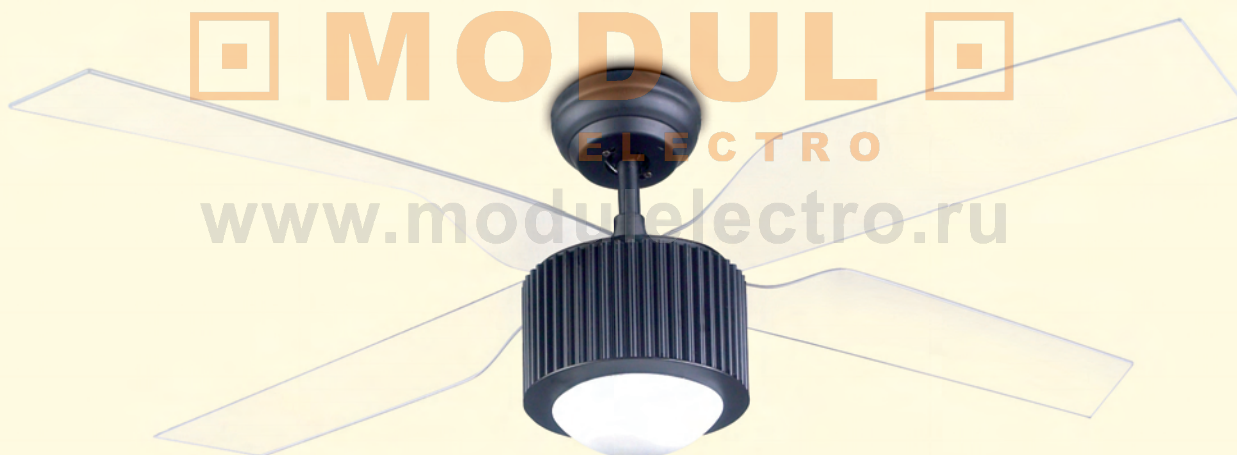
**30-2859-05-F9**

1 x G9 Max. 60W OSRAM included

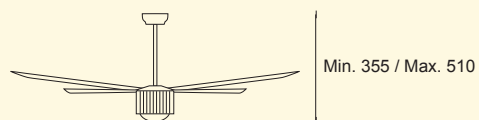
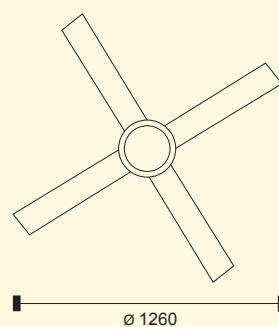
**Mando a distancia - incluido**

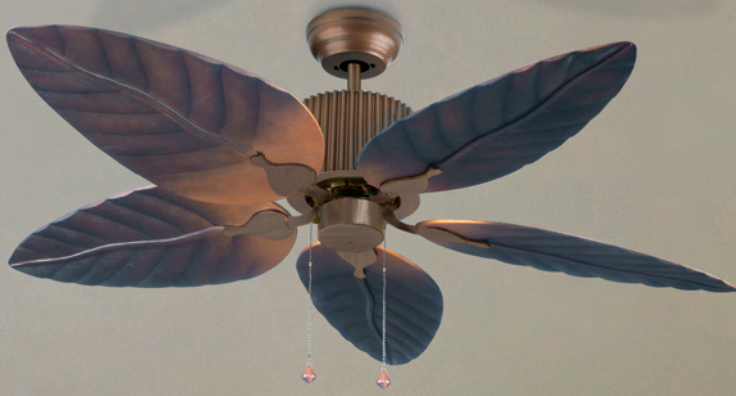

NAPALI

- J7** Marrón cobrizo
 Coper brown
 Marron cuivré
 Kupferrot Braun
 Marrone color rame
 Marrom acobreado





30-2856-J7-J7

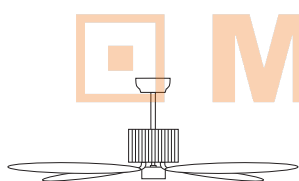

Min. 335 / Max. 490

MODULO
ELECTRO

www.modulelectro.ru

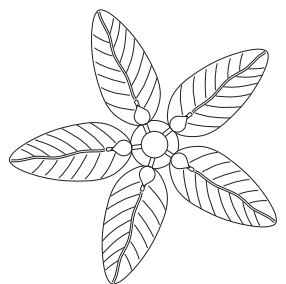

Ø 1260



71-2856-J7-F9

1 x R7s 100W OSRAM included



Kit de luces opcional
Optional lighting kit

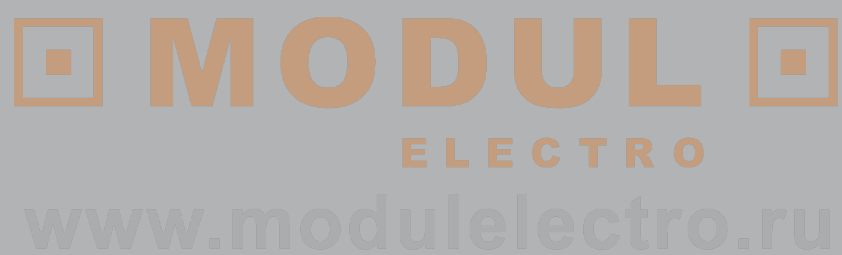

información general

general information

information generale

MODULE

ELECTRO

www.modulelectro.ru

allgemeine informationen

informazione generale

informação geral

MODULO
ELECTRO
www.modulelectro.ru

Acabados

CODIFICACIÓN / CODIFICATION / CODIFICATION / BESTELL-NUMMER / CODIFIC / CODIFICAÇÃO

	ACABADOS	FINISHING	FINITIONS	AUSFÜRUNGEN	RIFINITURE	ACABAMENTOS
00	Con vela	Candle shaped	Avec bougie	Mit Kerzenhalter	Con candela	Com vela
01	Oro con madera	Gold with wood	Or avec bois	Vergoldet mit holz	Oro e legno	Ouro i madeira
05	Negro	Black	Noir	Schwartz	Nero	Preto
08	Vidrio verde	Green glass	Verre vert	Grün glas	Vetro verde	Vidro verde
10	Pantalla de tela naranja incluida	Orange fabric shade included	Abat-jour orange en tissu compris	Orange stoff schirm inklusiv	Scherma arancione compresa	Cupula de tela laranja inclusa
14	Blanco	White	Blanc	Weiss	Bianco	Branco
15	Cristal ámbar	Amber Glass	Verre ambre	Bernstein	Cristallo Ambra	Vidro âmbar
20	Pantalla de tela incluida	Fabric shade included	Avec abat-jour en tissu	Mit stoffschirm	Schermo compresa	Âbat-jour incluido
21	Cromo	Chrome	Chrome	Chrom	Cromo	Cromo
22	Latón pulido	Polish brass	laiton poli	Messing poliert	Ottone pulito	Latão polido
26	Vidrio opal brillo	Bright opal glass	Verre opal brillant	Glänzendes opal glas	Vetro opal lucido	Vidro opal brilho
34	Pintado gris	Grey painted	Peinture grise	Grau lackiert	Grigio pintato	Pintado cinza
54	Aluminio anodizado	Anodized aluminium	Aluminium anodisé	Eloxiertes aluminium	Alluminio anodizzato	Aluminio anodizado
81	Níquel satinado	Satin nickel	Nickel satiné	Nickel matt	Nichel satinato	Níquel acetinado
92	Madera oscura	Dark wood	Bois foncé	Dunkles Holz	Legno oscuro	Madeira escura
93	Madera clara	Pale wood	Bois claire	Helles Holz	Legno chiaro	Madeira clara
AE	Vidrio Tiffany	Tiffany glass	Verre Tiffany	Tiffany Glas	Vetro Tiffany	Vidro Tiffany
AJ	Pantalla gris ópera	Opera grey shade	Abat-jour gris opéra	Grau Schirm	Paralume grigio	Âbat-jour gris opera
AL	Aluminio satinado	Satin Aluminium	Aluminium satiné	Aluminium matt	Alluminio satinato	Aluminio acetinado
AM	Níquel mate	Nickel matt	Nickel mat	Nickel matt	Nichel opaco	Níquel fosco
AS	Pantalla negro brillante/ blanco brillante/cromo	Shining black/shining white/chrome shade	Abat-jour noir brillant/ blanc brillant/chrome	Schirm schwarz/glänzend weiss/schirm chrom	Paralume nero brillante/ bianco brillante/cromo	Cupula preto brillante/branco brillante/cromo
AW	Alumitio	Aluminium	Aluminium	Aluminium	Alluminio	Aluminio
B8	Cristal satinado	Satin glass	Verre satiné	Satiniertes glas	Cristallo satinato	Cristal acetinado
BC	Pantalla serigrafiada no incluida	Serigraphic shade not included	Abat-jour serigraphié non compris	Serigraphie schirm nicht inklusiv	Paralume serigrafato no incluso	Cupula serigrafiada não inclusa
BL	Blanco	White	Blanc	Weiss	Bianco	Branco
CN	Cromo negro	Black chrome	Chrome noir	Chrom Schwartz	Cromo nero	Cromo preto
CR	Cromo	Chrome	Chrome	Chrom	Cromo	Cromo
D8	Pan de oro	Golden leaf	Feuille d'or	Gold folie	Foglia di oro	Pão de ouro
D9	Pan de plata	Silver leaf	Feuille argent	Silber folie	Foglia di argento	Pão de prata
E4	Patiné	Antique brass	Patiné	Alt messing	Patinato	Patinado
E7	Cristal decorado	Decorated glass	Verre décoré	Dekoglas	Cristallo Decorato	Vidro decorado
E9	Cristal satinado	Satin glass	Verre satiné	Satiniertes glas	Cristallo satinato	Cristal acetinado
ES	Espejo	Mirror	Miroir	Spiegel	Specchio	Espelho
F3	Pátina negra	Black patine	Patina noir	Schwarzer Patina	Patina nera	Patina preta
F9	Cristal opal mate	Matt opal glass	Verre opalin mat	Matt opales Glas	Vetro ottico satinato	Vidro opalino mate
GB	Gris/Blanco	Grey/White	Gris/Blanc	Brau/Weiss	Grigio/Blanco	Cinzeto/Branco
GN	Gris/Negro	Grey/Black	Gris/Noir	Brau/Schwartz	Grigio/Nero	Cinzeto/Preto
GR	Gris	Grey	Gris	Grau	Grigio	Cinzeto
J6	Pantalla de tela marrón incluida	Brown fabric shade included	Abat-jour marron en tissu compris	Stoffschirm braun inklusiv	Schermo marrone compresa	Cupula castanho inclusa
J7	Marrón cobrizo	Coper brown	Marron cuivré	Kupferrot Braun	Marrone color rame	Marrom acobreado
N3	Gris textura	Grey texture	Gris à effet de texture	Grau rauh-matt	Grigio	Cinzento textura
NA	Madera pintada en color naranja	Wood painted in orange	Bois peint en couleur orange	Orangerfarbig angestrichenes Holz	Tavola verniciata in color arancione	Madeira pintada em cor laranja
NE	Negro	Black	Noir	Schwartz	Nero	Preto
NM	Níquel mate	Nickel matt	Nickel mat	Nickel matt	Nichel opaco	Níquel fosco
NS	Níquel satinado	Satin nickel	Nickel satiné	Nickel matt	Nichel satinato	Níquel acetinado
PA	Patiné	Antique brass	Patiné	Antique brass	Patinato	Patinado
PP	Patiné pintado	Painted antique brass	Brossé peint	Lackiertes Messing	Ottone verniciato	Patiné pintado
Q3	Vidrio Fusing	Fusing glass	Verre fusing	Fusing Glas	Cristallo Fusing	Cristal Fusing
R0	Rojo	Red	Rouge	Rot	Rosso	Vermelho
S4	Ámbar dorado	Golden amber	Ambré doré	Vergoldet Bernstein	Ambra dorato	Âmbar dourado
T1	Níquel mate, polypiel marrón, cristal	Matt nickel, brown polypiel, glass	Nickel mate, polypiel marron, verre	Nickel matt, brauner polypiel, glas	Nichel opaco, pelle marrone, vetro	Níquel fosco, couro sintético marron, vidro
VE	Madera pintada en color verde	Wood painted in green	Bois peint en couleur vert	Grün angestrichenes Holz	Tavola verniciata in color verde	Madeira pintada em cor verde
Y2	Marrón envejecido	Old brown	Marron vielli	Dunkel braun	Marrone vecchio	Castanho envelhecido
Z8	Cristal mosaico	Mosaic glass	Verre mosaïque	Mosaikglas	Mosaico di vetro	Mosaico em vidro

Especificaciones técnicas

SIMBOLOGÍA / SIMBOLS / SYMBOLES / SYMBOLE / SIMBOLOGIA / SIMBOLOGIA

-  Classe I • Class I • Classe I • Klasse I • Klasse I • Classe I
-  Classe II • Class II • Classe II • Klasse II • Klasse II • Classe II
-  Classe III • Class III • Classe III • Klasse III • Klasse III • Classe III
-  Instalable sobre una superficie normalmente inflamable • Suitable for installation on normally inflammable surfaces • Installation sur une surface normalement inflammable • Darf unter normalen Bedingungen auf leicht entzündbaren Oberflächen angebracht werden • Tutte le lampade contraddistinte con questo simbolo sono costruite in modo tale da poter essere installate su di una superficie normalmente infiammabile • Instalável sobre uma superfície normalmente inflamável
-  No pueden ser instaladas en superficies inflamables • Unsuitable for installation on normally inflammable surfaces • Ne pas installer sur des surfaces normalement inflammables • Darf unter normalen Bedingungen nicht auf leicht entzündbaren Oberflächen angebracht werden • Tutte le lampade contraddistinte con questo simbolo non possono essere installate su di una superficie normalmente infiammabile • Não podem ser instaladas em superfícies inflamáveis
-  Fabricado según normas de seguridad y electromagnetismo de Europa • Manufactured according to the set safety and electromagnetism standards of Europe • Fabriqué en conformité avec les normes de sécurité et d'électromagnétique de l'Europe • Europa geltenden Sicherheitsbestimmungen • Tutti i prodotti fabbricati rispettano le norme di sicurezza e di elettromagnetismo europee • Fabricado de acordo com as normas de segurança e electromagnetismo da Europa
-  Resistente al hilo incandescente a 850°C • Resistance to incandescent wire at 850°C • Tenue au feu 850°C • Glühdrahtbeständig auf 850°C • Resistente a filo incandescente 850°C • Resistente ao fio incandescente a 850°C
-  Lámpara protegida contra la penetración de objetos sólidos mayores de 12mm y contra el agua en forma de lluvia hasta 60° de inclinación • Lamp protected against ingress of solid objects greater than 12mm and against spraying water • Luminaire protégé contre la pénétration d'objets solides d'une taille supérieure à 12mm, et contre l'eau de pluie inclinée à plus de 60° • Lampe geschützt gegen das Eindringen von festen Gegenständen, die größer als 12 mm sind und gegen Regenwasser mit einer Inklination bis zu 60° • Lampada protetta contro la penetrazione di oggetti solidi più grandi di 12 mm e contro l'acqua a forma di pioggia fino a 60° di inclinazione • Luminária protegida contra a penetração de objetos sólidos >12mm e contra a penetração de água em forma de chuva até uma inclinação de 60°.
-  Lámpara protegida contra la penetración de objetos sólidos mayores de 1mm y contra proyecciones de agua en todas direcciones • Lamp protected against ingress of solid objects greater than 1mm and against splashing water • Luminaire protégé contre la pénétration d'objets solides d'une taille supérieure à 1mm, et contre les projections d'eau dans toutes les directions • Lampe geschützt gegen das Eindringen von festen Gegenständen, die größer als 1 mm und gegen Wasserstrahlen aus allen Richtungen • Lampada protetta contro la penetrazione di oggetti solidi più grandi di 1 mm e contro le proiezioni d'acqua in tutte le direzioni • Luminária protegida contra a penetração de objetos sólidos >1mm e contra projeções de água em todas as direções.
-  Lámpara totalmente protegida contra la penetración de polvo y contra chorros de agua en todas direcciones • Lamp dust-tight and protected against water jets • Luminaire totalement protégé contre les poussières et les jets d'eau dans toutes les directions • Lampe vollkommen geschützt gegen das Eindringen von Staub und gegen Wassergüsse aus allen Richtungen • Lampada completamente protetta contro la penetrazione di polvere e contro getti d'acqua in tutte le direzioni • Luminária protegida contra a penetração de pó e contra jactos de água em todas as direções.
-  Distancia mínima entre el foco de la luminaria y el objeto iluminado • Minimum distance to be left between the focus of the lighting fixture and the lightened object • La distance minimum pour être gauche entre le foyer de l'accessoire d'éclairage et l'objet allumé • Mindestabstand zwischen dem Scheinwerfer der Leuchte und dem beleuchteten Gegenstand • Distanza minima tra la lampada e l'oggetto illuminato • Distância mínima entre o foco da luminaria e o objeto iluminado.
-  Dirección del halo de luz • Halo light direction • Direction du faisceau lumineux • Lichtstrom in Richtung • Direzione dall'halo • Direção do feixe de luz.
-  Uds. de embalaje • Items per box • Unité d'emballage • Verpackungseinheiten • Unità d'imballaggio • Uds. de embalagem
-  Modelos registrados • Registered models • Modèles enregistrés • Eingetragene Modelle • Modelli registrati • Modelos registados
-  Energy saving
-  Transformador electrónico incluido • Electronic recessed transformer • Transformateur électronique inclus • Elektronisches Vorschalgerät inkl. • Trasformatore elettronico incluso • Transformador eletrônico incluso
-  Palas reversibles de 2 colores • 2 colors reversible blades • Lames réversibles du 2 couleurs • 2 Farben umkehrbare Blätter • Lame reversibili di 2 colori • Láminas revogáveis do 2 cores
-  Revoluciones por minuto • Revolutions per minute • Revolution per minute • Umdrehungen pro Minute • Rivoluzioni al minuto • Rotações por minuto
-  3 Velocidades • 3 Speeds • 3 Vitesses • 3 Geschwindigkeiten • 3 velocità • 3 velocidades
-  Silencioso • Quiet • Silencieux • Silent • Silenzioso • Silencioso
-  Control remoto incluido • Remote control included • Télécommande inclus • Fernbedienung inklusiv • Comando a distanza incluso • Controle remoto incluído
-  Palas de metacrilato transparente • Transparent methacrylate blades • Pale en méthacrylate transparent • Durchsichtig methacrylate Blätter • Pale metacrilato trasparente • Pás metacrilato transparente
-  El giro a la izquierda crea un efecto refrigerante, perfecto para el verano • A rotation to the left causes a cooling effect, perfect for the summer • La rotation vers la gauche crée un effet rafraîchissant, parfait pour l'été • Die Umdrehung nach links verursacht ein Kühleffekt, ideal für den Sommer • Girare a sinistra ci da un effetto refrigerante, ottimo per l'estate • A rotação à esquerda cria um efeito refrescante, que é ideal para o Verão
-  El giro a la derecha envía el aire más caliente hacia abajo, ideal para el invierno • A rotation to the right sends warm air down, ideal for the winter • La rotation vers la droite envoie l'air le plus chaud vers le bas, idéal pour l'hiver • Die Umdrehung nach rechts sendet die Warmluft abwärts, ideal für den Winter • Girare a destra guida l'aria più calda in basso, ideale per l'inverno • A rotação à direita envia o ar mais quente para baixo, que é ideal para o Inverno

CODIFICACIÓN / CODIFICATION / CODIFICATION / BESTELL-NUMMER / CODIFICA / CODIFICAÇÃO

Para realizar el pedido de un artículo es necesario colocar después de la referencia del modelo los dos números que identifican el acabado seguidos de los dos números que corresponden al código suplementario.

When placing an order for an item, please quote after the model reference number, the two numbers indicating the required finish and the two supplementary code numbers.

Pour passer commande d'un article il faut indiquer après la référence du modèle, les deux numéros identifiant la finition, suivis de deux numéros correspondants au code supplémentaire.

Bei der Bestellung eines Artikels müssen hinter der Modell-Nr. die zwei Ziffern für die Ausführung und die zwei Ziffern des Zusatzcodes angegeben werden.

Per ordinare un articolo, si deve inserire, dopo la referenza, i 2 numeri per la finitura ed anche i 2 numeri per il codice supplementario.

Para efectuar a encomenda de um artigo é necessário colocar depois da referência do modelo os dois números que identificam o acabamento, seguidos dos dois números que correspondem ao código suplementar.

CONDICIONES GENERALES

INFORMACIÓN GENERAL:

Las descripciones y medidas de los aparatos del presente catálogo son orientativas, pudiendo por tanto ser modificadas, a fin de mejorar las características técnicas o de diseño / La empresa se reserva el derecho de anular o modificar cualquiera modelo sin previo aviso / Todos los modelos presentados cumplen las normas exigidas por la C.E. para aparatos de iluminación de uso doméstico y sus características vienen determinadas por las clases I y II / Los acabados y las especificaciones técnicas corresponden a los productos que se suministran en Europa, pudiendo estos variar en otros mercados / Para una buena conservación de las lámparas, no usar bombillas de potencia superior a las recomendadas y limpiar simplemente con un paño seco. No usar limpia metales, ya que dañan los barnices protectores que garantizan la duración del acabado.

GENERAL INFORMATION:

The descriptions and dimensions of the items in this catalogue are indicative and may be modified for the purpose of technical or design improvements / We reserve the right to cancel or change all models without prior notice / All items meet the E.C. Class I and Class II safety regulations for home lighting appliances / The finishes and technical specifications listed here are for the European market and may vary elsewhere / Do not use stronger bulbs that recommended, and allways clean lamps with a soft dry cloth alone since metal polish will damage the protective finish.

INFORMATION GENERALE:

Les descriptions et mesures des appareils de ce catalogue sont données à titre d'orientation, pouvant être modifiées dans le but d'améliorer les caractéristique techniques ou de design / L'usine se réserve le droit d'annuler ou modifier l'un ou l'autre de ses modèles sans avis préalable / Tous les modèles présentés sont conformes aux normes exigées par la C.E. pour les appareils d'éclairage domestique et leur caractéristiques sont déterminées par le classe I et II / Les finitions et spécifications techniques correspondent à la demande du marché européen. Elles peuvent être modifiées par d'autres pays / Ne pas utiliser d'ampoules d'une puissance supérieure à celle recommandée. Pour un bon entretien, utiliser simplement un chiffon sec. N'utilisez aucun produit pur métaux, ils abiment le vernis protecteur.

www.modulelectro.ru

ALLGEMEINE INFORMATIONEN:

Die Beschreibung und Maße der in diesem Katalog aufgeführten Modelle dienen zur Orientierung und können zur Verbesserung der technischen Eigenschaften oder des Designs geändert werden / Der Hersteller behält sich das Recht vor, Modelle zu ändern oder aus dem Programm wegzunehmen / Die geeigneten Modelle erfüllen alle die innerhalb der EU geforderten Normen und Richtlinien für Leuchten für allgemeine Beleuchtungszwecke der Schutzklassen I und II / Die Ausführungen und technischen Daten gelten für den europäischen Markt und können in anderen Ländern abweichen / Für eine gute Erhaltung der Leuchten bitten wir immer den empfohlene Leuchtmittel zu benutzen (keine höhere Leistung). Zur Reinigung benutzen Sie einfach ein trockenes Tuch, da Metallputzmitteln die Schutzlackierung angreifen können.

INFORMAZIONE GENERALE:

Le descrizione e le dimensioni degli articoli del presente catalogo vengono fornite a mero titolo orientativo e possono pertanto essere modificate al fine di migliorarne le caratteristiche tecniche o di design. / La Casa si riserva il diritto di cessare la produzione o di modificare qualsiasi modello senza preavviso. / Tutti i modelli presentati sono conformi alle normative C.E. per gli articoli da illuminazione per uso domestico di classe I e II. / Le rifiniture e le specifiche tecniche corrispondono ai prodotti venduti in Europa; tali dati possono pertanto variare su altri mercati. / Per una buona conservazione delle lampade, non utilizzare lampadine di potenza superiore a quella consigliata e pulirle semplicemente con un panno asciutto. Non utilizzare prodotti per la pulizia del metallo che potrebbero rovinare le vernici di protezione che garantiscono la vita della rifinitura.

INFORMAÇÃO GERAL:

As descrições e medidas dos aparelhos do presente catálogo são orientativas, podendo, por isso, ser modificadas, para se melhorarem as características técnicas ou de concepção. / A empresa reserva-se o direito de anular ou modificar qualquer modelo sem aviso prévio. / Todos os modelos apresentados cumprem as normas impostas pela C.E. para aparelhos de iluminação de uso doméstico e as suas características estão determinadas pelas classes I e II. / Os acabamentos e especificações técnicas correspondem aos produtos fornecidos na Europa, podendo estes ser diferentes em outros mercados. / Para uma boa conservação das lâmpadas, não use lâmpadas de potência superior às recomendadas e limpe apenas com um pano seco. Não use limpa metais, dado que danificam os vernizes protectores que garantem a duração do acabamento.

Índice • Index • Index • Indexzahl • Indice • Índice

REF.	PAG	REF.	PAG	REF.	PAG	REF.	PAG
00-2380-21-20.....	078	05-2569-Y2-14.....	052	10-2568-Y2-14.....	052	15-2302-S4-15.....	202
00-2535-21-Q3.....	109	05-2593-05-Q3.....	111	10-2569-Y2-14.....	052	15-2303-S4-15.....	201
00-2541-21-Q3.....	113	05-2597-21-92.....	056	10-2690-21-20.....	076	15-2374-Y2-AE.....	047
00-2568-Y2-14.....	051	05-2598-21-92.....	056	10-2713-81-AJ.....	087	15-2375-Y2-AE.....	045
00-2593-05-Q3.....	111	05-2690-21-20.....	075	10-2775-21-05.....	011	15-2376-Y2-AE.....	045
00-2597-21-92.....	057	05-2775-21-05.....	011	10-2775-21-14.....	011	15-2377-Y2-AE.....	045
00-2690-21-20.....	075	05-2775-21-14.....	011	10-2785-21-AS.....	015	15-2378-Y2-AE.....	045
00-2691-21-05.....	039	05-2785-21-AS.....	016	10-2786-21-J6.....	036	15-2568-Y2-14.....	053
00-2691-21-14.....	039	05-2786-21-J6.....	036	10-2792-D8-92.....	097	15-2569-Y2-14.....	053
00-2692-21-05.....	039	05-2795-21-92.....	091	10-2792-D9-14.....	097	15-2570-Y2-14.....	053
00-2692-21-14.....	039	05-2797-D9-14.....	095	10-2793-D8-92.....	097	15-2588-Y2-E7.....	195
00-2713-81-AJ.....	087	05-2798-Y2-20.....	107	10-2793-D9-14.....	097	15-2589-Y2-E7.....	195
00-2775-21-05.....	012	05-2814-81-05.....	135	10-2795-21-92.....	091	15-2593-05-Q3.....	111
00-2775-21-14.....	012	05-2814-81-14.....	135	10-2797-D9-14.....	095	15-2597-21-92.....	055
00-2776-21-05.....	013	05-2814-81-20.....	135	10-2798-Y2-20.....	107	15-2598-21-92.....	055
00-2776-21-14.....	013	05-2815-21-21.....	131	10-2817-81-14.....	029	150-GR.....	059
00-2785-21-AS.....	016	05-2815-81-81.....	131	10-2818-21-10.....	023	152-GR.....	059
00-2817-81-14.....	030	05-2816-21-21.....	133	10-2818-21-14.....	023	154-AM.....	061
00-2843-21-21.....	025	05-2816-81-81.....	133	10-2819-05-05.....	033	155-AM.....	061
00-2844-21-21.....	025	05-2817-81-14.....	029	10-2819-14-14.....	033	170-NS.....	065
00-2846-05-05.....	041	05-2818-21-10.....	022	10-2819-92-92.....	033	170-PP.....	065
00-2846-14-14.....	041	05-2818-21-10.....	022	10-2825-21-14.....	093	171-NS.....	065
00-7022-22-26.....	103	05-2822-54-54.....	145	10-2827-81-14.....	019	171-PP.....	065
05-0542-Y2-20.....	119	05-2823-54-54.....	145	10-2828-N3-14.....	027	172-NS.....	065
05-0543-Y2-20.....	119	05-2824-81-20.....	073	10-2842-81-81.....	137	172-PP.....	065
05-0544-Y2-20.....	118	05-2825-21-14.....	093	117-NS.....	181	174-NS.....	067
05-0575-Y2-E7.....	124	05-2826-21-14.....	093	118-PP.....	181	174-PP.....	067
05-0576-Y2-E7.....	124	05-2827-81-14.....	019	119-PP.....	181	176-NS.....	067
05-0577-Y2-E7.....	123	05-2828-N3-14.....	027	127-NS.....	083	176-PP.....	067
05-0578-Y2-E7.....	123	05-2829-81-E9.....	147	127-PA.....	083	195-NM.....	224
05-0579-Y2-E7.....	123	05-2830-34-34.....	141	127-Y2.....	083	196-NM.....	225
05-0581-S4-Z8.....	127	05-2831-34-34.....	141	15-0319-S4-E7.....	197	197-NM.....	225
05-0584-S4-Z8.....	127	05-2834-54-54.....	142	15-0319-Y2-E7.....	197	198-NM.....	225
05-1515-21-82.....	100	05-2835-54-54.....	142	15-0320-S4-E7.....	198	20-0542-Y2-20.....	117
05-1515-22-82.....	100	05-2836-54-54.....	142	15-0320-Y2-E7.....	198	20-0543-Y2-20.....	117
05-1516-21-82.....	100	05-2837-21-21.....	139	15-0321-S4-E7.....	198	20-0544-Y2-20.....	117
05-1516-22-82.....	100	05-2838-21-21.....	139	15-0321-Y2-E7.....	198	20-0575-Y2-E7.....	121
05-2175-E4-E4.....	191	05-2839-21-21.....	139	15-0322-S4-E7.....	197	20-0576-Y2-E7.....	121
05-2304-S4-15.....	202	05-2840-21-14.....	143	15-0322-Y2-E7.....	197	20-1515-21-82.....	099
05-2317-S4-E7.....	129	05-2845-21-21.....	139	15-0549-Y2-E7.....	193	20-1515-22-82.....	099
05-2318-S4-E7.....	129	10-0542-Y2-20.....	118	15-0550-Y2-E7.....	193	20-2266-E4-08.....	103
05-2374-Y2-AE.....	046	10-0543-Y2-20.....	119	15-0551-Y2-E7.....	193	20-2374-Y2-AE.....	047
05-2375-Y2-AE.....	046	10-0581-S4-Z8.....	127	15-0552-S4-E7.....	125	20-2375-Y2-AE.....	049
05-2376-Y2-AE.....	046	10-1515-21-82.....	101	15-0552-Y2-E7.....	125	20-2376-Y2-AE.....	049
05-2380-21-20.....	078	10-1515-22-82.....	101	15-0553-S4-E7.....	125	20-2380-21-20.....	079
05-2381-21-20.....	078	10-1516-21-82.....	101	15-0553-Y2-E7.....	125	20-2381-21-20.....	080
05-2541-81-Q3.....	113	10-1516-22-82.....	101	15-0554-S4-E7.....	125	20-2382-21-20.....	079
05-2542-21-Q3.....	113	10-1518-21-82.....	101	15-0554-Y2-E7.....	125	20-2383-21-20.....	080
05-2543-81-Q3.....	114	10-1518-22-82.....	101	15-0575-Y2-E7.....	122	20-2568-Y2-14.....	051
05-2544-21-Q3.....	114	10-2374-Y2-AE.....	045	15-0576-Y2-E7.....	122	20-2569-Y2-14.....	051
05-2550-21-Q3.....	115	10-2380-21-20.....	081	15-0582-S4-Z8.....	127	20-2597-21-92.....	057
05-2554-21-Q3.....	115	10-2381-21-20.....	081	15-0583-S4-Z8.....	127	20-2690-21-20.....	075
05-2565-81-82.....	069	10-2549-21-Q3.....	110	15-0584-S4-Z8.....	127	20-2691-21-05.....	039
05-2567-T1-20.....	105	10-2564-81-82.....	069	15-2300-S4-15.....	203	20-2691-21-14.....	039
05-2568-Y2-14.....	053	10-2567-T1-20.....	105	15-2301-S4-15.....	203	20-2786-21-J6.....	035

Índice • Index • Index • Indexzahl • Indice • Índice

REF.	PAG	REF.	PAG	REF.	PAG	REF.	PAG
20-2787-21-J6.....	037	30-2855-05-05.....	257	429-CR.....	084	498-BL.....	041
200-NM.....	224	30-2856-J7-J7.....	263	429-NS.....	084	498-NE.....	041
201-NM.....	223	30-2858-N3-F9.....	259	429-PA.....	084	500-CR.....	215
203-NM.....	223	30-2859-N3-F9.....	261	431-GR.....	165	501-CR.....	216
237-NM.....	063	30-2859-05-F9.....	261	431-Y2.....	165	502-CR.....	217
239-NM.....	063	303-NS.....	060	432-GR.....	165	503-CR.....	215
240-NM.....	063	310-NS.....	058	432-Y2.....	165	505-NS.....	171
242-NM.....	224	314-NS.....	071	433-GR.....	165	505-Y2.....	171
247-NS.....	085	315-NS.....	071	433-Y2.....	165	506-CR.....	171
248-NS.....	085	316-NS.....	071	434-AL.....	183	506-Y2.....	171
25-0542-Y2-20.....	119	318-CR.....	233	435-AL.....	183	507-Y2.....	199
25-0543-Y2-20.....	118	319-CR.....	233	436-AL.....	183	508-Y2.....	199
25-1515-21-82.....	099	320-BL.....	229	440-NS.....	163	509-Y2.....	199
25-1515-22-82.....	099	320-CR.....	229	441-GR.....	161	510-CR.....	159
25-2380-21-20.....	081	320-NS.....	229	441-Y2.....	161	511-NE.....	158
25-2381-21-20.....	081	323-CR.....	237	442-NS.....	161	511-RO.....	158
25-2564-81-82.....	069	324-CR.....	237	443-AL.....	151	514-GR.....	177
25-2567-T1-20.....	105	325-CR.....	231	444-BL.....	163	514-Y2.....	177
25-2690-21-20.....	076	326-CR.....	231	445-BL.....	163	515-CR.....	243
25-2713-81-AJ.....	087	327-CR.....	231	446-NS.....	137	516-CR.....	243
25-2775-21-05.....	011	330-GR.....	149	447-CR.....	241	517-CR.....	243
25-2775-21-14.....	011	331-GR.....	149	448-CR.....	241	518-CN.....	227
25-2785-21-AS.....	015	332-GR.....	073	449-CR.....	241	519-CN.....	227
25-2795-21-92.....	091	333-NS.....	073	450-AL.....	235	520-CN.....	227
25-2797-D9-14.....	095	335-NS.....	073	451-AL.....	235	71-2821-05-05.....	145
25-2798-Y2-20.....	107	337-AL.....	017	452-AL.....	235	71-2856-J7-F9.....	263
25-2817-81-14.....	030	352-CR.....	220	455-AL.....	152	PAN-019-20.....	101
25-2818-21-10.....	021	353-CR.....	220	456-AL.....	152	PAN-027-20.....	101
25-2818-21-14.....	021	354-CR.....	219	457-CR.....	241	PAN-028-20.....	099
25-2819-05-05.....	033	355-CR.....	219	458-NS.....	176	PAN-029-20.....	099
25-2819-14-14.....	033	357-CR.....	221	465-NM.....	189	PAN-030-20.....	100
25-2819-92-92.....	033	362-CR.....	185	467-ES.....	247	PAN-031-20.....	101
25-2825-21-14.....	093	363-CR.....	185	468-ES.....	247	PAN-032-20.....	100
25-2827-81-14.....	019	366-NS.....	176	469-ES.....	247	PAN-090-14.....	069
25-2828-N3-14.....	027	380-CR.....	210	476-CR.....	245	PAN-103-14.....	065 - 067
25-2860-Y2-05.....	089	381-CR.....	211	478-CR.....	187	PAN-103-20.....	065 - 067
25-2860-Y2-14.....	089	382-CR.....	211	479-CR.....	187	PAN-104-14.....	067 - 069
260-NM.....	031	385-CR.....	210	480-CR.....	188	PAN-104-20.....	067
269-NS.....	173	390-CR.....	213	481-CR.....	188	PAN-133-BC.....	025
270-NS.....	175	391-CR.....	212	482-CR.....	187	PAN-135-BC.....	025
271-NS.....	175	392-CR.....	212	483-CR.....	188	PAN-138-BC.....	025
272-NS.....	175	394-CR.....	213	484-CR.....	188	PAN-139-BC.....	025
274-NS.....	173	407-CR.....	234	485-BL.....	239	PAN-140-BC.....	025
275-GN.....	043	408-NS.....	234	486-BL.....	239	PAN-141-BC.....	025
276-GN.....	043	410-CR.....	207	487-BL.....	239	PAN-144-05.....	131 - 133
278-GB.....	043	411-CR.....	207	488-AL.....	169	PAN-144-14.....	131 - 133
279-NS.....	179	412-CR.....	206	489-AL.....	169	PAN-144-20.....	131 - 133
280-NS.....	179	413-CR.....	206	491-AL.....	151	PAN-145-05.....	131 - 133
283-CR.....	157	414-CR.....	205	492-CR.....	167	PAN-145-14.....	131 - 133
284-CR.....	157	415-CR.....	205	493-CR.....	167	PAN-145-20.....	131 - 133
300-BL.....	060	416-CR.....	208	494-AW.....	156		
301-BL.....	060	417-CR.....	208	495-AW.....	156		
302-BL.....	060	425-ES.....	245	496-AW.....	156		
30-2854-81-F9.....	253	426-ES.....	245	497-BL.....	041		
30-2855-14-14.....	255	427-ES.....	245	497-NE.....	041		

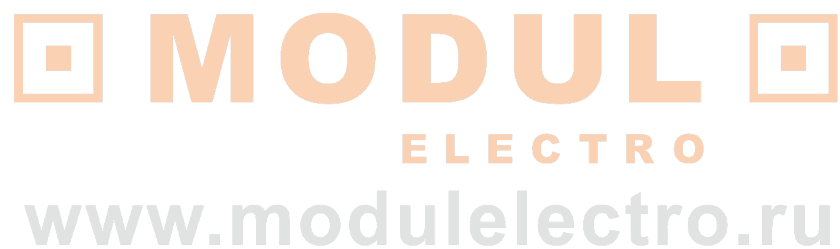

Todos los derechos reservados. Ninguna parte de este libro puede ser reproducida en ningún formato de papel o electrónico, sin el consentimiento previo del editor o de los propietarios de los derechos.

All rights reserved. No part of this publication may be reproduced or transmitted in any form or by any means, electronic storage and retrieval system, without permission in writing from the copyright owner (s).

Tous droits réservés. Aucune partie de ce livre ne pourra être reproduite en format papier ou électronique sans l'autorisation préalable de l'éditeur ou du propriétaire des droits.

Sämtliche Rechte vorbehalten. Kein Teil dieses Buches darf in keinem Papier- oder elektronischem Format ohne ausdrückliche Zustimmung des Herausgebers oder der Inhaber der Urheberrechte wiedergegeben oder vervielfältigt werden.

Tutti i diritti riservati. Nessuna parte di questo libro può essere riprodotta in nessun formato cartaceo o elettronico, senza la previa autorizzazione dell'editore o dei proprietari dei diritti.

Todos os direitos reservados. Nenhuma parte deste livro pode ser reproduzida em qualquer formato de papel ou electrónico, sem o consentimento prévio do editor ou dos proprietários dos direitos.



LEDS-C4, S.A.

Afuera s/n, - 25750 - TORA (Lleida) SPAIN

www.leds-c4.com

España

Tel.: 973 46 81 01

Fax.: 973 46 81 29

info@leds-c4.com

Europe

Tel.: + 34 973 46 81 02

Fax.: + 34 973 46 81 06

europe@leds-c4.com

France - Portugal

Tel.: + 34 973 46 81 30

Fax.: + 34 973 46 81 29

france@leds-c4.com

portugal@leds-c4.com

Asia - Pacific and Africa

Tel.: + 34 973 46 81 16

Fax.: + 34 973 46 81 06

export@leds-c4.com

USA - Canada - Ireland

Tel.: +34 973 46 81 09

Fax: +34 973 46 81 06

lighting@leds-c4.com

América Latina

Tel.: + 34 973 46 81 15

Fax.: + 34 973 46 81 06

sudamerica@leds-c4.com

Middle East Countries

Tel.: + 34 973 46 81 08

Fax.: + 34 973 46 81 06

dep-export@leds-c4.com



www.modulelectro.ru