

LA CREU

NEWS 2010

NEWS 2010

A photograph of a modern dining table with a black lamp and two lit candles. The lamp has a black shade and a metal frame. The table is dark and reflective. Two lit candles in glass holders are on the table. The background is a blurred interior.

MODUL
ELECTRO
www.modulelectro.ru

 LED S-C4

La Creu
www.modulelectro.ru

Gladis

05

Negro
Black
Noir
Schwarz
Nero
Preto



ST COT

MODUL
ELECTRO
www.modulelectro.ru

05-4342-05-05

1 x PL Elec. E-27 Max. 23W

1 x E-27 Max. 60W

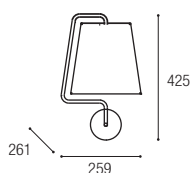



MODUL
ELECTRO
www.modulelectro.ru

00-4342-05-05

3 x PL Elec. E-27 Max.16W 

3 x E-27 Max. 60W 

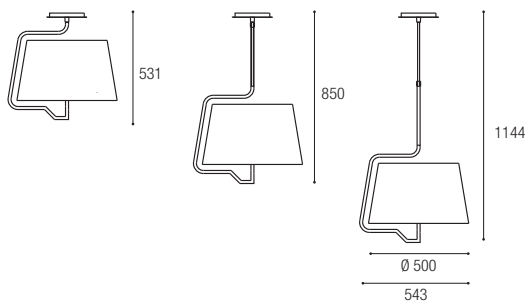



25-4342-05-05

1 x PL Elec. E-27 Max. 23W 

1 x E-27 Max. 100W 

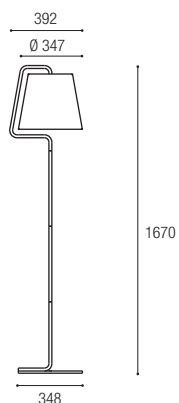



10-4342-05-05

1 x PL Elec. E-27 Max.23W 

1 x E-27 Max. 60W 

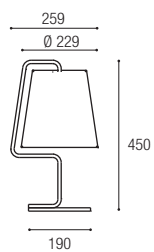

Zoe

05 Negro
Black
Noir
Schwarz
Nero
Preto

F CE ®

ST AL



90-4350-05-05
2 aros de colores incluidos
2 color rings included
2 anneaux de couleur compris
2 austauschbare Farbringe inklusive
2 anelli di colore inclusi
2 aros de cores incluidos



90-4350-05-05

1 x GU-5.3 Max. 50W 

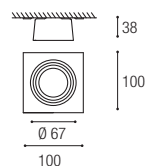

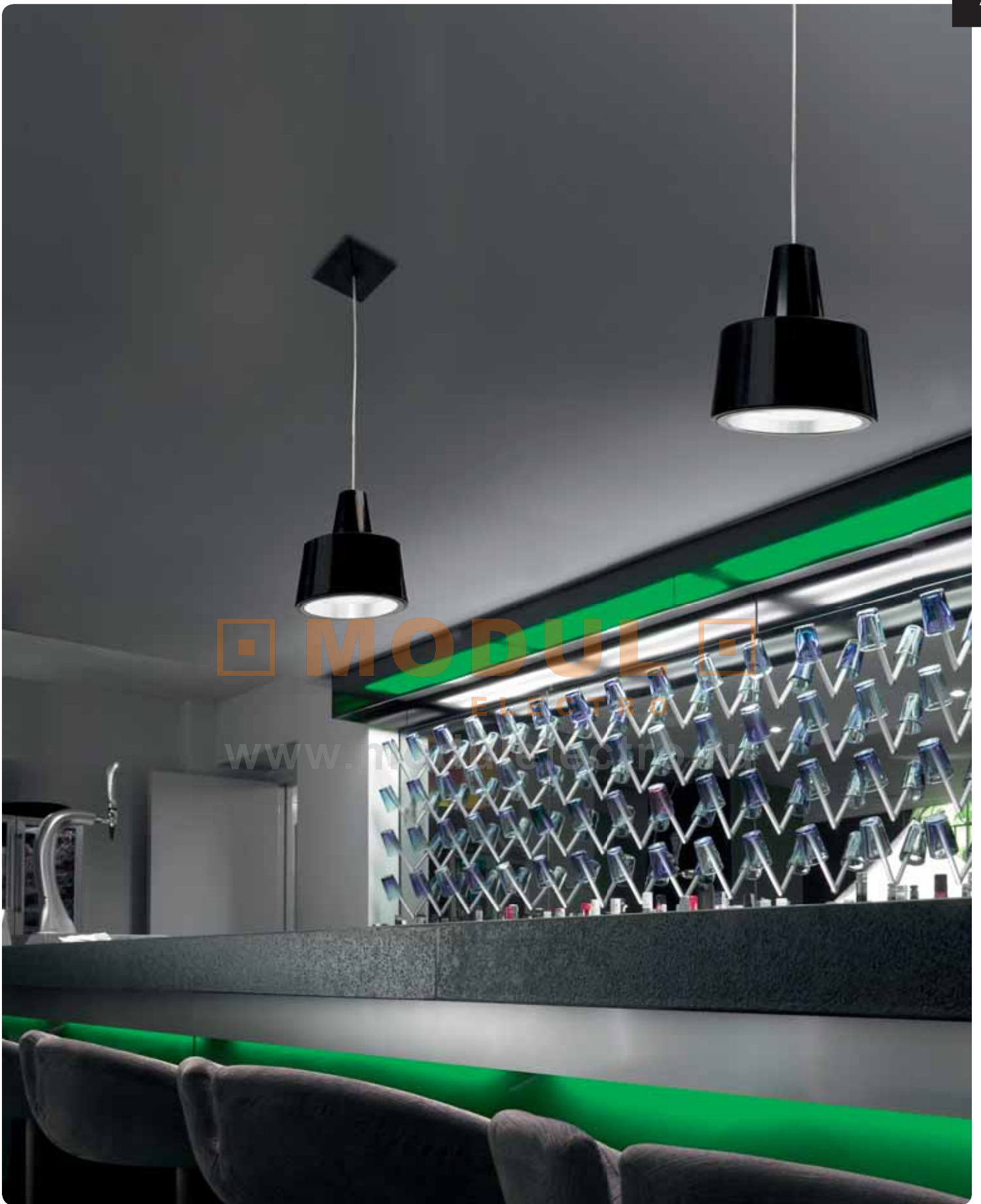

MODUL
www.modul.it

00-4350-05-05



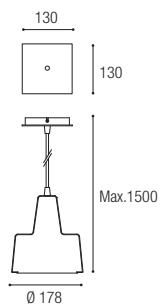







1 x E-27 PAR 38 Max. 60W 



Materiales • Materials

	ALUMINIO ALUMINIUM ALUMINIUM ALUMINIUM ALLUMINIUM ALUMINIO		ALGODÓN COTTON COTON BAUMWOLLE COTONE ALGODAO		ACERO STEEL ACIER STAHL ACCIAIO AÇO
--	---	---	--	---	--

Simbología • Symbols

 <p>Clase I • Class I • Classe I • Classe I • Classe I • Classe I</p>	 <p>Modelos registrados • Registered models • Modèles enregistrés • Eingetragene Modelle • Modelli registrati • Modelos registados</p>
 <p>Clase II • Class II • Classe II • Classe II • Classe II • Classe II</p>	 <p>Fabricado según normas de seguridad y electromagnetismo de Europa • Manufactured according to the set safety and electromagnetism standards of Europe • Fabriqués en conformité avec les normes de sécurité et d'électromagnétique de l'Europe • Europa geltenden Sicherheitsbestimmungen • Tutti i prodotti fabbricati rispettano le norme di sicurezza e di elettromagnetismo europee • Fabricado de acordo com as normas de segurança e electromagnetismo da Europa</p>
 <p>Clase III • Class III • Classe III • Classe III • Classe III • Classe III</p>	 <p>Uds. de embalaje • Items per box • Unité d'emballage • Verpackungseinheiten • Unità per scatola • Uds. por embalagem</p>
 <p>Instalable sobre una superficie normalmente inflamable • Suitable for installation on normally inflammable surfaces • Installation sur une surface normalement inflammable • Darf unter normalen Bedingungen auf leicht entzündbaren Oberflächen angebracht werden • Tutte le lampade contraddistinte con questo simbolo sono costruite in modo tale da poter essere installate su di una superficie normalmente infiammabile • Instalável sobre uma superfície normalmente inflamável</p>	 <p>Dirección del halo de luz • Halo light direction • Direction du faisceau lumineux • Lichtstrom in Richtung • Direzione del fascio di luce • Direção do feixe de luz.</p>
 <p>No pueden ser instaladas en superficies inflamables • Unsuitable for installation on normally inflammable surfaces • Ne pas installer sur des surfaces normalement inflammables • Darf unter normalen Bedingungen nicht auf leicht entzündbaren Oberflächen angebracht werden • Tutte le lampade contraddistinte con questo simbolo non possono essere installate su di una superficie normalmente infiammabile • Não podem ser instaladas em superfícies inflamáveis</p>	 <p>Bajo consumo • Energy saving • Économie d'énergie • Energiesparlampe • Risparmio energetico • Poupança de energia</p>

Índice • Index

COLGANTES PENDANTS SUSPENSIONS PENDELLEUCHTEN PENDENTI SUSPENSÕES	APLIQUES WALL FIXTURES APPLIQUES WANDLEUCHTEN APLIQUE APLIQUES	SOBREMESAS TABLE LAMPS LAMPES DE TABLE TISCHLEUCHTEN DA TAVOLO CANDEEIROS DE MESA	PIES DE SALÓN FLOOR LAMPS LAMPADAIRES STEHLEUCHTEN PIEDISTALLO DA SALONE CANDEEIROS DE SALA	EMPOTRABLES EMBEDDED À ENCASTER EINBAULEUCHTEN ENCASTRABLE ENCASTRAVEL
00-4342-05-053	05-4342-05-052	10-4342-05-055	25-4342-05-054	90-4350-05-056
00-4350-05-056	www.modulelectro.ru			

Codificación • Codification • Codification • Bestellnummer • Codifica • Codificação

Para realizar el pedido de un artículo es necesario colocar después de la referencia del modelo los dos números que identifican el acabado seguidos de los dos números que corresponden al código suplementario. When placing an order for an item, please quote after the model reference number, the two numbers indicating the required finish and the two supplementary code numbers. Pour passer commande d'un article il faut indiquer après la référence du modèle, les deux numéros identifiant la finition, suivis de deux numéros correspondants au code supplémentaire. Bei der Bestellung eines Artikels müssen hinter der Modell-Nr. die zwei Ziffern für die Ausführung und die zwei Ziffern des Zusatzcodes angegeben werden. Per ordinare un articolo, si devono inserire, dopo la referenza, i 2 numeri per la finitura ed anche i 2 numeri per il codice supplementare. Para efectuar a encomenda de um artigo é necessário colocar depois da referência do modelo os dois números que identificam o acabamento, seguidos dos dois números que correspondem ao código suplementar.

Información general • General information • Information générale • Allgemeine Informationen • Informazioni generale • Informação geral

- Las descripciones y medidas de los aparatos del presente catálogo son orientativas, pudiendo por tanto ser modificadas, a fin de mejorar las características técnicas o de diseño. • La empresa se reserva el derecho de anular o modificar cualquier modelo sin previo aviso. • Todos los modelos presentados cumplen las normas exigidas por la C.E. para aparatos de iluminación de uso doméstico y sus características vienen determinadas por las clases I y II. • Los acabados y las especificaciones técnicas corresponden a los productos que se suministran en Europa, pudiendo éstos variar en otros mercados. • Para una buena conservación de las lámparas, no usar bombillas de potencia superior a las recomendadas y limpiar simplemente con un paño seco. No usar limpia metales, ya que dañan los barnices protectores que garantizan la duración del acabado.
- The descriptions and dimensions of the items in this catalogue are indicative and may be modified for the purpose of technical or design improvements. • We reserve the right to cancel or change all models without prior notice. • All items meet the E.C. Class I and Class II safety regulations for home lighting appliances. • The finishes and technical specifications listed here are for the European market and may vary elsewhere. • Do not use stronger bulbs than recommended, and always clean lamps with a soft dry cloth alone since metal polish will damage the protective finish.
- Les descriptions et mesures des appareils de ce catalogue sont données à titre d'orientation, pouvant être modifiées dans le but d'améliorer les caractéristiques techniques ou de design. • L'usine se réserve le droit d'annuler ou modifier l'un ou l'autre de ses modèles sans avis préalable. • Tous les modèles présentés sont conformes aux normes exigées par la C.E. pour les appareils d'éclairage domestique et leur caractéristiques sont déterminées par la classe I et II. • Les finitions et spécifications techniques correspondent à la demande du marché européen. Elles peuvent être modifiées pour d'autres pays. • Ne pas utiliser d'ampoules d'une puissance supérieure à celle recommandée. Pour un bon entretien, utiliser simplement un chiffon sec. N'utilisez aucun produit pour métaux, ils abîment le vernis protecteur.
- Die Beschreibung und Maße der in diesem Katalog aufgeführten Modelle dienen der Orientierung und können zur Verbesserung der technischen Eigenschaften oder des Designs geändert werden. • Der Hersteller behält sich das Recht vor, Modelle zu ändern oder aus dem Programm zu nehmen. • Die gezeigten Modelle erfüllen alle die innerhalb der EU geforderten Normen und Richtlinien für Leuchten für allgemeine Beleuchtungszwecke der Schutzklassen I und II. • Die Ausführungen und technischen Daten gelten für den europäischen Markt und können in anderen Ländern abweichen. • Für eine gute Erhaltung der Leuchten ist der Betrieb mit Lampen höherer Leistung als empfohlen zu vermeiden. Zur Reinigung benutzen Sie einfach ein trockenes Tuch, da Metallputzmittel die Schutzlackierung angreifen.
- Le descrizioni e le dimensioni degli articoli del presente catalogo vengono fornite a mero titolo indicativo e possono pertanto essere modificate al fine di migliorarne le caratteristiche tecniche o di design. • La Casa si riserva il diritto di cessare la produzione o di modificare qualsiasi modello senza preavviso. • Tutti i modelli presentati sono conformi alle normative C.E. per gli articoli di illuminazione per uso domestico di classe I e II. • Le rifiniture e le specifiche tecniche corrispondono ai prodotti venduti in Europa; tali dati possono pertanto variare su altri mercati. • Per una buona conservazione delle lampade, non utilizzare lampadine di potenza superiore a quella consigliata e pulirle semplicemente con un panno asciutto. Non utilizzare prodotti per la pulizia del metallo che potrebbero rovinare le vernici di protezione che garantiscono la vita della rifinitura.
- As descrições e medidas dos modelos do presente catálogo são orientativas podendo, portanto, ser modificadas com o fim de melhorar as características técnicas ou de Design. • A empresa reserva-se o direito de anular ou modificar qualquer modelo sem aviso prévio. • Todos os modelos apresentados cumprem as normas CE para aparelhos de iluminação de uso doméstico e as suas características de protecção estão definidas pelas Classes I ou II. • Os acabamentos e especificações técnicas correspondem aos produtos fornecidos na Europa, podendo estes ser diferentes em outros mercados. • Para bom funcionamento e manutenção dos aparelhos, nunca usar lâmpadas de potência superior à recomendada nem usar produtos para limpeza de metais porque podem danificar os vernizes de protecção que garantem a durabilidade do acabamento. Para limpeza usar apenas um pano seco.

Todos los derechos reservados. Ninguna parte de este libro puede ser reproducida en ningún formato de papel o electrónico, sin el consentimiento previo del editor o de los propietarios de los derechos. All rights reserved. No part of this publication may be reproduced or transmitted in any form or by any means, electronic storage and retrieval system, without permission in writing from the copyright owner (s). Tous droits réservés. Aucune partie de ce livre ne pourra être reproduite en format papier ou électronique sans l'autorisation préalable de l'éditeur ou du propriétaire des droits. Sämtliche Rechte vorbehalten. Kein Teil dieses Buches darf in keinem Papier- oder elektronischem Format ohne ausdrückliche Zustimmung des Herausgebers oder der Inhaber der Urheberrechte wiedergegeben oder vervielfältigt werden. Tutti i diritti riservati. Nessuna parte di questo libro può essere riprodotta in nessun formato cartaceo o elettronico, senza la previa autorizzazione dell'editore o dei proprietari dei diritti. Todos os direitos reservados. Nenhuma parte deste livro pode ser reproduzida em qualquer formato de papel ou electrónico, sem o consentimento prévio do editor ou dos proprietários dos direitos.



LEDS-C4, S.A.

Afuera s/n, - 25750 - TORA (Lleida) SPAIN

www.leds-c4.com

España

Tel.: 973 46 81 01

Fax.: 973 46 81 29

info@leds-c4.com

Europe

Tel.: + 34 973 46 81 02

Fax.: + 34 973 46 81 06

europe@leds-c4.com

France - Portugal

Tel.: + 34 973 46 81 30

Fax.: + 34 973 46 81 29

france@leds-c4.com

portugal@leds-c4.com

Asia - Pacific and Africa

Tel.: + 34 973 46 81 16

Fax.: + 34 973 46 81 06

export@leds-c4.com

USA - Canada - Ireland

Tel.: +34 973 46 81 09

Fax: +34 973 46 81 06

lighting@leds-c4.com

América Latina

Tel.: + 34 973 46 81 15

Fax.: + 34 973 46 81 06

sudamerica@leds-c4.com

Middle East Countries

Tel.: + 34 973 46 81 08

Fax.: + 34 973 46 81 06

dep-export@leds-c4.com



www.modulelectro.ru

