

# OUTDOOR

CATÁLOGO GENERAL  
GENERAL CATALOGUE  
2011



**MODUL**  
ELECTRO  
[www.modulelectro.ru](http://www.modulelectro.ru)

**LEDS-C4**

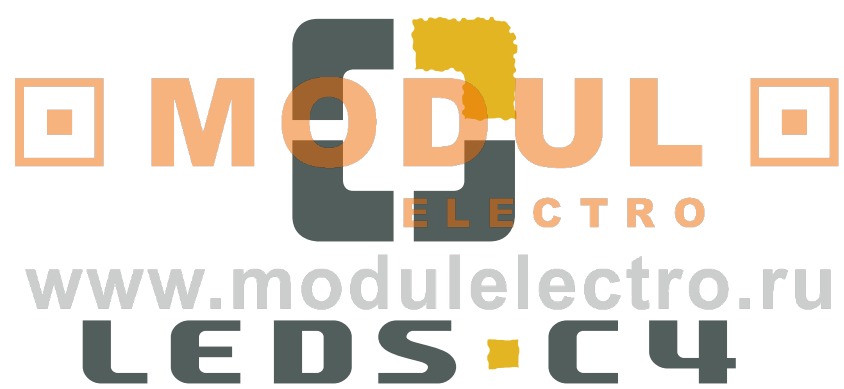

# DIALux

2

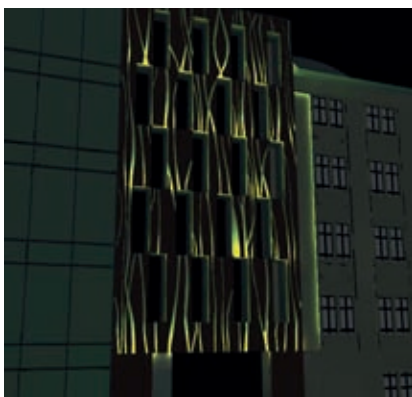

## MODUL ELECTRO

### CONSULTORÍA DE ILUMINACIÓN – DIALUX

LEDS-C4 dispone de un departamento técnico de proyectos de iluminación destinado a ayudar y asesorar a nuestros clientes sobre cualquier consulta en materia de iluminación. Este departamento está preparado para seleccionar el tipo de iluminación según sus necesidades y la funcionalidad de la zona. Asimismo, puede asesorarle sobre la mejor distribución de la intensidad de la luz.

Además, LEDS-C4 ofrece a sus clientes la posibilidad de trabajar con DIALux, el software líder en planificación de iluminación, que utilizan más de 30.000 proyectistas y lighting designers de todo el mundo.

### LIGHTING CONSULTANCY – DIALUX

LEDS-C4 has a technical department for lighting projects, with the aim to help and advise our clients about any questions they may have about lighting. This department is equipped to select the type of lighting according to your needs and the functionality of the area. It can also advise you on the best distribution of the light intensity.

LEDS-C4 also offers its clients the possibility of working with DIALux, the leading software in lighting planning, with more than 30,000 draftspeople and lighting designers from all over the world.

### LE CONSEIL EN ILLUMINATION – DIALUX

LEDS-C4 dispose d'un département technique de projets d'illumination destiné à aider et conseiller nos clients en matière d'illumination. Ce département est capable de choisir, avec vous, le meilleur type d'éclairage en fonction des vos besoins et des fonctionnalités de la zone en question. Ainsi, nous pouvons vous conseiller sur la meilleure distribution et intensité de la lumière.

De plus, LEDS-C4 offre à ses clients la possibilité de travailler avec DIALux, le logiciel leader en études et simulations d'éclairage, utilisé par plus de 30.000 designers et concepteurs lumière du monde entier.

### CONSULENZA DI ILLUMINAZIONE – DIALUX

LEDS-C4 dispone di un reparto tecnico di progetti di illuminazione destinato ad aiutare e consigliare i nostri clienti per qualsiasi problema in fatto di illuminazione. Questo reparto è preparato per selezionare il tipo di illuminazione a seconda delle necessità del cliente e la funzionalità della zona. Al tempo stesso, il cliente potrà essere consigliato in quanto alla distribuzione ottimale dell'intensità luminosa.

Inoltre, LEDS-C4 offre ai suoi clienti la possibilità di lavorare con DIALux, il software leader in pianificazione di illuminazione, utilizzato da oltre 30.000 progettisti e lighting designer di tutto il mondo.

### ABTEILUNG FÜR BELEUCHTUNGSBERATUNG – DIALUX

LEDS-C4 stellt den Kunden eine Abteilung zur technischen Beratung für Beleuchtungsprojekte zur Verfügung, die bezüglich jeder Angelegenheit im Zusammenhang mit der Beleuchtung Rat und Auskunft erteilt. Diese Abteilung ist Ihnen bei der Auswahl der Beleuchtungsart behilflich, die sich am besten an Ihre Bedürfnisse anpasst und die höchste Funktionalität im jeweiligen Einsatzbereich bietet. Darüber hinaus kann Sie diese Abteilung bezüglich der günstigsten räumlichen Lichtstärkeverteilung beraten.

LEDS-C4 bietet den Kunden überdies die Möglichkeit, mit DIALux zu arbeiten, der im Bereich der Beleuchtungsplanung marktführenden Software, die von über 30.000 Projekttechnikern und Beleuchtungsdesignern der ganzen Welt benutzt wird.

### CONSULTORIA DE ILUMINAÇÃO – DIALUX

A LEDS-C4 dispõe de um departamento técnico de projectos de iluminação destinado a ajudar e a prestar assessoria aos nossos clientes para qualquer consulta em matéria de iluminação. Este departamento está preparado para seleccionar o tipo de iluminação de acordo com as suas necessidades e a funcionalidade da zona. De igual modo, pode prestar-lhe assessoria para a melhor distribuição da intensidade da luz.

Além disso, a LEDS-C4 oferece aos seus clientes a possibilidade de trabalharem com o DIALux, o software líder em planificação de iluminação, que é utilizado por mais de 30.000 projectistas e lighting designers de todo o mundo.



### LEDS-C4 POR LA SOSTENIBILIDAD

El modelo de gestión de LEDS-C4 ha sido diseñado para que la actividad de la empresa sólo tenga repercusiones positivas sobre su entorno, tanto a nivel social como medioambiental.

En este sentido, LEDS-C4 garantiza que el diseño de todas las luminarias que aparecen en sus catálogos cumplen como mínimo con 4 de los siguientes requisitos por la sostenibilidad (C4 = COMPROMISO 4):

- Ofrecen una alta eficiencia energética
- Utilizan fuentes de luz energéticamente eficientes
- Controlan las emisiones de luz hacia el hemisferio superior (evitando así la contaminación lumínica)
- Incorporan mecanismos de regulación de la intensidad de la luz
- Favorecen la utilización de lámparas con bajo o nulo contenido de mercurio
- Fabricadas de forma que pueden ser desmontadas fácilmente al final de su vida útil
- Fabricadas con materiales reciclables o de larga durabilidad en el tiempo

### LEDS-C4 SUSTAINABILITY

LEDS-C4 management model has been designed so that the company's activity will only have positive effects on both its social and natural environment.

Thus, LEDS-C4 warrants that all luminaries design displayed in its catalogues fulfill at least 4 requirements for sustainability (C4 = COMMITMENT 4):

- They provide high energetic efficiency,
- The use light energetically efficient sources,
- They control light emissions towards the upper hemisphere (in order to avoid light pollution)
- They integrate regulation mechanisms for light intensity
- They match the use of lamps with a low or nil mercury content
- They are manufactured in such a way that they can be easily disassembled at the end of their lifespan
- They are manufactured by means of recyclable material or durable in time

### LEDS-C4 POUR LA DURABILITÉ

Le modèle de gestion de LEDS-C4 a été conçu pour que l'activité de l'entreprise n'ait que des répercussions positives sur son environnement, tant au niveau social qu'environnemental.

Dans cette optique, LEDS-C4 garantit que la conception de tous les luminaires figurant dans ses catalogues remplit au moins 4 des conditions requises ci-dessous en termes de durabilité:

- Ils offrent une efficacité énergétique élevée.
- Ils utilisent des sources de lumière énergétiquement efficaces.
- Ils contrôlent les émissions de lumière vers l'hémisphère supérieur (évitant ainsi la pollution lumineuse).
- Ils intègrent des mécanismes de régulation de l'intensité de la lumière.
- Ils favorisent l'utilisation de lampes à contenu faible ou nul de mercure.
- Ils sont fabriqués de façon à faciliter leur démontage à la fin de leur vie utile.
- Ils sont fabriqués avec des matériaux recyclables ou à forte durabilité temporelle.

### LEDS-C4 FÜR UMWELTVERTRÄGLICHKEIT

Das Geschäftsmodell von LEDS-C4 wurde so konzipiert, dass die Aktivitäten des Unternehmens ausschließlich positive Auswirkungen auf seine Umgebung haben, sowohl in Bezug auf das soziale Umfeld als auch auf die Umwelt.

Im Rahmen seiner Unternehmensphilosophie garantiert LEDS-C4, dass das Design aller Leuchtkörper seiner Produktpalette mindestens 4 der folgenden Nachhaltigkeitsprämissen erfüllt:

- Hohe Energieeffizienz
- Verwendung von energieeffizienten Lichtquellen
- Steuerung der Lichtemissionen in Richtung der oberen Hemisphäre (zur Vermeidung von Lichtverschmutzung)
- Vorrichtungen zur Regulierung der Lichtintensität
- bevorzugte Verwendung von Lampen mit geringem oder keinem Quecksilbergehalt
- konstruiert, um sich am Ende ihrer Nutzungsdauer leicht ausbauen zu lassen
- hergestellt aus leicht wiederverwertbaren oder lange haltbaren Materialien

### LEDS-C4 PER LA SOSTENIBILITÀ

Il sistema di gestione della LEDS-C4 è strutturato in modo che l'attività dell'azienda abbia esclusivamente ripercussioni positive sull'ambiente, SA a livello sociale che ambientale.

In questo senso, LEDS-C4 garantisce che il design di tutte le lampade che compaiono nei propri cataloghi rispettano almeno 4 dei seguenti requisiti per la sostenibilità dell'ambiente:

- Offrono un'alta efficacia energetica
- Utilizzano fonti di luce energeticamente efficienti
- Controllano le emissioni di luce fino all'emisfero superiore (evitando così la contaminazione luminosa)
- Contengono meccanismi di regolazione dell'intensità della luce
- Favoriscono l'utilizzazione di lampade con un contenuto di mercurio basso o inesistente
- Sono fabbricate in maniera da poter essere smontate facilmente al termine della loro vita utile
- Sono fabbricate con materiali riciclabili o di lunga durata nel tempo.

### LEDS-C4 PELA SUSTENTABILIDADE

O modelo de gestão da LEDS-C4 foi desenvolvido de forma a que a actividade da empresa só tenha repercussões positivas sobre a sua envolvente, tanto a nível social como ambiental.

Neste sentido, a LEDS-C4, garante que todas as luminárias que surgem nos seus catálogos, cumpram no mínimo com 4 dos seguintes requisitos pela sustentabilidade:

- Oferecem uma alta eficiência energética;
- Utilizam fontes de luz energeticamente eficientes;
- Controlam as emissões de luz até ao hemisfério superior (evitando assim a poluição luminosa);
- Incorporam mecanismos de regulação da intensidade da luz;
- Favorecem a utilização das lâmpadas com baixo ou nulo conteúdo de mercúrio;
- Fabricadas de forma a que possam ser desmontadas facilmente no final da sua vida útil;
- Fabricadas com materiais recicláveis ou de longa durabilidade no tempo;

# DISEÑADORES / DESIGNERS



Benedito Design



Manel Llusçà

**MODUL**   
**ELECTRO**

[www.modulelectro.ru](http://www.modulelectro.ru)



Josep Patsí



Ramon Camps



Francesc Vilaró



Nahrang disseny

**MODULO**  
**ELECTRO**

[www.modulelectro.ru](http://www.modulelectro.ru)



Josep Juanola

								
AFRODITA.....65,67,69	AJAX.....51,53	ALBA.....201	ALEXANDRIA.....181	ALFA.....13	ALIEN.....87			
								
ANTEO.....223	AQUA.....127	ARIADNA.....167	ARMONIA.....168	ATENA.....55	ATLANTE.....241	ATLANTIDA.....231		
								
BASIC.....35	CIRI.....209	CROSS.....205	CURIE.....45	DALTON.....17,19	DARWIN.....41	DELPHOS.....61	ECLIPSE.....54	EDIPO.....219
								
ELECTRA.....161,163	EOLO.....88	ESPARTA.....91	FENIX.....73	FLASH.....97	GALATEA.....233,235	GALILEI.....49		
								
GRID.....211,212	HADES.....226	HEBE.....183	HECATE.....101	HELIO.....89	HERA.....213	HERCULES.....57		
								
HUBBLE.....81	ICARO.....179	IRIS.....228	ITACA.....222	IXION.....185	JANNA.....197	LUA.....31	MARK.....189	MEDEA.....221
								
MICENAS.....25	MIDI.....99	MIMER.....170	MORFEO.....225	NEMESIS.....71	NEREO.....166	OCEANO.....229	O'COLOR.....85	
								
ODISEO.....215	OLIMPO.....237	PASTEUR.....29	PERSEFONE.....217	PERSEO.....228	POMPEYA.....95	POSIDO.....226		

MODULO ELECTRO  
www.modulelectro.ru



**PLAFÓN / CEILING FIXTURE / PLAFONNIER / DECKENLEUCHE / PLAFONIER / LUMINÁRIA DE TECTO**



**COLGANTE / PENDANT / SUSPENSION / PENDELLEUCHE / LAMPADA A SOSPENSIONE / LUMINÁRIA PARA SUSPENSÃO**

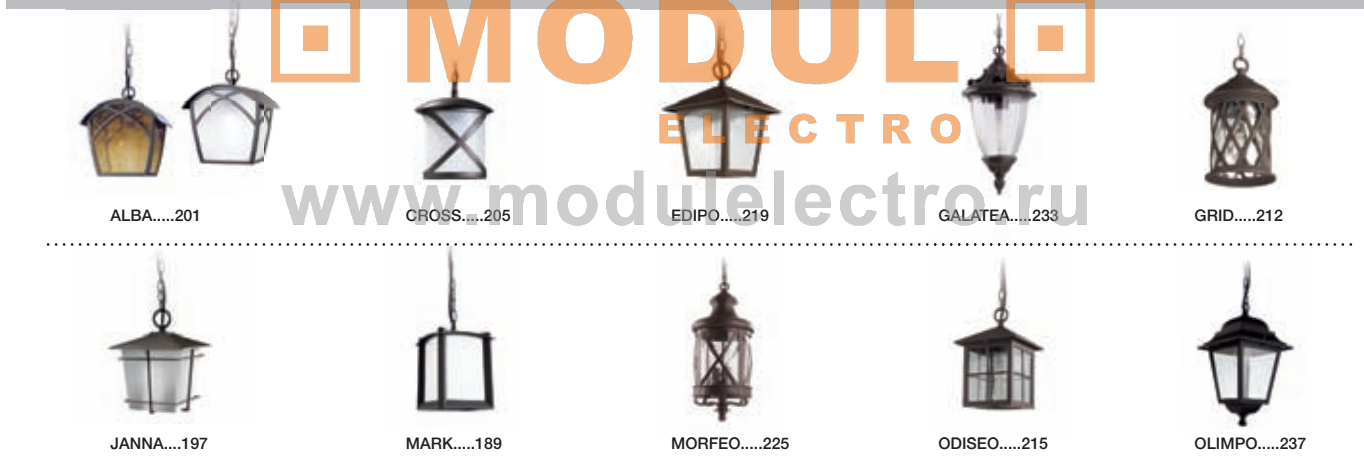

**SOBREMURO / LANTERN / LANterne / MAUERLEUCHE / LAMPADA DI MURO / SOBREMURO**





BALIZA / BEACON / BALISE / STEHLEUCHTE / PALETTI / LUMINÁRIA PARA BALIZAGEM



ALBA.....203      ALEXANDRIA.....181      BALIZAS.....155      BALIZAS.....157      BALIZAS.....158      BRIDGE.....141      CROSS.....205      CUBIK.....137



EDIPO.....220      ELECTRA.....161,163      HEBE.....183      ICARO.....179      IXION.....185      MARK.....193      MERCURIO.....159



NEWTON.....143      NOTT.....151      PRIAP.....165      QUADRA.....149      TEMIS.....263      TORCH.....145      URANO.....159

**MODULO**  
ELECTRO

www.modulelectro.ru

EMPOTRABLE / EMBEDDED / À ENCASTRER / EINBAULEUCHTEN / ENCASTRABLE / ENCASTRABEL



AQUA.....125,127      GEA.....109      GEA.....106,107      GEA.....109-121



HERCULES.....27      MICENAS.....23,25      XENA.....131,133

PROYECTOR / PROJECTOR / PROJECTEUR / STRAHLER / PROIETTORE / PROJECTOR



ALIEN..... 87      AQUA..... 127      EOLO.....88      ESPARTA ..... 91      FLASH.....97      HELIO.....89      HUBBLE.....81  
ICARO.....179      MIDI.....99      O'COLOR.....85      POMPEYA.....95      RAY.....102      TRON.....103      SKADE.....88



ANDALUCIA.....266



ATLANTE.....241



BOHEMIA. ....266



CITIZEN.....267



ELIPSE.....264



GALATEA.....235



HEADS.....254,255,257



MERIDIAN.....267



OLIMPO.....239



PERSEFONE.....217



POMPEYA .....96



PROMENADE .....265



TEMIS.....260,261

**MODULO ELECTRO**

OTROS / OTHERS / AUTRES / ANDERE / ALTRI / OUTROS

www.modulelectro.ru



CISNE.....244



ION.....247



MOONLIGHT.....147



RAND.....251



ROCK.....243



ZENIT...249

ACCESORIOS / ACCESSORIES / ACCESSORIES / ACCESSOIRES / ZUBEHÖR / ACCESSORI / ACESSÓRIOS



KIT VSAP/HM  
HPS/MH KIT.....254,257



CONTROLADORES RGB  
RGB CONTROL SYSTEM.....245



CAJA DE CONEXIONES  
CONNECTION BOX.....268



CAJA PARA EMPOTRAR  
FLUSH FITTING BOX.....269



CONECTOR IP 68  
IP 68 CONNECTION..... 268



CONTRAPESO PARA FAROLAS.  
BALANCING WEIGHT  
FOR LAMPOSTS.....239,241,269



REACTANCIA  
BALLAST..... 27,71,269



ACCESORIO PARA LED  
LED ACCESSORY.....270,271



TRANSFORMADOR  
TRANSFORMER.....268



ACCESORIO PARA IP65  
ACCESSORY UP TO IP 65.....269



BRAZO  
ARM.....81,89,91,269

LÀMPARA / LAMP / GLÜHBIRNE / AMPOULE / LAMPADINA / LÂMPADA ... 272-274



# TINA





Design by Nahrang Disseny

Tina 10

## Tina collection ®

- Apliche de cuidado diseño realizado en aluminio de alta calidad y con difusor de policarbonato. Posibilidad de instalación en horizontal y en vertical. También permite la orientación de la luz para adaptarse a cada necesidad concreta de iluminación. Equipo electrónico para fluorescencia incluido.
- Cared of design wall light made of high quality aluminium and a polycarbonate diffuser. May be horizontally or vertically installed. It also allows positioning the light in order to suit each illumination specific need. Electronic equipment for fluorescence included.
- Applique au design soigné, fabriqué en aluminium de grande qualité et munie d'un diffuseur en polycarbonate. Possibilité d'installation horizontale et verticale. Permet également d'orienter la lumière selon le besoin d'éclairage concret. Dispositif électronique de fluorescence compris.
- Wandleuchte in ausgefeiltem Design aus hochwertigem Aluminium mit Diffusor aus Polykarbonat. Horizontaler und vertikaler Einbau möglich. Der Lichtstrahl lässt sich je nach Beleuchtungsbedarf ausrichten. Aggregat für fluoreszierende Lampe eingeschlossen.
- Applique dal design raffinato realizzata in alluminio di alta qualità e con diffusore in policarbonato. Può essere installata sia verticalmente che orizzontalmente. Luce orientabile che rende possibile l'adeguarsi a ogni specifica necessità di illuminazione. Impianto elettronico per fluorescente incluso.
- Apliche de cuidado desenho realizado em alumínio de alta qualidade e com difusor de policarbonato. Possibilidade de instalação em horizontal e em vertical. Também permite a orientação da luz para se adaptar a cada necessidade concreta de iluminação. Equipamento eletrônico para fluorescência incluído.

® Registration number: Pending

 **MODUL**   
ELECTRO  
[www.modulelectro.ru](http://www.modulelectro.ru)



Materiales / Materials



Accesorio reflector  
Reflector accessory

Especificaciones / Specifications

IP 54 CE RF 850° ENERGY SAVING IK 07



Acabados / Finishes

- 34 Gris
- Grey
- Cris
- Grau
- Grigio
- Cinzentu

(New)



05-9472-34-M3 ■

2G11 36W

IP 54 2

Included

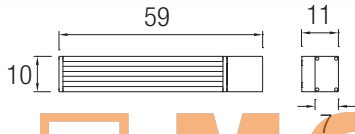

**MODULO**  
ELECTRO

www.modulelectro.ru

# ALFA





Design by Manel Llusà

## Alfa collection ®

- Colección de apliques en dos acabados (gris y marrón) que permiten el montaje en superficie, ocupando así el mínimo espacio.
- Wall lights collection within two finishes (grey and brown) which allows a surface mounting, taking up the minimum space.
- Collection d'appliques en deux coloris (gris et marron) pouvant être montées en surface pour occuper un minimum d'espace.
- Wandleuchten-Kollektion in zwei Ausführungen (grau und schoko) zur Oberflächenmontage mit minimalem Platzbedarf.
- Collezione di applique in due finiture (grigio e marrone) che permettono il montaggio in superficie, occupando così il minimo spazio.
- Coleção de apliques em dois acabamentos (cinzento e castanho) que permite, uma montagem em superfície, ocupando assim o mínimo espaço.

® Registration number: 0011866221-068 / 0011866221-069

 **MODUL**   
**ELECTRO**  
[www.modulelectro.ru](http://www.modulelectro.ru)



Materiales / Materials



MONTAJE EN SUPERFICIE  
SURFACE MOUNTED

Especificaciones / Specifications

IP 54 IK 07

Acabados / Finishes

J6 Marrón Brown Marron Braun Marrone Castanho	34 Gris Grey Gris Grau Grigio Cinzento
--	---



05-9344-J6-T2 ■

05-9344-34-T2 ■ (NEW)

GU-10 max. 50W

GU-10 max. 9W Fluorescent

GU-10 max. 5W LED

IP 54 6 276 IK 07

OSRAM 50W **Included**

GU-10 50W

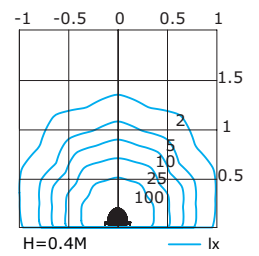
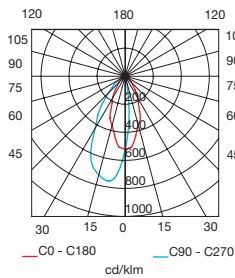

**MODULO**  
ELECTRO

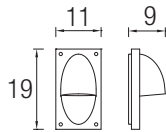

[www.modulelectro.ru](http://www.modulelectro.ru)



05-9345-J6-T2 ■

05-9345-34-T2 ■ (NEW)

G24d-3 26W fluorescent

IP 54 4 276 IK 07

**Included**

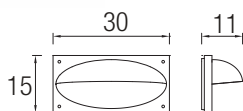
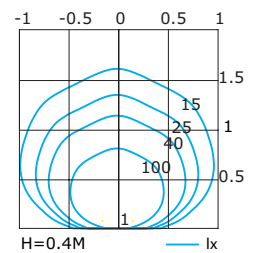
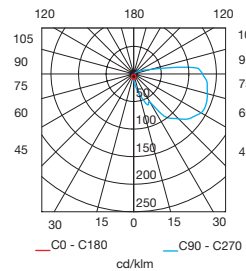



**MODULO**  
ELECTRO  
[www.modulelectro.ru](http://www.modulelectro.ru)





### Dalton collection ®

- Colección formada por empotrables de varios tamaños y formas, realizados en aluminio de alta calidad y con difusor de cristal mate. Disponibles en acabado gris claro.
- Embedding collection with several sizes and shapes made of high quality aluminium with a matt glass diffuser. Light grey finish available.
- Collection composée d'encastables aux formes et dimensions diverses, fabriqués en aluminium de grande qualité et munis d'un diffuseur en verre mat. Disponibles en gris clair.
- Die Kollektion besteht aus Einbauleuchten in verschiedenen Größen und Formen aus hochwertigem Aluminium und mit Mattglas-Diffusor. In hellgrau lieferbar.
- Collezione formata da lampade da incasso di diverse forme e grandezze, realizzate in alluminio di alta qualità e con diffusore di vetro opaco. Disponibile anche in grigio chiaro.
- Coleção formada por embutidos de vários tamanhos e formas, realizados em alumínio de alta qualidade e com difusor de cristal mate. Disponíveis em acabamento cinzento claro.

® Registration number: Pending



 **MODUL**   
ELECTRO  
[www.modulelectro.ru](http://www.modulelectro.ru)





**MODUL**  
ELECTRO  
[www.modulelectro.ru](http://www.modulelectro.ru)

Materiales / Materials



Incluido / Included



Especificaciones / Specifications



Acabados / Finishes

- 34 Gris
- Grey
- Gris
- Grau
- Grigio
- Cinzeno

(new)

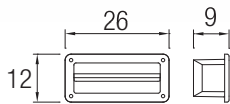

**05-9460-34-T2** ■

➔ G24d-3 26W fluorescent

☑ 6 🌱 277 IK 06

📦 BAG Included

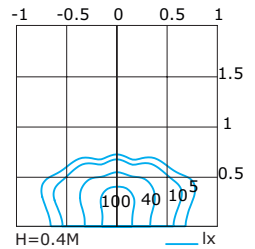
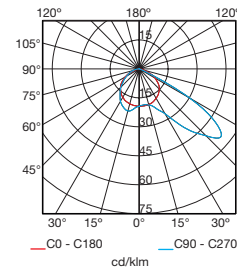

(new)

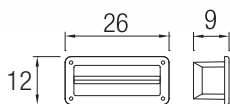

**05-9461-34-T2** ■

6 x 1W LED 230V EDISON Neutral white 4200K

☑ 6 🌱 277 IK 06

📦 EAGLE RISE Included



**MODULO**  
**ELECTRO**  
[www.moduloelectro.ru](http://www.moduloelectro.ru)

(new)

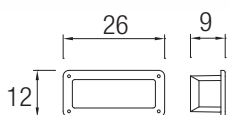

**05-9466-34-B8** ■

➔ G24d-3 26W fluorescent

☑ 6 🌱 277 IK 04

📦 BAG Included

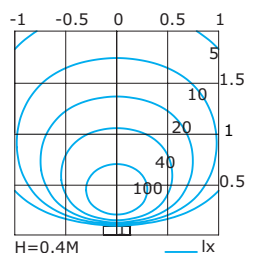
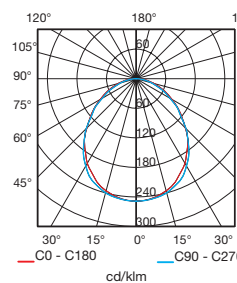



Materiales / Materials



Incluido / Included



Especificaciones / Specifications



Acabados / Finishes

- 34 Gris
- Grey
- Gris
- Grau
- Grigio
- Cinzentu

(new)



**05-9464-34-T2** ■

➤ G24d-3 26W fluorescent

☑ 2 🌱 🛠️ 277 IK 06

📦 BAG Included

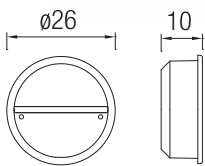
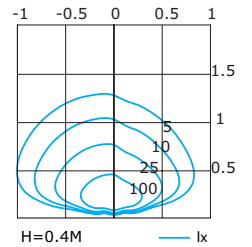
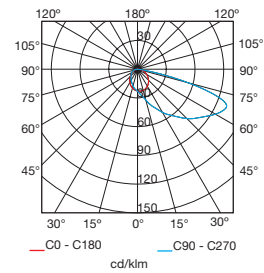

**MODUL**  
ELECTRO

[www.modulelectro.ru](http://www.modulelectro.ru)

(new)





**05-9467-34-B8** ■

➤ 2 x G24d-2 18W fluorescent

☑ 2 🌱 🛠️ 277 IK 04

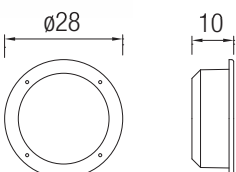
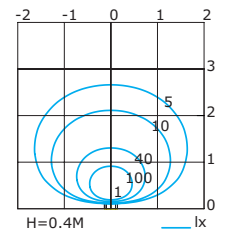
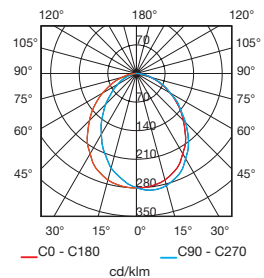
📦 Included





**MODUL**  
ELECTRO  
[www.modulelectro.ru](http://www.modulelectro.ru)

## Micenas collection <sup>®</sup>

- Colección de bañadores de suelo empotrables y de superficie con gran variedad de tamaños y formas realizados en aluminio inyectado. Los modelos están especialmente indicados para la señalización de zonas de paso. Además, están disponibles para utilizar con lámparas fluorescentes, halogenuros y LED.
- A collection of built-in floor and surface wash lights in a large variety of shapes and sizes, made of die-cast aluminium. The models are specially designed to indicate paths. They are also available to be used with fluorescent, halide and LED lamps.
- Une collection de luminaires de sol encastrables et de surface disposant d'une grande variété de tailles et de formes, en aluminium injecté. Les modèles sont particulièrement indiqués pour la signalisation de chemins et zones piétonnes. Ils permettent, de plus, l'utilisation de lampes fluorescentes, halogénures et LED.
- Eine Kollektion von Lichtdiffusoren, die in Böden eingebaut werden können, bestehend aus einer umfangreichen Auswahl an Größen und Formen, hergestellt aus gespritztem Aluminium. Die Modelle eignen sich besonders zur Markierung von Durchgangszonen. Sie sind ebenfalls für die Benutzung von Leuchtstoff-, Halogendampf- und LED-Lampen geeignet.
- Collezione di elementi bagnabili da suolo, a incasso e di superficie, dalla grande varietà di dimensioni e forme, realizzati in alluminio iniettato. I modelli sono particolarmente indicati per la segnalazione di zone di passaggio. Inoltre, possono essere utilizzati con lampade a fluorescenza, ad alogenuri e LED.
- Colecção de bases de duche de solo encastráveis e de superfície com uma grande variedade de tamanhos e formas feitas em alumínio injectado. Os modelos são especialmente indicados para a sinalização de zonas de passagem. Além disso, estão disponíveis com lâmpadas fluorescentes, halogenetos e LED.



**MODUL**

<sup>®</sup> Registration number: 001186621-041



**ELECTRO**

[www.modulelectro.ru](http://www.modulelectro.ru)





 **MODUL**   
ELECTRO  
[www.modulselectro.ru](http://www.modulselectro.ru)



Materiales / Materials



Incluido / Included



Especificaciones / Specifications



Acabados / Finishes

- 34 Gris
- Grey
- Gris
- Grau
- Grigio
- Cinzentto



**05-9407-34-B8** ■

G24d-3 26W fluorescent

IP 54 4 276 IK 04

**BAG Included**

CRIS STN

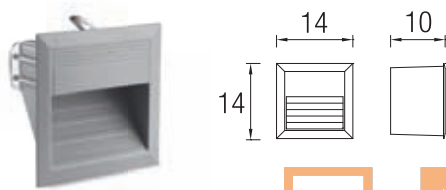
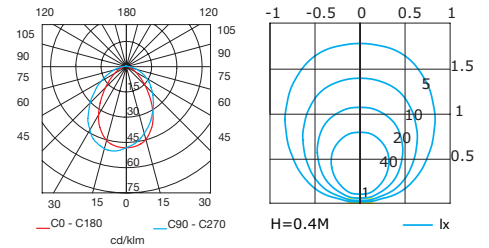

**05-9169-34-37** ■

18 x 0,1W - 230V Cool white 6500K

IP 65 6 276 IK 04

**Included**

PC TRAN

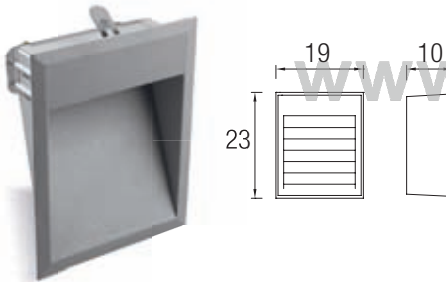
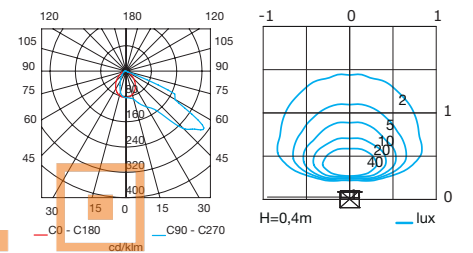

**05-9240-34-37** ■

27 x 0,1W - 230V Cool white 6500K

IP 65 4 276 IK 04

**Included**

PC TRAN

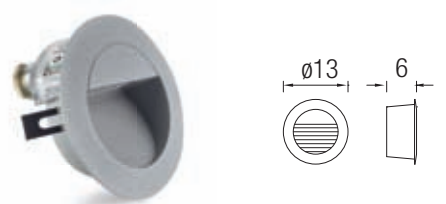
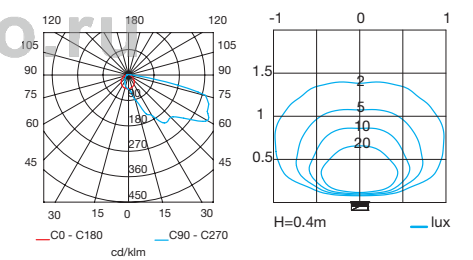

**05-9167-34-37** ■

14 x 0,1W - 230V Cool white 6500K

IP 65 6 276 IK 04

**Included**

PC TRAN

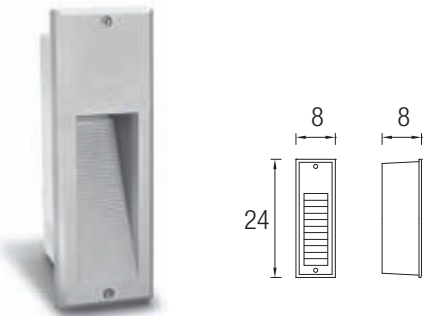
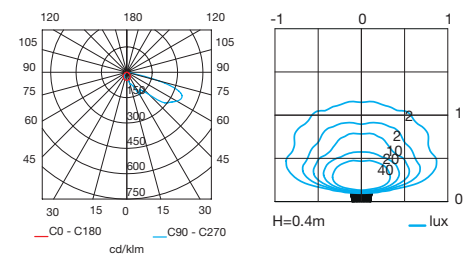

**05-9128-34-T2** ■

G9 max. 60W

IP 44 6 276 IK 04

**40W OSRAM Included**

CRIS STN

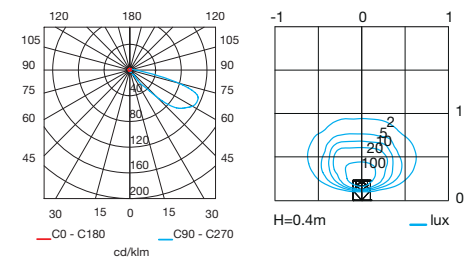

**MODULO ELECTRO**

www.moduloelectro.ru





**MODUL**  
ELECTRO  
[www.modulelectro.ru](http://www.modulelectro.ru)

Materiales / Materials



Especificaciones / Specifications



Acabados / Finishes

■ 34 Gris	■ Z5 Gris urbano
Grey	Urban grey
Gris	Gris urbain
Grau	Anthrazit
Grigio	Grigio urbano
Cinzeno	Cinzeno urbano

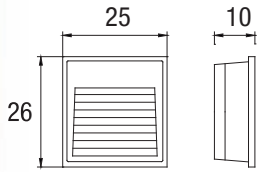

**05-9434-34-T2** ■

G24d-3 26W fluorescent

IP 54 2 IK 04

BAG Included

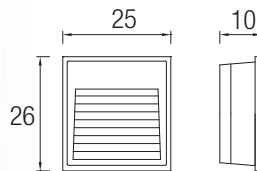
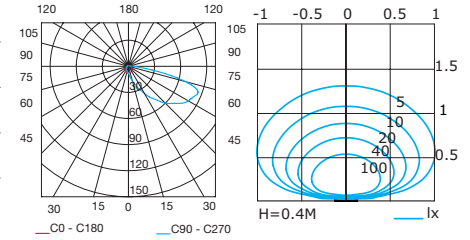

**05-9388-34-T2** ■

**05-9388-Z5-T2** ■ (S)

G12 35W HID

IP 54 2 IK 04

BAG Included

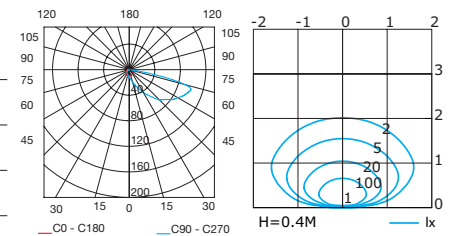

**05-9179-34-B8** ■

**05-9179-Z5-B8** ■

G24d-3 26W fluorescent

IP 44 6 IK 06

BAG/VOSSLÖH Included

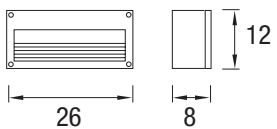
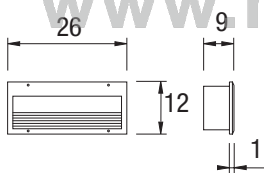
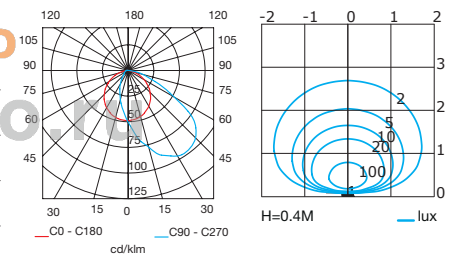

**05-9315-34-B8** ■

**05-9315-Z5-B8** ■

G24d-3 26W fluorescent

IP 44 6 IK 06

BAG/VOSSLÖH Included

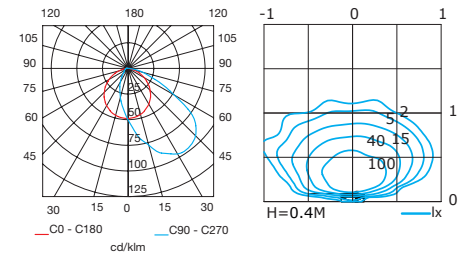

Montaje en superficie  
Surface mounted

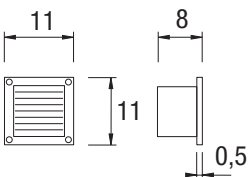

**05-9182-34-B8** ■

G9 max. 40W

IP 65 6 IK 04

40W OSRAM + Dos frontales Included

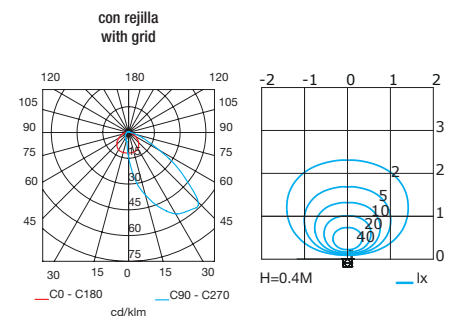

con rejilla  
with grid

# HERCULES

26  
Hercules



## Hercules collection

- Colección de empotrables de pared y apliques de superficie, con gran variedad de tamaños y formas realizados en aluminio inyectado. Los modelos, especialmente indicados para la señalización de zonas de paso, están disponibles con lámparas fluorescentes.
- A collection of built-in wall luminaires and surface wall fixtures, in a wide variety of shapes and sizes, made of die-cast aluminium. The models are specially designed for indicating paths, and they are available with fluorescent.
- Une collection de luminaires encastrables muraux et appliques de surface avec une grande variété de tailles et de formes, en aluminium injecté. Les modèles, particulièrement indiqués pour la signalisation de chemins et zones piétonnes, sont également disponibles avec des lampes fluorescentes.
- Eine Kollektion von Wandeinbau- und Wandaufsatzleuchten in vielfältigen Größen und Formen, die aus eingespritztem Aluminium hergestellt werden. Die Modelle, die sich besonders zur Markierung in Durchgangszonen eignen, sind mit Leuchtstofflampen erhältlich.
- Collezione di elementi a incasso da parete e applique di superficie dalla grande varietà di dimensioni e forme realizzate in alluminio iniettato. I modelli, particolarmente indicati per la segnalazione di zone di passaggio, sono disponibili con lampade fluorescenti.
- Coleção de encastráveis de parede e apliques de superfície com uma grande variedade de tamanhos e formas feitos em alumínio injectado. Os modelos, especialmente indicados para a sinalização de zonas de passagem, estão disponíveis com lâmpadas fluorescentes.



**MUY IMPORTANTE** consulte la tabla de usos y mantenimiento en la página 290  
**VERY IMPORTANT** please consult the table on use and maintenance on page 290  
**TRÈS IMPORTANT** consultez la table d'utilisation et de maintenance de la page 290

**WICHTIG** Bitte beachten Sie die Tabelle der Gebrauchs- und Instandhaltungsanweisungen auf Seite 290  
**MOLTO IMPORTANTE** si consulti la tabella di uso e manutenzione a pagina 290  
**MUITO IMPORTANTE** consulte a tabela de uso e manutenção na página 290

Materiales / Materials



Incluido / Included



Especificaciones / Specifications

IP 44 CE IK 08



Acabados / Finishes

05 Negro Black Noir Schwarz Nero Preto	14 Blanco White Blanc Weiß Bianco Branco	34 Gris Grey Gris Grau Grigio Cinzento	Y4 Acero inoxidable Stainless steel Acier inoxydable Rostfreier Stahl Acciaio inossidabile Aço inoxidável
---	---	---	--

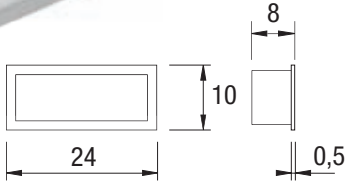

**05-9211-Y4-T2**

PL elect. E-27 max. 20W - GE

E-27 ø45 max. 60W

IP 44 18 276 IK 08

set completo para uso con / complete set to use with PL G24d-1

**05-9211-Y4-T2 + 71-8969-00-00**

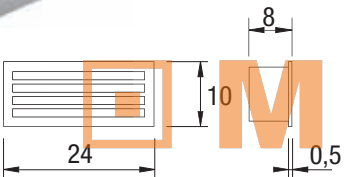
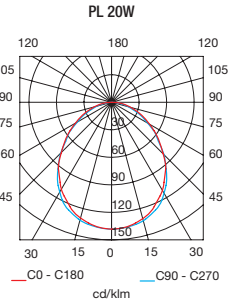

**05-9212-Y4-T2**

PL elect. E-27 max. 20W - GE

E-27 ø45 max. 60W

IP 44 18 276 IK 08

set completo para uso con / complete set to use with PL G24d-1

**05-9212-Y4-T2 + 71-8969-00-00**

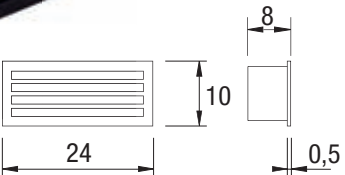
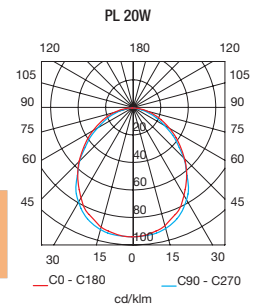

**05-8759-05-B8**

**05-8759-14-B8**

**05-8759-34-B8**

PL elect. E-27 max. 20W - GE

E-27 ø45 max. 60W

IP 44 18 276 IK 08

set completo para uso con / complete set to use with PL G24d-1

**05-8759 + 71-8969-00-00**

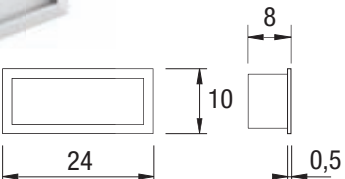
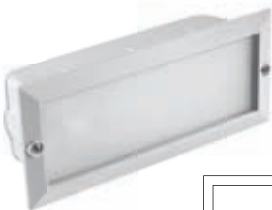
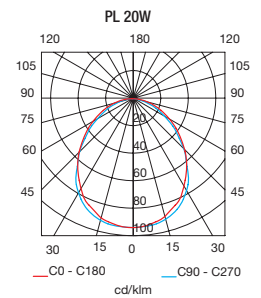

**05-8961-05-B8**

**05-8961-14-B8**

**05-8961-34-B8**

PL elect. E-27 max. 20W - GE

E-27 ø45 max. 60W

IP 44 18 276 IK 08

set completo para uso con / complete set to use with PL G24d-1

**05-8961 + 71-8969-00-00**

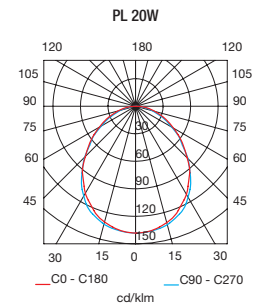

**71-8969-00-00**

Reactancia para PL G24d-1 13W  
Ballast for PL G24d-1 13W

# PASTEUR

Design by Manel Llusçà

Pasteur 28

## Pasteur collection ®

- Luminaria realizada en aluminio de alta calidad y con difusor de policarbonato mate. Equipo de bajo consumo integrado.
- High quality aluminium luminaire, provided with a matt polycarbonate diffuser. Integrated low consumption equipment.
- Luminaire fabriqué en aluminium de grande qualité et muni d'un diffuseur en polycarbonate mat. Dispositif basse consommation intégré.
- Leuchte aus hochwertigem Aluminium mit Diffusor aus matterm Polykarbonat. Einschließlich Niedrigverbrauch-Aggregat.
- Lampada realizzata in alluminio di alta qualità e con diffusore di policarbonato opaco. Impianto di basso consumo integrato.
- Lustre realizado em alumínio de alta qualidade e com difusor de policarbonato mate. Equipamento de baixo consumo integrado.

® Registration number: Pending

  
www.modulelectro.ru



Materiales / Materials



Especificaciones / Specifications



Acabados / Finishes

- Z5 Gris urbano
- Urban grey
- Gris urbain
- Anthrazit
- Grigio urbano
- Cinzeno urbano

(new)

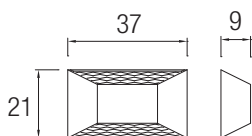

**05-9456-Z5-M3** ■

2 x G24d-2 18W fluorescent

4 IK 10

Included

**MODULO**  
ELECTRO  
[www.modulelectro.ru](http://www.modulelectro.ru)

# LUA



Design by Manel Llusçà

## Lua collection ®

- Luminaria Up & Downlight de estilo moderno, realizada en aluminio de alta calidad y con difusor de cristal mate. Disponible en acabado gris oscuro y equipo de bajo consumo integrado.
- Modern style Up & Down light illumination, made of high quality aluminium and matt glass diffuser. Dark grey finish and integrated low consumption equipment.
- Luminaire à éclairage vers le haut et vers le bas au style moderne, fabriqué en aluminium de grande qualité et muni d'un diffuseur en verre mat. Disponible en gris foncé, avec dispositif basse consommation intégré.
- Up-&Downlight-Leuchte im modernen Design, aus hochwertigem Aluminium und mit Diffusor aus Mattglas. Lieferbar in dunkelgrau und mit integriertem Niedrigverbrauch-Aggregat.
- Lampada Up & Downlight dallo stile moderno, realizzata in alluminio di alta qualità con diffusore in vetro opaco. Disponibile in grigio scuro e con impianto di basso consumo integrato.
- Lustre Up & Downlight de estilo moderno, realizada em alumínio de alta qualidade e com difusor de cristal mate. Disponível em acabamento cinzento-escuro e equipamento de baixo consumo integrado.

® Registration number: Pending



**MODUL**  
ELECTRO  
[www.modulelectro.ru](http://www.modulelectro.ru)

Materiales / Materials



Especificaciones / Specifications

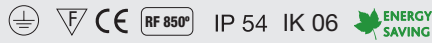

Acabados / Finishes

- Z5 Gris urbano
- Urban grey
- Gris urbain
- Anthrazit
- Grigio urbano
- Cinzeno urbano

(new)

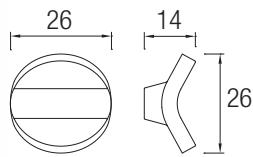

05-9471-Z5-T2 ■

G24d-3 26W fluorescent

IP 54 4 IK 06

Included

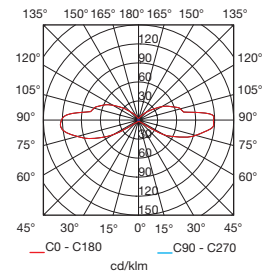

**MODULO**  
ELECTRO

[www.modulelectro.ru](http://www.modulelectro.ru)



# SOPHIE



Design by Manel Llusçà

## Sophie collection ®

- Sophie destaca por su diseño contemporáneo de líneas rectas y curvas, haciéndola ideal tanto para ambientes modernos como clásicos. Disponible en una sola luz o doble según cada necesidad.
- Sophie stands out for its contemporary design made of straight and curve lines, perfect for modern or classical environments. Sole or double light available, depending on each need.
- Doté d'un design contemporain aux lignes droites et courbes, le luminaire Sophie s'adapte tant aux environnements modernes qu'aux plus classiques. Disponible en éclairage simple ou double selon le besoin.
- Die Serie Sophie besticht durch ihr zeitgenössisches Design mit geraden Linien und Kurven, die zu modernen und klassischen Innenräumen gleichermaßen passen. Lieferbar je nach Beleuchtungsbedarf mit einem oder zwei Lampen.
- Lampada dal design contemporaneo caratterizzato da linee rette e curve, perfetta sia in un ambiente moderno che in un ambiente classico. Disponibile con una sola luce o due, secondo le esigenze.
- Sophie destaca pelo seu desenho contemporâneo de linhas rectas e curvas, fazendo-a ideal tanto para ambientes modernos como clássicos. Disponível numa só luz ou dupla segundo cada necessidade.

® Registration number: Pending



Materiales / Materials



Especificaciones / Specifications



Acabados / Finishes

- Z5 Gris urbano
- Urban grey
- Gris urbain
- Anthrazit
- Grigio urbano
- Cinzeno urbano

(new)

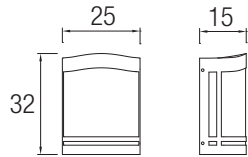

05-9509-Z5-37 ■

PL elect. E-27 max. 23W

IP 23 4

Consultar disponibilidad.  
Check availability.

# MODULO ELECTRO

[www.modulelectro.ru](http://www.modulelectro.ru)

(new)

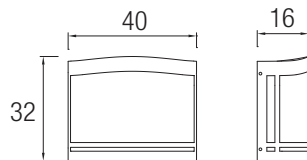

05-9510-Z5-37 ■

2 x PL elect. E-27 max. 23W

IP 23 2

Consultar disponibilidad.  
Check availability.

# BASIC

Design by Josep Patsí

## Basic collection <sup>®</sup>

- Colección para lámpara fluorescente E27 pensada para su uso como applique o plafón. Su fabricación con materiales plásticos y su IK10 lo hace ideal para instalar en zonas públicas y para soportar las condiciones ambientales más extremas. Versiones sin cruz frontal disponibles en gris claro y versiones con cruz frontal disponibles en gris oscuro.
- Collection of E27 fluorescent lamps which can be used whether as wall light or soffit. It is made of plastic materials which, combined to its IK10, renders it perfect for installation in public areas and endures the most extreme environmental conditions. Versions without front cross available in light grey; versions with front cross available in dark grey.
- Collection pour lampe fluorescente E27 conçue pour une utilisation en applique ou en plafonnier. Sa fabrication en matériaux plastiques et son indice IK10 la rendent idéale pour une installation en zones publiques et pour supporter les conditions environnementales les plus extrêmes. Versions sans croix frontale disponibles en gris clair et versions avec croix frontale disponibles en gris foncé.
- Kollektion für fluoreszierende Lampe E27 zur Nutzung als Wand- oder Deckenleuchte. Dank dem Gehäuse aus Kunststoffe und dem IK10 ist die Leuchte ideal für die Installation in öffentlichen Räumen. Sie hält auch extremen Witterungsbedingungen stand. Ausführung ohne Kreuz an Vorderseite in Hellgrau lieferbar und Ausführung mit Kreuz in Dunkelgrau lieferbar.
- Collezione per lampade fluorescenti E27 pensata per il suo uso come applique o plafoniera. La fabbricazione in materiale plastico e il suo IK10 la rendono ideale per essere installata in zone pubbliche e per sopportare le condizioni ambientali più estreme. Versioni senza croce frontale sono disponibili in color grigio scuro.
- Coleção para lâmpada fluorescente E27 pensada para o seu uso como applique ou teto. A sua fabricação com materiais plásticos e a sua IK10 fá-lo ideal para instalar em zonas públicas e para suportar as condições ambientais más extremas. Versões sem cruz frontal disponíveis em cinzento claro e versões com cruz frontal disponíveis em cinzento-escuro.

<sup>®</sup> Registration number: Pending



Materiales / Materials



Especificaciones / Specifications

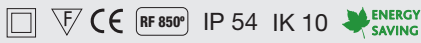

Acabados / Finishes

■ 34 Gris Grey Gris Grau Grigio Cinzeno	■ Z5 Gris urbano Urban grey Gris urbain Anthrazit Grigio urbano Cinzeno urbano
--	---

(new)

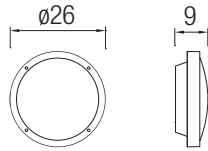

**15-9491-34-M3** ■

PL elect. E-27 max. 18W



IP 54 12 IK 10

(new)

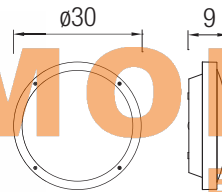

**15-9493-34-M3** ■

2 x PL elect. E-27 max. 23W



IP 54 12 IK 10

**MODULE**  
**ELECTRO**  
[www.modulelectro.ru](http://www.modulelectro.ru)

(new)

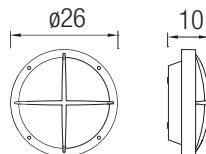

**15-9492-Z5-M3** ■

PL elect. E-27 max. 18W



IP 54 12 IK 10

(new)

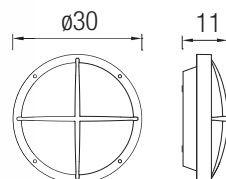

**15-9494-Z5-M3** ■

2 x PL elect. E-27 max. 23W



IP 54 12 IK 10



**MODUL**  
ELECTRO  
[www.modulelectro.ru](http://www.modulelectro.ru)



## Surf collection ®

- Novedosa colección de apliques de superficie modernos, disponible en tres tamaños distintos y realizada en aluminio de alta calidad. Versiones en LED y en fluorescencia, especialmente diseñadas para proyectar luz sin renunciar a un diseño moderno y compacto.
- Innovative collection of modern surface wall lights, three different sizes available and made of high quality aluminium. Led and fluorescent versions specifically designed in order to cast the light without having to give up to a modern and compact design.
- Nouvelle collection d'appliques de surface modernes disponibles en trois dimensions différentes et fabriquées en aluminium de grande qualité. Versions en LED et en fluorescence spécialement conçues pour projeter de la lumière sans renoncer à un design moderne et compact.
- Neuartige Wandleuchten-Kollektion aus hochwertigem Aluminium in modernem Finish, lieferbar in drei verschiedenen Größen. Ausführungen mit LED und mit fluoreszierenden Lampen, zur Projektion von Licht, ohne Abstriche am modernen und kompakten Design.
- Nuova e moderna collezione di applique da superficie disponibile in tre diversi formati e realizzata in alluminio di alta qualità. Versione con fonte luminosa led e fluorescente studiata con l'intenzione di proiettare la luce senza per questo rinunciare a un design moderno e compatto.
- Inovadora coleção de apliques de superfície modernos disponível em três tamanhos diferentes e realizada em alumínio de alta qualidade. Versões em LED e em fluorescência especialmente desenhadas para projectar luz sem renunciar a um desenho moderno e compacto.

® Registration number: Pending

 **MODULO**   
**ELECTRO**  
[www.modulelectro.ru](http://www.modulelectro.ru)





**MODUL**  
ELECTRO  
[www.modulelectro.ru](http://www.modulelectro.ru)

Materiales / Materials



Especificaciones / Specifications



Acabados / Finishes

- 34 Gris
- Grey
- Gris
- Grau
- Grigio
- Cinzeno

(NEW)

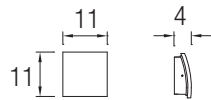

**05-9483-34-37 ■**

3W LED 100-240V CREE Neutral white 4500K

IP 65 4 IK 08

EAGLE RISE **Included**



# MODULO

## ELECTRO

[www.moduloelectro.ru](http://www.moduloelectro.ru)

(NEW)

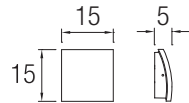

**05-9484-34-37 ■**

2 x 3W LED 230V CREE Neutral white 4500K

IP 65 4 IK 08

EAGLE RISE **Included**



(NEW)

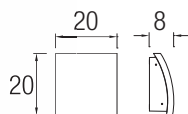

**05-9485-34-T2 ■**

GX24d-3 26W fluorescent

IP 65 4 IK 04

BAG **Included**





## Darwin collection ®

- Luminaria polivalente para uso en pared o techo. Cuerpo y difusor de policarbonato, por lo que resulta idóneo para instalación en zonas con alto riesgo de corrosión. Se puede complementar con accesorio embellecedor. Especialmente dimensionado para uso de lámparas de bajo consumo.
- Multi-purpose light to use on walls or ceilings. Body and diffuser made of polycarbonate, making it ideal for installation in areas with a high risk of corrosion. It can be complemented with a decorative accessory. Specially designed to use low energy lights.
- Lampe polyvalente pour mur ou plafond. Corps et diffuseur en polycarbonate qui en font une lampe idéale pour être installée dans des zones à haut risque de corrosion. Peut être complétée par un accessoire enjoliveur. Spécialement dimensionnée pour l'utilisation d'ampoules à économie d'énergie.
- Mehrzwecklampe für Wand- oder Deckenmontage. Körper und Diffusor aus Polycarbonat, weshalb sich die Lampe hervorragend für die Montage an Orten mit hohem Verschleißrisiko eignet. Sie kann mit einer Zierkappe ergänzt werden. Besonders für die Verwendung von Energiesparlampen ausgerüstet.
- Lampada polivalente per installazione a parete o a soffitto. Corpo e diffusore in policarbonato, idoneo per l'installazione in zone ad alto rischio di corrosione. Si può integrare con accessorio decorativo. Disegnato in modo che possano essere usate lampadine a basso consumo.
- Luminária polivalente para aplicação em parede ou tecto. Corpo e difusor em policarbonato, pelo que pode ser instalada em zonas onde exista alto risco de corrosão. Pode-se complementar com acessório embelezador. Especialmente dimensionada para uso de lâmpadas de baixo consumo.

® Registration number: 001186621-044

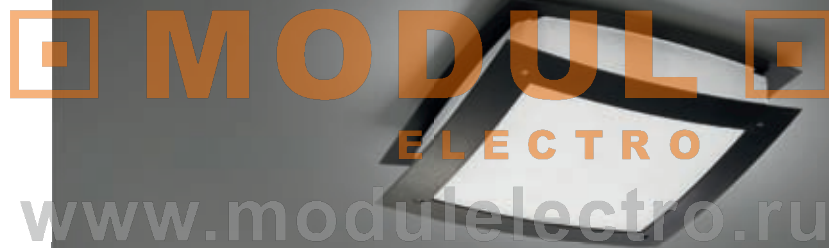

Materiales / Materials



Especificaciones / Specifications

□ ▽ CE RF 850° IP 54 ENERGY SAVING IK 10

Acabados / Finishes

■ Z5 Gris urbano  
Urban grey  
Gris urbain  
Anthrazit  
Grigio urbano  
Cinzeno urbano



**05-9444-Z5-M3** ■

PL elect. E-27 max. 23W



IP 54 6 IK 10

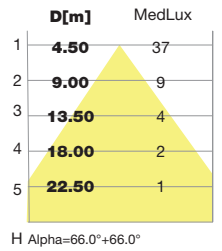
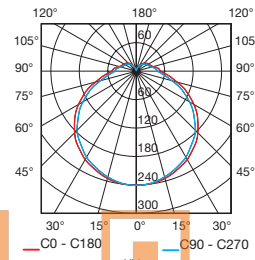

**MODULO ELECTRO**  
www.modulelectro.ru



2 posiciones de instalación.  
2 installation positions.  
2 positions d'installation.  
2 Stellungen zur Installation (Einbaustellungen).  
2 posizione d'installazione  
2 posições de instalação.

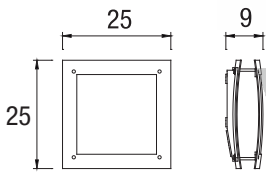

**71-9445-Z5-Z5**



Accesorio para 05-9444  
Accessory for 05-9444

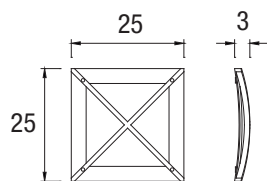



## Windows collection ®

- Luminaria realizada en aluminio de alta calidad y con difusor de cristal satinado. Equipo de bajo consumo integrado.
- Light fitting made from high quality aluminium with satin glass diffuser. Integrated energy saving equipment.
- Luminaire réalisé en aluminium de haute qualité avec un diffuseur en verre satiné. Equipement à économie d'énergie intégré.
- Leuchte, die aus hochwertigem Aluminium hergestellt und mit einem Diffusor aus satiniertem Glas ausgestattet ist. Integriertes Energiesparsystem.
- Lampada realizzata in alluminio di alta qualità e con diffusore in cristallo satinato. Gruppo a basso consumo integrato.
- Luminária concebida feito em alumínio de alta qualidade e com difusor em vidro acetinado. Equipamento para baixo consumo integrado.

® Registration number: 001186621-046



Materiales / Materials



Especificaciones / Specifications



Acabados / Finishes

- Z5 Gris urbano
- Urban grey
- Gris urbain
- Anthrazit
- Grigio urbano
- Cinzeno urbano



**05-9410-Z5-B8** ■

GX24d-3 26W Fluorescent

IP 44 4 IK 04

**Included**

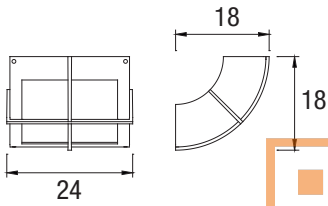
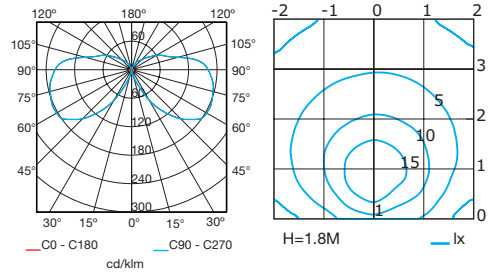

**MODULO**  
ELECTRO

[www.modulelectro.ru](http://www.modulelectro.ru)

# CURIE



Design by Josep Patsí

## Curie collection ®

- Luminaria realizada en aluminio de alta calidad y con difusor de policarbonato. Disponible en dos tamaños y acabados diferentes de gris. Equipo de bajo consumo integrado.
- High quality aluminium illumination, provided with a polycarbonate diffuser. Two sizes and different grey finishes available. Integrated low consumption equipment.
- Luminaire fabriqué en aluminium de grande qualité et muni d'un diffuseur en polycarbonate. Disponible en deux formats et en plusieurs camaïeux de gris. Dispositif basse consommation intégré.
- Leuchte aus hochwertigem Aluminium mit Diffusor aus Polykarbonat. Lieferbar in zwei Größen und zwei verschiedenen Grautönen. Einschließlich Niedrigverbrauch-Aggregat.
- Lampada realizzata in alluminio di alta qualità e con diffusore di policarbonato. Disponibile in due misure e finiture in varie tonalità di grigio. Impianto di basso consumo integrato.
- Lustre realizado em alumínio de alta qualidade e com difusor de policarbonato. Disponível em dois tamanhos e acabamentos diferentes de cinzento. Equipamento de baixo consumo integrado.

® Registration number: 001186621-042

**MODUL**  
ELECTRO  
[www.modulelectro.ru](http://www.modulelectro.ru)

Materiales / Materials



Especificaciones / Specifications



Acabados / Finishes

■ 34 Gris	■ Z5 Gris urbano
Grey	Urban grey
Gris	Gris urbain
Grau	Anthrazit
Grigio	Grigio urbano
Cinzeno	Cinzeno urbano



05-9408-34-M3 ■  
05-9408-Z5-M3 ■

G24d-3 26W fluorescent

IP 65 4 IK 10

Included

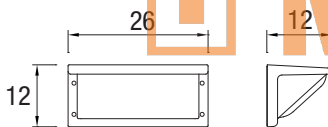
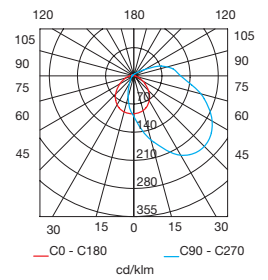

**MODULO**  
**ELECTRO**

[www.modulelectro.ru](http://www.modulelectro.ru)

(New)





05-9457-34-M3 ■  
05-9457-Z5-M3 ■

2 x G24d-3 26W fluorescent

IP 65 4 IK 10

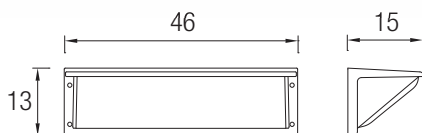
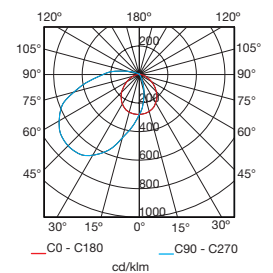
Included





**MODUL**  
ELECTRO  
[www.modulelectro.ru](http://www.modulelectro.ru)

## Galilei collection ®

- Apliques con cuerpo y difusor de policarbonato, por lo que resultan idóneos para instalación en zonas con alto riesgo de corrosión. Serie formada por dos modelos de applique, especialmente dimensionados para uso de lámparas de bajo consumo.
- Fittings with body and diffuser made of polycarbonate, making them ideal for installation in areas with a high risk of corrosion. Range includes two models of fitting, specially designed for use with energy saving lamps.
- Appliques avec corps et diffuseur en polycarbonate, idéales pour être installées dans des zones à haut risque de corrosion. Série comprenant deux modèles d'appliques, spécialement dimensionnés pour l'utilisation d'ampoules à économie d'énergie.
- Wandleuchten mit Körper und Diffusor aus Polycarbonat, weshalb sie sich auszeichnet für die Montage an Orten mit hohem Verschleißrisiko eignen. Eine Serie, die aus zwei Wandlampenmodellen besteht und besonders für die Verwendung von Energiesparlampen ausgerüstet ist.
- Applique con corpo e diffusore in policarbonato, idonea per l'installazione in zone ad alto rischio di corrosione. Serie formata da due modelli di applique, disegnati in modo che si possano utilizzare lampadine a basso consumo.
- Apliques com corpo e difusor em policarbonato, pelo que podem ser instalados em zonas com alto risco de corrosão. Série composta por dois modelos de applique, especialmente dimensionados para o uso de lâmpadas de baixo consumo.

**MODUL** ® Registration number: 001186621-043

**ELECTRO**

[www.modulelectro.ru](http://www.modulelectro.ru)







Materiales / Materials



Especificaciones / Specifications



Acabados / Finishes

■ 34 Gris	■ Z5 Gris urbano
Grey	Urban grey
Gris	Gris urbain
Grau	Anthrazit
Grigio	Grigio urbano
Cinzeno	Cinzeno urbano

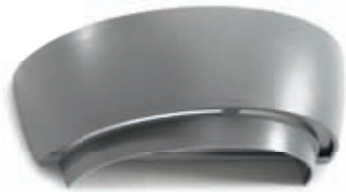

**05-9409-34-M3** ■  
**05-9409-Z5-M3** ■

PL elect. E-27 max. 23W

IP 54 10 IK 08

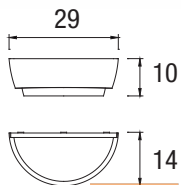
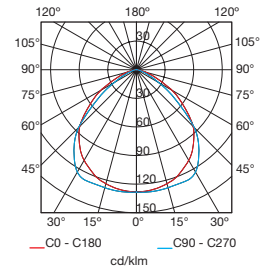

**MODULO**  
**ELECTRO**

[www.modulelectro.ru](http://www.modulelectro.ru)



**05-9415-Z5-M3** ■

PL elect. E-27 max. 23W

IP 54 6 IK 10

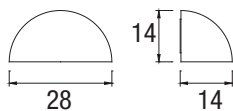

# AJAX



Design by Manel Llusçà

## Ajax collection ®

- Serie formada por una gran variedad de apliques contemporáneos realizados en acero inoxidable y con difusor en policarbonato. Uno de los modelos incorpora un sensor de movimiento a la luminaria.
- A collection that includes a wide range of contemporary wall fixtures, made of stainless steel and with a polycarbonate diffuser. One of the models comes with a movement sensor on the luminaire.
- Une série composée d'une grande variété de lampes appliques contemporaines en acier inoxydable avec diffuseur en polycarbonate. Un des modèles comprend un senseur de mouvement.
- Eine Produktserie, bestehend aus einer großen Vielfalt von modernen Wandleuchten, die aus rostfreiem Stahl hergestellt sind und über einen Diffusor aus Polykarbonat verfügen. In einem der Modelle ist ein Bewegungssensor eingebaut.
- Serie formata da una grande varietà di applique dal design contemporaneo realizzate in acciaio inossidabile e con diffusore in policarbonato. Uno dei modelli incorpora alla luminaria un sensore di movimento.
- Série composta por uma grande variedade de apliques contemporâneos feitos em aço inoxidável e com difusor em policarbonato. Um dos modelos incorpora um sensor de movimento no aparelho de iluminação.

® Registration number: 000835277-0035 / 001091375-023 / 001091375-024 / 000504063-0012



**MODULO**  
ELECTRO  
[www.modulelectro.ru](http://www.modulelectro.ru)

Materiales / Materials



Especificaciones / Specifications



Acabados / Finishes

- J6 Marrón
- Brown
- Marron
- Braun
- Marrone
- Castanho

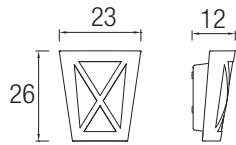

05-9373-J6-M3 ■

E-27 max. 60W

PL elect. E-27 max. 30W

IP 54

18W Included

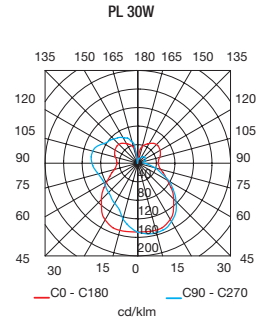

**MODULO**  
ELECTRO

[www.modulelectro.ru](http://www.modulelectro.ru)



Materiales / Materials



Especificaciones / Specifications



Acabados / Finishes

■ J6 Marrón Brown Marron Braun Marrone Castanho	■ Y4 Acero inoxidable Stainless steel Acier inoxydable Rostfreier Stahl Acciaio inossidabile Aço inoxidável
--	--

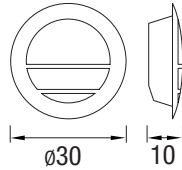

05-9288-J6-M1 ■  
05-9288-Y4-M1 ■

E-27 max. 60W  
PL elect. E-27 max. 23W

IP 54

18W Included

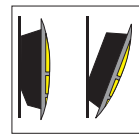

2 posiciones de instalación.  
2 installation positions.  
2 positions d'installation.  
2 Stellungen zur Installation (Einbaustellungen).  
2 posizione d'installazione  
2 posições de instalação.

PL 23W

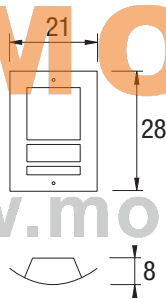
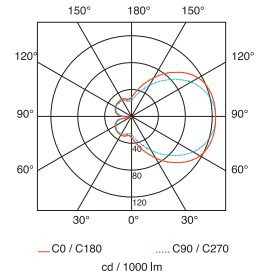

05-9207-J6-M1 ■  
05-9207-Y4-M1 ■

E-27 max. 60W  
PL elect. E-27 max. 23W

IP 44

18W Included

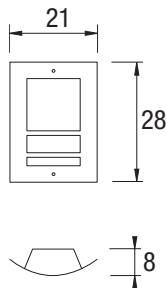
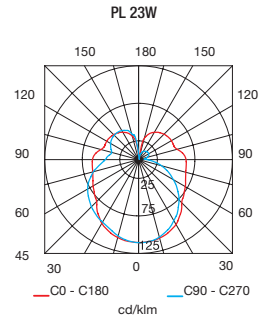

05-9236-Y4-M1 ■

E-27 max. 60W  
PL elect. E-27 max. 23W

IP 44

18W Included



Sensor de movimiento + crepuscular  
Movement + dusk sensor  
Détecteur de mouvement + crépusculaire  
Bewegungssensor + Dämmerungssensor  
Con sensore di movimento + crepuscolare  
Com sensor de movimento + crepuscular

PL 23W

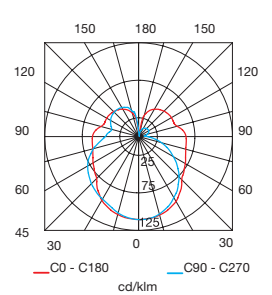

MUY IMPORTANTE consulte la tabla de usos y mantenimiento en la página 290  
VERY IMPORTANT please consult the table on use and maintenance on page 290  
TRÈS IMPORTANT consultez la table d'utilisation et de maintenance de la page 290

WICHTIG Bitte beachten Sie die Tabelle der Gebrauchs- und Instandhaltungsanweisungen auf Seite 290  
MOLTO IMPORTANTE si consulti la tabella di uso e manutenzione a pagina 290  
MUITO IMPORTANTE consulte a tabela de uso e manutenção na página 290

# ECLIPSE

® Registration number: 000835277-0032 / 000835277-0031

## Materiales / Materials



## Especificaciones / Specifications

⊕ ⚡ IP 54 CE ENERGY SAVING IK 10

## Acabados / Finishes

■ 34 Gris	■ Z5 Gris urbano
Grey	Urban grey
Gris	Gris urbain
Grau	Anthrazit
Grigio	Grigio urbano
Cinzeno	Cinzeno urbano



□ 05-9300-34-M3 ■ (S)  
 □ 05-9300-Z5-M3 ■ (S)

⦿ 2 x E-27 max. 40W

⦿ 2 x PL elect. E-27 max. 23W

IP 54 ⚡ 6 ENERGY SAVING IK 10

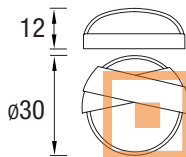
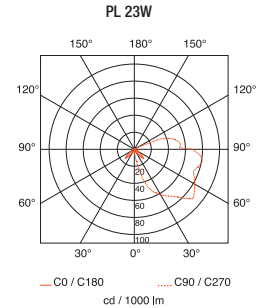

# MODULO

## ELECTRO



□ 05-9301-34-M3 ■ (S)  
 □ 05-9301-Z5-M3 ■ (S)

⦿ E-27 max. 60W

⦿ PL elect. E-27 max. 23W

IP 54 ⚡ 6 ENERGY SAVING IK 10

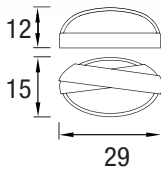
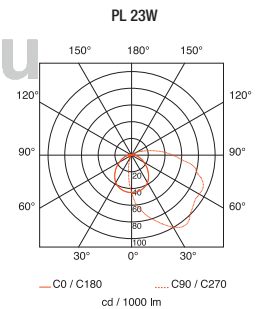

□ 15-9300-34-M3 ■  
 □ 15-9300-Z5-M3 ■ (S)

⦿ 2 x G24d-3 26W fluorescent

IP 54 ⚡ 6 ENERGY SAVING IK 10

Included

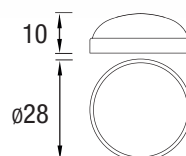
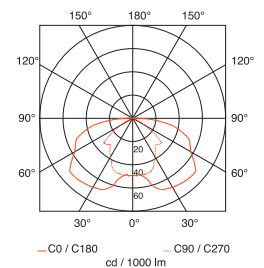

# ZEUS

Materiales / Materials	Especificaciones / Specifications	Acabados / Finishes																		
	IP 44	<table border="0"> <tr> <td> 34 Gris</td> <td> 05 Negro</td> <td> 14 Blanco</td> </tr> <tr> <td>Grey</td> <td>Black</td> <td>White</td> </tr> <tr> <td>Gris</td> <td>Noir</td> <td>Blanc</td> </tr> <tr> <td>Grau</td> <td>Schwarz</td> <td>Weiß</td> </tr> <tr> <td>Grigio</td> <td>Nero</td> <td>Bianco</td> </tr> <tr> <td>Cinzeno</td> <td>Preto</td> <td>Branco</td> </tr> </table>	34 Gris	05 Negro	14 Blanco	Grey	Black	White	Gris	Noir	Blanc	Grau	Schwarz	Weiß	Grigio	Nero	Bianco	Cinzeno	Preto	Branco
34 Gris	05 Negro	14 Blanco																		
Grey	Black	White																		
Gris	Noir	Blanc																		
Grau	Schwarz	Weiß																		
Grigio	Nero	Bianco																		
Cinzeno	Preto	Branco																		

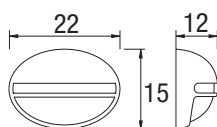

**05-8751-34-M3**
  
**05-8751-05-M3**
  
**05-8751-14-M3**

---

E-27 ø 45 max. 60W

---

IP 44 18

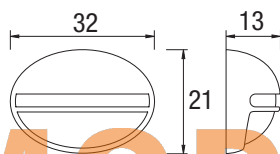

**05-8729-34-M3**
  
**05-8729-05-M3**
  
**05-8729-14-M3**

---

E-27 max. 100W

---

PL elect. E-27 max. 20W - GE

---

IP 44 6

**MODULO**

**ELECTRO**

[www.modulelectro.ru](http://www.modulelectro.ru)

# ATENA

Materiales / Materials	Especificaciones / Specifications	Acabados / Finishes												
	IP 44	<table border="0"> <tr> <td> 34 Gris</td> <td> Z5 Gris urbano</td> </tr> <tr> <td>Grey</td> <td>Urban grey</td> </tr> <tr> <td>Gris</td> <td>Cris urbain</td> </tr> <tr> <td>Grau</td> <td>Anthrazit</td> </tr> <tr> <td>Grigio</td> <td>Grigio urbano</td> </tr> <tr> <td>Cinzeno</td> <td>Cinzeno urbano</td> </tr> </table>	34 Gris	Z5 Gris urbano	Grey	Urban grey	Gris	Cris urbain	Grau	Anthrazit	Grigio	Grigio urbano	Cinzeno	Cinzeno urbano
34 Gris	Z5 Gris urbano													
Grey	Urban grey													
Gris	Cris urbain													
Grau	Anthrazit													
Grigio	Grigio urbano													
Cinzeno	Cinzeno urbano													

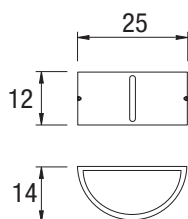

**05-9131-34-M3**
  
**05-9131-Z5-M3**

---

E-27 max. 75W

---

PL elect. E-27 max. 23W

---

IP 44 6

---

18W **Included**



# VULCANO

## Materiales / Materials



## Especificaciones / Specifications



## Acabados / Finishes

-  34 Gris
- Grey
- Gris
- Grau
- Grigio
- Cinzentu

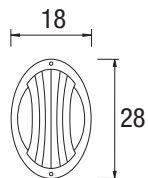

**05-8767-34-M3** ■

 E-27  $\varnothing$  45 max. 60W

 PL elect. E-27 max. 15W - GE

IP 44   12 

# HERCULES. □

## Materiales / Materials



## Especificaciones / Specifications



## Acabados / Finishes

■ 05 Negro Black Noir Schwarz Nero Preto	□ 14 Blanco White Blanc Weiß Bianco Branco
---	---

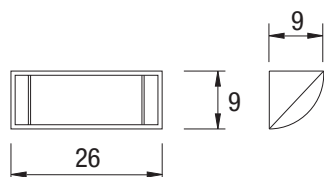

□ 05-8783-05-M3 ■  
□ 05-8783-14-M3 □

⦿ E-27 max. 60W

⦿ PL elect. E-27 max. 23W

IP 44 📦 12 🌿





**MODUL**  
ELECTRO

[www.modulelectro.ru](http://www.modulelectro.ru)

## Delfos collection

- Familia de apliques realizados en aluminio de alta calidad y con difusor de cristal. Disponible en dos acabados diferentes de gris y para distintas fuentes de luz: descarga o fluorescencia.
- Wall lights collection made of high quality aluminium, with a glass diffuser. Two different grey finishes and several light sources available: discharge or fluorescent.
- Famille d'appliques fabriquées en aluminium de grande qualité et munies d'un diffuseur en verre. Disponible en deux coloris gris et pour différentes sources d'éclairage : à décharge ou à fluorescence.
- Wandleuchten-Reihe aus hochwertigem Aluminium mit Glasdiffusor. Lieferbar in zwei verschiedenen Grautönen und für verschiedene Lichtquellen: Entladungslampen oder fluoreszierend.
- Serie di applique realizzate in alluminio di alta qualità e con diffusore di vetro. Disponibile in due toni di grigio e per due tipi di fonte di luce: a scarica o fluorescente.
- Família de apliques realizados em alumínio de alta qualidade e com difusor de cristal. Disponível em dois acabamentos diferentes de cinzento e para diferentes fontes de luz: descarga ou fluorescência.

 Registration number: Pending

 **MODUL**   
ELECTRO  
[www.modulelectro.ru](http://www.modulelectro.ru)





**MODUL**  
ELECTRO  
[www.modulelectro.ru](http://www.modulelectro.ru)

Materiales / Materials



Accesorio reflector  
Reflector accessory

Especificaciones / Specifications

IP 65 CE RF 850° ENERGY SAVING IK 04

Acabados / Finishes

34 Gris  
Grey  
Gris  
Grau  
Grigio  
Cinzeno

Z5 Gris urbano  
Urban grey  
Gris urbain  
Anthrazit  
Grigio urbano  
Cinzeno urbano

(new)

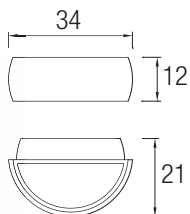

05-9468-34-37 ■  
05-9468-Z5-37 ■

Rx7s-24 150W HID

IP 65 BAG 2 IK 04

BAG Included

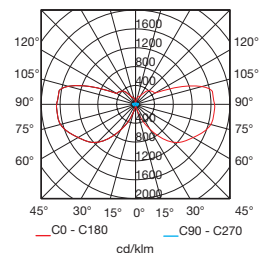

# MODULO ELECTRO

www.modul-electro.ru

(new)

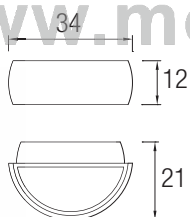

05-9469-34-T2 ■  
05-9469-Z5-T2 ■

2 x G24q-3 26W Fluo

IP 65 BAG 2 IK 04

BAG Included

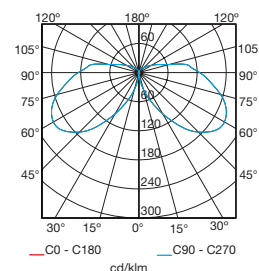

(new)

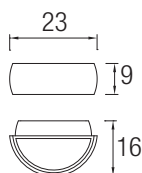

05-9470-34-T2 ■  
05-9470-Z5-T2 ■

GX24d-3 26W Fluo

IP 65 BAG 4 IK 04

BAG Included



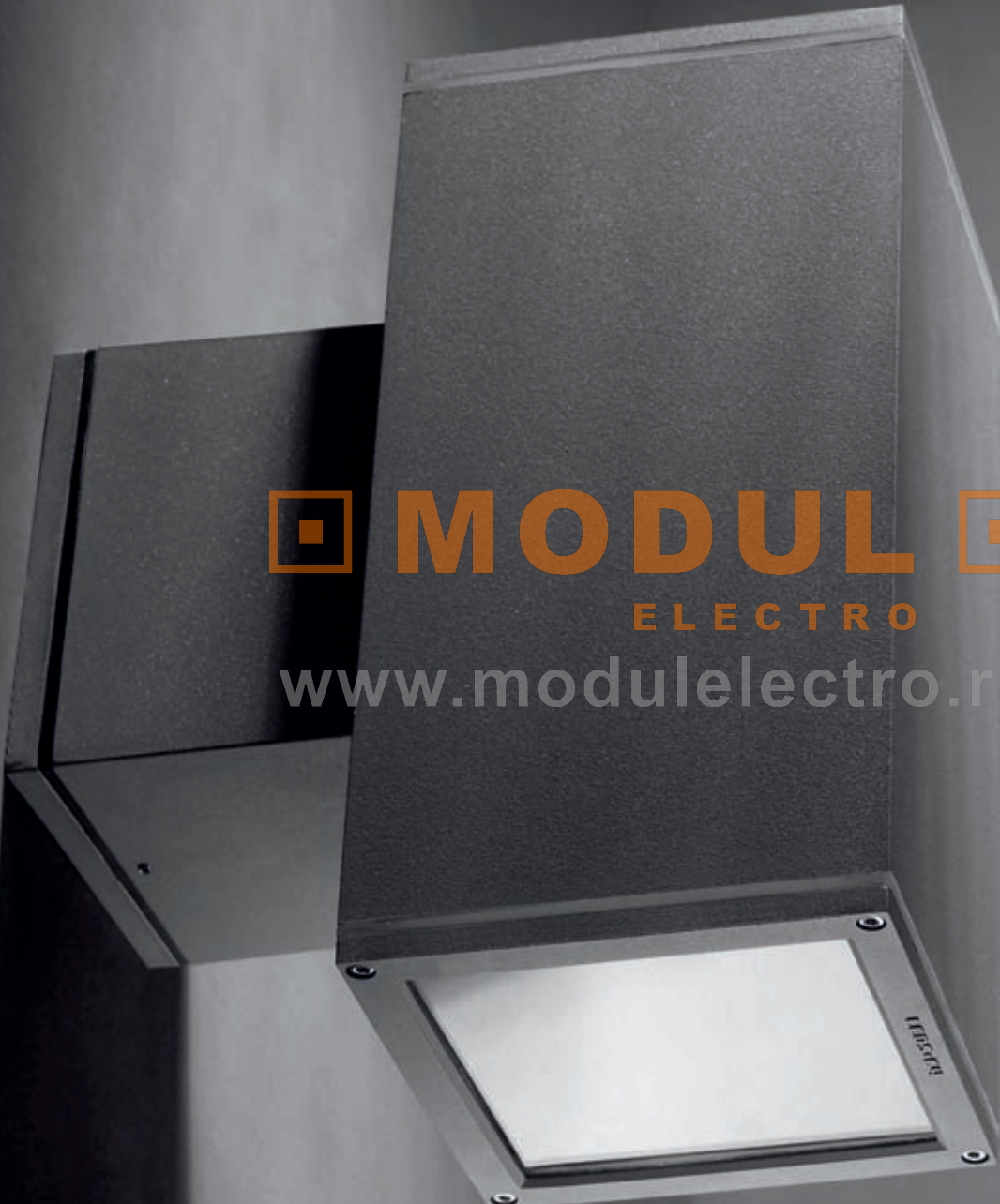



**MODUL**  
ELECTRO  
[www.modulelectro.ru](http://www.modulelectro.ru)

## Afrodita collection

- Colección de apliques de cuidado diseño realizados en aluminio inyectado. La serie está formada por dos plafones y una completa gama de apliques up&down. Disponibles en varios acabados y para diferentes fuentes de luz (fluorescencia, descarga, led y halógena).
- Wall lights collection with a cared design, made of die-cast aluminium. The series consists of two soffits and a complete range of up & down wall light. Several finishes and different lights sources (fluorescent, discharge, led and halogen) available.
- Collection d'appliques au design soigné et en aluminium injecté. La série se compose de deux plafonniers et d'une gamme complète d'appliques à éclairage vers le haut et vers le bas. Disponibles en plusieurs finitions et pour diverses sources d'éclairage (fluorescence, à décharge, à diodes LED et halogène).
- Wandleuchten-Kollektion in ausgefeiltem Design aus Aluminiumguss. Sie Serie besteht aus zwei Deckenleuchten und einer kompletten Palette Up&down-Wandleuchten. In verschiedenen Ausführungen und für verschiedene Lichtquellen erhältlich (fluoreszierend, Entladelampen, LED und Halogen).
- Collezione di applique dal design studiato nei minimi dettagli, realizzate in alluminio pressofuso. La serie è composta da due plafoniere e una gamma completa di applique up&down. Disponibili in varie finiture e per diversi tipi di fonti luminose (fluorescenti, a scarica, led e alogena).
- Colecção de apliques de desenho cuidado realizados em alumínio inyectado. A série está formada por dois tetos e uma completa gama de apliques up&down. Disponíveis em vários acabamentos e para diferentes fontes de luz (fluorescência, descarga, led e halogénico).

 Registration number: 000835277-0033 / 000966874-24

 **MODUL**   
**ELECTRO**  
[www.modulelectro.ru](http://www.modulelectro.ru)







**MODUL**  
ELECTRO  
[www.modulelectro.ru](http://www.modulelectro.ru)

Materiales / Materials



Especificaciones / Specifications



Acabados / Finishes

■ 34 Gris	■ Z5 Gris urbano
Grey	Urban grey
Gris	Gris urbain
Grau	Anthrazit
Grigio	Grigio urbano
Cinzeno	Cinzeno urbano

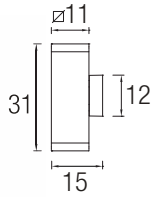

05-9368-34-37 ■  
05-9368-Z5-37 ■

2 x Par-30 E-27 max. 75W

2 x Par-30 E-27 max. 15W Fluo

IP 65 6 IK 06



2 x Par-30 75W

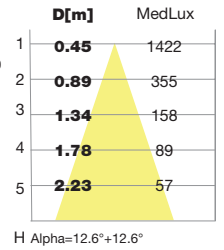
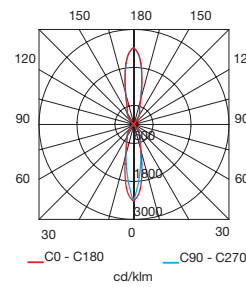

# MODULO ELECTRO

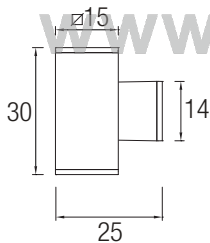

05-9369-34-37 ■  
05-9369-Z5-37 ■

G12 70W HID

IP 65 2 277 IK 08

BAG + Reflector simple y doble  
Double and simple reflector **Included**

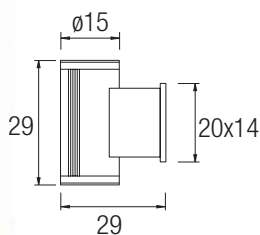
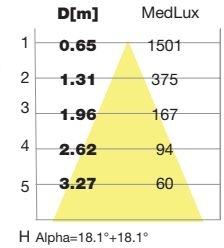
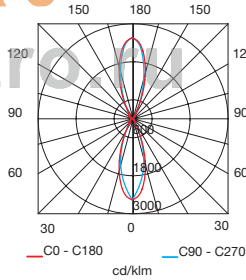

05-9204-34-B8 ■  
05-9204-Z5-B8 ■

G12 70W HID

IP 65 2 IK 08

BAG + Reflector simple y doble  
Double and simple reflector **Included**

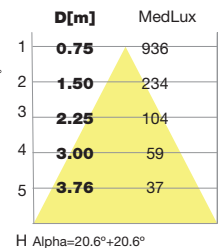
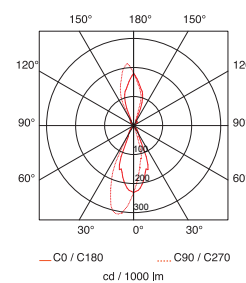

## Materiales / Materials



## Incluido / Included



Accesorio reflector  
Reflector accessory

## Especificaciones / Specifications



## Acabados / Finishes

■ 34 Gris Grey	■ J6 Marrón Brown	■ Z5 Gris urbano Urban grey
■ Gris Grey	■ Marron Brown	■ Gris urbain Urban grey
■ Grau Grey	■ Braun Brown	■ Anthrazit Anthracite
■ Grigio Grey	■ Marrone Brown	■ Grigio urbano Urban grey
■ Cinzento Grey	■ Castanho Brown	■ Cinzento urbano Urban grey



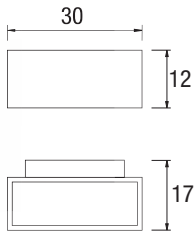

05-9438-34-37 ■  
05-9438-Z5-37 ■

Rx7s 70W HID

IP 65 IK 04

BAG **Included**

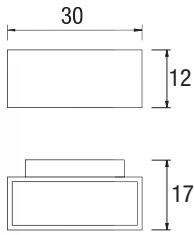
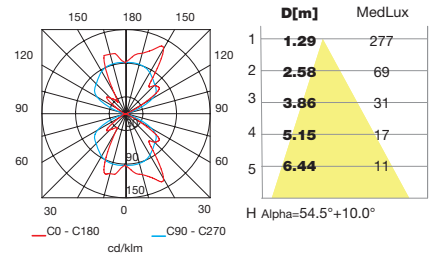

05-9227-34-37 ■  
05-9227-Z5-37 ■

Rx7s-24 150W HID

IP 65 IK 04

BAG **Included**

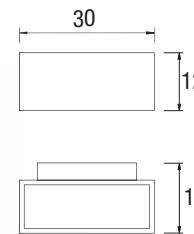
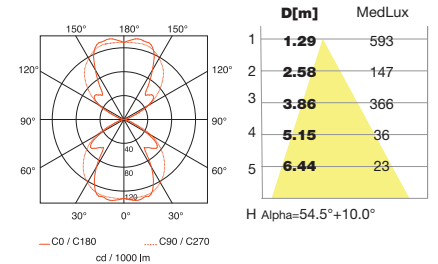

05-9228-34-37 ■  
05-9228-Z5-37 ■

2 x G24q-3 26W Fluo

IP 65 IK 04

BAG **Included**

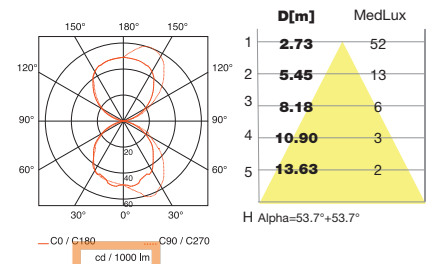

# MODUL

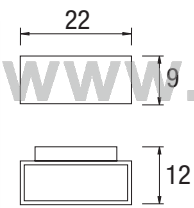

05-9229-34-37 ■  
05-9229-J6-37 ■  
05-9229-Z5-37 ■

R7s L=78 max. 150W Halogen

IP 65 IK 04

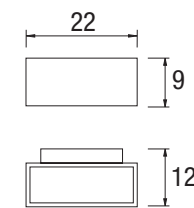
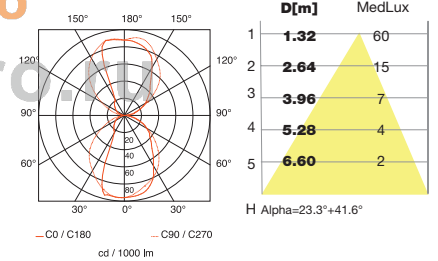

05-9230-34-37 ■  
05-9230-J6-37 ■  
05-9230-Z5-37 ■

1 x G24d-3 26W Fluo

IP 65 IK 04

BAG / VOSSLOH 26W **Included**

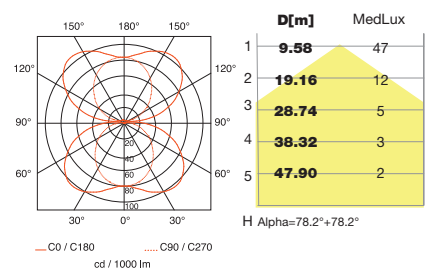

(new)

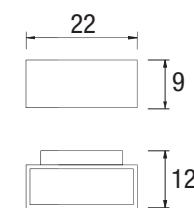

05-9458-34-T2 ■  
05-9458-J6-T2 ■  
05-9458-Z5-T2 ■

8 x 1 W LED 230V EDISON Neutral white 4200K

IP 65 IK 04

EAGLE RISE **Included**





Materiales / Materials



Especificaciones / Specifications



Acabados / Finishes

- 34 Gris Grey Gris Gris Grau Grigio Cinzento
- 25 Gris urbano Urban grey Gris urbain Anthrazit Grigio urbano Cinzento urbano

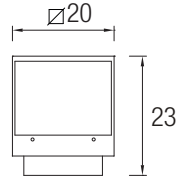

05-9393-34-37 ■  
05-9393-Z5-37 ■

- G12 70W HID
- IP 65
- 2
- 277 IK 08
- BAG + Cristales lupa Magnifying glasses Included

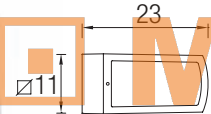
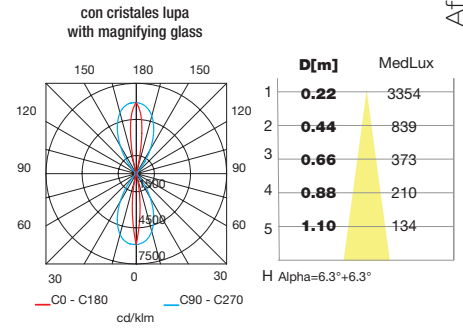
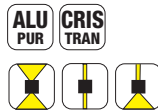

05-9287-34-37 ■  
05-9287-Z5-37 ■

- E-27 max. 100W
- PL elect. E-27 max. 23W
- IP 65
- 6
- IK 05
- 18W + Accesorio reflector Reflector accessory Included

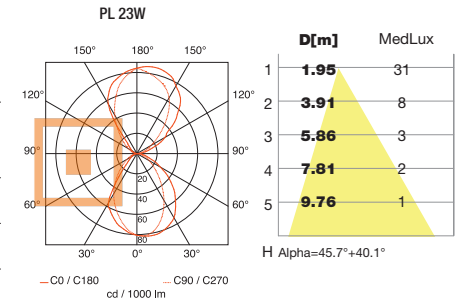
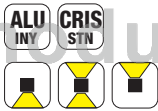

www.modulelectro.ru

(new)

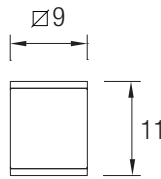

15-9480-34-37 ■  
15-9480-Z5-37 ■

- GU-10 max. 50W
- GU-10 max. 14W Fluorescent
- GU-10 max. 5W LED
- IP 54
- 8
- IK 05

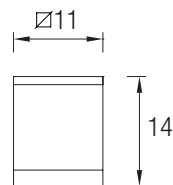
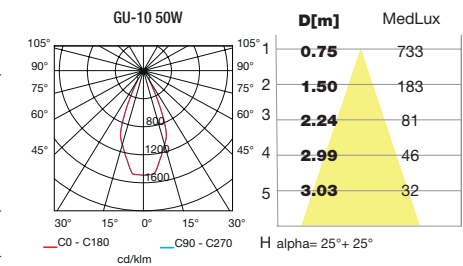

15-9328-34-B8 ■  
15-9328-Z5-B8 ■

- Par-30 E-27 max. 75W
- Par-30 E-27 max. 15W Fluo
- IP 54
- 8
- IK 05

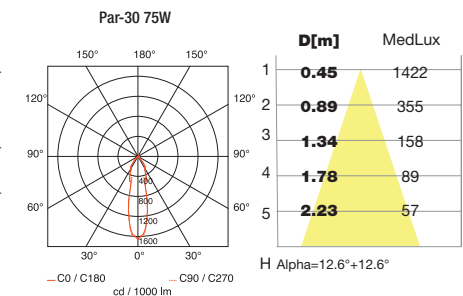



# NEMESIS

Nemesis 70

## Nemesis collection

- Serie de apliques de estilo moderno, con opción de orientar la luz arriba y abajo.
- A collection of modern wall fixtures, with up and down light.
- Une série d'appliques de style moderne, avec faisceau lumineux de haut en bas.
- Ein Produktserie von Wandleuchten im modernem Stil, licht geht nach oben und nach unten.
- Serie di applique di stile moderno, con luce sopra e sotto.
- Série de appliques de estilo moderno, com feixe de luz para cima e para baixo.



 **MODUL**   
ELECTRO  
[www.modulelectro.ru](http://www.modulelectro.ru)

Materiales / Materials



Especificaciones / Specifications



Acabados / Finishes

■ 34 Gris Grey Gris Grau Grigio Cinzentu	■ J6 Marrón Brown Marron Braun Marrone Castanho	■ Z5 Gris urbano Urban grey Gris urbain Anthrazit Grigio urbano Cinzentu urbano
---	--	--

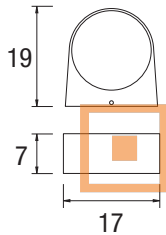

05-9123-34-B8 ■  
05-9123-Z5-B8 ■

E-27  $\phi$  45 max. 60W  
PL elect. E-27 max. 15W - GE

IP 44 12

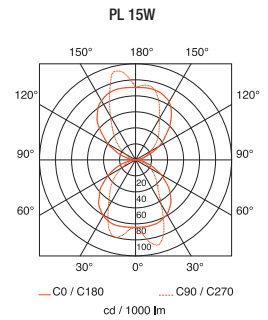

**MODULO**  
ELECTRO

www.modulelectro.ru

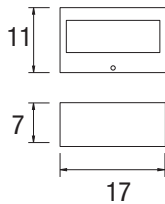

05-9177-34-B8 ■  
05-9177-J6-B8 ■  
05-9177-Z5-B8 ■

R7s L=78 max. 100W

IP 44 12 IK 06

R7s L=78 100W OSRAM **Included**

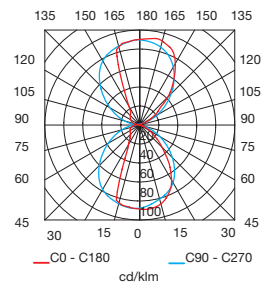

set completo para uso con PL G24d-1 / complete set to use with PL G24d-1

**05-9177 + 71-8969-00-00**





**71-8969-00-00**

Reactancia para PL G24d-1 13W  
Ballast for PL G24d-1 13W



## Fenix collection

- Serie realizada en aluminio inyectado y difusor de cristal transparente. Tres modelos de apliques con dos acabados diferentes y con la posibilidad de direccionar la luz. Hay una versión para halogenuros metálicos con equipo integrado.
- A series made of die-cast aluminium, with a transparent glass diffuser. Three wall fixture models with two different finishes, with the possibility of directing light. There is a version of metal halide lamps with equipment included.
- Série fabriquée en aluminium injecté avec un diffuseur en verre transparent. Trois modèles d'appliques disponibles dans deux finitions différentes et avec la possibilité d'orienter la lumière. Il existe une version avec des lampes halogène métallique avec équipement compris.
- Diese Serie ist aus Aluminiuminjektion hergestellt und mit einem Lichtverteiler aus durchsichtigem Glas versehen. Zur Verfügung stehen drei Wandleuchtenmodelle in zwei Ausführungsarten, deren Lichtstrahlrichtung reguliert werden kann. Es ist eine Ausfertigung von Halogendampflampen aus Metall mit integrierter Vorrichtung vorhanden.
- Serie realizzata in alluminio iniettato con diffusore in cristallo trasparente. Tre modelli di applique con due diverse finiture e possibilità di orientare la luce. Vi è una versione con lampade ad alogenuri metallici e impianto incluso.
- Série feita em alumínio injectado e difusor de vidro transparente. Três modelos de apliques com dois acabamentos diferentes e com a possibilidade de direccionar a luz. Pensados para a utilização de halogenetos metálicos. Uma coleção que se apresenta com equipamentos incluídos.

 **MODUL**   
ELECTRO  
[www.modulelectro.ru](http://www.modulelectro.ru)

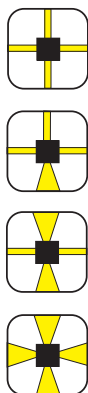
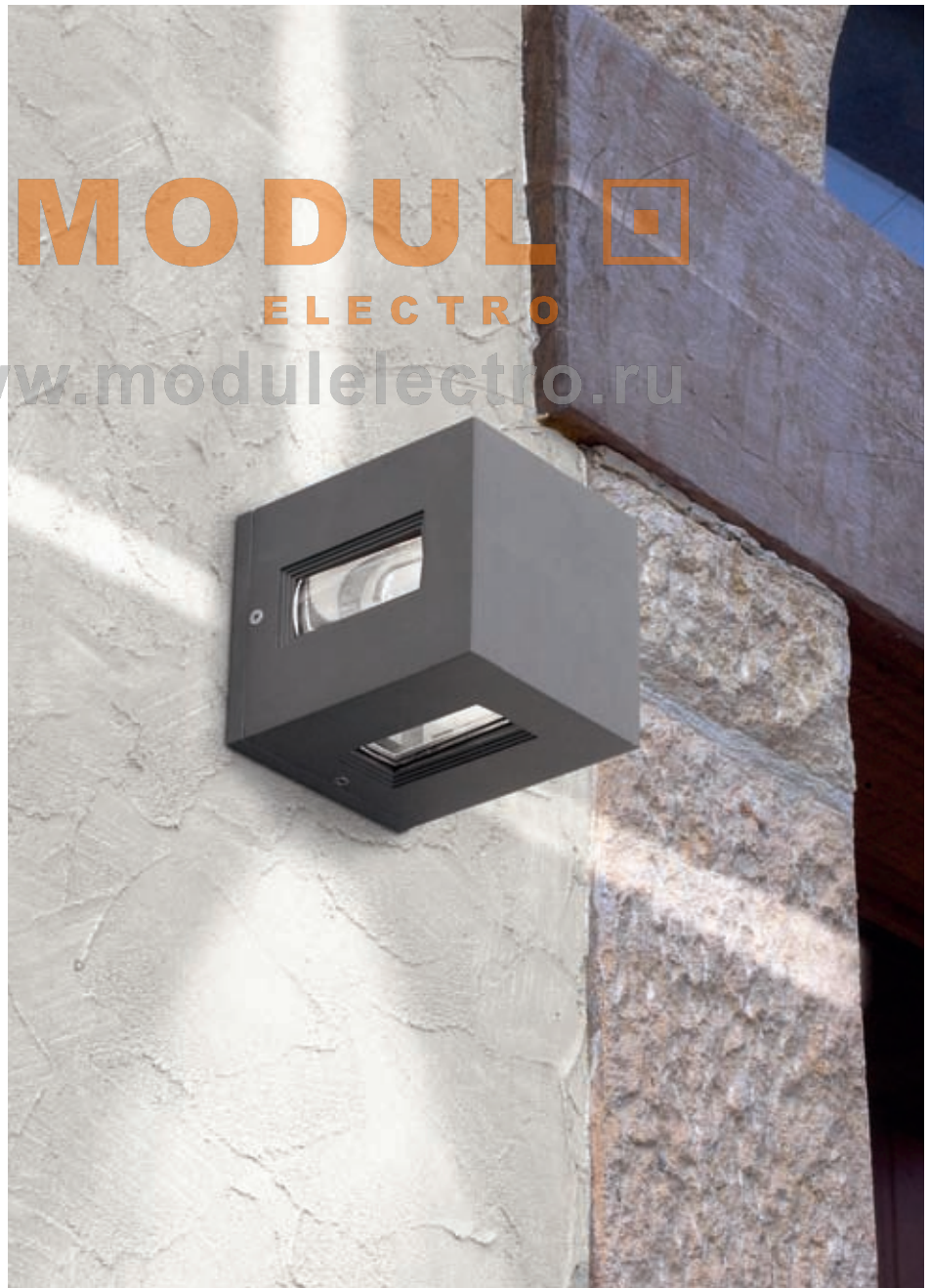

Materiales / Materials



Especificaciones / Specifications

IP 54 CE RF 850° IK 06

Acabados / Finishes

■ 34 Gris	■ Z5 Gris urbano
Grey	Urban grey
Gris	Gris urbain
Grau	Anthrazit
Grigio	Grigio urbano
Cinzeno	Cinzeno urbano

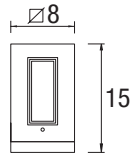

05-9129-34-37 ■  
05-9129-Z5-37 ■

G9 max. 60W

IP 54 6 IK 06

40W OSRAM + Cristales lupa y planos  
Magnifying and flat glasses **Included**

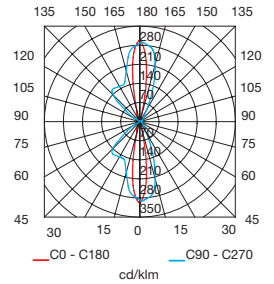
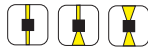

# MODULO

## ELECTRO

www.modulselectro.ru

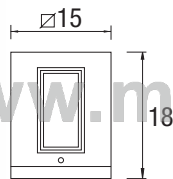

05-9159-34-37 ■  
05-9159-Z5-37 ■

R7s L=78 max. 150W

IP 54 2 IK 06

150W OSRAM + Cristales lupa y planos  
Magnifying and flat glasses **Included**

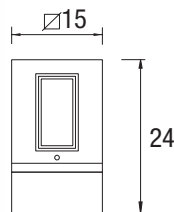
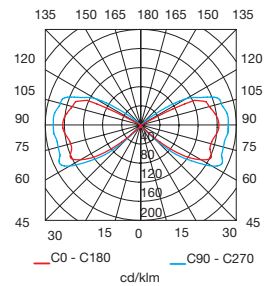

05-9208-34-37 ■  
05-9208-Z5-37 ■

G12 70W HID

IP 54 2 IK 06

BAG + Cristales lupa y planos  
Magnifying and flat glasses **Included**

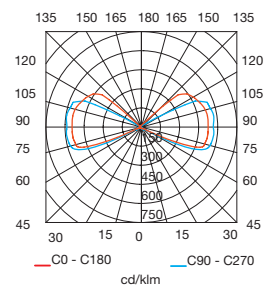



 **MODUL**   
ELECTRO  
[www.modulelectro.ru](http://www.modulelectro.ru)





## Cosmos collection

- Colección realizada en aluminio inyectado y difusor de cristal transparente templado. Serie pensada para el uso de lámparas halogenuros metálicos, fluorescencia y PAR 30.
- A collection made of die-cast aluminium and a tempered glass diffuser. A series designed to be used with: metal halide lamps, fluorescent lamps, and PAR 30 lamps.
- Collection réalisée en aluminium injecté avec diffuseur en verre transparent trempé. La série permet l'utilisation de lampes halogénures métalliques, fluorescentes et PAR 30.
- Diese Kollektion ist aus Aluminiuminjektion hergestellt und mit einem Lichtverteiler aus durchsichtigem gehärteten Glas versehen. Die Modelle der Serie sind für den Gebrauch von Halogendampflampen aus Metall, Leuchtröhren und PAR 30 vorgesehen.
- Collezione realizzata in alluminio iniettato con diffusore di cristallo trasparente temprato. Serie pensata utilizzo di lampade ad alogenuri metallici, fluorescenti e PAR 30.
- Coleção feita em alumínio injectado e difusor de vidro transparente temperado. Série pensada la utilização de lâmpadas halogenetos metálicos, fluorescência e PAR 30.

**MODUL**  
ELECTRO  
[www.modulelectro.ru](http://www.modulelectro.ru)

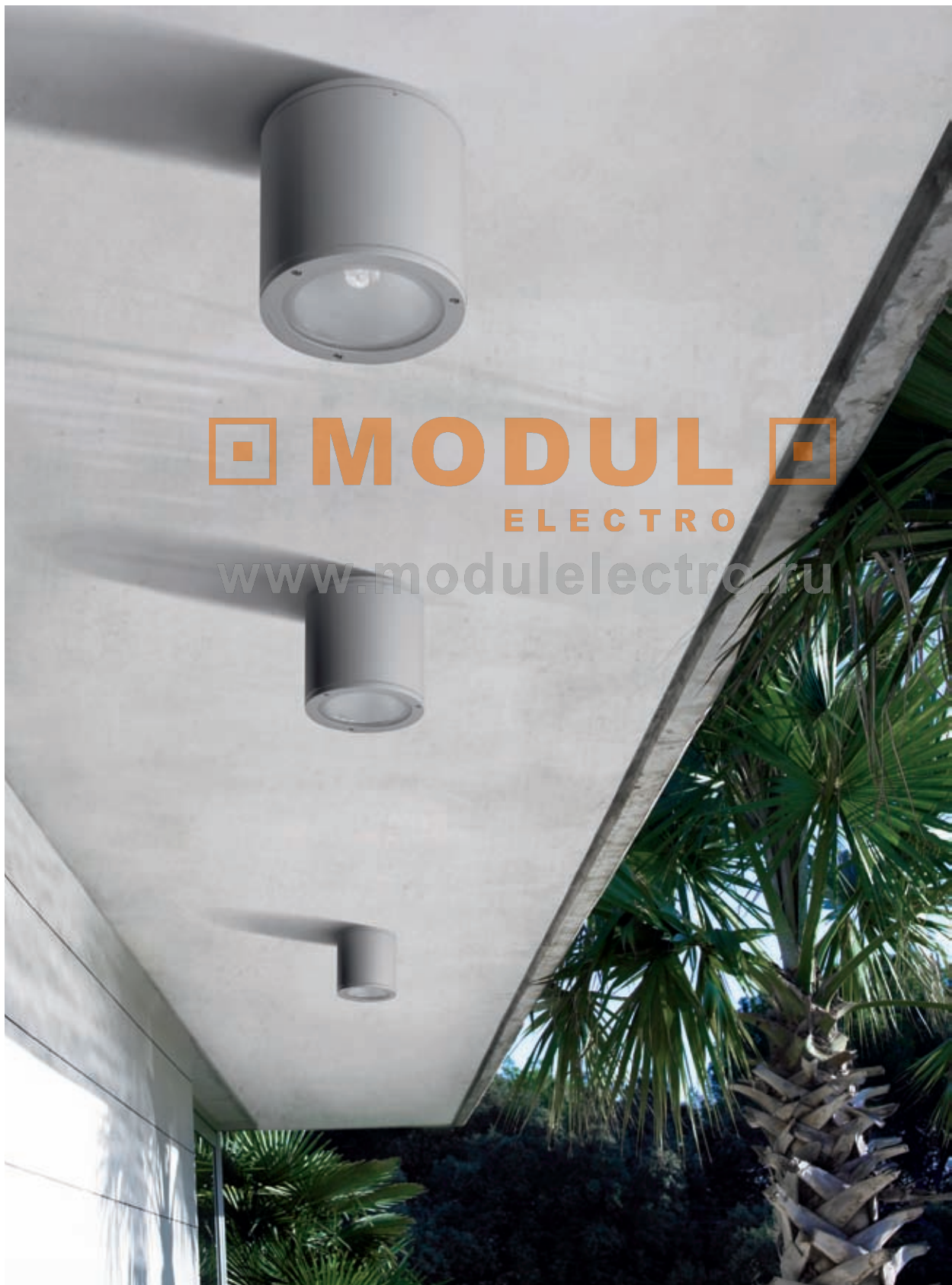



 **MODUL**   
ELECTRO  
[www.modulelectro.ru](http://www.modulelectro.ru)

Materiales / Materials



Especificaciones / Specifications



Acabados / Finishes

- 34 Gris  
Grey  
Gris  
Grau  
Grigio  
Cinzeno
- Z5 Gris urbano  
Urban grey  
Gris urbain  
Anthrazit  
Grigio urbano  
Cinzeno urbano

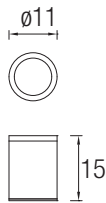

**15-9362-34-37** ■  
**15-9362-Z5-37** ■

Par-30 E-27 max. 75W

Par-30 E-27 15W Fluo

IP 65 6 IK 07



Par-30 75W

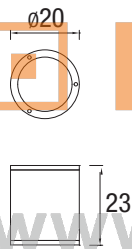
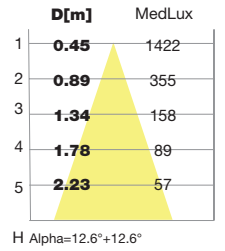
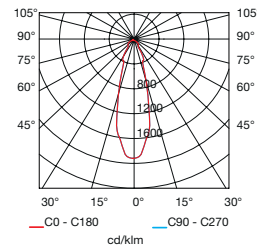

**15-9363-34-37** ■  
**15-9363-Z5-37** ■

Par-38 E-27 max. 80W

PL elect. E-27 max. 30W

Par-38 E-27 max. 23W Fluo

IP 65 4 IK 08



PAR-38 80W

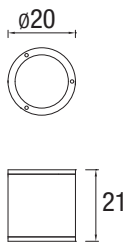
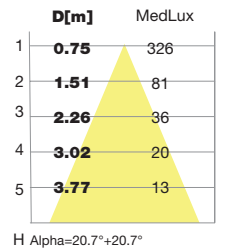
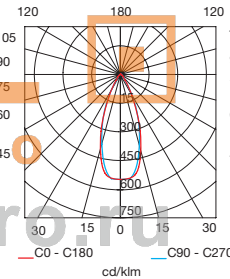

**15-9364-34-37** ■  
**15-9364-Z5-37** ■

G12 70W HID

IP 65 2 IK 08

BAG Included

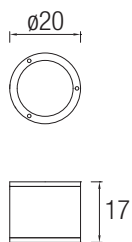
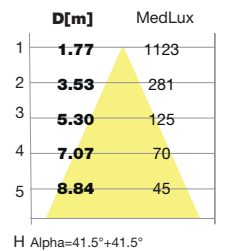
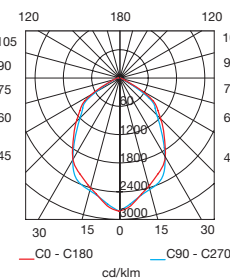



**15-9365-34-T2** ■  
**15-9365-Z5-T2** ■

2 x GX24d-3 26W

IP 65 2 IK 08

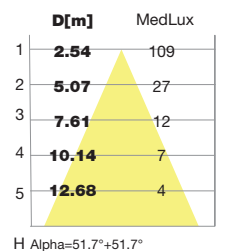
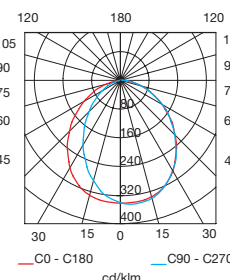
BAG Included





**MODUL**  
ELECTRO  
[www.modulelectro.ru](http://www.modulelectro.ru)



## Hubble collection ®

- Familia de proyectores realizados en aluminio de alta calidad y difusor de cristal templado, pensados para adaptarse a múltiples necesidades, desde pequeñas zonas ajardinadas a grandes fachadas o monumentos. Disponible en 3 tamaños distintos y para distintas fuentes de luz.
- Spotlights collection made of high quality aluminium and a tempered glass diffuser, perfect to suit multiple needs, from little landscaped areas to huge facades and monuments. 3 different sizes and several light sources available.
- Famille de projecteurs fabriqués en aluminium de grande qualité et munis d'un diffuseur en verre trempé, conçus pour s'adapter à différents environnements, depuis les petits espaces verts jusqu'aux vastes façades ou monuments. Disponible en 3 dimensions différentes et pour plusieurs sources d'éclairage.
- Strahlerreihe aus hochwertigem Aluminium und Diffusor aus temperiertem Sicherheitsglas, für vielfältige Einsatzzwecke geeignet, angefangen von kleinen Grünanlagen bis zu großen Fassaden oder Bauwerken. In 3 Größen und für verschiedene Arten von Lichtquellen lieferbar.
- Serie di proiettori realizzati in alluminio di alta qualità e diffusore di vetro temperato, pensati per adattarsi a ogni tipo di esigenza, a partire da piccole zone giardino, fino a grandi facciate e monumenti. Disponibile in tre formati e per diverse fonti di luce.
- Família de projectores realizados em alumínio de alta qualidade e difusor de cristal suave, pensados para se adapta a múltiplas necessidades, desde pequenas zonas ajardinadas a grandes fachadas ou monumentos. Disponível em 3 tamanhos diferentes e para distintas fontes de luz.

® Registration number: 001186621-045

**MODUL**  
ELECTRO  
[www.modulelectro.ru](http://www.modulelectro.ru)







**MODUL**  
ELECTRO  
[www.modulelectro.ru](http://www.modulelectro.ru)

\* Consultar condiciones comerciales.  
\* Consult commercial conditions.  
\* Consulter les conditions commerciales.

\* Handelsbedingungen abfragen.  
\* Consultare le condizioni commerciali.  
\* Consultar condições comerciais.

Materiales / Materials

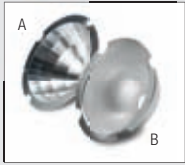

2 reflectores incluidos.  
2 reflectors included.  
2 réflecteurs inclus.  
2 Reflektore inklusive.  
2 riflettori inclusi.  
2 reflectores incluidos

Especificaciones / Specifications



Incluido / Included



Acabados / Finishes

- 34 Gris Grey Gris Gris Grau Grigio Cinzento
- Z5 Gris urbano Urban grey Gris urbain Anthrazit Grigio urbano Cinzento urbano



05-9416-34-37 ■  
05-9416-Z5-37 ■

- GU-10 max. 50W
- GU-10 max. 14W Fluorescent
- GU-10 max. 5W LED

IP 65 6 IK 06  $\phi_{0.5m}$

50W OSRAM **Included**

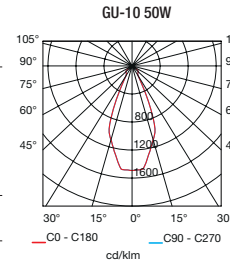

D[m]	MedLux
1	0.75 733
2	1.50 183
3	2.24 81
4	2.99 46
5	3.03 32

H alpha= 25°+ 25°

Visera incluida  
Visor included

(new)

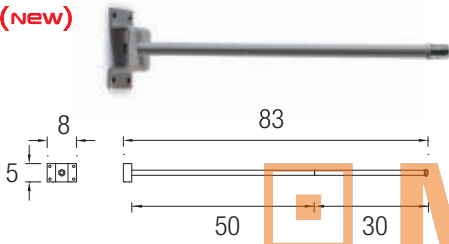

71-9487-34-34 ■  
71-9487-Z5-Z5 ■

Accesorio para 05-9416  
Accessory for 05-9416



**MODULO ELECTRO**

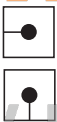

05-9473-34-37 ■  
05-9473-Z5-Z5 ■

- G8,5 20W HID
- IP 65 2 IK 05  $\phi_{0.5m}$

OSRAM **Included**

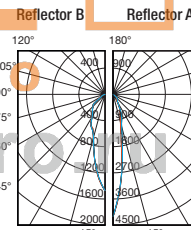

D[m]	MedLux
1	0.50 859 0.29 2503
2	1.00 215 0.58 626
3	1.50 95 0.87 278
4	2.0 54 1.17 156
5	2.49 34 1.46 100

H Alpha=14.0°+14.0° Alpha=8.3°+8.3°

Visera + 2 reflectores incluidos  
Visor + 2 reflectors included

(new)

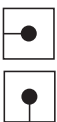
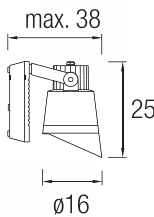

05-9501-34-37 ■  
05-9501-Z5-Z5 ■

- G8,5 35W HID
- IP 65 2 IK 05  $\phi_{0.5m}$

OSRAM **Included**

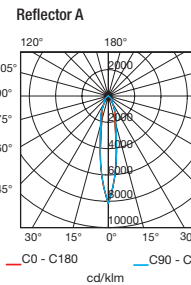

D[m]	MedLux
1	0.29 4860
2	0.58 1215
3	0.87 540
4	1.17 304
5	1.46 194

H Alpha=8.3°+8.3°

Visera + 2 reflectores incluidos  
Visor + 2 reflectors included

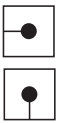
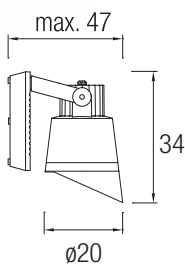

05-9474-34-37 ■  
05-9474-Z5-Z5 ■

- G12 70W HID
- IP 65 2 IK 05  $\phi_{0.5m}$

OSRAM **Included**

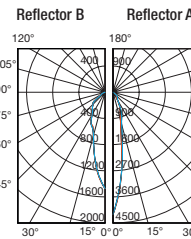

D[m]	MedLux
1	1.05 1709 0.46 6513
2	2.09 427 0.92 1628
3	3.14 190 1.38 724
4	4.18 107 1.85 407
5	5.23 68 2.31 261

H Alpha=26.5°+26.5° Alpha=12.7°+13.3°

Visera + 2 reflectores incluidos  
Visor + 2 reflectors included

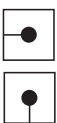

05-9502-34-37 ■  
05-9502-Z5-Z5 ■

- G12 150W HID
- IP 65 2 IK 05  $\phi_{0.5m}$

OSRAM **Included**

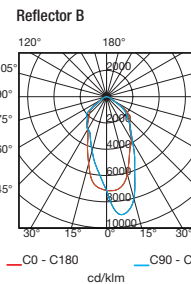

D[m]	MedLux
1	1.05 3742
2	2.09 936
3	3.14 416
4	4.18 234
5	5.23 150

H Alpha=26.5°+28.5°

Visera + 2 reflectores incluidos  
Visor + 2 reflectors included



**MODUL**  
ELECTRO  
[www.modulelectro.ru](http://www.modulelectro.ru)



### O'color collection ®

- Novedosa colección fabricada en aluminio inyectado. Los modelos diseñados según la tendencia más contemporánea incluyen embellecedores de 3 colores distintos y cuentan con protección IP 54. Además, pueden utilizar lámparas halógenas o halogenuros metálicos.
- Innovative collection made of die-cast aluminum. The models designed according to the latest trend include trim with three different colors, and they have IP 54 protection. Additionally, they may use halogen lamps or metal halide lamps.
- Nouvelle collection réalisée en aluminium injecté. Dessinés suivant la tendance la plus actuelle, ces modèles comprennent des enjoliveurs de 3 couleurs différentes et disposent de protection IP 54. De plus, ils peuvent recevoir des lampes halogènes ou des lampes à halogénure métallique.
- Eine neuartige Kollektion, die aus Aluminiuminjektion hergestellt ist. Das Design der Modelle folgt den neuesten modischen Tendenzen. Eingeschlossen sind Verblendungen in 3 verschiedenen Farben und die Modelle verfügen über Schutzvorrichtungen der Klasse IP 54. Sie können mit Halogenlampen und metallischen Halogenidlampen benutzt werden.
- Nuova collezione realizzata in alluminio iniettato. I modelli progettati secondo il trend più attuale includono delle ghiera in 3 colori distinti e prevedono una protezione classe IP 54. Possono inoltre utilizzare lampade alogene o ad alogenuri metallici.
- Coleção inovadora fabricada em alumínio injectado. Os modelos concebidos de acordo com a tendência mais contemporânea incluem embelezadores de 3 cores diferentes e têm protecção IP 54. Além disso, podem utilizar lâmpadas de halogéneo ou halogenetos metálicos.

® Registration number: 001091375-030

**MODUL**  
ELECTRO  
[www.modulelectro.ru](http://www.modulelectro.ru)



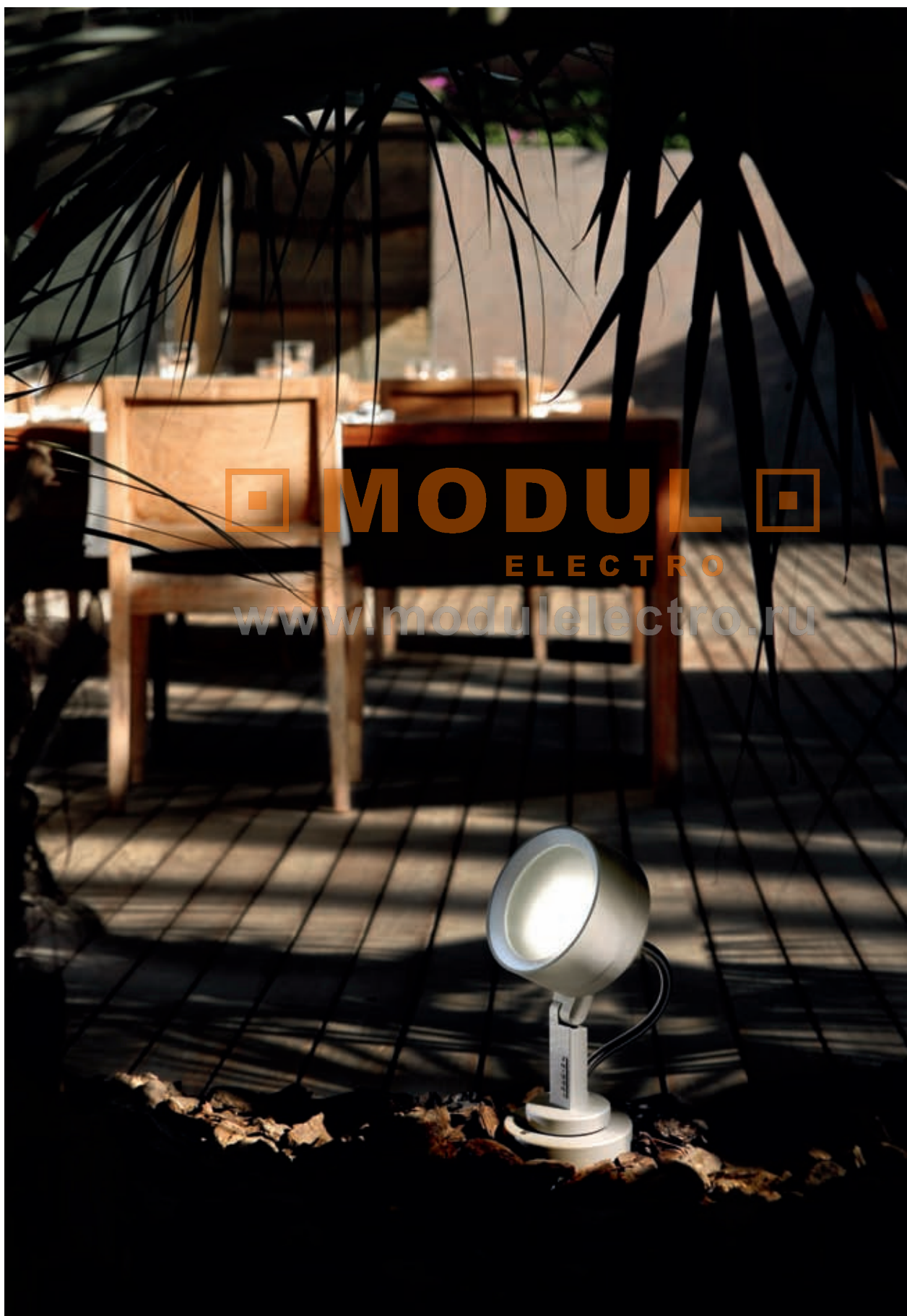

**MODUL**  
ELECTRO  
[www.modulelectro.ru](http://www.modulelectro.ru)

Materiales / Materials



3 aros de colores incluidos  
 3 color rings included  
 3 anneaux de couleur compris  
 3 austauschbare Farbringe inklusive  
 3 anelli di colore inclusi  
 3 aros de cores incluidos

Especificaciones / Specifications



Incluido / Included



Acabados / Finishes

- 34 Gris
- Grey
- Gris
- Grau
- Grigio
- Cinzeno

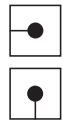
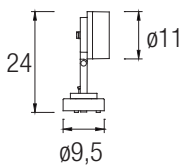

**05-9417-34-T2** ■

GX 53 max. 13W

IP 65 6 IK 04

7W **Included**

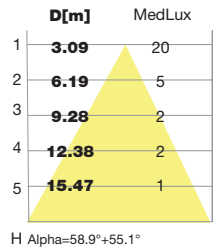
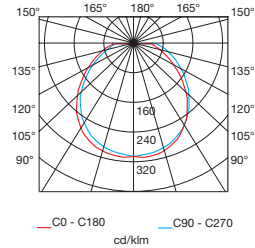

# MODULO ELECTRO

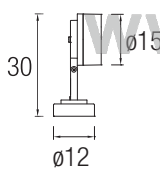

**05-9359-34-T2** ■

R7s L=78 max. 150W

IP 65 4 IK 04

150W OSRAM **Included**

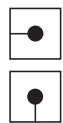
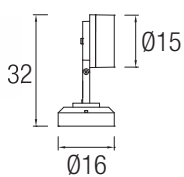
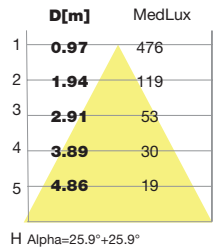
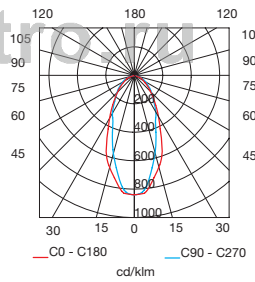

**05-9360-34-T2** ■

G 8.5 35W HID

IP 65 2 IK 04

VOSSLOH / PHILIPS **Included**

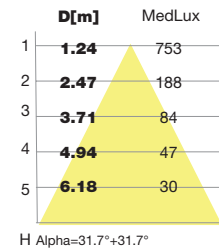
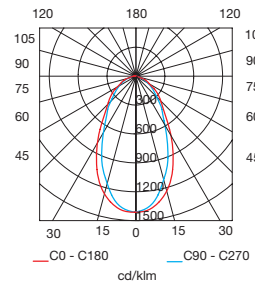

# ALIEN

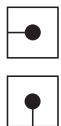

Design by Manel Llusçà

## Alien collection ®

- Los focos Alien se adaptan a todo tipo de ambientes de exterior y requisitos de iluminación gracias a la gran variedad de lámparas disponibles. Adicionalmente, Alien se puede orientar hacia todas direcciones.
- The Alien lights adapt to all kinds of outdoor environments and lighting requirements, thanks to the large variety of available lamps. Alien can also be adjusted in all directions.
- Les spots Alien s'adaptent à tous les types d'espaces extérieurs et aux différents besoins d'illumination grâce à la grande variété de lampes disponibles. De plus, Alien diffuse la lumière dans toutes les directions.
- Die Alien Scheinwerfer passen sich an jegliches Außenambiente und erforderliche Beleuchtungsstärken, dank der großen Auswahl an Lampen, an. Außerdem kann man die Alien Scheinwerfer in alle Richtungen verstellen.
- I riflettori Alien si adattano a ogni tipo di ambiente in esterni e a qualsiasi requisito di illuminazione grazie alla grande varietà di lampade disponibili. Inoltre, Alien si può orientare in tutte le direzioni.
- Os focos Alien adaptam-se a todo o tipo de ambientes de exterior e requisitos de iluminação graças à grande variedade de lâmpadas disponíveis. Adicionalmente o Alien pode ser orientado em todas direções.

® Registration number: 000835277-0030

**MODULO**  
ELECTRO  
[www.modulelectro.ru](http://www.modulelectro.ru)

Materiales / Materials



Incluido / Included



Especificaciones / Specifications



Acabados / Finishes

- 34 Gris Grey Gris Grau Grigio Cinzento
- Z5 Gris urbano Urban grey Gris urbain Anthrazit Grigio urbano Cinzento urbano

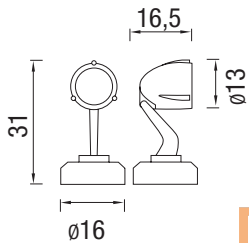

05-9297-34-37 ■  
05-9297-Z5-37 ■

GX 8.5 70W HID

IP 65 4 IK 05

**VOSSL.OH** **Included**

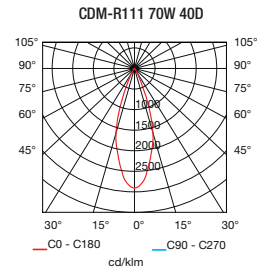

D[m]	MedLux
1	0.17 35670
2	0.34 8917
3	0.51 3963
4	0.68 2229
5	0.85 1427

H Alpha=4.9°+4.9°

# MODULO ELECTRO

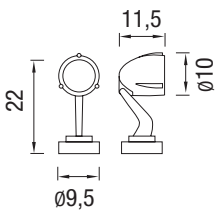

05-9327-34-37 ■  
05-9327-Z5-37 ■

GU-10 max. 50W

GU-10 max. 14W Fluorescent

GU-10 max. 5W LED

IP 65 8 IK 05

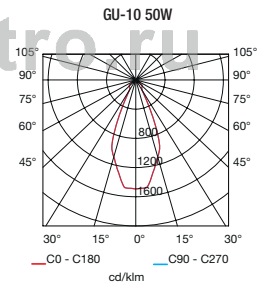

D[m]	MedLux
1	0.75 733
2	1.50 183
3	2.24 81
4	2.99 46
5	3.03 32

H alpha= 25°+ 25°

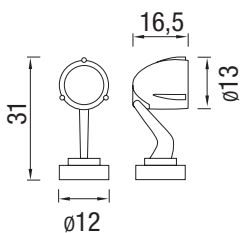

05-9296-34-37 ■  
05-9296-Z5-37 ■

E-27 100W-HAL

Par-30 E-27 max. 75W

Par-30 E-27 max. 15W Fluo

IP 65 4 IK 05

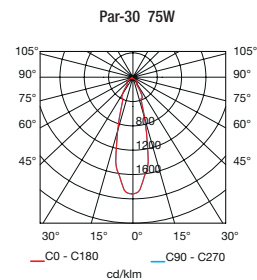

D[m]	MedLux
1	0.52 1513
2	1.05 378
3	1.57 168
4	2.09 95
5	2.62 61

H Alpha=14.7°+14.7°



# SKADE

<b>Materiales / Materials</b> 	<b>Especificaciones / Specifications</b>  	<b>Acabados / Finishes</b> <table border="0"> <tr> <td> 34 Gris</td> <td> Z5 Gris urbano</td> </tr> <tr> <td>Grey</td> <td>Urban grey</td> </tr> <tr> <td>Gris</td> <td>Gris urbain</td> </tr> <tr> <td>Grau</td> <td>Anthrazit</td> </tr> <tr> <td>Grigio</td> <td>Grigio urbano</td> </tr> <tr> <td>Cinzeno</td> <td>Cinzeno urbano</td> </tr> </table>	34 Gris	Z5 Gris urbano	Grey	Urban grey	Gris	Gris urbain	Grau	Anthrazit	Grigio	Grigio urbano	Cinzeno	Cinzeno urbano
34 Gris	Z5 Gris urbano													
Grey	Urban grey													
Gris	Gris urbain													
Grau	Anthrazit													
Grigio	Grigio urbano													
Cinzeno	Cinzeno urbano													
<b>Incluido / Included</b> 														



**05-9107-34-37**  
**05-9107-Z5-37**  
 R7s L=78 max. 150W  
 IP 54 2 IK 08  
 150W OSRAM **Included**

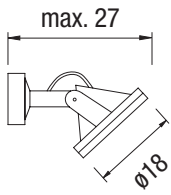
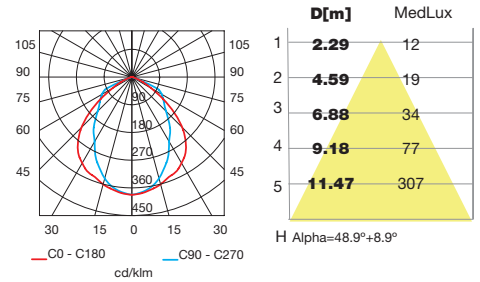

# MODULO

## ELECTRO

[www.modulelectro.ru](http://www.modulelectro.ru)

# EOLO

<b>Materiales / Materials</b> 	<b>Especificaciones / Specifications</b> 	<b>Acabados / Finishes</b> Y4 Acero inoxidable Stainless steel Acier inoxydable Rostfreier Stahl Acciaio inossidabile Aço inoxidável

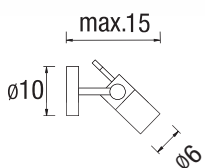

**05-9122-Y4-37**  
 GU-10 max. 50W  
 GU-10 max. 14W Fluorescent  
 GU-10 max. 5W LED  
 IP 54 12

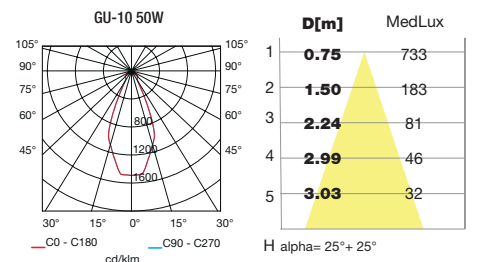

**Materiales / Materials**

**ALU INY** **INOX AISI 304** **CRIS TEMP**

**Especificaciones / Specifications**

☐ ⚡ CE RF 850° IK 08

**Acabados / Finishes**

■ 05 Negro Black Noir Schwarz Nero Preto

■ 34 Gris Grey Gris Grau Grigio Cinzento

■ Y4 Acero inoxidable Stainless steel Acier inoxydable Rostfreier Stahl Acciaio inossidabile Aço inoxidável

**Incluido / Included**

☐



MODULO

ELECTRO

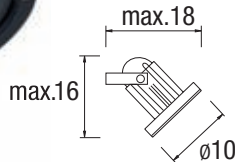

☐ 05-9165-05-37 ■  
☐ 05-9165-34-37 ■

☐ GU-10 max. 50W  
☐ GU-10 max. 14W Fluorescent  
☐ GU-10 max. 5W LED

IP 65 ⚡ 0.5m ⚡ 12 IK 08 🌿

▶ OSRAM 50W **Included**

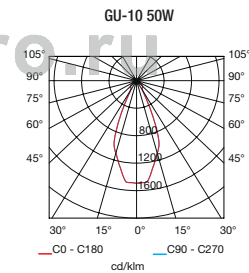

D[m]	MedLux
1	0.75 733
2	1.50 183
3	2.24 81
4	2.99 46
5	3.03 32

H alpha= 25°+ 25°

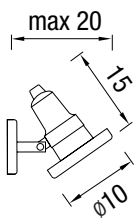

☐ 05-9310-Y4-37 ■

☐ GU-10 max. 50W  
☐ GU-10 max. 14W Fluorescent  
☐ GU-10 max. 5W LED

☐ IP 67 ⚡ 8 IK 08 🌿

▶ OSRAM 50W **Included**

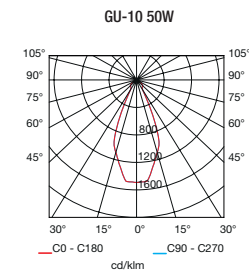

D[m]	MedLux
1	0.75 733
2	1.50 183
3	2.24 81
4	2.99 46
5	3.03 32

H alpha= 25°+ 25°



(new)

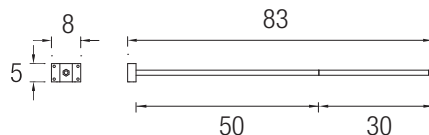

71-9487-34-34 ■  
71-9487-Z5-Z5 ■

☐ 2 Accesorio para 05-9165  
Accessory for 05-9165



**MUY IMPORTANTE** consulte la tabla de usos y mantenimiento en la página 290  
**VERY IMPORTANT** please consult the table on use and maintenance on page 290  
**TRÈS IMPORTANT** consultez la table d'utilisation et de maintenance de la page 290

**WICHTIG** Bitte beachten Sie die Tabelle der Gebrauchs- und Instandhaltungsanweisungen auf Seite 290  
**MOLTO IMPORTANTE** si consulti la tabella di uso e manutenzione a pagina 290  
**MUITO IMPORTANTE** consulte a tabela de uso e manutenção na página 290

# ESPARTA



Esparita 90



## Esparita collection <sup>®</sup>

- La serie Esparita funciona con fluorescencia, aportando una estanqueidad superior, a la vez que es orientable.
- The Esparita collection works with fluorescent lights and offers high leaktightness, and the light can be adjusted.
- La Série Esparita est une série fluorescente offrant à la fois une étanchéité supérieure et une diffusion orientable.
- Die Esparita Produktserie wird mit Leuchtstofflampen betrieben, sie besitzt eine obere Abdichtung und ist gleichzeitig verstellbar.
- La serie Esparita funziona con lampade a fluorescenza, è dotata di superiore tenuta all'acqua e al tempo stesso è orientabile.
- A série Esparita funciona com fluorescência, proporcionando uma estanqueidade superior, sendo também orientável.

<sup>®</sup> Registration number: 001091375-031

**MODUL**  
**ELECTRO**  
[www.modulelectro.ru](http://www.modulelectro.ru)



Materiales / Materials



Incluido / Included



Especificaciones / Specifications



Acabados / Finishes

05 Negro Black Noir Schwarz Nero Preto	34 Gris Grey Gris Grau Grigio Cinzeno	Z5 Gris urbano Urban grey Gris urbain Anthrazit Grigio urbano Cinzeno urbano
---	--	---

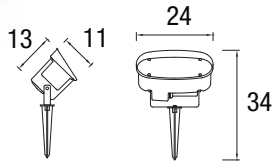

55-9349-Z5-M3 ■

G24d-3 26W Fluo  
IP 65 4 IK 09  
26W Fluo + BAG Included

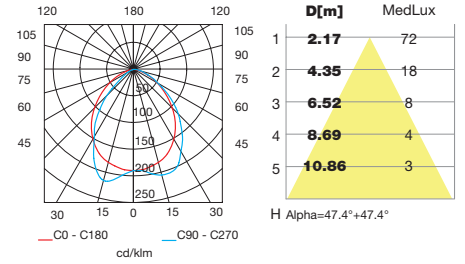

(new)

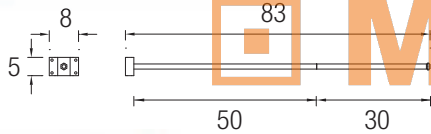

71-9487-34-34 ■  
71-9487-Z5-Z5 ■

Accesorio para 55-9349  
Accessory for 55-9349

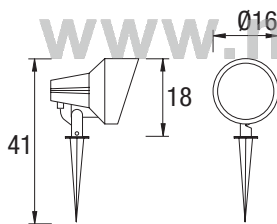

55-9172-34-37 ■

Par-38 E-27 max. 60W  
IP 54 12 IK 08 0.5m  
2.5 m Included

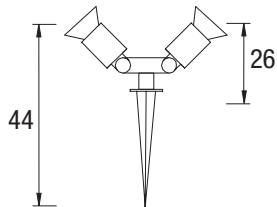
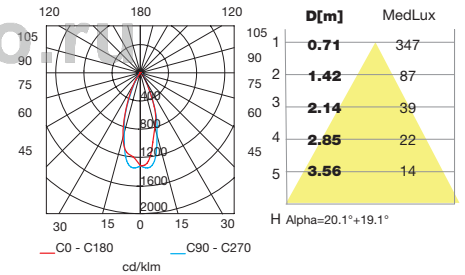

55-8785-05-05 ■

2 x Par-38 E-27 max. 100W  
IP 44 0.5m 18  
2.5 m Included

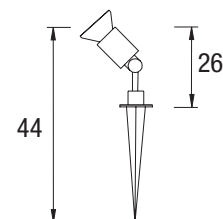

55-8784-05-05 ■

Par-38 E-27 max. 100W  
IP 44 0.5m 18  
2.5 m Included



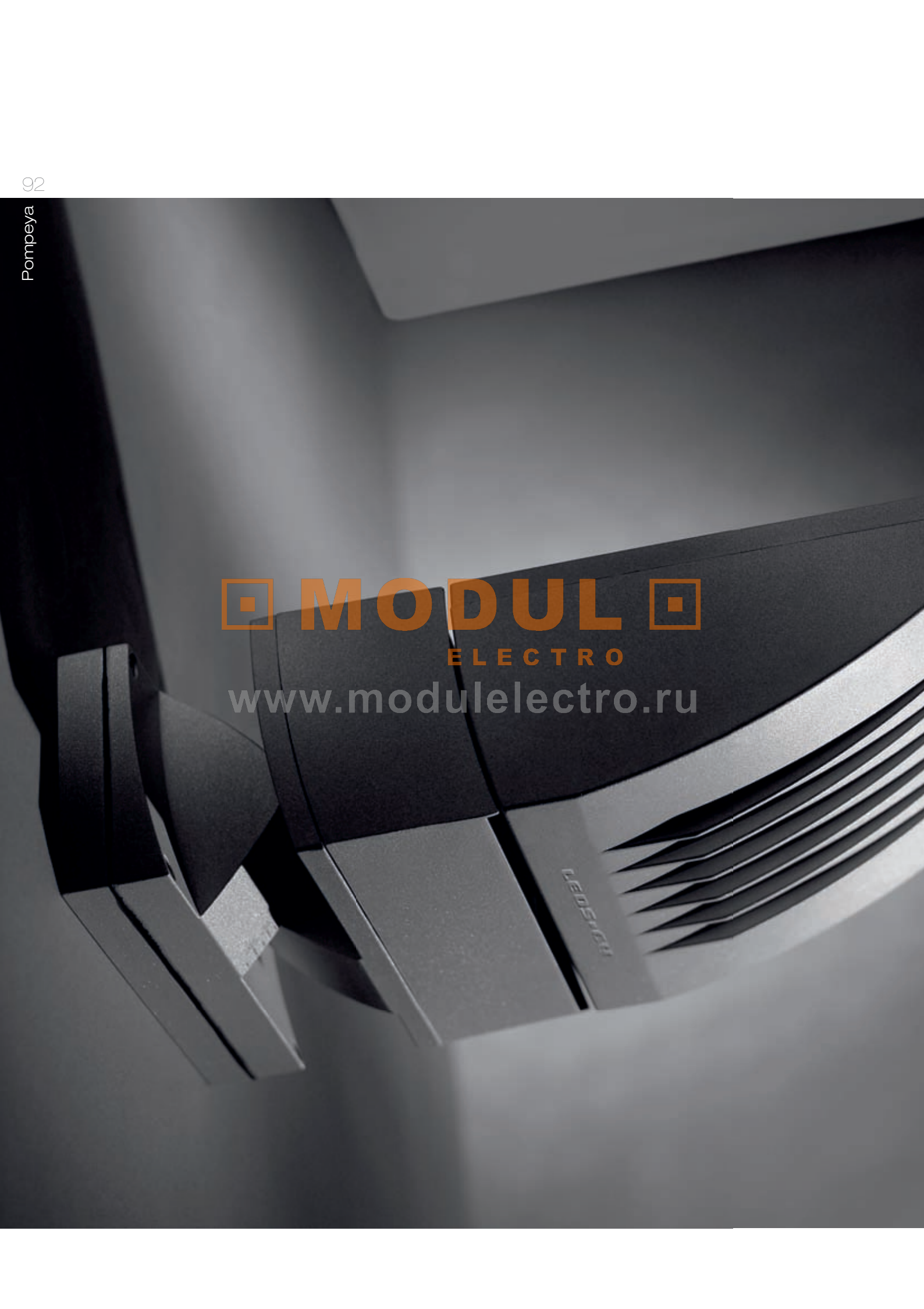

**MODUL**  
ELECTRO  
[www.modulelectro.ru](http://www.modulelectro.ru)



## Pompeya collection ®

- Serie formada por varios modelos de apliques proyectores de altas prestaciones, realizados en aluminio inyectado. La colección está preparada para el uso de diferentes lámparas: fluorescentes, halógenas y halogenuros metálicos.
- A collection of various models of high performance projecting wall fixtures made of die-cast aluminium. The collection is prepared for the use of different lamps: fluorescent, halogen and metal halide.
- Série composée de plusieurs modèles d'appliques/projecteurs, haute performance réalisées en aluminium injecté. La collection est compatible avec différentes lampes: fluorescentes, halogènes et halogénures métalliques.
- Eine Produktserie, die aus mehreren Modellen von Wandprojektoren mit Höchstleistungen besteht und zwei Modellen von Leuchtbacken, gefertigt aus gespritztem Aluminium. Die Kollektion ist für den Gebrauch von verschiedenen Leuchtstoff-, Holgen- und Halogendampflampen aus Metall vorgesehen.
- Serie costituita da vari modelli di applique-proiettori da parete ad alte prestazioni realizzati in alluminio iniettato. La collezione è predisposta per l'uso di lampade a fluorescenza, alogene e ad alogenuri metallici.
- Série composta por vários modelos de apliques projector de parede de altas prestações feitos em alumínio injectado. A coleção está preparada para o uso de diferentes lâmpadas: fluorescentes, de halogéneo e halogenetos metálicos.

® Registration number: 001186621-057 / 001186621-058 / 001186621-059

**MODUL**  
ELECTRO  
[www.modulelectro.ru](http://www.modulelectro.ru)





**MODUL**  
ELECTRO  
[www.modulelectro.ru](http://www.modulelectro.ru)

Materiales / Materials



Especificaciones / Specifications



Acabados / Finishes

- 34 Gris
- Grey
- Gris
- Grau
- Grigio
- Cinzento

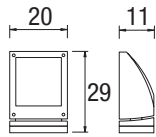

**05-9250-34-37** ■

R7s L=118 max. 300W Halogen

IP 65 4 IK 08  $\varnothing_{0.5m}$

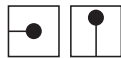
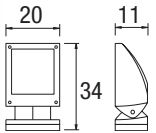
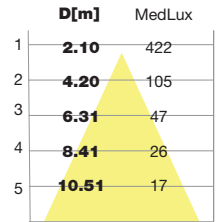
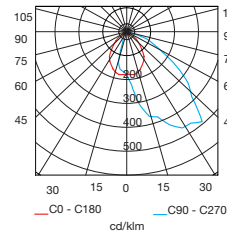

**05-9251-34-37** ■

R7s L=118 max. 300W Halogen

IP 65 4 IK 08  $\varnothing_{0.5m}$

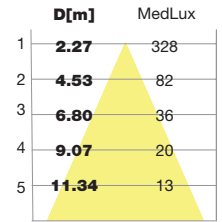
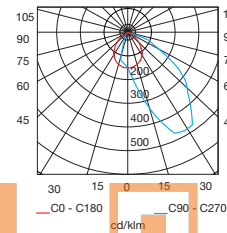

**MODULO ELECTRO**

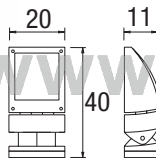

**05-9252-34-37** ■

Rx7s 70W Halogenurs

IP 65 2 IK 08  $\varnothing_{0.5m}$

PHILIPS Included

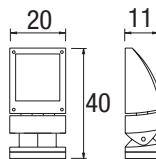
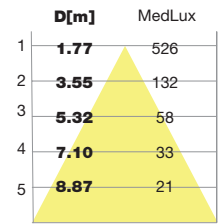
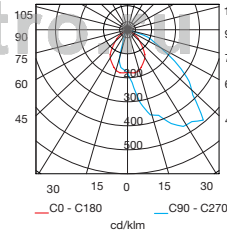

**05-9253-34-37** ■

Rx7s-24 150W Halogenurs

IP 65 2 IK 08  $\varnothing_{0.5m}$

PHILIPS Included

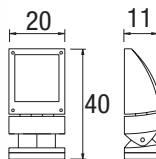
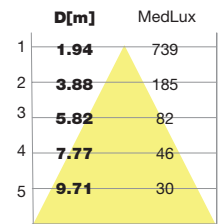
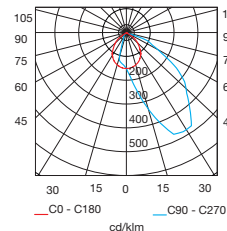

**05-9254-34-37** ■

2 x GX24q-3 26W Fluor

IP 65 2 IK 08  $\varnothing_{0.5m}$

BAG Included

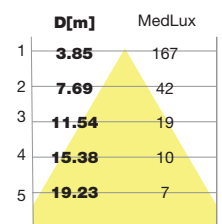
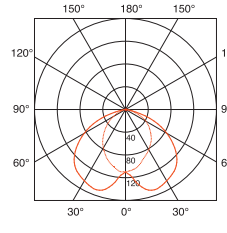



Materiales / Materials



Especificaciones / Specifications



Acabados / Finishes

■ 34 Gris	■ 48 Acero galvanizado.
Grey	Galvanised steel.
Gris	Acier galvanisé.
Grau	Galvanisiertes Stahl.
Grigio	Acciaio galvanizzato.
Cinzentu	Aço galvanizado.



# MODULO



**71-9291-34-34 ■**

Soportes para instalación en poste de Ø 60 mm. Para usar con 05-9251, 05-9252, 05-9253, 05-9254  
 Supports for installing in Ø 60 mm post. To use with 05-9251, 05-9252, 05-9253, 05-9254



www.modulelectro.ru



**71-9292-34-34 ■**

Soportes para instalación en poste de Ø 60 mm. Para usar con 05-9251, 05-9252, 05-9253, 05-9254  
 Supports for installing in Ø 60 mm post. To use with 05-9251, 05-9252, 05-9253, 05-9254

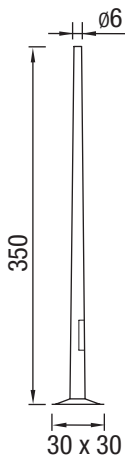

55-9305-48-48

**55-9305-48-48 ■**

Columna 3,5 m / 3,5 m. column



Kit de instalación incluido.  
 Installation kit included.  
 Kit d'installation compris.  
 Einbaukit inklusive.  
 Kit installazione incluso.  
 Kit de instalação incluso.

# FLASH

## Materiales / Materials



## Especificaciones / Specifications



## Acabados / Finishes

- 34 Gris
- Grey
- Gris
- Grau
- Grigio
- Cinzeno

## Incluido / Included



**MODULO**  
ELECTRO  
[www.modulelectro.ru](http://www.modulelectro.ru)

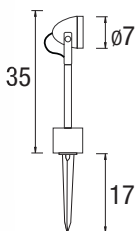

**05-9241-34-37** ■

3 POWER LEDS X 1 W 3W-230V Cool white 6500K

IP 65   2 

 **Included**

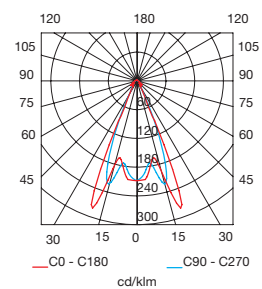

D[m]	MedLux
0.85	155
1.71	39
2.56	17
3.41	10
4.26	6

H Alpha=23.1°+23.1°

## Midi collection

- Projector led de alta eficiencia, adecuado para crear efectos de acentuación y excelente para localizaciones de difícil acceso. Cuerpo fabricado en aluminio mecanizado y pintado con soporte de acero inoxidable AISI 304. Sus dos ejes de rotación ofrecen una máxima versatilidad.
- High efficiency led projector, adapted to widen effects, suitable for difficult accessibility locations. Body made of mechanized aluminium and painted with AISI 304 stainless steel bracket. Its two rotation axis offer maximum versatility.
- Projecteur à diodes électroluminescentes haut rendement, adapté à la création d'effets d'accentuation et pour les lieux d'accès difficile. Corps en aluminium mécanisé haute densité et support en acier inoxydable AISI 304.
- LED-Strahler mit hoher Energieeffizienz. Gut geeignet zur Akzentuierung angestrahler Bereiche, optimal für die Beleuchtung schwer zugänglicher Stellen. Gehäuse aus eloxiertem hochdichtem Aluminium und Edelstahlhalterung AISI 304.
- Proiettore led ad alto rendimento, adatto a creare un effetto di messa in evidenza, eccellente per zone di difficile accesso. Corpo fabbricato in alluminio meccanizzato e dipinto con supporto di acciaio inossidabile AISI 304. Le due assi di rotazione garantiscono la massima versatilità.
- Projector led de alta eficiência, adequado para criar efeitos de acentuação e excelente para localizações de difícil acesso. Corpo fabricado em alumínio mecanizado e pintado com suporte de aço inoxidável AISI 304. Os seus dois eixos de rotação oferecem uma máxima versatilidade.

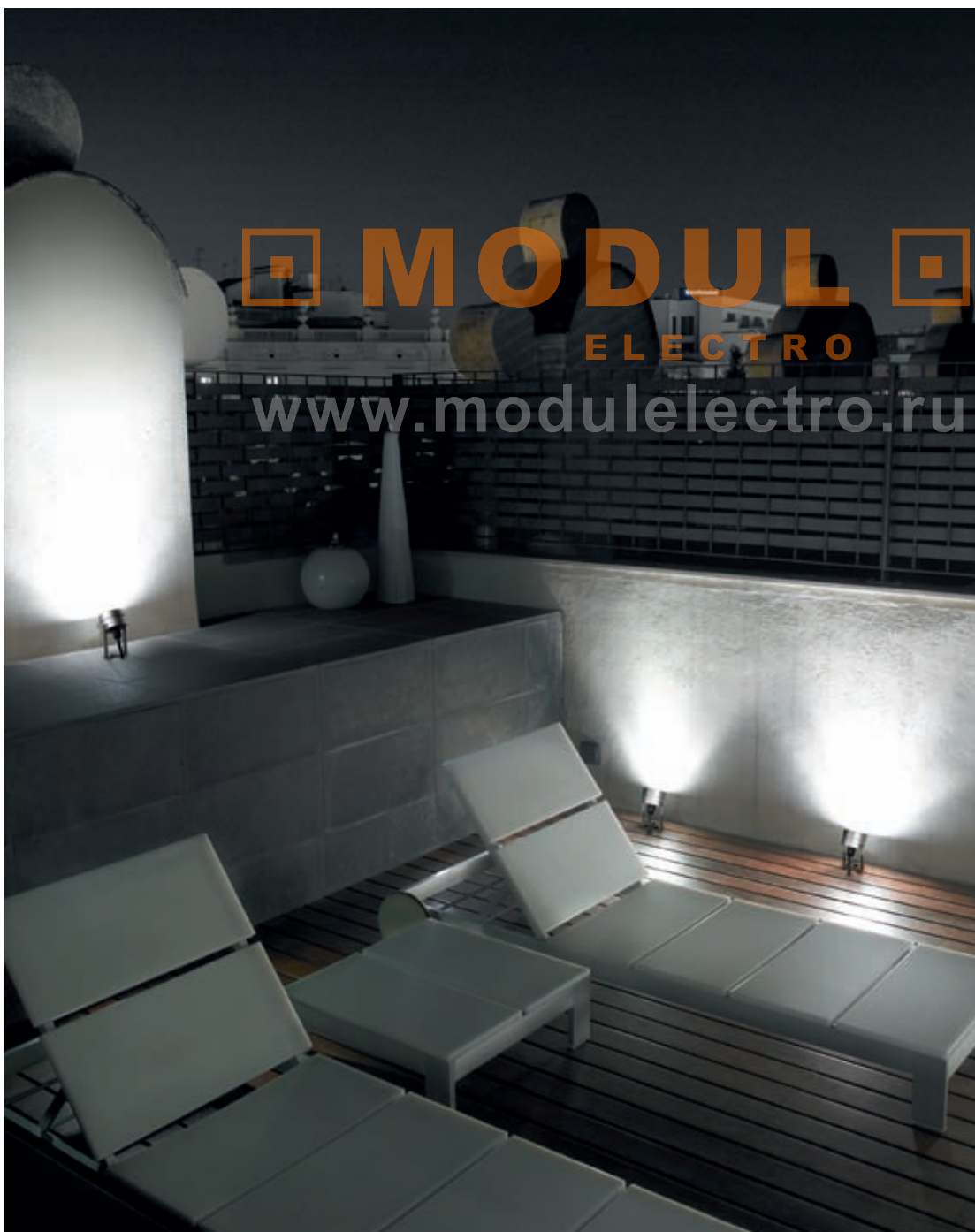

Materiales / Materials



Incluido / Included



Especificaciones / Specifications



350 mA 700 mA



Acabados / Finishes

- N3 Gris
- Grey
- Gris
- Grau
- Grigio
- Cinzeno

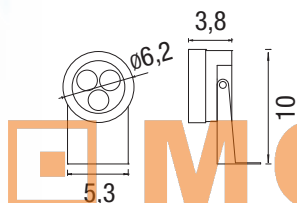

**05-3358-N3-37** ■

3 CREE LEDS X 1 W 3W 350 mA Natural white 4500K  
3 CREE LEDS X 1 W 9W 700 mA Natural white 4500K

IP 65 2

1,4 m Included

05-3358-N3-37  
Blanco natural / natural white - 9w -15°

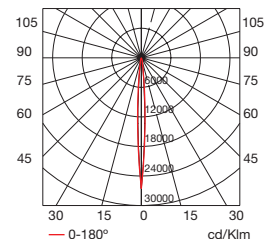

**05-3361-N3-37** ■

3 CREE LEDS X 1 W 3W 350 mA Blue  
3 CREE LEDS X 1 W 9W 700 mA Blue

IP 65 2

1,4 m Included

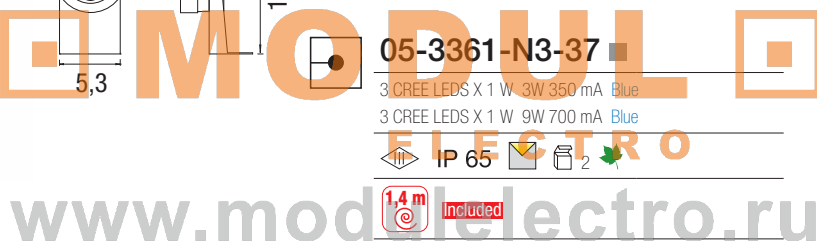

Equipos de control (ver pág. 270-271) / Controller devices (see page 270-271)

350mA

ACT-0803-00-00, ACT-0804-00-00 (1 pieza / 1 piece)

ACT-0808-00-00 (1 a 2 piezas / 1 to 2 pieces)

ACT-0816-00-00 (1 a 6 piezas / 1 to 6 pieces)

71-3477-00-00 (1 a 2 piezas / 1 to 2 pieces) IP 68

700mA

71-3307-00-00 (1 pieza / 1 piece)

71-3308-00-00 (1 a 2 piezas / 1 to 2 pieces)

71-3478-00-00 (1 a 2 piezas / 1 to 2 pieces) IP 68

DIMMING

350mA

71-3475-00-00 (1 a 4 piezas / 1 to 4 pieces)

700mA

71-3475-00-00 (1 a 3 piezas / 1 to 3 pieces)

\* Consultar condiciones comerciales. \* Handelsbedingungen abfragen.  
\* Consult commercial conditions. \* Consultare le condizioni commerciali.  
\* Consulter les conditions commerciales. \* Consultar condições comerciais.



# HECATE

100

Hecate

## Hecate collection

- Los bañadores de pared Hecate están disponibles en cuatro longitudes diferentes y siempre en fluorescencia. Fabricados en aluminio extrusionado, proporcionan un elevado IP y incluyen una reactancia electrónica.
- The Hecate wash lights are available in four different lengths, and always work with fluorescent. They are made of extruded aluminium and offer a high IP rating, and include electronic reactance.
- Les projecteurs muraux Hecate sont fluorescents et disponibles en quatre longueurs différentes. Fabriqués en aluminium extrudé, ils offrent un indice élevé de protection IP et disposent d'une réactance électronique.
- Die Wand-Lichtdiffusoren Hecate sind in vier verschiedenen Längen, ausschließlich mit Leuchtstofflampen, erhältlich. Sie sind aus extrudiertem Aluminium hergestellt, bieten einen hohen IP Schutz und schließen eine elektronische Reaktanz ein.
- Gli elementi bagnabili da parete Hecate sono disponibili in quattro lunghezze differenti e sempre in fluorescenza. Fabbricati in alluminio estruso offrono un alto grado di resistenza IP e includono una reattanza elettronica.
- Os lustres de parede Hecate estão disponíveis em quatro comprimentos diferentes e sempre fluorescentes. Fabricados em alumínio extrusionado, proporcionam um elevado IP e incluem uma reactância electrónica.

 **MODUL**   
ELECTRO  
[www.modulelectro.ru](http://www.modulelectro.ru)

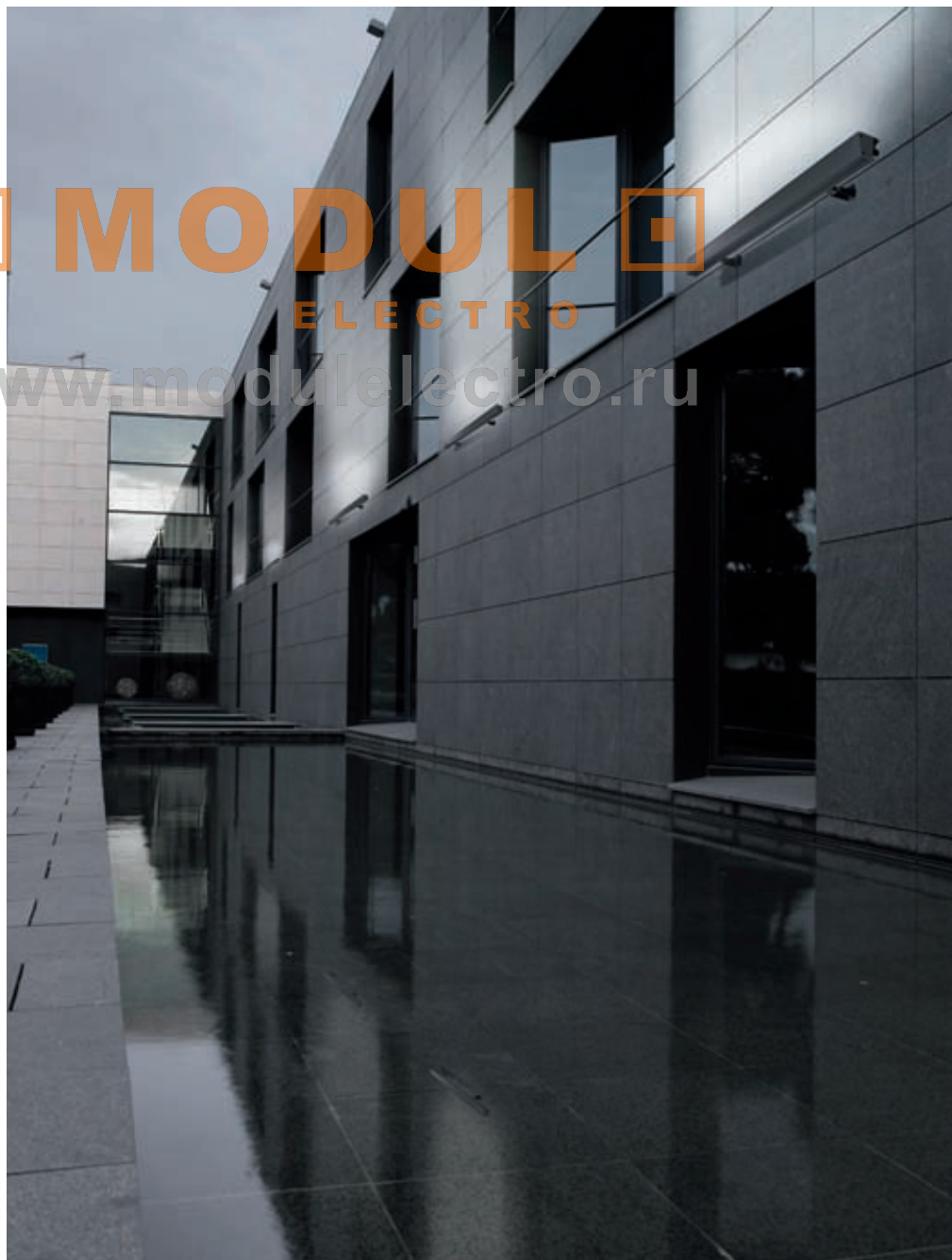

Materiales / Materials



Accesorios para fijación en pared o techo incluidos.  
 Accessories for wall or ceiling fitting included.  
 Accessoires de fixation murale ou au plafond inclus.  
 Zubehör zur Befestigung an Wänden und Decken inklusive.  
 Accessori per fissaggio nella parete o tetto inclusi.  
 Acessórios para a fixação em parede ou tecto incluídos.

Especificaciones / Specifications

IP 65 CE ENERGY SAVING IK 07



Acabados / Finishes

Z5 Gris urbano  
 Urban grey  
 Gris urbain  
 Anthrazit  
 Grigio urbano  
 Cinzento urbano

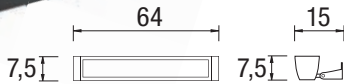

05-9264-Z5-37 ■

T5 24W Fluorescent

IP 65 BAG 2 ENERGY SAVING IK 07

BAG Included

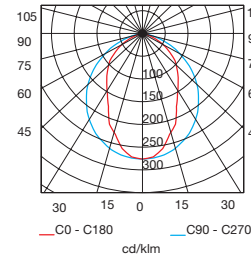

D[m]	MedLux
1	1.38 165
2	2.75 41
3	4.13 18
4	5.50 10
5	6.88 7

H Alpha=34.5°+34.5°

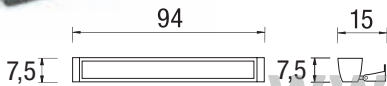
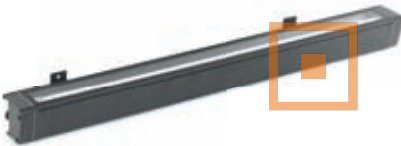

05-9265-Z5-37 ■

T5 39W Fluorescent

IP 65 BAG 2 ENERGY SAVING IK 07

BAG Included

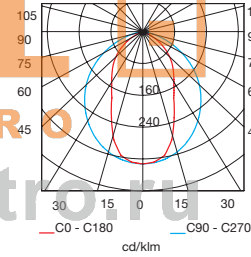

D[m]	MedLux
1	1.38 293
2	2.75 73
3	4.13 33
4	5.50 18
5	6.88 12

H Alpha=4.5°+34.5°

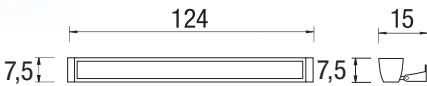

05-9266-Z5-37 ■

T5 54W Fluorescent

IP 65 BAG 2 ENERGY SAVING IK 07

BAG Included

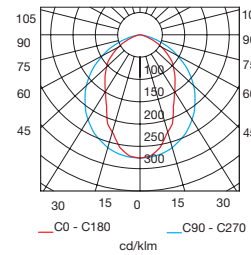

D[m]	MedLux
1	1.38 420
2	2.75 105
3	4.13 47
4	5.50 26
5	6.88 17

H Alpha=34.5°+34.5°

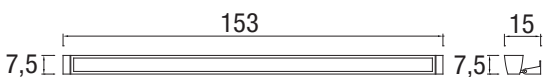

05-9439-Z5-37 ■

T5 80W Fluorescent

IP 65 BAG 2 ENERGY SAVING IK 07

BAG Included

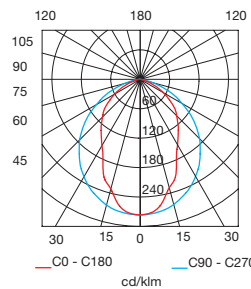

D[m]	MedLux
1	2.73 52
2	5.45 13
3	8.18 6
4	10.90 3
5	13.63 2

H Alpha=53.7°+53.7°

Materiales / Materials



Especificaciones / Specifications



Acabados / Finishes

- 54 Aluminio anodizado
- Anodized aluminium
- Aluminium anodisé
- Eloxiertes Aluminium
- Alluminio anodizzato
- Aluminio anodizado



**MODULO**  
ELECTRO

[www.modulelectro.ru](http://www.modulelectro.ru)



**05-3442-54-H6**

36 CREE LEDS X 1 W 24 VDC 36W 2000 lm Neutral white 5500K

IP 65 IK 07

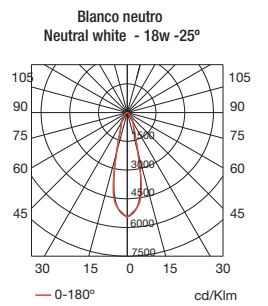
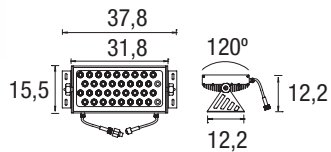

**05-3443-54-H6**

36 CREE LEDS X 1 W 24 VDC 36W 660 lm RGB

IP 65 IK 07

Equipos (ver pág. 270-271 / Gears (see page 270-271)

71-3480-00-00 (24VDC-130W) IP 67

Equipos de control (ver pág. 270-271) / Controller devices (see page 270-271)

**05-3442-54-H6**

71-3472-00-00 (1-10V)

71-3473-00-00 (DALI)

**05-3443-54-H6**

71-3474-00-00 (DMX)

\* Consultar condiciones comerciales. \* Handelsbedingungen abfragen.  
\* Consult commercial conditions. \* Consultare le condizioni commerciali.  
\* Consulter les conditions commerciales. \* Consultar condições comerciais.

# TRON

## Materiales / Materials



## Especificaciones / Specifications



## Acabados / Finishes

- 54 Aluminio anodizado
- Anodized aluminium
- Aluminium anodisé
- Eloxiertes Aluminium
- Alluminio anodizzato
- Aluminio anodizado



**MODULO ELECTRO**



**05-3438-54-H6**  
18 CREE LEDs X 1 W 24 VDC 18W 0,5 m 1055 lm Neutral white 5500K  
IP 65 IK 05

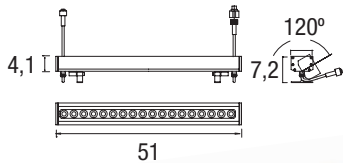
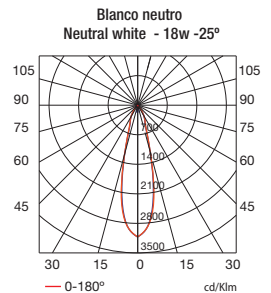

**05-3439-54-H6**  
18 CREE LEDs X 1 W 24 VDC 18W 0,5 m 298 lm RGB  
IP 65 IK 05

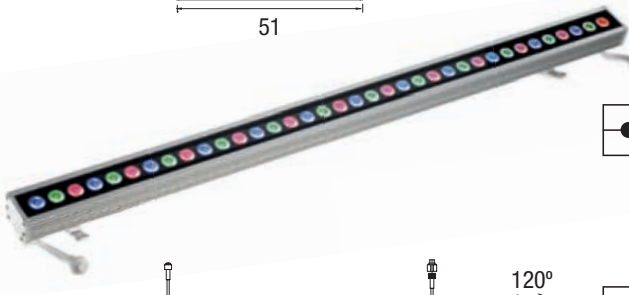

**05-3440-54-H6**  
36 CREE LEDs X 1 W 24 VDC 36W 1 m 2110 lm Neutral white 5500K  
IP 65 IK 05

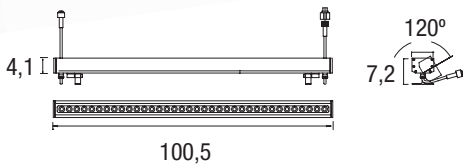

**05-3441-54-H6**  
36 CREE LEDs X 1 W 24 VDC 36W 1 m 595 lm RGB  
IP 65 IK 05

Equipos (ver pág. 270-271 / Gears (see page 270-271)

71-3480-00-00 (24VDC-130W) IP 67

Equipos de control (ver pág. 270-271) / Controller devices (see page 270-271)

**05-3442-54-H6**

71-3472-00-00 (1-10V)

71-3473-00-00 (DALI)

**05-3443-54-H6**

71-3474-00-00 (DMX)

\* Consultar condiciones comerciales. \* Handelsbedingungen abfragen.  
\* Consult commercial conditions. \* Consultare le condizioni commerciali.  
\* Consulter les conditions commerciales. \* Consultar condições comerciais.



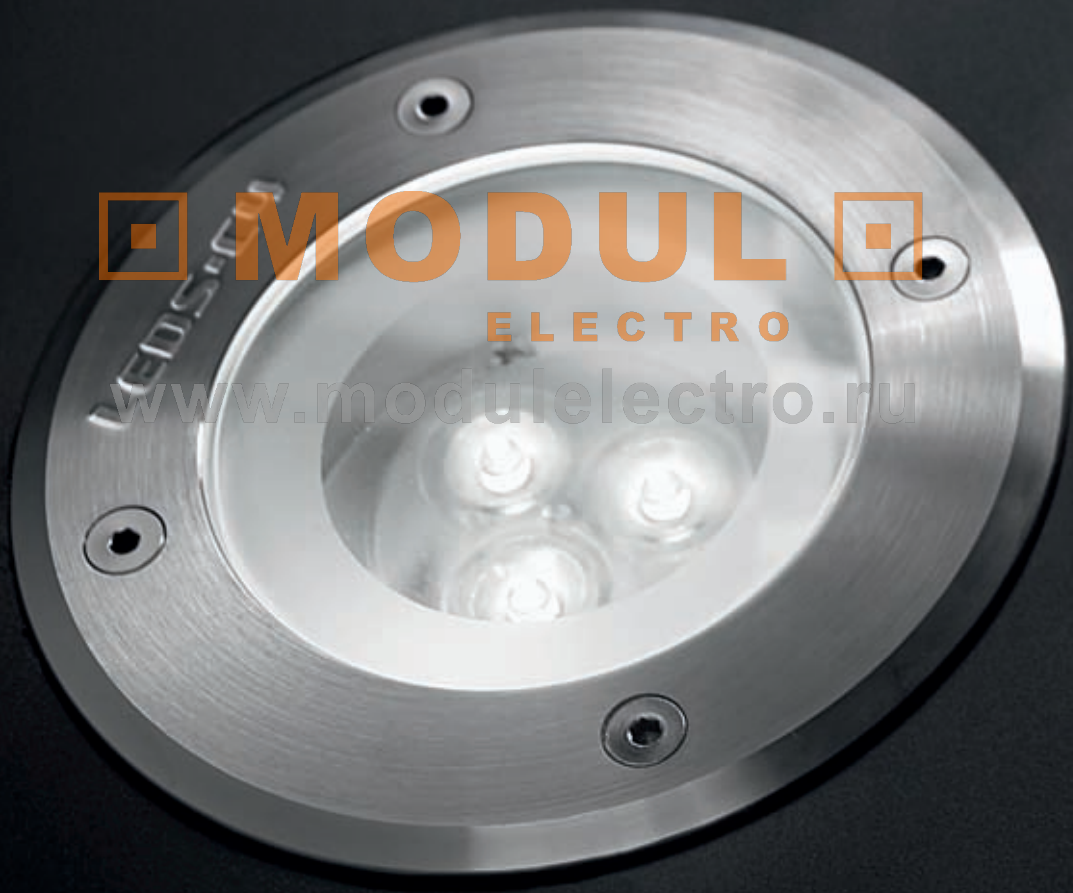

## Gea collection <sup>®</sup>

- Amplia colección de empotrables en aluminio, tecnopolímero y acero inoxidable 304 o 316 para uso profesional y con gran variedad de fuentes de luz. Los modelos tienen una alta protección IP (hasta IP 68).
- Wide collection of aluminium, technopolymere and 304 or 316 stainless steel embeddings, for professional use and wide range of light sources. The models are provided with a high IP (up to IP 68) protection.
- Vaste collection d'encastrables en aluminium, technopolymère et acier inoxydable 304 ou 316 à usage professionnel et offrant une grande variété de sources d'éclairage. Les modèles présentent une haute protection IP (jusqu'à IP 68).
- Große Kollektion von Einbauleuchten aus Aluminium, Technikpolymer und Edelstahl 304 oder 316 zur professionellen Nutzung. Große Auswahl an Lichtquellen. Die Modelle haben einen hohen IP-Schutzgrad (bis IP 68).
- Ampia collezione di lampade da incasso in alluminio, tecnopolimero e acciaio inossidabile 304 o 316 per uso professionale e con una grande varietà di fonti di luce. I modelli hanno un'alta protezione IP (fino a IP 68).
- Amplia coleção de embutidos em alumínio, tecnopolímero e aço inoxidável 304 ou 316 para uso profissional e com grande variedade de fontes de luz. Os modelos têm uma alta proteção IP (hasta IP 68).

<sup>®</sup> Registration number: 000966874-025

 **MODUL**   
ELECTRO

[www.modulelectro.ru](http://www.modulelectro.ru)





### 55-9264-Y4-37

T5 24W Fluorescent <40°C

IP 67 2 279 IK 08

BAG **Included**

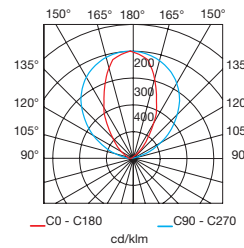

D[m]	MedLux
5	5.61 9
4	4.49 14
3	3.36 25
2	2.24 55
1	1.12 221

H Alpha=29.3°+29.3°

(new)



### 55-9523-Y4-37

12 x 1 W LED 100-240V 50-60Hz <40°C  
PHILIPS Neutral white 4100K

IP 67 2 279 IK 08

**Included**

Consultar disponibilidad / Check availability

(new)



### 55-9524-Y4-37

12 x 1 W LED PHILIPS RGB 100-240V 50-60Hz <40°C

IP 67 2 279 IK 08

**Included** Compatible con DMX 512  
DMX 512 compatible

Consultar disponibilidad / Check availability

- \* Consultar condiciones comerciales.
- \* Consult commercial conditions.
- \* Consulter les conditions commerciales.
- \* Handelsbedingungen abfragen.
- \* Consultare le condizioni commerciali.
- \* Consultar condições comerciais.

Para versión en blanco DMX dimmable CONSULTAR.  
LOOK UP for a white DMX dimmable version.  
Veuillez nous consulter pour la version en blanc DMX dimmable (à variateur).  
Ausführung in Weiß DMX mit Dimmfunktion AUF ANFRAGE.  
Per la versione nel bianco DMX dimmable chiedere informazioni.  
Para versão em branco DMX dimmable CONSULTAR.

Materiales / Materials



Incluido / Included



Especificaciones / Specifications

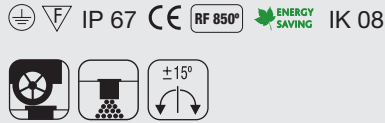

Acabados / Finishes

Y4 Acero inoxidable  
Stainless steel  
Acier inoxydable  
Rostfreier Stahl  
Acciaio inossidabile  
Aço inoxidável

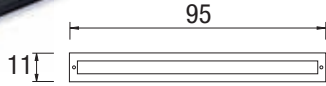

55-9265-Y4-37

T5 39W Fluorescent <40°C

IP 67 2 280 IK 08

BAG Included

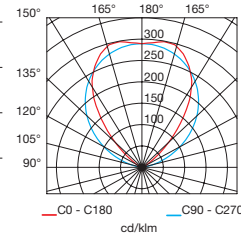

D[m]	MedLux
5	8.32
4	6.66
3	4.99
2	3.33
1	1.66

H Alpha=39.8°+39.8°



(New)



55-9525-Y4-37

18 x 1 W LED 100-240V 50-60Hz <40°C  
PHILIPS Neutral white 4100K

IP 67 2 280 IK 08

Included

Consultar disponibilidad / Check availability



(New)



55-9526-Y4-37

18 x 1 W LED PHILIPS RGB 100-240V 50-60Hz <40°C

IP 67 2 280 IK 08

Included Compatible con DMX 512  
DMX 512 compatible

Consultar disponibilidad / Check availability

www.modulelectro.ru



11

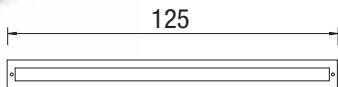

55-9266-Y4-37

T5 54W Fluorescent <40°C

IP 67 2 280 IK 08

BAG Included

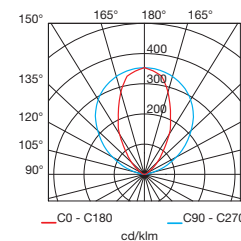

D[m]	MedLux
5	5.61
4	4.49
3	3.36
2	2.24
1	1.12

H Alpha=29.3°+29.3°



(New)



55-9527-Y4-37

24 x 1 W LED 100-240V 50-60Hz <40°C  
PHILIPS Neutral white 4100K

IP 67 2 280 IK 08

Included

Consultar disponibilidad / Check availability



(New)



55-9528-Y4-37

24 x 1 W LED PHILIPS RGB 100-240V 50-60Hz <40°C

IP 67 2 280 IK 08

Included Compatible con DMX 512  
DMX 512 compatible

Consultar disponibilidad / Check availability



MUY IMPORTANTE consulte la tabla de usos y mantenimiento en la página 290  
VERY IMPORTANT please consult the table on use and maintenance on page 290  
TRÈS IMPORTANT consultez la table d'utilisation et de maintenance de la page 290

WICHTIG Bitte beachten Sie die Tabelle der Gebrauchs- und Instandhaltungsanweisungen auf Seite 290  
MOLTO IMPORTANTE si consulti la tabella di uso e manutenzione a pagina 290  
MUITO IMPORTANTE consulte a tabela de uso e manutenção na página 290



**MODUL**  
ELECTRO  
[www.modulelectro.ru](http://www.modulelectro.ru)

Materiales / Materials



Especificaciones / Specifications



Acabados / Finishes

Y4 Acero inoxidable  
Stainless steel  
Acier inoxydable  
Rostfreier Stahl  
Acciaio inossidabile  
Aço inoxidável

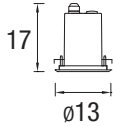

**15-9381-Y4-37**

- GU-10 max. 50W
- GU-10 max. 14W Fluorescent
- GU-10 max. 5W LED

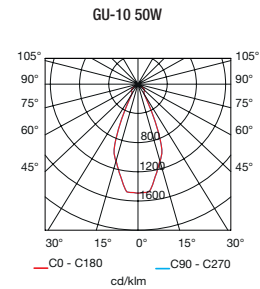

D[m]	MedLux
0.75	733
1.50	183
2.24	81
2.99	46
3.03	32

H alpha= 25°+ 25°



**71-9448-Y4-Y4**

Aro de acero inoxidable AISI 316 para 15-9381  
Stainless steel AISI 316 ring for 15-9381

**MODULO ELECTRO**

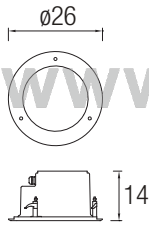

**15-9391-Y4-B8**

- GX24d-3 26W
- IP 66
- 2
- 278
- IK 08

BAG Included

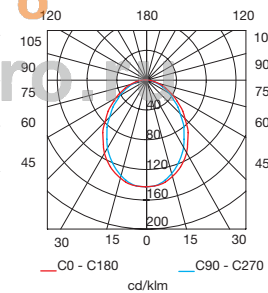

D[m]	MedLux
1.66	177
3.33	44
4.99	20
6.66	11
8.32	7

H Alpha=39.8°+39.8°

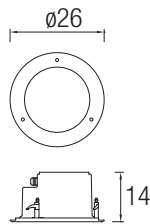

**15-9392-Y4-B8**

- 2 x GX24d-3 26W
- IP 66
- 2
- 278
- IK 08

BAG Included

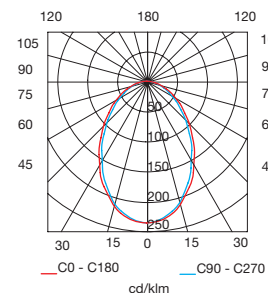

D[m]	MedLux
2.13	184
4.25	46
6.38	20
8.50	12
10.63	7

H Alpha=46.7°+46.7°



MUY IMPORTANTE consulte la tabla de usos y mantenimiento en la página 290  
VERY IMPORTANT please consult the table on use and maintenance on page 290  
TRÈS IMPORTANT consultez la table d'utilisation et de maintenance de la page 290

WICHTIG Bitte beachten Sie die Tabelle der Gebrauchs- und Instandhaltungsanweisungen auf Seite 290  
MOLTO IMPORTANTE si consulti la tabella di uso e manutenzione a pagina 290  
MUITO IMPORTANTE consulte a tabela de uso e manutenção na página 290



Materiales / Materials

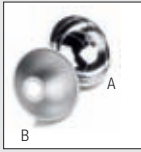

2 reflectores incluidos.  
2 reflectors included.  
2 réflecteurs inclus.  
2 Reflektore inklusive.  
2 riflettori inclusi.  
2 reflectores incluidos

Especificaciones / Specifications

⚡ ⚡ CE IP 67 ENERGY SAVING IK 08



Incluido / Included



Acabados / Finishes

Y4 Acero inoxidable  
Stainless steel  
Acier inoxydable  
Rostfreier Stahl  
Acciaio inossidabile  
Aço inoxidável

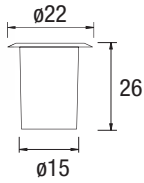

55-9433-Y4-37

Rx7s. 70W HID >80°C

IP 67  $\varnothing_{0.5m}$  2 279 IK 08

BAG Included

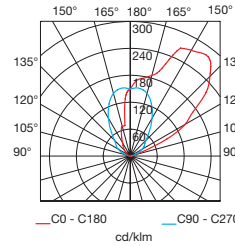

D[m]	MedLux
5	8.95 18
4	7.16 27
3	5.37 49
2	3.58 110
1	1.79 439

H Alpha=23.0+40.2

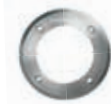

71-9453-Y4-Y4

Aro de acero inoxidable AISI 316 para 55-9433  
Stainless steel AISI 316 ring for 55-9433

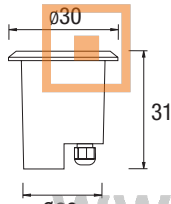

55-9429-Y4-37

G12 150W HID >80°C

IP 67  $\varnothing_{0.5m}$  2 280 IK 08

BAG Included

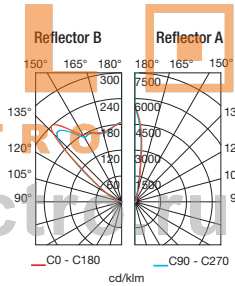

D[m]	MedLux	MedLux
5	12.11 43	1.32 1811
4	9.69 68	1.06 2830
3	7.27 120	0.79 5032
2	4.85 270	0.53 11321
1	2.42 1081	0.26 45284

H Alpha= 50.5°+50.5° Alpha=7.5°+7.5°

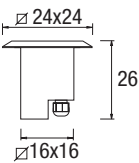

55-9232-Y4-37

G12 70W HID >80°C

IP 67  $\varnothing_{0.5m}$  2 279 IK 08

BAG Included

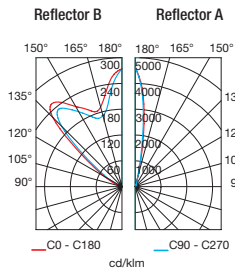

D[m]	MedLux	MedLux
5	12.08 23	1.47 729
4	9.66 36	1.18 1139
3	7.25 64	0.88 2024
2	4.83 143	0.59 4555
1	2.42 572	0.29 18218

H Alpha=50.4°+50.4° Alpha=8.4°+8.4°

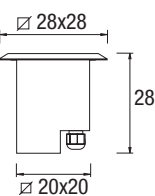

55-9233-Y4-37

G12 150W HID >80°C

IP 67  $\varnothing_{0.5m}$  2 279 IK 08

BAG Included

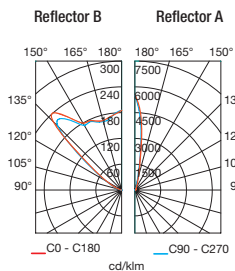

D[m]	MedLux	MedLux
5	12.11 43	1.32 1811
4	9.69 68	1.06 2830
3	7.27 120	0.79 5032
2	4.85 270	0.53 11321
1	2.42 1081	0.26 45284

H Alpha=50.5°+50.5° Alpha=7.5°+7.5°



MUY IMPORTANTE consulte la tabla de usos y mantenimiento en la página 290  
VERY IMPORTANT please consult the table on use and maintenance on page 290  
TRÈS IMPORTANT consultez la table d'utilisation et de maintenance de la page 290

WICHTIG Bitte beachten Sie die Tabelle der Gebrauchs- und Instandhaltungsanweisungen auf Seite 290  
MOLTO IMPORTANTE si consulti la tabella di uso e manutenzione a pagina 290  
MUITO IMPORTANTE consulte a tabela de uso e manutenção na página 290



Materiales / Materials



2 reflectores incluidos.  
2 reflectors included.  
2 réflecteurs inclus.  
2 Reflektore inklusive.  
2 riflettori inclusi.  
2 reflectores incluídos

Especificaciones / Specifications



Incluido / Included



Acabados / Finishes

Y4 Acero inoxidable  
Stainless steel  
Acier inoxydable  
Rostfreier Stahl  
Acciaio inossidabile  
Aço inoxidável

(NEW)

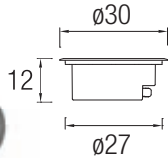

**55-9486-Y4-37**

G 8.5 35W HID 40-80°C

IP 67  $\leq 0.5m$  2 281 IK 08

BAG Included

Consultar disponibilidad / Check availability



**71-9512-Y4-Y4**

Aro de acero inoxidable AISI 316 para 55-9486  
Stainless steel AISI 316 ring for 55-9486

Reflector B

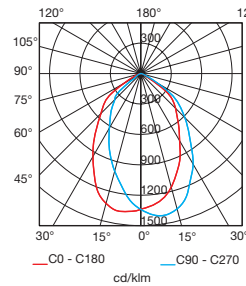

Reflector A

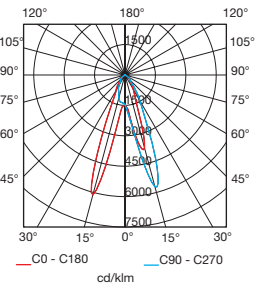

D[m]	MedLux
5	7.39
4	5.91
3	4.43
2	2.96
1	1.48

D[m]	MedLux
5	1.04
4	0.83
3	0.63
2	0.42
1	0.21

H Alpha=30.3°+42.4°

H Alpha=6.0°+5.1°

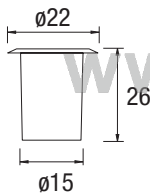

**55-9323-Y4-37**

G12 35W HID 40-80°C

IP 67  $\leq 0.5m$  2 279 IK 08

BAG Included

Reflector B

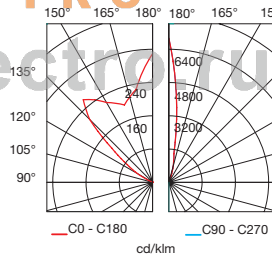

Reflector A

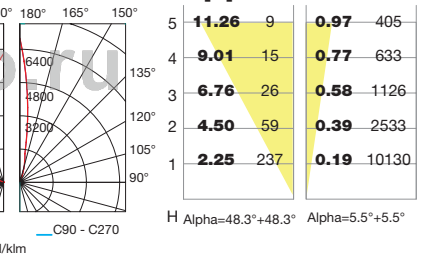

D[m]	MedLux
5	11.26
4	9.01
3	6.76
2	4.50
1	2.25

H Alpha=48.3°+48.3° Alpha=5.5°+5.5°

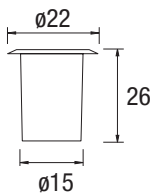

**55-9187-Y4-37**

G12 70W HID >80°C

IP 67  $\leq 0.5m$  2 279 IK 08

BAG Included

Reflector B

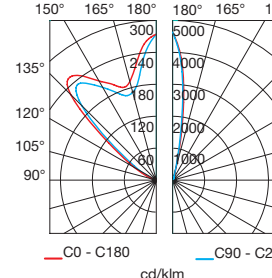

Reflector A

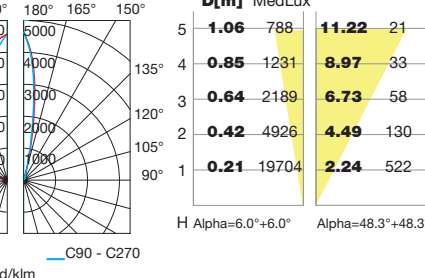

D[m]	MedLux
5	1.06
4	0.85
3	0.64
2	0.42
1	0.21

H Alpha=6.0°+6.0° Alpha=48.3°+48.3°



**71-9453-Y4-Y4**

Aro de acero inoxidable AISI 316 para 55-9187 y 55-9323  
Stainless steel AISI 316 ring for 55-9187 and 55-9323

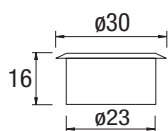

**71-9187-Y4-37**

Accesorio para 55-9187 y 55-9323  
Accessory for 55-9187 and 55-9323

2 IK 08



La temperatura en la superficie externa es <70°.  
The temperature of the external surface is <70°.  
La température de la surface extérieur est <70°.

Die Temperatur an der äußeren Oberfläche beträgt <70°.  
La temperatura sulla superficie esterna è <70°.  
A temperatura na superfície extrna é <70°.

Materiales / Materials



Incluido / Included



Especificaciones / Specifications

IP 67 CE RF 850° IK 08 ENERGY SAVING



Acabados / Finishes

Y4 Acero inoxidable  
Stainless steel  
Acier inoxydable  
Rostfreier Stahl  
Acciaio inossidabile  
Aço inoxidável

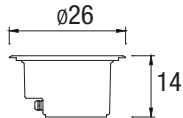

55-9430-Y4-T2

2 x GX24d-3 26W >80°C

IP 67 IK 08

2 x BAG Included

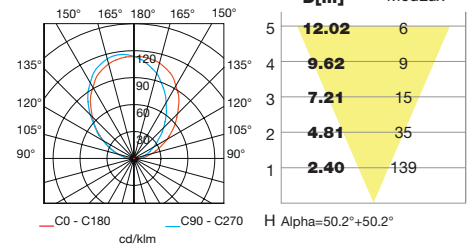

71-9454-Y4-Y4

Aro de acero inoxidable AISI 316 para 55-9430  
Stainless steel AISI 316 ring for 55-9430

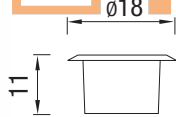

55-9337-Y4-37

G-53 75W Hal. 12V. AC >80°C

IP 67 IK 08

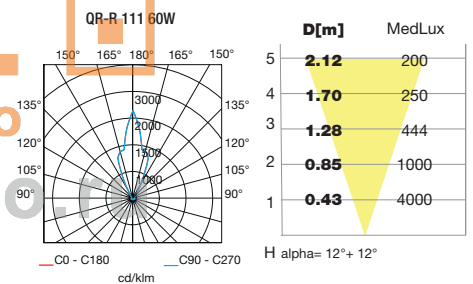

71-9452-Y4-Y4

Aro de acero inoxidable AISI 316 para 55-9337  
Stainless steel AISI 316 ring for 55-9337

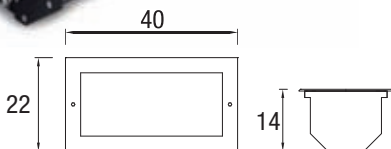

55-9384-Y4-37 (S)

2 x G-53 50W Hal. 12V. AC >80°C

IP 67 IK 08

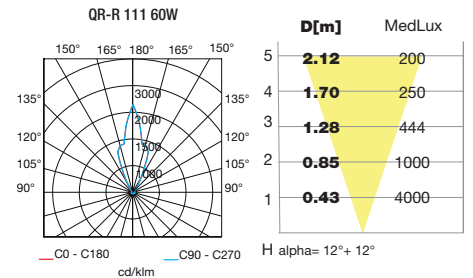



71-9197-05-05

Transformador estanco para lámparas halógenas. 230/12V AC-100W.  
Water proof transformer for halogen bulbs. 230/12V AC - 100W.

IP 68 1 m 6



 **MODUL**   
ELECTRO  
[www.modulelectro.ru](http://www.modulelectro.ru)

Materiales / Materials



Incluido / Included



Especificaciones / Specifications

IP 67 CE IK 08 ENERGY SAVING



Acabados / Finishes

Y4 Acero inoxidable  
Stainless steel  
Acier inoxydable  
Rostfreier Stahl  
Acciaio inossidabile  
Aço inoxidável

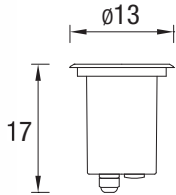

**55-9280-Y4-37**

- GU-10 max. 50W >80°C
- GU-10 max. 14W Fluorescent 40-80°C
- GU-10 max. 5W LED <40°C

IP 67 0.5m 8 280 IK 08

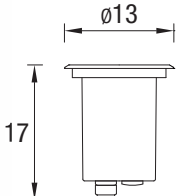
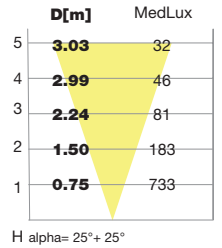
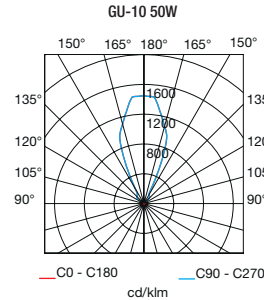

**55-9394-Y4-37**

- GU-10 max. 50W >80°C
- GU-10 max. 14W Fluorescent 40-80°C
- GU-10 max. 5W LED <40°C

IP 67 4 280 IK 08

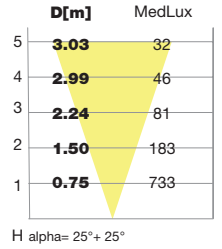
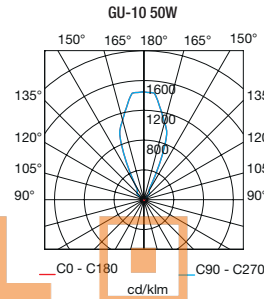

**MODULO ELECTRO**

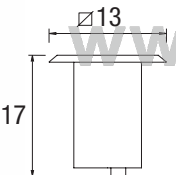

**55-9281-Y4-37**

- GU-10 max. 50W >80°C
- GU-10 max. 14W Fluorescent 40-80°C
- GU-10 max. 5W LED <40°C

IP 67 0.5m 8 280 IK 08

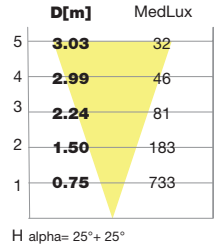
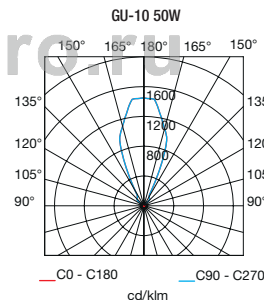

**71-9449-Y4-Y4**

Marco de acero inoxidable AISI 316 para 55-9281  
Stainless steel AISI 316 frame for 55-9281

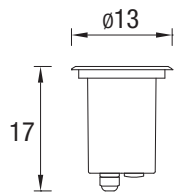

**55-9380-Y4-37**

- GU-10 max. 50W >80°C
- IP 67 0.5m 4 280 IK 08

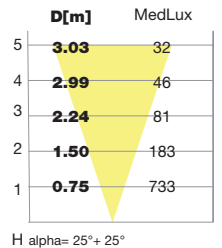
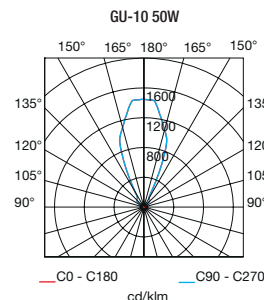

**71-9448-Y4-Y4**

Aro de acero inoxidable AISI 316 para 55-9380  
Stainless steel AISI 316 ring for 55-9380



MUY IMPORTANTE consulte la tabla de usos y mantenimiento en la página 290  
VERY IMPORTANT please consult the table on use and maintenance on page 290  
TRÈS IMPORTANT consultez la table d'utilisation et de maintenance de la page 290

WICHTIG Bitte beachten Sie die Tabelle der Gebrauchs- und Instandhaltungsanweisungen auf Seite 290  
MOLTO IMPORTANTE si consulti la tabella di uso e manutenzione a pagina 290  
MUITO IMPORTANTE consulte a tabela de uso e manutenção na página 290

Materiales / Materials



Incluido / Included

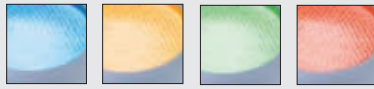

4 filtros de colores incorporados. 4 color filters included. 4 filtri di colore inclusi. 4 filtros de colores incluidos.  
4 Farfilter inklusive. 4 filtri di colore inclusi. 4 filtros de cor incluidos.

Especificaciones / Specifications

IP 67 CE ENERGY SAVING IK 08



Acabados / Finishes

Y4 Acero inoxidable  
Stainless steel  
Acier inoxydable  
Rostfreier Stahl  
Acciaio inossidabile  
Aço inoxidável

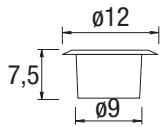

55-9184-Y4-37

GX 53 max. 9W - 230V 40-80°C

IP 67 8 ENERGY SAVING 278 IK 08

7W Included

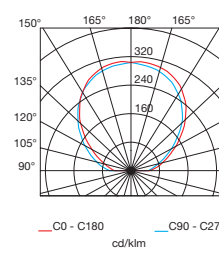

D[m]	MedLux
5	15.47
4	12.38
3	9.28
2	6.19
1	3.09

H Alpha=58.9°+55.1°



71-9450-Y4-Y4

Aro de acero inoxidable AISI 316 para 55-9184  
Stainless steel AISI 316 ring for 55-9184

MODULO ELECTRO

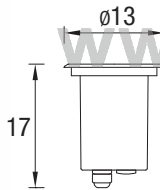

55-9282-Y4-T2

15 LEDs x 0,1 W 1,5W-230V Cool White 6500K <40°C

IP 67 8 ENERGY SAVING 280 IK 08

Included

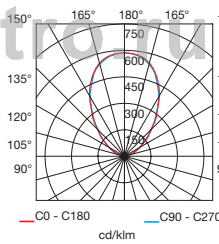

D[m]	MedLux
5	7.89
4	6.31
3	4.73
2	3.15
1	1.58

H Alpha=38.3°+38.3°



71-9448-Y4-Y4

Aro de acero inoxidable AISI 316 para 55-9282  
Stainless steel AISI 316 ring for 55-9282

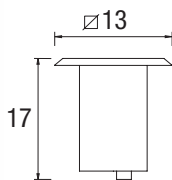

55-9283-Y4-T2

15 LEDs x 0,1 W 1,5W-230V Cool White 6500K <40°C

IP 67 8 ENERGY SAVING 280 IK 08

Included

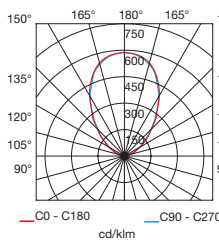

D[m]	MedLux
5	7.89
4	6.31
3	4.73
2	3.15
1	1.58

H Alpha=38.3°+38.3°



71-9449-Y4-Y4

Marco de acero inoxidable AISI 316 para 55-9283  
Stainless steel AISI 316 frame for 55-9283

Materiales / Materials



Incluido / Included



Especificaciones / Specifications

IP 67 CE IK 08 ENERGY SAVING



Acabados / Finishes

Y4 Acero inoxidable  
Stainless steel  
Acier inoxydable  
Rostfreier Stahl  
Acciaio inossidabile  
Aço inoxidável

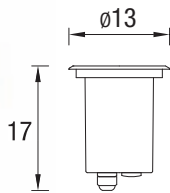

55-9284-37-37

- GU-10 max. 50W >80°C
- GU-10 max. 14W Fluorescent 40-80°C
- GU-10 max. 5W LED <40°C

IP 67 0.5m 8 ENERGY SAVING 280 IK 08

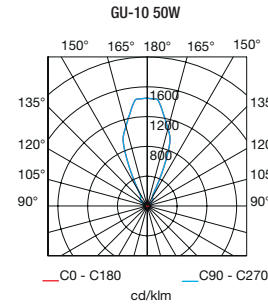

D[m]	MedLux
1	13
2	21
3	37
4	82
5	330

H Alpha=15.6°+15.6°

# MODULO ELECTRO

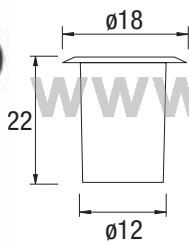

55-9186-Y4-37

- Par-30 E-27 max. 75W 40-80°C
- PL elect. E-27 max. 20W 40-80°C

IP 67 0.5m 8 ENERGY SAVING 279 IK 08

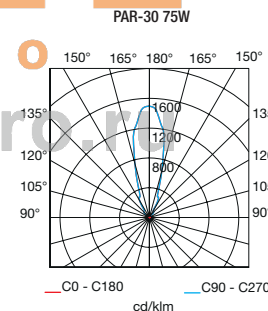

D[m]	MedLux
5	61
4	95
3	168
2	378
1	1513

H Alpha=14.7°+14.7°



2 cristales incluidos.  
2 glasses included.  
2 verres compris.  
Einbaukasten mit zwei Zusatzteilen aus Glas.  
2 vetri inclusi.  
2 vidros incluídos.



71-9452-Y4-Y4

Aro de acero inoxidable AISI 316 para 55-9186  
Stainless steel AISI 316 ring for 55-9186



MUY IMPORTANTE consulte la tabla de usos y mantenimiento en la página 290  
VERY IMPORTANT please consult the table on use and maintenance on page 290  
TRÈS IMPORTANT consultez la table d'utilisation et de maintenance de la page 290

WICHTIG Bitte beachten Sie die Tabelle der Gebrauchs- und Instandhaltungsanweisungen auf Seite 290  
MOLTO IMPORTANTE si consulti la tabella di uso e manutenzione a pagina 290  
MUITO IMPORTANTE consulte a tabela de uso e manutenção na página 290



MUY IMPORTANTE consulte la tabla de usos y mantenimiento en la página 290  
VERY IMPORTANT please consult the table on use and maintenance on page 290  
TRÈS IMPORTANT consultez la table d'utilisation et de maintenance de la page 290

WICHTIG Bitte beachten Sie die Tabelle der Gebrauchs- und Instandhaltungsanweisungen auf Seite 290  
MOLTO IMPORTANTE si consulti la tabella di uso e manutenzione a pagina 290  
MUITO IMPORTANTE consulte a tabela de uso e manutenção na página 290

Materiales / Materials



Incluido / Included



Especificaciones / Specifications

IP 67 CE RF 850° ENERGY SAVING IK 08



Acabados / Finishes

Y4 Acero inoxidable  
Stainless steel  
Acier inoxydable  
Rostfreier Stahl  
Acciaio inossidabile  
Aço inoxidável

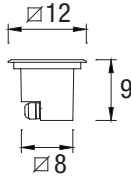

**55-9435-Y4-37**

3 x 1 W LED 100-240V Neutral white 4200K <40°C

IP 67 2 281 IK 08

Included

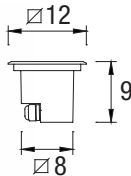
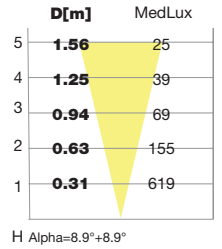
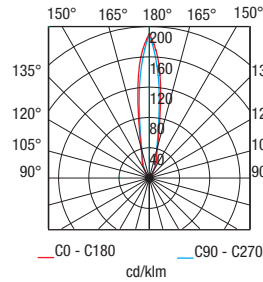

**55-9443-Y4-37**

3 x 1W RGB LED pag. 245 <40°C

IP 67 2 281 IK 08

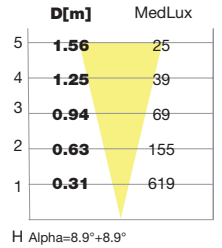
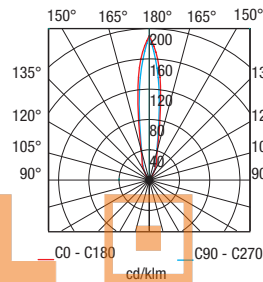

**71-9451-Y4-Y4**

Marco de acero inoxidable AISI 316 para 55-9435 y 55-9443  
Stainless steel AISI 316 frame for 55-9435 and 55-9443

www.modulelectro.ru

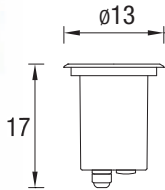

**55-9437-Y4-37**

3 x 1 W LED 100-240V Neutral white 4200K <40°C

IP 67 2 280 IK 08

Included

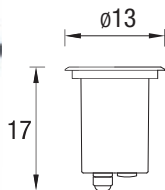
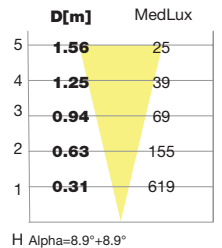
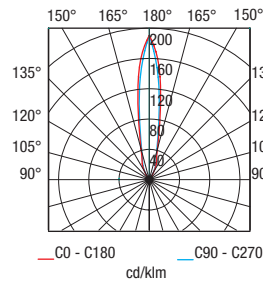

**55-9382-Y4-37**

3 x 1W RGB LED pag. 245 <40°C

IP 67 2 280 IK 08

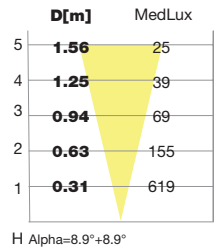
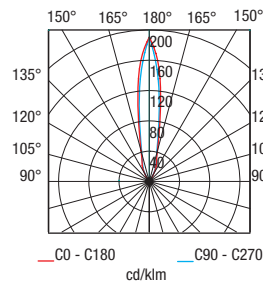

**71-9448-Y4-Y4**

Aro de acero inoxidable AISI 316 para 55-9437 y 55-9382  
Stainless steel AISI 316 ring for 55-9437 and 55-9382

Equipos para 55-9443 /55-9382 / (ver pag. 245)  
Gears for 55-9443 /55-9382 (see page 245)

71-9403-34-34 50W  
71-9404-34-34 100W

71-9495-34-34 50W MASTER  
71-9496-34-34 100W MASTER  
71-9497-34-34 100W SLAVE



Materiales / Materials



Incluido / Included



Especificaciones / Specifications

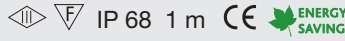

Acabados / Finishes

- 54 Aluminio anodizado
- Anodized aluminium
- Aluminium anodisé
- Eloxiertes Aluminium
- Alluminio anodizzato
- Amuminio anodizado

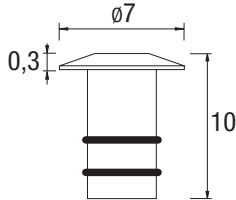

**55-9255-54-37**

MR11 max. 20W - 12V AC Halogen **>80°C**

IP 68 1 m 8 279 IK 07

71-9197 Pag. 268

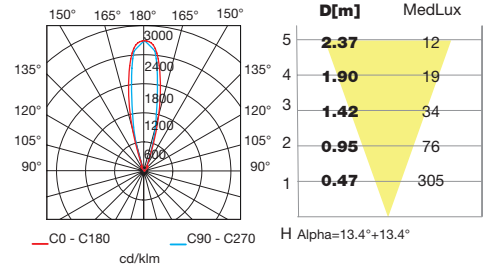

**MODULO**

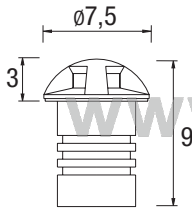

**55-9257-54-M2**

1 power LED 1W-3V DC 300mA Neutral White 4000K **<40°C**

IP 68 1 m 6 279 IK 10

71-9278 Pag. 268

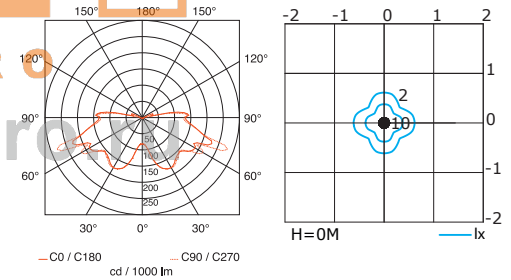

- 4 filtros de colores incorporados.
- 4 color filters included
- 4 filtres de couleurs inclus.
- 4 Farbfilter inklusive.
- 4 filtri di colore inclusi.
- 4 filtros de cor incluídos.

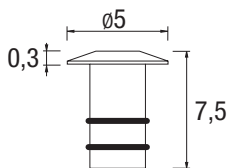

**55-9254-54-37**

1 power LED 1W-3V DC 300mA Neutral White 4000K **<40°C**

IP 68 1 m 8 279 IK 05

71-9278 Pag. 268

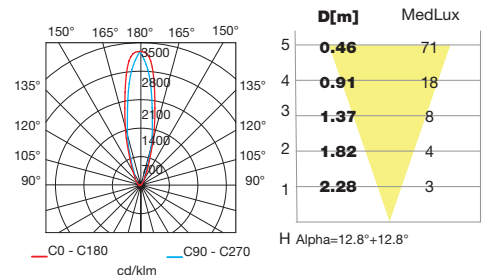

- 4 filtros de colores incorporados.
- 4 color filters included
- 4 filtres de couleurs inclus.
- 4 Farbfilter inklusive.
- 4 filtri di colore inclusi.
- 4 filtros de cor incluídos.

Características / Specifications



Especificaciones / Specifications

IP 66 CE RF 850° IK 05



Acabados / Finishes

54 Aluminio anodizado  
Anodized aluminium  
Aluminium anodisé  
Eloxiertes Aluminium  
Alluminio anodizzato  
Amuminio anodizzato

Incluido / Included



2,5 m



4 filtros de colores incorporados.  
4 color filters included  
4 filtres de couleurs inclus.

4 Farbfilter inklusive.  
4 filtri di colore inclusi.  
4 filtros de cor incluídos.

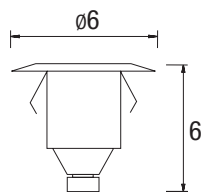

55-9243-54-B8

12 x 0,1W -12V DC Cool White 6500K

<40°C

IP 66 20 279 IK 05

71-9198 Pag. 268

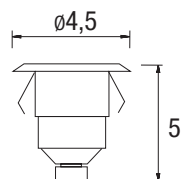
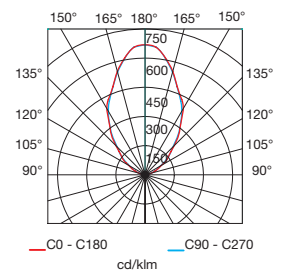

55-9242-54-B8

6 x 0,1W -12V DC Cool White 6500K

<40°C

IP 66 36 279 IK 05

71-9198 Pag. 268



**MODUL**  
ELECTRO  
[www.modulelectro.ru](http://www.modulelectro.ru)

## Aqua collection

- Colección de empotrables sumergibles realizados en acero inoxidable. Todos los modelos tienen un grado de protección IP 68. La serie cuenta con versiones halógenas, LED blanco y LEDs RGB.
- A collection of built-in waterproof luminaires, made of stainless steel. All models have IP68 rating. The collection includes halogens, white LEDs and RGB LEDs.
- Une collection de luminaires encastrables submersibles en acier inoxydable. Tous les modèles disposent d'un indice de protection IP 68. La série dispose de versions halogènes, LED blanc et LEDs RGB.
- Eine Kollektion von Einbau-Unterwasserleuchten, hergestellt aus rostfreiem Stahl. Von Einbau-Unterwasserleuchten IP 68 aus. Die Produktserie enthält halogene Versionen von weißen LED-Leuchten und RGB-LEDs.
- Collezione di elementi a incasso sommersibili realizzati in acciaio inossidabile. Tutti i modelli hanno un grado di protezione IP 68. La serie comprende versioni alogene, a LED bianchi e a LED RGB.
- Coleção de encastráveis submersíveis feitos em aço inoxidável. Todos os modelos têm um grau de proteção IP 68. A série tem versões de halogénio, LED branco e LED's RGB.

  
[www.modulelectro.ru](http://www.modulelectro.ru)

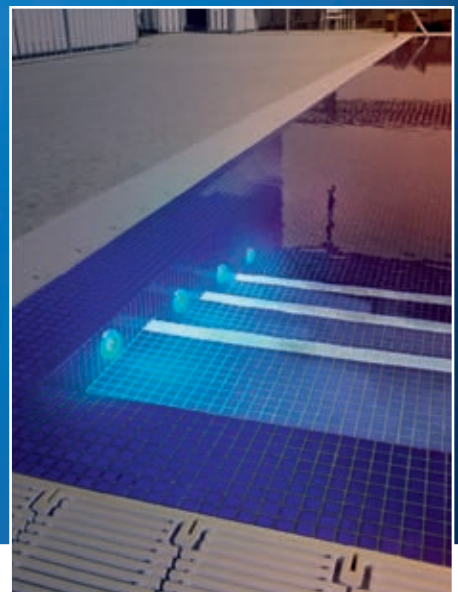
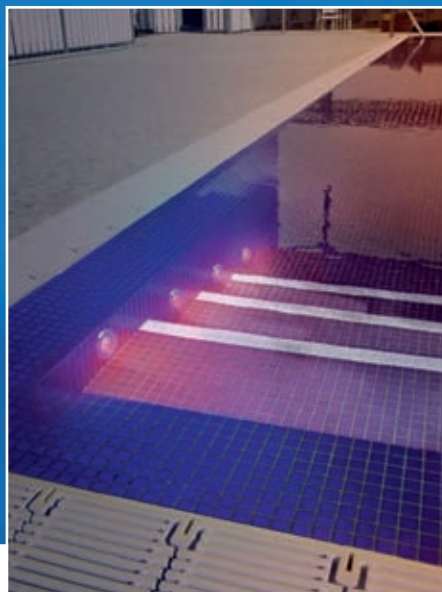
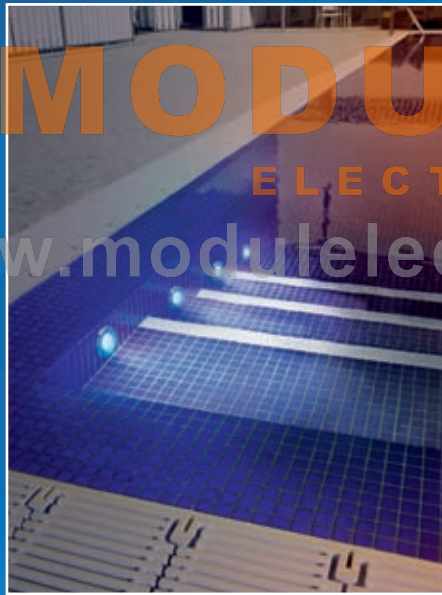



 **MODUL**   
ELECTRO  
[www.modulelectro.ru](http://www.modulelectro.ru)



**MUY IMPORTANTE** consulte la tabla de usos y mantenimiento en la página 290  
**VERY IMPORTANT** please consult the table on use and maintenance on page 290  
**TRÈS IMPORTANT** consultez la table d'utilisation et de maintenance de la page 290

**WICHTIG** Bitte beachten Sie die Tabelle der Gebrauchs- und Instandhaltungsanweisungen auf Seite 290  
**MOLTO IMPORTANTE** si consulti la tabella di uso e manutenzione a pagina 290  
**MUITO IMPORTANTE** consulte a tabela de uso e manutenção na página 290

Materiales / Materials



Incluido / Included



Especificaciones / Specifications

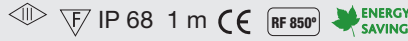

Acabados / Finishes

Y4 Acero inoxidable  
Stainless steel  
Acier inoxidable  
Rostfreier Stahl  
Acciaio inossidabile  
Aço inoxidável

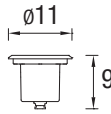

55-9377-Y4-37

3 x 1W LED 12-24V AC Cool White 6500K <40°C

IP 68 1 m 2 281 IK 10

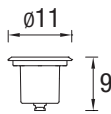
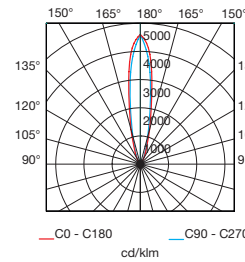

55-9378-Y4-37

3 x 1W LED RGB pag. 245 <40°C

IP 68 1 m 2 281 IK 10

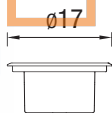
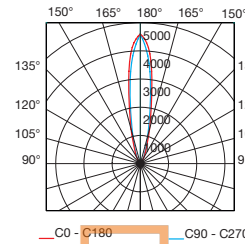

55-9354-Y4-37

9 x 1W LED 12-24V AC Cool White 6500K <40°C

IP 68 1 m 2 280 IK 09

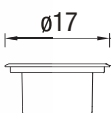
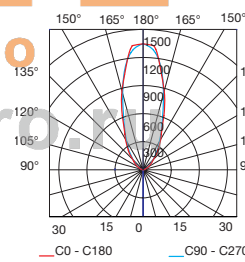

55-9355-Y4-37

9 x 1W LED RGB pag. 245 <40°C

IP 68 1 m 2 280 IK 09

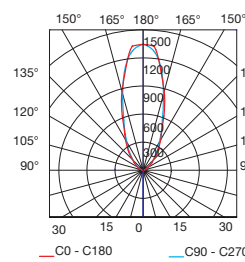

71-9396-05-05

Conector IP 68 3 vías forma "T" 3 polos.  
IP 68 connection 3 ways T shape x 3 wires.



71-9197-05-05

Transformador estanco. 230/12V AC - 100W.  
Water proof transformer. 230/12V AC - 100W.



71-9397-05-05

Conector IP 68 2 vías 3 polos.  
IP 68 connection 2 ways 3 wires.

IP 68 1 m 6

Equipos para 55-9378 /55-9355 / (ver pág. 245)  
Gears for 55-9378 /55-9355 (see page 245)

71-9403-34-34 50W 71-9495-34-34 50W MASTER  
71-9404-34-34 100W 71-9496-34-34 100W MASTER  
71-9497-34-34 100W SLAVE

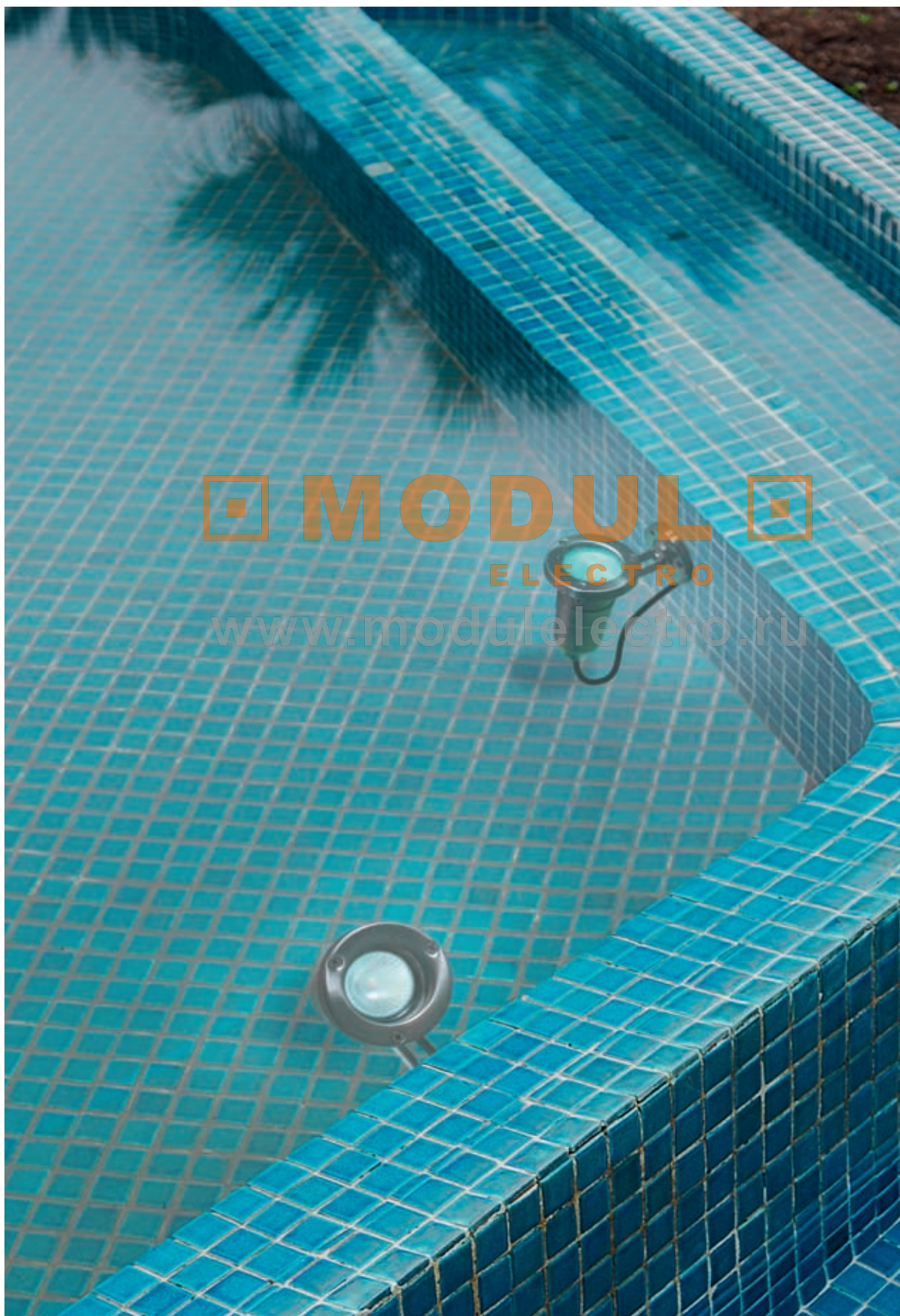

Materiales / Materials



Especificaciones / Specifications

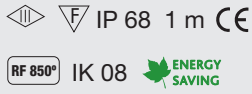

Acabados / Finishes

Y4 Acero inoxidable  
Stainless steel  
Acier inoxydable  
Rostfreier Stahl  
Acciaio inossidabile  
Aço inoxidável

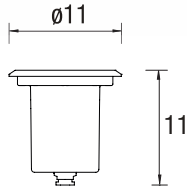

**55-9245-Y4-37**

MR-16 max. 50W - 12VAC >80°C

MR-16 max. 5W LED <40°C

IP 68 1 m 12 279 IK 08

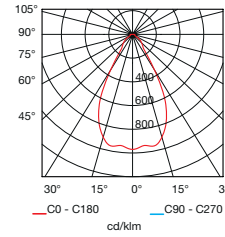

D[m]	MedLux
5	5.77 54.4
4	4.62 68
3	3.46 122
2	2.31 275
1	1.15 591

H alpha= 30°+ 30°

**MODULO**

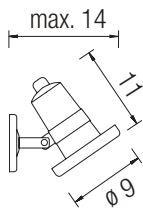

**05-9245-Y4-37**

MR-16 max. 50W - 12VAC

MR-16 max. 5W LED

IP 68 1 m 12 IK 08

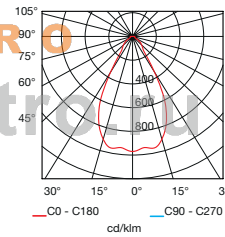
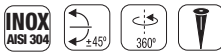

D[m]	MedLux
1	1.15 591
2	2.31 275
3	3.46 122
4	4.62 68
5	5.77 54.4

H alpha= 30°+ 30°



MUY IMPORTANTE consulte la tabla de usos y mantenimiento en la página 290  
VERY IMPORTANT please consult the table on use and maintenance on page 290  
TRÈS IMPORTANT consultez la table d'utilisation et de maintenance de la page 290

WICHTIG Bitte beachten Sie die Tabelle der Gebrauchs- und Instandhaltungsanweisungen auf Seite 290  
MOLTO IMPORTANTE si consulti la tabella di uso e manutenzione a pagina 290  
MUITO IMPORTANTE consulte a tabela de uso e manutenção na página 290



**71-9197-05-05**

Transformador estanco para lámparas halógenas. 230/12V AC-100W.  
Water proof transformer for halogen bulbs. 230/12V AC-100W.

IP 68 1 m 6





## Xena collection ®

- Colección de empotrables de suelo especialmente diseñados para la señalización de zonas de paso. Cuerpo en tecnopolímero de altas prestaciones y protectores en aluminio de alta calidad y policarbonato. Alto grado de resistencia al paso de vehículos y a la corrosión. Con los filtros de color obtenemos vistosos efectos de luz.
- Floor embedding collection specifically designed for traffic areas signposting. Body made of high performance technopolymere, high quality aluminium and polycarbonate. Highly resistant to vehicles traffic and corrosion. We obtain colourful light effects with their colour filters.
- Collection d'encastrés de sol spécialement conçus pour la signalisation de zones de passage. Corps en technopolymère aux prestations élevées et protecteurs en aluminium haute qualité et en polycarbonate. Forte résistance au passage de véhicules et à la corrosion. Les filtres de couleur permettent de superbes effets de lumière.
- Kollektion von Bodeneinbauleuchten, insbesondere zum Signalisieren von Durchgangsbereichen gedacht. Gehäuse aus hochwertigem Technikpolymer und Schutzschirm aus hochwertigem Aluminium und Polykarbonat. Hoher Grad an Beständigkeit gegenüber Durchgangsverkehr und Korrosion. Mit Farbfiltern können attraktive Lichteffekte erzeugt werden.
- Collezione di lampade da incasso a terra specialmente studiate per zone di passaggio. Corpo in tecnopolimero dalle alte prestazioni e proiettori in alluminio di alta qualità e policarbonato. Alto grado di resistenza al passaggio dei veicoli e alla corrosione. Con i filtri di colore è possibile ottenere vistosi effetti luminosi.
- Colecção de embutidos de chão especialmente desenhados para a sinalização de zonas de passagem. Corpo em tecnopolímero de altas prestações e protectores em alumínio de alta qualidade e policarbonato. Alto grau de resistência com a passagem de veículos e à corrosão. Com os filtros de cor obtemos vistosos efeitos de luz.

® Registration number: Pending

MODULO

ELECTRO

www.modulelectro.ru





**MODUL**  
ELECTRO

[www.modulelectro.ru](http://www.modulelectro.ru)

Materiales / Materials



Incluido / Included



Especificaciones / Specifications

⊕ ⊖ IP 67 CE ENERGY SAVING IK 10



5000kg

Acabados / Finishes

M3 Difusor de policarbonato mate  
 Matt polycarbonate diffuser.  
 Difuseur en polycarbonate mat.  
 Diffusore di polycarbonato matt.  
 Matter Diffusor aus Polykarbonat  
 Difusor de policarbonato mate.

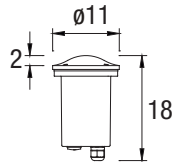

**55-9421-M3-M3**

GU-10 max. 14W Fluorescent <40°C

GU-10 max. 5W LED <40°C

IP 67 8 ENERGY SAVING 281 IK 10

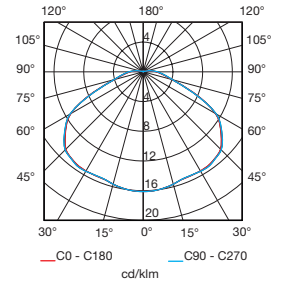

**MODULO**  
**ELECTRO**

[www.modulelectro.ru](http://www.modulelectro.ru)

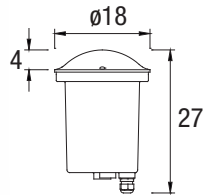

**55-9425-M3-M3**

PL elect. E-27 max. 20W <40°C

IP 67 6 ENERGY SAVING 281 IK 10

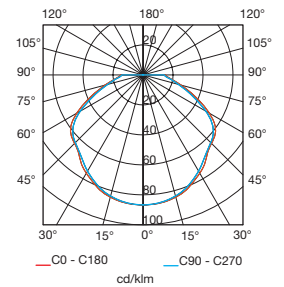

Materiales / Materials

TEC  
POLI

ALU  
PUR

PC

CRIS  
MAT

Especificaciones / Specifications



IP 67



IK 10



5000kg

Acabados / Finishes

34 Gris  
Grey  
Gris  
Grau  
Grigio  
Cinzeno

Z5 Gris urbano  
Urban grey  
Gris urbain  
Anthrazit  
Grigio urbano  
Cinzeno urbano



**MODUL**  
ELECTRO  
[www.modulelectro.ru](http://www.modulelectro.ru)

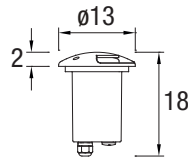

**55-9423-34-T2** ■  
**55-9423-Z5-T2** ■

12 x 0,1W LED 230V Neutral white 4200K <40°C

IP 67 8 280 IK 10

**Included**

12 x 0,1W LED **Included**

**TEC POLI** **ALU PUR**

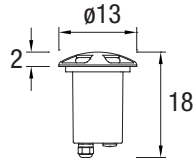
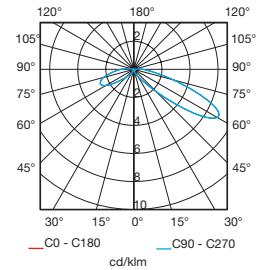

**55-9424-34-T2** ■  
**55-9424-Z5-T2** ■

12 x 0,1W LED 230V Neutral white 4200K <40°C

IP 67 8 280 IK 10

**Included**

12 x 0,1W LED **Included**

**TEC POLI** **ALU PUR**

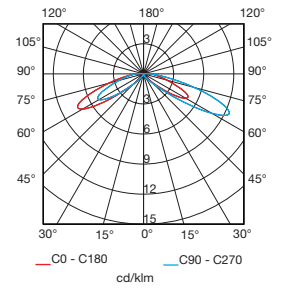

(new)



**71-9476-08-08** ■  
**71-9476-11-11** ■  
**71-9476-24-24** ■  
**71-9476-25-25** ■

Filtros de colores para referencias 55-9423 y 55-9424  
Color filters for references 55-9423 and 55-9424

Cada código incluye 2 filtros  
Each code includes 2 filters

**PC**

www.modulelectro.ru

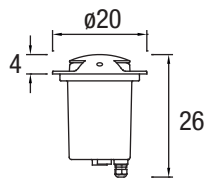

**55-9427-34-T2** ■  
**55-9427-Z5-T2** ■

PL elect. E-27 max. 20W 40-80°C

IP 67 4 281 IK 10

**TEC POLI** **ALU PUR**

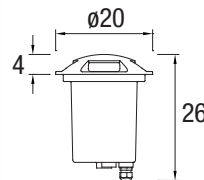
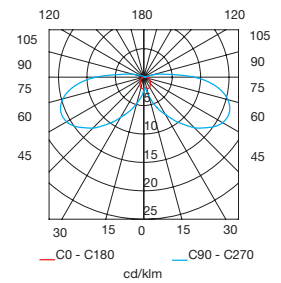

**55-9428-34-T2** ■  
**55-9428-Z5-T2** ■

PL elect. E-27 max. 20W 40-80°C

IP 67 4 281 IK 10

**TEC POLI** **ALU PUR**

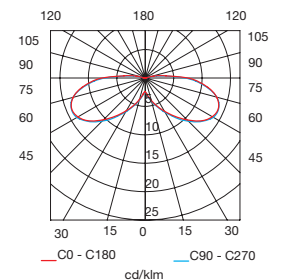

(new)



**71-9477-08-08** ■  
**71-9477-11-11** ■  
**71-9477-24-24** ■  
**71-9477-25-25** ■

Filtros de colores para referencias 55-9427 y 55-9428  
Color filters for references 55-9427 and 55-9428

Cada código incluye 2 filtros  
Each code includes 2 filters

**PC**





### Cubik collection

- Colección de sobremuros y balizas realizada con difusor de policarbonato satinado y aluminio extrusionado, con varias posibilidades de acabados. Los modelos, que están disponibles en tres tamaños, favorecen el ahorro energético y la anti-contaminación luminica.
- Wall lights and buoys collection made of extrusionated aluminium and shiny polycarbonate diffuser , with several finishes possibilities. Three eco friendly sizes available.
- Collection de bornes et de balises munies d'un diffuseur en polycarbonate satiné et en aluminium extrudé avec plusieurs finitions possibles. Disponibles en trois dimensions, ces modèles favorisent l'économie d'énergie et sont anti-pollution lumineuse.
- Kollektion aus Mauerleuchten und Signalleuchten aus extrudiertem Aluminium mit Diffusor aus satiniertem Polykarbonat. In verschiedenen Ausführungen erhältlich. Die in drei Größen lieferbaren Leuchten tragen zum Energiesparen und zur Eindämmung der Lichtverschmutzung bei.
- Collezione di lampade a muro e piantane realizzata con diffusore di policarbonato satinato e alluminio estruso con varietà di finiture. I modelli, disponibili in tre grandezze, favoriscono il risparmio energetico e limitano la contaminazione luminosa.
- Coleção de sobre muros e balizas realizada com difusor de policarbonato acetinado e alumínio extrusado com várias possibilidades de acabamentos. Os modelos, que estão disponíveis em três tamanhos, favorecem a poupança energética e a anti-contaminação de luz.

  
ELECTRO  
[www.modulelectro.ru](http://www.modulelectro.ru)







Materiales / Materials



Especificaciones / Specifications



Acabados / Finishes

■ 34 Gris Grey	■ K7 Gris acabado piedra Stone grey	■ Z5 Gris urbano Urban grey
■ Gris Gris	■ Gris pierre	■ Gris urbain
■ Grau Steingrau	■ Grigio pietra	■ Anthrazit
■ Grigio Cinzento	■ Cinzento pedra	■ Grigio urbano
		■ Cinzento urbano

(new)

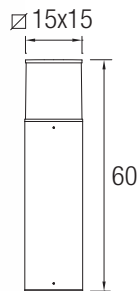

**55-9488-34-M3** ■  
**55-9488-Z5-M3** ■

○ E-27 max. 60W  
 ≡ PL elect. E-27 max. 23W

IP 54 ☒ 2 🌿 IK 10

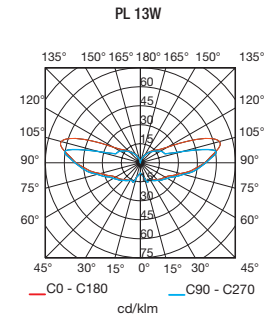

# MODULO ELECTRO

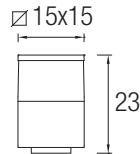

**10-9386-34-M3** ■  
**10-9386-K7-M3** ■  
**10-9386-Z5-M3** ■

○ E-27 max. 60W  
 ≡ PL elect. E-27 max. 18W

IP 54 ☒ 4 🌿 IK 10

≡ 13W Included

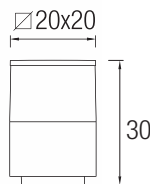
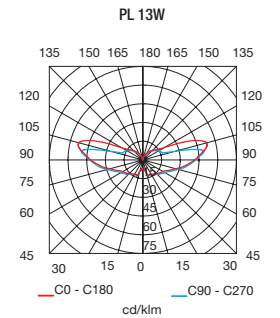

**10-9387-34-M3** ■  
**10-9387-K7-M3** ■  
**10-9387-Z5-M3** ■

○ E-27 max. 100W  
 ≡ PL elect. E-27 max. 23W

IP 54 ☒ 4 🌿 IK 10

≡ 18W Included

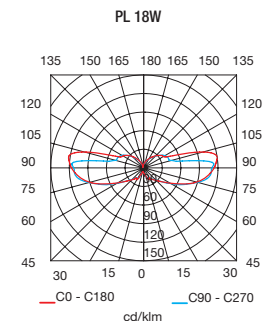



## Mariner collection

- Luminaria realizada en aluminio de alta calidad y con difusor de policarbonato. Su cuidado diseño la hace idónea tanto para ambientes modernos como clásicos.
- Luminaires made of high quality aluminium and a polycarbonate diffuser. Its timeless design is suitable for both classic and modern environments.
- Luminare fabriqué en aluminium de grande qualité et muni d'un diffuseur en polycarbonate. Son design soigné le rend idéal dans tous les environnements, qu'ils soient modernes ou classiques.
- Leuchte aus hochwertigem Aluminium mit Diffusor aus Polykarbonat. Das ausgefeilte Design passt zu modernen und klassischen Räumen gleichermaßen.
- Lampada realizzata in alluminio di alta qualità e con diffusore incorporato. La sua estetica la rende perfetta sia in ambienti moderni che di stile classico.
- Lustre realizado em alumínio de alta qualidade e com difusor de policarbonato. O seu cuidado desenho fá-lo idónea tanto para ambientes modernos como clássicos.

® Registration number: Pending



Materiales / Materials



Especificaciones / Specifications

⊕ ⚡ IP 55 CE ENERGY SAVING RF 850° IK 10

Acabados / Finishes

- Z5 Gris urbano
- Urban grey
- Gris urbain
- Anthrazit
- Grigio urbano
- Cinzeno urbano

(new)

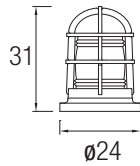

10-9475-Z5-M2 ■

⦿ E-27 max. 60W

▶ PL elect. E-27 max. 23W

IP 55 2 278 IK 10

PL 23W

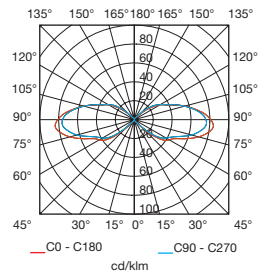

**MODULO**  
ELECTRO

[www.modulelectro.ru](http://www.modulelectro.ru)

**Materiales / Materials**



**Especificaciones / Specifications**



**Acabados / Finishes**

- Z5 Gris urbano
- Urban grey
- Gris urbain
- Anthrazit
- Grigio urbano
- Cinzeno urbano



**MODULO**  
**ELECTRO**  
[www.modulelectro.ru](http://www.modulelectro.ru)

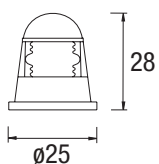

**10-9116-Z5-M2 ■**

E-27 max.60W

PL elect. E-27 max. 23W

IP 54 2 277

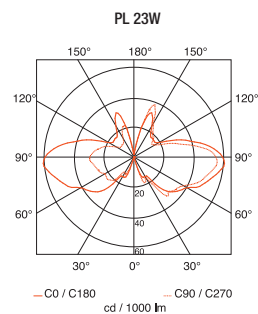

# BRIDGE

## Materiales / Materials



## Especificaciones / Specifications



## Acabados / Finishes

-  Y4 Acero inoxidable
- Stainless steel
- Acier inoxidable
- Rostfreier Stahl
- Acciaio inossidabile
- Aço inoxidável

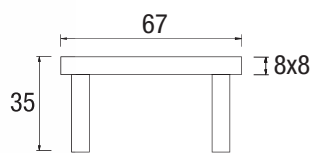

**55-9263-Y4-37**  (S)

 2G11 36W

IP 44   2  279 

 36W +  **Included**



## Newton collection

- De diseño moderno, se adapta a cualquier ambiente. Realizada en aluminio de alta calidad y con difusor de policarbonato transparente. Disponible para lámparas fluorescentes y descarga.
- Modern design, suitable for any environment. Made of high quality aluminium and a clear polycarbonate diffuser. Fluorescent and discharge lamps available.
- De design moderne, ce luminaire s'adapte à n'importe quel environnement. Fabriqué en aluminium de grande qualité et muni d'un diffuseur en polycarbonate transparent. Disponible pour les lampes fluorescentes et à décharge.
- Passt mit ihrem modernen Design zu jeder Umgebung. Leuchte aus hochwertigem Aluminium mit Diffusor aus transparentem Polykarbonat. Lieferbar für fluoreszierende Lampen und Entladungslampen.
- Dal design moderno, si adatta a qualsiasi tipo di ambiente. Realizzata in alluminio di alta qualità e con diffusore di policarbonato trasparente. Disponibile sia per lampadine fluorescenti che per lampadine a scarica.
- De desenho moderno, adapta-se a qualquer ambiente. Realizada em alumínio de alta qualidade e com difusor de policarbonato transparente. Disponível para lâmpadas fluorescentes e descarga.

® Registration number: Pending



Materiales / Materials



Especificaciones / Specifications



Acabados / Finishes

■ 34 Gris	■ Z5 Gris urbano
Grey	Urban grey
Gris	Gris urbain
Grau	Anthrazit
Grigio	Grigio urbano
Cinzeno	Cinzeno urbano

(new)

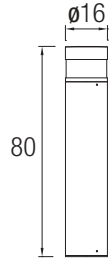

55-9504-34-M2 ■

55-9504-Z5-M2 ■

PL elect. E-27 max. 23W

IP 54 2 281 IK 08

(new)



55-9505-34-M2 ■

55-9505-Z5-M2 ■

G8.5 35W HID

IP 54 2 281 IK 08

Included

(new)

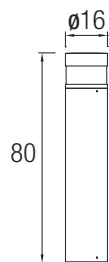

55-9506-34-M2 ■

55-9506-Z5-M2 ■

G8.5 70W HID

IP 54 2 281 IK 08

Included

**MODULO**  
**ELECTRO**  
[www.moduloelectro.ru](http://www.moduloelectro.ru)





## Torch collection

- Luminaria de diseño moderno realizada en aluminio de alta calidad y con difusor de policarbonato. Su IK10 lo hace ideal para las condiciones más exigentes.
- Modern design luminaire made of high quality aluminium and polycarbonate diffuser. Its IK10 makes it perfect for the most demanding conditions.
- Luminaire au design moderne fabriqué en aluminium de grande qualité et muni d'un diffuseur en polycarbonate. Son indice IK10 le rend idéal pour les conditions les plus exigeantes.
- Leuchte in modernem Design aus hochwertigem Aluminium mit Diffusor aus Polykarbonat. Dank IK10 ideal für anspruchsvolle Einsatzbedingungen.
- Lampada dal design moderno realizzata in alluminio di alta qualità e con diffusore di policarbonato. Il suo IK10 la rende ideale per le condizioni più esigenti.
- Lustre de desenho moderno realizada em alumínio de alta qualidade e com difusor de policarbonato. A sua IK10 faz dele ideal para as condições mais exigentes.

® Registration number: Pending



Materiales / Materials



Especificaciones / Specifications



Acabados / Finishes

- Z5 Gris urbano
- Urban grey
- Gris urbain
- Anthrazit
- Grigio urbano
- Cinzeno urbano



(new)

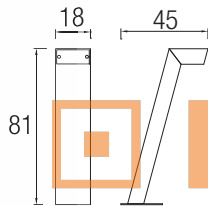
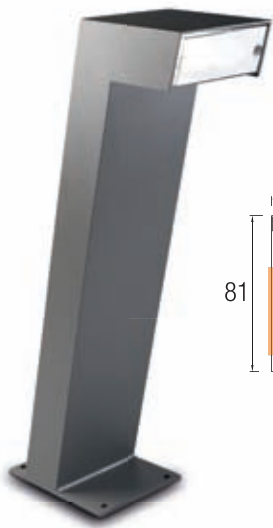

**55-9459-Z5-M3** ■

2 x PL elect. E-27 max. 18W

IP 65 2 281 ENERGY SAVING IK 10

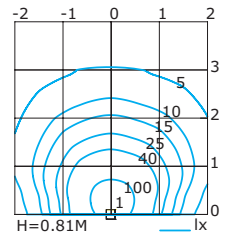
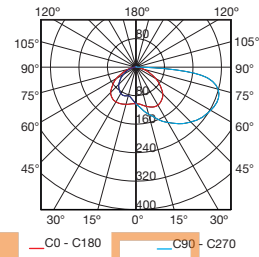

**MODULO ELECTRO**

**55-9529-Z5-M3** ■

2 x GX24d-3 26W Fluor

IP 65 2 281 ENERGY SAVING IK 10

BAG Included

[www.modulelectro.ru](http://www.modulelectro.ru)

# MOONLIGHT



Design by Francesc Vilaró

## Moonlight collection

- Lámpara de pie, con cuerpo de aluminio de alta calidad acabado en gris oscuro y pantalla de polietileno. Incluye pantalla opaca para evitar la contaminación lumínica, al mismo tiempo que crea un ambiente más íntimo. Interruptor incorporado.
- Standard lamp with high quality aluminium body, dark grey finish and polyethylene lampshade. It includes an eco friendly opaque lampshade, wich creates an intimate environment. Integrated switch.
- Lampadaire muni d'un corps en aluminium de grande qualité en gris foncé et d'un abat-jour en polyéthylène. Comprend un abat-jour opaque qui permet d'éviter la pollution lumineuse et de créer une ambiance plus intime. Interrupteur incorporé.
- Stehleuchte mit Körper aus hochwertigem Aluminium , Finish in Dunkelgrau und Schirm aus Polyethylen. Einschließlich opakem Schirm zur Eindämmung der Lichtverschmutzung und Schaffung eines intimen Ambientes. Inkl. Schalter.
- Lampada da terra con corpo in alluminio di alta qualità con finiture grigio scuro e paralume in polietilene. Include paralume opaco per evitare la contaminazione luminosa, oltre a creare un ambiente piú intimo. Interruttore incorporato.
- Lámpada de pé com corpo de alumínio de alta qualidade acabamentoo em cinzento-escuro e tela de polietileno. Incluí tela opaca para evitar a contaminação de luz, ao mesmo tempo que cria um ambiente mais íntimo. Interruptor incorporado.

® Registration number: Pending



**MODULO**  
ELECTRO  
[www.moduloelectro.ru](http://www.moduloelectro.ru)

Materiales / Materials



Incluido / Included



Especificaciones / Specifications



Acabados / Finishes

- Z5 Gris urbano
- Urban grey
- Gris urbain
- Anthrazit
- Grigio urbano
- Cinzeno urbano

(new)

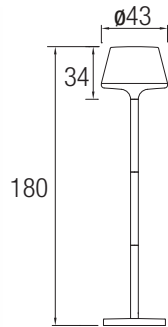

**25-9503-Z5-M1** ■

E-27 max. 100W

PL elect. E-27 max. 30W

IP 44 2 IK 08

Con interruptor y pantalla opaca incluida. Consultar disponibilidad  
With switch and opaque lampshade included. Check availability

**MODULO**  
ELECTRO  
[www.modulelectro.ru](http://www.modulelectro.ru)

# QUADRA

Design by Josep Juanola

148

Quadra

## Quadra collection

- Colección de diseño contemporáneo realizada en aluminio extrusionado y en acabado plata. Una serie pensada para la señalización de zonas de paso exteriores. La pieza utiliza lámparas de bajo consumo 26W fluorescencia, para garantizar el ahorro energético. Equipo incluido.
- Contemporary design collection made of extruded aluminum and with silver finish. A suitable series for outdoors signposting. The part uses 26W fluorescent low consumption lamps, in order to ensure energetic savings. Equipment included.
- Design contemporain pour cette collection réalisée en aluminium extrudé et en finition argent. Une série constituée de deux balises pensées pour la signalisation de zones de passages extérieures. Série conçue pour la signalisation de zones de passage extérieures. Cette pièce est munie de lampes basse consommation de 26 W à fluorescence, qui garantissent l'économie d'énergie. Dispositif compris.
- Eine Kollektion in zeitgemäßem Design aus stranggepresstem Aluminium und in Silber ausgefertigt. Eine Serie zur Signalisierung von Durchgangsbereiche im Freien. Die Leuchte funktioniert mit 26 W fluoreszierenden Energiesparlampen, um den Energieverbrauch zu senken. Inklusive Aggregat.
- Collezione dal design contemporaneo realizzata in alluminio estruso e con finitura argento. Una serie pensata per la segnalazione delle zone di passaggio esterne. Da usare con lampadine a basso consumo 26W fluorescenti, per garantire il risparmio energetico. Impianto integrato.
- Coleção de concepção contemporânea feita em alumínio extrusionado e com acabamento cor prata. Uma série pensada para a sinalização de zonas de passagem exteriores. A peça utiliza lâmpadas de baixo consumo 26W fluorescência, para garantir a poupança energética. Equipamento incluido.

 Registration number: 001091375-026



Materiales / Materials



Especificaciones / Specifications

IP 44 CE RF 850° ENERGY SAVING IK 03

Acabados / Finishes

- 34 Gris
- Grey
- Gris
- Grau
- Grigio
- Cinzeno

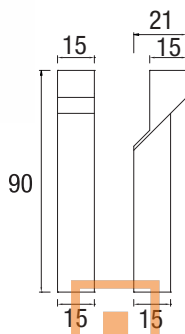

**55-9374-34-T2** ■

2 x GX24d-3 26W Fluo

IP 44 2 ENERGY SAVING IK 03

BAG Included

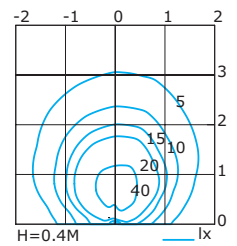
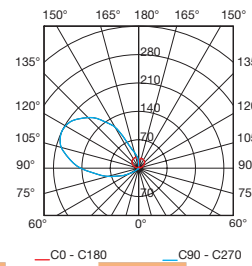

**MODULO**  
**ELECTRO**

[www.modulelectro.ru](http://www.modulelectro.ru)

# NOTT



Design by Josep Juanola

150

Nott

## Nott collection

- Colección realizada en aluminio extrusionado y difusor de policarbonato satinado. Serie de diseño moderno formada por dos balizas con dos acabados diferentes, preparadas para el uso de lámparas de bajo consumo.
- A collection made of extruded aluminium and satin polycarbonate diffuser. A modern design collection with two beacons in two different finishes, prepared for the use of energy-saving lamps.
- Une collection en aluminium extrudé et diffuseur en polycarbonate satiné. Une série au design moderne composée de deux balises de finitions distinctes permettant l'utilisation de lampes basse consommation.
- Eine Kollektion, hergestellt aus extrudiertem Aluminium mit Diffusor aus satiniertem Polykarbonat. Es ist eine moderne Produktserie, die aus zwei Leuchtbacken unterschiedlicher Ausführungen besteht und für den Gebrauch von Energiesparlampen geeignet ist.
- Collezione realizzata in alluminio estruso e diffusore in policarbonato satinato. Serie dal design moderno formata da due faretti con due rifiniture differenti, predisposte per l'uso di lampade a basso consumo.
- Coleção feita em alumínio extrusionado e difusor de policarbonato acetinado. Série de concepção moderna composta por duas sinalizações com dois acabamentos diferentes, preparadas para o uso de lâmpadas de baixo consumo.



Materiales / Materials



Especificaciones / Specifications



Acabados / Finishes

■ 34 Gris	■ Z5 Gris urbano
■ Grey	■ Urban grey
■ Gris	■ Gris urbain
■ Grau	■ Anthrazit
■ Grigio	■ Grigio urbano
■ Cinzento	■ Cinzento urbano

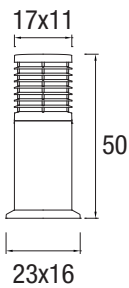

**55-9357-34-M3** ■  
**55-9357-Z5-M3** ■

○ E-27 max. 30W

⏏ PL elect. E-27 max. 23W

IP 44 IK 08

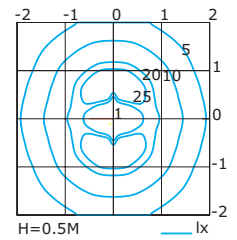
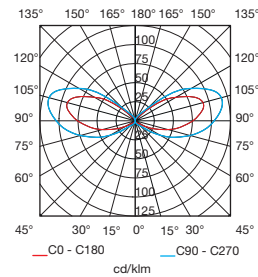

**MODULO**  
**ELECTRO**

[www.modulelectro.ru](http://www.modulelectro.ru)

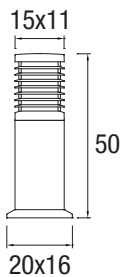

**55-9358-34-M3** ■  
**55-9358-Z5-M3** ■

○ E-27 max. 30W

⏏ PL elect. E-27 max. 23W

IP 44 IK 08

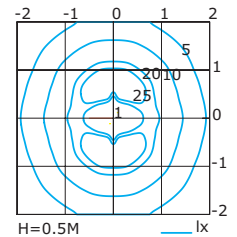
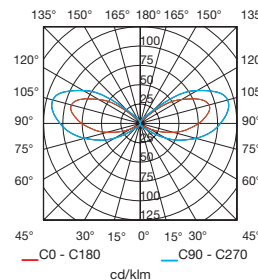





 **MODUL**   
ELECTRO  
[www.modulelectro.ru](http://www.modulelectro.ru)

## Balizas collection <sup>®</sup>

- Colección de balizas realizadas en aluminio. La serie está disponible en tres dimensiones y acabados diferentes. Una colección ideal para la iluminación de zonas ajardinadas, disponible para usar lámparas fluorescentes y halógenos metálicos.
- A collection of beacons made with aluminium. The collection is available in three different sizes and finishes. It is an ideal collection to light gardens, available for the use of fluorescent and metal halide lamps.
- Une collection de balises en aluminium. La série présente trois tailles et plusieurs types de finitions. Une collection idéale pour l'illumination des espaces verts et jardins, permettant l'utilisation de lampes fluorescentes et halogénures métalliques.
- Eine Kollektion von Leuchtbaken, Aluminium. Die Produktserie ist in drei Größen und in verschiedenen Ausführungen erhältlich. Sie ist besonders für die Beleuchtung von Gartenanlagen geeignet und für den Gebrauch von Leuchtstoff- und Halogenmetaldampflampen hergestellt worden.
- Collezione di faretti realizzati in alluminio. La serie è disponibile in tre dimensioni e rifiniture differenti. Una collezione ideale per l'illuminazione di zone a giardino, disponibile per l'uso con lampade fluorescenti e ad alogenuri metallici.
- Coleção de sinalizações feitas em alumínio. A série está disponível em três dimensões e acabamentos diferentes. Uma coleção ideal para iluminação de zonas ajardinadas, disponível com lâmpadas fluorescentes e halogenetos metálicos.

 **MODUL** 

® Registration number: 000966874-026 / 000966874-028

**ELECTRO**  
www.modulelectro.ru





Materiales / Materials



Especificaciones / Specifications



Acabados / Finishes

■ Z5 Gris urbano Urban grey Gris urbain Anthrazit Grigio urbano Cinzeno urbano	■ 34 Gris Grey Gris Grau Grigio Cinzeno
---	--

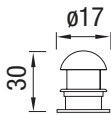

55-9334-34-M3 ■  
55-9334-Z5-M3 ■

⦿ E-27 max. 100W

⦿ PL elect. E-27 max. 23W

IP 44 ⚡ 6 ♀ 280 🌿 IK 08

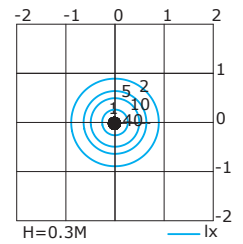
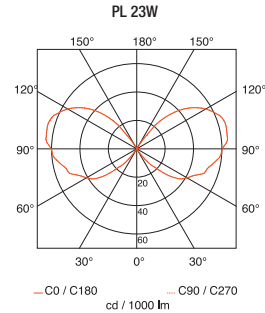

# MODULO ELECTRO

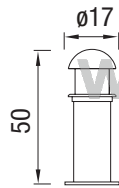

55-9335-34-M3 ■  
55-9335-Z5-M3 ■

⦿ E-27 max. 100W

⦿ PL elect. E-27 max. 23W

IP 44 ⚡ 4 ♀ 280 🌿 IK 08

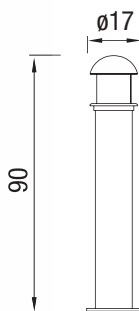
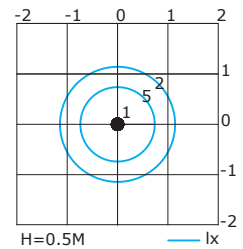
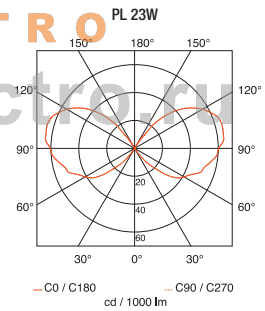

55-9336-34-M3 ■  
55-9336-Z5-M3 ■

⦿ E-27 max. 100W

⦿ PL elect. E-27 max. 23W

IP 44 ⚡ 4 ♀ 280 🌿 IK 08

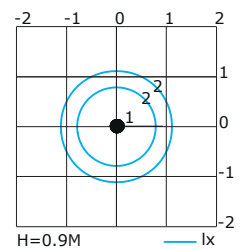
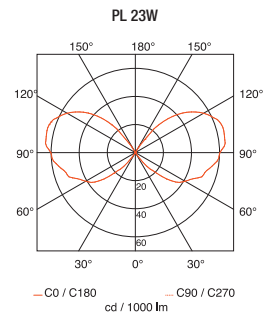



**MODUL**  
ELECTRO  
[www.modulelectro.ru](http://www.modulelectro.ru)

Materiales / Materials



Especificaciones / Specifications



Acabados / Finishes

■ 34 Gris Grey Gris Grau Grigio Cinzeno	■ J6 Marrón Brown Marron Braun Marrone Castanho	■ Z5 Gris urbano Urban grey Gris urbain Anthrazit Grigio urbano Cinzeno urbano
--	--	---

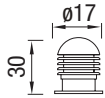

● 55-9318-34-M3 ■  
55-9318-J6-M3 ■  
55-9318-Z5-M3 ■

○ E-27 max. 100W  
▶ PL elect. E-27 max. 23W

IP 44 6 280 IK 08

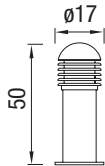
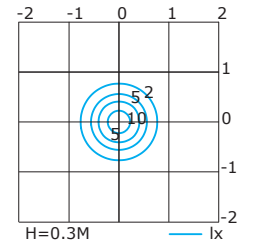
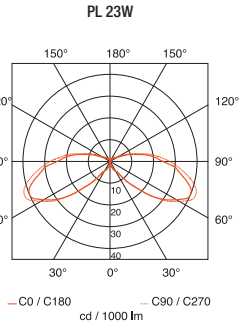

● 55-9319-34-M3 ■  
55-9319-J6-M3 ■  
55-9319-Z5-M3 ■

○ E-27 max. 100W  
▶ PL elect. E-27 max. 23W

IP 44 4 280 IK 08

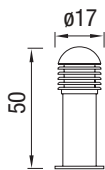
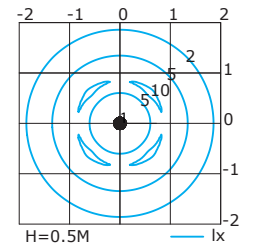
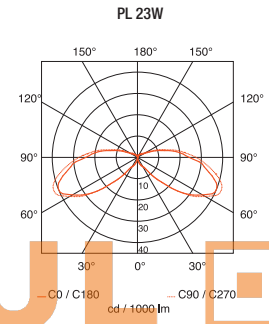

● 55-9342-34-M3 ■  
55-9342-J6-M3 ■  
55-9342-Z5-M3 ■

▶ G12 70W HID

IP 44 4 280 IK 08

Included

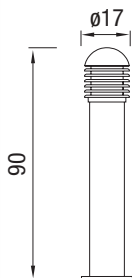
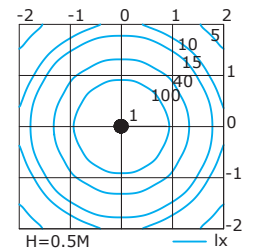
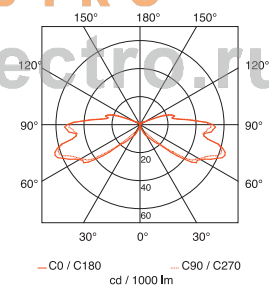

● 55-9320-34-M3 ■  
55-9320-J6-M3 ■  
55-9320-Z5-M3 ■

○ E-27 max. 100W  
▶ PL elect. E-27 max. 23W

IP 44 4 280 IK 08

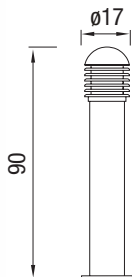
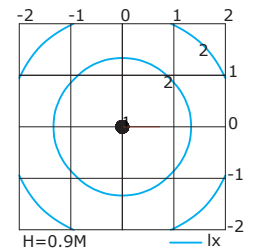
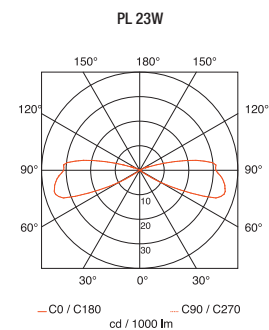

● 55-9343-34-M3 ■  
55-9343-J6-M3 ■  
55-9343-Z5-M3 ■

▶ G12 70W HID

IP 44 4 280 IK 08

Included

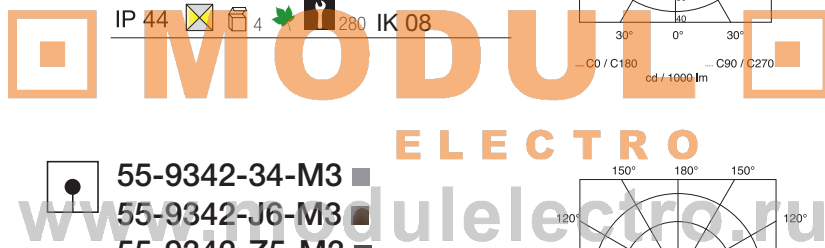
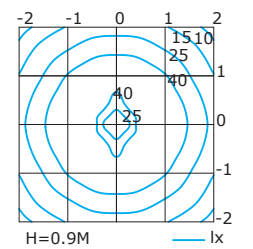
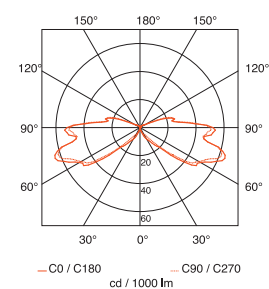

Materiales / Materials



Especificaciones / Specifications

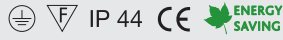

Acabados / Finishes

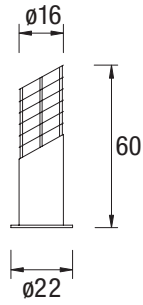
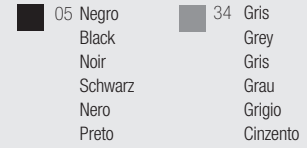

**55-8956-05-M1** ■  
**55-8956-34-M1** ■

⦿ E-27 max. 100W

⦿ PL elect. E-27 max. 23W

IP 44 ⚡ 4 ♻️ 278



# MODULO

## ELECTRO

MIDAS [www.modulelectro.ru](http://www.modulelectro.ru)

Materiales / Materials



Especificaciones / Specifications



Acabados / Finishes

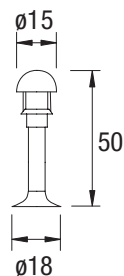
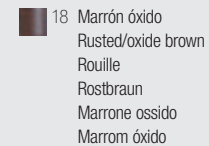

**10-9183-18-B8** ■

⦿ E-27 100W-HAL

⦿ PL elect. E-27 max. 23W

IP 44 ⚡ 4 ♻️ 277

⦿ 13W Included

# URANO

## Materiales / Materials



## Especificaciones / Specifications

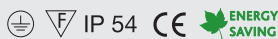

## Acabados / Finishes

- Z5 Gris urbano
- Urban grey
- Gris urbain
- Anthrazit
- Grigio urbano
- Cinzeno urbano

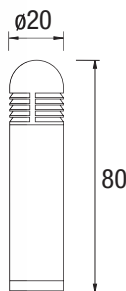

### 55-9237-Z5-M2

- E-27 max. 150W
- PL elect. E-27 max. 30W

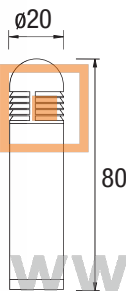
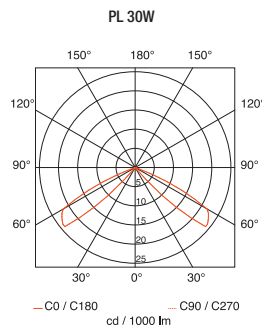

### 55-9272-Z5-M2

- G12 70W HID
- IP 54



Included

www.modulelectro.ru

# MERCURIO

## Materiales / Materials



## Especificaciones / Specifications

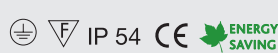

## Acabados / Finishes

- Z5 Gris urbano
- Urban grey
- Gris urbain
- Anthrazit
- Grigio urbano
- Cinzeno urbano

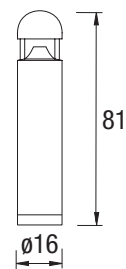

### 55-9125-Z5-M2

- E-27 max. 100W
- Mezcla E-27 max. 160W
- PL elect. E-27 max. 23W



23W Included

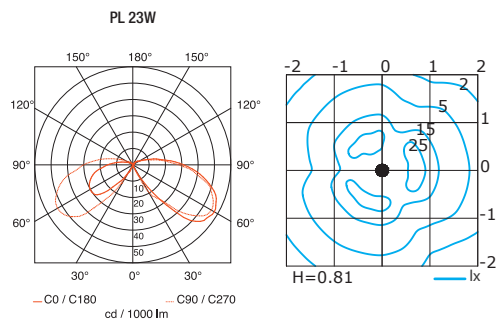





## Electra collection

- Amplia colección de diseño contemporáneo formada por applique, sobremuro y baliza. Una serie realizada en acero inoxidable apta para el uso de lámparas de bajo consumo.
- A large contemporary-design collection of wall fixtures, lanterns and beacons. They are made of stainless steel, suitable for the use of energy-saving lamps.
- Une vaste collection au design contemporain composée de balises, appliques et bornes. Une série en acier inoxydable permettant l'utilisation de lampes basse consommation.
- Umfangreiche Kollektion von modernem Design, bestehend aus Wandlampen, Lampen für Außenwände und Bakenleuchten. Die Produktserie ist aus rostfreiem Stahl hergestellt und eignet sich zur Benutzung von Energiesparlampen.
- Amplia collezione dal design contemporáneo formata da applique, base da muro e faretto. Una serie realizzata in acciaio inossidabile adatta all'uso di lampade a basso consumo.
- Ampla coleção de concepção contemporânea formada por applique, sobremuro e baliza. Uma série efectuada em aço inoxidável apta para o uso de lâmpadas de baixo consumo.

 **MODULO**   
**ELECTRO**  
[www.modulelectro.ru](http://www.modulelectro.ru)



Materiales / Materials



Especificaciones / Specifications



Acabados / Finishes

- Y4 Acero inoxidable
- Stainless steel
- Acier inoxydable
- Rostfreier Stahl
- Acciaio inossidabile
- Aço inoxidável

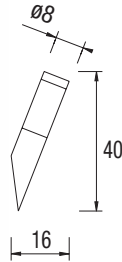

**05-8790-Y4-M1**

PL elect. E-27 Max. 23W

IP 55 4

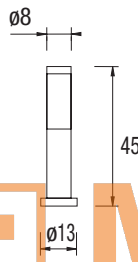

**10-8790-Y4-M1**

PL elect. E-27 Max. 23W

IP 55 4 277

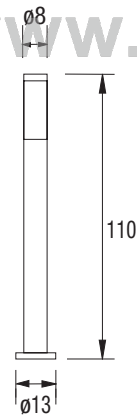

**55-8790-Y4-M1**

PL elect. E-27 Max. 23W

IP 55 2 277

**MODULO**  
ELECTRO

www.modulelectro.ru

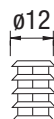

**55-8791-Y4-Y4**

Kit reflector / Spotlight kit

2



MUY IMPORTANTE consulte la tabla de usos y mantenimiento en la página 290  
 VERY IMPORTANT please consult the table on use and maintenance on page 290  
 TRÈS IMPORTANT consultez la table d'utilisation et de maintenance de la page 290

WICHTIG Bitte beachten Sie die Tabelle der Gebrauchs- und Instandhaltungsanweisungen auf Seite 290  
 MOLTO IMPORTANTE si consulti la tabella di uso e manutenzione a pagina 290  
 MUITO IMPORTANTE consulte a tabela de uso e manutenção na página 290



**MODUL**  
ELECTRO  
[www.modulelectro.ru](http://www.modulelectro.ru)

Materiales / Materials



Especificaciones / Specifications



Acabados / Finishes

- J6 Marrón
- Brown
- Marron
- Braun
- Marrone
- Castanho

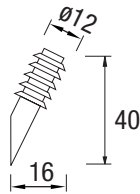

**05-9333-J6-M1** ■

PL elect. E-27 max. 23W

IP 55 4

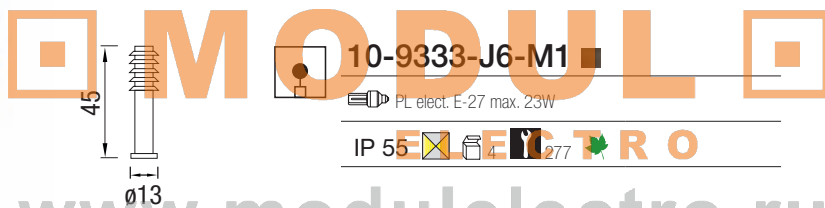

**10-9333-J6-M1** ■

PL elect. E-27 max. 23W

IP 55 4 277

www.modulelectro.ru

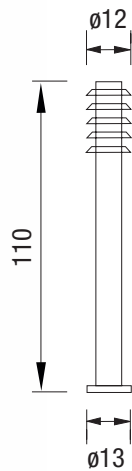

**55-9333-J6-M1** ■

PL elect. E-27 max. 23W

IP 55 2 277



## Priap collection

- Colección de acero inoxidable y difusor de policarbonato. Adecuada para uso con lámparas de bajo consumo, presenta un diseño estilizado y atractivo.
- A collection made of stainless steel and a polycarbonate diffuser. It is suitable for the use of energy-saving lamps. It has an attractive and stylish design.
- Une collection en acier inoxydable et diffuseur en polycarbonate. Compatible avec l'utilisation de lampes basse consommation, cette collection présente un design stylisé et attractif.
- Die Kollektion ist aus rostfreiem Stahl hergestellt und verfügt über einen Diffusor aus Polykarbonat. Sie eignet sich zum Gebrauch von Energiesparlampen und besitzt ein stilisiertes und sehr attraktives Design.
- Collezione in acciaio inossidabile con diffusore in policarbonato. Adeguata all'uso di lampade a basso consumo, presenta un design stilizzato e attraente.
- Coleção de aço inoxidável e difusor de policarbonato. Adequada para uso com lâmpadas de baixo consumo, apresenta uma concepção estilizada e atractiva.



**MODUL**  
ELECTRO  
[www.modulelectro.ru](http://www.modulelectro.ru)



Materiales / Materials



Especificaciones / Specifications



Acabados / Finishes

Y4 Acero inoxidable  
Stainless steel  
Acier inoxydable  
Rostfreier Stahl  
Acciaio inossidabile  
Aço inoxidável

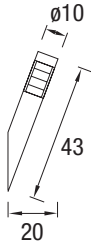

**05-9239-Y4-M2**

E-27 max. 60W  
PL elect. E-27 max. 23W

IP 54

11W Included

PL 23W

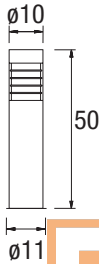
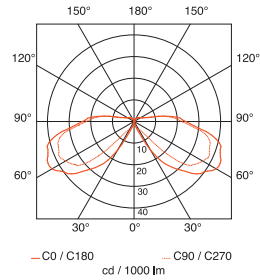

**55-9239-Y4-M2**

E-27 max. 60W  
PL elect. E-27 max. 23W

IP 54

11W Included

PL 23W

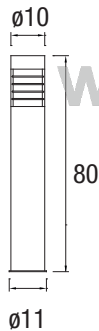
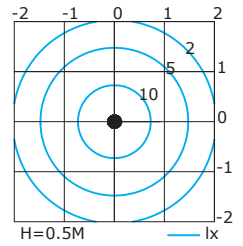
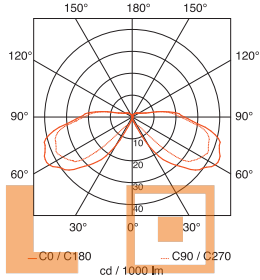

**55-9440-Y4-M2**

E-27 max. 60W  
PL elect. E-27 max. 23W

IP 54

15W Included

PL 23W

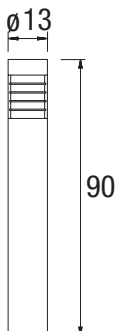
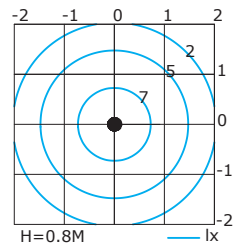
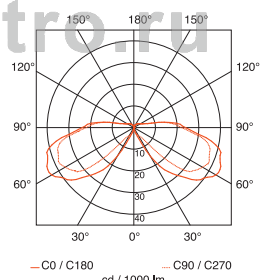

**55-9317-Y4-M2**

E-27 max. 100W  
PL elect. E-27 max. 23W

IP 54

18W Included

PL 23W

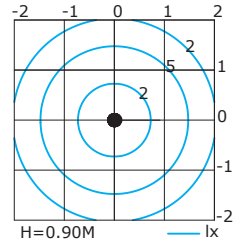
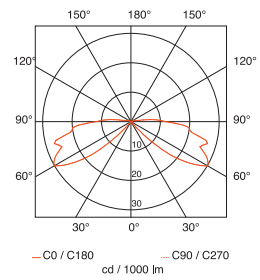

**MODULO ELECTRO**

www.modulelectro.ru



MUY IMPORTANTE consulte la tabla de usos y mantenimiento en la página 290  
VERY IMPORTANT please consult the table on use and maintenance on page 290  
TRÈS IMPORTANT consultez la table d'utilisation et de maintenance de la page 290

WICHTIG Bitte beachten Sie die Tabelle der Gebrauchs- und Instandhaltungsanweisungen auf Seite 290  
MOLTO IMPORTANTE si consulti la tabella di uso e manutenzione a pagina 290  
MUITO IMPORTANTE consulte a tabela de uso e manutenção na página 290

# NEREO



## Materiales / Materials



## Especificaciones / Specifications



## Acabados / Finishes

- Y4 Acero inoxidable
- Stainless steel
- Acier inoxydable
- Rostfreier Stahl
- Acciaio inossidabile
- Aço inoxidável



**MODUL**  
ELECTRO  
[www.modulelectro.ru](http://www.modulelectro.ru)

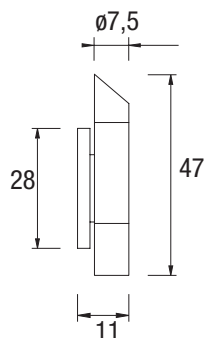

**05-8796-Y4-M1** ■

PL elect. E-27 20W - GE

IP 44   

# ARIADNA

## Materiales / Materials



## Especificaciones / Specifications





## Acabados / Finishes

-  Z5 Gris urbano
- Urban grey
- Gris urbain
- Anthrazit
- Grigio urbano
- Cinzeno urbano

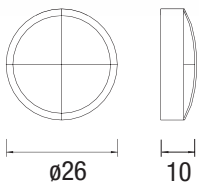

**MODULO**  
ELECTRO  
[www.modulelectro.ru](http://www.modulelectro.ru)



**15-9153-Z5-B8** 

 E-27 max. 100W

 PL elect. E-27 max. 23W

IP 54   4 

 **23W Included**

PL 23W

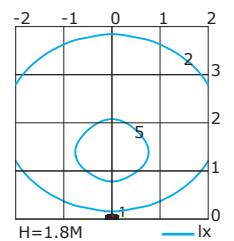
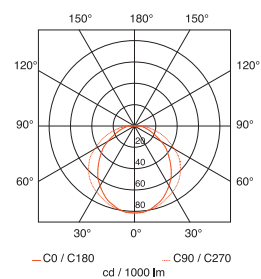



# ARMONIA

168  
Armonia

## Materiales / Materials



## Especificaciones / Specifications



## Acabados / Finishes

 Y4 Acero inoxidable  
Stainless steel  
Acier inoxydable  
Rostfreier Stahl  
Acciaio inossidabile  
Aço inoxidável



2 Frontales incluidos.  
2 front covers included.  
2 couvercles compris.

2 Frontteile inklusive.  
2 frontali inclusi.  
2 frontais incluídos.

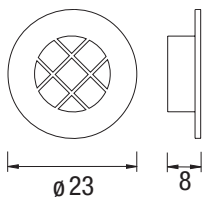

**05-9121-Y4-B8** ■

 E-27 max 60W



 PL elect. E-27 15W - GE

IP 45   4 

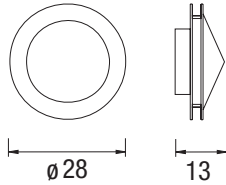

# PEGASO

Materiales / Materials	Especificaciones / Specifications	Acabados / Finishes
 	  IP 23  	 Y4 Acero inoxidable Stainless steel Acier inoxydable Rostfreier Stahl Acciaio inossidabile Aço inoxidável



 **15-8797-Y4-F9** 

 E-27  $\phi$ 45 max. 60W

IP 23   4



MUY IMPORTANTE consulte la tabla de usos y mantenimiento en la página 290  
 VERY IMPORTANT please consult the table on use and maintenance on page 290  
 TRÈS IMPORTANT consultez la table d'utilisation et de maintenance de la page 290

WICHTIG Bitte beachten Sie die Tabelle der Gebrauchs- und Instandhaltungsanweisungen auf Seite 290  
 MOLTO IMPORTANTE si consulti la tabella di uso e manutenzione a pagina 290  
 MUITO IMPORTANTE consulte a tabela de uso e manutenção na página 290



# MODUL ELECTRO

[www.modulelectro.ru](http://www.modulelectro.ru)

# IRENE

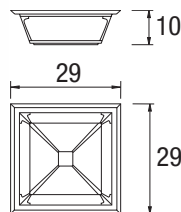

Materiales / Materials	Especificaciones / Specifications	Acabados / Finishes
 	  CE IP 44 	 18 Marrón óxido Rusted/oxide brown Rouille Rostbraun Marrone ossido Marrom óxido



 **15-9209-18-M3** 

 2 x E-27 max 60W

 2 x PL elect. E-27 max. 18W

IP 44   6 

 2 x 18W **Included**

# IDUN

Mimer / Idun  
170

### Materiales / Materials



### Especificaciones / Specifications



### Acabados / Finishes

-  Z5 Gris urbano  
Urban grey  
Gris urbain  
Anthrazit  
Grigio urbano  
Cinzeno urbano



## 15-9114-Z5-B8

 2 x E-27 max 100W

 2 x PL elect. E-27 max. 23W

IP 54   2 

### PL 23W

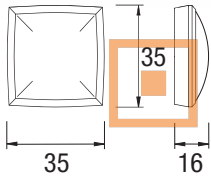
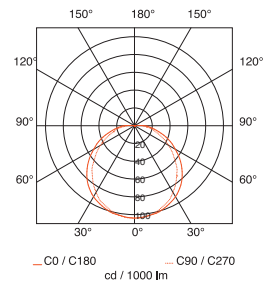

# MODULO

## ELECTRO

[www.modulelectro.ru](http://www.modulelectro.ru)

# MIMER

### Materiales / Materials



### Especificaciones / Specifications



### Acabados / Finishes

-  Z5 Gris urbano  
Urban grey  
Gris urbain  
Anthrazit  
Grigio urbano  
Cinzeno urbano



## 05-9114-Z5-B8

 2 x E-27 max 100W

 2 x PL elect. E-27 max. 23W

IP 54   2 

### PL 23W

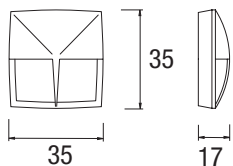
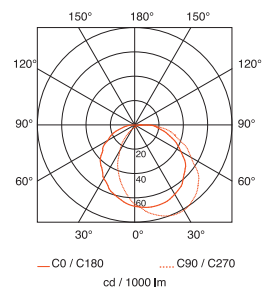

# PERGOLA®

## Materiales / Materials



## Especificaciones / Specifications



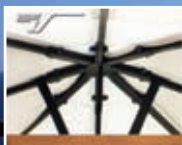

## Acabados / Finishes

-  92 Madera de teca
- Teak wood
- Bois de teck
- Teakholz
- Legno di teak
- Madeira de teka



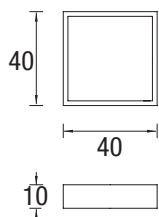

Incluye un sistema fácil y exclusivo para colgar en pérgolas.  
Includes an exclusive and easy system for hanging in pergolas.  
Inclut un système pratique et exclusif pour suspendre dans les terrasses.  
Schließt ein einfaches System ausschließlich zum Aufhängen an Pergolen.  
Include sistema facile e esclusivo per collegare in gazebo.  
Inclui um sistema fácil e exclusivo para pendurar em pérgolas.



**15-9341-92-M2** 

 4 x PL elect. E-27 max. 23W

 IP 23 



# SELENE

172

Selene

## Selene collection

- Serie realizada en aluminio inyectado, pensada para su uso como aplique y plafón. La serie presenta modelos con versiones Up & Down light. Asimismo, algunos modelos incluyen difusores extra de PMMA azul y amarillo.
- A collection made of die-cast aluminium, designed to be used as a wall fixture and a ceiling fixture. The collection has models with Up & Down light versions. Some models also include additional blue and yellow PMMA diffusers.
- Une série en aluminium injecté conçue pour une utilisation applique et plafond. La série présente des modèles avec versions Up & Down light. Certains modèles sont équipés de diffuseurs extra PMMA bleu et jaune.
- Die Produktserie ist aus gespritztem Aluminium hergestellt und für die Benutzung als Wand- und Deckenleuchte gedacht. Die Serie beinhaltet Modelle mit der Version für Up & Down Light - Schaltung. Außerdem schließt sie einige Modelle an Extra- Diffusoren mit PMMA blau und gelb ein.
- Serie realizzata in alluminio iniettato pensata per l'uso come applique e plafoniera. La serie presenta modelli con versioni Up&Down light. Inoltre, alcuni modelli comprendono diffusori supplementari di PMMA di colore azzurro e giallo.
- Série feita em alumínio injectado pensada para ser usada como applique e lustre. A série apresenta modelos com versões Up & Down light. De igual modo, alguns modelos incluem difusores extra de PMMA azul e amarelo.



Materiales / Materials



Especificaciones / Specifications



Acabados / Finishes

- 34 Gris
- Grey
- Gris
- Grau
- Grigio
- Cinzeno

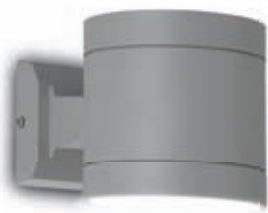

**05-9309-34-37** ■

☞ G9 max. 60W

▽ IP 54 ☒ 12

☞ 40W OSRAM **Included**

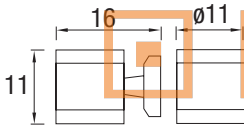
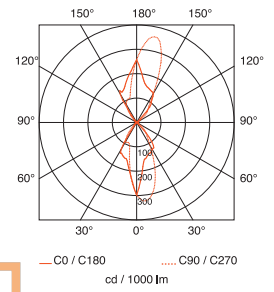

**MODULO**  
**ELECTRO**

[www.modulelectro.ru](http://www.modulelectro.ru)



**05-9308-34-B8** ■

☞ G9 max. 40W

✕ IP 54 ☒ 12

☞ 40W OSRAM **Included**

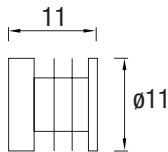



**MODUL**  
ELECTRO  
[www.modulelectro.ru](http://www.modulelectro.ru)

Materiales / Materials



Difusor de PMMA azul de cortesia para acabado 34 / Difusor de PMMA amarillo de cortesia para acabado 18.  
Blue PMMA diffuser included for finish 34 / Yellow PMMA diffuser included for finish 18

Especificaciones / Specifications



Acabados / Finishes

- 18 Marrón óxido / Rusted/oxide brown / Rouille / Rostbraun / Marrone ossido / Marrom óxido
- 34 Gris / Grey / Gris / Grau / Grigio / Cinzento

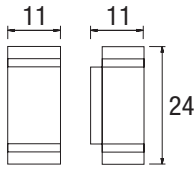

05-9234-18-37 ■  
05-9234-34-37 ■

- 2 x GU-10 max. 50W
- 2 x GU-10 max. 14W Fluorescent
- 2 x GU-10 max. 5W LED



2 x OSRAM 50W Included

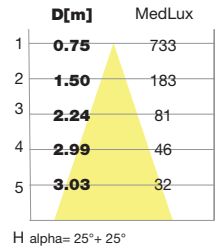
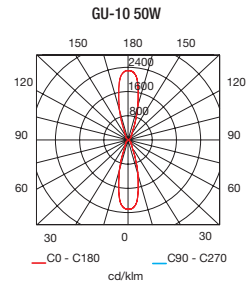

# MODULO ELECTRO

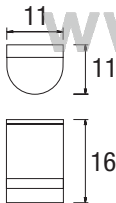

05-9235-18-37 ■  
05-9235-34-37 ■

- GU-10 max. 50W
- GU-10 max. 14W Fluorescent
- GU-10 max. 5W LED



OSRAM 50W Included

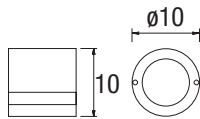
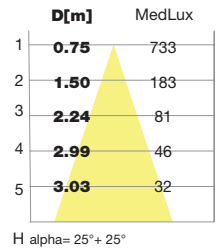
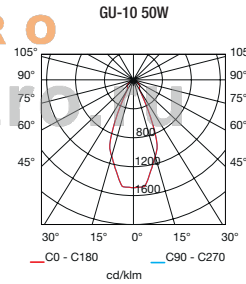

15-9234-18-37 ■  
15-9234-34-37 ■

- GU-10 max. 50W
- GU-10 max. 14 W Fluorescent
- GU-10 max. 5W LED



OSRAM 35W Included

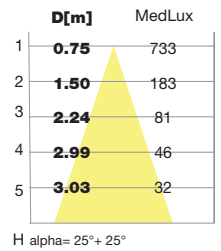
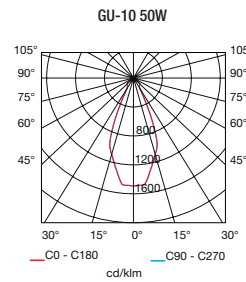



# SOFT

Design by Manel Lluscà

176

Soft

## Soft collection ®

- Colección realizada en cuerpo de inyección de aluminio con difusor de cristal satinado. La serie está formada por dos apliques, uno de ellos en versión Up & Down Light.
- A collection with a die-cast aluminium body and a transparent satin glass diffuser. The series consists of two wall lights, one of them Up&Down Light version.
- Collection réalisée en injection d'aluminium avec diffuseur en verre transparent. Série constituée de deux appliques, dont l'une en version à éclairage vers le haut et vers le bas.
- Bei dieser Kollektion ist der Körper der Leuchten aus Aluminiuminjektion hergestellt und die Modelle sind mit einem Lichtverteiler aus transparentem Glasdiffusor. Die Serie besteht aus zwei Wandleuchtenmodellen, eine davon ein Up & Down Light.
- Collezione realizzata con corpo in alluminio iniettato e diffusore in cristallo satinato. La serie si compone di due applique, uno nella versione Up & Down Light.
- Colecção feita em corpo de injeção de alumínio com difusor de vidro satinado. A série está formada por dois apliques, um deles em versão Up & Down Light."

® Registration number: 001091375-027 / 001091375-028 / 001091375-029



Materiales / Materials



Especificaciones / Specifications



Acabados / Finishes

- 34 Gris
- Grey
- Gris
- Grau
- Grigio
- Cinzeno

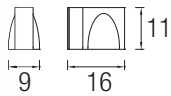

**05-9370-34-T2** ■

- ▶ GU-10 max. 50W
- ▶ GU-10 max. 14W Fluorescent
- ▶ GU-10 max. 5W LED

IP 54 6 IK 07

2 OSRAM 50W **Included**

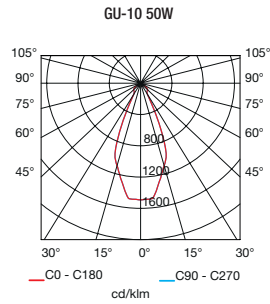

D[m]	MedLux
1	0.75 733
2	1.50 183
3	2.24 81
4	2.99 46
5	3.03 32

H alpha= 25°+ 25°

# MODULO ELECTRO

[www.modulelectro.ru](http://www.modulelectro.ru)

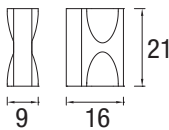

**05-9371-34-T2** ■

- ▶ 2 x GU-10 max. 50W
- ▶ 2 x GU-10 max. 14W Fluorescent
- ▶ 2 x GU-10 max. 5W LED

IP 54 4 IK 07

2 x OSRAM 50W **Included**

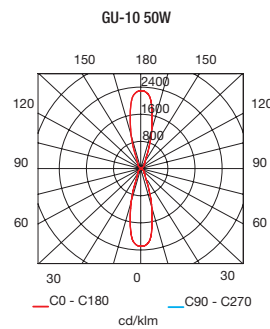

D[m]	MedLux
1	0.75 733
2	1.50 183
3	2.24 81
4	2.99 46
5	3.03 32

H alpha= 25°+ 25°

## Icaro collection

- La serie ICARO dispone de una amplia variedad de opciones desde el foco, hasta la baliza pasando por el "pincho", incluyendo el doble foco. Todas las opciones se pueden orientar para satisfacer cualquier necesidad de iluminación.
- The ICARO collection comes with a wide variety of options – the spotlight, the beacon, the support, including the double spotlight. All the options can be turned round to satisfy any lighting requirements.
- La Série ICARO offre un large choix d'options: du faisceau à la balise en passant par les "pieux" et le double faisceau. Les différentes options permettent de répondre à tous les besoins d'illumination.
- Die ICARO Produktserie verfügt über eine große Auswahl, die Scheinwerfer und Leuchtbaken bis hin zur "Stecklampe" sowie Doppelscheinwerfer einschließt. Alle Optionen sind verstellbar, sodass jedem Bedarf an Beleuchtung nachgekommen werden kann.
- La serie ICARO dispone di un'ampia varietà di opzioni, dal riflettore al faretto, comprendendo il riflettore doppio. Tutte le opzioni si possono orientare per soddisfare qualsiasi necessità di illuminazione.
- A série ICARO dispõe de uma grande variedade de opções desde o foco, até à sinalização passando pelo "pico", incluindo o duplo foco. Todas as opções podem ser orientadas para a satisfação de qualquer necessidade de iluminação.



  
**ELECTRO**  
[www.modulelectro.ru](http://www.modulelectro.ru)



Materiales / Materials



Especificaciones / Specifications

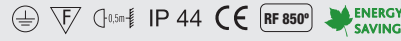

Acabados / Finishes

- 34 Gris
- Grey
- Gris
- Grau
- Grigio
- Cinzeno

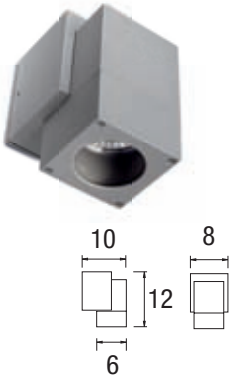

05-9190-34-37 ■

- ▶ GU-10 max. 50W
- ▶ GU-10 max. 14W Fluorescent
- ▶ GU-10 max. 5W LED



▶ OSRAM 50W **Included**

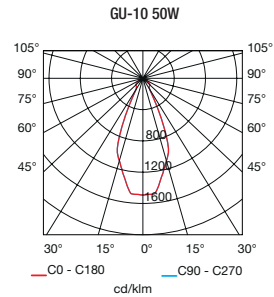

D[m]	MedLux
1	0.75 733
2	1.50 183
3	2.24 81
4	2.99 46
5	3.03 32

H alpha= 25°+ 25°

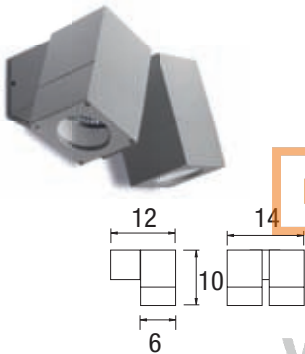

05-9191-34-37 ■

- ▶ 2 x GU-10 max. 50W
- ▶ 2 x GU-10 max. 14W Fluorescent
- ▶ 2 x GU-10 max. 5W LED



▶ 2 x OSRAM 50W **Included**

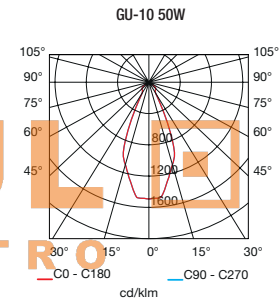

D[m]	MedLux
1	0.75 733
2	1.50 183
3	2.24 81
4	2.99 46
5	3.03 32

H alpha= 25°+ 25°

www.modulelectro.ru

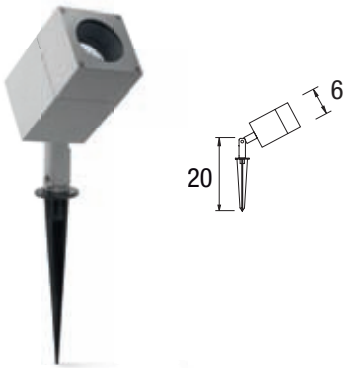

55-9191-34-37 ■

- ▶ GU-10 max. 50W
- ▶ GU-10 max. 14W Fluorescent
- ▶ GU-10 max. 5W LED

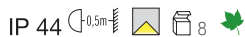

▶ OSRAM 50W + 2.5m **Included**

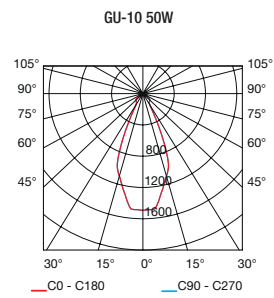

D[m]	MedLux
1	0.75 733
2	1.50 183
3	2.24 81
4	2.99 46
5	3.03 32

H alpha= 25°+ 25°

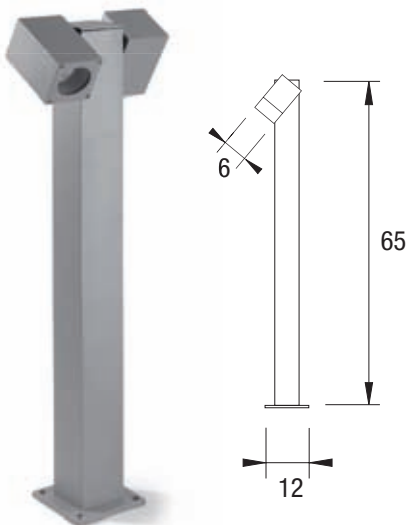

55-9190-34-37 ■

- ▶ 2 x GU-10 max. 50W
- ▶ 2 x GU-10 max. 14W Fluorescent
- ▶ 2 x GU-10 max. 5W LED



▶ 2 x OSRAM 50W **Included**

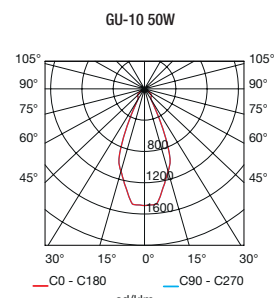

D[m]	MedLux
1	0.75 733
2	1.50 183
3	2.24 81
4	2.99 46
5	3.03 32

H alpha= 25°+ 25°

# ALEXANDRIA

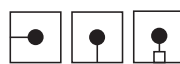

180

Alexandria

## Alexandria collection

- La serie Alexandria presenta una amplia oferta de balizas y apliques en acabados diferentes, siendo apta para uso con lámparas de bajo consumo.
- The Alexandria series consists of a wide range of different finish markers and wall lights, suitable for its use with low consumption lamps
- La série Alexandria offre un vaste éventail de balises et d'applique dans des finitions variées, tandis qu'elle peut accueillir des lampes basse consommation.
- Die Serie Alexandria bietet eine breitgefächerte Palette an Signal- und Wandleuchten in verschiedenen Ausführungen an, die zur Verwendung mit Energiesparlampen geeignet sind.
- La serie Alexandria presenta un'ampia offerta di piantane e applique in diverse finiture, adatta all'uso con lampade a basso consumo.
- A série Alexandria apresenta uma vasta oferta de balizas e apliques em diferentes acabados, sendo apta para uso com lâmpadas de baixo consumo.



**MODULO**  
ELECTRO  
[www.modulelectro.ru](http://www.modulelectro.ru)

Materiales / Materials



Especificaciones / Specifications



Acabados / Finishes

■ 18 Marrón óxido Rusted/oxide brown Rouille Rostbraun Marrone ossido Marrom óxido	■ 34 Gris Grey Gris Grau Grigio Cinzento
---	---

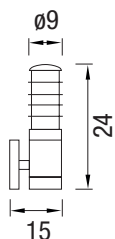

**05-9329-18-B8 ■**  
**05-9329-34-B8 ■**

○ E-27 max. 100W

⦿ PL elect. E-27 max. 23W

IP 44 ⚡ 6 🌿

▶▶ 18W **Included**

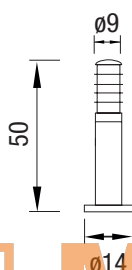

**10-9329-18-B8 ■**  
**10-9329-34-B8 ■**

○ E-27 max. 100W

⦿ PL elect. E-27 max. 23W

IP 44 ⚡ 4 🌿 278

▶▶ 18W **Included**

**MODULO**  
**ELECTRO**

[www.modulelectro.ru](http://www.modulelectro.ru)

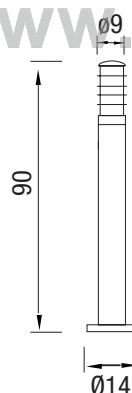

**55-9329-18-B8 ■**  
**55-9329-34-B8 ■**

○ E-27 max. 100W

⦿ PL elect. E-27 max. 23W

IP 44 ⚡ 4 🌿 278

▶▶ 18W **Included**

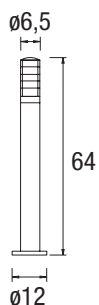

**55-9195-34-T2 ■ (S)**

⦿ E-27 100W-HAL

⦿ PL elect. E-27 max. 20W-GE

IP 44 ⚡ 4 🌿 279

▶▶ 11W **Included**



## Hebe collection

- De diseño moderno, se adapta a cualquier ambiente. Fabricada en aluminio inyectado y difusor de policarbonato mate.
- A modern design that adapts to any kind of environment. Made of die-cast aluminium and a matt-finish polycarbonate diffuser.
- Un design moderne qui s'adapte à tout les espaces. Une série fabriquée en aluminium injecté avec diffuseur en polycarbonate mat.
- Von modernem Design, das sich an jedes Ambiente anpasst, hergestellt aus gespritztem Aluminium und mit Diffusor aus mattem Polykarbonat.
- Dal design moderno, si adatta a qualsiasi ambiente. In alluminio iniettato e diffusore in policarbonato opaco.
- De concepção moderna, adapta-se a qualquer ambiente. Fabricada em alumínio injectado e difusor de policarbonato mate.

**MODUL**  
ELECTRO  
[www.modulelectro.ru](http://www.modulelectro.ru)



Características / Specifications



Especificaciones / Specifications



Acabados / Finishes

- 34 Gris
- Grey
- Gris
- Grau
- Grigio
- Cinzeno

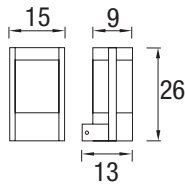

**05-9238-34-M3** ■

- E-27 max. 100W
- ▶ PL elect. E-27 Max. 30W

IP 44 6

18W **Included**

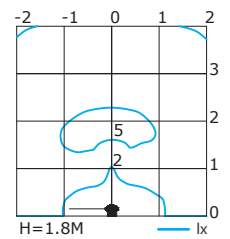
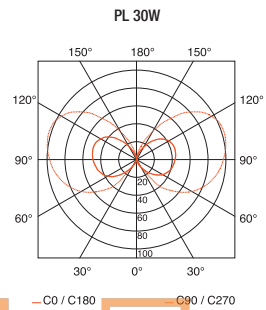

**MODULO**  
ELECTRO

[www.modulelectro.ru](http://www.modulelectro.ru)

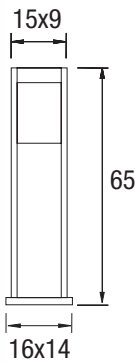

**55-9238-34-M3** ■

- E-27 max. 100W
- ▶ PL elect. E-27 max. 30W

IP 44 4 279

18W **Included**

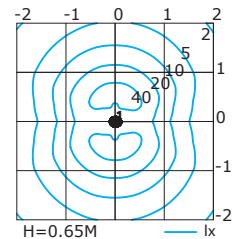
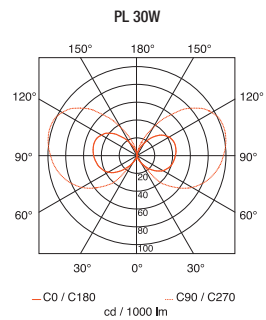





## Ixion collection ®

- La madera de Teca de la serie Ixion se une a los detalles de acero inox. AISI 304 para hacerla adecuada para los ambientes más nobles.
- Ixion includes teak wood together with stainless steel details. AISI 304 to make it suitable for the noblest environments.
- Le bois de teck de la série Ixion allié à l'acier inoxydable AISI 304 nous offre une série qui s'adapte parfaitement aux espaces les plus nobles.
- Das Teakholz der Produktserie Ixion ist mit Details aus rostfreiem AISI 304 Stahl verbunden worden, damit es sich an ein eleganteres Ambiente anpasst.
- Il legno di Teak della serie Ixion si unisce ai dettagli in acciaio inossidabile AISI 304 per un connubio adeguato agli ambienti più nobili.
- A madeira de Teca da série Ixion junta-se aos detalhes de aço inox AISI 304 para se tornar indicada para os ambientes mais nobres.

® Registration number: 000504063-0011 / 000504063-0013

**MODUL**  
ELECTRO  
[www.modulelectro.ru](http://www.modulelectro.ru)



Materiales / Materials



Especificaciones / Specifications

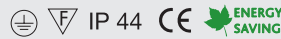

Acabados / Finishes

- 92 Madera de teca
- Teak wood
- Bois de teck
- Teakholz
- Legno di teak
- Madeira de teka

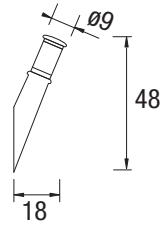

**05-9176-92-B8**

E-27 max. 100W

PL elect. E-27 max. 23W

IP 44

18W **Included**

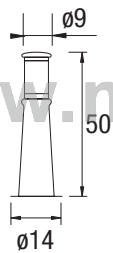

**10-9176-92-B8**

E-27 max. 100W

PL elect. E-27 max. 23W

IP 44

18W **Included**

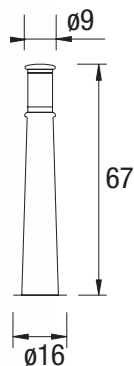

**55-9176-92-B8**

E-27 max. 100W

PL elect. E-27 max. 23W

IP 44

18W **Included**

**MODULO**  
ELECTRO  
www.moduloelectro.ru



**MODUL**  
ELECTRO  
[www.modulelectro.ru](http://www.modulelectro.ru)

## Mark collection ®

- El estilo de la serie Mark la hace idónea tanto para ambientes modernos como clásicos, disponiendo de una amplia oferta de soluciones.
- The style of the Mark collection makes it ideal for both modern and traditional environments, and it offers a wide range of solutions.
- Le style de la série Mark est idéal tant pour les espaces modernes que classiques et dispose d'une vaste gamme de solutions.
- Der Stil von der Produktserie Mark eignet sich sowohl für modernes als auch klassisches Ambiente und sie verfügt außerdem über umfangreiche Lösungen.
- Per il suo stile, la serie Mark è adatta tanto agli ambienti moderni quanto a quelli classici, disponendo di un'ampia offerta di soluzioni.
- O estilo da série Mark torna-a idónea para ambientes tanto modernos como clássicos, e dispõe de uma ampla oferta de soluções.

® Registration number: 000835277-0034 / 000835277-028 / 000835277-0029

  
**MODUL**  
**ELECTRO**  
[www.modulelectro.ru](http://www.modulelectro.ru)





Materiales / Materials



Especificaciones / Specifications



Acabados / Finishes

- Z5 Gris urbano
- Urban grey
- Gris urbain
- Anthrazit
- Grigio urbano
- Cinzeno urbano

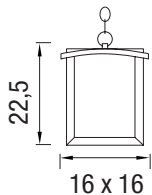

**00-9298-Z5-M3** ■

- E-27 max. 100W
- ⚡ PL elect. E-27 max.18W

IP 23

13W **Included**

**IP+**

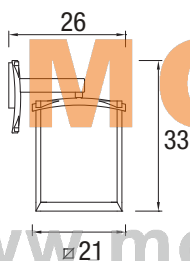
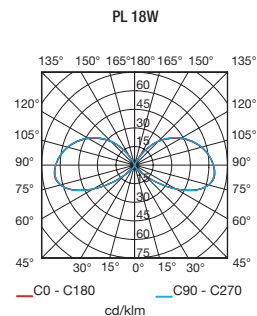

**05-9390-Z5-M3** ■

- E-27 max. 100W
- ⚡ PL elect. E-27 max. 30W

IP 23

18W **Included**

**IP+**

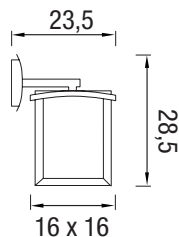
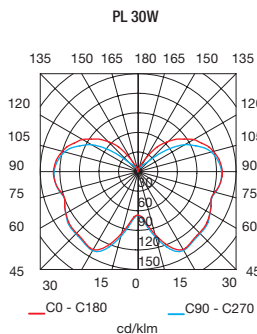

**05-9298-Z5-M3** ■

- E-27 max. 100W
- ⚡ PL elect. E-27 max.18W

IP 23

13W **Included**

**IP+**

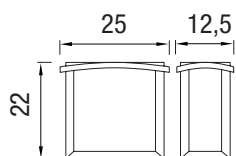
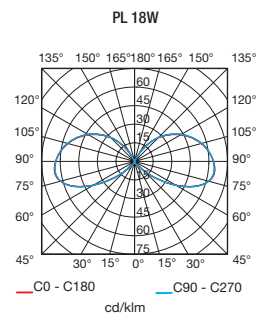

**05-9299-Z5-M3** ■

- 2 x E-27 max. 60W
- ⚡ 2 x PL elect. E-27 max.18W

IP 23

2 x 13W **Included**

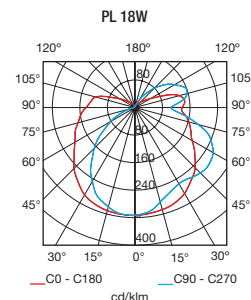



**MODUL**  
ELECTRO  
[www.modulelectro.ru](http://www.modulelectro.ru)

Materiales / Materials



Especificaciones / Specifications



Acabados / Finishes

- Z5 Gris urbano
- Urban grey
- Gris urbain
- Anthrazit
- Grigio urbano
- Cinzeno urbano

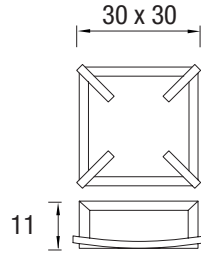

**15-9298-Z5-M3** ■

○ 2 x E-27 max. 60W

▮ 2 x PL elect. E-27 max 23W

IP 44 ☒ 6 🌱

▮ 2 x 13W **Included**

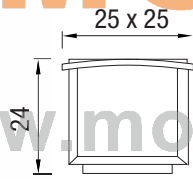
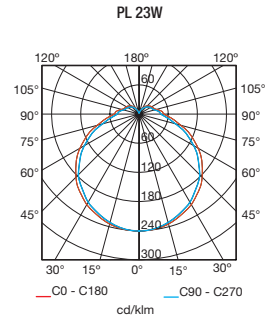

**10-9299-Z5-M3** ■

○ E-27 max. 100W

▮ PL elect. E-27 max. 23W

IP 44 ☒ 4 🌱 278

▮ 18W **Included**

**IP+**

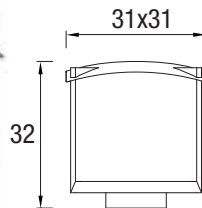
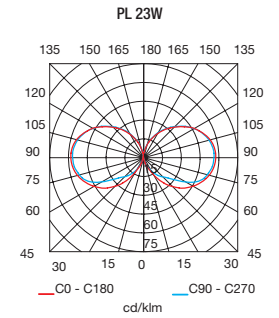

**10-9390-Z5-M3** ■

○ E-27 max. 150W

▮ PL elect. E-27 max. 30W

IP 44 ☒ 2 🌱 278

▮ 23W **Included**

**IP+**

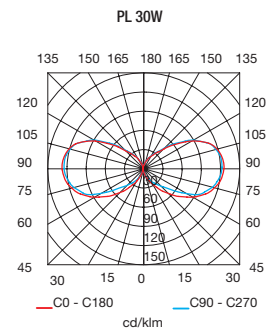

**MODULO**  
ELECTRO  
www.modulselectro.ru





**MODUL**  
ELECTRO  
[www.modulelectro.ru](http://www.modulelectro.ru)

Materiales / Materials



Especificaciones / Specifications



Acabados / Finishes

- Z5 Gris urbano
- Urban grey
- Gris urbain
- Anthrazit
- Grigio urbano
- Cinzeno urbano

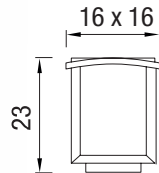

**10-9298-Z5-M3** ■

⦿ E-27 max. 100W

⦿ PL elect. E-27 max. 18W

IP 44 ⚡ 6 🛠️ 277 🌿

➡️ 13W **Included**

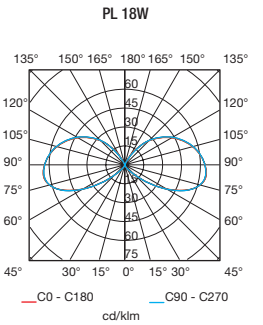

**55-9390-Z5-M3** ■

⦿ 2G11 55W

IP 44 ⚡ 2 🛠️ 281 🌿

➡️ 55W + 📦 **BAG Included**

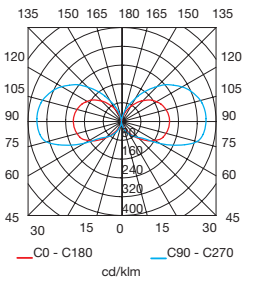

**MODULO**  
**ELECTRO**

www.modulselectro.ru

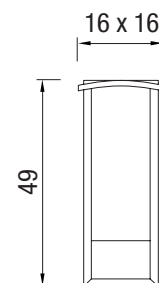

**55-9298-Z5-M3** ■



⦿ 2G11 24W

IP 44 ⚡ 4 🛠️ 280 🌿

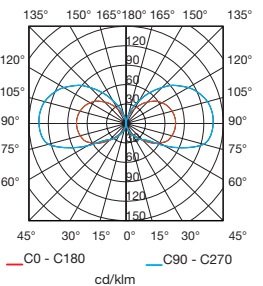
➡️ 24W + 📦 **BAG Included**





 **MODUL**   
ELECTRO  
[www.modulelectro.ru](http://www.modulelectro.ru)

## Janna collection

- Colección de estilo rústico con un diseño actual, formada por applique, colgante y sobremuro en acabado marrón óxido. Realizada en aluminio de alta calidad y con difusor de policarbonato. Se presenta con lámparas de bajo consumo incluidas.
- Collection in a rustic style with a contemporary design, composed of a fitting, a pendant section and a lantern, with rust brown finish. Produced in high quality aluminium with polycarbonate diffuser. Supplied with low energy lights.
- Collection de style rustique au design actuel, constituée par des appliques, des suspensions et des appliques murales avec une finition marron oxydé. Réalisée en aluminium de haute qualité et avec un diffuseur en polycarbonate. Elle est présentée avec des ampoules à économie d'énergie incluses.
- Kollektion in rustikalem Stil mit aktuellem Design. Sie besteht aus Wandlampe, Hängelampe und Mauerleuchte in antikbrauner Ausfertigung. Hergestellt aus hochwertigem Aluminium mit Diffusor aus Polycarbonat. Energiesparlampen werden migestellert.
- Collezioni in stile rustico dal design attuale, formata da applique, sospensioni e paletti in finitura marrone ossido. Realizzata in alluminio di alta qualità e con diffusore in policarbonato. Fornita con lampadine a basso consumo incluse.
- Coleção de estilo rústico com um design actual, composta por applique, suspensão e applique de parede, com acabamento castanho oxidado. Concebida em alumínio de alta qualidade e com difusor em policarbonato. Fornecida com lâmpadas de baixo consumo incluídas.

® 001186621-047 / 001186621-048 / 001186621-049

**MODUL**  
ELECTRO  
[www.modulelectro.ru](http://www.modulelectro.ru)





**MODUL**  
ELECTRO  
[www.modulelectro.ru](http://www.modulelectro.ru)

Materiales / Materials



Especificaciones / Specifications



Acabados / Finishes

- 18 Marrón óxido
- Rusted/oxide brown
- Rouille
- Rostbraun
- Marrone ossido
- Marrom óxido

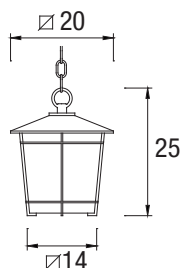

(new)



**00-9447-18-M3** ■

E-27 max. 100W

PL elect. E-27 max.18W

IP 23

18W **Included**



**00-9522-18-M3** ■

4 x 1W LED 100-240V Neutral white 4200K

IP 23

**Included**

Consultar disponibilidad.  
Check availability.

**MODULO**  
ELECTRO

www.modulelectro.ru

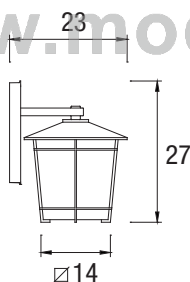

(new)



**05-9447-18-M3** ■

E-27 max.100W

PL elect. E-27 max.18W

IP 23

18W **Included**



**05-9522-18-M3** ■

4 x 1W LED 100-240V Neutral white 4200K

IP 23

**Included**

Consultar disponibilidad.  
Check availability.

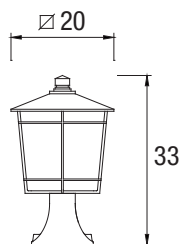

(new)



**10-9447-18-M3** ■

E-27 max. 100W

PL elect. E-27 max.18W

IP 23

18W **Included**



**10-9522-18-M3** ■

4 x 1W LED 100-240V Neutral white 4200K

IP 23

**Included**

Consultar disponibilidad.  
Check availability.



**MODUL**  
ELECTRO  
[www.modulelectro.ru](http://www.modulelectro.ru)

Alba collection <sup>®</sup>

- Completa colección rústica - moderna realizada en color óxido. Todas las versiones incluyen 2 tipos de cristal: uno rústico ámbar y otro transparente satinado.
- Complete rustic collection – and modern oxide coloured. All versions include 2 types of glass diffusers: one amber rustic and another transparent satin.
- Collection rustique-moderne complète réalisée en couleur rouille. Toutes les versions comprennent 2 types de diffuseur en verre : un rustique ambre et un autre transparent satiné.
- Komplette Kollektion im rustikal-modernen Design in Oxidfinish. Alle Ausführungen einschließlich 2 Arten von Glasdiffusoren: eine Ausführung bernsteinfarben und die andere satiniert-transparent.
- Completa collezione rustica-moderna realizzata in color ruggine. Tutte le versioni comprendono due tipi di diffusore di vetro: uno rustico ambrato e un altro trasparente satinato.
- Completa coleção rústica - moderna realizada em cor óxido. Todas as versões incluem 2 tipos de difusor de cristal: um rústico âmbar e outro transparente acetinado.

<sup>®</sup> Registration number: 001091375-032 / 001091375-033 / 001091375-034







**MODUL**  
ELECTRO  
[www.modulelectro.ru](http://www.modulelectro.ru)

Materiales / Materials



Especificaciones / Specifications



Acabados / Finishes

- 18 Marrón óxido  
Rusted/oxide brown  
Rouille  
Rostbraun  
Marrone ossido  
Marrom óxido



2 juegos de cristales incluidos (rústico ámbar + transparente satinado)  
2 sets of glass included (rustic amber + transparent satin)

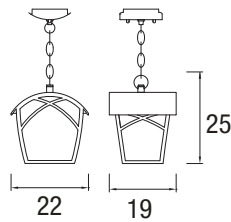

**00-9350-18-AA ■**

E-27 max. 100W

PL elect. E-27 max.18W

IP 23 4

13W **Included**

IP+

**MODULO**  
**ELECTRO**

[www.modulelectro.ru](http://www.modulelectro.ru)

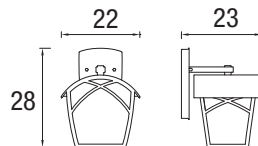

**05-9350-18-AA ■**

E-27 max. 100W

PL elect. E-27 max.18W

IP 23 4

13W **Included**

IP+

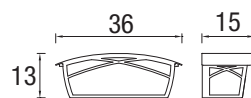

**05-9351-18-AA ■**

E-27 max. 100W

PL elect. E-27 max.18W

IP 23 4

18W **Included**



**MODUL**  
ELECTRO  
[www.modulelectro.ru](http://www.modulelectro.ru)

Materiales / Materials



Especificaciones / Specifications



Acabados / Finishes

- 18 Marrón óxido
- Rusted/oxide brown
- Rouille
- Rostbraun
- Marrone ossido
- Marrom óxido



2 juegos de cristales incluidos (rústico ámbar + transparente satinado)  
2 sets of glass included (rustic amber + transparent satin)

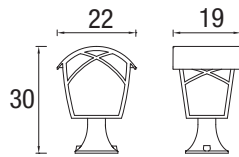

**10-9350-18-AA** ■

○ E-27 max. 100W

⏏ PL elect. E-27 max.18W

IP 23 4

13W **Included**

**MODULO**



**15-9350-18-AA** ■

○ 2 x E-27 max. 100W

⏏ 2 x PL elect. E-27 max.18W

IP 23 4

2 x 18W **Included**

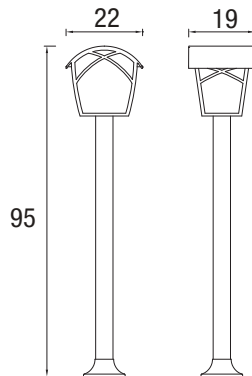

**55-9350-18-AA** ■

○ E-27 max. 100W

⏏ PL elect. E-27 max.18W

IP 23 2 280

13W **Included**

# CROSS

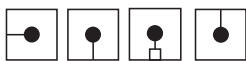

Design by Manel Lluscà

204

Cross

## Cross collection ®

- Cross ofrece una gran amplitud de iluminación gracias a su gran difusor, con un diseño actual que encaja en todos los ambientes.
- Cross offers a wide beam of light, thanks to its large modern-design diffuser which fits in any environment.
- Cross offre un grand choix d'illumination grâce à son diffuseur au design actuel qui s'adapte à tous les espaces.
- Cross verfügt über eine außerordentliche Leuchtkraft, dank des großen Diffusors von zeitgemäßem Design, der sich allen Ambienten anpasst.
- Cross offre una grande ampiezza di illuminazione grazie al suo grande diffusore dal design attuale che si adatta in tutti gli ambienti.
- A Cross oferece uma iluminação muito ampla, graças ao seu grande difusor de concepção actual que se encaixa bem em todos os ambientes.

® Registration number: 000835277-0026



Materiales / Materials



Especificaciones / Specifications



Acabados / Finishes

- 18 Marrón óxido  
Rusted/oxide brown  
Rouille  
Rostbraun  
Marrone ossido  
Marrom óxido

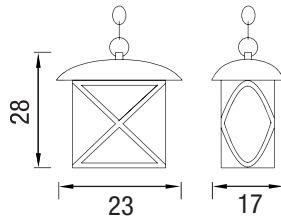

**00-9295-18-M3** ■

○ E-27 max. 100W

⚡ PL elect. E-27 max.18W

IP 23

▶▶ 13W Included

IP+

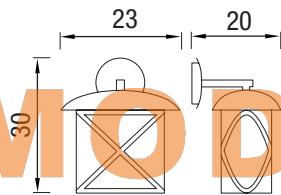

**05-9295-18-M3** ■

○ E-27 max. 100W

⚡ PL elect. E-27 max.18W

IP 23

▶▶ 13W Included

IP+

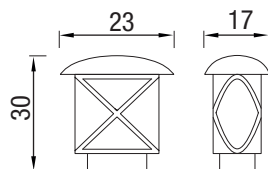

**10-9295-18-M3** ■

○ E-27 max. 100W

⚡ PL elect. E-27 max.18W

IP 44 277

▶▶ 13W Included

IP+

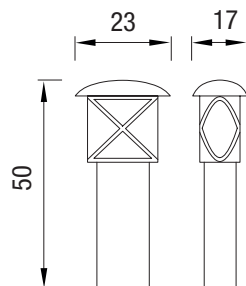

**55-9295-18-M3** ■

○ E-27 max. 100W

⚡ PL elect. E-27 max.18W

IP 44 277

▶▶ 13W Included

IP+

www.modulelectro.ru

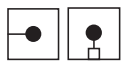

## Reed collection

- Su amplitud de cristal proporciona una gran iluminación en cualquier ambiente.
- This collection includes large pieces of glass, which offers great lighting in any environment.
- La magnificence du verre offre une grande luminosité à toutes les ambiances.
- Die große Menge an Kristallglas verleiht dieser Serie eine außerordentliche Leuchtkraft in jedlichem Ambiente.
- L'ampiezza del cristallo permette di ottenere una vasta illuminazione in qualsiasi ambiente.
- A sua amplitude de vidro proporciona uma grande iluminação a qualquer ambiente.



Materiales / Materials



Especificaciones / Specifications



Acabados / Finishes

- 05 Negro
- Black
- Noir
- Schwarz
- Nero
- Preto

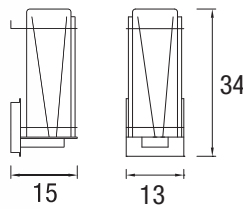

**05-9356-05-B8 ■**

E-27 max. 100W

PL elect. E-27 max. 23W

IP 44 4

**18W Included**



**MODULO**  
**ELECTRO**

[www.modulelectro.ru](http://www.modulelectro.ru)

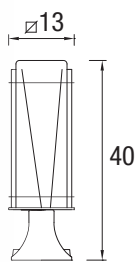

**10-9356-05-B8 ■**

E-27 max. 100W

PL elect. E-27 max. 23W

IP 44 2



**23W Included**





## Ciri collection

- Ofrece un estilo clásico aunque gracias a su diseño actual se hace apta a cualquier ambiente.
- A classical-style collection with a modern design suitable for any environment.
- Un style classique qui, grâce à son design actuel, s'adapte à tous les espaces.
- Ein Produkt von klassischem Stil, das sich aber dank seines zeitgemäßen Design an jegliches Ambiente anpasst.
- Offre uno stile classico, per quanto grazie al suo design attuale si possa adattare a qualsiasi ambiente.
- Oferece um estilo clássico embora, graças à sua concepção actual, seja indicada para qualquer ambiente.

 **MODUL**   
**ELECTRO**  
[www.modulelectro.ru](http://www.modulelectro.ru)



Materiales / Materials



Especificaciones / Specifications



Acabados / Finishes

- 05 Negro
- Black
- Noir
- Schwarz
- Nero
- Preto

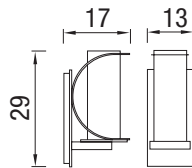

**05-9330-05-B8 ■**

E-27 max. 100W

PL elect. E-27 max.18W

IP 44 6

13W **Included**



**MODULO**  
ELECTRO

[www.modulelectro.ru](http://www.modulelectro.ru)

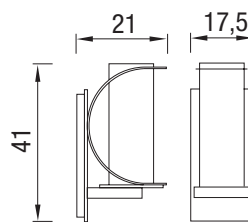

**05-9331-05-B8 ■**

E-27 max. 100W

PL elect. E-27 max.23W

IP 44 4

18W **Included**



# GRID



210

Grid

## Grid collection

- En aluminio inyectado, la serie Grid se caracteriza por luminarias adecuadas para uso en bajo consumo, y con difusor de cristal rústico.
- Made of injected aluminium, the Grid series features proper luminaries for low consumption use, provided with a rustic crystal diffuser.
- En aluminium injecté, la série Grid est constituée de luminaires adaptés à l'usage en basse consommation et munis d'un diffuseur en verre rustique.
- Die Serie Grid aus Aluminiumguss bietet zur Verwendung mit Energiesparlampen geeignete Leuchten mit Diffusoren aus robustem Glas.
- In alluminio pressofuso, la serie Grid si caratterizza per la sua versatilità essendo possibile utilizzare lampadine a basso consumo, e con diffusore di vetro rustico.
- Em alumínio injectado, a serie Grid caracteriza-se por luminárias adequadas para uso em baixo consumo, e com difusor de cristal rústico.

 **MODUL**   
ELECTRO  
[www.modulelectro.ru](http://www.modulelectro.ru)



Materiales / Materials



Especificaciones / Specifications



Acabados / Finishes

- 18 Marrón óxido  
Rusted/oxide brown  
Rouille  
Rostbraun  
Marrone ossido  
Marrom óxido

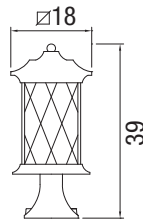

10-9389-18-AA ■ (S)

E-27 max. 100W

PL elect. E-27 max.18W

IP 23 2

18W **included**

**MODULO**  
ELECTRO

[www.modulelectro.ru](http://www.modulelectro.ru)

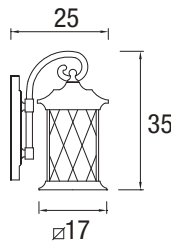

05-9389-18-AA ■

E-27 max. 100W

PL elect. E-27 max.18W

IP 23 4

18W **included**

IP+

Materiales / Materials



Especificaciones / Specifications



Acabados / Finishes

- 18 Marrón óxido  
Rusted/oxide brown  
Rouille  
Rostbraun  
Marrone ossido  
Marron óxido

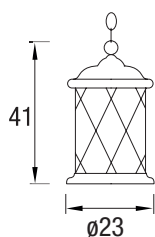

00-9312-18-AA ■

E-27 max. 100W

PL elect. E-27 max. 23W

IP23 4

18W Included



# MODULO

## ELECTRO

www.modulelectro.ru

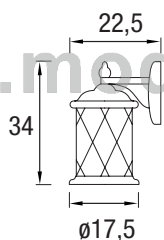

05-9312-18-AA ■

E-27 max. 60W

PL elect. E-27 max. 18W

IP 23 6

13W Included

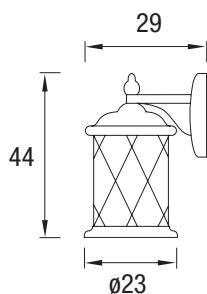

05-9313-18-AA ■

E-27 max. 100W

PL elect. E-27 max. 23W

IP 23 4

18W Included



# HERA

## Materiales / Materials



## Especificaciones / Specifications



## Acabados / Finishes

- 18 Marrón óxido  
Rusted/oxide brown
- Rouille
- Rostbraun
- Marrone ossido
- Marrom óxido

213  
Hera

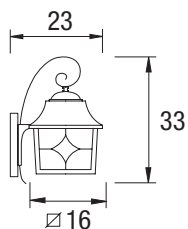

**05-9124-18-37** ■

 E-27 max. 100W

 PL elect. E-27 max. 15W

IP 23   6 

**CRIS +** **included**

**IP+**

# ODISEO



214

Odiseo



## Odiseo collection

- Fabricado en aluminio inyectado, la colección Odiseo dispone de una amplia oferta, incluyendo un cristal de recambio de cortesía.
- The Odiseo collection, made of die-cast aluminium, offers a wide range of lights, including a courtesy spare glass.
- Fabriquée en aluminium injecté, la collection Odisea dispose d'une vaste gamme tout en incluant un verre de rechange offert.
- Die Kollektion Odisea, hergestellt aus gespritztem Aluminium, verfügt über ein umfangreiches Angebot und sie schließt ein nicht angerechnetes Ersatzkristall ein.
- Fabbricata in alluminio iniettato, la collezione Odisea presenta un'ampia offerta, e include un cristallo di ricambio in omaggio.
- Fabricada em alumínio injectado, a coleção Odiseia tem uma grande oferta, incluindo um vidro de substituição como oferta.

 **MODULO**   
ELECTRO  
[www.moduloelectro.ru](http://www.moduloelectro.ru)



Materiales / Materials



Especificaciones / Specifications



Acabados / Finishes

- 18 Marrón óxido  
Rusted/oxide brown  
Rouille  
Rostbraun  
Marrone ossido  
Marrom óxido

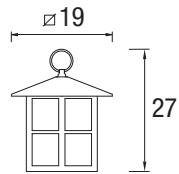

**00-9126-18-AA** ■ (S)

E-27 max. 100W

PL elect. E-27 max. 18W

IP 23 4

18W + **CRIS +** **Included**

**IP+**

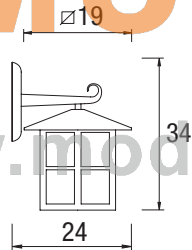

**05-9126-18-AA** ■

E-27 max. 100W

PL elect. E-27 max. 18W

IP 23 4

18W + **CRIS +** **Included**

**IP+**

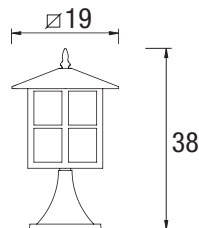

**10-9126-18-AA** ■ (S)

E-27 max. 100W

PL elect. E-27 max. 18W

IP 23 4

18W + **CRIS +** **Included**

**IP+**



# PERSEFONE

216

Persefone

## Persefone collection

- Persefone emula las antiguas luces de aceite y gracias a su diseño se puede utilizar con lámparas de bajo consumo.
- Persefone emulates ancient oil lamps and thanks to its design it can be used with energy-saving lamps.
- La série Persefone nous rappelle les anciennes lampes à huile. Grâce à son design, elle peut être utilisée avec des lampes basse consommation.
- Persefone erinnert an die alten Öllampen; sie können dank ihres Design mit Energiesparlampen benutzt werden.
- Persefone imita le vecchie lampade a olio e grazie al suo design si può utilizzare con lampade a basso consumo.
- A Persefone imita as antigas luzes de óleo e, graças à sua concepção, pode ser utilizada com lâmpadas de baixo consumo.

 Registration number: 000504063-0010

 **MODUL**   
ELECTRO  
[www.modulelectro.ru](http://www.modulelectro.ru)



Materiales / Materials



Especificaciones / Specifications



Acabados / Finishes

- 18 Marrón óxido  
Rusted/oxide brown
- Rouille
- Rostbraun
- Marrone ossido
- Marrom óxido

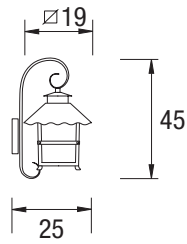

**05-9202-18-AA**

E-27 max. 100W

PL elect. E-27 max. 23W

IP 23 4

18W + CRIS + Included

IP+

# MODULO ELECTRO

[www.modulelectro.ru](http://www.modulelectro.ru)

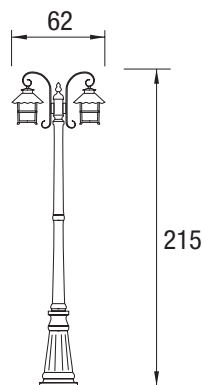

**60-9203-18-AA**

2 x E-27 max. 100W

2 x PL elect. E-27 max. 23W

IP23 2

2 x 18W + CRIS + Included

IP+

**55-9203-18-18**

Columna / Column

278

farola completa / complete lamp-post

**60-9203-18-AA + 55-9203-18-18**

# EDIPO



218

Edipo

## Edipo collection

- Edipo destaca por su combinación de líneas rectas y curvas con un diseño semi-rústico.
- Edipo stands out because of its combination of straight lines and curves, with a semi-rustic design.
- L'Edipo est mis en valeur grâce à ses lignes droites et courbes selon un design semi rustique.
- Edipo hebt sich aufgrund der Kombinationen von geraden Linien und Kurven halbländlichen Designs hervor.
- Edipo si distingue per la sua combinazione di linee rette e curve in un design semi-rustico.
- A Edipo destaca-se pela sua combinação de linhas rectas com curvas numa concepção semi-rústica.



**MODUL**  
ELECTRO  
[www.modulelectro.ru](http://www.modulelectro.ru)

Materiales / Materials



Especificaciones / Specifications



Acabados / Finishes

- 18 Marrón óxido  
Rusted/oxide brown  
Rouille  
Rostbraun  
Marrone ossido  
Marrom óxido

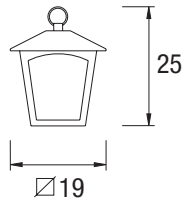

**00-9149-18-AA** ■

E-27 max. 100W

PL elect. E-27 max. 15W - GE

IP 23

11W + **CRIS +** **Included**

**IP+**

**MODULO**

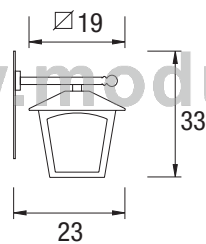

**05-9149-18-AA** ■

E-27 max. 100W

PL elect. E-27 max. 15W - GE

IP 23

11W + **CRIS +** **Included**

**IP+**

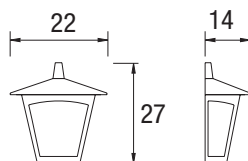

**05-9180-18-AA** ■

E-27 max. 60W

PL elect. E-27 max. 15W - GE

IP 23

11W **Included**

Materiales / Materials



Especificaciones / Specifications



Acabados / Finishes

- 18 Marrón óxido  
Rusted/oxide brown  
Rouille  
Rostbraun  
Marrone ossido  
Marrom óxido

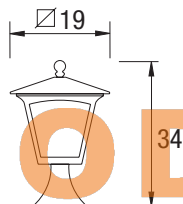

**10-9149-18-AA ■**

⦿ E-27 max. 100W

⦿ PL elect. E-27 max. 15W - GE

IP 23 ☒ 6 🌿

⦿ 11W + **CRIS +** Included

**MODULE**  
**ELECTRO**

[www.modulelectro.ru](http://www.modulelectro.ru)

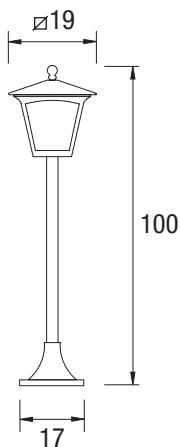

**55-9149-18-AA ■**

⦿ E-27 max. 100W

⦿ PL elect. E-27 max. 15W - GE

IP 23 ☒ 6 🌿

⦿ 11W + **CRIS +** Included

## Materiales / Materials



## Especificaciones / Specifications



## Acabados / Finishes

- 18 Marrón óxido  
Rusted/oxide brown  
Rouille  
Rostbraun  
Marrone ossido  
Marrom óxido



**MODULO**  
ELECTRO  
[www.moduloelectro.ru](http://www.moduloelectro.ru)

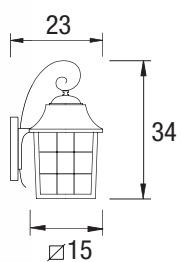

**05-9150-18-AA ■**

E-27 max. 100W

PL elect. E-27 20W - GE

IP 23

18W + **CRIS +** **Included**



Materiales / Materials



Especificaciones / Specifications



Acabados / Finishes

- 18 Marrón óxido
- Rusted/oxide brown
- Rouille
- Rostbraun
- Marrone ossido
- Marron óxido



**MODULO**  
ELECTRO  
[www.modulelectro.ru](http://www.modulelectro.ru)

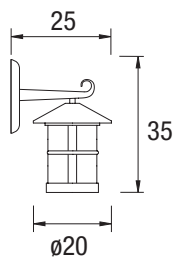

**05-9132-18-AA**

E-27 max. 100W

PL elect. E-27 max.18W

IP 23 4

18W Included

PC IP+

Materiales / Materials



Especificaciones / Specifications



Acabados / Finishes

- 18 Marrón óxido
- Rusted/oxide brown
- Rouille
- Rostbraun
- Marrone ossido
- Marrom óxido



**MODULO**  
ELECTRO  
[www.modulelectro.ru](http://www.modulelectro.ru)

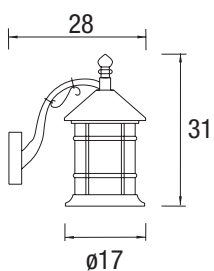

**05-9100-18-37** ■

 E-27 max. 100W

 PL elect. E-27 max. 20W

IP 23   4 

**IP+**



# MORFEO

224

Morfeo



Materiales / Materials



Especificaciones / Specifications

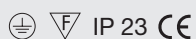

Acabados / Finishes

■ 18 Marrón óxido Rusted/oxide brown Rouille Rostbraun Marrone ossido Marrom óxido	■ 34 Gris Grey Gris Grau Grigio Cinzeno	■ J6 Marrón Brown Marron Braun Marrone Castanho
---	--	--

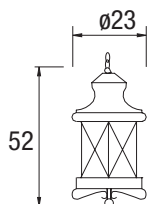

00-9175-18-AA ■

3 x E-14 max. 60W

IP 23 2



# MODULO ELECTRO

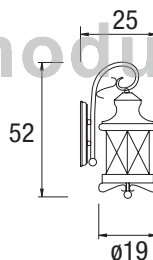

05-9175-18-AA ■

3 x E-14 max. 60W

IP 23 4

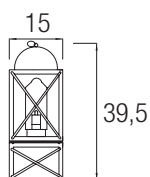

10-9432-34-B8 ■ (S)

10-9432-J6-B8 ■ (S)

E-14 max. 60W

IP 23 4

2,5 m **Included**



# POSIDO

226

Hades/Posido

## Materiales / Materials



## Especificaciones / Specifications



## Acabados / Finishes

- 14 Blanco  
White  
Blanc  
Weiß  
Bianco  
Branco

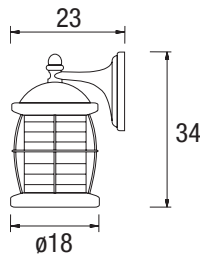

**05-9258-14-B8**  (S)

E-27 max. 60W

PL elect. E-27 max. 18W

IP 23 4

13W **Included**

**MODULO**  
ELECTRO

[www.modulelectro.ru](http://www.modulelectro.ru)

# HADES

## Materiales / Materials



## Especificaciones / Specifications



## Acabados / Finishes

- 18 Marrón óxido  
Rusted/oxide brown  
Rouille  
Rostbraun  
Marrone ossido  
Marrom óxido

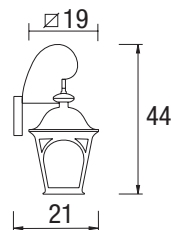

**05-8938-18-37**

E-27 max. 100W

PL elect. E-27 max. 23W

IP 23 4

**CRIS +** **Included**

**IP+**

# SIRENA

Materiales / Materials	Especificaciones / Specifications	Acabados / Finishes
 	   	 18 Marrón óxido Rusted/oxide brown Rouille Rostbraun Marrone ossido Marrom óxido

227

Triton / Sirena

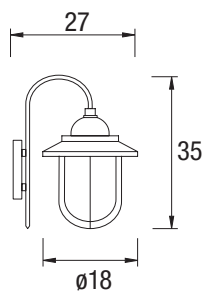

**05-9104-18-M2** 

 E-27 max. 60W

 PL elect. E-27 max. 18W

IP 44   6 



[www.modulelectro.ru](http://www.modulelectro.ru)

# TRITON

Materiales / Materials	Especificaciones / Specifications	Acabados / Finishes
 	    	 05 Negro Black Noir Schwarz Nero Preto

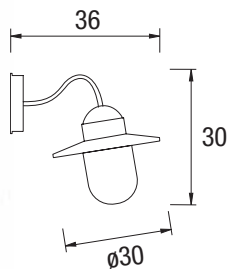

**05-8959-05-37** 

 E-27 max. 100W

 PL elect. E-27 max. 18W

IP 44   4 

# IRIS

228

Perseo / Iris

## Materiales / Materials



## Especificaciones / Specifications



## Acabados / Finishes

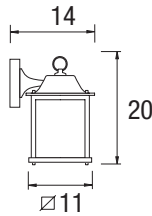
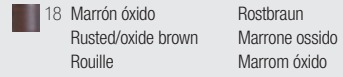

**05-8726-18-37**

E-27 max. 100W

PL elect. E-27 max. 12W

IP 23 12

**CRIS + Included**

# PERSEO

## Materiales / Materials



## Especificaciones / Specifications



## Acabados / Finishes

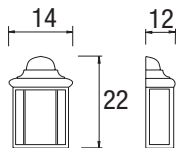
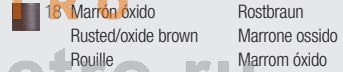

**05-8761-18-37**

E-27 ø45 max. 60W

PL elect. E-27 max. 12W

IP 23 12

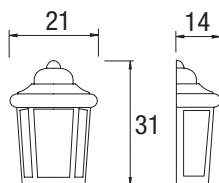

**05-8762-18-37**

E-27 max. 100W

PL elect. E-27 max. 21W

IP 23 6

**MODULO ELECTRO**  
www.modulelectro.ru

# OCEANO

## Materiales / Materials



## Especificaciones / Specifications



## Acabados / Finishes

- 18 Marrón óxido  
Rusted/oxide brown  
Rouille  
Rostbraun  
Marrone ossido  
Marrom óxido



  
[www.modulelectro.ru](http://www.modulelectro.ru)

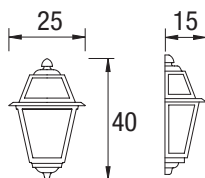

**05-9158-18-AA ■**

 E-27 max. 100W

 PL elect. E-27 max. 23W

IP 23   6 

 18W **Included**

# ATLANTIDA

230

Atlantida

## Atlantida collection

- Serie de apliques, todos ellos realizados en aluminio inyectado. Una colección con variedad de difusores, según las necesidades del cliente.
- Wall fixtures made of die-cast aluminium. A collection with a wide variety of diffusers, according to clients' requirements.
- Série d'appliques, toutes réalisées en aluminium injecté. Une collection offrant un large choix de diffuseurs en fonction des besoins du client.
- Apliques realizzatos in alluminio iniettato. Una collezione con varietà di diffusori a seconda delle necessità del cliente.
- Apliques feitos em alumínio injectado. Uma coleção com uma grande variedade de difusores, de acordo com as necessidades do cliente.

 **MODUL**   
ELECTRO  
[www.modulelectro.ru](http://www.modulelectro.ru)



Materiales / Materials



Especificaciones / Specifications



Acabados / Finishes

- 18 Marrón óxido  
Rusted/oxide brown  
Rouille  
Rostbraun  
Marrone ossido  
Marrom óxido

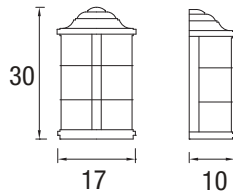

**05-9379-18-T2** ■

○ E-27 max. 60W

⚡ PL elect. E-27 max. 23W

IP 23

⚡ 18W **Included**

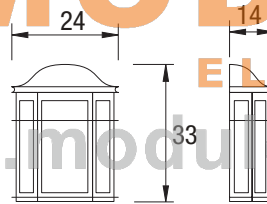

**05-8965-18-M3** ■

○ 2 x E-27 max. 60W

⚡ 2 x PL elect. E-27 max. 23W

IP 23

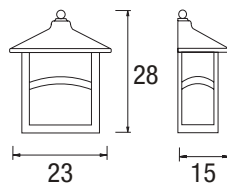

**05-9249-18-AA** ■ (S)

○ E-27 max. 100W

⚡ PL elect. E-27 max. 18W

IP 23

⚡ 13W **Included**





# GALATEA



232

Galatea



## Galatea collection

- La Serie Galatea ofrece una gran variedad de alternativas de iluminación en todo tipo de ambientes señoriales.
- The Galatea Collection offers a wide range of lighting alternatives for all kinds of noble environments.
- La Série Galatea offre une grande variété d'alternatives d'illumination pour tout type d'ambiances seigneuriales.
- Die Produktserie Galatea bietet eine große Auswahl an Beleuchtungsmöglichkeiten für alle Arten von vornehmen Ambiente.
- La Serie Galatea offre una gran varietà di alternative di illuminazione in qualsiasi tipo di ambiente signorile.
- A Série Galatea oferece uma grande variedade de alternativas de iluminação para todo o tipo de ambientes senhoriais.

**MODULO**  
ELECTRO  
[www.modulselectro.com](http://www.modulselectro.com)



Materiales / Materials



Especificaciones / Specifications



Acabados / Finishes

- 18 Marrón óxido
- Rusted/oxide brown
- Rouille
- Rostbraun
- Marrone ossido
- Marron óxido

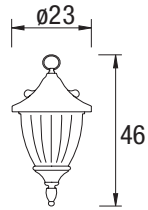

**00-9151-18-E7** ■

E-27 max. 100W

PL elect. E-27 max. 23W

IP 23 4

18W **Included**

**IP+**

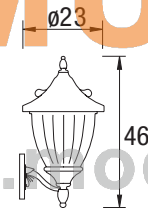

**05-9151-18-E7** ■

E-27 max. 100W

PL elect. E-27 max. 23W

IP 23 4

18W **Included**

**IP+**

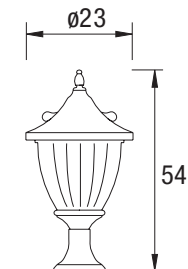

**10-9151-18-E7** ■

E-27 max. 100W

PL elect. E-27 max. 23W

IP 23 4

18W **Included**

**IP+**



**MODUL**  
ELECTRO  
[www.modulelectro.ru](http://www.modulelectro.ru)

Materiales / Materials



Especificaciones / Specifications



Acabados / Finishes

- 18 Marrón óxido  
Rusted/oxide brown  
Rouille  
Rostbraun  
Marrone ossido  
Marrom óxido

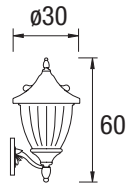

**05-9152-18-E7**

3 x E-14 max. 60W

IP 23 2

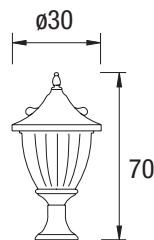

**10-9152-18-E7**

3 x E-14 max. 60W

IP 23 2

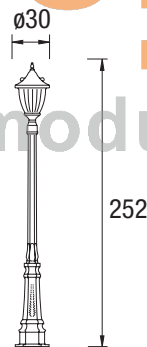

**60-9151-18-E7**

3 x E-14 max. 60W

IP 23 2

**55-9151-18-18**

Columna / column

278

farola completa / complete lamppost

**60-9151-18-E7 + 55-9151-18-18**

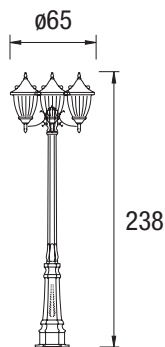

**60-9152-18-E7**

3 x E-27 max. 100W

3 x PL elect. E-27 max. 23W

IP 23 2

3 x 18W **Included**

**55-9151-18-18**

Columna / column

278

farola completa / complete lamppost

**60-9152-18-E7 + 55-9151-18-18**

IP+

**MODULO**  
ELECTRO  
www.modulelectro.ru

# OLIMPO

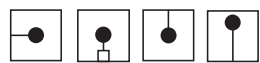

236

Olimpo



## Olimpo collection

- La Serie Olimpo ofrece una amplia variedad de opciones al cuatro caras. Fabricada en aluminio inyectado y con difusor de cristal transparente, incluye un cristal de recambio de cortesía.
- The Olimpo collection offers a wide range of options, with a four-side design. It is made of die-cast aluminium and transparent glass diffuser, and includes a spare glass.
- La Série Olimpo propose une grande variété d'options pour les modèles à quatre faces. Fabriquée en aluminium injecté et avec un diffuseur en verre transparent, cette série inclut un verre de rechange offert.
- Die Produktserie Olimpo, mit vier Seiten, bietet eine Vielfalt an Anwendungsmöglichkeiten. Sie ist aus gespritztem Aluminium hergestellt und verfügt über einen transparenten Kristalldiffusor, außerdem schließt sie ein nicht angerechnetes Ersatzkristall ein.
- La Serie Olimpo offre un'ampia varietà di opzioni per il quattro facce. Fabbricata in alluminio iniettato e con un diffusore di cristallo trasparente comprende un cristallo di ricambio omaggio.
- A Série Olimpo oferece uma grande variedade de opções de quatro faces. Fabricada em alumínio inyectado e com difusor de vidro transparente, inclui um vidro de substituição como oferta.

**MODUL**  
ELECTRO  
[www.modulelectro.ru](http://www.modulelectro.ru)



Materiales / Materials



Especificaciones / Specifications



Acabados / Finishes

- 05 Negro
- Black
- Noir
- Schwarz
- Nero
- Preto

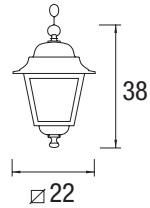

**00-8715-05-37** ■

E-27 max. 100W

PL elect. E-27 max. 23W

IP 23

**CRIS +** **Included**

**IP+**

**MODULO**

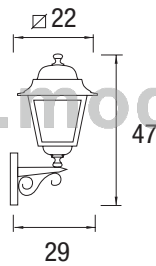

**05-8715-05-37** ■

E-27 max. 100W

PL elect. E-27 max. 23W

IP 23

**CRIS +** **Included**

**IP+**

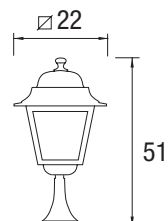

**10-8715-05-37** ■

E-27 max. 100W

PL elect. E-27 max. 23W

IP 23

**CRIS +** **Included**

**IP+**



 **MODULO**   
ELECTRO  
[www.modulelectro.ru](http://www.modulelectro.ru)

Materiales / Materials



Especificaciones / Specifications



Acabados / Finishes

- 05 Negro
- Black
- Noir
- Schwarz
- Nero
- Preto

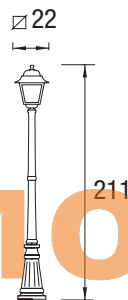

**60-8772-05-37** ■

E-27 max. 100W

PL elect. E-27 max.23W

IP 23

**CRIS + Included**

**IP+**

**55-8793-05-05** ■

Columna / column

278

set completo / complete lamppost

**60-8772-05-37 + 55-8793-05-05**

**IP+**



www.modulelectro.ru

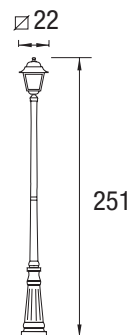

**55-8766-05-05** ■

Columna / column

278

set completo / complete lamppost

**60-8772-05-37 + 55-8766-05-05**

**IP+**

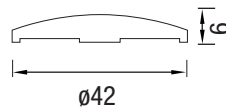

**71-9206-05-05** ■ (S)

Contrapeso para farolas / Balancing weight for lamppost

**9 Kg**



# ATLANTE

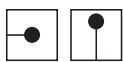

240

Atlante



## Atlante collection

- Atlante es el faro cuatro caras clásico, disponible tanto en applique como en farola de dos alturas.
- Atlante is the classic four-side lighthouse, available as wall fixture and two-height lamp-post.
- L'Atlante représente le réverbère classique à quatre faces, disponible en applique comme en réverbère à deux hauteurs.
- Atlante ist ein klassischer Scheinwerfer mit vier Seiten und ist sowohl als Wandleuchte als auch als Laterne in zwei Höhengrößen erhältlich.
- Atlante è il faro quattro facce classico, disponibile tanto in applique quanto in lampione di due altezze.
- Atlante é o farol de quatro faces clássico, disponível tanto em applique como em farol de duas alturas.

 **MODULO**   
ELECTRO  
[www.modulelectro.ru](http://www.modulelectro.ru)



Materiales / Materials



Especificaciones / Specifications



Acabados / Finishes

- 05 Negro
- Black
- Noir
- Schwarz
- Nero
- Preto

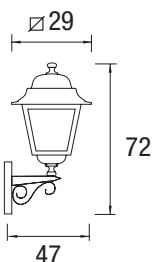

**05-9103-05-37** ■

- E-27 max. 200W
- PL elect. E-27 max.30W
- Mezcla E-27 max. 160W

IP 23 2

**CRIS + Included**

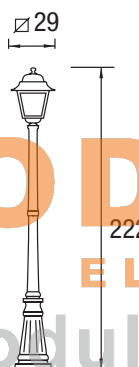

**60-9103-05-37** ■

- E-27 max. 200W
- PL elect. E-27 max.30W
- Mezcla E-27 max. 160W

IP 23 2

**CRIS + Included**

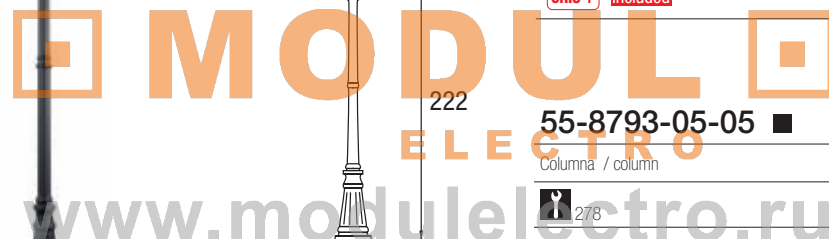

**55-8793-05-05** ■

Columna / column



farola completa / complete lamppost

**60-9103-05-37 + 55-8793-05-05**

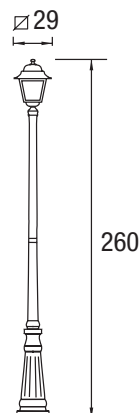

**55-8766-05-05** ■

Columna / column



farola completa / complete lamppost

**60-9103-05-37 + 55-8766-05-05**

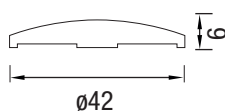

**71-9206-05-05** ■ (S)

Contrapeso para farolas / Balancing weight for lamppost



# ROCK



Design by Josep Juanola

## Rock collection

- Cubo iluminado con formas orgánicas, que puede ser utilizado como asiento. Disponible con lámpara de bajo consumo o LED RGB; esta última versión se controla con un mando a distancia.
- Illuminated cube with organic shapes which can be used as a seat. Available with a low consumption lamp or LED RGB, this last version is remote controlled.
- Cube illuminé aux formes organiques qui peut servir d'assise. Disponible avec lampe basse consommation ou LED RGB, cette dernière version étant contrôlée par télécommande.
- Beleuchtete Eimer in organischen Formen, die auch als Sitz dienen. Lieferbar mit Energiesparlampe oder mit ferngesteuertem LED RGB.
- Cubo con forme organiche illuminato che può essere utilizzato come sedile. Disponibile con lampadina a basso consumo o LED RGB, quest'ultima versione si controlla con un telecomando a distanza.
- Cubo com formas orgânicas iluminado que pode ser utilizado como assento. Disponível com lâmpada de baixo consumo ou LED RGB, esta última versão controla-se com um comando à distância.

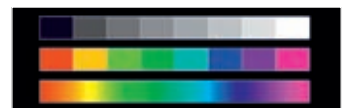

Materiales / Materials



Incluido / Included



Especificaciones / Specifications



Acabados / Finishes

- M1 Blanco mate  
Matt white  
Blanc mate  
Weiß mat  
Bianco matt  
Branco satinado

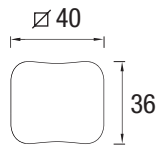

**55-9520-M1-M1**

LED RGB 5 W - 230V

IP 65 2

Puede usarse como asiento - Máx. 110 Kg.  
It can be a sitting place - Max. 110 kg

Consultar disponibilidad.  
Check availability.

# MODULO

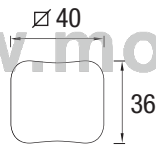

**55-9521-M1-M1**

E-27 max.150W  
 PL elect. E-27 max.30W

IP 65 2

Puede usarse como asiento - Máx. 110 Kg.  
It can be a sitting place - Max. 110 kg

Consultar disponibilidad.  
Check availability.

www.moduloelectro.ru



**71-9520-00-00**

Un mando a distancia puede controlar multitud de cubos 55-9520  
A remote control can monitor several cubes 55-9520

4

Consultar disponibilidad.  
Check availability.

# CISNE

244

Cisne

## Materiales / Materials



## Especificaciones / Specifications



## Acabados / Finishes

- M1 Blanco mate  
Matt white  
Blanc mate  
Weiß mat  
Bianco matt  
Branco satinado

## Incluido / Included



**MODULO**  
ELECTRO



[www.modulelectro.ru](http://www.modulelectro.ru)

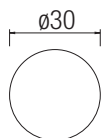

### 55-9155-M1-M1

E-27 max. 100W

PL elect. E-27 max. 23W

IP 44 2

18W **Included**

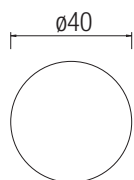

### 55-9156-M1-M1

E-27 max. 150W

PL elect. E-27 max. 30W

IP 44 2

18W **Included**

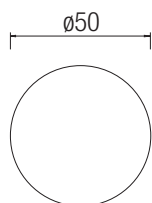

### 55-9481-M1-M1

E-27 max. 150W

PL elect. E-27 max. 30W

IP 44 2

18W **Included**



**71-9403-34-34** ■ (S)

Controlador RGB 230V hasta 50W  
RGB Control System 230V up to 50W

IP 54 2

**71-9404-34-34** ■ (S)

Controlador RGB 230V hasta 100W  
RGB Control System 230V up to 100W

IP 54 2



**71-9495-34-34** ■

Controlador **MASTER** RGB 230V hasta 50W  
RGB **MASTER** Control System 230V up to 50W

IP 54 2

**71-9496-34-34** ■

Controlador **MASTER** RGB 230V hasta 100W  
RGB **MASTER** Control System 230V up to 100W

IP 54 2



**71-9497-34-34** ■

Controlador **ESCLAVO** RGB 230V hasta 100W  
RGB **SLAVE** Control System 230V up to 100W

IP 54 2

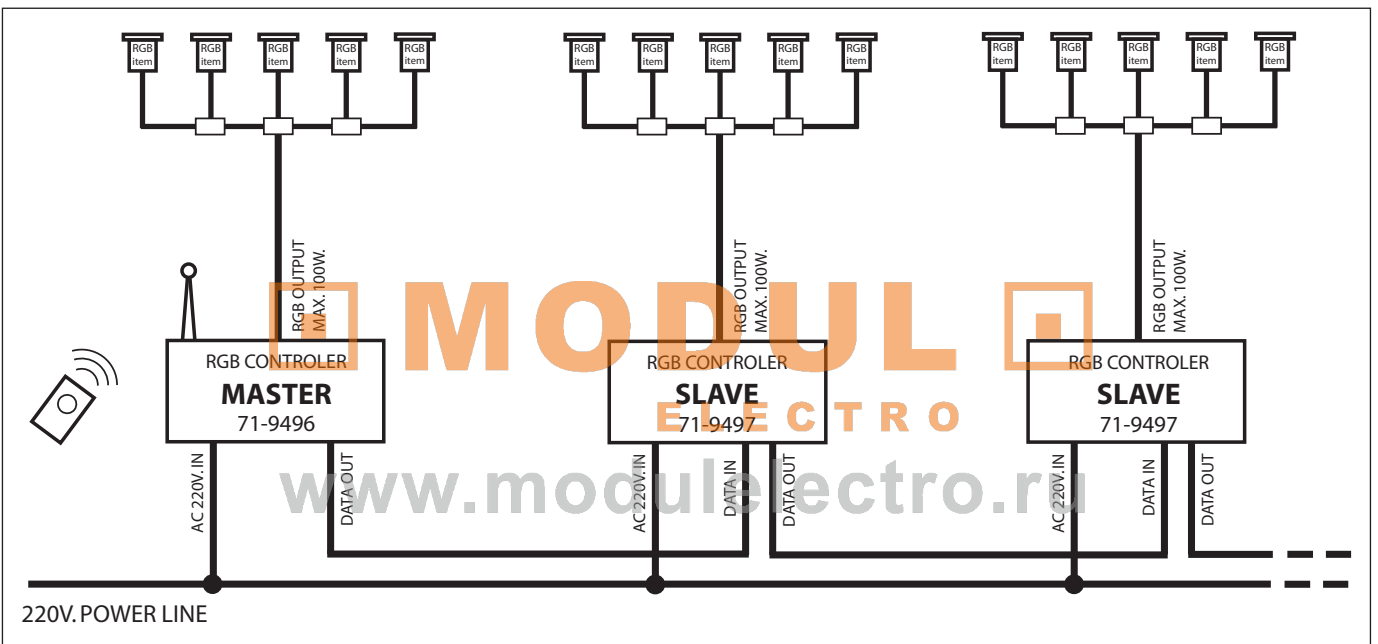

**¿POR QUÉ LO LLAMAMOS EASY RGB?  
WHY IS IT CALLED EASY RGB?**



Toda la instalación se realiza mediante cables standard de 3 polos.  
The whole installation is carried out by means of Standard 3-pole wires.



Toda la instalación se realiza con conectores standard.  
The whole installation is carried out with Standard connectors.



Podemos usar el pulsador situado en el lateral de la caja del controlador para cambiar el programa en caso de pérdida o falta de batería del mando a distancia.

We can use the button located on the side of the controller box to change the program in case of dead battery or loss of the remote control.



Un pequeño LED rojo situado en el lateral de la caja del controlador nos indica que hay un cruce en alguna parte de la instalación.

A red LED placed on the side of the controller box shows that there is a short circuit in some part of the installation.

**POSICIONES DEL PROGRAMA  
PROGRAM POSITIONS**

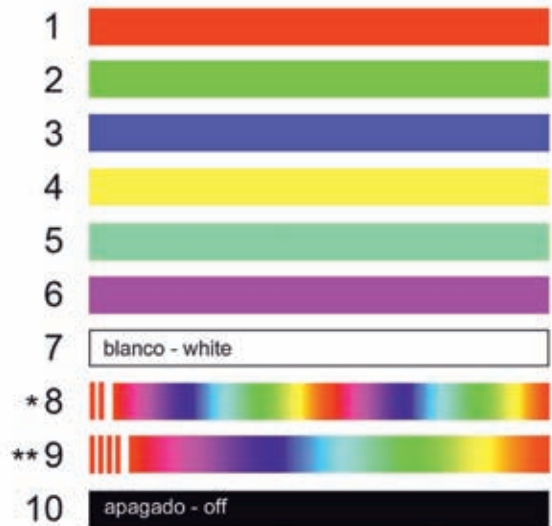

\* 2 flash, cambia todos los colores uno a uno durante 90 segundos y vuelve a empezar.  
2 flash, changes all the colours one by one for 90 seconds and restarts.

\*\* 4 flash, cambia todos los colores uno a uno durante 330 segundos y vuelve a empezar.  
4 flash, changes all the colours one by one for 330 seconds and restarts.

## Ion collection

- Perfil led de aluminio de alta eficiencia y elevada estanqueidad. Versiones en diferentes tonalidades de blancos y RGB, que proporciona una luz completamente uniforme al incorporar la tecnología triled. Fácilmente controlable con sistemas DMX, Dali, etc.
- High efficiency and sealing aluminium led profile. RGB and several white shades versions, which provide a complete even light by integrating the tri led technology. Easy to control by means of DMX, Dali, etc. systems.
- Diode électroluminescente profilée en aluminium haut rendement et à étanchéité élevée. Versions dans différentes tonalités de blancs et RGB; intègre la technologie Triled. Facilement contrôlable par les de systèmes DMX, Dali, etc.
- LED-Profil aus Aluminium mit hoher Lichtausbeute und hoher Dichtheit. Ausführungen in verschiedenen weißen Lichttönen und RGB, mit TRI-LED-Technologie. Leicht zu regeln per DMX, Dali, ...
- Profilo led di alluminio ad alto rendimento ed elevato grado di tenuta stagna. Versioni in varie tonalità di bianco e RGB, proporciona una luce completamente uniforme grazie alla tecnologia incorporata 3 led. Facilmente controllabile con sistema DMX, Dali, ecc.
- Perfil led de aluminio de alta eficiencia e elevada estanqueidade. Versões em diferentes tonalidades de brancos e RGB, que proporciona uma luz completamente uniforme ao incorporar a tecnologia triled. Facilmente controlável com sistemas DMX, Dali, etc.



MODUL  
ELECTRO  
www.modulelectro.ru

Materiales / Materials

ALU

Especificaciones / Specifications



Acabados / Finishes

54 Aluminio anodizado  
Anodized aluminium  
Aluminium anodisé  
Eloxierties Aluminium  
Alluminio anodizzato  
Aluminio anodizado

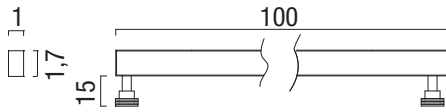

91-3407-54-M2 ■

12 VDC 14,4W 1 m 250 lm RGB

IP 68

91-3408-54-M2 ■

12 VDC 14,4W 1 m 440 lm Warm white 2900K

IP 68

91-3409-54-M2 ■

12 VDC 14,4W 1 m 520 lm Cold white 6000K

IP 68

**MODULO**  
ELECTRO

91-3410-54-M2 ■

12 VDC 7,2W 0,5 m 125 lm RGB

IP 68

91-3411-54-M2 ■

12 VDC 7,2W 0,5 m 220 lm Warm white 2900K

IP 68

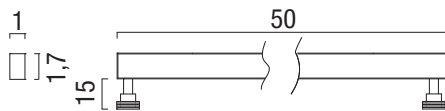

91-3412-54-M2 ■

12 VDC 7,2W 0,5 m 260 lm Cold white 6000K

IP 68

Equipos (ver pág. 270-271 / Gears (see page 270-271))

71-3479-00-00 (100W-12VDC) IP 67

Controladores RGB / RGB controlers

71-3314-00-00, 71-3431-00-00, 71-3432-00-00 (144W-12A)

Equipos de control / Controller devices

71-3472-00-00 (1-10V)

71-3473-00-00 (DALI)

71-3474-00-00 (DMX)

Amplificador / Amplifier

71-3433-00-00

\* Consultar condiciones comerciales.  
\* Consult commercial conditions.  
\* Consulter les conditions commerciales.

\* Handelsbedingungen abfragen.  
\* Consultare le condizioni commerciali.  
\* Consultar condições comerciais.



# ZENIT

Zenit  
248

## Zenit collection

- Innovadora tira led de 5m que permite el control del color de la luz blanca, desde blanco cálido (3000k) a blanco frío (6000k). Está compuesta por 600 leds SMD. Esta debe ser controlada con el controlador 71-3467 y amplificador 71-3468.
- 5 m innovative led strip which allows controlling the white light colour, from warm white (3000k) to cold white (6000k). It consists of 600 SMD leds. It shall be controlled by the means of the 71-3467 controller and the 71-3468 amplifier.
- Bande à diodes électroluminescentes innovatrice de 5 m qui permet le contrôle de la couleur de la lumière blanche, du blanc chaud (3 000 k) au blanc froid (6 000 k). Prévoit l'installation de 600 diodes électroluminescentes SMD. Doit se contrôler par le biais du contrôleur 71-3467 et de l'amplificateur 71-3468
- Innovatives. LED-Band 5 Meter lang zur Regelung der Farbe von weißem Licht: von warmem Weiß (3000k) bis zu kaltem Weiß (6000k). Installation von 600 LEDs SMD. Muss über die Regler 71-3467 und Verstärker 71-3468 gesteuert werden.
- Innovativa fascia led di 5 metri che permette il controllo della luce bianca, dal bianco caldo (3000k) al bianco freddo (6000k). È formata da 600 led SMD. Deve essere controllata con il pannello di controllo 71-3467 e con l'amplificatore 71-3468.
- Inovadora tira led de 5m que permite o controlo da cor da luz branca, desde branco cálido (3000k) a branco frio (6000k). Está composta por 600 leds SMD. Esta deve ser controlada com o controlador 71-3467 e amplificador 71-3468.



Especificaciones / Specifications

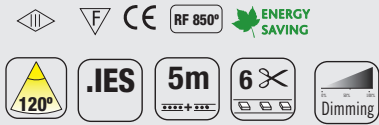

**91-3467-00-00** □

12 VDC 48W 5 m Cold W. 7000K 576 lm Warm W. 3000K 576 lm

IP 67

**MODUL**

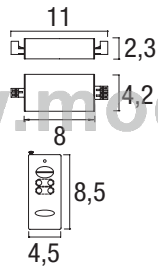

**71-3467-00-00** □

Controlador / Controller

12 VDC 72W

IP 20

www.modulselectro.ru

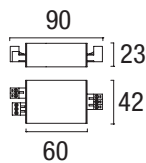

**71-3468-00-00** □

Amplificador / Amplifier

12 VDC 72W

IP 20



**71-3454-54-M2** ■

Perfil de 2 m.  
2 m. profile



\* Consultar condiciones comerciales. \* Handelsbedingungen abfragen.  
\* Consult commercial conditions. \* Consultare le condizioni commerciali.  
\* Consulter les conditions commerciales. \* Consultar condições comerciais.

Equipos (ver pág. 270-271 / Gears (see page 270-271)

71-3435-00-00 (72w-6A),  
71-3436-00-00 (120w-10A),  
71-3437-00-00 (360w-30A)  
71-3479-00-00 (100W-12VDC) ) IP 67

# RAND

250

Rand

## Rand collection

- Tiras flexibles de 5 metros de longitud, de alta eficiencia lumínica y completamente estancas. Versión RGB de 150 SMD led y dos versiones blancas con 300 SMD leds. Ideal para instalaciones exteriores, sumergidas y ambientes muy húmedos.
- 5 metre long flexible strips, of high light efficiency that are fully water proof. There is a RGB version of 150 SMD led and two white versions with 300 SMD leds. Ideal for outdoor and underwater facilities and in very damp environments.
- Bandes flexibles de 5 mètres de long, à haut rendement et entièrement étanches. Version RVB à diodes électroluminescentes de 150 SMD et deux versions blanches avec diodes électroluminescentes de 300 SMD. Idéales pour les installations immergées et les environnements très humides.
- Flexible Bänder 5 Meter lang mit hoher Lichtausbeute. und vollkommen dicht. RGB-Version mit 150 SMD-LEDs und zwei weiße Ausführungen mit 300 SMD-LEDs. Ideal für Unterwasserinstallationen und sehr feuchte Umgebungen.
- Fasce flessibili di 5 metri di lunghezza, ad alta efficienza luminosa e a tenuta stagna. Versione RGB di 150 SMD led e due versioni bianche con 300 SMD led. Ideale per installazioni in esterno, sott'acqua e ambienti molto umidi.
- Tiras flexíveis de 5 metros de longitude, de alta eficiência de luz e completamente estancas. Versão RGB de 150 SMD led e duas versões brancas com 300 SMD leds. Ideal para instalações exteriores, submersas e ambientes muito húmidos.



Especificaciones / Specifications

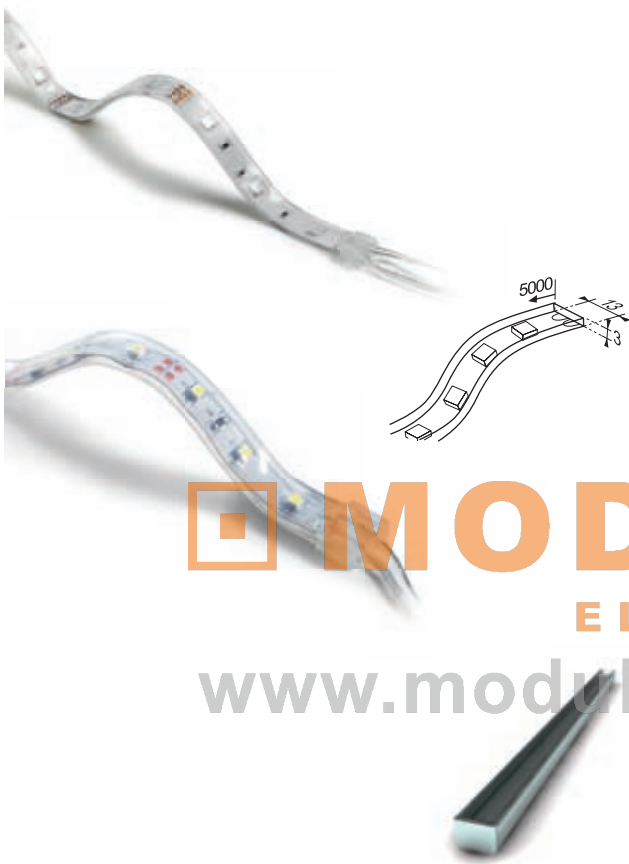

**MODULO**  
**ELECTRO**

[www.modulelectro.ru](http://www.modulelectro.ru)

**91-3419-00-00** □

12 VDC 24W 5 m 1075 lm Cold white 6000K

IP 65

**91-3420-00-00** □

12 VDC 24W 5 m 730 lm Warm white 3300K

IP 65

**91-3421-00-00** □

12 VDC 36W 5 m 1180 lm RGB

IP 65

**71-3454-54-M2** ■

Perfil de 2 m.  
2 m. profile



**Equipos (ver pág. 270-271 / Gears (see page 270-271))**

- 71-3435-00-00 (72w-6A),
- 71-3436-00-00 (120w-10A),
- 71-3437-00-00 (360w-30A)
- 71-3479-00-00 (100W-12VDC), ) IP 67

**Controladores RGB / RGB controllers**

- 71-3314-00-00, 71-3431-00-00, 71-3432-00-00 (144W-12A)

**Equipos de control / Controller devices**

- 71-3472-00-00 (1-10V)
- 71-3473-00-00 (DALI)
- 71-3474-00-00 (DMX)

**Amplificador / Amplifier**

- 71-3433-00-00

\* Consultar condiciones comerciales.      \* Handelsbedingungen abfragen.  
 \* Consult commercial conditions.        \* Consultare le condizioni commerciali.  
 \* Consulter les conditions commerciales.   \* Consultar condições comerciais.



**MODUL**  
ELECTRO  
[www.modulelectro.ru](http://www.modulelectro.ru)

## Heads collection <sup>®</sup>

- Colección de farolas de diseño moderno con difusor matizado, ideal para iluminar entornos públicos o residenciales. Existen versiones con y sin cubierta superior. Esta serie permite la sustitución de las lámparas sin herramientas.
- Modern design streetlamps collection with an ideal shading diffuser for public or residential environments lighting. Many versions are available, with or without upper cover. This series allows substituting the lamps without the need of tools.
- Collection de réverbères au design moderne munis d'un diffuseur teinté idéal pour l'éclairage des espaces publics ou résidentiels. Existe en versions avec et sans cache supérieur. Cette série permet de remplacer les lampes sans outils.
- Leuchten-Kollektion in modernem Design mit mattiertem Diffusor, ideal zu Beleuchtung öffentlicher Räume oder Wohnanlagen. In Ausführungen mit und ohne Abdeckung erhältlich. Die Lampen dieser Leuchte lassen sich ohne Werkzeuge auswechseln.
- Collezione di lampioni dal design moderno con diffusore sfumato ideale per illuminare ambienti pubblici o residenziali. Disponibili versioni con e senza la copertura superiore. Questa serie permette la sostituzione di lampadine senza l'uso di alcun attrezzo.
- Coleção de postes de desenho moderno com difusor matizado ideal para iluminar ambientes públicos ou residenciais. Existem versões com e sem coberta superior. Esta série permite a substituição das lâmpadas sem ferramentas.

<sup>®</sup> Registration number: 000966874-030 / 000966874-029



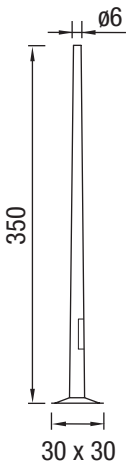

**55-9305-48-48 ■**

Columna 3,5 m / 3,5 m. column



280



Kit de instalación incluido.  
Installation kit included.  
Kit d'installation compris.  
Einbaukit inklusive.  
Kit installazione incluso.  
Kit de instalação incluso.



**71-9442-00-00**

Kit sodio alta presión y halogenuros metálicos 70W para 60-9375 y 60-9376  
70W high pressure sodium and metal halide Kit for 60-9375 and 60-9376

⦿ E-27 70W



**71-9399-05-05 ■**

Accesorio anti-contaminación lumínica para 60-9375 y 60-9376  
Anti light pollution accessory for 60-9375 and 60-9376



**71-9398-05-05 ■**

Accesorio anti-contaminación lumínica para 60-9306 y 60-9307  
Anti light pollution accessory for 60-9306 and 60-9307

Materiales / Materials



Sustitución de la lámpara sin herramientas.  
The bulb can be changed without any tools.  
Remplacement de la lampe sans outils.  
Leuchtmittelerersetzung ohne Werkzeuge.  
Sostituzione della lampadina senza degli attrezzi.  
Substituição de luminária sem ferramenta

Especificaciones / Specifications



Acabados / Finishes

- 48 Acero galvanizado.  
Galvanised steel.  
Acier galvanisé.  
Galvanisiertes Stahl.  
Acciaio galvanizzato.  
Aço galvanizado.
- Z5 Gris urbano  
Urban grey  
Gris urbain  
Stadtgrau  
Grigio urbano  
Cinzeno urbano

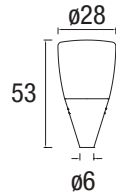

**60-9375-Z5-M3** ■ (S)

- ⦿ E-27 max. 150W
- ⦿ PL elect. E-27 max. 30W

IP 65 2 IK 08

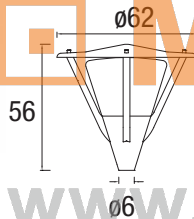
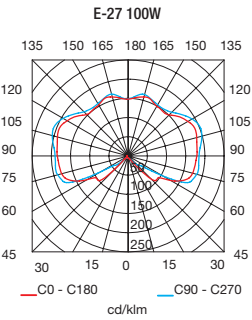

**60-9376-Z5-M3** ■

- ⦿ E-27 max. 150W
- ⦿ PL elect. E-27 max. 30W

IP 65 2 IK 08

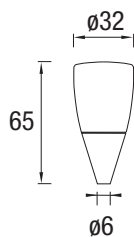
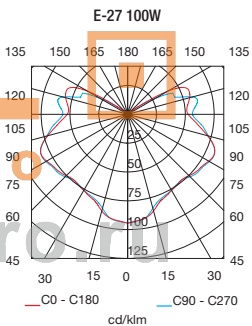

**60-9306-Z5-M3** ■ (S)

- ⦿ E-40 150W

IP 65 2 IK 08

BAG Included

60-9306 + 71-9398

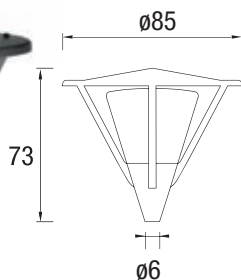
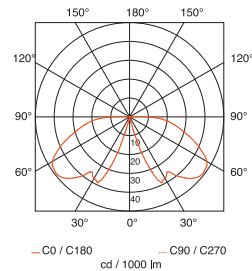

**60-9307-Z5-M3** ■

- ⦿ E-40 150W

IP 65 2 IK 08

BAG Included

60-9307 + 71-9398

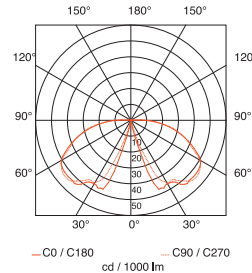

60-9307 + 55-9305

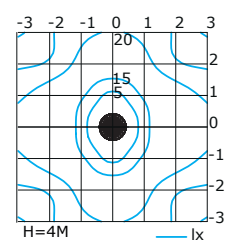





**MODUL**  
ELECTRO  
[www.modulelectro.ru](http://www.modulelectro.ru)

Materiales / Materials



Especificaciones / Specifications



Acabados / Finishes

■ 48 Acero galvanizado Galvanised steel Acier galvanisé Galvanisiertes Stahl Acciaio galvanizzato Aço galvanizado	■ Z5 Gris urbano Urban grey Gris urbain Stadtgrau Grigio urbano Cinzentu urbano
--	--

(new)

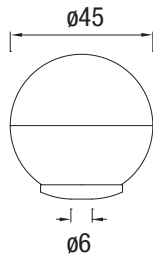

**60-9482-Z5-M2 ■**

⦿ E-27 max. 100W

⦿ PL elect. E-27 max. 30W

☐ IP 44 ☑ 6 🌿 IK 08

Sustitución de la lámpara sin herramientas.  
The bulb can be changed without any tools.  
Remplacement de la lampe sans outils.  
Leuchtmittelerersetzung ohne Werkzeuge.  
Sostituzione della lampadina senza degli attrezzi.  
Substituição de luminária sem ferramenta

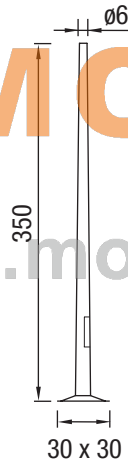

**MODULO ELECTRO**

www.modulelectro.ru

**55-9305-48-48 ■**

Columna 3,5 m / 3,5 m. column

⦿ 280



Kit de instalación incluido.  
Installation kit included.  
Kit d'installation compris.  
Einbaukit inklusive.  
Kit installazione incluso.  
Kit de instalação incluso.



**71-9508-00-00**



Kit sodio alta presión y halogenuros metálicos 70W para 60-9482  
70W high pressure sodium and metal halide Kit for 60-9482

⦿ E-27 70W

⦿ 2

Included



 **MODUL**   
ELECTRO  
[www.modulelectro.ru](http://www.modulelectro.ru)

## Temis collection <sup>®</sup>

- Colección de diseño moderno formada por apliques, balizas y farolas realizadas en aluminio extrusionado de alta calidad y difusor de policarbonato. La gran variedad de alturas y diámetros de las columnas permiten múltiples combinaciones. Los modelos están disponibles con lámparas de bajo consumo e incluyen reflectores anti-contaminación lumínica.
- Modern design collection which consists of wall lights, buoys and streetlamps made of high quality extrusionated aluminium and a polycarbonate diffuser. The wide range of columns heights and diameters allows multiple combinations. The models are available with low consumption lamps and include eco friendly reflectors.
- Collection au design moderne composée d'appliques, de balises et de réverbères en aluminium extrudé de grande qualité et munis d'un diffuseur en polycarbonate. Le vaste éventail de hauteurs et de diamètres des colonnes permettent des combinaisons variées. Les modèles sont disponibles avec lampes basse consommation et comprennent des réflecteurs anti-pollution lumineuse.
- Kollektion in modernem Design mit Wandleuchten, Signalleuchten und Laternen aus hochwertigem extrudiertem Aluminium mit Diffusor aus Polykarbonat. Die große Auswahl an verschiedenen Höhen und Ständerdurchmessern gestatten eine Vielfalt an Kombinationsmöglichkeiten. Die Modelle sind mit Energiesparlampen lieferbar und enthalten Reflektoren zur Eindämmung von Lichtverschmutzung.
- Collezione dal design moderno formata da applique, piantane e lampioni realizzati in alluminio estruso di alta qualità e con diffusore in policarbonato. La grande varietà di altezze e diametro delle colonne permettono molteplici combinazioni. I modelli sono disponibili con lampadine di basso consumo e comprendono riflettori anti-contaminazione luminosa.
- Coleção de desenho moderno formada por apliques, balizas e postes realizadas em alumínio extrusado de alta qualidade e difusor de policarbonato. A grande variedade de alturas e diâmetros das colunas permitem diversas combinações. Os modelos estão disponíveis com lâmpadas de baixo consumo e incluem reflectores anti-contaminação de luz.

 **MODUL** 

<sup>®</sup> Registration number: 000835277-0027



**ELECTRO**  
www.modulelectro.ru

Materiales / Materials



Especificaciones / Specifications



Acabados / Finishes

- 34 Gris
- Grey
- Gris
- Grau
- Grigio
- Cinzeno

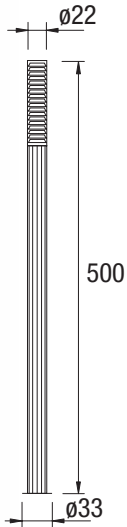

60-9293+55-9294

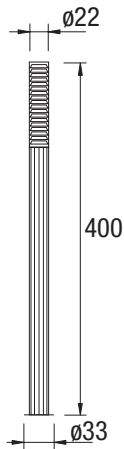

60-9293+55-9293

Fluorescente / Fluorescent

60-9293-34-M2 ■

4 x 2G11 80W

IP 65 2 IK 08

OSRAM **Included**

55-9293-34-34 ■

Columna 4 m / 4 m. column



55-9294-34-34 ■ (S)

Columna 5 m / 5 m. column

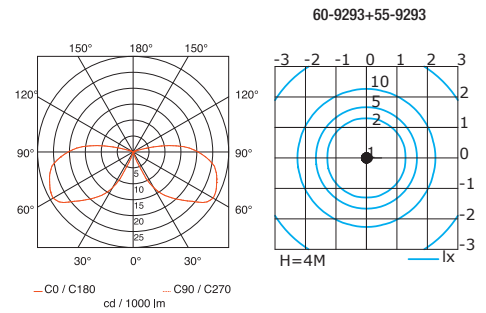

Potencia total: 320W / Total power: 320W.

**MODULO ELECTRO**

Sodio de alta presión y Halogenuros metálicos  
High pressure sodium and Metal Halide

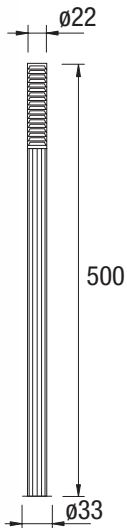

60-9294+55-9294

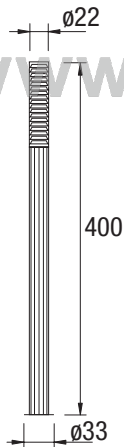

60-9294+55-9293

60-9294-34-M2 ■

2 x E-40 150W

IP 65 IK 08

PHILIPS **Included**

55-9293-34-34 ■

Columna 4 m / 4 m. column



55-9294-34-34 ■ (S)

Columna 5 m / 5 m. column

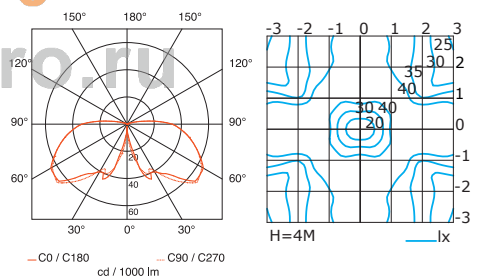

71-9513-52-52

Reflector direccional para 60-9294 y 60-9293  
Directional reflector for 60-9294 and 60-9293

2

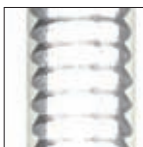

Reflectores anticontaminación lumínica.  
Anti light pollution reflectors.  
Réflecteurs anti-pollution lumineuse.  
Reflektore für eine umweltfreundliche Beleuchtung  
Riflettori anti-contaminazione luminica.  
Reflectores que previnem a contaminação luminosa.



Superficie estriada para evitar el pegado de adhesivos.  
Slotted surface to prevent sticking of adhesives.  
Superficie striée pour éviter le collage d'adhésifs.  
Gestreckte Oberflächen, um das Ankleben von Adhäsivmaterial zu vermeiden  
Superficie striata per evitare l'attacco degli adesivi.  
Superficie estriada para evitar a colagem de adesivos.



Kit de instalación incluido.  
Installation kit included.  
Kit d'installation compris.  
Einbaukit inklusive.  
Kit installazione incluso.  
Kit de instalação incluso.

Certificado CE para la instalación en espacios públicos.  
CE Certificate for installation in public places.  
Certificat CE pour l'installation dans les espaces publics.  
CE-Zertifikat für die Installation an öffentlichen Orten.  
Certificato CE per la installazione per degli spazi pubblici.  
Certificado CE para instalação em espaços públicos

Materiales / Materials



Especificaciones / Specifications



Acabados / Finishes

- 34 Gris
- Grey
- Gris
- Grau
- Grigio
- Cinzeno

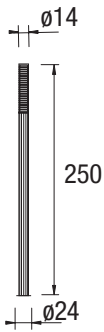

**55-9431-34-M2** ■

2 x GX24q-4 26-32-42W

IP 65 2 281 IK 08

**BAG** **Included**

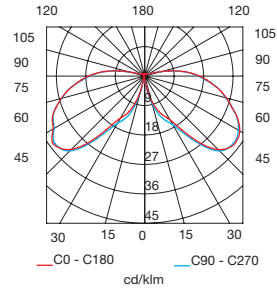

**71-9515-52-52**

Reflector direccional para 55-9431  
Directional reflector for 55-9431

2

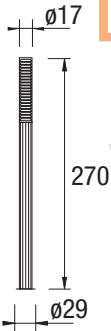

# MODULO



**55-9268-34-M2** ■

4 x 2G11 55W

IP 65 2 280 IK 08

**OSRAM** **Included**

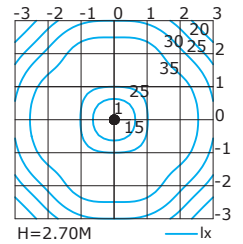
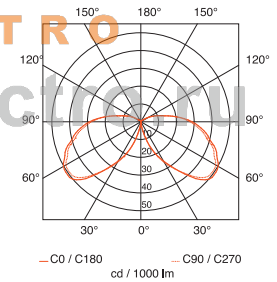

Potencia total: 220W / Total power: 220W.

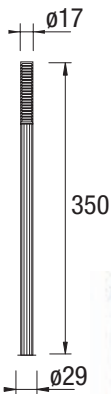

**55-9269-34-M2** ■

4 x 2G11 55W

IP 65 2 280 IK 08

**OSRAM** **Included**

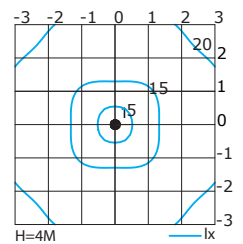
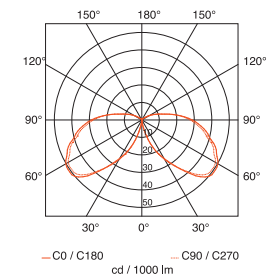

Potencia total: 220W / Total power: 220W.

**71-9514-52-52**

Reflector direccional para 55-9268 y 55-9269  
Directional reflector for 55-9268 and 55-9269

2





**MODUL**  
ELECTRO  
[www.modulelectro.ru](http://www.modulelectro.ru)

Materiales / Materials



Especificaciones / Specifications



Acabados / Finishes



(new)

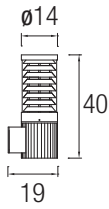

**05-9478-34-M2**

- E-27 max. 100W
- PL elect. E-27 max. 30W

IP 44 2 IK 08

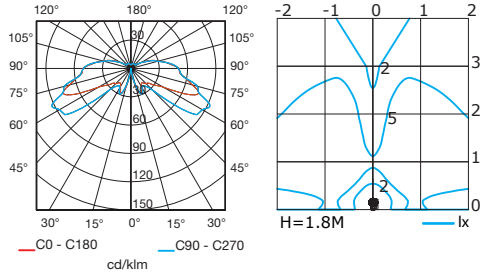

PL 30W

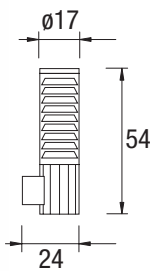

**05-9268-34-M2**

- E-27 - Halogen max. 150W
- PL elect. E-27 max. 30W
- Mezcla E-27 max. 160W

IP 44 2 IK 08

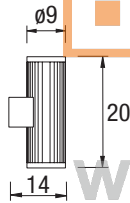
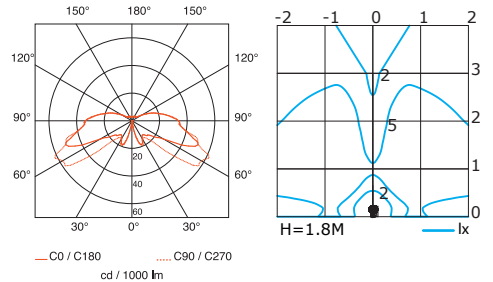

**05-9146-34-T2**

- 2 x GU-10 max. 50W
- 2 x GU-10 max. 14W Fluorescent
- 2 x GU-10 max. 5W LED

IP 44 4 IK 08

2 x OSRAM 50W **Included**

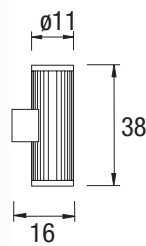
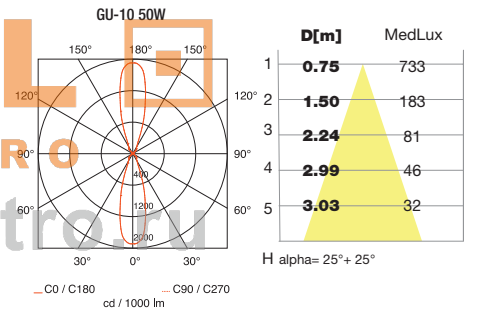

**05-9173-34-T2**

- 2 x Par-30 E-27 max. 75W
- 2 x PL elect. E-27 max. 23W

IP 44 4 IK 08

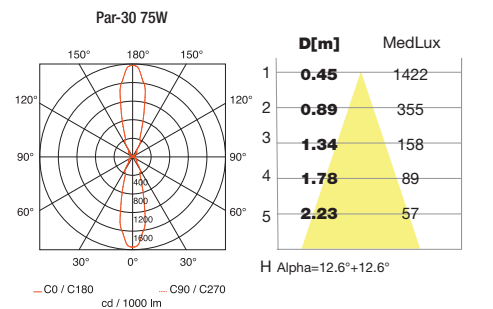

(new)

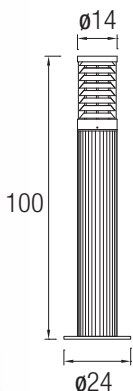

**55-9479-34-M2**

- E-27 max. 100W
- PL elect. E-27 max. 30W

IP 65 4 281 IK 08



**55-9530-34-M2**

- G12 70W HID

IP 65 4 281 IK 08

**Included**

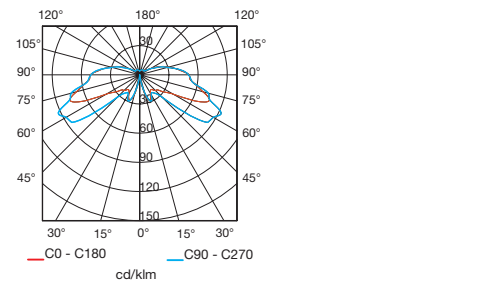

www.modulelectro.ru



En el catálogo URBAN encontrará una amplia gama de soluciones de alumbrado exterior público.

In URBAN catalogue you can find a wide range of solutions for exterior public system of illumination.



## ELIPSE LED

**CÓDIGO/ CODE**      **DESCRIPCIÓN/ DESCRIPTION**

80-4530-BQ-37      ELIPSE LED 45 W

Potencia LED 45W - LED power 45W  
 Eficiencia luminosa LED: 100 lm/W - Average lumen/watt: 100 lm/W

**IP 65**      **IK 08**

FHS INST = 0.1 %  
 LED REBEL 45W

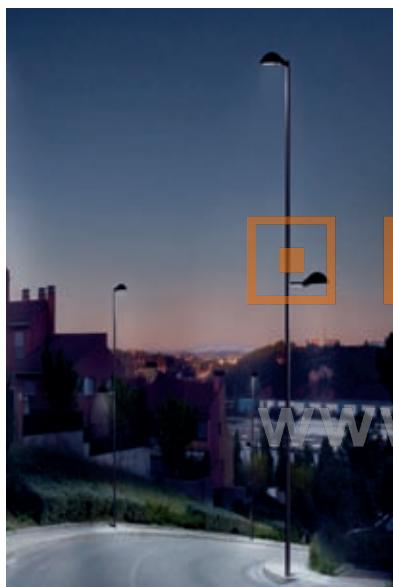

Altura de montaje: 4 - 10 m  
 Assembled height: 4 - 10 m

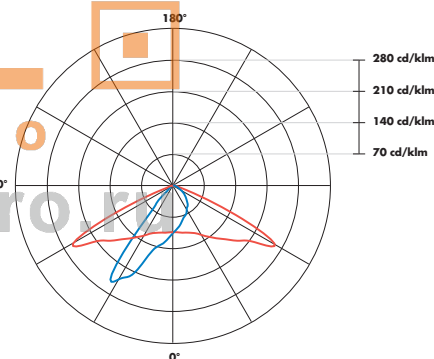
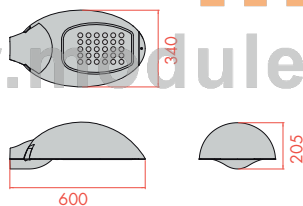

\* Consultar condiciones comerciales.  
 \* Consult commercial conditions.  
 \* Consulter les conditions commerciales.

\* Handelsbedingungen abfragen.  
 \* Consultare le condizioni commerciali.  
 \* Consultar condições comerciais.

Para ampliar información, consultar catálogo URBAN  
 For more information, please consult URBAN catalogue.

## ELIPSE DESCARGA

**CÓDIGO/ CODE**      **DESCRIPCIÓN/ DESCRIPTION**

80-3031-BQ-37      150W VSAP-HM / 150W HPS-MH  
 80-3034-BQ-37      150 W VSAP 2N / 150W HPS BIPOWER  
 80-3041-BQ-37      150W 2N TEMP VSAP / 150W HPS BIPOWER TIMED

Potencia disponible 70W-150W  
 Available power: 70W-150W

FHS INST = 0,1 %  
 VSAP 150W

**IP 65**      **IP 66**      **IK 08**

Luminaria      Bloque  
 óptico

Altura de montaje: 4 - 10 m  
 Assembled height: 4 - 10 m

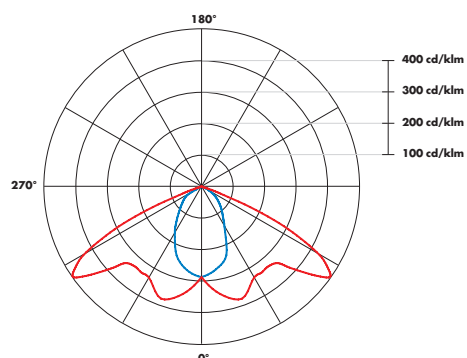
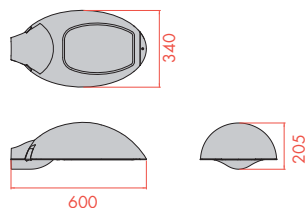

## PROMENADE LED

**CÓDIGO/ CODE**      **DESCRIPCIÓN/ DESCRIPTION**

83-4488-AX-37	COLUMNA PROMENADE 3 MTS + LUMINARIA LED 28W / COLUMN PROMENADE 3 MTS + LUMINAIRE LED 28W
83-4489-AX-37	COLUMNA PROMENADE 5 MTS + LUMINARIA LED 56W / COLUMN PROMENADE 5 MTS + LUMINAIRE LED 56W
83-4490-AX-37	COLUMNA PROMENADE 5 MTS + 2 LUMINARIA LED 28+56W / COLUMN PROMENADE 5 MTS + 2 LUMINAIRE LED 28 +56W
83-4491-AX-37	COLUMNA PROMENADE 5 MTS + 2 LUMINARIA LED 56+56W / COLUMN PROMENADE 5 MTS + 2 LUMINAIRE LED 56 +56W



Potencia LED 50W - LED power 50W  
Eficiencia luminosa LED: 90 lm/W - Average lumen/watt: 90 lm/W

**IP 66**      **IK 08**

Altura de montaje: 3-5 m  
Assembled height: 3-5 m

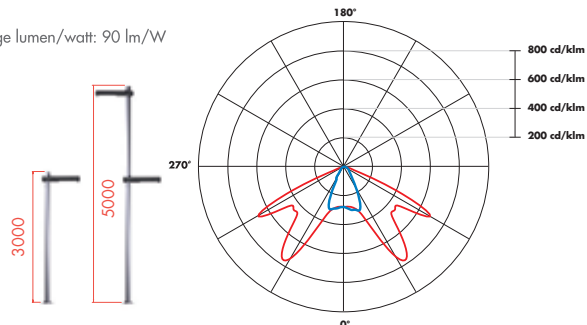
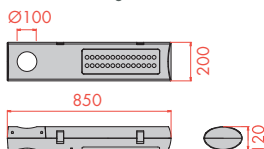

## PROMENADE DESCARGA

**CÓDIGO/ CODE**      **DESCRIPCIÓN/ DESCRIPTION**

83-4497-AX-37	150W HM / 150W MH
83-4501-AX-37	150W HM CII / 150W MH C-II
83-4504-AX-37	150W VSAP-HM / 150W HPS-MH
83-4507-AX-37	150W VSAP 2N / 150W HPS BIPOWER
83-4510-AX-37	150W VSAP 2N TEMP / 150W HPS BIPOWER TIMED
83-4513-AX-37	150W VSAP-HM CII / 150W HPS-MH C-II
83-4516-AX-37	150W VSAP 2N CII / 150W HPS BIPOWER C-II
83-4519-AX-37	150W VSAP 2N TEMP CII / 150W HPS BIPOWER C-II TIMED



Potencia disponible: 70-150W  
Available power: 70-150W

**IP 66**      **IK 08**

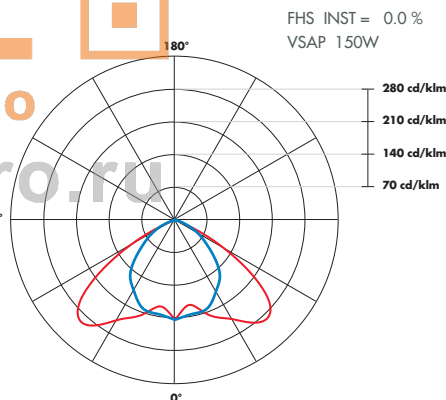
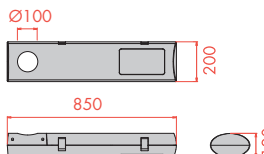

## PROMENADE FLUOR

**CÓDIGO/ CODE**      **DESCRIPCIÓN/ DESCRIPTION**

83-3023-AX-37	COLUMNA PROMENADE 3 MTS + LUMINARIA 2x36W FLUORESCENTE/ COLUMN PROMENADE 3 MTS + LUMINAIRE 2x36W FLUORESCENT
83-3024-AX-37	COLUMNA PROMENADE 5 MTS + LUMINARIA LED 56W FLUORESCENTE/ COLUMN PROMENADE 5 MTS + LUMINAIRE LED 56W FLUORESCENT
83-3025-AX-37	COLUMNA PROMENADE 5 MTS + 2 LUMINARIA LED 28+56W FLUORESCENTE/ COLUMN PROMENADE 5 MTS + 2 LUMINAIRE LED 28 +56W FLUORESCENT



Potencia disponible 36W  
Available power: 36W

**IP 66**      **IK 08**

Altura de montaje: 3-5 m  
Assembled height: 3-5 m

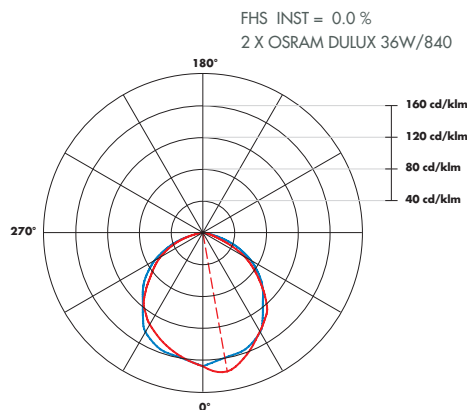
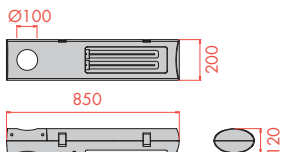

\* Consultar condiciones comerciales.  
\* Consult commercial conditions.  
\* Consulter les conditions commerciales.

\* Handelsbedingungen abfragen.  
\* Consultare le condizioni commerciali.  
\* Consultar condições comerciais.

Para ampliar información, consultar catálogo URBAN  
For more information, please consult URBAN catalogue.

# LUMINARIAS DE ALUMBRADO PÚBLICO

## BOHEMIA LED

CÓDIGO/ CODE DESCRIPCIÓN/ DESCRIPTION

80-4528-BP-37 BOHEMIA LED 50 W

Potencia disponible 50W  
Available power: 50W

Material: Aluminio inyectado  
Material: Injected aluminium.

IP 64 IK 08

Altura de montaje: 3 - 5 m  
Assembled height: 3 - 5 m

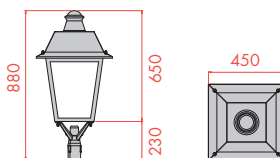

FHS INST = 0.1 %  
LED REBEL 50W

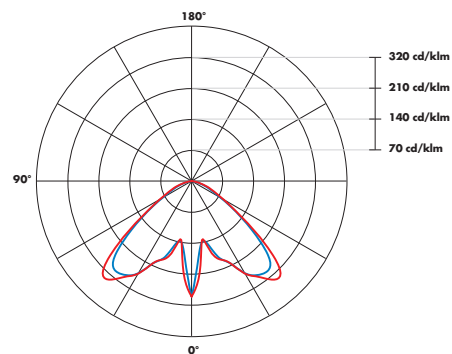

## BOHEMIA DESCARGA

CÓDIGO/ CODE DESCRIPCIÓN/ DESCRIPTION

80-3003-BP-37 150W VSAP/HM / 150W HPS/MH  
80-3006-BP-37 150W VSAP 2N / 150W HPS BIPOWER  
80-3009-BP-37 150W 2N TEMP VSAP / 150W HPS BIPOWER TIMED  
80-3028-BP-37 150W CII VSAP-HM / 150W HPS-MH C-II  
80-3175-BP-37 150W CII 2N VSAP / 150W HPS BIPOWER C-II  
80-3178-BP-37 150W CII 2N TEMP VSAP / 150 W HPS BIPOWER C-II TIMED

Potencia disponible 70W-150W  
Available power: 70W-150W

Material: Aluminio inyectado  
Material: Injected aluminium.

IP 66 IK 08

Altura de montaje: 3 - 6 m  
Assembled height: 3 - 6 m

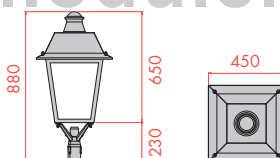

FHS INST = 1.0 %  
VSAP 150W

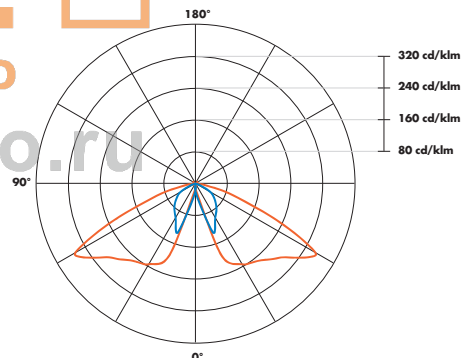

## ANDALUCIA LED

CÓDIGO/ CODE DESCRIPCIÓN/ DESCRIPTION

80-4520-BP-37 ANDALUCÍA LED 50 W

Potencia disponible 50W  
Available power: 50W

IP 44 IK 08

Altura de montaje: 3 - 5 m  
Assembled height: 3 - 5 m

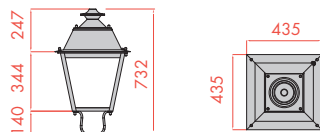

FHS INST = 0.1 %  
LED SEOUL 50W

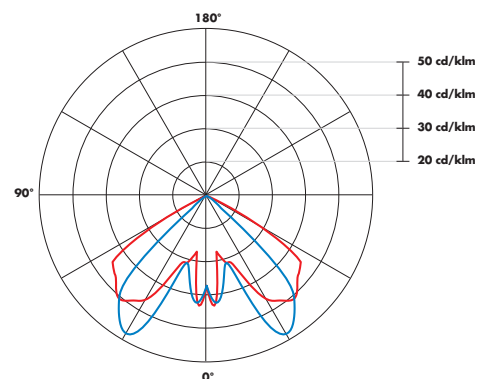

\* Consultar condiciones comerciales.  
\* Consult commercial conditions.  
\* Consulter les conditions commerciales.

\* Handelsbedingungen abfragen.  
\* Consultare le condizioni commerciali.  
\* Consultar condições comerciais.

Para ampliar información, consultar catálogo URBAN  
For more information, please consult URBAN catalogue.

## MERIDIAN LED

**CÓDIGO/ CODE**      **DESCRIPCIÓN/ DESCRIPTION**

80-4529-BP-37      150W VSAP/HM / 150W HPS/MH



Potencia disponible 50W  
Available power: 50W

**IP 64**      **IK 08**

Altura de montaje: 3 - 5 m  
Assembled height: 3 - 5 m

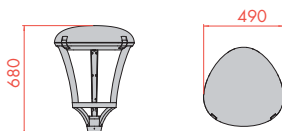

FHS INST = 0.1 %  
LED REBEL 50W

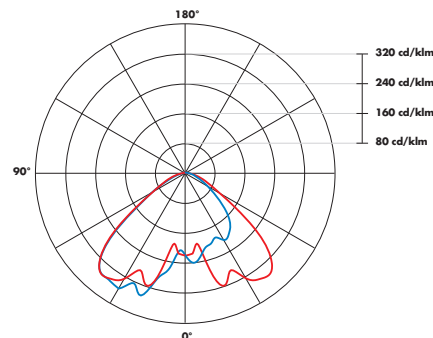

## MERIDIAN DESCARGA

**CÓDIGO/ CODE**      **DESCRIPCIÓN/ DESCRIPTION**

80-3014-BP-37      150W VSAP/HM / 150W HPS/MH  
80-3017-BP-37      150W VSAP 2N VSAP/ 150W HPS BIPOWER  
80-3020-BP-37      150W VSAP 2N TEMP VSAP / 150W HPS BIPOWER TIMED  
80-3027-BP-37      150W CII 2N VSAP / 150W HPS BIPOWER C-II  
80-3181-BP-37      150W CII 2N TEMP VSAP / 150 W HPS BIPOWER C-II TIMED



Potencia disponible 70-150W  
Available power: 70-150W

**IP 66**      **IK 08**

Altura de montaje: 3 - 5 m  
Assembled height: 3 - 5 m

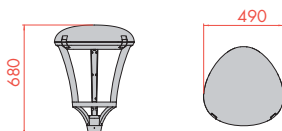

FHS INST = 0.1 %  
VSAP 150W

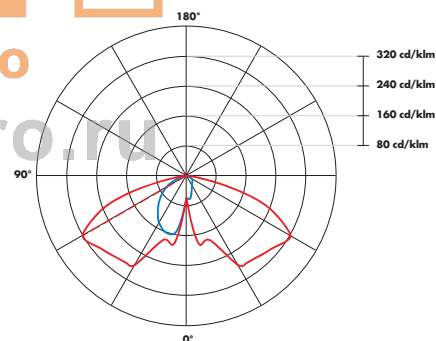

## CITIZEN DESCARGA

**CÓDIGO/ CODE**      **DESCRIPCIÓN/ DESCRIPTION**

83-3102-BB-M2      2x150W VSAP-HM / 2x150W HPS-MH  
83-3105-BB-M2      2x150W VSAP 2N / 2x150W HPS BIPOWER  
83-3119-BB-M2      2x150W 2N TEMP VSAP / 2x150W HPS BIPOWER TIMED  
83-3186-BB-M2      2x150W CII VSAP-HM / 2x150W HPS-MH C-II



Potencia disponible: 70-150W  
Available power: 70-150W

**IP 65**      **IK 10**

Altura de montaje: 4 m  
Assembled height: 4 m

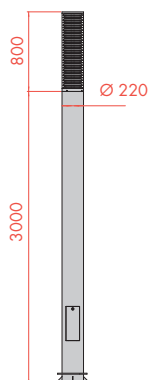

FHS INST = 103 %  
VSAP 2 X 150W

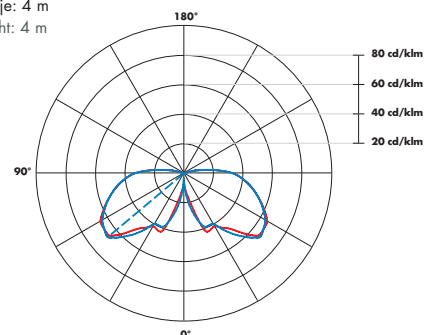

\* Consultar condiciones comerciales.  
\* Consult commercial conditions.  
\* Consulter les conditions commerciales.

\* Handelsbedingungen abfragen.  
\* Consultare le condizioni commerciali.  
\* Consultar condições comerciais.

Para ampliar información, consultar catálogo URBAN  
For more information, please consult URBAN catalogue.

**71-9400-34-34 ■**

Caja de conexiones  
Multipurpose connection box

IP 54  6

**71-9199-05-05 ■**

Caja de conexiones estanca. Para cables de  $\phi$ 6,5 a  $\phi$ 11 mm.  
Water proof connexion box. For wires from 6,5 to  $\phi$ 11 mm.

IP 68 1 m  6

**71-9262-05-05 ■**

Caja de conexiones estanca.  $\phi$ 8,5 máx.  
Water proof connexion box.  $\phi$ 8,5 max.

IP 67  50

**71-9311-05-05 ■**

Caja de conexiones estanca. Medidas: 30 x 19 x 12.  
Water proof connexion box. measures: 30 x 19 x 12.

IP 67  6

**71-9197-05-05 ■**

Transformador estanco para lámparas halógenas. 230/12V AC-100W.  
Water proof transformer for halogen bulbs. 230/12V AC-100W.

  IP 68 1 m  6

**71-9198-05-05 ■**

Fuente de alimentación estanco para LED 230/12V DC-20W.  
Water proof power supply for LED 230/12V DC-20W.

  IP 68 1 m  6

**71-9278-05-05 ■**

Fuente de alimentación estanco para POWER LED 230/3V DC-10W.  
Water proof power supply for POWER LED 230/3V DC-10W.

  IP 68 1 m  6

**71-9396-05-05 ■**

Conector IP 68 3 vías forma "T" 3 polos. Para cables de  $\phi$ 5 a  $\phi$ 13 mm.  
IP 68 connection 3 ways T shape x 3 wires. For wires from  $\phi$ 5 to  $\phi$ 13 mm.

**71-9397-05-05 ■**

Conector IP 68 2 vías 3 polos completo. Para cables de  $\phi$ 5 a  $\phi$ 13 mm.  
IP 68 connection 2 ways 3 wires complete. For wires from  $\phi$ 5 to  $\phi$ 13 mm.

**MODULO**

**www.modul-electro.ru**

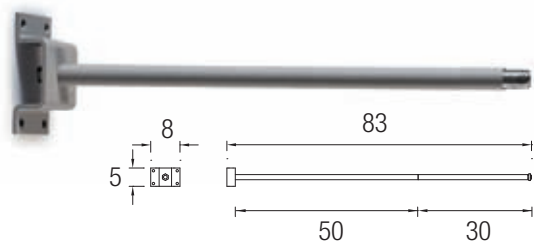

**71-9487-34-34 ■**

**71-9487-Z5-Z5 ■**



**71-9405-M3-M3 □**

Accesorio para aumento hasta IP65. Máx 15W  
Accessory to increase up to IP 65. Max 15W

**71-9406-M3-M3 □**

Accesorio para aumento hasta IP65. Máx 20W  
Accessory to increase up to IP 65. Max 20W



**71-9507-05-05 ■**

Caja para empotrar válida para las referencias: 55-9323 y 55-9187  
Flush fitting box valid for references: 055-9323 and 55-9187



**71-9489-05-05 ■**

Caja para empotrar válida para las referencias: 05-9460, 05-9461 y 05-9466

Flush fitting box valid for references: 05-9460, 05-9461 and 05-9466



**MODULO ELECTRO**  
www.modulelectro.ru



**71-9490-05-05 ■**

Caja para empotrar válida para las referencias: 05-9460, 05-9461 y 05-9466

Flush fitting box valid for references: 05-9460, 05-9461 and 05-9466



**71-9273-05-05 ■**

Caja para empotrar válida para las referencias: 05-8759, 05-8961, 05-9211 y 05-9212

Flush fitting box valid for references: 05-8759, 05-8961, 05-9211 and 05-9212



**71-8969-00-00 □**

Reactancia para PL G24d-1 13W.  
Ballast for PL G24d-1 13W.

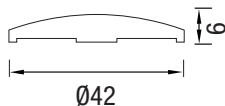

**71-9206-05-05 ■**

Contrapeso para farolas.  
Balancing weight for lampposts.



**DRIVERS**



**ACT-0803-00-00**

Driver 100-240V AC/350 mA-3W.

□ ▽ IP 20 CE



**ACT-0804-00-00**

Driver 100-240V AC/350 mA-4W.

□ ▽ IP 20 CE



**ACT-0808-00-00**

Driver 100-240V AC/350 mA-8W.

□ ▽ IP 20 CE



**ACT-0816-00-00**

Driver 100-240V AC/350 mA-18W.

□ ▽ IP 20 CE



**71-3477-00-00**

Driver 100-240V AC/350 mA-10W.

□ ▽ IP68 CE



**71-3307-00-00**

Driver 100-240V AC/700 mA-12W.

□ ▽ IP 20 CE



**71-3308-00-00**

Driver 220V AC/700 mA-18W.

□ ▽ IP 20 CE



**71-3478-00-00**

Driver 100-240V AC/700 mA-17W.

□ ▽ IP68 CE



**71-3475-00-00**

Driver 100-240V AC/350mA/700 mA

□ ▽ IP20 CE



**MODULO**

**FUENTES DE TENSION / POWER SUPPLY / SOURCE D'ALIMENTATION / NETZGERÄTE**

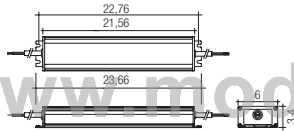

**71-3479-00-00**

Fuente de alimentación 110-264V AC/ 12V DC 100W  
Power supply 100-264V AC/ 12V DC 100W

□ ▽ IP 67 CE

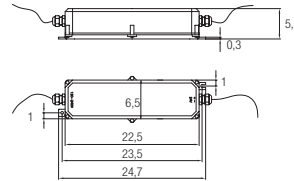

**71-3480-00-00**

Equipo 220-240V AC/ 24V DC 130W  
Gear 220-240V AC/ 24V DC 130W

□ ▽ IP 67 CE

**EQUIPOS DE CONTROL / DEVICE CONTROLLERS / CONTROLEUR D'EQUIPE / REGLER**

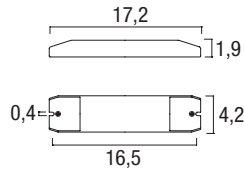

**71-3472-00-00 (1-10V)**

Equipo de control para 05-3438 y 05-3440 10-24 VDC / 10-24 VDC 50-120W  
Device controllers for 05-3438 and 05-3440 10-24 VDC / 10-24 VDC 50-120W

□ ▽ IP 20 CE

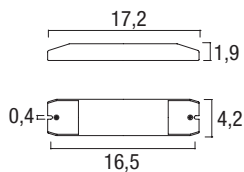

**71-3473-00-00 (DALI)**

Equipo de control 10-24 VDC / 10-24 VDC 50-120W  
Device controllers 10-24 VDC / 10-24 VDC 50-120W

□ ▽ IP 20 CE

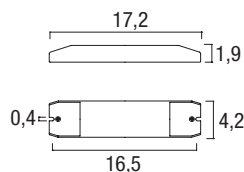

**71-3474-00-00 (DMX)**

Equipo de control 10-24 VDC / 10-24 VDC 21-48W x 3 canales  
Device controllers 10-24 VDC / 10-24 VDC 21-48W x 3 channels

□ ▽ IP 20 CE

FUENTES DE ALIMENTACIÓN / POWER SUPPLY / SOURCES D'ALIMENTATION / NETZGERÄTE

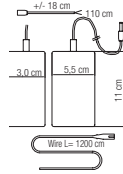

**71-3435-00-00**

Fuentes de alimentación 100-240V AC/ 12v DC 72W 6A 3 canales  
Power supply 100-240V AC/ 12v DC 72W 6A 3 channels

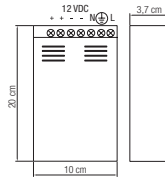

**71-3436-00-00**

Fuentes de alimentación 110-240V AC/ 12v DC 120W 10A 2 canales  
Power supply 110-240V AC/ 12v DC 120W 10A 2 channels

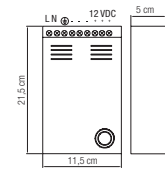

**71-3437-00-00**

Fuentes de alimentación 100-240V AC/ 12v DC 360W 30A 3 canales  
Power supply 100-240V AC/ 12v DC 360W 30A 3 channels



CONTROLADORES RGB SIN MANDO A DISTANCIA / RGB CONTROLLERS WITHOUT REMOTE CONTROL  
CONTRÔLEURS RVB SANS TÉLÉCOMMANDE / RGB-REGLER OHNE FERNBEDIENUNG

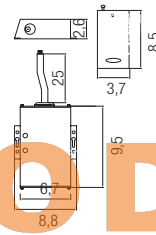

**71-3314-00-00**

12v dc / 12v DC 144W 12A 3 canales  
12v dc / 12v DC 144W 12A 3 channels

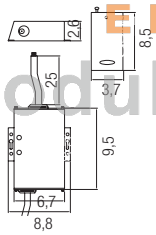

**71-3431-00-00**

12v dc / 12v DC 144W 12A 3 canales  
12v dc / 12v DC 144W 12A 3 channels

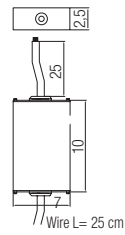

**71-3432-00-00**

12v dc / 12v DC 144W 12A 3 canales  
12v dc / 12v DC 144W 12A 3 channels



Combinaciones / Combinations / Combinaisons / Kombinationen

FUENTE DE ALIMENTACIÓN / POWER SUPPLY SOURCE D'ALIMENTATION / NETZGERÄT	CONTROLADOR / CONTROLLER CONTRÔLEURS / REGLER
71-3435-00-00	71-3314-00-00
71-3436-00-00	71-3431-00-00
71-3437-00-00	71-3431-00-00
71-3435-00-00	71-3432-00-00
71-3436-00-00	
71-3437-00-00	

AMPLIFICADOR / AMPLIFIER / AMPLIFICATEUR / VERSTÄRKER

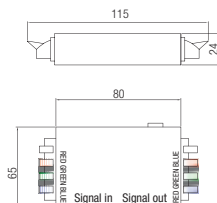





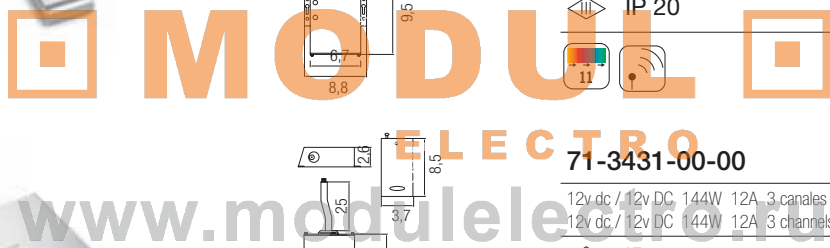











**71-3433-00-00**

12v dc / 12v DC 144W 12A 3 canales  
12v dc / 12v DC 144W 12A 3 channels





	CÓDIGO CODE	CASQUILLO SOCKET	W	K	V	LM	HAZ (°) ANGLE (°)	I (Cd)	VIDA (h) LIFE (h)	DIÁMETRO (mm) DIAMETER (mm)	LONGITUD (mm) LENGTH (mm)	EMBALAJE (mm) (alto x ancho x profundo) PACKAGING (mm) (height x width x depth)	
	ACT-FLF-019	G24d-3	26	6.500		1.800			8.000		149,0	192 x 81 x 186	10
	ACT-FLF-006	G24d-3	26	4.000		1.800			8.000		149,0	192 x 81 x 186	10
	ACT-FLF-005	G24d-3	26	3.000		1.800			8.000		149,0	192 x 81 x 186	10
	ACT-FLF-020	G24q-3	26	6.500		1.800			10.000		149,0	192 x 81 x 186	10
	ACT-FLF-012	G24q-3	26	4.000		1.800			10.000		149,0	192 x 81 x 186	10
	ACT-FLF-011	G24q-3	26	3.000		1.800			10.000		149,0	192 x 81 x 186	10
	ACT-FLF-021	2G11	18	3.000		1.200			8.000	17,5	217,0	260 x 103 x 136	10
	ACT-FLF-022	2G11	24	3.000		1.800			8.000	17,5	317,0	365 x 107 x 140	10
	ACT-FLF-023	2G11	40	3.000		3.500			8.000	17,5	533,0	581 x 107 x 140	10
	ACT-FLF-024	G5	39	4.000		3.100			16.000	16,0	849,0	90 x 110 x 887	20
	ACT-FLF-025	G5	54	4.000		4.450			16.000	16,0	1.149,0	83 x 104 x 1182	20
	ACT-FLF-026	G5	80	4.000		6.150			16.000	16,0	1.449,0	83 x 104 x 1482	20
	ACT-FLF-027	G5	39	3.000		3.100			16.000	16,0	849,0	90 x 110 x 887	20
	ACT-FLF-028	G5	54	3.000		4.450			16.000	16,0	1.149,0	83 x 104 x 1182	20
	ACT-FLF-029	G5	80	3.000		6.150			16.000	16,0	1.449,0	83 x 104 x 1482	20
	ACT-FLF-039	G5	24	3.000		1.750			16.000	16,0	549,0	95 x 198 x 598	40

Los pedidos de lámparas siempre deben respetar las unidades de embalaje reflejadas en esta página. Todas las bombillas son de 1ª marca (OSRAM o PHILIPS) y fabricadas en Europa.



















Light bulbs POs shall always be placed according to the packaging units reflected in the present page. All light bulbs are first quality (OSRAM or PHILIPS) and made in Europe.



















Les commandes d'ampoules doivent toujours respecter les unités d'emballage figurant sur cette page. Toutes les ampoules sont de grande marque (OSRAM ou PHILIPS) et fabriquées en Espagne.

Bei Bestellungen von Glühbirnen bitte die auf dieser Seite angegebenen Verpackungseinheiten beachten. Alle Glühbirnen sind in Europa hergestellte Markenartikel (OSRAM oder PHILIPS).

Gli ordini relativi alle lampadine devono tenere in conto le unità di imballaggio evidenziate in questa pagina. Tutte le lampadine sono di marca (OSRAM o PHILIPS) e fabbricate in Europa.

Os pedidos de lâmpadas devem respeitar sempre as unidades de embalagem reflectidas nesta página. Todas as lâmpadas são de 1ª marca (OSRAM ou PHILIPS) e fabricadas na Europa.

	CÓDIGO CODE	CASQUILLO SOCKET	W	K	V	LM	HAZ (°) ANGLE (°)	I (Cd)	VIDA (h) LIFE (h)	DIÁMETRO (mm) DIAMETER (mm)	LONGITUD (mm) LENGTH (mm)	EMBALAJE (mm) (alto x ancho x profundo) PACKAGING (mm) (height x width x depth)	
	ACT-FLF-058	E14	10	2.500	220-240	445			10.000	39,0	124,0	137 x 88 x 211	10
	ACT-FLF-041	E14	11	3.000	220-240	660			20.000	45,0	126,0	145 x 102 x 242	10
	ACT-FLF-042	E27	11	3.000	220-240	660			20.000	45,0	117,0	145 x 102 x 242	10
	ACT-FLF-043	E27	14	3.000	220-240	820			20.000	45,0	131,0	145 x 102 x 242	10
	ACT-FLF-044	E27	22	3.000	220-240	1.440			20.000	58,0	176,0	194 x 127 x 310	10
	ACT-FLF-045	E27	18	3.000	220-240	1.060			10.000	120,0	170,0	179 x 259 x 630	10
	ACT-FLF-046	E27	18	6.500	220-240	1.200			12.000	55,0	111,0	142 x 120 x 289	10
	ACT-FLF-047	E27	18	4.000	220-240	1.200			12.000	55,0	111,0	142 x 120 x 289	10
	ACT-FLF-048	E27	18	2.500	220-240	1.200			12.000	55,0	111,0	142 x 120 x 289	10
	ACT-FLF-049	E27	23	6.500	220-240	1.600			12.000	58,0	119,0	150 x 120 x 289	10
	ACT-FLF-050	E27	23	4.000	220-240	1.600			12.000	58,0	119,0	150 x 120 x 289	10
	ACT-FLF-051	E27	23	2.500	220-240	1.600			12.000	58,0	119,0	150 x 120 x 289	10
	ACT-FLF-052	E27	30	4.000	220-240	1.940			15.000	58,0	195,0	215 x 127 x 310	10
	ACT-FLF-053	E27	30	2.500	220-240	1.940			15.000	58,0	195,0	215 x 127 x 310	10
	ACT-FLF-054	E27	7	6.500	220-240	420			12.000	42,0	88,0	116 x 90 x 214	10
	ACT-FLF-055	E27	7	4.000	220-240	420			12.000	42,0	88,0	116 x 90 x 214	10
	ACT-FLF-056	E27	7	2.500	220-240	420			12.000	42,0	88,0	116 x 90 x 214	10

	CÓDIGO CODE	CASQUILLO SOCKET	W	K	V	LM	HAZ (°) ANGLE (°)	I (cd)	VIDA (h) LIFE (h)	DIÁMETRO (mm) DIAMETER (mm)	LONGITUD (mm) LENGTH (mm)	EMBALAJE (mm) (alto x ancho x profundo) PACKAGING (mm) (height x width x depth)	
<b>LÁMPARAS DE DESCARGA (HID) / DISCHARGE BULBS (HID)</b>													
	ACT-FLD-022	G12	35	4.200		6.500/ 3.600			12.000	19,0	100,0	158 x 140 x 180	12
	ACT-FLD-017	G12	35	3.000		6.500/ 3.600			12.000	19,0	100,0	158 x 140 x 180	12
	ACT-FLD-018	G12	70	4.200		6.800 / 7.300			12.000	19,0	100,0	158 x 140 x 180	12
	ACT-FLD-019	G12	70	3.000		6.800 / 7.300			12.000	19,0	100,0	158 x 140 x 180	12
	ACT-FLD-020	G12	150	4.200		14.500 / 15.000			12.000	25,0	105,0	158 x 140 x 180	12
	ACT-FLD-021	G12	150	3.000		14.500 / 15.000			12.000	25,0	105,0	158 x 140 x 180	12
<b>HALÓGENA / HALOGEN</b>													
	ACT-FLH-027	GU10	40	2.800	230		30	900	2.000	50,7	55,0	131 x 110 x 257	20
	ACT-FLH-028	GU4	20	3.000	12		38	700	4.000	35,3	40,0	58 x 81 x 178	10
	ACT-FLH-029	GU5,3	50	2.950	12		38	1.450		50,7	46,0	123 x 105 x 238	20
	ACT-FLH-030	G9	33	3.000	230	460			2.000	14,0	43,0	118 x 55 x 144	20
	ACT-FLH-031	G9	48	3.000	230	740			2.000	14,0	51,0	118x55x144	20
	ACT-FLH-032	R7S (118mm)	230	2.950	230	5.000			2.000	12,0	114,2	77 x 112 x 137	20
	ACT-FLH-033	R7s (78mm)	120	2.900	230	2.300			2.000	12,0	74,9	77 x 112 x 92	20
<b>INCANDESCENTE / INCANDESCENT</b>													
	ACT-FLI-001	E27 PAR-38	60	2.500	230	460	12	3.400	2.000	122,0	136,0	151 x 344 x 462	12
<b>LED RETROFIT (LED)</b>													
	ACT-FLL-001	E27	8	6.500	100-240	450 / 345			25.000	55,0	113,0	135 x 126 x 299	10
	ACT-FLL-002	E27	8	3.000	100-240	450 / 345			25.000	55,0	113,0	135 x 126 x 299	10
	ACT-FLL-003	GU10	4,5	6.500	100-240		35	600 / 450	35.000	50,0	60,0	77 x 114 x 271	10
	ACT-FLL-004	GU10	4,5	3.000	100-240		35	600 / 450	35.000	50,0	60,0	77 x 114 x 271	10

Los pedidos de lámparas siempre deben respetar las unidades de embalaje reflejadas en esta página. Todas las bombillas son de 1ª marca (OSRAM o PHILIPS) y fabricadas en Europa.

Light bulbs POs shall always be placed according to the packaging units reflected in the present page. All light bulbs are first quality (OSRAM or PHILIPS) and made in Europe.

Les commandes d'ampoules doivent toujours respecter les unités d'emballage figurant sur cette page. Toutes les ampoules sont de grande marque (OSRAM ou PHILIPS) et fabriquées en Espagne.

Bei Bestellungen von Glühbirnen bitte die auf dieser Seite angegebenen Verpackungseinheiten beachten. Alle Glühbirnen sind in Europa hergestellte Markenartikel (OSRAM oder PHILIPS).

Gli ordini relativi alle lampadine devono tenere in conto le unità di imballaggio evidenziate in questa pagina. Tutte le lampadine sono di marca (OSRAM o PHILIPS) e fabbricate in Europa.

Os pedidos de lâmpadas devem respeitar sempre as unidades de embalagem reflectidas nesta página. Todas as lâmpadas são de 1ª marca (OSRAM ou PHILIPS) e fabricadas na Europa.

## INFORMACIÓN CATÁLOGO

Las descripciones y medidas de los modelos del presente catálogo son orientativas, pudiendo por tanto ser modificadas, a fin de mejorar las características técnicas o de diseño.

Medidas en cm.

La empresa se reserva el derecho de anular o modificar cualquier modelo sin previo aviso.

Todos los modelos presentados cumplen las normas exigidas por la C.E. para aparatos de iluminación de uso doméstico y sus características vienen determinadas por las clases I y II.

Los acabados y las especificaciones técnicas corresponden a los productos que se suministran en Europa, pudiendo éstos variar en otros mercados.

Para una buena conservación de las luminarias, no usar lámparas de potencia superior a las recomendadas y limpiar simplemente con un paño seco. No usar limpiametales, ya que dañan los barnices protectores que garantizan la duración del acabado.

Se recomienda no mojar las luminarias con agua de riego que contenga un grado elevado de sales o ácidos.

Las potencias de las lámparas PL electrónicas E-27 indicadas corresponden a las marcas Osram, Philips o GE indistintamente, salvo que se especifique una marca en concreto.

## CATALOGUE INFORMATION

All descriptions and sizes included in this catalogue are orientative and can be modified due to technical or design reasons.

Any fixture can be withdrawn or modified without previous announcement.

All the fixtures shown in this catalogue follow the EC regulations for decorative lighting under classes I and II.

Measurements in cm.

Finishes and technical specifications are valid only for European market, and can be changed to suit other market requirements.

Do not use bulbs over maximum recommended wattage. Clean with a dry piece of soft fabric. To avoid varnish damage do not use abrasive materials.

It is recommended not to wet the luminaires with water with high salt or acid content.

The wattage indicated for PL electronic E-27 correspond to either Osram, Philips or GE brands, except where a brand is specifically stated.

## INFORMATION CATALOGUE

Toutes les descriptions et dimensions incluses dans ce catalogue sont données à titre indicatif, et peuvent être modifiées pour des raisons techniques ou esthétiques.

Dimensions en centimètres.

N'importe quel modèle peut être supprimé ou modifié sans préavis.

Tous les modèles de ce catalogue sont conformes à la norme C.E. pour les luminaires décoratifs de classe I et II.

Les finitions et spécifications techniques sont valables seulement pour le marché Européen, et peuvent être modifiées pour convenir aux exigences d'autres marchés.

Ne pas utiliser d'ampoule d'une puissance supérieure au maximum recommandé.

Nettoyer avec un chiffon doux et sec. Pour éviter d'abîmer le vernis, ne pas utiliser de produit abrasif.

Est recommandable ne pas mouiller les lumières avec de l'eau contenant un haut gré de sels ou acides.

Les puissances indiquées pour les lampes PL électroniques E27 correspondent indifféremment aux marques Osram, Philips, ou GE, sauf exception.

## KATALOG INFORMATIONEN

Die Beschreibungen und angegebenen Maße von den Modellen des vorliegenden Kataloges dienen lediglich zur Orientierung und können deshalb zur Verbesserung der technischen Charakteristiken oder des Designs modifiziert werden.

Maßangaben in cm.

Das Unternehmen behält sich das Recht vor jegliches Modell ohne vorherige Benachrichtigung zu annullieren oder zu modifizieren.

Alle Modelle erfüllen die von der EG vorgeschriebenen Regelungen von Beleuchtungsapparaten für den Haushaltsgebrauch und die notwendigen Charakteristiken werden von den Produktklassen I und II bestimmt.

Die Fertigverarbeitung und die technischen Spezifizierungen beziehen sich auf die in Europa vertriebenen Produkte; auf den Märkten von anderen Ländern können diese unterschiedlich sein.

Zur guten Erhaltung der Beleuchtungsanlagen sollten keine Lampen (Glühbirnen) verwendet werden, die die empfohlene Stärke übersteigen. Außerdem sollte man keine Metallreiniger benutzen, sondern sie nur mit einem trockenen Tuch säubern, da sonst der Schutzlack beschädigt werden könnte, der die Haltbarkeit der Endverarbeitung garantiert. Es wird empfohlen die Leuchten nicht mit Gießwasser, das einen hohen Grad an Salz oder Säuren enthalten könnte, zu bespritzen.

Die Stromstärke der elektrischen PL Glühbirnen E-27 ist unterschiedslos für die Produktmarken von Osram, Philips oder Ge angegeben, außer es wird ausdrücklich eine andere Marke verlangt.

## INFORMAZIONE CATALOGO

Tutte le descrizioni e le misure sono descritte in questo catalogo, ma possono essere modificate su richiesta specifica per un progetto.

Le misurazioni in centimetri.

Tutte le lampade sono a norma CE e quelle decorative in classe I-II.

Le descrizioni sono valide solo per il mercato europeo, ma possono essere variate per soddisfare altre richieste di mercato.

Non usare lampadine sopra la potenza (W) indicata.

Pulire con panno di tessuto morbido. Per evitare danni alla verniciatura non usare materiali abrasivi.

Si raccomanda non bagnare le lampade con dell'acqua con un alto grado di sali ed acidi. La potenza indicata per PL elettronico o E27, corrispondente a Osram Philips GE senza distinzione di marchio ad eccezione dove il marchio è specificatamente dichiarato.

## INFORMAÇÃO CATÁLOGO

As descrições e medidas dos modelos do presente catálogo são orientativas podendo, portanto, ser modificadas com o fim de melhorar as características técnicas ou de desenho. Medidas em cm.

LEDs reserva-se o direito de anular ou modificar qualquer modelo sem aviso prévio.

Todos os modelos apresentados cumprem as normas CE para aparelhos de iluminação de uso doméstico e as suas características de protecção estão definidas pelas Classes I ou II. Para uma boa conservação dos aparelhos, nunca usar lâmpadas de potência superior à recomendada nem usar produtos para limpeza de metais porque podem danificar os vernizes de protecção que garantem a duração do acabamento. Para limpeza usar apenas um pano seco.

Recomenda-se não molhar as luminárias com água de rega que contenha um elevado grau de sais ou ácidos.

As potências indicadas para as lâmpadas PL electrónicas correspondem às marcas Osram, Philips ou GE indistintamente, excepto se se especifica alguma marca em concreto.

Todos los derechos reservados. Ninguna parte de este libro puede ser reproducida en ningún formato de papel o electrónico, sin el consentimiento previo del editor o de los propietarios de los derechos.

All rights reserved. No part of this publication may be reproduced or transmitted in any form or by any means, electronic storage and retrieval system, without permission in writing from the copyright owner (s).

Tous droits réservés. Aucune partie de ce livre ne pourra être reproduite en format papier ou électronique sans l'autorisation préalable de l'éditeur ou du propriétaire des droits.

Sämtliche Rechte vorbehalten. Kein Teil dieses Buches darf in keinem Papier-oder elektronischem Format ohne ausdrückliche Zustimmung des Herausgebers oder der Inhaber der Urheberrechte wiedergegeben oder vervielfältigt werden.

Tutti i diritti riservati. Nessuna parte di questo libro può essere riprodotta in nessun formato cartaceo o elettronico, senza la previa autorizzazione dell' editore o dei proprietari dei diritti.

Todos os direitos reservados. Nenhuma parte deste livro pode ser reproduzida em qualquer formato de papel ou electrónico, sem o consentimento prévio do editor ou dos proprietários dos direitos.

05-8759  
05-8961  
05-9211  
05-9212

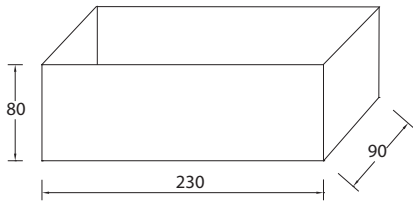

05-9128

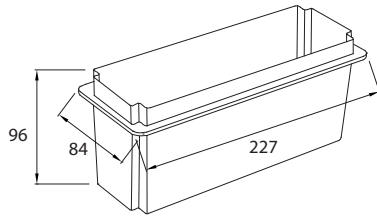

05-9159

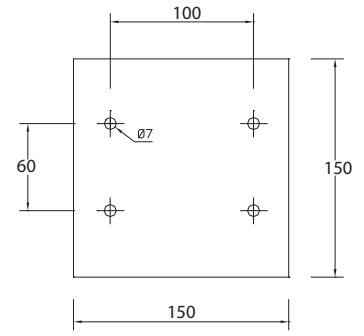

05-9167

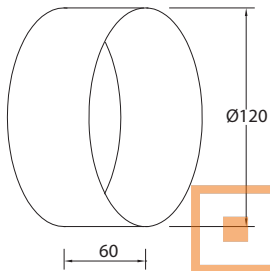

05-9169

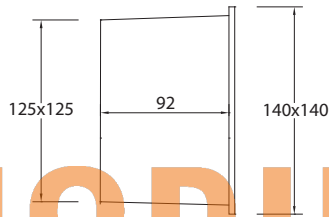

05-9179

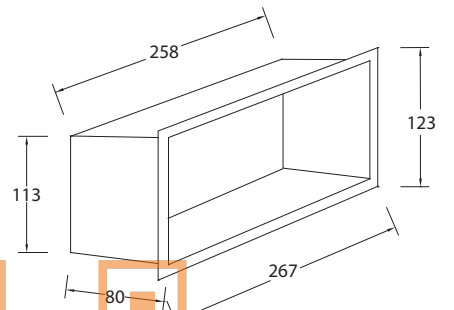

**MODULO**  
**ELECTRO**

[www.modulelectro.ru](http://www.modulelectro.ru)

05-9182

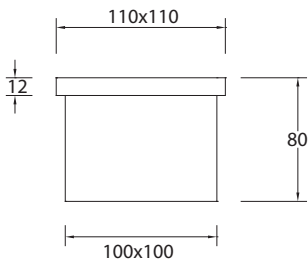

05-9240

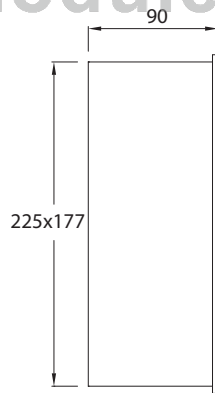

05-9344

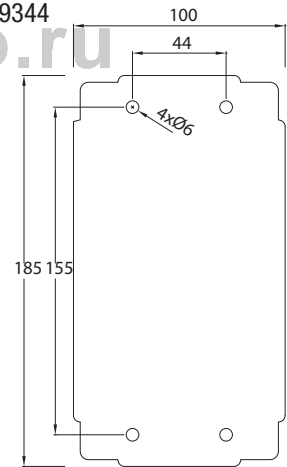

05-9345



05-9346  
05-9407

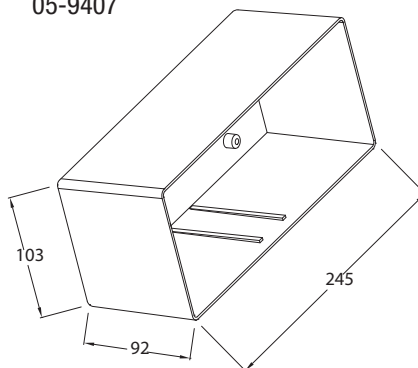

05-9347

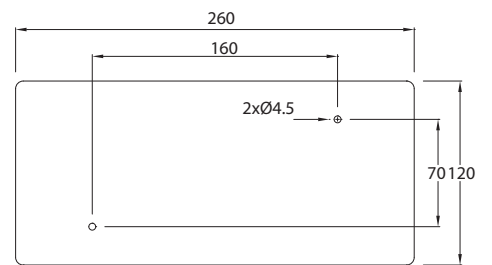

05-9369

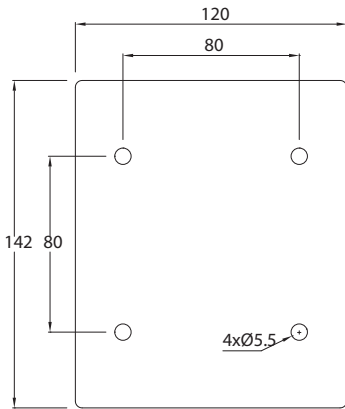

05-9388  
05-9434

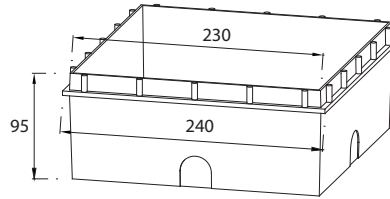

05-9393

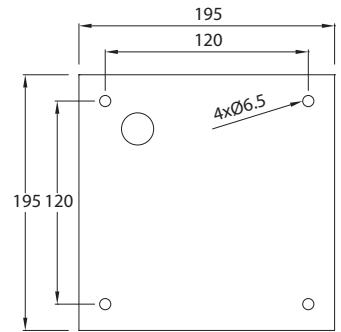

05-9460  
05-9461  
05-9466

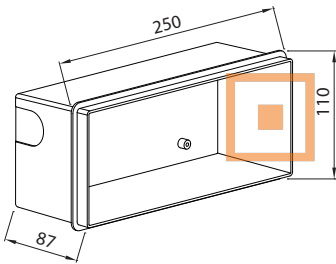

05-9464  
05-9567

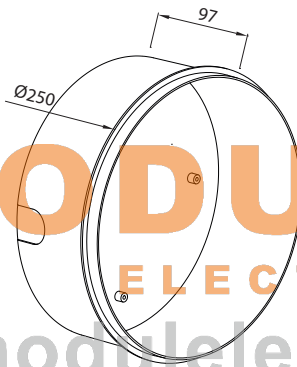

10-8790  
10-9333  
55-8790  
55-9333

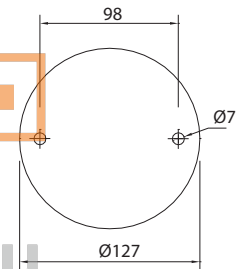

**MODULO ELECTRO**  
www.modulelectro.ru

10-9116

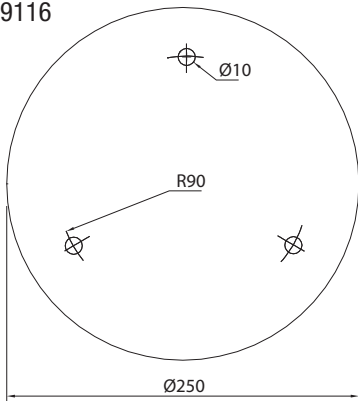

10-9176  
55-9176

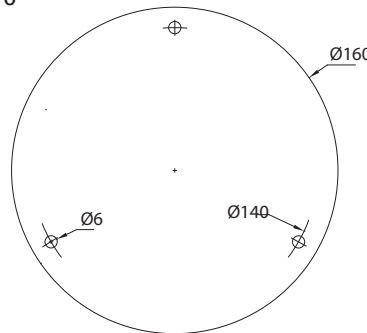

10-9183

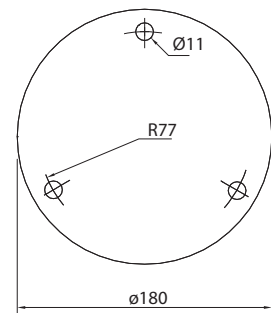

55-9237  
55-9272

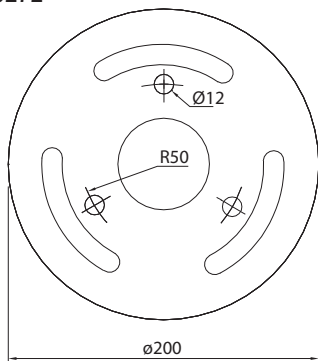

10-9295  
55-9295

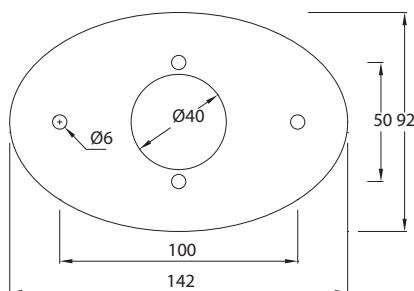

10-9298

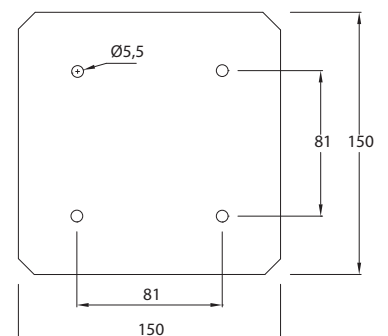

10-9299

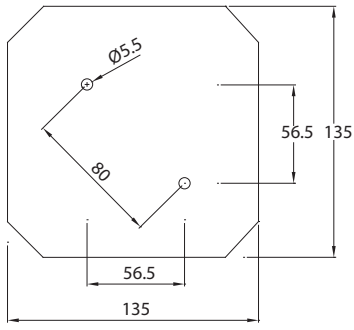

10-9329  
55-9329

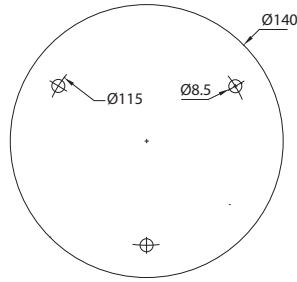

10-9390

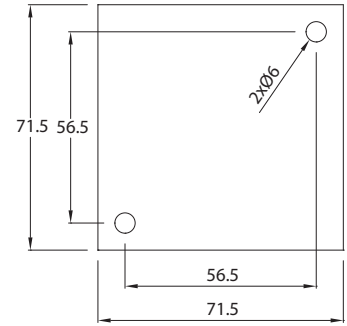

10-9475

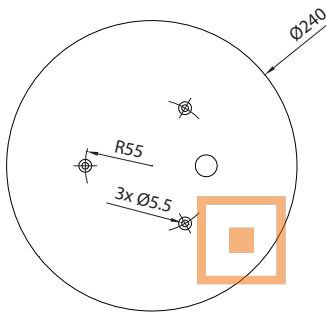

15-9363  
15-9364  
15-9365

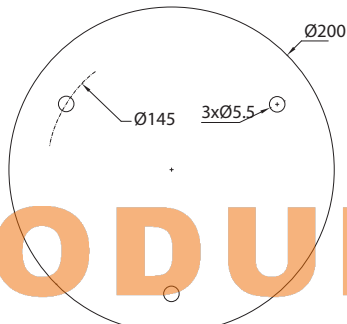

15-9381

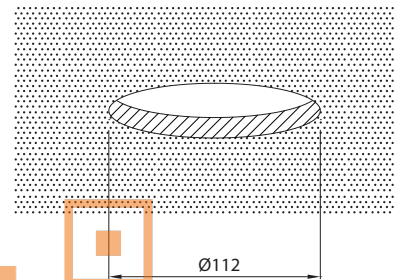

15-9391  
15-9392

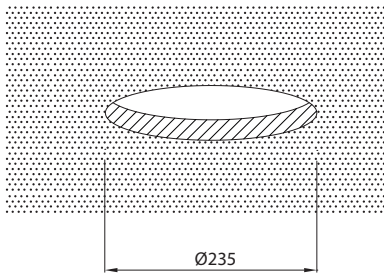

[www.modulelectro.ru](http://www.modulelectro.ru)

55-8766  
55-8793  
55-9203

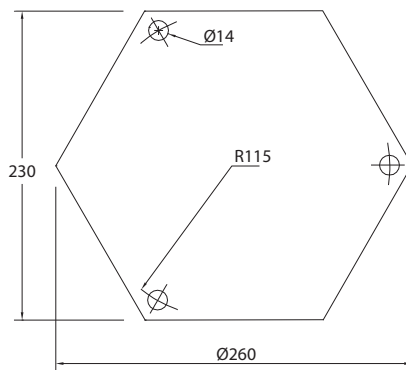

55-8956

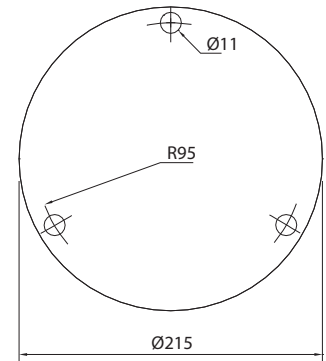

55-9125

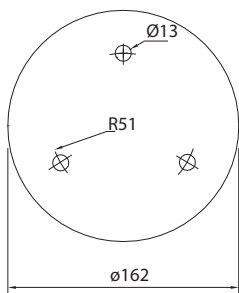

55-9151

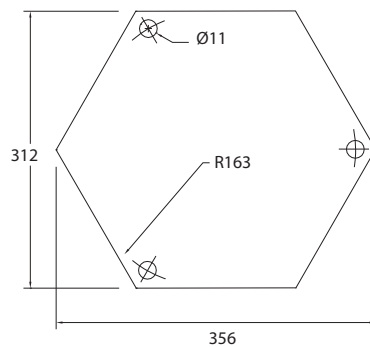

55-9184

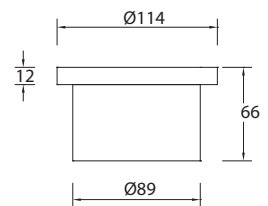

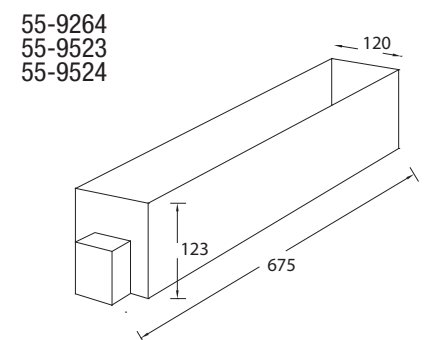
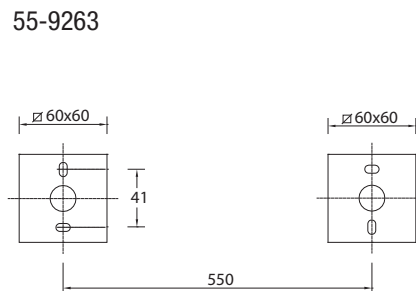
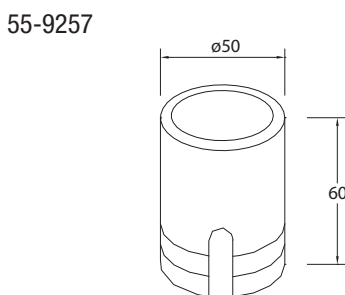
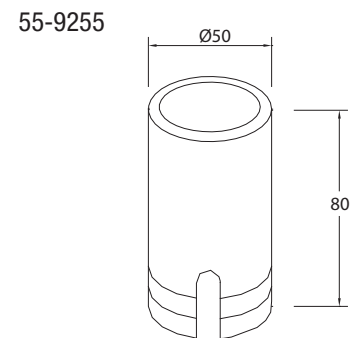
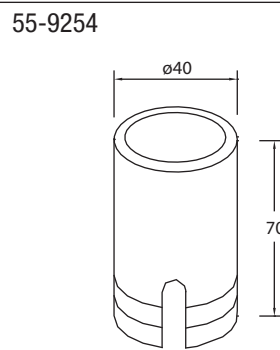
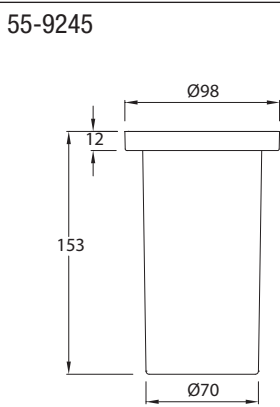
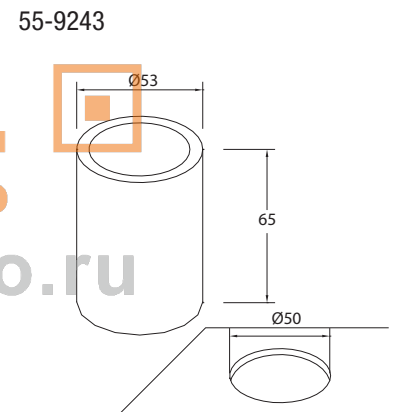
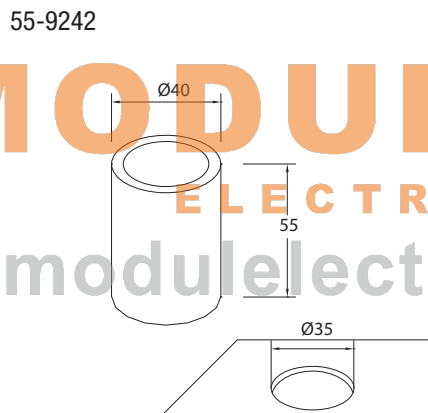
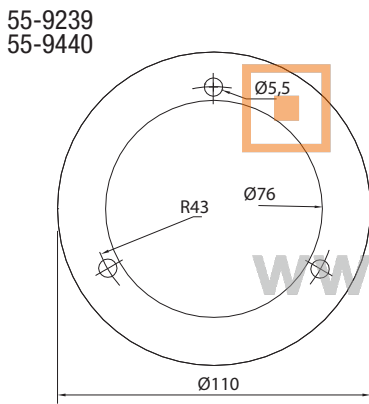
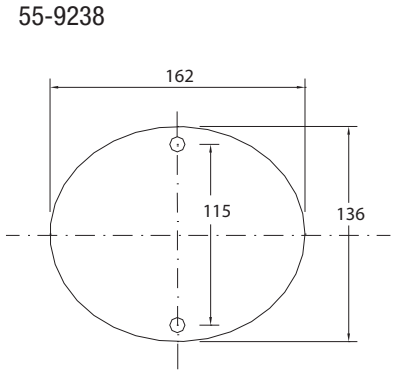
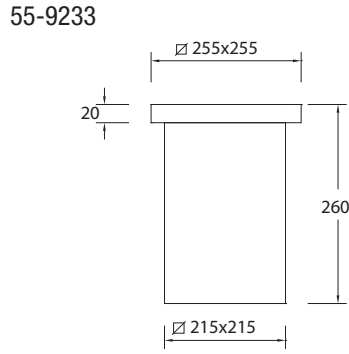
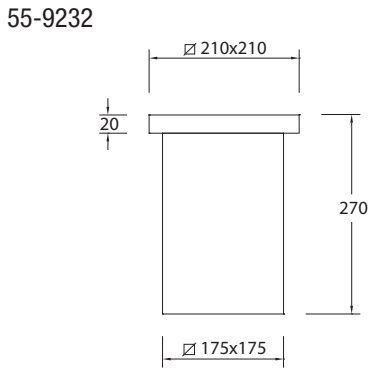
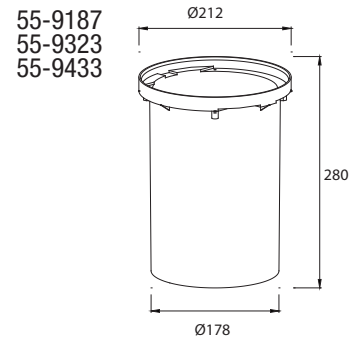
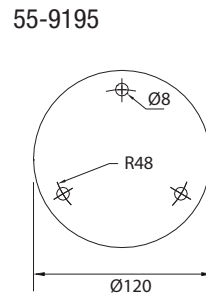
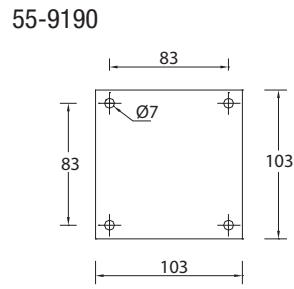
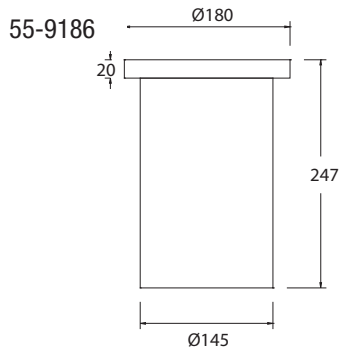



55-9265  
55-9525  
55-9526

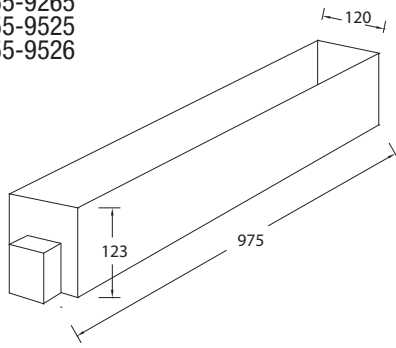

55-9266  
55-9527  
55-9528

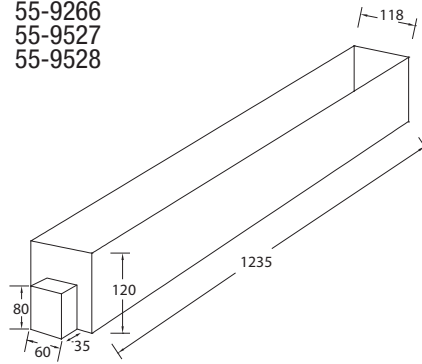

55-9429

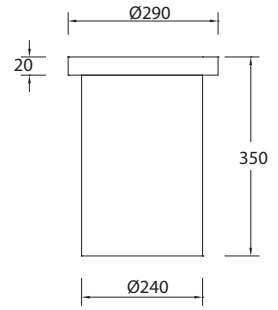

55-9268  
55-9269

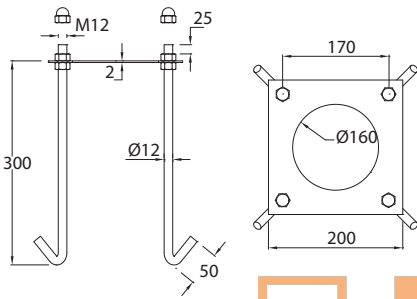

55-9280  
55-9281  
55-9282  
55-9283  
55-9380  
55-9382  
55-9394  
55-9423  
55-9424  
55-9437

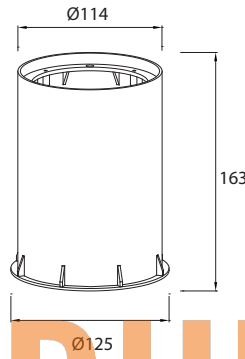

55-9284

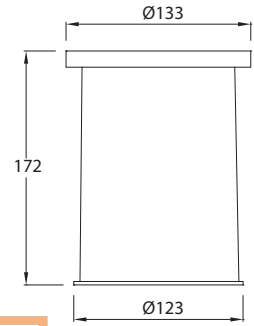

**MODULO**

55-9293  
55-9294

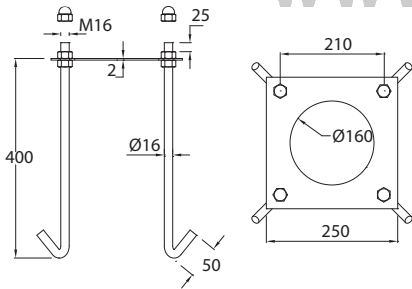

55-9298

**ELECTRO**

55-9305

[www.modulelectro.ru](http://www.modulelectro.ru)

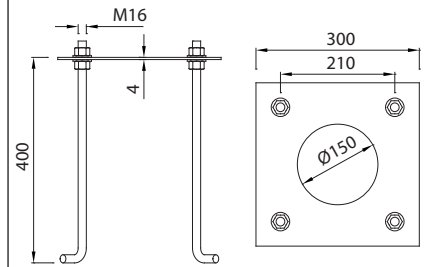
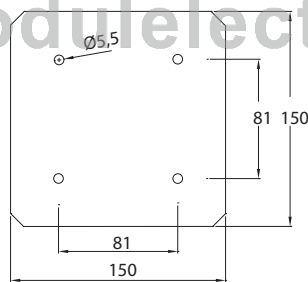

55-9318  
55-9319  
55-9320  
55-9334

55-9335  
55-9336  
55-9342  
55-9343

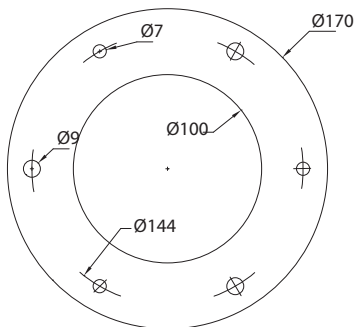

55-9337

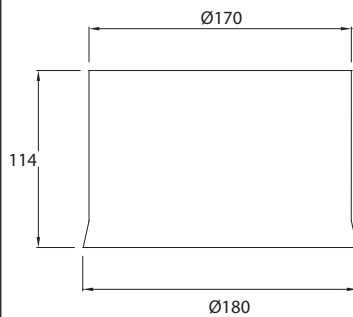

55-9350

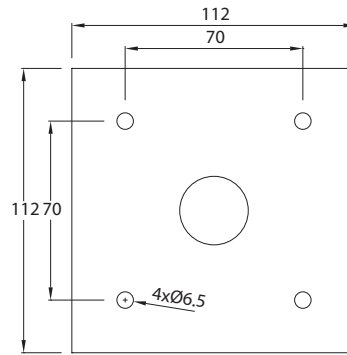

55-9354  
55-9355

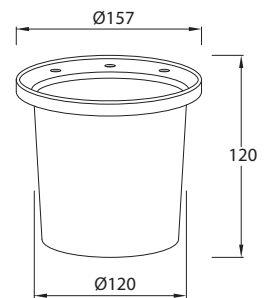

55-9357

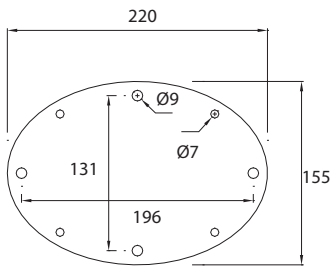

55-9358

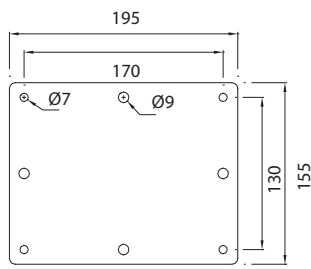

55-9374

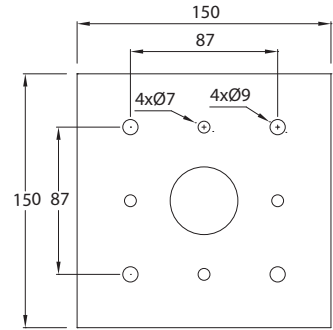

55-9377  
55-9378

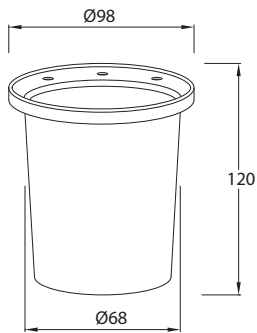

55-9384

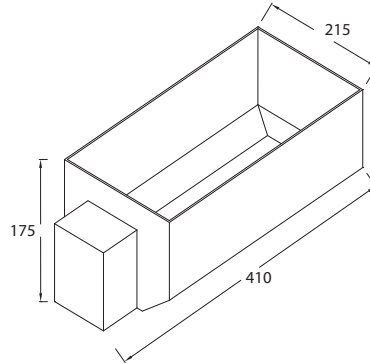

55-9390

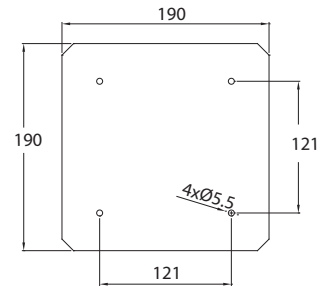

55-9421

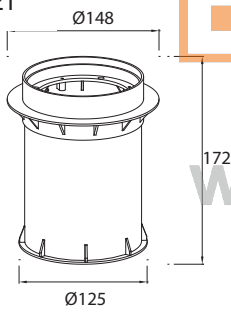

55-9425

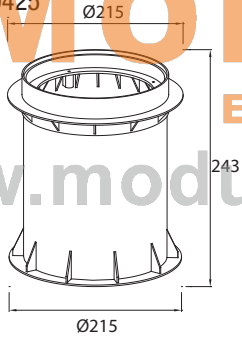

55-9427  
55-9428

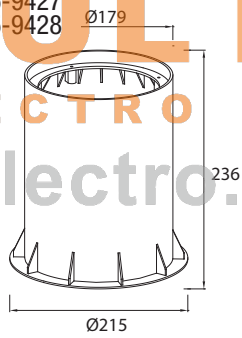

55-9430

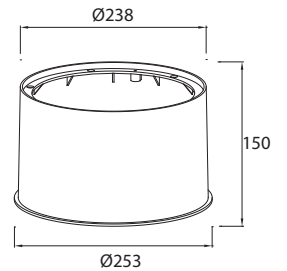

55-9431

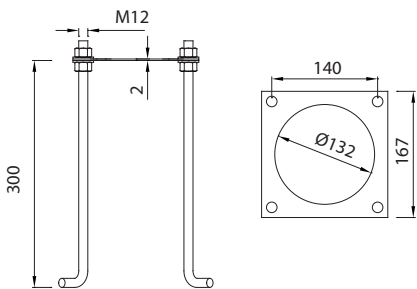

55-9435  
55-9443

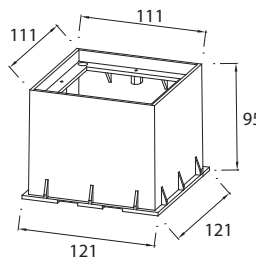

55-9459  
55-9529

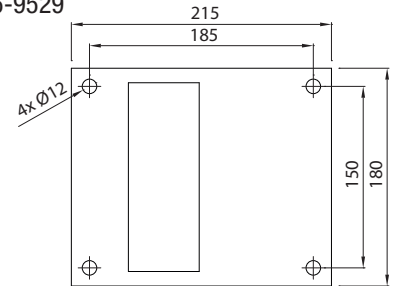

55-9479

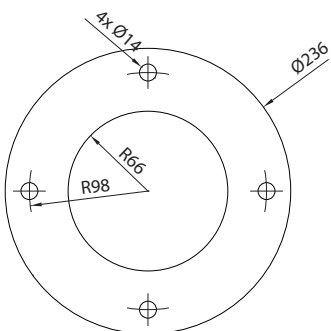

55-9486

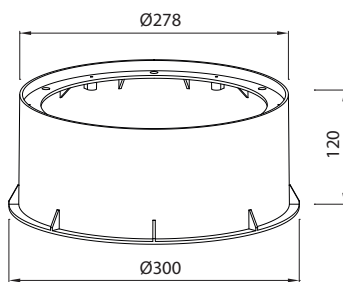

55-9504  
55-9505  
55-9506

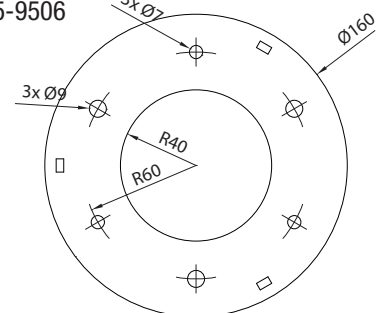



05 Negro  
Black  
Noir  
Schwarz  
Nero  
Preto



14 Blanco  
White  
Blanc  
Weiß  
Bianco  
Branco



18 Marrón óxido  
Rusted/oxide brown  
Rouille  
Rostbraun  
Marrone ossido  
Marrom óxido



92 Madera de Teca  
Teak wood  
Bois de teck  
Teakholz  
Legno di teak  
Madeira de teka



34 Gris  
Grey  
Gris  
Grau  
Grigio  
Cinzeno  
(RAL 9006 aprox/approx)



46 Acero inoxidable acabado teka  
Stainless steel teka finish  
Acier inoxydable finition aspect teck  
Rostfreier Stahl, Fertigverarbeitung in Teakholz  
Acciaio inossidabile con finitura teak  
Aço inoxidável com acabamento teka



54 Aluminio anodizado  
Anodized aluminium  
Aluminium anodisé  
Eloxiertes Aluminium  
Alluminio anodizzato  
Aluminio anodizado



K7 Gris piedra  
Stone grey  
Gris pierre  
Steingrau  
Grigio pietra  
Cinzeno pedra



M1 Blanco mate  
Matt white  
Blanc mate  
Weiß mat  
Bianco matt  
Branco satinado

# MODUL

## ELECTRO



M2 Plástico transparente  
Transparent plastic  
Plastique transparent  
Plastico trasparente  
Durchsichtiges Kunststoff  
Plástico transparente



B8 Satinado ácido 2 caras  
Acid satin 2 sides  
Satiné à l'acide des deux cotés  
Satinato ácido 2 facie  
Beidseitig satiniert  
Acetinado ácido 2 caras



Y4 Acero inoxidable AISI 304  
Stainless steel AISI 304  
Acier inoxydable AISI 304  
Rostfreier Stahl AISI 304  
Acciaio inossidabile AISI 304  
Aço inoxidável AISI 304



Y4 Acero inoxidable AISI 316  
Stainless steel AISI 316  
Acier inoxydable AISI 316  
Rostfreier Stahl AISI 316  
Acciaio inossidabile AISI 316  
Aço inoxidável AISI 316



Z5 Gris urbano  
Urban grey  
Gris urbain  
Anthrazit  
Grigio urbano  
Cinzeno urbano  
(RAL 7010 aprox/approx)



48 Acero galvanizado  
Galvanised steel  
Acier galvanisé  
Galvanisiertes Stahl  
Acciaio galvanizzato  
Aço galvanizado



J6 Marrón  
Brown  
Marron  
Braun  
Marrone  
Castanho



AW Terracota  
Clay backed  
Terre cuite  
Terracotta  
Terracotta  
Terracota







M3 Plástico transparente mate  
Matt transparent polycarbonate  
Polycarbonate transparent mat  
Transparenter matter polycarbonat  
Polycarbonate transparente matt  
Policarbonato transparente mate









<b>ABS</b>	Plástico ABS ABS plastic Plastique ABS Spritzkunststoff ABS Plastic ABS Plástico ABS	<b>CRIS BISEL</b>	Cristal biselado Beveled glass Verre biseauté Geschliffener Glas Cristallo molato Vidro com moldura facetada	<b>INOX AISI 304</b>	Acero inoxidable AISI 304 Stainless steel AISI 304 Acier inoxydable AISI 304 Rostfreier Stahl AISI 304 Acciaio inossidabile AISI 304 Aço inoxidável AISI 304	<b>PLAS TEC PE</b>	Plástico técnico PE Technopolymer PE Plastique technique PE Technischer Kunststoff PE Plastico tecnico PE Plástico técnico PE
<b>AC EPOXI</b>	Acero acabado epoxy Epoxy finish steel Acier finition exposi Stahl, Fertigverarbeitung mit Epoxy-Lackierung Acciaio Alluminio pressofuso Aço com acabamento epoxy	<b>CRIS BIS/SAT</b>	Cristal biselado y satinado Beveled and satin glass Verre biseauté et satiné Geschliffener und santinierter Glas Cristallo molato satinado Vidro satinado com moldura facetada	<b>INOX AISI 202</b>	Acero inoxidable AISI 202 Stainless steel AISI 202 Acier inoxydable AISI 202 Rostfreier Stahl AISI 202 Acciaio inossidabile AISI 202 Aço inoxidável AISI 202	<b>PMMA</b>	PMMA mate Matt PMMA PMMA mat Matter PMMA. PMMA matt PMMA mate
<b>ACRI</b>	Acrílico Acrylic Acrylique Acryl Acrilico Acrílico	<b>CRIS BURB</b>	Cristal burbuja Bubbled glass Verre à bulles Bläschen im Glas Cristallo bolicoso Vidro com bolhas	<b>INOX AISI 316</b>	Acero inoxidable AISI 316 Stainless steel AISI 316 Acier inoxydable AISI 316 Rostfreier Stahl AISI 316 Acciaio inossidabile AISI 316 Aço inoxidável AISI 316	<b>PMMA OPAL</b>	Difusor PMMA opal mate Satin opal PMMA diffuser Diffuseur PMMA opale satiné Opal matter PMMA Diffusor Diffusore PMMA Opale Matt Difusor PMMA opalino satinado
<b>AC FUND</b>	Acero fundido Cast steel Acier coulé Gussstahl Acciaio fuso Aço fundido	<b>CRIS MAT</b>	Cristal mate Matt glass Verre mat Matter Glas Vicchiere matt Vidrio mate	<b>PC</b>	Polycarbonato Polycarbonate Polycarbonate Polykarbonat Polycarbonate Polycarbonate Policarbonato	<b>PMMA PRISM</b>	PMMA prismatizado Prismatic PMMA PMMA prismatique Prismatisierter PMMA PMMA prismatico PMMA prismático
<b>ALU</b>	Aluminio Aluminum Aluminium Aluminium Alluminio Aluminio	<b>CRIS OPAL</b>	Cristal opal Opal glass Verre opal Optishes Glas Vetro ottico Vidro opalino	<b>PC MAT</b>	Polycarbonato mate Matt polycarbonate Polycarbonate mat Matter Polykarbonat Polycarbonato matt Policarbonato mate	<b>PMMA TRAN</b>	PMMA transparente Transparent PMMA PMMA transparent Transparenter PMMA PMMA transparente PMMA transparente
<b>ALU ANOD</b>	Aluminio anodizado Anodized aluminium Aluminium anodisé Eloxiertes Aluminium Alluminio anodizzato. Aluminio anodizado.	<b>CRIS PRISM</b>	Cristal prismatizado Prismatic glass Verre prismatique Prismatisierter mit Bläschen im Glas Cristallo prismatico Vidro prismático.	<b>PC OPAL</b>	Polycarbonato opal Opal polycarbonate Polycarbonate opale Opaler Polykarbonat Polycarbonato Opale Polycarbonato opalino	<b>RES</b>	Resina Resin Résine Harz Resina Resina sintética
<b>ALU EXTR</b>	Aluminio extrusionado Extruded aluminium Extrudé d'aluminium Extrudiertes Aluminium Estruso di alluminio Alumínio extrudido	<b>CRIS RUST</b>	Cristal rústico Rustic glass Verre rustique Cristallo rustico Rustikaler mit Bläschen im Glas Vidro rústico	<b>PC PRISM</b>	Polycarbonato prismatizado Prismatic polycarbonate Polycarbonate prismatique Prismatisierter Polykarbonat Polycarbonato prismatico Policarbonato prismático	<b>TEC POLI</b>	Tecnopolímero Technopolymer Technopolymère Technopolymer Tecnopolímero Tecnopolímero
<b>ALU INY</b>	Aluminio inyectado Injected aluminium Aluminium injecté Spritzaluminium Alumínio injectado Alluminio pressofuso	<b>CRIS STN</b>	Difusor de cristal satinado Satin glass diffuser. Diffuseur en verre satiné Satinierter Glasdiffusor Diffusore di cristallo satinato Difusor de vidro satinado	<b>PC STN</b>	Polycarbonato satinado Satin polycarbonate. Polycarbonate satiné Satinierter Polykarbonat Polycarbonate raso Policarbonato satinado	<b>TERMO PLAST</b>	Termoplástico Thermoplastic Thermoplastique Thermoplastik Thermoplastic Thermoplástico
<b>ALU PUR</b>	Aluminio de alta pureza High purity aluminum Aluminium haute pureté Aluminium mit hohem Reinheitsgrad Alluminio di alta purezza Alumínio de elevada pureza	<b>CRIS TEMP</b>	Cristal templado Hardened glass Verre trempé Gehärtetes durchsichtiges Glas Bicchiere indurito Vidro endurecido	<b>PC TRAN</b>	Polycarbonato transparente Transparent polycarbonate Polycarbonate transparent Transparenter Polykarbonat Polycarbonate trasparente Policarbonato transparente	<b>TK</b>	Madera de teca Teak wood Bois en teck Teakholz. Legno di teak Madeira de teka
<b>CRIS</b>	Cristal Glass Verre Glas Vicchiere Vidrio	<b>CRIS TRAN</b>	Cristal transparente. Transparent glass. Verre transparent. Transparenter Glas. Vicchiere transparente. Vidro transparente.	<b>PLAS INY</b>	Plástico inyectado Injected plastic Plastique injecté Spritzkunststoff Plastic iniettato Plástico injectad		
<b>CRIS LUPA</b>	Cristal lupa. Magnifying glass. Verre de loupe Lupenglas Cristallo con lente essetto diffondenti Vidro tipo lupa						



SIMBOLOGÍA / SIMBOLS

 Uds. de embalaje Items per box	 Clase I Class I	 Clase II Class II	 Clase III Class III	 Dirección del halo de luz. Halo light direction.
Unité d'emballage	Classe I	Classe II	Classe III	Direction du faisceau lumineux.
Verpackungseinheiten	Klasse I	Klasse II	Klasse III	Lichtstrom in Richtung
Unità d'imballaggio	Classe I	Classe II	Classe III	Direzione dall'halo.
Uds. de embalagem	Classe I	Classe II	Classe III	Direção do feixe de luz.

Se aplicará un 3% de descuento a todos los pedidos que respeten las unidades de embalaje.

 Aplique colgado Pendant wall fixture Applique suspendue Pendel Wandleuchte Applique sospeso Arandela pendurada	 Plafón Ceiling fixture Plafonnier Deckenleuchte Plafonier Luminária de tecto	 Sobremuro Lantern Lanterne Mauerleuchte Lampada di muro Sobremuro	 Farola Lamp-post Lampadaire Laternenpfahl Fanale Luminária
 Aplique adosado Wall mounted Applique murale Einbauwandleuchte Applique a schiera Arandela encastada	 Colgante Pendant Suspension Pendelleuchte Lampada a sospensione Luminária para suspensão	 Baliza Beacon Balise Stehleuchte Paletti Luminária para balizagem	 Empotrable Embedded À encastrer Einbauleuchten Encastrable Encastravel

**CE** Fabricado según las normas de seguridad y electromagnetismo de Europa.  
Manufactured according to the set safety and electromagnetism standards of Europe.  
Fabriqué selon les normes de sécurité électromagnétiques européennes.  
Hergestellt, gemäß den europäischen Sicherheitsnormen und Vorschriften für Elektromagnetismus.  
Fabricato secondo le norme di sicurezza elettromagnetiche europee.  
Fabricado de acordo com as normas europeias de segurança e electromagnetismo.

 Distancia mínima entre el foco de la luminaria y el objeto iluminado.  
Minimum distance to be left between the focus of the lighting fixture and the lightened object.  
La distance minimum pour être gauche entre le foyer de l'accessoire d'éclairage et l'objet allumé.  
Mindestabstand zwischen dem Scheinwerfer der Leuchte und dem beleuchteten Gegenstand.  
Distanza minima tras il fuoco della lampada e l'oggetto illuminato.  
Distância mínima entre o foco da luminaria e o objeto iluminado.

**F** Instalable sobre una superficie normalmente inflamable.  
Suitable for installation on normally inflammable surfaces.  
Convient aux installations sur des surfaces normalement inflammables.  
Kann auf brennbare Oberflächen installiert werden.  
Installabile su superfici normalmente infiammabili.  
Pode ser instalado sobre uma superfície normalmente inflamável.

**X** No instalable sobre una superficie normalmente inflamable.  
Unsuitable for installation on normally inflammable surfaces.  
Ne pas installer sur des surfaces normalement inflammables.  
Darf nicht auf brennbaren Oberflächen installiert werden.  
Non installabile su superfici normalmente infiammabili.  
Não pode ser instalado sobre uma superfície normalmente inflamável.

**MOD**  
**ELECTRO**

[www.modulelectro.ru](http://www.modulelectro.ru)

 Rotación en el plano vertical de ± 90°  
Adjustable ± 90° on the vertical axis  
Inclinaison sur le plan vertical de +/- 90°  
Einstellbar +/- 90° in der Vertikalachse  
Regolazione di +/- 90° nel piano verticale  
Rotação no plano vertical +/- 90°

 Rotación en el plano horizontal de ± 90°  
Adjustable +/- 90° on the horizontal axis  
Inclinaison sur le plan horizontal de +/- 90°  
Einstellbar +/- 90° in der Horizontalachse  
Regolazione di +/- 90° nel piano orizzontale  
Rotação no plano horizontal +/- 90°

 Rotación en el plano vertical de ± 45°  
Adjustable ± 45° on the vertical axis  
Inclinaison sur le plan vertical de +/- 45°  
Einstellbar +/- 45° in der Vertikalachse  
Regolazione di +/- 45° nel piano verticale  
Rotação no plano vertical +/- 45°

 Rotación en el plano horizontal de +45/-90°  
Adjustable +45/-90° on the horizontal axis  
Inclinaison sur le plan horizontal de +45/-90°  
Einstellbar +45/-90° in der Horizontalachse  
Regolazione +45/-90° nel piano orizzontale  
Rotação no plano horizontal +45/-90°

 Rotación en el plano vertical de ± 15°  
Adjustable ± 15° on the vertical axis  
Inclinaison sur le plan vertical de +/- 15°  
Einstellbar +/- 15° in der Vertikalachse  
Regolazione di +/- 15° nel piano verticale  
Rotação no plano vertical +/- 15°

 Rotación en el plano horizontal de +180/-15°  
Adjustable +180/-15° on the horizontal axis  
Inclinaison sur le plan horizontal de +180/-15°  
Einstellbar +180/-15° in der Horizontalachse  
Regolazione di +180/-15° nel piano orizzontale  
Rotação no plano horizontal +180/-15°

 Rotación en el plano horizontal de ± 45°  
Adjustable +/- 45° on the horizontal axis  
Inclinaison sur le plan horizontal de +/- 45°  
Einstellbar +/- 45° in der Horizontalachse  
Regolazione +/- 45° nel piano orizzontale  
Rotação no plano horizontal +/- 45°

 Rotación de 360° alrededor del plano vertical  
Adjustable from 0° to 360° on the vertical axis  
Inclinaison de 0 à 360° sur le plan vertical  
Einstellbar 0° bis 360° in der Vertikalachse  
Rotazione a 360° attorno all'asse verticale  
Rotação de 360° ao redor do plano vertical

 Rotación en el plano horizontal de ± 20°  
Adjustable +/- 20° on the horizontal axis  
Inclinaison sur le plan horizontal de +/- 20°  
Einstellbar +/- 20° in der Horizontalachse  
Regolazione di +/- 20° nel piano orizzontale  
Rotação no plano horizontal +/- 20°

 Rotación de 350° alrededor del plano vertical  
Adjustable from 0° to 350° on the vertical axis  
Inclinaison de 0 à 350° sur le plan vertical  
Einstellbar 0° bis 350° in der Vertikalachse  
Rotazione di 350° attorno all'asse verticale  
Rotação de 350° ao redor do plano vertical

 Rotación en el plano horizontal de ± 120°  
Adjustable +/- 120° on the horizontal axis  
Inclinaison sur le plan horizontal de +/- 120°  
Regolazione di +/- 120° nel piano orizzontale  
Einstellbar +/- 120° in der Horizontalachse  
Rotação no plano horizontal +/- 120°

 Rotación de 355° alrededor del plano vertical  
Adjustable from 0° to 355° on the vertical axis  
Inclinaison de 0 à 355° sur le plan vertical  
Einstellbar 0° bis 355° in der Vertikalachse  
Rotazione di 355° attorno all'asse verticale  
Rotação de 355° ao redor do plano vertical

## SIMBOLOGÍA / SIMBOLS

	<p>Ajustable de 0° a 40° en relación al plano horizontal Adjustable from 0° to 40° on the horizontal axis Inclinaison de 0 à 40° par rapport au plan horizontal Einstellbar 0° bis 40° in der Horizontalachse Regolabile in inclinazione da 0° a 40° rispetto al piano orizzontale Ajustável de 0° a 40° em relação ao plano horizontal</p>		<p>Estaca de plástico incluida Plastic spike included Piquet en plastique inclus Kunststoff Pfahl inklusive Palo in plastica incluso Vara de plástico incluida</p>	(s) Consultar disponibilidad Consult availability Consulter disponibilités Verfügbarkeit abfragen Consultare disponibilità Consultar disponibilidade	
	<p>Ajustable de 0° a 90° en relación al plano horizontal Adjustable from 0° to 90° on the horizontal axis Inclinaison de 0 à 90° par rapport au plan horizontal Einstellbar 0° bis 90° in der Horizontalachse Regolabile in inclinazione da 0° a 90° rispetto al piano orizzontale Ajustável de 0° a 90° em relação ao plano horizontal</p>		<p>Drenaje Drainage Drainage Drainage Drenaggio Drenagem</p>		<p>Reflector direccional Spotlight Réflecteur directionnel Eibaustrahler Riflettore direzionale Reflector direccional</p>
	<p>Posibilidad de suministrar con un IP más alto (Complementando con accesorios 71-9405 ó 71-9406) Higher IP option available (To complement with accessories 71-9405 ó 71-9406) IP supérieur disponible sur demande Par ajout d'accessoire 71-9405 ó 71-9406) Höheres IP möglich nach Anfrage (Andere Zubehör 71-9405 ó 71-9406) Possibilità di fornitura con IP più alto (Ed anche con degli accessori 71-9405 ó 71-9406) Possibilidade de fornecer com um IP maior (Complementando com acessórios 71-9405 ó 71-9406)</p>		<p>Transformador electrónico integrado Electronic recessed transformer Transformateur électronique inclus Elektronisches Vorschalgerät inklusive Trasformatore elettronico incluso Transformador eletrônico incluso</p>		<p>Plug-in disponible en Dialux Plug-in available in Dialux Plug-in disponible en Dialux Plug-in verfügbar in Dialux Plug-in disponibile en Dialux Plug-in disponível para Dialux</p>
	<p>Caja para empotrar de tecnopolímero incluida Recessed technopolymer box included Boite à encastrer en technopolymère incluse technopolimer Einbaukiste inklusive Involucro per l'incasso in tecnopolimero incluso Caixa para embutir de tecnopolímero incluida</p>		<p>Transformador magnético integrado Magnetic recessed transformer Transformateur magnétique inclus Magnetisches Vorschalgerät inklusive Trasformatore magnetico incluso Transformador magnético incluso</p>		<p>Nº de metros máx. de conexión en serie Max. no. of metres in serial connection Longueur max. (en mètres) de raccordement en série Mètres de connexion continue Nº massimo di metri di connessione in serie Nº de metros máximo de ligação em série</p>
	<p>Guía de instalación Installation guide Guide d'installation Einbauanleitung Guida di installazione Guia de instalação</p>		<p>Transformador magnético BAG integrado BAG magnetic recessed transformer Transformateur magnétique BAG inclus BAG Magnetisches Vorschalgerät inklusive Trasformatore magnetico BAG incluso Transformador magnético BAG incluso</p>		<p>Posibilidad de cortar cada x leds Option to cut every x leds. Mètres de connexion continue Möglichkeit zu schneiden je x LED Possibilità di tagliarli ogni x led</p>
	<p>Resistente a hilo incandescente a 850° Resistance to incandescent wire at 850° Résistance a filament incandescent a 850° Gühdrahtbeständig auf 850° Resistente a filo incandescente a 850° Resistencia a fio incandescente a 850°</p>		<p>Transformador electrónico Philips integrado Philips electronic recessed transformer Transformateur électronique Philips inclus Philips Elektronisches Vorschalgerät inklusive Trasformatore elettronico Philips incluso Transformador eletrônico Philips incluso</p>		<p>Ángulo de la ópticas Lents angle. Ángulo de la ópticas Lents angle. Angulo delle ottiche Ángulo das ópticas</p>
	<p>Empotrable para paso de vehículos hasta 2.500 Kg. y velocidad 20 Km/h Built-in lamp vehicle resistant up to 2.500 Kg. and speed 20 Km/h Encastré pour pas des voitures jusqu'à 2.500 Kg. et vitesse 20 Km/h Geegnet zum Einbau von Durchfahrten für Fahrzeuge mit einem Gewicht bis zu 2.500 Kg. und einer Geschwindigkeit von 20km/h Elemento a incasso resistente a passaggio di veicoli fino a 2.500 Kg. con velocità fino a 20 Km/h Aparelho para encastrar que resiste ao passo de veículos de até 2500 Kg a uma velocidade de 20 Km/h</p>		<p>Transformador electrónico Vossloh integrado Vossloh electronic recessed transformer. Transformateur électronique Vossloh inclus Vossloh Elektronisches Vorschalgerät inklusive Trasformatore elettronico Vossloh incluso Transformador eletrônico Vossloh incluso</p>		<p>Dimable Dimming Dimmable Dimmbar Dimmerabile Dimerável</p>
	<p>Empotrable para zona peatonal Downlight for pedestrian crossing Encastré pour zone piétonnière Einbauleuchte für Fußgängerübergang Carrabile per zona pedonale Embutido para zona de pedestres</p>		<p>Cristal de recambio de cortesía Courtesy spare glass included Verre recharge compris Zusätzliche Ersatzteile aus Glas zum Auswechseln Cristallo di recambio omaggio Vidro de reposito incluido</p>		<p>11 cambios de color 11 - changing colorus. 11 changements de couleur 11 Farben 11 cambiamenti di colori 11 mudaça de cor</p>
	<p>Temperatura máxima en la superficie de la luminaria Highest temperature on the surface Température maximale à la superficie du luminaire Leuchtenerfläche max. Temperatur Temperatura massima alla superficie dell'apparecchio Temperatura máxima da superfície da luminária</p>		<p>x metros de cable. x meters of cable. x metre de câble. x Meter langes Kabel. x metri di cabo. x metros de cabo.</p>		<p>Mando a distancia por radiofrecuencia Remote control Commande à distance par radiofréquence Hochfrequenz-Fernbedienung Tele comando per onde radio Radiofrequência controle remoto</p>
	<p>Accesorio reflector incluido Reflector accessory included Accessoire réflecteur compris Zubehör, Reflektor inklusive Accessori riflettore incluso Accessório reflector incluído</p>		<p>Bajo consumo Energy saving Économie d'énergie Energiesparlampe Risparmio energetico Baixo consumo</p>	<40°C	<p>Temperatura en la superficie menor de 40°C Temperature on the surface under 40°C Température à la surface inférieure à 40°C Oberflächentemperatur unter 40°C Temperatura alla superficie minore di 40 °C Temperatura na superfície inferior a 40°C</p>
	<p>Asimétrico Asymmetrical Asymétrique Asymmetrischen Asimmetrica Assimétrico</p>	40-80°C	<p>Temperatura en la superficie entre 40 y 80°C Temperature on the surface between 40 and 80°C Température à la surface comprise entre 40 et 80°C Oberflächentemperatur zwischen 40 und 80°C Temperatura alla superficie tra 40 e 80 °C Temperatura na superfície entre 40 e 80°C</p>	>80°C	<p>Temperatura en la superficie superior a 80°C Temperature on the surface over 80°C Température à la surface supérieure à 80°C Oberflächentemperatur über 80°C Temperatura alla superficie superiore di 80 °C Temperatura na superfície superior a 80°C</p>

**IP**

Sistema de codificación para indicar el grado de protección proporcionado por una envolvente contra la entrada de elementos sólidos y líquidos.  
 A coding system that shows the degree of protection that a casing provides against the penetration of solid objects or dust and liquids.  
 Système de codification permettant d'indiquer le degré de protection procuré par une enveloppe contre la pénétration de corps solides, poussières et liquides.  
 Sistema di codifica per indicare il grado di protezione offerto da un involucro contro la penetrazione di oggetti solidi, di polvere, o di liquidi.  
 Dieses Codierungssystem dient zur Angabe des Schutzgrades, der mit einer besonderen Verkleidung zum Schutz gegen das Eindringen fester Gegenstände, Staub oder Flüssigkeiten erreicht wird.  
 Sistema de codificação para a indicação do grau de protecção proporcionado por um invólucro contra a penetração de objectos sólidos ou pó e líquidos.

**IP 23** Lámpara protegida contra la penetración de objetos sólidos mayores de 12mm y contra el agua en forma de lluvia hasta 60° de inclinación.  
 Lamp protected against ingress of solid objects greater than 12mm and against spraying water.  
 Luminaire protégé contre la pénétration d'objets solides d'une taille supérieure à 12mm, et contre l'eau de pluie inclinée à plus de 60°.  
 Lampe geschützt gegen das Eindringen von festen Gegenständen, die größer als 12 mm sind und gegen Regenwasser mit einer Inklination bis zu 60°.  
 Lampada protetta dalla penetrazione di oggetti solidi più grandi di 12 mm e dell'acqua piovana con inclinazione fino a 60°.  
 Luminária protegida contra a penetração de objectos sólidos >12mm e contra a penetração de água em forma de chuva até uma inclinação de 60°.

**IP 44** Lámpara protegida contra la penetración de objetos sólidos mayores de 1mm y contra proyecciones de agua en todas direcciones.  
 Lamp protected against ingress of solid objects greater than 1mm and against splashing water.  
 Luminaire protégé contre la pénétration d'objets solides d'une taille supérieure à 1mm, et contre les projections d'eau dans toutes les directions.  
 Lampe geschützt gegen das Eindringen von festen Gegenständen, die größer als 1 mm und gegen Wasserstrahlen aus allen Richtungen.  
 Lampada protetta dalla penetrazione di oggetti solidi più grandi di 1 mm e dagli schizzi d'acqua provenienti da tutte le direzioni.  
 Luminária protegida contra a penetração de objectos sólidos >1mm e contra projecções de água em todas as direcções.

**IP 45** Lámpara protegida contra la penetración de objetos sólidos mayores de 1mm y contra chorros de agua en todas direcciones.  
 Lamp protected against ingress of solid objects greater than 1mm and against water jets.  
 Luminaire protégé contre la pénétration d'objets solides d'un taille supérieure à 1mm et contre jets d'eau.  
 Lampe geschützt gegen das Eindringen von festen Gegenständen, die größer als 1mm und gegen Wassergüsse aus allen Richtungen.  
 Lampada protetta dalla penetrazione di oggetti solidi più grandi di 1 mm e dai getti d'acqua provenienti da tutte le direzioni.  
 Luminária protegida contra a penetração de objectos sólidos >1mm e contra os jactos de água em todas as direcções.

**IP 54** Lámpara protegida contra la penetración de polvo y contra proyecciones de agua en todas direcciones.  
 Lamp protected against ingress of dust and against splashing water.  
 Luminaire protégé contre les poussières et contre les projections d'eau dans toutes les directions.  
 Lampe geschützt gegen das Eindringen von Staub und gegen Wasserstrahlen aus allen Richtungen.  
 Lampada a prova di polvere e di schizzi d'acqua provenienti da tutte le direzioni.  
 Luminária protegida contra a penetração de pó e contra os jactos de água em todas as direcções.

**IP 55** Lámpara protegida contra la penetración de polvo y contra chorros de agua en todas direcciones.  
 Lamp protected against ingress of dust and water jets.  
 Pièce protégée contre la poussière et jets d'eau.  
 Lampe geschützt gegen das Eindringen von Staub und gegen Wassergüsse aus allen Richtungen.  
 Lampada a prova di polvere e di getti d'acqua provenienti da tutte le direzioni.  
 Luminária protegida contra a penetração de pó e contra os jactos de água em todas as direcções.

**IP 65** Lámpara totalmente protegida contra la penetración de polvo y contra chorros de agua en todas direcciones.  
 Dust-tight lamp, protected against water jets.  
 Luminaire totalement protégé contre les poussières et les jets d'eau dans toutes les directions.  
 Lampe vollkommen geschützt gegen das Eindringen von Staub und gegen Wassergüsse aus allen Richtungen.  
 Lampada a prova di polvere e di getti d'acqua provenienti da tutte le direzioni.  
 Luminária protegida contra a penetração de pó e contra jactos de água em todas as direcções.

**IP 66** Lámpara totalmente protegida contra la penetración de polvo y contra las pulverizaciones de agua con una presión de 1 bar a 3 metros.  
 Dust-tight lamp, protected against water jets and against water spray at a pressure of 1 bar at three metres.  
 Luminaire totalement protégé contre les poussières et les jets d'eau dans toutes les directions et les pulvérisations d'eau à une pression de 1 bar à trois mètres.  
 Lampe vollkommen geschützt gegen das Eindringen von Staub und gegen Wasserbestäubung mit einem Druck bis zu 1 bar aus 3 Meter Entfernung.  
 Lampada a prova di polvere e protetta dalle polverizzazioni d'acqua a pressione di 3 bar a distanza di 3 metri.  
 Luminária protegida contra a penetração de pó e contra as pulverizações de água com uma pressão de 1 bar a três metros

**IP 67** Lámpara totalmente protegida contra la penetración de polvo y contra los efectos de la inmersión.  
 Dust-tight lamp, protected against immersion.  
 Pièce protégée contre la poussière et immersion.  
 Lampe vollkommen geschützt gegen das Eindringen von Staub und gegen die Auswirkungen von Immersion im Wasser.  
 Lampada a prova di polvere e di immersione.  
 Luminária hermética contra a penetração de pó e resistente à imersão temporal.

**IP 68 ... m** Lámpara totalmente protegida contra el polvo. Protección contra los efectos de la inmersión prolongada en agua y en profundidad.  
 Dust-tight lamp and protected against the effects of prolonged immersion in water and at depth.  
 Luminaire totalement protégé contre les poussières et contre les effets de l'immersion prolongée dans l'eau et en profondeur.  
 Lampe vollkommen geschützt gegen das Eindringen von Staub und gegen Staub und gegen die Auswirkungen von lang andauernder Immersion im tiefen Wasser.  
 Lampada a prova di polvere e resistente all'immersione prolungata in acqua, anche in profondità.  
 Luminária completamente protegida contra o pó e contra os efeitos da imersão prolongada em água a profundidade.

**IK**

- IK01:** 0,15J
- IK02:** 0,20J
- IK03:** 0,35J
- IK04:** 0,5J
- IK05:** 0,7J
- IK06:** 1J
- IK07:** 2J
- IK08:** 5J
- IK09:** 10J
- IK 10:** 20J

**Código IK**  
 Sistema de codificación para indicar el grado de protección proporcionado por una envolvente contra los impactos mecánicos nocivos.  
 Energía de impacto (Jules)

**IK Code**  
 It is a coding system that shows the level of protection that a casing provides against damaging mechanical impacts.  
 Energy of impact (Jules)

**Code IK**  
 Système de codification permettant d'indiquer le degré de protection procuré par une enveloppe contre les impacts mécaniques nuisibles.  
 Energie d'impact ( en Joules)

**IK Schutzklasse**  
 Dieses Codierungssystem dient zur Angabe des Schutzgrades, der mit einer besonderen Verkleidung zum Schutz gegen schädliche mechanische Einflüsse erreicht wird.  
 Schlagenergie (Joule)

**Codice IK**  
 Sistema di codifica per indicare il grado di protezione offerto da un involucro contro gli impatti meccanici dannosi.  
 Energia di impatto (Joule).

**Código IK**  
 Sistema de codificação para indicar o grau de protecção proporcionado por um invólucro contra os impactos mecánicos nocivos.  
 Energia de impacto (Jules)

**EMPOTRABLES DE TIERRA – DRENAJE**

Es imprescindible seguir las instrucciones de montaje y la guía de instalación de los empotrables para lograr el mejor funcionamiento posible de la luminaria.

1. Evitar colocar las luminarias en zonas de depresión del terreno.
2. Evitar colocar las luminarias en zonas donde se pueda acumular agua y en ubicaciones permanentemente húmedas, como jardines o césped.
3. Evitar el uso de productos químicos utilizados para el abono de jardines ya que pueden deteriorar algunos componentes.
4. Nivelar la luminaria con el pavimento.
5. Prever un recubrimiento de dilatación en el caso de empotrables colocados en superficies como el cemento o el hormigón para evitar la posible dilatación o compresión.
6. Colocar un drenaje eficaz para evitar el estancamiento de agua, como mínimo de 25 centímetros de grava por debajo de la carcasa de instalación. Un drenaje correcto debe absorber hasta 10 litros de agua en 15 minutos.
7. Hacer funcionar la luminaria durante 20 minutos sin el cristal para evitar condensaciones de agua dentro.

**BUILT-IN FLOOR LUMINAIRE - DRAINAGE**

It is essential to follow the assembling instructions and the installation guide of the built-in luminaires in order to achieve the best performance.

1. Avoid installing the luminaires in terrain depressions.
2. Avoid installing the luminaires in areas where water can accumulate and in places that are permanently damp, such as gardens or lawns.
3. Avoid the use of chemical products used to fertilise gardens because they could damage some of the components.
4. Level the luminaire with the surface.
5. Anticipate a dilation coating for built-in luminaires installed on surfaces like cement or concrete, to avoid possible dilation or compression.
6. Install an effective drainage system to avoid the accumulation of water, at least 25 cm of gravel under the installation casing. A correct drainage must absorb up to 10 litres of water in 15 minutes.
7. Put the light on for 20 minutes without the glass to avoid condensation inside.

**ENCASTRABLES AU SOL – DRAINAGE**

Il est indispensable de suivre les instructions et le guide d'installation des encastrables afin de garantir un éclairage optimum.

1. Eviter l'installation de luminaires dans des zones de dépression de terrain.
2. Eviter l'installation de luminaires dans des espaces où s'accumule de l'eau ou des zones humides telles que jardins ou pelouses.
3. Eviter l'utilisation de produits chimiques utilisés pour le compostage des jardins car ils peuvent détériorer certains composants.
4. Nivelar le terrain en vue de l'installation des luminaires.
5. Prévoir un recouvrement pour la dilatation dans le cas de luminaires encastrables installés en surface tel que le ciment ou le béton, afin d'éviter une possible dilatation ou compression.
6. Poser un drain efficace afin d'éviter toute stagnation de l'eau, avec un minimum de 25 centimètres de gravier en dessous de l'installation. Un drain efficace doit permettre d'absorber jusqu'à 10 litres d'eau en 15 minutes.
7. Faire fonctionner le luminaire pendant 20 minutes, sans le verre, afin d'éviter toute condensation d'eau à l'intérieur.

**ELEMENTI DA INCASSARE AL SUOLO – DRENAGGIO**

È indispensabile seguire le istruzioni di montaggio e la guida di installazione degli elementi a incasso per ottenere il migliore funzionamento possibile della luminaria.

1. Evitare di collocare le luminarie in zone depresse del terreno.
2. Evitare di collocare le luminarie in zone in cui possa accumularsi acqua e in ubicazioni permanentemente umide, come giardini o prati.
3. Evitare l'uso di prodotti chimici utilizzati per la concimazione di giardini, dal momento che potrebbero deteriorare alcuni componenti.
4. Collocare la luminaria a livello del suolo.
5. Prevedere un rivestimento di dilatazione nel caso di elementi a incasso collocati in superfici come cemento e calcestruzzo, per evitare la possibile dilatazione o compressione.
6. Disporre un drenaggio efficace per evitare il ristagno di acqua, come minimo di 25 centimetri di ghiaia al di sotto della carcassa di installazione. Un drenaggio corretto deve assorbire fino a 10 litri di acqua in 15 minuti.
7. Far funzionare la luminaria per 20 minuti senza il cristallo per evitare la condensa di acqua al suo interno.

**BODENEINBAULEUCHTEN – DRAINAGE**

Die Montageanweisungen und Anleitungen des Handbuchs für die Installation der Bodeneinbauleuchten sind unbedingt zu befolgen, um den bestmöglichen Betrieb der Beleuchtungskörper gewährleisten zu können.

1. Vermeiden Sie die Montage der Beleuchtungskörper in abschüssigem Gelände.
2. Vermeiden Sie die Montage der Beleuchtungskörper in Bereichen der Wasseransammlung und in Feuchtzonen, wie Gärten und Rasenflächen.
3. Vermeiden Sie die Verwendung von chemischen Gartendüngemitteln, da diese einen schädlichen Einfluss auf einige der Komponenten ausüben können.
4. Bringen Sie den Beleuchtungskörper und den Bodenbelag auf eine Höhe.
5. Sorgen Sie beim Einbau der Beleuchtungskörper in Zement- oder Betonflächen für eine geeignete Ummantelung, um eine eventuelle Ausdehnung oder ein Zusammenpressen zu verhindern.
6. Bauen Sie ein wirksames Drainagesystem ein, um das Anstauen von Wasser zu vermeiden, wobei ein Kiesbett von mindestens 25 cm unter dem Einbaugeschäube vorhanden sein muss. Bei einer korrekten Drainage müssen bis zu 10 Liter Wasser in 15 Minuten absorbiert werden.
7. Nehmen Sie den Beleuchtungskörper 20 Minuten lang ohne Deckglas in Betrieb, um eine Kondensierung des Wassers im Inneren der Leuchte zu vermeiden.

**ENCASTRÁVEIS DE TERRA – DRENAGEM**

É imprescindível que siga as instruções de montagem e o guia de instalação dos encastráveis para obter o melhor funcionamento possível do aparelho de iluminação.

1. Evite colocar os aparelhos de iluminação em zonas de depressão do terreno.
2. Evite Coloque os aparelhos de iluminação em zonas onde se possa acumular água e em localizações permanentemente húmidas, como jardins ou relva.
3. Evite o uso de produtos químicos utilizados para o adubamento de jardins, dado que eles podem deteriorar alguns componentes.
4. Nivele o aparelho de iluminação pelo pavimento.
5. Preveja um revestimento de dilatação no caso de encastráveis colocados em superfícies como o cimento ou o betão para evitar a eventual dilatação ou compressão.
6. Coloque uma drenagem eficaz para evitar a estagnação da água, no mínimo de 25 centímetros de gravilha abaixo da carcaça de instalação. Uma drenagem correcta deve absorver até 10 litros de água em 15 minutos.
7. Faça funcionar o aparelho de iluminação durante 20 minutos sem o vidro para evitar condensações de água dentro dele.





### DIRECTIVA SOBRE APARATOS ELÉCTRICOS Y ELECTRÓNICOS (RAEE)

El cargo RAEE consiste en un ingreso para financiar la gestión de los Residuos de Aparatos Eléctricos y Electrónicos (RAEE) a nivel nacional. No es ningún impuesto o tasa, sino un coste inherente a la gestión de residuos que deberá ser mostrado a los consumidores de forma separada en el momento de la venta.

Según el Real Decreto 2008/2005, el cargo RAEE deberá aparecer en los documentos de venta, así como en las facturas emitidas por el fabricante, y repercutidas posteriormente por el usuario final, ya sea instalador o distribuidor.

Hasta el 13 de febrero de 2011 deberá aparecer de manera separada, es decir, diferenciando el precio de la RAEE. A partir del 13 de febrero de 2011 formará parte integrante del precio, sin tener que desglosar este importe.

La Legislación Española con el R.D. 208//200/ (RAEE) establece tres categorías distintas de cargos RAEE en función de los pesos de los aparatos:

Categoría A: <900 gr. - 0,25€/unidad

Categoría B: de 900 gr. hasta 6Kg. - 0,56€/unidad

Categoría C: >6Kg - 0,73€/unidad

El cargo RAEE no es de aplicación sobre partes de luminarias, ya sean recambios o componentes, sino solo sobre luminarias completas. En caso de suministrar lámparas fluorescentes en los aparatos, se repercutirá un cargo RAEE de 0,30€/unidad adicional, independientemente de la potencia de la lámpara en cuestión.

En el caso de las exportaciones, cada país tiene su propia directiva y establece las características del cargo.

### ELECTRICAL AND ELECTRONIC EQUIPMENT DIRECTIVE (WEEE)

The WEEE charge is an amount of money to pay for the management of Waste Electrical and Electronic Equipment (WEEE), nationally. It is not tax or a fee; it is an inherent cost in waste management that has to be shown to consumers separately when they buy the product.

In accordance with the ROYAL DECREE 2008/2005, the WEEE charge must appear on sales documents, as well as on invoices issued by the manufacturer, and passed on to the final user, either the installer or the distributor.

The WEEE cost must appear separately until 13 February 2011. From 13 February 2011 onwards it will be part of the price and there will be no need to break down the price.

Spanish legislation, with the ROYAL DECREE 208//200/ (WEEE) establishes three different categories of WEEE charges according to the weight of the equipment:

Category A: <900 gr. - 0.25€/unit

Category B: 900 gr. up to 6 kg. - 0.56€/unit

Category C: >6 kg. - 0.73€/unit

The WEEE charge does not apply to luminaire spare parts or pieces; only to full luminaires. If the luminaires are supplied with fluorescent lamps, an extra WEEE charge will be added, 0.30€/unidad, regardless of the power of the lamp that is supplied.

In the case of exports, each country has its own directive and establishes the characteristics of the charge.

### LA DIRECTIVE SUR LES DECHETS DES EQUIPEMENTS ELECTRIQUES ET ELECTRONIQUES (DEEE)

La contribution environnementale DEEE permet de financer la gestion des Déchets des Equipements Electriques et Electroniques (DEEE) au niveau national. Il ne s'agit ni d'un impôt ni d'une taxe mais d'un montant inhérent à la gestion des déchets qui doit être indiqué aux consommateurs de façon séparée, au moment de la vente.

Selon le Décret royal n° 2008/2005, la contribution DEEE doit figurer sur les documents de ventes, ainsi que sur les factures émises par le fabricant, et répercutée ultérieurement sur l'utilisateur final, soit l'installateur soit le distributeur.

Jusqu'au 13 février 2011, elle devra apparaître, de façon séparée, c'est-à-dire, qu'elle n'est pas incluse dans le prix de l'équipement. A partir du 13 février 2011, cette éco-contribution fera partie intégrante du prix du produit et son montant ne devra pas être détaillé.

Au travers du Décret royal n° 208//200/ (DEEE), la législation espagnole définit trois catégories distinctes de contributions DEEE, en fonction du poids des équipements:

Catégorie A: <900 gr. - 0,25€/unité

Catégorie B: de 900gr. jusqu'à 6Kg. - 0,56€/unité

Catégorie C: >6Kg. - 0,73€/unité

La contribution environnementale DEEE ne s'applique pas aux pièces de luminaires telles que pièces de rechange ou composants mais aux luminaires dans leur ensemble. Si les équipements utilisent des lampes fluorescentes, une contribution environnementale DEEE supplémentaire de 0,30€/unité sera ajoutée, indépendamment de la puissance de la lampe en question.

Dans le cas des exportations, chaque pays dispose de sa propre directive et établit les caractéristiques de la contribution.

### DIRETTIVA SULLE APPARECCHIATURE ELETTRICHE ED ELETTRONICHE (RAEE)

L'importo RAEE consiste in un versamento destinato a finanziare lo smaltimento dei Rifiuti di Apparecchiature Elettriche ed Elettroniche (RAEE) a livello nazionale. Non si tratta di un'imposta o tassa, ma di un costo relativo alla gestione dei rifiuti che dovrà essere presentato ai consumatori in modo separato all'atto della vendita.

Secondo il Reale Decreto 2008/2005, l'importo RAEE dovrà apparire nei documenti di vendita, nonché nelle fatture emesse dal fabbricante, per ricadere in ultimo sull'utilizzatore finale, tramite le fatture dell'installatore o distributore.

Fino al 13 febbraio del 2011 dovrà figurare in modo separato, vale a dire la RAEE dovrà essere differenziata dal prezzo in quanto tale. A partire dal 13 febbraio 2011 costituirà parte integrante del prezzo, senza dover scorporare questo importo.

La Legislazione Spagnola con il R.D. 208//200/ (RAEE) stabilisce tre categorie distinte di addebiti RAEE in funzione dei pesi degli apparati:

Categoria A: <900gr. - 0,25€/unità

Categoria B: da 900gr. a 6Kg. - 0,56€/unità

Categoria C: >6Kg. - 0,73€/unità

L'addebito RAEE non viene applicato su parti di luminarie, come ricambi o componenti, ma solo sulle luminarie complete. Nel caso in cui gli apparati siano dotati di lampade fluorescenti, si avrà un addebito RAEE di 0,30€/unità addizionale, indipendentemente dalla potenza della lampada in questione. In caso di esportazione, ciascun paese ha le proprie direttive e stabilisce le caratteristiche dell'addebito.

### RICHTLINE ÜBER ELEKTRO- UND ELEKTRONIK-ALTGERÄTE (WEEE)

Die WEEE-Gebühr ist ein Betrag, der auf nationaler Ebene zur Beseitigung der Abfälle aus elektrischen und elektronischen Geräten eingehoben wird. Dabei handelt es sich nicht um eine Steuer oder öffentliche Abgabe, sondern um die Belastung des Verbrauchers mit den Kosten, die aufgrund der Beseitigung der Abfälle entstehen. Dieser Betrag muss dem Konsument zum Zeitpunkt des Verkaufs in getrennter Form aufgezeigt werden.

Nach der Königlichen Verordnung 2008/2005 muss die WEEE-Gebühr in den Verkaufsdokumenten aufscheinen und ebenso in den vom Hersteller ausgestellten Rechnungen. Die entsprechende Gebühr wird später dem Endverbraucher, d.h. dem Einbautechniker oder Vertreter, in Rechnung gestellt.

Bis zum 13. Februar 2011 ist die WEEE-Gebühr als vom Preis getrennter Betrag anzugeben. Ab dem 13. Februar 2011 wird sie einen integrierten Bestandteil des Preises bilden und muss nicht mehr als getrennter Betrag aufgeschlüsselt werden.

Die spanische Gesetzgebung unterscheidet in der Königlichen Verordnung 208//200/ (WEEE) drei WEEE-Gebührekategorien, die sich nach dem Gewicht der Geräte richten:

Kategorie A: <900gr. - 0,25€/Einheit

Kategorie B: von 900gr. bis 6kg. - 0,56€/Einheit

Kategorie C: >6kg. - 0,73€/Einheit

Die WEEE-Gebühr ist nicht auf einzelne Bestandteile der Leuchten anzuwenden, weder auf Ersatzteile noch auf Komponenten derselben, sondern nur auf vollständige Leuchten. Bei der Lieferung von Geräten mit Leuchtstoffröhren wird eine zusätzliche WEEE-Gebühr von 0,30€/Einheit eingehoben, und zwar unabhängig von der Leistung der betreffenden Lampe.

Im Exportfall wendet jedes Land seine eigenen Richtlinien an und legt die Bestimmungen bezüglich der Gebührenerhebung fest.

### DIRETTIVA SOBRE APARELHOS ELÉCTRICOS E ELECTRÓNICOS (RAEE)

O encargo RAEE consiste numa receita para financiar a gestão dos Resíduos de Aparelhos Eléctricos e Electrónicos (RAEE) a nível nacional. Não é nenhum qualquer ou taxa, mas sim um custo inerente à gestão de resíduos que deverá ser mostrado aos consumidores de forma separada no momento da venda.

De acordo com o Real Decreto 2008/2005, o encargo RAEE deverá constar nos documentos de venda, assim como nas facturas emitidas pelo fabricante, e repercutidas posteriormente no utilizador final, quer instalador quer distribuidor.

Até 13 de Fevereiro de 2011, deverá constar em separado, isto é, diferenciando o preço do RAEE. A partir de 13 de Fevereiro de 2011 fará parte integrante do preço, sem que seja necessário desdobrar este montante.

A Legislação Espanhola com o R.D. 208//200/(RAEE) estabelece três categorias diferentes de encargos RAEE, em função dos pesos dos aparelhos:

Categoria A: <900gr - 0,25€/unidade

Categoria B: de 900gr Até 6Kg - 0,56€/unidade

Categoria C: >6Kg - 0,73€/unidade

O encargo RAEE não é aplicável a partes de aparelhos de iluminação, tanto sobressalentes como componentes, mas apenas a aparelhos de iluminação completas. No caso de fornecimento de lâmpadas fluorescentes nos aparelhos, far-se-á repercutir um encargo RAEE de 0,30€/unidade adicional, independentemente da potência da lâmpada em questão.

No caso das exportações, cada país tem a sua própria directiva e estabelece as características do encargo.



DISPLAY PARA MINI CATÁLOGOS / MINI CATALOGUES DISPLAY

TABLA DE RESISTENCIA A LA CORROSIÓN ACERO INOXIDABLE  
 CORROSION RESISTANCE TABLE OF STAINLESS STEEL  
 TABLEAU DE RÉSISTANCE À LA CORROSION DE L'ACIER INOXYDABLE  
 KORROSIONSFESTE PLATTE AUS ROSTFREIEM STAHL  
 TABOLA DI RESISTENZA ALLA CORROSIONE DELL'ACCIAIO  
 TABELA DE RESISTÊNCIA À CORROÇÃO DO AÇO INOXIDÁVEL

	AISI 202	AISI 304	AISI 316
Agua doméstica Domestic water Eau ménagère Haushaltswasser Acqua domestica Água doméstica	OK	OK	OK
Agua doméstica conteniendo cloro Domestic water containing chloride Eau ménagère contenant du chlore Chlorenhaltendes Haushaltswasser Acqua domestica contenente di cloro Água doméstica contendo cloro	X	X	OK
Agua de mar Sea water Eau de mer Meerwasser Acqua di mare Água do mar	X	X	OK
Aire Air Air Luft Aria Ar	OK	OK	OK
Atmósfera marina Marine atmosphere Atmosphère marine Meeresatmosphäre Atmosfera marina Atmosfera marinha	X	X	OK

	AISI 202	AISI 304	AISI 316
Vapor de agua Water vapor Vapeur d'eau Wasserdampf Vapore di acqua Vapor de água	OK	OK	OK
Limpiadores químicos quita cemento Chemical cleaning for use on cement Nettoyeurs chimiques lève ciment Chemische Reiniger zur Zemententfernung Prodotti chimici di pulizia per togliere il cemento Limpadores químicos para a remoção de cimento	X	X	X
Suelos con un PH alto o alcalinos Floors with high PH or alkaline values Terres avec un pH haut ou alcalins Böden mit hohem PH-Wert oder alkalische Böden Pavimenti con alto PH ed alcalini Terrenos com um PH alto ou alcalinos	X	X	OK
Fertilizantes y abonos químicos Fertilizers and chemical fertilizers Fertilisants et engrais chimiques Düngemittel und chemische Dünger Fertilizzante e prodotti chimici Fertilizantes e adubos químicos	X	X	X

## LIMPIEZA Y MANTENIMIENTO DEL ACERO INOXIDABLE

Por su excelente resistencia y belleza, el acero inoxidable es un material de fácil conservación, tendiéndose a veces a tener la errónea idea de que no requiere mantenimiento. Pero es necesario seguir unas recomendaciones mínimas durante su almacenamiento, manipulación y uso. Una limpieza adecuada permite mantener inalteradas sus características originales, preservando su resistencia a la corrosión y apariencia. Durante las tareas de limpieza, asegurar que se eliminan las acumulaciones de contaminantes llevados por el aire. Esto es muy importante en lugares industriales o marítimos ya que pueden provocar corrosión localizada si no se eliminan eficazmente. Para eliminar la suciedad sobre la superficie, se debe utilizar un paño húmedo o una gamuza. En caso de suciedad más difícil, utilizar detergentes suaves de uso doméstico con estropajos o cepillos suaves de nylon (no usar estropajos de acero). Después de limpiar, elimine los residuos con agua desionizada y seque la superficie. La frecuencia para una limpieza regular es de 6-12 meses para una suciedad moderada y de 3-6 meses cuando es más abundante, o para ambientes en que se den las siguientes condiciones:

- atmósferas marinas
- ambientes repletos de contaminantes industriales
- sal pulverizada proveniente de la sal utilizada en carreteras
- suciedad atmosférica y del tráfico

No deben usarse limpiadores que contengan cloruros ni lejías. Encontrará información más detallada en: [www.leds-c4.com](http://www.leds-c4.com)

## CLEANING AND MAINTENANCE OF STAINLESS STEEL

Stainless steel is a highly resistant beautiful material being easy to conserve. However, it does require maintenance. For this reason, it is necessary to follow some minimum recommendations during its storage, manipulation and use. Correct cleaning preserves its original characteristics, especially its resistance to corrosion.

During cleaning it is important to clean the contaminating agents which are present in the atmosphere. This is particularly the case in industrial places or close to a marine environment, as these areas can cause localized corrosion if they are not efficiently eliminated.

A damp cloth or chamois leather cloth should be used to eliminate the dirt on the surface. In case of extra dirt, gentle detergents suitable for domestic use should be used with non abrasive scrubbers or nylon brushes (no metal scrubbers). After cleaning wipe away the residue with water and dry surface.

The recommended frequency is every 6-12 months for moderate dirt and 3-6 months for heavy dirt or for the following situation:

- Marine atmosphere
- Industrial contaminated areas
- Salt from road gritting
- Dirt from traffic

No cleaning agents that contain chloride or bleach should be used. You can find further information at: [www.leds-c4.com](http://www.leds-c4.com)

## NETTOYAGE ET ENTRETIEN DE L'ACIER INOXYDABLE

Pour son excellente résistance et beauté, l'acier inoxydable est un matériel de conservation facile, en ayant souvent l'idée qu'il ne requiert pas d'entretien. Mais il est désormais nécessaire de suivre des recommandations minimales pendant son emmagasinage, manipulation et usage. Un nettoyage adéquat permet de maintenir ses caractéristiques originales inchangées, en préservant sa résistance à la corrosion et son apparence.

Pendant les tâches de nettoyage, il faut s'assurer de l'élimination des accumulations des contaminants portés par l'air. Cela devient très important dans des milieux industriels ou marins parce qu'ils peuvent occasionner une corrosion focalisée s'ils ne s'enlèvent pas de façon efficiente.

Pour éliminer les salissures des surfaces, il faut utiliser un torchon humide ou un chamois. Pour des saletés plus tenaces, il faut utiliser des détergents doux à usage ménager avec des éponges ou des brosses douces en nylon (ne pas utiliser des brosses en fils d'acier). Après le nettoyage, éliminez les résidus avec de l'eau déminéralisée et séchez la surface.

Il est conseillé une périodicité des nettoyages tous les 6 à 12 mois dans tous les cas modérés et tous les 3 à 6 mois en cas de fortes salissures ainsi que dans les circonstances suivantes :

- milieu marin
- milieu industriel
- projections de sel d'épandage
- patine provoquée par la saleté de l'air et le trafic

On ne doit jamais utiliser des nettoyeurs contenant des chlorures ou des lessives. Vous trouverez information plus précise dans le site : [www.leds-c4.com](http://www.leds-c4.com)

## REINIGUNG UND INSTANDHALTUNG VON ROSTFREIEM STAHL

Aufgrund seiner hohen Beständigkeit und seines attraktiven Erscheinungsbildes ist rostfreier Stahl ein einfach instand zu haltendes Material. Viele neigen daher zur irrtümlichen Annahme, dass rostfreier Stahl keine Wartung benötigt. Nichtsdestoweniger sollte man sich bei seiner Lagerung, Handhabung und seinem Gebrauch an gewisse Mindestanweisungen halten. Eine angemessene Reinigung trägt dazu bei, seine Eigenschaften im ursprünglichen Zustand zu erhalten, seine Korrosionsbeständigkeit zu erhöhen und sein attraktives Aussehen zu bewahren.

Während der Reinigung sollte man darauf achten, dass alle verunreinigenden Stoffe, die durch die Luft auf das Metall übertragen wurden, vollkommen entfernt werden. Dies ist besonders in den Bereichen der Industrie und der Seefahrt wichtig, denn werden diese Stoffe nicht auf wirksame Weise entfernt, so können sie an bestimmten Stellen Korrosionserscheinungen hervorrufen.

Für die Entfernung der Verunreinigungen von der Oberfläche ist ein feuchtes Tuch oder ein Wischlappen zu benutzen. Bei hartnäckigem Schmutz können milde Haushaltsreiniger mit weichen Scheuerlappen oder Nylonbürsten (keine Scheuerschwämme aus Stahl verwenden) eingesetzt werden. Danach müssen die Rückstände des Reinigers mit entionisiertem Wasser abgespült und die Oberfläche abgetrocknet werden.

Eine regelmäßige Reinigung sollte bei mäßigem Schmutzbefall alle 6-12 Monate durchgeführt werden, bzw. alle 3-6 Monate bei stärkerem Schmutzbefall oder bei Vorliegen der folgenden Bedingungen:

- im Meerwasserbereich
  - in Bereichen mit starker industriell bedingter Verschmutzung
  - bei Einwirkung von Streusalz, das auf den Straßen eingesetzt wird
  - wetter- oder verkehrsbedingter Schmutzbefall
- Es dürfen keine Reiniger benutzt werden, die Chloride oder Laugen enthalten. Ausführlichere Information finden Sie in: [www.leds-c4.com](http://www.leds-c4.com)

## PULIZIA E MANTENIMENTO DELL'ACCIAIO INOSSIDABILE

Per sua particolare resistenza e bellezza, l'acciaio inossidabile è un materiale di facile conservazione, è però necessaria una po' di manutenzione.

È necessario seguire qualche raccomandazione durante l'immagazzinamento, manipolazione ed uso. La pulizia appropriata permette di conservare la sua caratteristica originale, non solo la resistenza alla corrosione ed il suo aspetto.

Durante la pulizia, bisogna assicurarsi che gli accumuli di sostanze contaminanti portate dall'aria siano rimossi. Ciò è particolarmente importante in ambienti marini ed industriali, questi possono dar luogo a corrosione localizzata, se non rimossi.

Per rimuovere uno sporco leggero o le impronte, è consigliabile usare un panno umido o di pelle scamosciata. Invece per lo sporco più consistente è consigliabile usare dei prodotti di uso domestico, spugnette oppure spazzole soffici (assolutamente non usare pagliette abrasive o metalliche). Dopo aver effettuato un'appropriate pulizia, rimuovere i residui con acqua preferibilmente deionizzata ed asciugare.

Si consiglia una pulizia ogni 6-12 mesi per uno sporco leggero, ed ogni 3-6 mesi per quello più pesante derivante dagli ambienti sotto citati:

- atmosfere marine
- ambienti carichi di prodotti industriali inquinanti
- spruzzi di acqua contenenti il sale antighiaccio sparso sulle strade
- inquinamento atmosferico e da traffico

Non devono essere usati dei prodotti contenenti cloruri e neanche candeggine a base di acido ipoclorico.

Troverete informazioni più specifiche sul sito: [www.leds-c4.com](http://www.leds-c4.com)

## LIMPEZA E MANUTENÇÃO DO AÇO INOXIDÁVEL















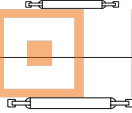

Dada a sua excelente resistência e beleza, o aço inoxidável é um material de conservação fácil, tendendo-se por vezes a ficar com a ideia de que não necessita de manutenção. No entanto é necessário que se sigam recomendações mínimas durante o seu armazenamento, manuseamento e uso. Uma limpeza adequada permite que se mantenham inalteradas as suas características originais, preservando a sua resistência à corrosão e o seu aspecto. Durante as tarefas de limpeza, certifique-se de que são eliminadas as acumulações de contaminantes transportados pelo ar. Isto é muito importante em locais industriais ou marítimos, dado que tais contaminantes podem provocar corrosão localizada se não forem eficazmente eliminados.



















Para eliminar a sujidade existente à sua superfície, deve-se utilizar um pano húmido ou uma camurça. No caso de sujidade mais difícil, devem ser utilizados detergentes suaves de uso doméstico, com esfregões ou escovas suaves de nylon (não se devem usar esfregões de aço). Depois da limpeza, devem ser eliminados os resíduos com água desionizada e secar a superfície.

Para uma limpeza regular, a frequência é de 6-12 meses para sujidade moderada e de 3-6 meses para sujidade mais abundante, ou para ambientes em que se verifiquem as condições seguintes:

- atmosferas marinhas
- ambientes repletos de contaminantes industriais
- sal pulverizado proveniente do sal utilizado nas estradas
- sujidade atmosférica e do trânsito

Não se devem usar produtos de limpeza que contenham cloratos ou lixívia. Pode encontrar informações mais detalhadas em: [www.leds-c4.com](http://www.leds-c4.com)

Lámpara Lamp	Fuentes de luz Light sources	Potencia Power	Voltage(V) Voltage (V)	Portalámparas Lampholder	Lumens (Lm) Candelas (Cd)	lcos
<b>Incandescencia / Incandescence</b>						
		40	230	E-14	400	IPP
		60	230	E-14	660	IPP
		40	230	E-27	430	IAA
		60	230	E-27	730	IAA
		75	230	E-27	960	IAA
PAR38		100	230	E-27	1380	IAA
		60	230	E-27	1200	HRG
		80	230	E-27	1800	HRG
		120	230	E-27	3100	HRG
<b>Halógenas / Halogen</b>						
QT32		60	230	E-27	490	HSGST
		100	230	E-27	1400	HSGST
HAL		150	230	E-27	2550	HEGBT
		40	230	B15d(L.86)	2500	HSG
		150	230	B15d(L.86)	2500	HSG
		70	12	BA-15d	2600	HSG
		25	230	G9	260	HDG
		40	230	G9	490	HDG
		60	230	G9	820	HDG
		75	230	G9	1100	HDG
QT-12		20	12	G4	320	HSG
QT-DE		60	230	R7s (74,9)	840	HDG
		100	230	R7s (74,9)	1600	HDG
		150	230	R7s (74,9)	2600	HDG
		100	230	R7s (114,2)	1600	HDG
		200	230	R7s (114,2)	3500	HDG
		300	230	R7s (114,2)	5300	HDG
PAR16		35	230	GU10	600	HAGS
		50	230	GU10	950	HAGS
		35	230	GZ10	600	HAGS
		50	230	GZ10	900	HAGS
PAR20		50	230	E-27	3200	HEGPAR
PAR30		75	230	E-27	6900	HEGPAR
		75	230	E-27	2200	HEGPAR
		100	230	E-27	9000	HEGPAR
QR-111		75	12	G53	30000	HRGI
		100	12	G53	48000	HRGI
QR-CB		20	12	GU-4	4500	HRGI
		35	12	GU-5,3	3750	HRGI
		50	12	GU-5,3	15000	HRGI
		50	12	GU-5,3	2850	HRGI
QR-70		50	12	BA-15d	-	-
<b>Vapor Sodio / Sodium vapour lamp</b>						
HST		50	230	E-27	3500	SE
		70	230	E-27	5600	SE
		100	230	E-27	10200	SE
		250	230	E-27	27000	SE
		400	230	E-27	48000	SE
<b>Vapor Mercurio / Mercury vapour lamp</b>						
HME		50	230	E-27	2000	QE
		80	230	E-27	4000	QE
		125	230	E-27	6500	QE
<b>Luz Mezcla / Mixed light</b>						
Mezcla / Mixed		160	230	E-27	3100	QB

Lámpara Lamp	Fuentes de luz Light sources	Potencia Power	Voltage(V) Voltage (V)	Portalámparas Lampholder	Lumens (Lm) Candelas (Cd)	lcos
<b>Fluorescencia / Fluorescence</b>						
COMPACTAS / COMPACT		5	230	E-27	240	FBT
		7	230	E-27	400	FBT
		11	230	E-27	630	FBT
		15	230	E-27	900	FBT
		20	230	E-27	1200	FBT
		23	230	E-27	1500	FBT
		30	230	E-27	1900	FBT
PAR 30		15	230	E-27	190 (cd)	-
PAR 38		15	230	E-27	190 (cd)	-
		20	230	E-27	295 (cd)	-
		23	230	E-27	339 (cd)	-
TC		7	230	G23	400	FSD
		9	230	G23	600	FSD
		11	230	G23	900	FSD
TC-D		10	230	G24d1	600	FSQ
		13	230	G24d1	900	FSD
		18	230	G24d2	1200	FSD
		26	230	G24d3	1800	FSD
TC-DE		18	230	G24q2	1200	-
		26	230	G24q3	1800	-
TC-T		18	230	Gx24d2	1200	FSM
		26	230	Gx24d3	1800	FSM
TC-TE		26	230	Gx24q3	1800	FSMH
		42	230	Gx24q4	3200	FSMH
		57	230	Gx24q5	4300	FSMH
		70	230	Gx24q6	5200	FSMH
TC-L		24	230	2G11	1800	FSD
		55	230	2G11	4800	FSD
		80	230	2G11	600	FSD
T1		7	230	GU10	62 (cd)	-
		9	230	GU10	92 (cd)	-
		11	230	GU10	110 (cd)	-
T2		9	230	Gx53	265 (cd)	-
T5		8	230	G5	300	FD
		21	230	G5	1900	FD
		28	230	G5	2600	FD
		35	230	G5	3300	FD
		24	230	G5	1750	FD
		39	230	G5	3100	FD
		49	230	G5	4300	FD
		54	230	G5	4450	FD
T8		18	230	G3	1350	FD
		36	230	G13	3250	FD
		58	230	G13	5200	FD
<b>Halogenuros Metálicos / Metal Halogen</b>						
CDM-R111		70	230	Gx8,5	50000	MR
CDM-R (H.I.D.)		35	230	E-27	46000	MR
		70	230	E-27	70000	MR
HIE		35	230	E-27	24000	MR
		70	230	E-27	6000	MC
		250	230	E-40	20000	MC
HIT		400	230	E-40	35000	MC
		35	230	G12	3300	MT
		70	230	G12	5500	MT
HIT-DE		150	230	G12	13000	MT
		70	230	Rx7s	6500	MD
		150	230	Rx7s	14500	MD
CDM-Tm		250	230	Fc2	24500	MD
		20	230	PGJS	1650	MT

ÍNDICE / INDEX

00-8715-05-37	237	05-9177-34-B8	71	05-9331-05-B8	209	10-9151-18-E7	233
00-9126-18-AA	215	05-9177-J6-B8	71	05-9333-J6-M1	163	10-9152-18-E7	235
00-9149-18-AA	219	05-9177-Z5-B8	71	05-9344-34-T2	13	10-9176-92-B8	185
00-9151-18-E7	233	05-9179-34-B8	25	05-9344-J6-T2	13	10-9183-18-B8	158
00-9175-18-AA	225	05-9179-Z5-B8	25	05-9345-34-T2	13	10-9295-18-M3	205
00-9295-18-M3	205	05-9180-18-AA	219	05-9345-J6-T2	13	10-9298-Z5-M3	193
00-9298-Z5-M3	189	05-9182-34-B8	25	05-9350-18-AA	201	10-9299-Z5-M3	191
00-9312-18-AA	212	05-9190-34-37	179	05-9351-18-AA	201	10-9329-18-B8	181
00-9350-18-AA	201	05-9191-34-37	179	05-9356-05-B8	207	10-9329-34-B8	181
00-9447-18-M3	197	05-9202-18-AA	217	05-9359-34-T2	85	10-9333-J6-M1	163
00-9522-18-M3	197	05-9204-34-B8	65	05-9360-34-T2	85	10-9350-18-AA	203
05-3358-N3-37	99	05-9204-Z5-B8	65	05-9368-34-37	65	10-9356-05-B8	207
05-3361-N3-37	99	05-9207-J6-M1	53	05-9368-Z5-37	65	10-9386-34-M3	137
05-3438-54-H6	103	05-9207-Y4-M1	53	05-9369-34-37	65	10-9386-K7-M3	137
05-3439-54-H6	103	05-9208-34-37	73	05-9369-Z5-37	65	10-9386-Z5-M3	137
05-3440-54-H6	103	05-9208-Z5-37	73	05-9370-34-T2	177	10-9387-34-M3	137
05-3441-54-H6	103	05-9211-Y4-T2	27	05-9371-34-T2	177	10-9387-K7-M3	137
05-3442-54-H6	102	05-9212-Y4-T2	27	05-9373-J6-M3	51	10-9387-Z5-M3	137
05-3443-54-H6	102	05-9227-34-37	67	05-9379-18-T2	231	10-9389-18-AA	211
05-8715-05-37	237	05-9227-Z5-37	67	05-9388-34-T2	25	10-9390-Z5-M3	191
05-8726-18-37	228	05-9228-34-37	67	05-9388-Z5-T2	25	10-9432-34-B8	225
05-8729-05-M3	55	05-9228-Z5-37	67	05-9389-18-AA	211	10-9432-J6-B8	225
05-8729-14-M3	55	05-9229-34-37	67	05-9390-Z5-M3	189	10-9447-18-M3	197
05-8729-34-M3	55	05-9229-J6-37	67	05-9393-34-37	69	10-9475-Z5-M2	139
05-8751-05-M3	55	05-9229-Z5-37	67	05-9393-Z5-37	69	10-9522-18-M3	197
05-8751-14-M3	55	05-9230-34-37	67	05-9407-34-B8	23	15-8797-Y4-F9	169
05-8751-34-M3	55	05-9230-J6-37	67	05-9408-34-M3	45	15-9114-Z5-B8	170
05-8759-05-B8	27	05-9230-Z5-37	67	05-9408-Z5-M3	45	15-9153-Z5-B8	167
05-8759-14-B8	27	05-9234-18-37	175	05-9409-34-M3	49	15-9209-18-M3	169
05-8759-34-B8	27	05-9234-34-37	175	05-9409-Z5-M3	49	15-9234-18-37	175
05-8761-18-37	228	05-9235-18-37	175	05-9410-Z5-B8	43	15-9234-34-37	175
05-8762-18-37	228	05-9235-34-37	175	05-9415-Z5-M3	49	15-9298-Z5-M3	191
05-8767-34-M3	56	05-9236-Y4-M1	53	05-9416-34-37	81	15-9300-34-M3	54
05-8783-05-M3	57	05-9238-34-M3	183	05-9416-Z5-37	81	15-9300-Z5-M3	54
05-8783-14-M3	57	05-9239-Y4-M2	165	05-9417-34-T2	85	15-9328-34-B8	69
05-8790-Y4-M1	161	05-9240-34-37	23	05-9434-34-T2	25	15-9328-Z5-B8	69
05-8796-Y4-M1	166	05-9241-34-37	97	05-9438-34-37	67	15-9341-92-M2	171
05-8938-18-37	226	05-9245-Y4-37	127	05-9438-Z5-37	67	15-9350-18-AA	203
05-8959-05-37	227	05-9249-18-AA	231	05-9439-Z5-37	101	15-9362-34-37	77
05-8961-05-B8	27	05-9250-34-37	95	05-9444-Z5-M3	41	15-9362-Z5-37	77
05-8961-14-B8	27	05-9251-34-37	95	05-9447-18-M3	197	15-9363-34-37	77
05-8961-34-B8	27	05-9252-34-37	95	05-9456-Z5-M3	29	15-9363-Z5-37	77
05-8965-18-M3	231	05-9253-34-37	95	05-9457-34-M3	45	15-9364-34-37	77
05-9100-18-37	223	05-9254-34-37	95	05-9457-Z5-M3	45	15-9364-Z5-37	77
05-9103-05-37	241	05-9258-14-B8	226	05-9458-34-T2	67	15-9365-34-T2	77
05-9104-18-M2	227	05-9264-Z5-37	101	05-9458-J6-T2	67	15-9365-Z5-T2	77
05-9107-34-37	88	05-9265-Z5-37	101	05-9458-Z5-T2	67	15-9381-Y4-37	109
05-9107-Z5-37	88	05-9266-Z5-37	101	05-9460-34-T2	17	15-9391-Y4-B8	109
05-9114-Z5-B8	170	05-9268-34-M2	263	05-9461-34-T2	17	15-9392-Y4-B8	109
05-9121-Y4-B8	168	05-9287-34-37	69	05-9464-34-T2	19	15-9480-34-37	69
05-9122-Y4-37	88	05-9287-Z5-37	69	05-9466-34-B8	17	15-9480-Z5-37	69
05-9123-34-B8	71	05-9288-J6-M1	53	05-9467-34-B8	19	15-9491-34-M3	35
05-9123-Z5-B8	71	05-9288-Y4-M1	53	05-9468-34-37	61	15-9492-Z5-M3	35
05-9124-18-37	213	05-9295-18-M3	205	05-9468-Z5-37	61	15-9493-34-M3	35
05-9126-18-AA	215	05-9296-34-37	87	05-9469-34-T2	61	15-9494-Z5-M3	35
05-9128-34-T2	23	05-9296-Z5-37	87	05-9469-Z5-T2	61	25-9503-Z5-M1	147
05-9129-34-37	73	05-9297-34-37	87	05-9470-34-T2	61	55-8766-05-05	239, 241
05-9129-Z5-37	73	05-9297-Z5-37	87	05-9470-Z5-T2	61	55-8784-05-05	91
05-9131-34-M3	55	05-9298-Z5-M3	189	05-9471-Z5-T2	31	55-8785-05-05	91
05-9131-Z5-M3	55	05-9299-Z5-M3	189	05-9472-34-M3	11	55-8790-Y4-M1	161
05-9132-18-AA	222	05-9300-34-M3	54	05-9473-34-37	81	55-8791-Y4-Y4	161
05-9146-34-T2	263	05-9300-Z5-M3	54	05-9474-34-37	81	55-8793-05-05	239, 241
05-9149-18-AA	219	05-9301-34-M3	54	05-9478-34-M2	263	55-8956-05-M1	158
05-9150-18-AA	221	05-9301-Z5-M3	54	05-9483-34-37	39	55-8956-34-M1	158
05-9151-18-E7	233	05-9308-34-B8	173	05-9484-34-37	39	55-9125-Z5-M2	159
05-9152-18-E7	235	05-9309-34-37	173	05-9485-34-T2	39	55-9149-18-AA	220
05-9158-18-AA	229	05-9310-Y4-37	89	05-9501-34-37	81	55-9151-18-18	235
05-9159-34-37	73	05-9312-18-AA	212	05-9502-34-37	81	55-9155-M1-M1	244
05-9159-Z5-37	73	05-9313-18-AA	212	05-9509-Z5-37	33	55-9156-M1-M1	244
05-9165-05-37	89	05-9315-34-B8	25	05-9510-Z5-37	33	55-9172-34-37	91
05-9165-34-37	89	05-9315-Z5-B8	25	05-9522-18-M3	197	55-9176-92-B8	185
05-9167-34-37	23	05-9327-34-37	87	10-8715-05-37	237	55-9184-Y4-37	116
05-9169-34-37	23	05-9327-Z5-37	87	10-8790-Y4-M1	161	55-9186-Y4-37	117
05-9173-34-T2	263	05-9329-18-B8	181	10-9116-Z5-M2	140	55-9187-Y4-37	112
05-9175-18-AA	225	05-9329-34-B8	181	10-9126-18-AA	215	55-9190-34-37	179
05-9176-92-B8	185	05-9330-05-B8	209	10-9149-18-AA	220	55-9191-34-37	179



55-9195-34-T2	181
55-9203-18-18	217
55-9232-Y4-37	111
55-9233-Y4-37	111
55-9237-Z5-M2	159
55-9238-34-M3	183
55-9239-Y4-M2	165
55-9242-54-B8	121
55-9243-54-B8	121
55-9245-Y4-37	127
55-9254-54-37	120
55-9255-54-37	120
55-9257-54-M2	120
55-9530-34-M2	263
55-9263-Y4-37	141
55-9264-Y4-37	106
55-9265-Y4-37	107
55-9266-Y4-37	107
55-9268-34-M2	261
55-9269-34-M2	261
55-9272-Z5-M2	159
55-9280-Y4-37	115
55-9281-Y4-37	115
55-9282-Y4-T2	116
55-9283-Y4-T2	116
55-9284-37-37	117
55-9293-34-34	260
55-9294-34-34	260
55-9295-18-M3	205
55-9298-Z5-M3	193
55-9305-48-48	96, 254, 257
55-9317-Y4-M2	165
55-9318-34-M3	157
55-9318-J6-M3	157
55-9318-Z5-M3	157
55-9319-34-M3	157
55-9319-J6-M3	157
55-9319-Z5-M3	157
55-9320-34-M3	157
55-9320-J6-M3	157
55-9320-Z5-M3	157
55-9323-Y4-37	112
55-9329-18-B8	181
55-9329-34-B8	181
55-9333-J6-M1	163
55-9334-34-M3	155
55-9334-Z5-M3	155
55-9335-34-M3	155
55-9335-Z5-M3	155
55-9336-34-M3	155
55-9336-Z5-M3	155
55-9337-Y4-37	113
55-9342-34-M3	157
55-9342-J6-M3	157
55-9342-Z5-M3	157
55-9343-34-M3	157
55-9343-J6-M3	157
55-9343-Z5-M3	157
55-9349-Z5-M3	91
55-9350-18-AA	203
55-9354-Y4-37	125
55-9355-Y4-37	125
55-9357-34-M3	151
55-9357-Z5-M3	151
55-9358-34-M3	151
55-9358-Z5-M3	151
55-9374-34-T2	149
55-9377-Y4-37	125
55-9378-Y4-37	125
55-9380-Y4-37	115
55-9382-Y4-37	119
55-9384-Y4-37	113
55-9390-Z5-M3	193
55-9394-Y4-37	115
55-9421-M3-M3	131
55-9423-34-T2	133

55-9423-Z5-T2	133
55-9424-34-T2	133
55-9424-Z5-T2	133
55-9425-M3-M3	131
55-9427-34-T2	133
55-9427-Z5-T2	133
55-9428-34-T2	133
55-9428-Z5-T2	133
55-9429-Y4-37	111
55-9430-Y4-T2	113
55-9431-34-M2	261
55-9433-Y4-37	111
55-9435-Y4-37	119
55-9437-Y4-37	119
55-9440-Y4-M2	165
55-9443-Y4-37	119
55-9459-Z5-M3	145
55-9479-34-M2	263
55-9481-M1-M1	244
55-9486-Y4-37	112
55-9488-34-M3	137
55-9488-Z5-M3	137
55-9504-34-M2	143
55-9504-Z5-M2	143
55-9505-34-M2	143
55-9505-Z5-M2	143
55-9506-34-M2	143
55-9506-Z5-M2	143
55-9520-M1-M1	243
55-9521-M1-M1	243
55-9523-Y4-37	106
55-9524-Y4-37	106
55-9525-Y4-37	107
55-9526-Y4-37	107
55-9527-Y4-37	107
55-9528-Y4-37	107
55-9529-Z5-M3	145
55-9530-34-M2	263
60-8772-05-37	239
60-9103-05-37	241
60-9151-18-E7	235
60-9152-18-E7	235
60-9203-18-AA	217
60-9293-34-M2	260
60-9294-34-M2	260
60-9306-Z5-M3	255
60-9307-Z5-M3	255
60-9375-Z5-M3	255
60-9376-Z5-M3	255
60-9482-Z5-M2	257
71-3307-00-00	270
71-3308-00-00	270
71-3314-00-00	271
71-3431-00-00	271
71-3432-00-00	271
71-3433-00-00	271
71-3435-00-00	271
71-3436-00-00	271
71-3437-00-00	271
71-3454-54-M2	249,251
71-3467-00-00	249
71-3468-00-00	249
71-3472-00-00	270
71-3473-00-00	270
71-3474-00-00	270
71-3475-00-00	270
71-3477-00-00	270
71-3478-00-00	270
71-3479-00-00	270
71-3480-00-00	270
71-8969-00-00	27, 71, 269
71-9187-Y4-37	112
71-9197-05-05	113, 125, 127, 268
71-9198-05-05	268
71-9199-05-05	268
71-9206-05-05	239, 241, 269

71-9262-05-05	268
71-9273-05-05	269
71-9278-05-05	268
71-9291-34-34	96
71-9292-34-34	96
71-9311-05-05	268
71-9396-05-05	125, 268
71-9397-05-05	125, 268
71-9398-05-05	254
71-9399-05-05	254
71-9400-34-34	268
71-9403-34-34	245
71-9404-34-34	245
71-9405-M3-M3	269
71-9406-M3-M3	269
71-9442-00-00	254
71-9445-Z5-Z5	41
71-9448-Y4-Y4	109, 115, 116, 119
71-9449-Y4-Y4	115, 116
71-9450-Y4-Y4	116
71-9451-Y4-Y4	119
71-9452-Y4-Y4	113, 117
71-9453-Y4-Y4	111, 112
71-9454-Y4-Y4	113
71-9476-08-08	133
71-9476-11-11	133
71-9476-24-24	133
71-9476-25-25	133
71-9477-08-08	133
71-9477-11-11	133
71-9477-24-24	133
71-9477-25-25	133
71-9487-34-34	81, 89, 91, 269
71-9487-Z5-Z5	81, 89, 91, 269
71-9489-05-05	269
71-9490-05-05	269
71-9495-34-34	245
71-9496-34-34	245
71-9497-34-34	245
71-9507-05-05	269
71-9508-00-00	257
71-9512-Y4-Y4	112
71-9513-52-52	260
71-9514-52-52	261
71-9515-52-52	261
71-9520-00-00	243
80-3003-BP-37	266
80-3006-BP-37	266
80-3009-BP-37	266
80-3014-BP-37	267
80-3017-BP-37	267
80-3020-BP-37	265
80-3027-BP-37	266
80-3028-BP-37	264
80-3031-BQ-37	264
80-3034-BQ-37	264
80-3041-BQ-37	266
80-3175-BP-37	266
80-3178-BP-37	266
80-3181-BP-37	265
80-4520-BP-37	266
80-4528-BP-37	267
80-4529-BP-37	264
80-4530-BQ-37	267
83-3023-AX-37	265
83-3024-AX-37	267
83-3025-AX-37	265
83-3102-BB-M2	267
83-3105-BB-M2	267
83-3119-BB-M2	267
83-3186-BB-M2	267
83-4488-AX-37	265
83-4489-AX-37	265
83-4490-AX-37	265
83-4491-AX-37	265
83-4497-AX-37	265

83-4501-AX-37	265
83-4504-AX-37	265
83-4507-AX-37	265
83-4510-AX-37	265
83-4513-AX-37	265
83-4516-AX-37	265
83-4519-AX-37	265
91-3407-54-M2	247
91-3408-54-M2	247
91-3409-54-M2	247
91-3410-54-M2	247
91-3411-54-M2	247
91-3412-54-M2	247
91-3419-00-00	251
91-3420-00-00	251
91-3421-00-00	251
91-3467-00-00	249
ACT-0803-00-00	270
ACT-0804-00-00	270
ACT-0808-00-00	270
ACT-0816-00-00	270
ACT-FLF-019	272
ACT-FLF-005	272
ACT-FLF-006	272
ACT-FLF-020	272
ACT-FLF-011	272
ACT-FLF-012	272
ACT-FLF-021	272
ACT-FLF-022	272
ACT-FLF-023	272
ACT-FLF-024	272
ACT-FLF-025	272
ACT-FLF-026	272
ACT-FLF-027	272
ACT-FLF-028	272
ACT-FLF-029	272
ACT-FLF-039	272
ACT-FLF-041	273
ACT-FLF-042	273
ACT-FLF-058	273
ACT-FLF-043	273
ACT-FLF-044	273
ACT-FLF-045	273
ACT-FLF-046	273
ACT-FLF-047	273
ACT-FLF-048	273
ACT-FLF-049	273
ACT-FLF-050	273
ACT-FLF-051	273
ACT-FLF-052	273
ACT-FLF-053	273
ACT-FLF-054	273
ACT-FLF-055	273
ACT-FLF-056	273
ACT-FLD-017	274
ACT-FLD-018	274
ACT-FLD-019	274
ACT-FLD-020	274
ACT-FLD-021	274
ACT-FLD-022	274
ACT-FLH-027	274
ACT-FLH-028	274
ACT-FLH-029	274
ACT-FLH-030	274
ACT-FLH-031	274
ACT-FLH-032	274
ACT-FLH-033	274
ACT-FLL-001	274
ACT-FLL-002	274
ACT-FLL-003	274
ACT-FLL-004	274





## LED

Gama de luminarias que han fusionado la tecnología led con el diseño vanguardista, consiguiendo la máxima eficiencia energética, sin renunciar a la estética.

Range of luminaires which have merged led technology with a state-of-the-art design, achieving the maximum energy efficiency, without neglecting aesthetics.



## ARCHITECTURAL

Soluciones lumínicas de altas prestaciones para espacios comerciales, oficinas u obras contract. Producto singular por su calidad, funcionalidad y facilidad de instalación y mantenimiento.

High-performance light solutions for commercial spaces, offices or contract works.

Product which is unique due to its quality, functionality and ease of installation and maintenance.

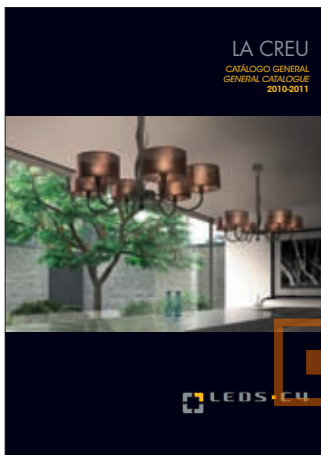

## LA CREU

Luminarias decorativas con una excelente relación calidad-precio, de todos los estilos: moderno, clásico, tradicional y rústico .. y aptas para distintas aplicaciones: dormitorios, salones, baños, zonas públicas.

Decorative luminaires with an excellent price-quality ratio in all styles: modern, classical, traditional and rustic and suitable for different applications: bedrooms, living rooms, bathrooms and public areas.

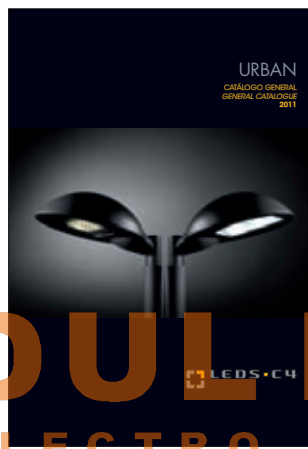

## URBAN

Luminarias para alumbrado urbano, tanto de zonas residenciales como de alumbrado vial, con distintas soluciones pensadas para favorecer el ahorro energético y la anticontaminación lumínica.

Luminaires for urban lighting both in residential areas as well as road lighting, with specific solutions designed to promote energy saving and anti-light pollution.



## GROK

Pura esencia contemporánea: luminarias que resultan obras de arte en sí mismas. Productos que conjugan a la perfección los conceptos de diseño, calidad e innovación.

Pure contemporary essence: luminaires which are works of art per se. Products which perfectly combine design, quality and innovation.



## VENTILACIÓN CEILING FANS

Cuidada selección de ventiladores con opciones para todos los estilos decorativos. Modelos silenciosos y con las más altas prestaciones, que favorecen el ahorro energético.

Careful selection of fans with options for all decorative styles. Silent models with the highest performance, which promote energy saving.

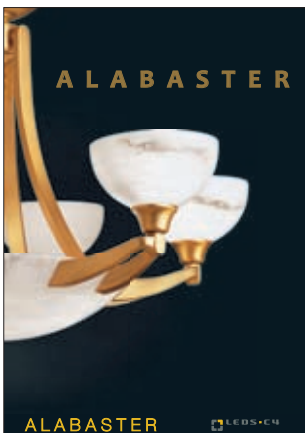

## ALABASTER

Luminarias en alabastro tanto de estilo barroco como de estilo contemporáneo. Y aplicaciones lumínico-arquitectónicas (paneles, cornisas y espejos) en alabastro para los ambientes más sofisticados.

Alabaster luminaires both in baroque and contemporary style. And light-architectonic applications (panels, cornices and mirrors) made of alabaster for more sophisticated environments.

MODULO ELECTRO  
www.modulelectro.ru



## **LEDS-C4, S.A.**

Afueras s/n – 25750 Torà (Lleida) - SPAIN

[www.leds-c4.com](http://www.leds-c4.com)

### **España**

Tel.: 973 468 101

Fax.: 973 468 129

e-mail: [info@leds-c4.com](mailto:info@leds-c4.com)

### **France**

Tel.: + 34 973 468 130

Fax.: + 34 973 468 129

e-mail: [france@leds-c4.com](mailto:france@leds-c4.com)

### **Portugal**

Tel.: + 34 973 468 130

Fax.: + 34 973 468 129

e-mail: [portugal@leds-c4.com](mailto:portugal@leds-c4.com)

### **Europe**

Tel.: + 34 973 468 102

Fax.: + 34 973 468 106

e-mail: [europa@leds-c4.com](mailto:europa@leds-c4.com)

### **América Latina**

Tel.: + 34 973 468 115

Fax.: + 34 973 468 106

e-mail: [sudamerica@leds-c4.com](mailto:sudamerica@leds-c4.com)

### **USA - Canada**

Tel.: +34 973 468 109

Fax: +34 973 468 106

e-mail: [lighting@leds-c4.com](mailto:lighting@leds-c4.com)

### **Asia - Pacific & Africa**

Tel.: + 34 973 468 116

Fax.: + 34 973 468 106

e-mail: [export@leds-c4.com](mailto:export@leds-c4.com)

### **Middle East Countries**

Tel.: + 34 973 468 108

Fax.: + 34 973 468 106

e-mail: [dep-export@leds-c4.com](mailto:dep-export@leds-c4.com)

The logo for MODUL ELECTRO, featuring the word "MODUL" in a large, bold, orange font with a square icon on either side, and "ELECTRO" in a smaller, orange font below it. Below the logo is the website address [www.modulelectro.ru](http://www.modulelectro.ru) in a grey font.