

62024
cromo chrome

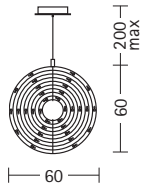

34x10W G4

Lampadine incluse
Bulbs included

62026
cromo chrome

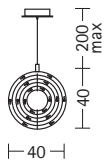

18x10W G4

Lampadine incluse
Bulbs included

62020
cromo chrome

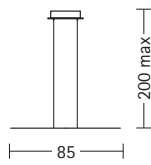

30x10W G4

Lampadine incluse
Bulbs included

62022
cromo chrome

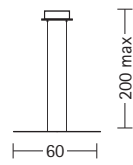

22x10W G4

Lampadine incluse
Bulbs included



62024



62026

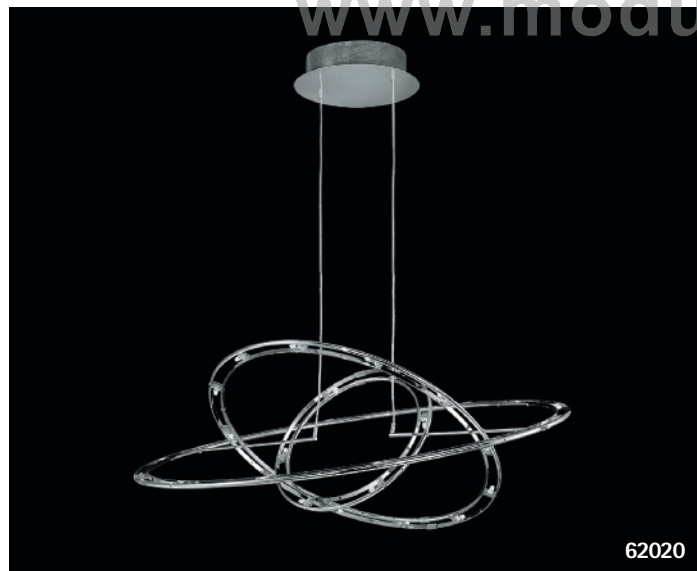

62020

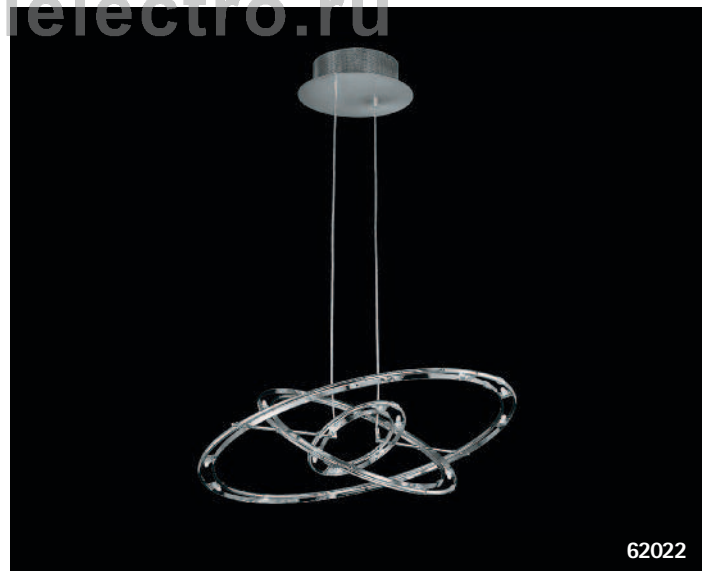

62022

Serie in bassa tensione. Struttura in metallo cromato con apertura dei cerchi graduabile. Cavo a lunghezza regolabile.

Low-voltage series. Structure in chrome-plated metal with graduable ring-span. Adjustable cable length.

Série basse tension. Structure en métal chromé avec ouverture des cercles qui peut être réglés. Câble à longueur réglable.

Niedervolt-Serie. Leuchtenstruktur aus verchromtem Metall mit individuell justierbaren Ringen. Die Länge des Kabels ist einstellbar.

Serie de bajo voltaje. Estructura en metal cromado con abertura del cerco graduable. Cable de largo regulable.

Серия светильников с низковольтными лампами. Арматура с хромовым покрытием и промежутком колец, который может градуироваться. Длина кабеля регулируется.

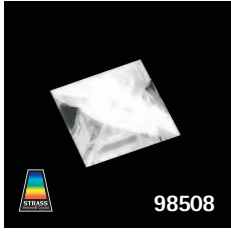

Confezione 5 Strass Swarovski.
 Set made by 5 Swarovski Strass.
 Boîte de 5 strass Swarovski.
 Packung mit 5 Swarovski Strass.
 Paquete de 5 Strass Swarovski.
 Упаковка 5 стразов Swarovski.

62000
 cromo chrome

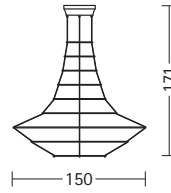

96x10W G4 
 Lampadine incluse
 Bulbs included

  IP20 CE

62002
 cromo chrome

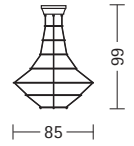

50x10W G4 
 Lampadine incluse
 Bulbs included

  IP20 CE



MODULE
 ELECTRO
www.modulelectro.ru



62000

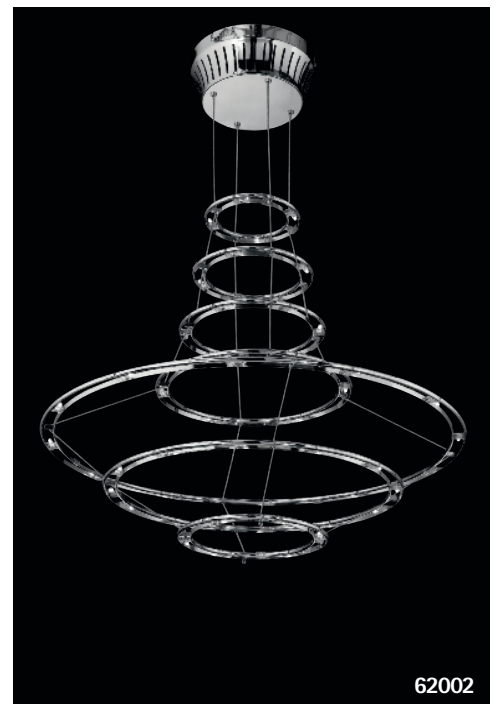

62002



Serie in bassa tensione. Struttura in metallo cromato.
 Low-voltage series. Chrome-plated metal structure.
 Série basse tension. Structure en métal chromé.
 Serie mit Niederspannung. Struktur aus verchromtem Metall.
 Serie de baja tensión. Estructura de metal cromado.
 Серия, работающая под низким напряжением. Структура из хромированного металла.

62015
cromo chrome



30x10W G4 

Lampadine incluse
Bulbs included

  IP20 CE

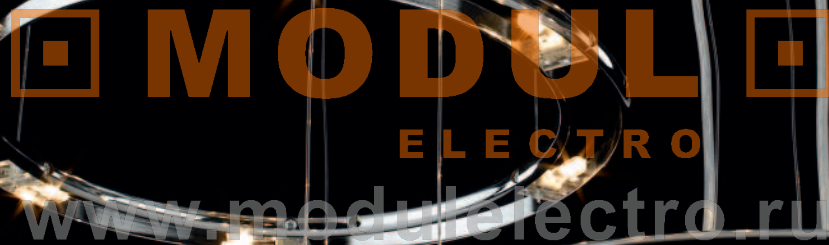
www.moduloelectro.ru



Serie in bassa tensione. Struttura in metallo cromato.
Low-voltage series. Chrome-plated metal structure.
Série basse tension. Structure en métal chromé.
Serie mit Niederspannung. Struktur aus verchromtem Metall.
Serie de baja tensión. Estructura de metal cromado.
Серия, работающая под низким напряжением. Структура из хромированного металла.





MOJUL
ELECTRO
www.mojulelectro.ru

63000
cromo chrome

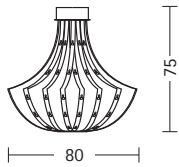

40x10W G4 

Lampadine incluse
Bulbs included

  IP20 CE

63002
cromo chrome

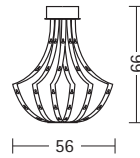

30x10W G4 

Lampadine incluse
Bulbs included

  IP20 CE

IMPERO 
ORAZIO SPADA 2006 

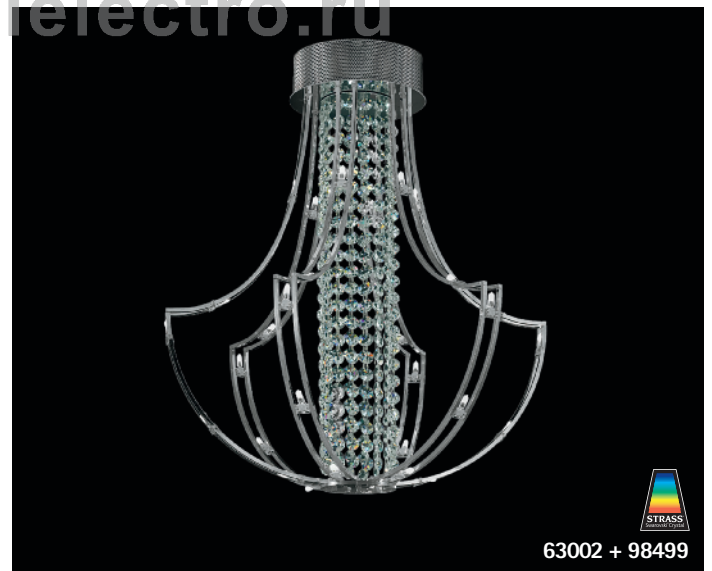

63000 + 98498 kit Strass Swarovski
cromo chrome

63002 + 98499 kit Strass Swarovski
cromo chrome

Serie in bassa tensione. Struttura in metallo cromato. Possibilità di aggiunta di Strass Swarovski.

Low-voltage series. Structure in chrome-plated metal. Option: Swarovski strass to be added.

Série basse tension. Structure en métal chromé. Possibilité d'ajouter des Strass Swarovski.

Serie mit Niederspannung. Struktur aus verchromtem Metall. Accessoires aus Swarovski Strass können ergänzt werden.

Serie de bajo voltaje. Estructura en metal cromado. Posibilidad de añadir Strass Swarovski.

Серия светильников с низковольтными лампами. Арматура с хромовым покрытием. Могут быть добавлены стразы Swarovski.

MADE IN ITALY



ELETTRA

ORAZIO SPADA 2002



55000
nichel nickel

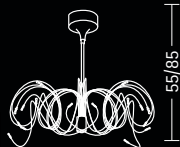

Ø 120

55/85

24x20W G4

Lampadine incluse
Bulbs included

IP20 CE

MODULO ELECTRO

www.modulelectro.ru

55001
nichel nickel



Ø 100

40/70

15x20W G4

Lampadine incluse
Bulbs included

IP20 CE



Serie in bassa tensione. Struttura in metallo nichelato.

Low-voltage series. Nickel-plated metal structure.

Série basse tension. Structure en métal nichelé.

Serie mit Niederspannung. Struktur aus vernickeltem Metall.

Serie de baja tensión. Estructura de metal niquelado.

Серия, работающая под низким напряжением. Структура из никелированного металла.



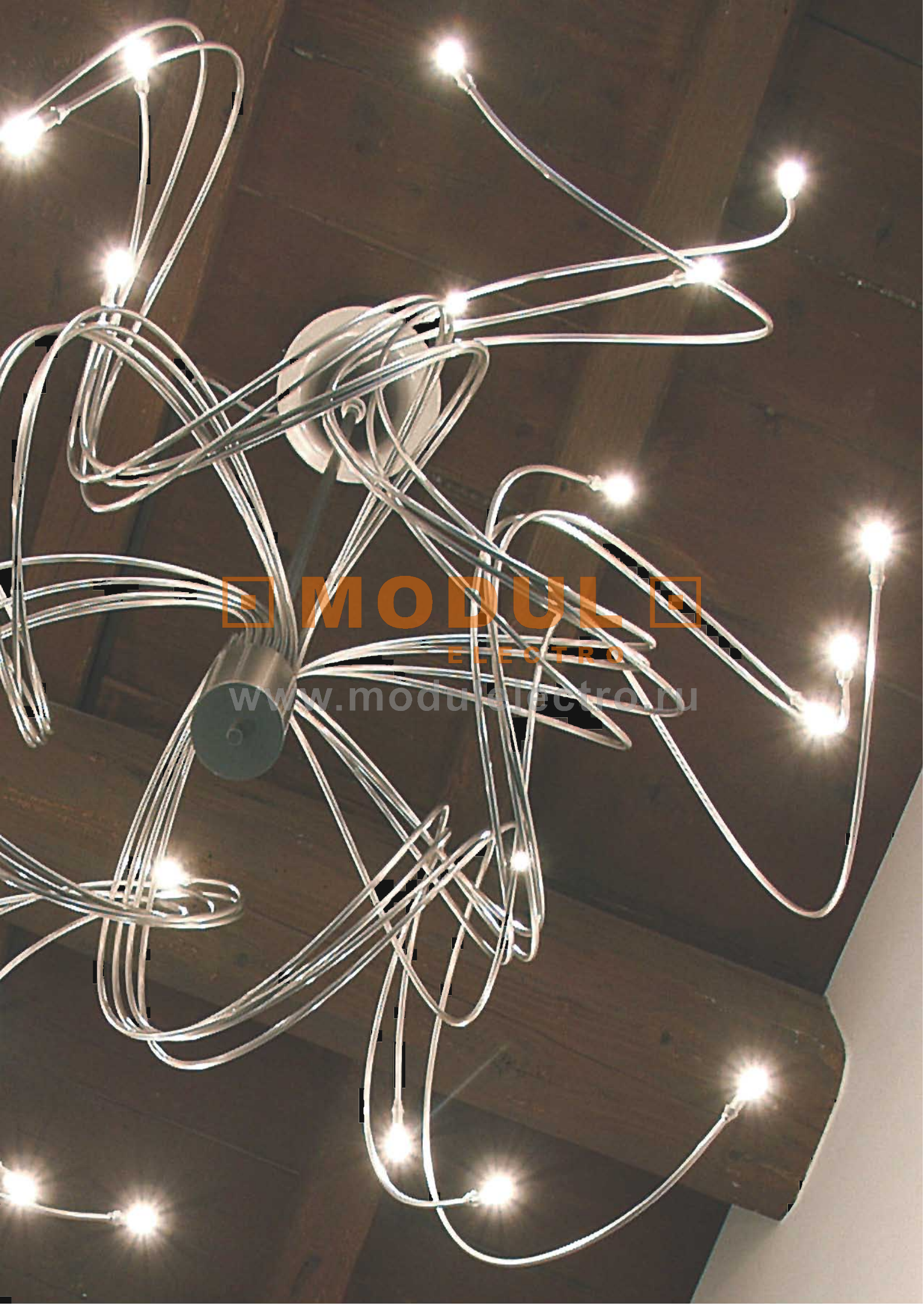

MODUL
ELECTRO

www.modul-electro.ru

86659
 nichel nickel



36x10W G4

Lampadine incluse Bulbs included
 Diffusori non inclusi Diffusers not included

IP20

86643
 nichel nickel

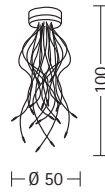

18x20W G4

Lampadine incluse Bulbs included
 Diffusori non inclusi Diffusers not included

IP20

86671
 nichel nickel



12x20W G4

Lampadine incluse Bulbs included
 Diffusori non inclusi Diffusers not included

IP20



Serie in bassa tensione. Struttura in rame nichelato. Possibilità di aggiunta di diffusori in vetro.
 Low-voltage series. Nickel-plated copper structure. Glass diffusers may be added.
 Série basse tension. Structure en cuivre nickelé. Ajout possible de diffuseurs en verre.
 Serie mit Niederspannung. Struktur aus vernickeltem Kupfer. Zusatz weiterer Diffusoren aus Glas möglich.
 Serie de baja tensión. Estructura de cobre niquelado. Posibilidad de añadir difusores de cristal.
 Серия, работающая под низким напряжением. Структура из никелированной меди. Возможность
 добавки распределителей из стекла.

Diffusori

Diffusers



55003
cromo chrome

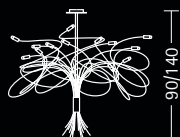

65

15x25W G9

Lampadine non incluse
Bulbs not included

IP20 CE

NARCISO
ORAZIO SPADA 2006



MODULO
ELECTRO
www.moduloelectro.ru

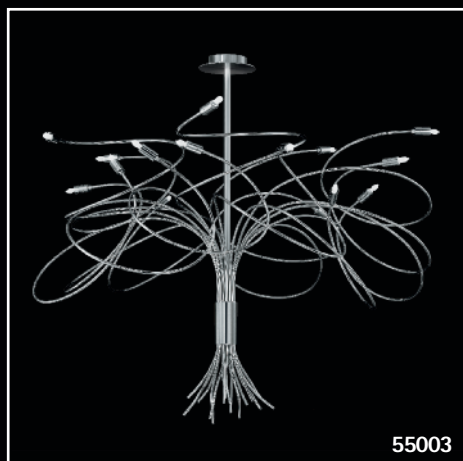

55003

Serie a tensione di rete. Asta telescopica ad estensione regolabile.
Mains-voltage series. Telescopic rod with adjustable extension.
Série alimentation secteur. Tige télescopique avec extension réglable.
230V - Serie. Justierbare Teleskopverlängerung.
Serie directa a red. Asta telescópica regulable.
Серия светильников сетевого напряжения. Телескопический стержень.

Lampadine
Bulbs



438

99758
 satinato satin-finish



Ø 2,5
 13,5
 8
 Diffusore
 Diffuser

84050
 cromo chrome

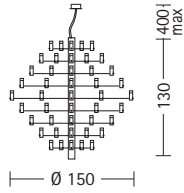

54x25W G9 
 Lampadine incluse Bulbs included
 Diffusori 99758 non inclusi Diffusers 99758 not included

  IP20  CE

84051
 cromo chrome

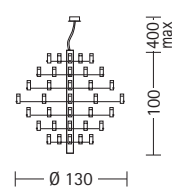

42x25W G9 
 Lampadine incluse Bulbs included
 Diffusori 99758 non inclusi Diffusers 99758 not included

  IP20  CE

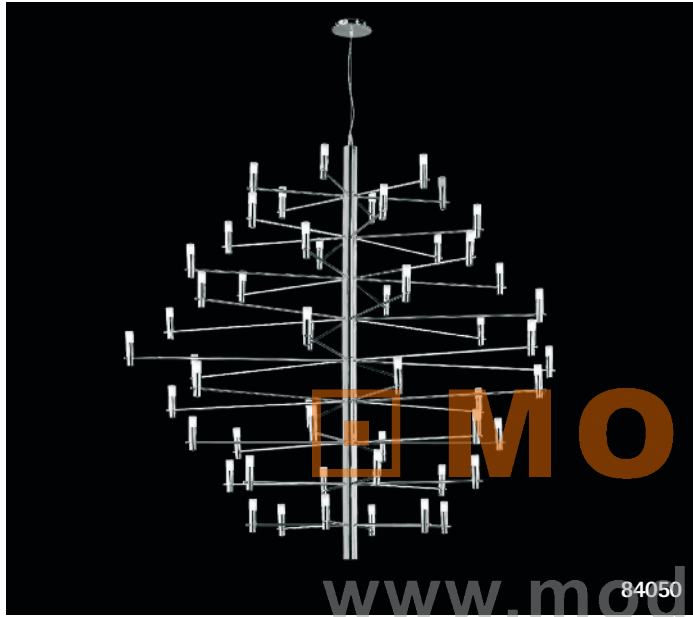

84050

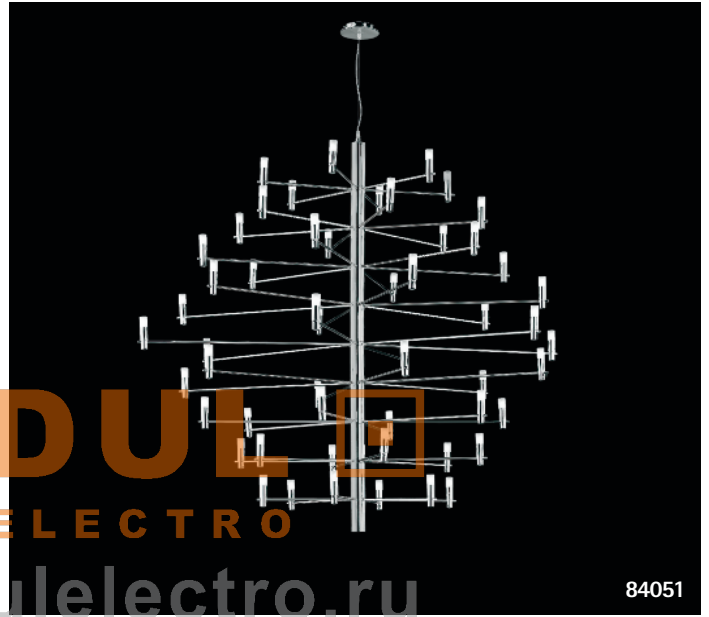

84051



84052



84053

Serie in bassa tensione. Struttura in rame nichelato. Possibilità di aggiunta di diffusori in vetro.

Low-voltage series. Nickel-plated copper structure. Glass diffusers may be added.

Série basse tension. Structure en cuivre nickelé. Ajout possible de diffuseurs en verre.

Serie mit Niederspannung. Struktur aus vernickeltem Kupfer. Zusatz weiterer Diffusoren aus Glas möglich.

Serie de baja tensión. Estructura de cobre niquelado. Posibilidad de añadir difusores de cristal.

Серия, работающая под низким напряжением. Структура из никелированной меди. Возможность добавки распределителей из стекла.

84052
cromo chrome

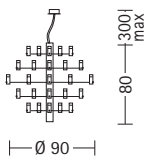

30x25W G9 

Lampadine incluse Bulbs included
Diffusori 99758 non inclusi Diffusers 99758 not included

  IP20 

84053
cromo chrome

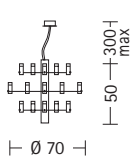

18x25W G9 

Lampadine incluse Bulbs included
Diffusori 99758 non inclusi Diffusers 99758 not included

  IP20 

LUMIERE 
LIGHT LAB 2004 

www.modulelectro.ru



55012

cromo chrome

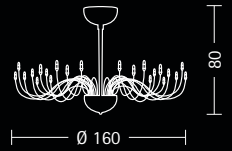

24x20W G4

Lampadine incluse
Bulbs included

IP20



MODUL
ELECTRO
www.modulelectro.ru



55012 + 98495 kit Strass Swarovski
cromo chrome

Serie in bassa tensione. Struttura in metallo cromato. Possibilità di aggiunta di Strass Swarovski.

Low-voltage series. Structure in chrome-plated metal. Option: Swarovski strass to be added.



Série basse tension. Structure en métal chromé. Possibilité d'ajouter des Strass Swarovski.

Niedervolt-Serie. Leuchtenstruktur aus verchromtem Metall. Accessoires aus Swarovski Strass können ergänzt werden.

Serie de bajo voltaje. Estructura en metal cromado. Posibilidad de añadir Strass Swarovski.

Серия светильников с низковольтными лампами. Арматура с хромым покрытием. Также могут быть добавлены стразы Swarovski.



 **MODUL** 
ELECTRO
www.modulelectro.ru



55013
 cromo chrome

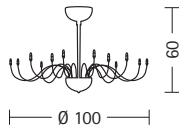

12x20W G4

Lampadine incluse
 Bulbs included

55010
 cromo chrome

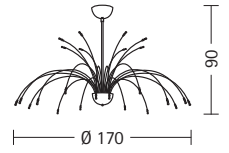

24x20W G4

Lampadine incluse
 Bulbs included

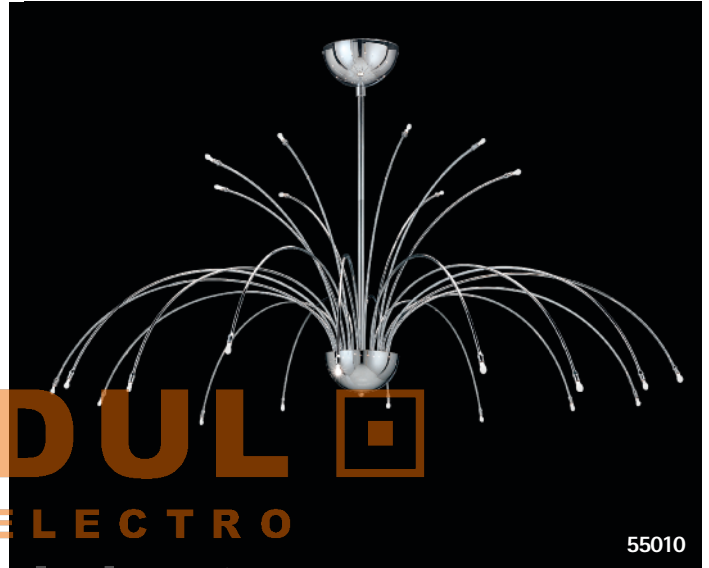

55013 + 98496 kit Strass Swarovski
 cromo chrome

55010 + 98493 kit Strass Swarovski
 cromo chrome

Serie in bassa tensione. Struttura in metallo cromato. Possibilità di aggiunta di Strass Swarovski.

Low-voltage series. Structure in chrome-plated metal. Option: Swarovski strass to be added.

Série basse tension. Structure en métal chromé. Possibilité d'ajouter des Strass Swarovski.

Niedervolt-Serie. Leuchtenstruktur aus verchromtem Metall. Accessoires aus Swarovski Strass können ergänzt werden.

Serie de bajo voltaje. Estructura en metal cromado. Posibilidad de añadir Strass Swarovski.

Серия светильников с низковольтными лампами. Арматура с хромовым покрытием. Также могут быть добавлены стразы Swarovski.

55011
cromo chrome

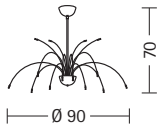

12x20W G4

Lampadine incluse
Bulbs included

IP20

55021
cromo chrome

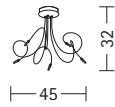

5x20W G4

Lampadine incluse
Bulbs included

IP20

ARTIFICIO
ORAZIO SPADA 2002/2006

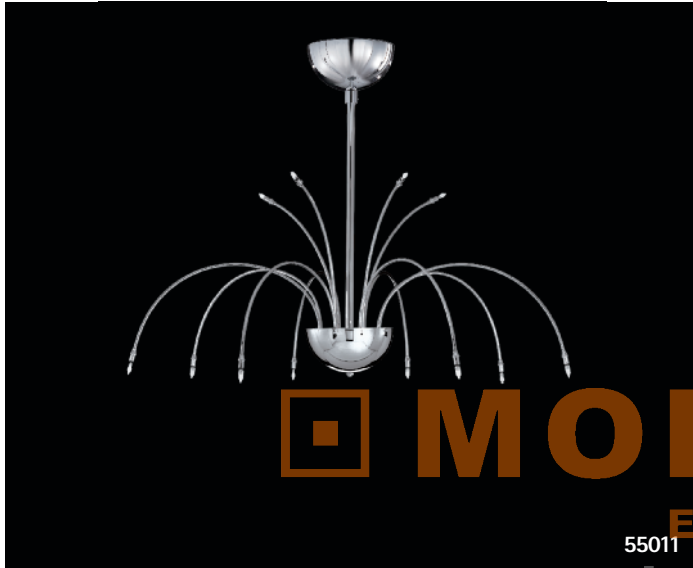

55011

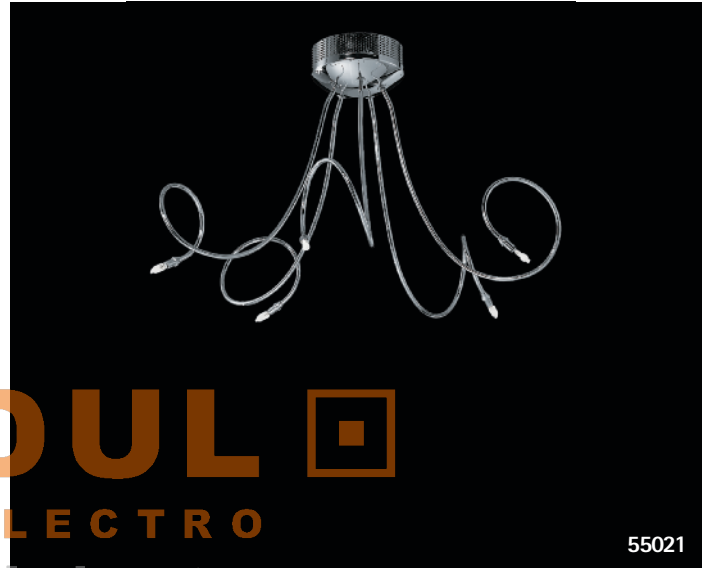

55021



55011 + 98494



55021 + 98497

55011 + 98494 kit Strass Swarovski
cromo chrome

55021 + 98497 kit Strass Swarovski
cromo chrome

Serie in bassa tensione. Struttura in metallo cromato. Possibilità di aggiunta di Strass Swarovski.

Low-voltage series. Structure in chrome-plated metal. Option: Swarovski strass to be added.

Série basse tension. Structure en métal chromé. Possibilité d'ajouter des Strass Swarovski.

Niedervolt-Serie. Leuchtenstruktur aus verchromtem Metall. Accessoires aus Swarovski Strass können ergänzt werden.

Serie de bajo voltaje. Estructura en metal cromado. Posibilidad de añadir Strass Swarovski.

Серия светильников с низковольтными лампами. Арматура с хромовым покрытием. Также могут быть добавлены стразы Swarovski.



50299
 cromo chrome

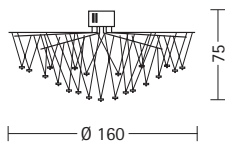

72x10W G4

Lampadine incluse Bulbs included
 Diffusori non inclusi Diffusers not included

IP20 CE

50327
 cromo chrome

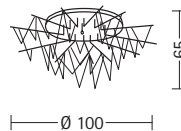

48x10W G4

Lampadine incluse Bulbs included
 Diffusori non inclusi Diffusers not included

IP20 CE



MODUL
 ELECTRO
www.modulelectro.ru

Serie in bassa tensione. Struttura in metallo cromato. Possibilità di scelta di diffusori in metallo, vetro e pirex.

Low-voltage series. Chromed-metal structure. Choice of metal, glass and pyrex diffusers.

Série basse tension. Structure en métal chromé. Éventail de choix de diffuseurs en métal, verre et pyrex.

Serie mit Niederspannung. Struktur aus verchromtem Metall. Mögliche Wahl der Diffusoren aus Metall, Glas und Pyrex.

Serie de baja tensión. Estructura de metal cromado. Posibilidad de elección de difusores de metal, cristal y pirex.

Серия, работающая под низким напряжением. Структура из хромированного металла. Возможность выбора между распределителя из металла, стекла и стекла типа «пирекс».

50136
cromo chrome

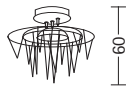

∅ 45

13x20W G4

Lampadine incluse Bulbs included
Diffusori non inclusi Diffusers not included

50321
cromo chrome



150

16x20W G4

Lampadine incluse Bulbs included
Diffusori non inclusi Diffusers not included



50299



50327

MODULO
ELECTRO
www.modulelectro.ru



50136



50321

Diffusori
Diffusers



86-87



MODUL
ELECTRO
www.modulelectro.ru

50683
cromo chrome

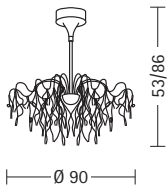

40x10W G4 

Lampadine incluse Bulbs included
Diffusori non inclusi Diffusers not included

  IP20 CE

50681
cromo chrome

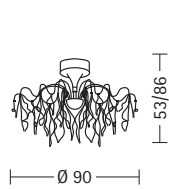

25x10W G4 

Lampadine incluse Bulbs included
Diffusori non inclusi Diffusers not included

  IP20 CE

COMETE 
ORAZIO SPADA 2004 



Serie in bassa tensione. Struttura in metallo cromato. Possibilità di scelta di diffusori in metallo, vetro e pirex.
Low-voltage series. Chromed-metal structure. Choice of metal, glass and pyrex.

Série basse tension. Structure en métal chromé. Éventail de choix de diffuseurs en métal, verre et pyrex.

Serie mit Niederspannung. Struktur aus verchromtem Metall. Mögliche Wahl der Diffusoren aus Metall, Glas und Pyrex.

Serie de baja tensión. Estructura de metal cromado. Posibilidad de elección de difusores de metal, cristal y pirex.

Серия, работающая под низким напряжением. Структура из хромированного металла. Возможность выбора между распределителя из металла, стекла и стекла типа «пирекс».

Diffusori
Diffusers



86-87

55004
 cromo satinato satin-finished chrome

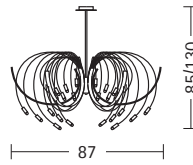



24x25W G9 

Lampadine non incluse
 Bulbs not included

 IP20 

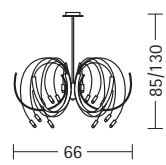
55006
 cromo satinato satin-finished chrome



15x25W G9 

Lampadine non incluse
 Bulbs not included

 IP20 



55004



55006

Serie a tensione di rete. Struttura in metallo cromato. Asta telescopica ad estensione regolabile.

Mains-voltage series. Structure in chromed metal. Telescopic rod with adjustable extension.
 Série alimentation secteur. Structure en métal chromé. Tige télescopique avec extension réglable.

230V - Serie. Leuchtenstruktur aus verchromten Metall. Justierbare Teleskopverlängerung.

Serie directa a red. Estructura en metal cromado. Asta telescópica regulable.

Серия светильников сетевого напряжения. Структура из хромированного металла. Телескопический стержень.

Lampadine
 Bulbs



438

64000
cromo chrome

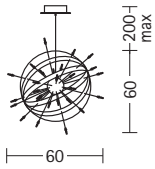

36x10W G4 

Lampadine incluse
Bulbs included

  IP20 CE

ATOMO 
ORAZIO SPADA 2006 



Serie a tensione di rete. Struttura in metallo cromato. Asta telescopica ad estensione regolabile.

Mains-voltage series. Structure in chromed metal. Telescopic rod with adjustable extension.
Série alimentation secteur. Structure en métal chromé. Tige télescopique avec extension réglable.

230V - Serie. Leuchtenstruktur aus verchromten Metall. Justierbare Teleskopverlängerung.

Serie directa a red. Estructura en metal cromado. Asta telescópica regulable.

Серия светильников сетевого напряжения. Структура из хромированного металла. Телескопический стержень.

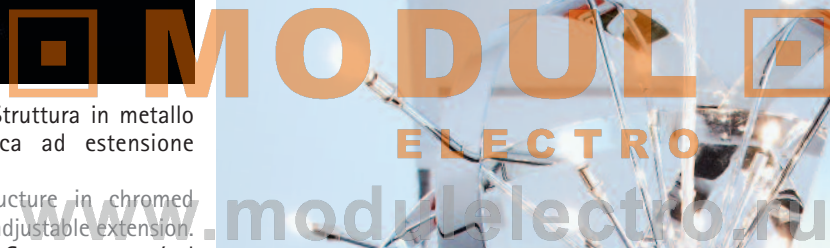

 www.modulelectro.ru

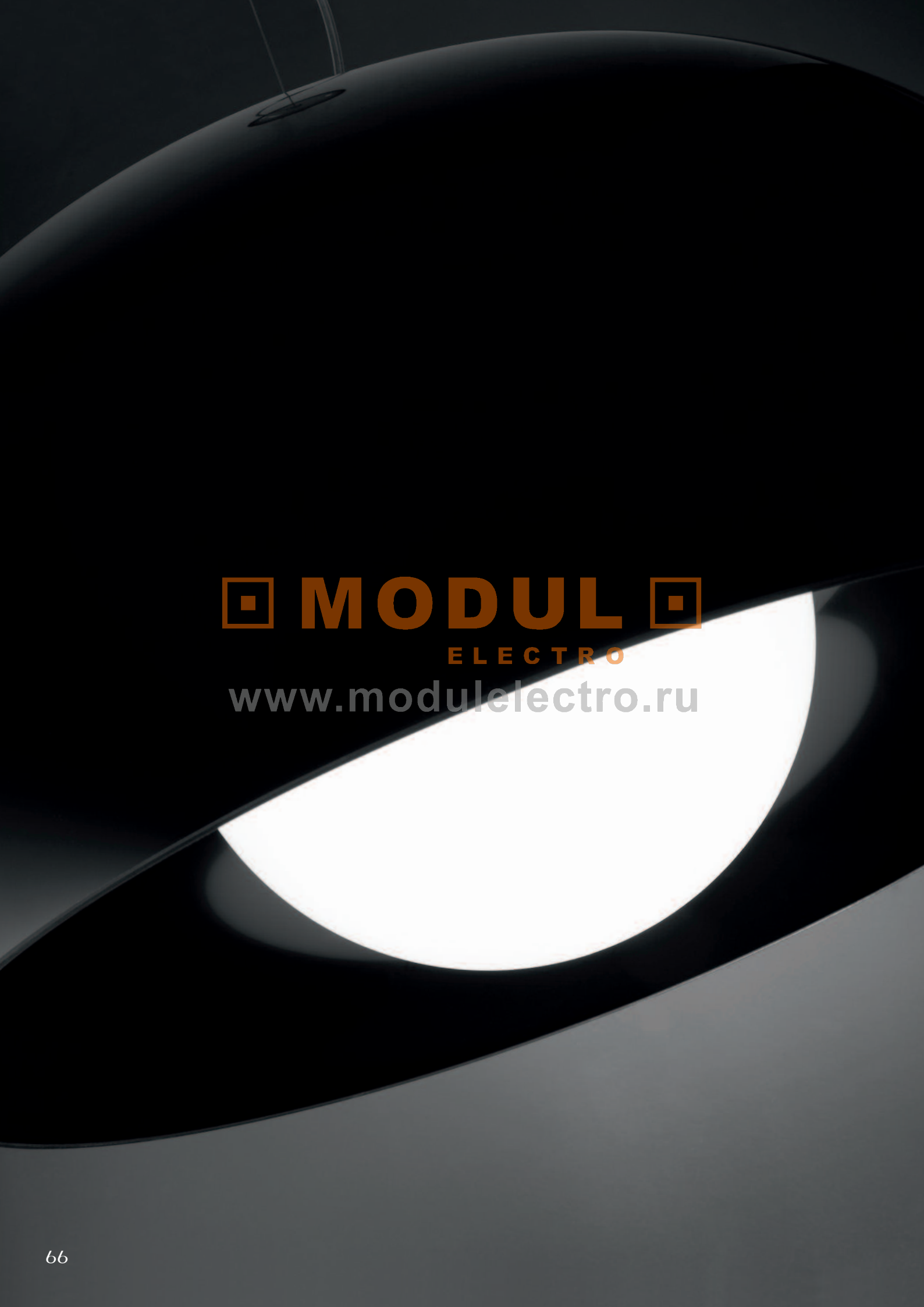

MODUL
ELECTRO
www.modulelectro.ru

BALUN

LIGHT LAB 2004/2009



- 51000 rosso red
- 51001 arancione orange
- 51002 azzurro blue
- 51003 grigio grey
- 51004 bianco white
- 51008 nero black
- 51009 fucsia fucsia

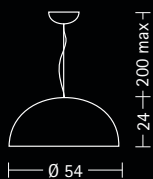

1x18W E27 Dulux DSS 
(1x75W E27 R80 )

Lampadine incluse
Bulbs included

  IP40 CE



51000



51001

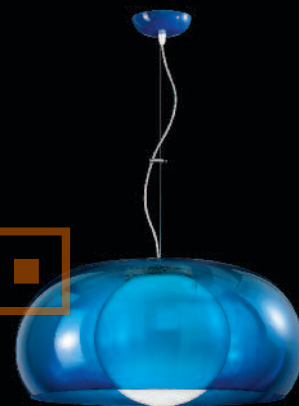

51002



51003



51004



51008

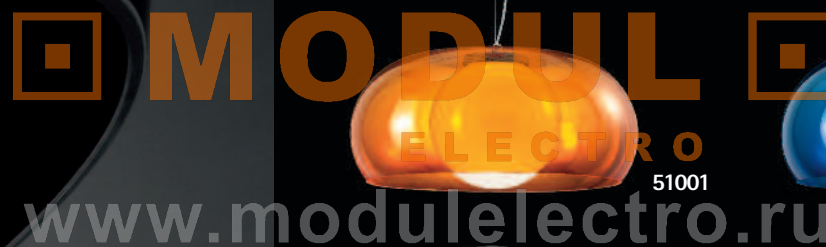

51009

www.modulelectro.ru

Serie a tensione di rete. Corpo in metacrilato colorato e diffusore sferico opalino.

Mains-voltage series. Coloured methacrylate body and spherical opal diffuser.

Série tension secteur. Corps en méthacrylique coloré et diffuseur sphérique opalin.

Serie mit Netzspannung. Körper aus farbigem Methacrylat, kugelrunder opalfarbiger Diffusor.

Serie a tensión de red. Cuerpo de metacrilato pintado y difusor esférico opalino.

Серия, работающая при сетевом напряжении. Корпус из крашено металакрилата и шарообразный матовый распределитель.



MODUL
ELECTRO
www.modulelectro.ru

Serie in bassa tensione. Struttura in metallo cromato. Diffusore in pirex. Accensione e intensità luminosa regolabili toccando il cavo.

Low-voltage series. Chromed-metal structure. Pyrex diffuser. Turn on and off and brightness adjustable by touching the cable.

Série basse tension. Structure en métal chromé. Diffuseur en pyrex. Éclairage et intensité lumineuse réglables par simple contact sur le câble.

Serie mit Niederspannung. Struktur aus verchromtem Metall. Diffusor aus Pyrex. Einschaltung und Leuchtstärke durch Berühren des Kabels regulierbar.

Serie de baja tensión. Estructura de metal cromado. Difusor de pirex. Encendido e intensidad luminosa regulables tocando el cable.

Серия, работающая при сетевом напряжении. Структура из хромированного металла. Распределитель из стекла «пирекс». Включение и светоинтенсивность регулируются при касании кабеля.

93436
cromo chrome



∅12

1x50W GY6,35

Lampadine incluse Bulbs included
Diffusori 98450 o 98451 non inclusi Diffusers 98450 or 98451 not included

IP40 CE

93435
cromo chrome

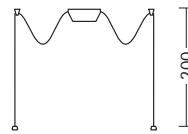

100

2x50W GY6,35

Lampadine incluse Bulbs included
Diffusori 98450 o 98451 non inclusi Diffusers 98450 or 98451 not included

IP40 CE



93436



93435

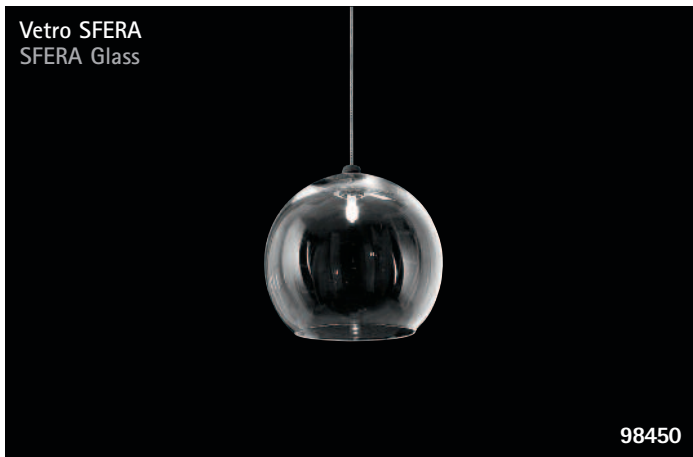

98450

Vetro SFERA
SFERA Glass



98451

Vetro UFO
UFO Glass

98450
trasparente transparent

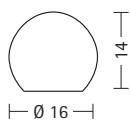

∅ 16

98451
trasparente transparent

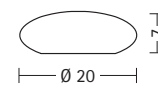

∅ 20



50722
 argento silver

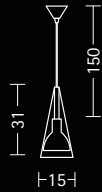

1x100W B15d

Lampadine non incluse
 Bulbs not included

IP20 CE



50723
 argento silver

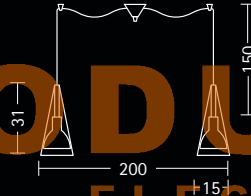

2x100W B15d

Lampadine non incluse
 Bulbs not included

IP20 CE

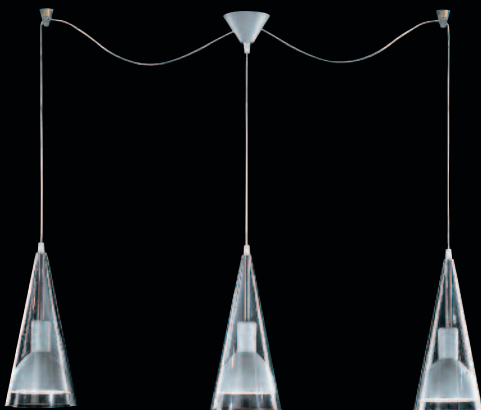

50724
 argento silver

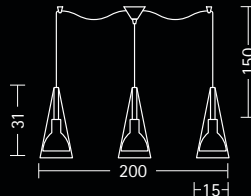

3x100W B15d

Lampadine non incluse
 Bulbs not included

IP20 CE

Serie a tensione di rete. Struttura in metallo e alluminio anodizzato. Diffusore in vetro.
 Mains-voltage series. Metal and anodised aluminium structure. Glass diffuser.
 Série tension secteur. Structure en métal et aluminium anodisé. Diffuseur en verre.
 Serie mit Netzspannung. Struktur aus Metall und eloxiertem Aluminium. Diffusor aus Glas.
 Serie a tensión de red. Estructura de metal y aluminio anodizado. Difusor de cristal.
 Серия, работающая при сетевом напряжении. Структура из хромированного металла и блестящего алюминия. Стеклопанный рассеиватель.

Lampadine
 Bulbs





MODUL
ELECTRO
www.modulelectro.ru

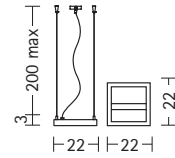

1x200W R7s 118mm 

Lampadine non incluse
 Bulbs not included

  IP40 CE



MODULO
ELECTRO
www.modulelectro.ru

Serie a tensione di rete. Struttura in metallo cromato lucido o graffiato. Diffusore in pirex satinato.

Mains-voltage series. Polished or brushed chrome metal structure. Satin-finish pyrex diffuser.

Série tension secteur. Structure en métal chromé brillant ou strié. Diffuseur en pyrex satiné.

Serie mit Netzspannung. Struktur aus verchromtem Metall, poliert oder geritzt. Diffusor aus satiniertem Pyrex.

Serie a tensión de red. Estructura de metal cromado brillante o rayado. Difusor de pirex satinado.

Серия, работающая при сетевом напряжении. Структура из хромированного блестящего или матового металла. Распределители из полированного стекла «пирекс».

53000
alluminio aluminium

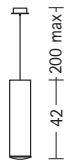

H111

1x100W GZ10 ESD 111 

Lampadine incluse
Bulbs included

  IP40 

53002
alluminio aluminium

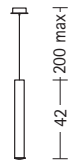

H51

1x50W GZ10 

Lampadine incluse
Bulbs included

  IP40 



53000



53002

Serie di apparecchi a tensione di rete.
Struttura in alluminio verniciato.

Mains-voltage series. Painted aluminium
structure.



Série d'appareils tension secteur. Structure en
aluminium verni.

Serie Leuchtkörper mit Netzspannung. Struktur
aus lackiertem Aluminium.

Serie de aparatos a tensión de red. Estructura
de aluminio pintado.

Серия, работающая при сетевом напряжении.
Структура из окрашенного алюминия



 **MODULO** 
ELECTRO
www.modulelectro.ru

 **MODUL** 
ELECTRO

www.modulelectro.ru

Lampadine
Bulbs





438

46200
argento silver

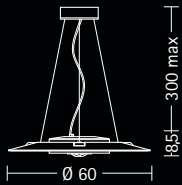
CIRCUM
EMANUELA PULVIRENTI 2008
MADE IN ITALY
MEASFO



1x50W G53 
+
1x60W 2GX13 

Lampadine non incluse
Bulbs not included

  IP20 

Sospensione a doppia lampada (fluorescente e alogena) accendibili separatamente. Struttura in metallo verniciato. Anello diffusore in policarbonato opalino. Alimentatori elettronici. I cavi permettono la regolazione della lunghezza dell'apparecchio e l'inclinazione dell'anello fluorescente. Possibilità di ulteriore regolazione del nucleo alogeno.

Double suspension lamp (fluorescent and halogen). Separate on/off switch. Painted metal structure. Diffuser ring in opalescent polycarbonate. Electronic ballast. Cables enable the adjustment of the lamp's length and of the inclination of the fluorescent ring. Possibility of also adjusting the halogen light source.

Suspension à deux ampoules (fluorescente et halogène) allumables séparément. Structure en métal peint. Anneau diffuseur en polycarbonate opalin. Alimentateurs électroniques. Les câbles permettent de régler la longueur de l'appareil et l'inclinaison de l'anneau fluorescent. Possibilité de réglage supplémentaire du noyau halogène.

Hängeleuchte mit doppelter Lampe (Leuchtstoff und Halogen), die einzeln geschaltet werden. Gestell aus lackiertem Metall. Diffusor, Ring aus Opal-Polykarbonat. Elektronische Netzteile. Über die Kabel können Länge und Neigung des Leuchtstoffrings reguliert werden. Weitere Reguliermöglichkeit der zentralen Halogenlampe. Luminaria de suspensión de doble lámpara (fluorescente y halógena) que se pueden encender por separado. Estructura de metal barnizado. Aro difusor de policarbonato opalino. Alimentadores electrónicos. Mediante los cables se pueden regular el aparato en longitud y la inclinación del aro fluorescente. Con la posibilidad añadida de regular también el núcleo halógeno.

Люстра с двумя лампами (флуоресцентной и галогенной), которые можно включать отдельно. Конструкция из окрашенного металла. Рассеивающее кольцо из матового поликарбоната. Электронные блоки питания. Кабели позволяют регулировать длину прибора и наклон флуоресцентного кольца. Возможность дополнительного регулирования галогенного источника.



Movimenti della lampada.
How the lamp can be moved.
Comment orienter la lampe.

Bewegungsmöglichkeiten der Leuchte.
Movimientos de la lámpara.
возможности вращения.



56004
alluminio aluminium

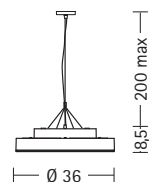

1x55W 2GX13

Lampadine non incluse
Bulbs not included

IP40



Guarnizione in PVC trasparente, giallo, rosso inclusa.
Transparent, yellow, and red PVC gasket included.
Joint en PVC transparent, jaune et rouge inclus.
Transparente, gelbe oder rote PVC-Dichtung inbegriffen.
Junta de PVC transparente, amarilla y roja incluida.
Прокладка из прозрачного, желтого и красного ПВХ.



Serie con lampada fluorescente. Alimentatore elettronico incluso. Struttura in PC trasparente o verniciato argento, diffusore in policarbonato. Disco centrale personalizzabile.

Series with fluorescent lamp. Electronic feeder included. Structure in transparent PC or painted silver - polycarbonate diffuser. Central disc that can be personalised.

Série avec lampe fluorescente. Alimentateur électronique inclus. Structure en PC transparent ou peint argent, diffuseur en polycarbonate. Disque central personnalisable.

Serie mit Leuchtstofflampen. Elektronisches Netzteil inbegriffen. Struktur aus transparentem PC oder silberfarben lackiert, PC-Schirm. Mittlere Scheibe vom Kunden gestaltbar.

Serie con lámpara fluorescente. Alimentador electrónico incluido. Estructura de PC transparente o pintado plata, difusor de policarbonato. Disco central personalizable.

Серия с флуоресцентной лампой. С электронным блоком питания. Структура из поликарбоната, прозрачного или окрашенного в серебристый цвет, рассеиватель из поликарбоната. Персонализируемый центральный диск.



 **MODUL** 

ELECTRO

www.modulelectro.ru



MODUL
ELECTRO
www.modulelectro.ru

32235

satinato cromo satin-finish chrome

LATO FLUO

MADE IN ITALY

MARCO SPADA 2006

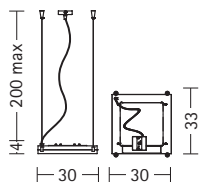

2x36W 2G10

Lampadine non incluse
Bulbs not included

IP20

Sospensione fluorescente con alimentatore elettronico. Struttura in policarbonato e metallo cromato. Cavi a lunghezza regolabile. Possibilità di aggiunta di diffusori.

Fluorescent suspension fitted with electronic ballast. Structure in polycarbonate and chrome-plated metal. Adjustable cable length. Option: diffusers to be added.

Suspension fluorescente avec alimentation électronique. Structure en polycarbonate et métal chromé. Câble à longueur réglable. Possibilité d'ajouter des diffuseurs.

Deckenleuchte für Leuchtstofflampe mit EVG. Struktur in Polycarbonat und verchromtem Metall. Die Kabellänge kann eingestellt werden. Diffusoren sind verfügbar.

Suspensión fluorescente con alimentador electrónico. Estructura de policarbonato y metal cromado. Cable de largo regulable. Posibilidad de añadir difusores.

Подвесной светильник с флуоресцентной лампой и электронным балластом. Изготовлен из пластика и металла с хромовым покрытием. Длина кабеля регулируется. Также можно добавить плафоны.



32235

MODULO ELECTRO
www.modulelectro.ru

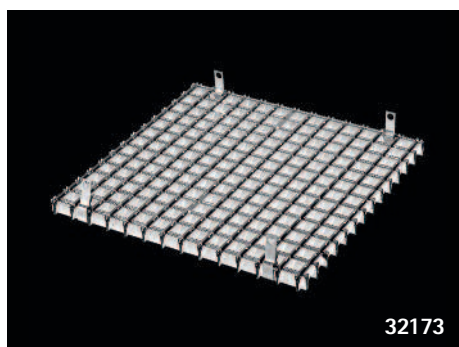

32173

32173
cromo chrome

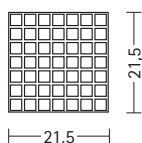

Schermo bassa luminanza.
Low luminance screen.

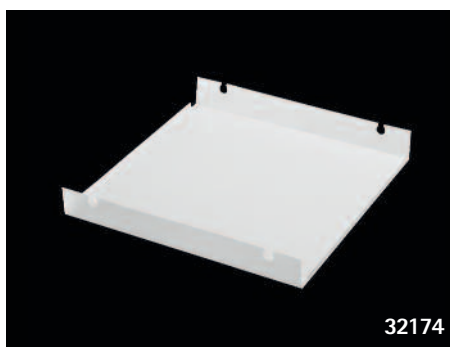

32174

32174
satinato satin-finish

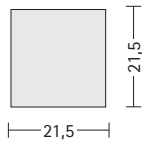

Diffusore policarbonato.
Polycarbonate diffuser.

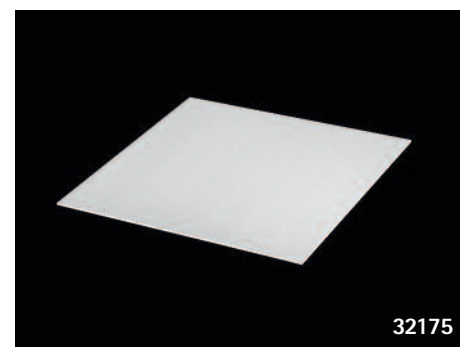

32175

32175
cromo chrome

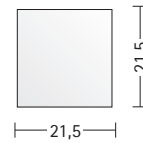

Riflettore.
Reflector.

Lampadine
Bulbs



438



206-248-270



MODUL
ELECTRO

www.modulelectro.ru

61102
trasparente transparent

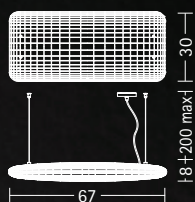

2x55W 2G11

Lampadine non incluse
Bulbs not included

IP20 CE

COB
LEO DE CARLO 2009



MODUL
ELECTRO
www.modulelectro.ru



Sospensione fluorescente. Alimentatore elettronico incluso. Struttura-diffusore in policarbonato trasparente trattata attraverso prismatura interna per il miglioramento di entrambe le curve fotometriche (emissione trasversale e longitudinale). La prismatura è basata su un profilo opportunamente adattato nelle varie sedi rettangolari per tenere conto delle diverse posizioni delle superfici rispetto alle lampade.

Fluorescent suspension lamp. Electronic ballast included. Transparent prismatic polycarbonate structure-diffuser to improve both photometric curves (transversal and longitudinal emission). The prismatic process is based on a profile specifically modified for each rectangular piece taking into account the different settings of the surfaces and the positioning of the lamps.

Suspension fluorescente. Alimentateur électronique inclus. Structure-diffuseur en polycarbonate transparent traité à travers une taille intérieure pour améliorer les deux courbes photométriques (émission transversale et longitudinale). La taille est basée sur un profil spécialement adapté dans les différentes embases rectangulaires pour tenir compte des différentes positions des surfaces par rapport aux ampoules.

Leuchtstoff-Pendelleuchte. Elektronisches Netzteil eingeschlossen. Diffusor-Gehäuse aus klarem Polykarbonat mit Prismenstruktur auf der Innenseite zur Verbesserung beider fotometrischer Kurven (Quer- und Längsausstrahlung). Die Prismenstruktur basiert auf einem den verschiedenen rechteckigen Gehäusen angepassten Profil, um den verschiedenen Positionen der Oberflächen zu den Lampen gerecht zu werden.

Lámpara colgante fluorescente. Alimentador electrónico incluido. Estructura-difusor de policarbonato transparente prismatizada internamente para mejorar las dos curvas fotométricas (haz transversal y longitudinal). La prismatización se basa en un perfil adecuadamente adaptado a los diferentes espacios rectangulares, para tener en cuenta las distintas posiciones de las superficies respecto a las lámparas.

Подвесная флуоресцентная лампа. Включает электронный блок питания. Конструкция-рассеиватель из прозрачного поликарбоната с внутренними призмами для улучшения обоих фотометрических графиков (поперечное и продольное излучение). Призмы основаны на профиле, соответствующим образом подогнанном в различных прямоугольных гнездах, для учета различных положений поверхностей относительно ламп.

Lampadine
Bulbs



438



164



210-246

Sospensione fluorescente. Struttura in metallo verniciato e policarbonato. Possibilità di aggiunta di diffusore in policarbonato o ottica Dark.

Fluorescent suspension lamp. Painted metal and polycarbonate structure. Polycarbonate or Dark optical diffusers may be added.

Suspension fluorescente. Structure en métal verni et polycarbonate. Ajout possible de diffuseurs en polycarbonate ou optique Dark.

Leuchtstoff-Pendelleuchte. Struktur aus lackiertem Metall und Polycarbonat. Zusatz eines weiteren Diffusors aus Polycarbonat oder Optik Dark möglich.

Lámpara colgante fluorescente. Estructura de metal pintado y policarbonato. Posibilidad de añadir difusor de policarbonato u óptico Dark.

Подвесная флуоресцентная лампа. Структура из крашеного металла или поликарбоната. Возможность добавления оптических распределителей Dark или распределителей из поликарбоната.

32056 39W argento silver

32066 54W argento silver

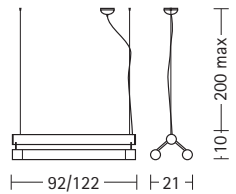

2x 39/54W G5

Lampadine e diffusori non inclusi
 Bulbs and diffusers not included

IP20 CE



MODULO
 ELECTRO
www.modulelectro.it



32056 - 32066



32055 per/for 32056
 bianco white

32145 per/for 32066
 bianco white

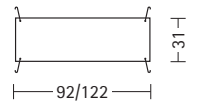

Diffusore policarbonato.
 Polycarbonate diffuser.

32055 - 32145



32171 per/for 32056
 alluminio aluminium

32172 per/for 32066
 alluminio aluminium

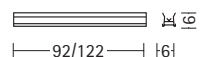

Ottica Dark (x2).
 Dark optics (x2).

32171 - 32172

Lampadine
 Bulbs



214-250



438

61010 39W trasparente/grigio transparent/grey

61020 54W trasparente/grigio transparent/grey

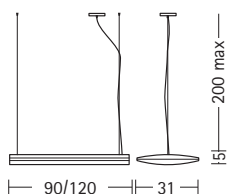

2x 39/54W G5

Lampadine e diffusori non inclusi
Bulbs and diffusers not included

IP20 CE

Sospensione fluorescente. Struttura in materiale termoplastico. Possibilità di aggiunta di diffusori in policarbonato o ottica Dark.

Fluorescent suspension lamp. Thermoplastic structure. Polycarbonate or Dark optical diffusers may be added.

Suspension fluorescente. Structure en matériau thermoplastique. Ajout possible de diffuseurs en polycarbonate ou optique Dark.

Leuchtstoff-Pendelleuchte. Struktur aus Thermoplastmaterial. Zusatz weiterer Diffusoren aus Polycarbonat oder Optik Dark möglich.

Lámpara colgante fluorescente. Estructura de material termoplástico. Posibilidad de añadir difusores de policarbonato u óptico Dark.

Флуоресцентная подвесная лампа. Структура из термопластичного материала. Возможность добавления распределителей из поликарбоната или оптики типа Dark.



61010 - 61020



32168 - 32169

32168 per/for 61010
bianco white

32169 per/for 61020
bianco white



Diffusore policarbonato.
Polycarbonate diffuser.



32171 - 32172

32171 per/for 61010
alluminio aluminium

32172 per/for 61020
alluminio aluminium

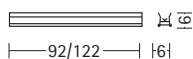

Ottica Dark (x2).
Dark optics (x2).

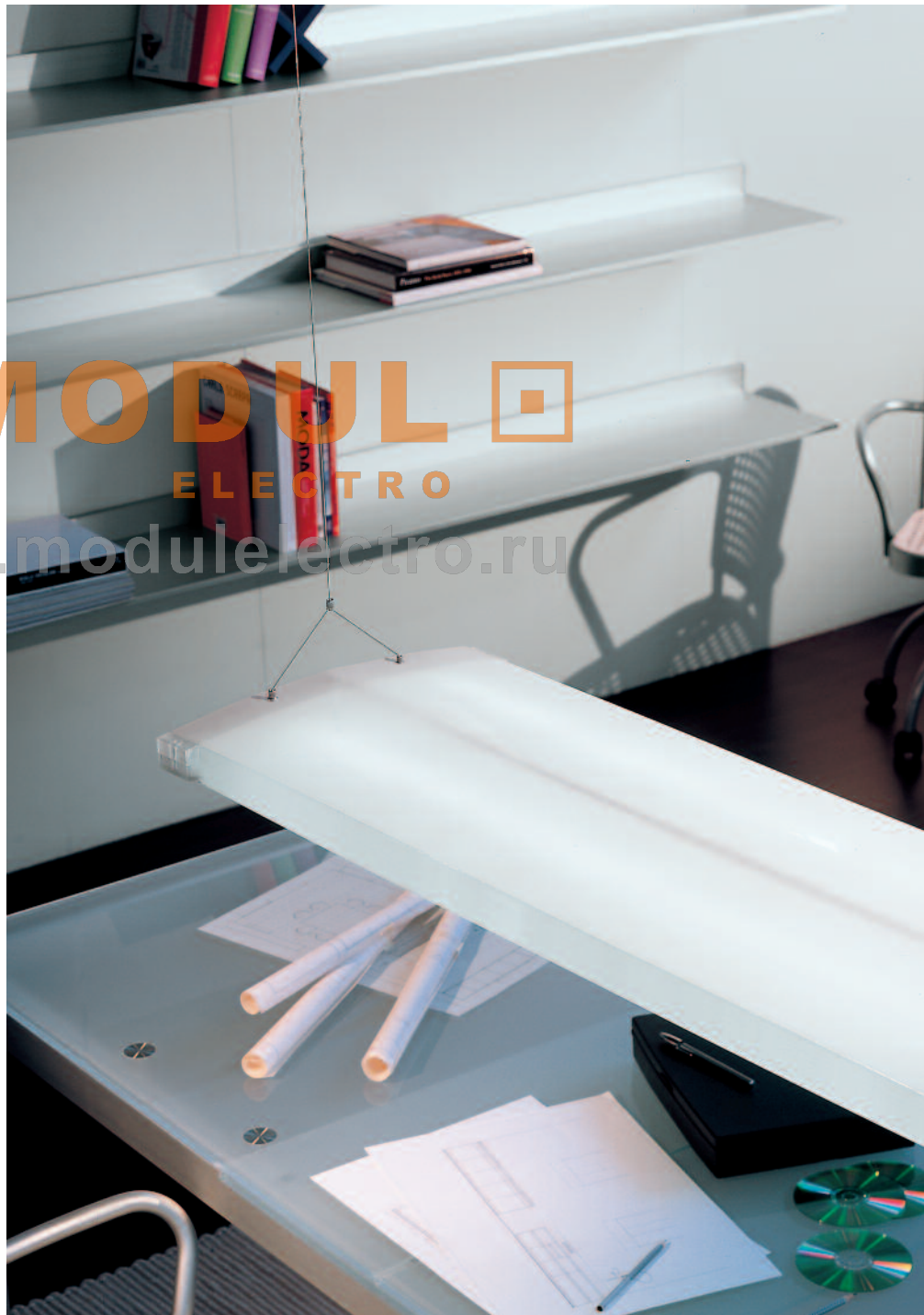

Lampadine
Bulbs



438



215-251

Sistema di illuminazione basato su una struttura in acciaio a maglie, alimentato a 12 Volt. Portata max 25 A. Nella versione tenda, può essere curvato e/o sospeso per poter configurare molteplici tipologie di installazione. Possibilità di personalizzazione dei moduli luminosi attraverso 3 differenti soluzioni (coppia schermi pirex, diffusore policarbonato satinato, cristalli Strass Swarovski).

Lighting system based on a structure made of steel links. 12 Volt power. 25 A. wiring-max capacity. The curtain version can be curved or hanged, giving endless possibilities of installation. Lighting modules can be customized with 3 different solutions: pyrex screen pair, diffuser in satin-finish polycarbonate, Swarovski Strass.

Système d'éclairage basé sur une structure en acier à maillons, alimenté à 12 Volts. Courant max 25 A. Dans la version rideau, il peut être cintré et/ou suspendu pour pouvoir proposer de nombreuses typologies d'installation. Il est possible de personnaliser les modules lumineux à travers 3 solutions différentes (paire d'écrans en pyrex, diffuseur en polycarbonate satiné, cristaux Swarovski).

Beleuchtungssystem, das auf einer Stahlmaschenstruktur basiert, mit 12 Volt Versorgung. Höchststromstärke 25 A. Beim Vorhangmodell kann es gebogen sein oder hängen, um zahlreichen Installationsarten gerecht zu werden. Die Leuchtelemente können durch drei verschiedene Lösungen (Paar Pyrexblenden, Diffusor aus satiniertem Polykarbonat, Swarovski Strasskristalle) individuell gestaltet werden.

Sistema de iluminación basado en una estructura de acero en eslabones, alimentado a 12 Voltios. Carga máx 25 A. En la versión "suelta", se puede curvar y/o colgar llegando a configurar múltiples tipologías de instalación. Posibilidad de personalización de los módulos luminosos con 3 diferentes soluciones (pareja de pantallas pirex, difusor policarbonato satinado, cristales Swarovski).

Осветительная система, основанная на стальной звеньевой конструкции, работающая на 12 В. Макс. сила тока 25 А. В варианте в виде занавеси эту систему можно закруглить и/или подвесить, определяя множество типов монтажа. Возможность персонализации световых модулей благодаря 3 различным решениям (пара экранов из пирекса, рассеиватель из сатирированного поликарбоната, кристаллы Swarovski).

MODULO
ELECTRO
www.modulelectro.ru

37040
acciaio steel

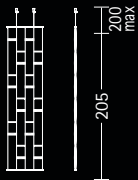

±50 ±1 131

24x10W G4 

  **IP20 CE**

Lampadine incluse Bulbs included
Alimentatore non incluso Ballast not included
Diffusori 98440 - 98441 - 98442 non inclusi Diffusers 98440 - 98441 - 98442 not included



37040

Tenda
Curtain
Rideau
Vorhang
Suelta
Занавесь



satinato
satin-finish

98440

Coppia diffusori in pirex satinato.
Satin-finished pyrex diffusers pair.
Paire de diffuseurs en pyrex satiné.
Diffusoren aus satiniertem Pyrex, Paar.
Pareja de difusores en pirex satinado.
Пара рассеивателей из сатинового пирекса.



satinato
satin-finish

98441

Diffusore in policarbonato.
Polycarbonate diffuser.
Diffuseur en polycarbonate.
Diffusor aus Polykarbonat.
Difusor de policarbonato.
Рассеиватель из поликарбоната.

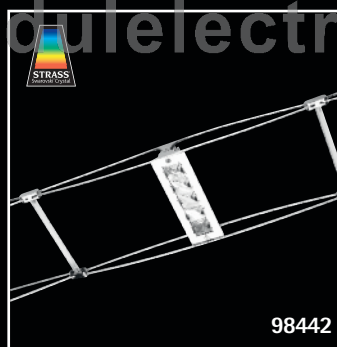

98442

Diffusore composto da 5 Strass Swarovski.
Diffuser made by 5 Swarovski Strass.
Diffuseur composé de 5 Strass Swarovski.
Diffusor bestehend aus 5 Swarovski Strasskristallen.
Difusor compuesto de 5 Strass Swarovski.
Рассеиватель, состоящий из 5 стразов Swarovski.

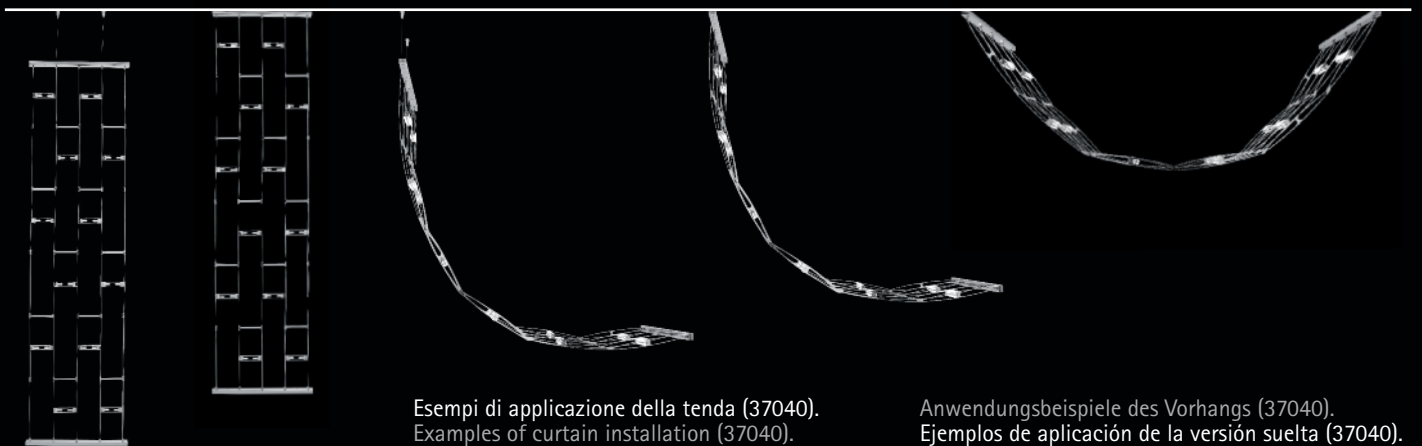

Esempi di applicazione della tenda (37040).
Examples of curtain installation (37040).
Exemples d'application pour le rideau (37040).

Anwendungsbeispiele des Vorhangs (37040).
Ejemplos de aplicación de la versión suelta (37040).
Примеры использования занавеси (37040).

Alimentatori
Ballast



316



314

DIFFUSORI DIFFUSERS DIFFUSEURS DIFFUSOREN DIFUSORES ПЛАФОНЫ
 COMETE - LUCCIOLE - FONTANA - MEDUSA

98262
 bianco white

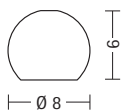

Pallina (3/4 sfera)

98284
 cromo chrome

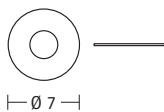

Dischetto

98043
 satinato satin-finish

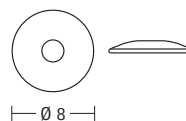

Vetrino Lucciole

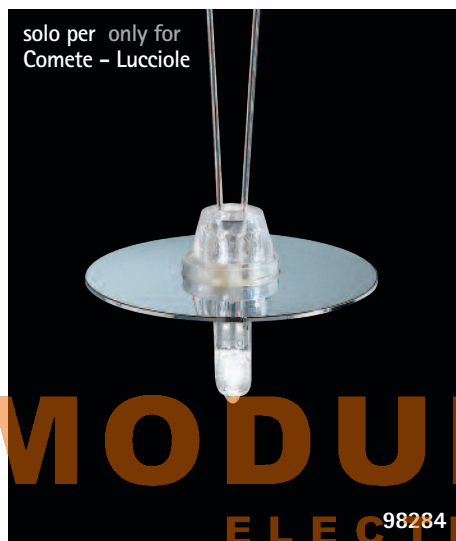

98285
 satinato satin-finish

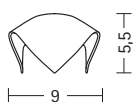

Tulipano piccolo

98435 trasparente transparent
98437 rosso red

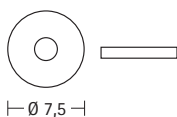

Chicco

98305
 trasparente transparent

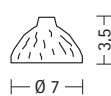

Ghiaccio

98266
 trasparente transparent

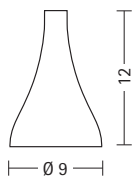

Campana



98267
 trasparente transparent

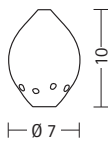

Uovo bucato

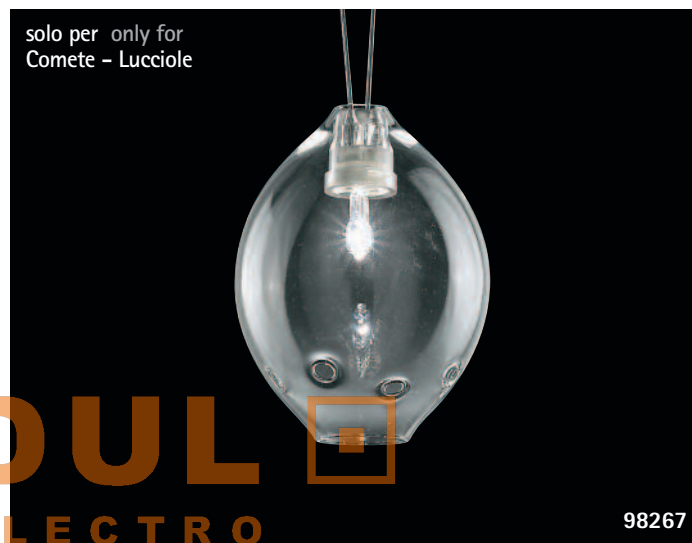

98265
 trasparente transparent

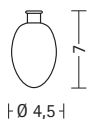

Stilla

99785
 trasparente transparent

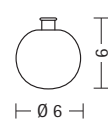

Vulcano



138-140



32-52-60-62

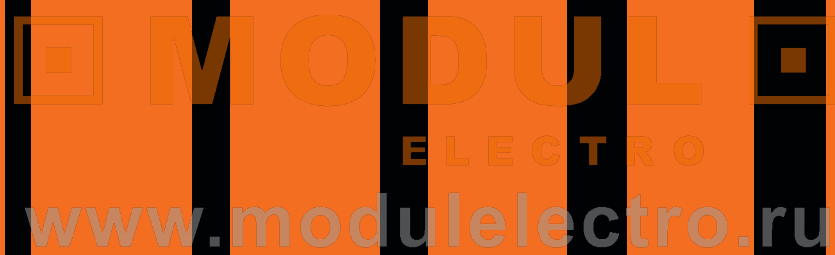

MODULO
ELECTRO
www.modulelectro.ru



ARTIFICIO	143
BOX	129
COB	164
CONO	125
CRISTAL	134
ELETTRA	141
EOS	120
FOCUS	155
FOCUS LED	154
FONTANA	138
GEODE	166
JAZZ	130
KAOS	139
LITTLE WING	168
LUMIERE	142
MEDUSA	140
MOOD	152
MUSE	136
NASTRO	90
OLIVIA	102
ORIGAMI	104
PARETE	126
PICTURA	148
PICTURA LED	144
PLUG-IN	156
QUADRO	108
REFLEX	158
RIGA	170
SHK	124
SO	128
SOFFIO	96
TOAST	118
TORA	133
TOWER	132
ZEN	122-171